



CE EAC

**TRANS-MIDIAMF**  
**AUTOMATIC MAINS FAILURE UNIT**  
**FOR GAS/DIESEL/GASOLINE GENERATORS**  
**WITH J1939 ECUs**  
**User Manual**

**EMKO ELEKTRONİK A.Ş.**  
Demirtaş Org. San. Bolg.  
Karanfil Sk. No: 6 TR  
16369 Bursa / TURKEY

Phone : +90 224 261 1900  
Faks : +90 224 261 1912  
Url : [www.emkoelektronik.com.tr](http://www.emkoelektronik.com.tr)  
E-mail : [emko@emkoelektronik.com.tr](mailto:emko@emkoelektronik.com.tr)  
[exposales@emkoelektronik.com.tr](mailto:exposales@emkoelektronik.com.tr)

# CONTENTS

<b>1.Introduction.....</b>	<b>Page</b>	<b>4</b>
1.1 General Specifications.....	Page	4
1.2 Warranty.....	Page	4
1.3 Maintenance .....	Page	4
1.4 Order Information.....	Page	5
<b>2.Installation.....</b>	<b>Page</b>	<b>6</b>
2.1 Unit Configuration.....	Page	6
2.2 Panel Mounting.....	Page	6
Figure 2.1 Front View.....	Page	6
Figure 2.2 Panel Cut-Out.....	Page	6
2.3 Electrical Connection.....	Page	7
<b>3.Definition Of Front Panel And Accessing To The Parameters.....</b>	<b>Page</b>	<b>8</b>
3.1 Front Panel Description.....	Page	8
3.2 Accessing To The Operator Parameters.....	Page	18
3.3 Accessing To The Technician Parameters.....	Page	19
3.4 Changing And Saving Parameter Values .....	Page	26
<b>4.Parameters.....</b>	<b>Page</b>	<b>27</b>
4.1 Operator Parameters.....	Page	27
4.1.1 Mains.....	Page	27
4.1.2 Generator.....	Page	27
4.2 Technician Parameters.....	Page	29
4.2.1 System.....	Page	29
4.2.2 Mains.....	Page	34
4.2.3 Generator.....	Page	34
4.2.4 Engine.....	Page	37
4.2.5 Inputs.....	Page	49
4.2.6 Outputs.....	Page	61
4.2.7 Timers.....	Page	69
4.2.8 Expansion Modules.....	Page	70
4.2.9 Synchronization.....	Page	71
4.2.10 User Adjustment.....	Page	72
<b>5.Specifications.....</b>	<b>Page</b>	<b>76</b>
<b>6.Other Informations.....</b>	<b>Page</b>	<b>77</b>

## EU DECLARATION OF CONFORMITY

**Manufacturer's Name** : EMKO ELEKTRONIK A.S.  
**Manufacturer's Address** : DOSAB, Karanfil Sk., No:6,  
16369 Bursa, TURKEY

---

The manufacturer hereby declares that the product:

**Product Name** : Automatic Mains Failure Unit  
**Type Number** : TRANS-MIDIAMF  
**Product Category** : Electrical equipment for measurement, control and laboratory use

Conforms to the following directives :

2006 / 95 / EC The Low Voltage Directive

2004 / 108 / EC The Electromagnetic Compatibility Directive

has been designed and manufactured to the following specifications:

EN 61000-6-4:2007 EMC Generic Emission Standard for Industrial Environments

EN 61000-6-2:2005 EMC Generic Immunity Standard for Industrial Environments

EN 61010-1:2001 Safety Requirements for electrical equipment for measurement, control and laboratory use

---

### When and Where Issued

25<sup>th</sup> February 2011

Bursa-TURKEY

### Authorized Signature

Name : Serpil YAKIN

Position : Quality Manager

## 1. Introduction

### 1.1 General Specifications

The unit provides for automatic transfer of a load from mains to generator in the event of a mains failure. Intended for unattended operation, it is able to detect failure of any phase of the mains and to start and switch over to a generator if the mains voltage goes outside pre-set limits. Both automatic and manual control is possible. A test mode is also available which allows the generator to be run without taking the load.

The unit calculates engine RPM from Magnetic Pickup sensor input (Trans-MidiAMF.MPU devices only) and/or generator voltage signal. At Trans-MidiAMF.CAN devices, unit gets engine RPM information from J1939 ECU.

The unit monitors J1939 ECU messages and provides remote start/stop control via J1939 protocol at only Trans-MidiAMF.CAN devices (supported ECUs: Volvo EMS2, Volvo EDC4, Perkins and standard messages).

The unit is extensively programmable through the front panel, with password protection on two levels. Operational parameters can also be monitored and controlled from a PC via a built-in RS-232 communication port.

In the event that the engine fails to start on the first attempt, the attempt will be repeated a programmed number of times or until successful.

The unit monitors generator operation and gives warning of any faults that are detected. If a fault is detected, the unit shuts down the engine and shows the failure message on the LCD display and activates the internal sounder.

### 1.2 Warranty

EMKO Elektronik warrants that the equipment delivered is free from defects in material and workmanship. This warranty is provided for a period of two years. The warranty period starts from the delivery date. This warranty is in force if duty and responsibilities which are determined in warranty document and instruction manual performs by the customer completely.

### 1.3 Maintenance

Repairs should only be performed by trained and specialized personnel. Cut power to the device before accessing internal parts.

Do not clean the case with hydrocarbon-based solvents (Petrol, Trichlorethylene etc.). Use of these solvents can reduce the mechanical reliability of the device. Use a cloth dampened in ethyl alcohol or water to clean the external plastic case.

## 1.4 Order Information

- Trans-midiAMF.MPU.232** : Automatic GenSet controller with transfer switching, speed sensing from Magnetic Pickup,RS-232 communication
- Trans-midiAMF.CAN.232** : Automatic GenSet controller with transfer switching, CanBus J1939 ECU communication,RS-232 communication
- Trans-midiAMF.MPU.485** : Automatic GenSet controller with transfer switching, speed sensing from Magnetic Pickup,RS-485 communication
- Trans-midiAMF.CAN.485** : Automatic GenSet controller with transfer switching, CanBus J1939 ECU communication,RS-485 communication
- Trans-midiAMF.MPU.232.GPRS** : Automatic GenSet controller with transfer switching, speed sensing from Magnetic Pickup,RS-232 communication, GSM-GPRS feature
- Trans-midiAMF.CAN.232.GPRS** : Automatic GenSet controller with transfer switching, CanBus J1939 ECU communication,RS-232 communication, GSM-GPRS feature
- Trans-midiAMF.MPU.485.GPRS** : Automatic GenSet controller with transfer switching, speed sensing from Magnetic Pickup,RS-485 communication, GSM-GPRS feature
- Trans-midiAMF.CAN.485.GPRS** : Automatic GenSet controller with transfer switching, CanBus J1939 ECU communication,RS-485 communication, GSM-GPRS feature
- Trans-midiAMF.MPU.232.GPRS+GPS** : Automatic GenSet controller with transfer switching, speed sensing from Magnetic Pickup,RS-232 communication, GSM-GPRS+GPS feature
- Trans-midiAMF.CAN.232.GPRS+GPS**: Automatic GenSet controller with transfer switching, CanBus J1939 ECU communication,RS-232 communication, GSM-GPRS+GPS feature
- Trans-midiAMF.MPU.485.GPRS+GPS**: Automatic GenSet controller with transfer switching, speed sensing from Magnetic Pickup,RS-485 communication, GSM-GPRS+GPS feature
- Trans-midiAMF.CAN.485.GPRS+GPS**: Automatic GenSet controller with transfer switching, CanBus J1939 ECU communication,RS-485 communication, GSM-GPRS+GPS feature

## 2. Installation



**Before beginning installation of this product, please read the instruction manual and warnings below carefully.**

A visual inspection of this product for possible damage occurred during shipment is recommended before installation. It is your responsibility to ensure that qualified mechanical and electrical technicians install this product.

If there is danger of serious accident resulting from a failure or defect in this unit, power off the system and separate the electrical connection of the device from the system.

Keep the power off until all of the wiring is completed so that electric shock and trouble with the unit can be prevented.

To reduce the effect of electrical noise on device, Low voltage line (especially sensor input cable) wiring must be separated from high current and voltage line. If possible, use shielded cable and shield must be connected to ground only one side.

Before commissioning the device, parameters must be set in accordance with desired use. Incomplete or incorrect configuration can cause dangerous situations.

### 2.1 Unit Configuration

The unit can be programmed using the buttons and LCD display on the front panel or PC Software.

### 2.2 Panel Mounting

The unit is designed for panel mounting. Fixing is by two screw fixings.

- 1- Insert the unit in the panel cut-out from the front.
- 2- Insert the fixings in the slotted at the corners of the unit and tighten the fixing screws to secure the unit against the panel.



**During the equipment is putted in hole on the metal panel while mechanical installation some metal burrs can cause injury on hands, you must be careful.**

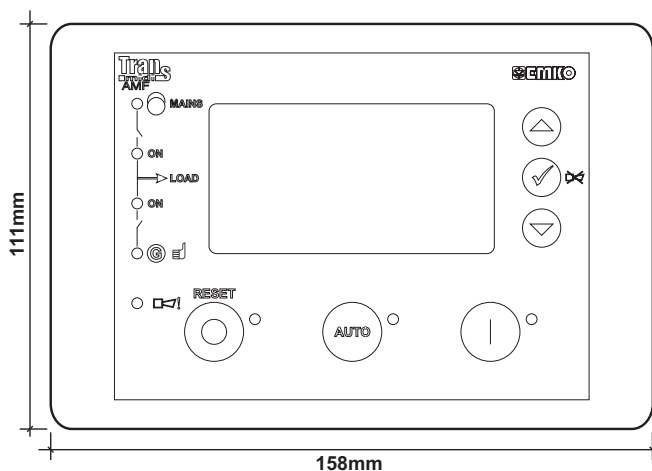

Figure 2.1 Front View

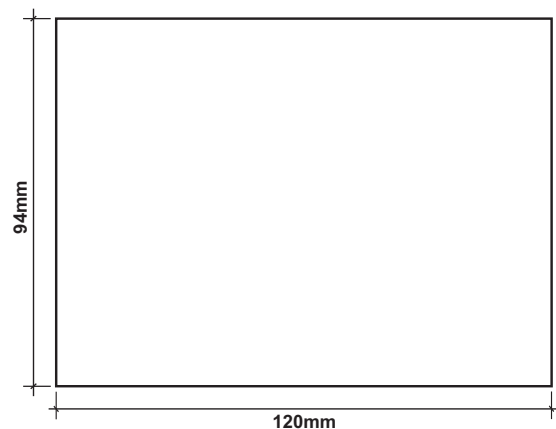
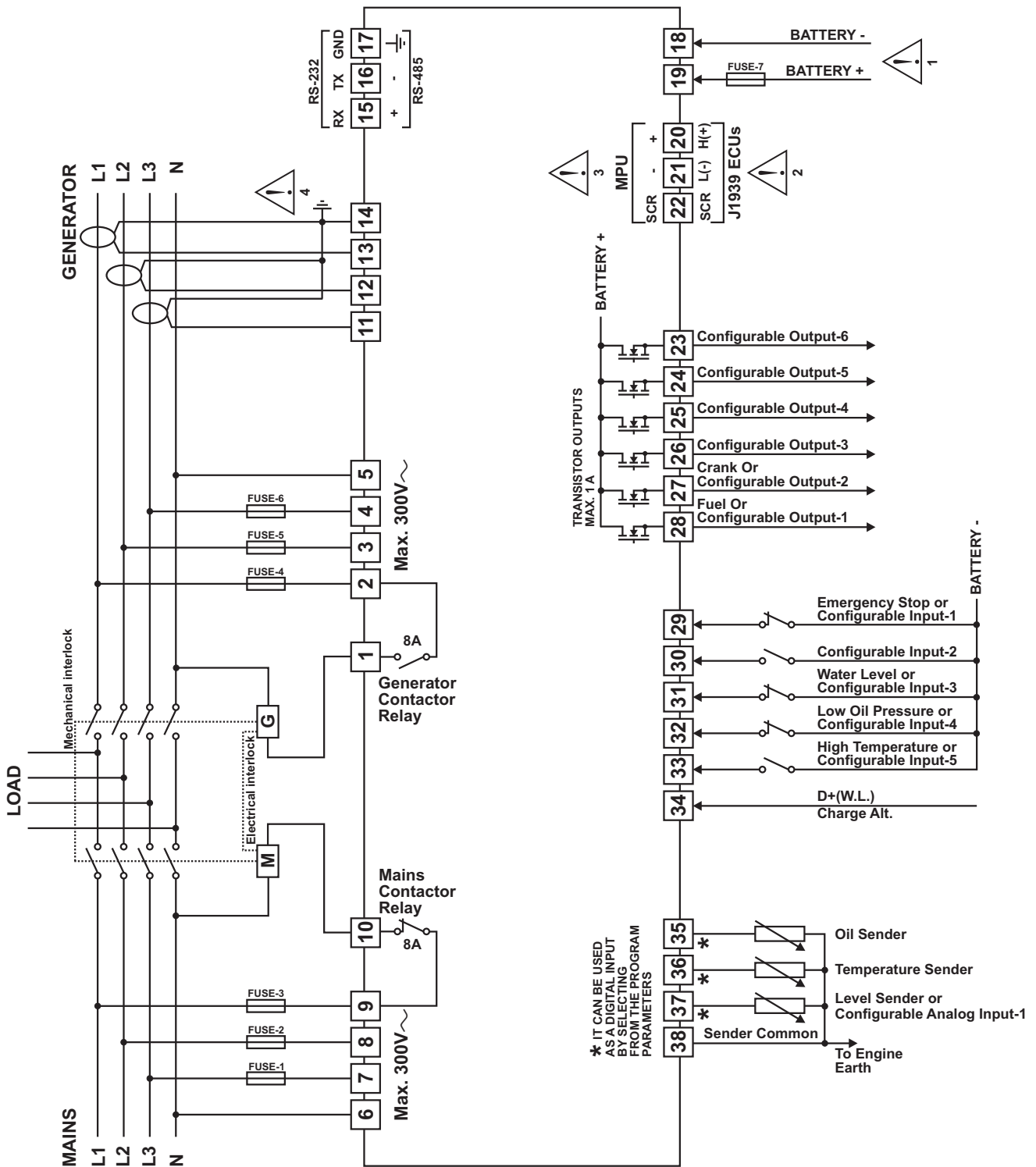

Figure 2.2 Panel Cut-Out

## 2.3 Electrical Connection

TRANS-MidiAMF three phase connections schematic



FUSE-1, FUSE-2, FUSE-5, FUSE-6 2A.T  
 FUSE-3, FUSE-4 8A.T  
 FUSE-7 6A.T



- 1- Connect the unit as shown in the appropriate diagram. Be sure to connect the battery supply the right way round and battery negative should be grounded.
- 2- The CAN interface requires that a 120 Ohms terminator is fitted to each end of the communications link. This termination resistor is fitted internally into the unit. So it is not required externally. The screen is grounded at one end ONLY.
- 3- Screened cable must be used for connecting the Magnetic Pickup, ensuring that the screen is grounded at one end ONLY.
- 4- Current transformers secondary should be grounded. The CT of 5VA is recommended.

### 3. Front Panel Description And Accessing To The Parameters

#### 3.1 Front Panel Description

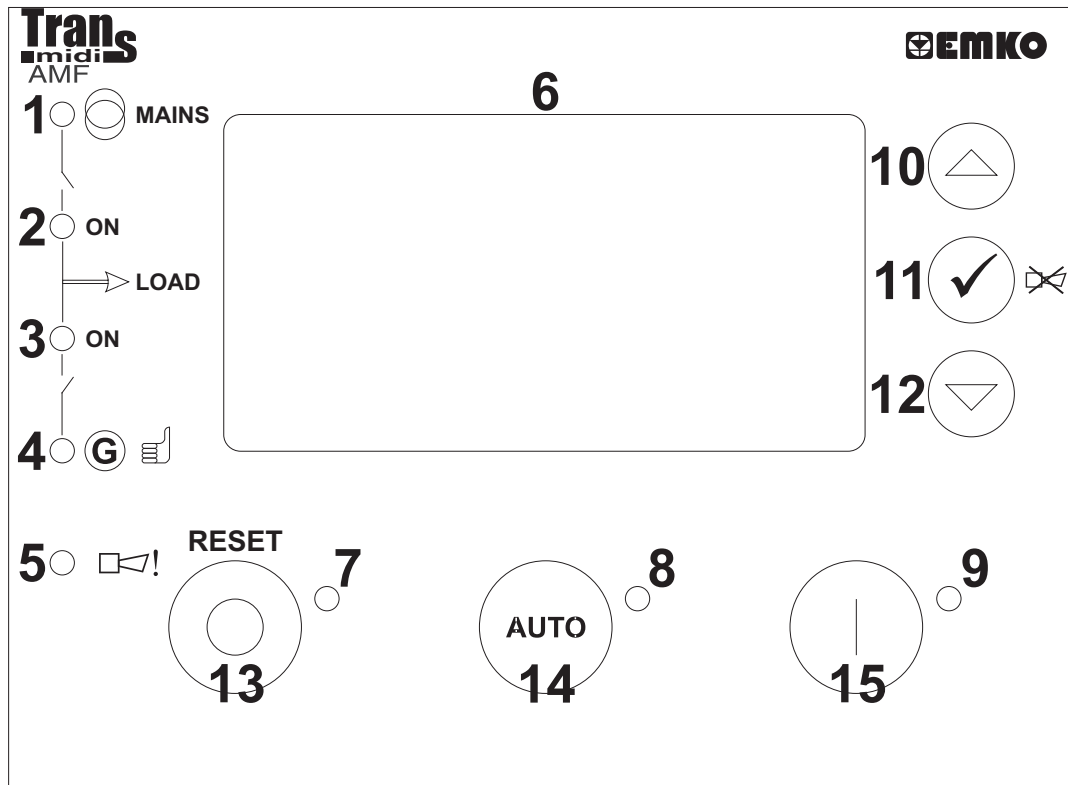

Number	Comment
1	This LED indicates that Mains voltage and frequency is within limits and is ready to take over the load.
2	This LED shows that the load is supplied from the mains.
3	This LED shows that the load is supplied from the generator.
4	This LED indicates that Generator voltage and frequency is within limits and is ready to take over the load.
5	This LED indicates that any alarm was detected.
6	This LCD display is used for displaying the electrical measurements during normal operation, and editing/inspecting programming parameters in program mode.
7	This LED shows that the unit is in the STOP mode.
8	This LED shows that the unit is in the AUTO mode.
9	In the MAN, AUTO and TEST modes, this LED indicates that the engine is starting up or is running.
10	This button is used for showing previous page in normal operation. In Programming mode, it operates as an Up button (changing cursor position) or Increment button (decrease parameter value).
11	In Programming mode it is used for entering parameter edit section, saving parameter value and showing next parameters on the currently selected page. This button will also silence the alarm horn after a failure has been detected.
12	This button is used for showing next page in normal operation. In Programming mode, it operates as an Down button (changing cursor position) or Decrement button (decrease parameter value).
13	The RESET/STOP button is used for changing operating mode of the unit to the Stop Mode. The RESET/STOP button will reset the controller after a failure has been detected. The generator will be stopped.
14	The AUTO button is used for changing operating mode of the unit to the Auto Mode.
15	The START button is used for starting the engine when the unit is in the Manual Mode.



## LCD display Description

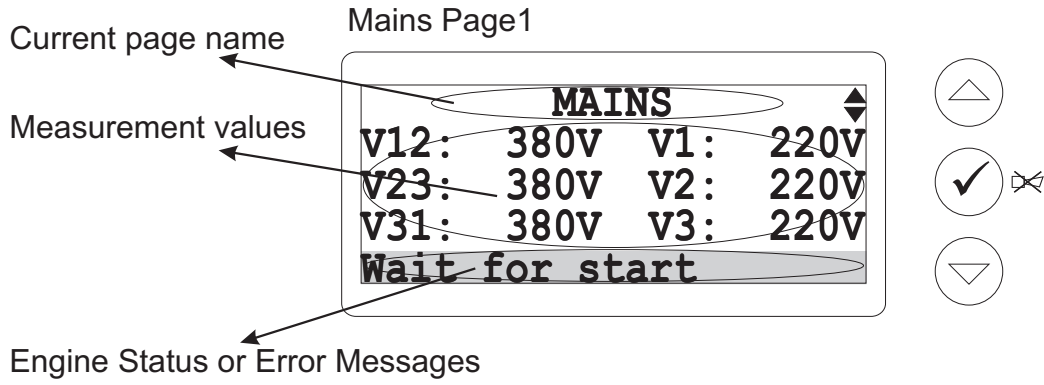

128x64 Dot-matrix LCD display.

Use the Up and Down buttons to select which Data display page (screen) is to be displayed.

When enter button pressed, menu options will be displayed.

Data display pages on the LCD display;

Mains Page1:

```
MAINS
V12: 380V V1: 220V
V23: 380V V2: 220V
V31: 380V V3: 220V
Wait for start
```

V12: Mains voltage L1-L2  
V23: Mains voltage L2-L3  
V31: Mains voltage L3-L1  
V1: Mains voltage L1-N  
V2: Mains voltage L2-N  
V3: Mains voltage L3-N

Mains Page2:

```
MAINS
Fq: 50.0Hz
Phase seq.: L1 L2 L3
Wait for start
```

Fq: Mains frequency  
Phase Seq.: Mains phase sequence

Generator Page1:

```
GENERATOR
V12: 380V V1: 220V
V23: 380V V2: 220V
V31: 380V V3: 220V
On load
```

V12: Generator voltage L1-L2  
V23: Generator voltage L2-L3  
V31: Generator voltage L3-L1  
V1: Generator voltage L1-N  
V2: Generator voltage L2-N  
V3: Generator voltage L3-N

Generator Page2:

```
GENERATOR
I1: 26A PF1: -0.84
I2: 23A PF2: -0.80
I3: 25A PF3: -0.82
On load
```

I1: Load Current L1  
I2: Load Current L2  
I3: Load Current L3  
PF1: Generator power factor L1  
PF2: Generator power factor L2  
PF3: Generator power factor L3

Generator Page3:

```
GENERATOR
Fq: 50.0Hz
Phase seq.: L1 L2 L3
On load
```

Fq: Generator frequency  
Phase Seq.: Generator phase sequence

Generator Page4:

```
GENERATOR
P1: 170kW
P2: 170kW
P3: 170kW
On load
```

P1: Generator active power L1  
P2: Generator active power L2  
P3: Generator active power L3

Generator Page5:

<b>GENERATOR</b>	
Q1:	40kVAr
Q2:	40kVAr
Q3:	40kVAr
On load	

Q1: Generator reactive power L1  
 Q2: Generator reactive power L2  
 Q3: Generator reactive power L3

Generator Page6:

<b>GENERATOR</b>	
S1:	210kVA
S2:	210kVA
S3:	210kVA
On load	

S1: Generator apparent power L1  
 S2: Generator apparent power L2  
 S3: Generator apparent power L3

Generator Page7:

<b>GENERATOR</b>	
$\Sigma P$ :	510kW
$\Sigma Q$ :	120kVAr
$\Sigma S$ :	630kVA
On load	

$\Sigma P$ : Generator total active power  
 $\Sigma Q$ : Generator total reactive power  
 $\Sigma S$ : Generator total apparent power

Generator Page8:

<b>GENERATOR</b>	
kWh :	30600
kVArh:	7200
On load	

kWh: Generator active energy  
 kVArh: Generator reactive energy

Engine Page1:

<b>ENGINE</b>	
Oil Pressure:	4.3bar
Temperature :	30°C
Speed :	1500rpm
On load	

Oil pressure: Oil pressure sender input value  
 Temperature: Coolant temperature sender input value  
 Speed: Engine speed

Engine Page2:

<b>ENGINE</b>	
Conf.AI1 :	96%
Battery volt:	12.0Vdc
Gen.chg.volt:	11.8Vdc
On load	

Conf. AI1: Configurable Analog Input-1 value  
 Battery volt: Battery supply voltage  
 Gen.chg.volt: Charge generator voltage

Engine Page3:

ENGINE	
Run times :	7
Crank times :	11
W.Hour Min:	2_57
On load	

**Run times:** Number of generator runs  
**Crank times:** Number of generator starts  
**W.Hour\_Min:** Engine running time (Hour and Minute)

Engine Maintenance Page:

ENGINE MAINTENANCE	
Next hours :	5000
Next days :	180
Last date:	15/02/2011
On load	

**Next hours:** The remaining hour for maintenance  
**Next days:** The remaining day for maintenance  
**Last date:** The last maintenance date

J1939 Values Page1: \*1

J1939 VALUES	
Engine speed:	1500rpm
Oil pressure:	4.0bar
Coolant temp:	27°C
On load	

**Engine speed:** Engine speed via J1939  
**Oil pressure:** Oil pressure via J1939  
**Coolant temp:** Coolant temperature via J1939

J1939 Values Page2: \*1

J1939 VALUES	
Fuel rate:	12.50L/h
Fuel tot.:	176L
Oil level:	97.2%
On load	

**Fuel rate:** Fuel rate via J1939  
**Fuel tot.:** Fuel total used via J1939  
**Oil level:** Oil level via J1939

J1939 Values Page3: \*1

J1939 VALUES	
Coolant level:	87.6%
Load at cur.spd:	25%
Fuel temper.:	13°C
On load	

**Coolant level:** Coolant level via J1939  
**Load at cur.spd:** Load at current speed via J1939  
**Fuel temper.:** Fuel temperature via J1939

J1939 Values Page4: \*1

J1939 VALUES	
Oil temper.:	82.00°C
Act.engine torq:	75%
Boost press.:	2.8bar
On load	

**Oil temper.:** Oil temperature via J1939  
**Act.engine torq:** Actual engine torque via J1939  
**Boost press.:** Boost pressure via J1939

**Note:** \*1 = These J1939 values pages are only available at Trans-MidiAMF.CAN

J1939 Values Page5: \*2

```

J1939 VALUES
Int.man.temp.: 45°C
Pedal position: 50.0%
W.Hour Min: 2 57
On load
    
```

**Int.man.temp.:** Intake manifold temperature via J1939  
**Pedal position:** Accelerator pedal position via J1939  
**W.Hour\_Min:** Working hour and minute via J1939

J1939 DM1 (Active) Faults Page: \*2

```

J1939 DM1 FAULTS1
Spn:110
Fmi:0          Oc:1
Coolant Temper.sensor
Value too high
    
```

**Spn:** Suspect parameter number (e.g. SPN = 110 corresponds to coolant temperature sensor)  
**Fmi:** Failure mode identifier (e.g. FMI = 0 means value too high)  
**Oc:** Occurrence count (if OC = 0, no alarm is present)  
 The first 10 active alarm messages (Active Diagnostic Trouble Codes - DM1) with SPN, FMI, and OC are displayed). If more than one active fault condition is present, all of them is displayed sequentially by pressing Next and Previous buttons.

GPRS Page: \*3

```

GPRS
Operator Name
IP :0.0.0.0
APN:mgb
    
```

**Signal Quality:** Signal Quality level indicator  
**Operator Name:** Operator name  
**IP:** Device IP value  
**APN:** Access point name of the operator

GPS Page: \*3

```

GPS
LAT:40.10529
LNG:29.18514
    
```

**LAT:** Latitude value of device's position  
**LNG:** Longitude value of device's position

Input & Output Status Page:

```

INPUT & OUTPUT
          1 4 5 8
Inputs : 0000 0XXX
Outputs: 0000 0000
On load
    
```

**Inputs:** Input status information. If an input is active, related digit is displayed as "1" else it is displayed as "0".  
 1: Conf. in-1, 2: Conf. in-2, 3: Conf. in-3, 4: Conf. in-4,  
 5: Conf. in-5, 6: Conf. in-6, 7: Conf. in-7, 8: Not available.  
**Outputs:** Output status information. If an output is active, related digit is displayed as "1" else it is displayed as "0".  
 1: Conf. out-1, 2: Conf. out-2, 3: Conf. out-3, 4: Conf. out-4,  
 5: Conf. out-5, 6: Conf. out-6, 7: Generator contactor,  
 8: Mains contactor.

Date & Time Page:

```

DATE & TIME
15/02/2011
13:32:28
    
```

**Date:** Day, Month, Year.  
**Time:** Hour, minute, second.

**Note:** \*2 = These J1939 values pages are only available at Trans-MidiAMF.CAN  
 \*3 = GPRS page is only available on devices with GPRS feature  
 \*3 = GPS page is only available on devices with GPRS/GPS feature

GenSet Page: (This page is only available at TRANS-AMF.TR device)

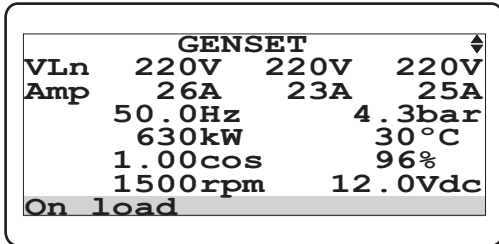

**VLn:** Generator voltage L1-N, L2-N and L3-N  
**Amp:** Generator current L1, L2 and L3  
**Hz:** Generator frequency  
**bar:** Oil pressure sender input value  
**kW:** Generator total active power  
**°C:** Coolant temperature sender input value  
**cos:** Generator power factor average  
**%:** Configurable Analog Input-1 value  
**rpm:** Engine speed  
**Vdc:** Battery supply voltage

Synchronoscope Page:

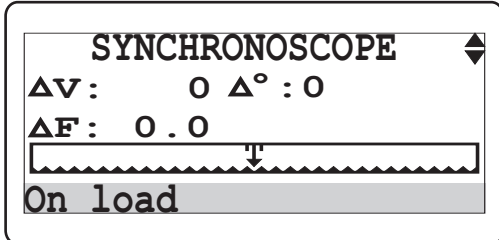

This page is for observing level differences between generator and mains voltage, frequency and phase angle. When an uninterrupted transfer is in progress, synchronoscope page will be shown automatically.

Breaker Control Page:

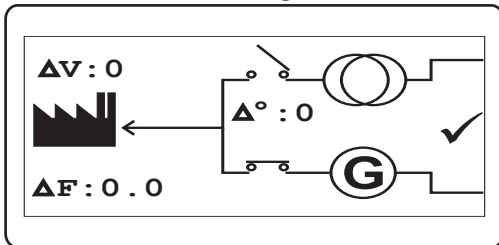

This page let's you to control Mains and Generator Breakers

Event Log display pages on the LCD display;

Event Log Page1:

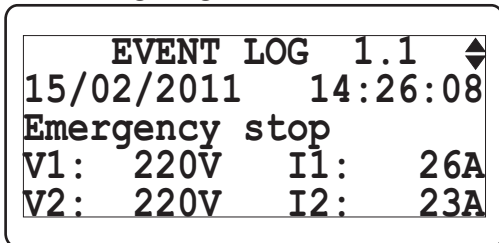

**1.1:** The first page of related event log  
**Emergency stop:** This message indicates that an emergency stop alarm has occurred. (Event history: 15/02/2011 date, 14:26:08 time).  
**V1:** Generator voltage L1-N  
**I1:** Load Current L1  
**V2:** Generator voltage L2-N  
**I2:** Load Current L2

Event Log Page2:

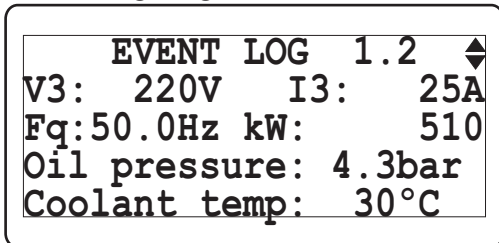

**1.2:** The second page of related event log  
**V3:** Generator voltage L3-N  
**I3:** Load Current L3  
**Fq:** Generator frequency  
**kW:** Generator total active power  
**Oil oressure:** Oil pressure sender input value  
**Coolant temp:** Coolant temperature sender input value

Event Log Page3:

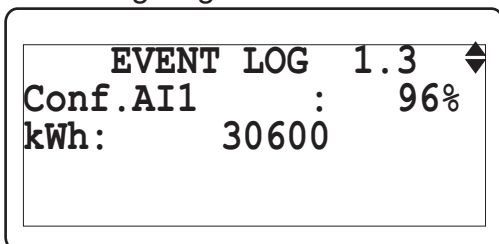

**1.3:** The last page of related event log  
**Conf. AI1:** Configurable Analog Input-1 value  
**KWh:** Generator active energy  
 Events (from 1 to 50) can be displayed sequentially with the Next and Previous buttons.

**Example-1:** Displaying all Data display pages.

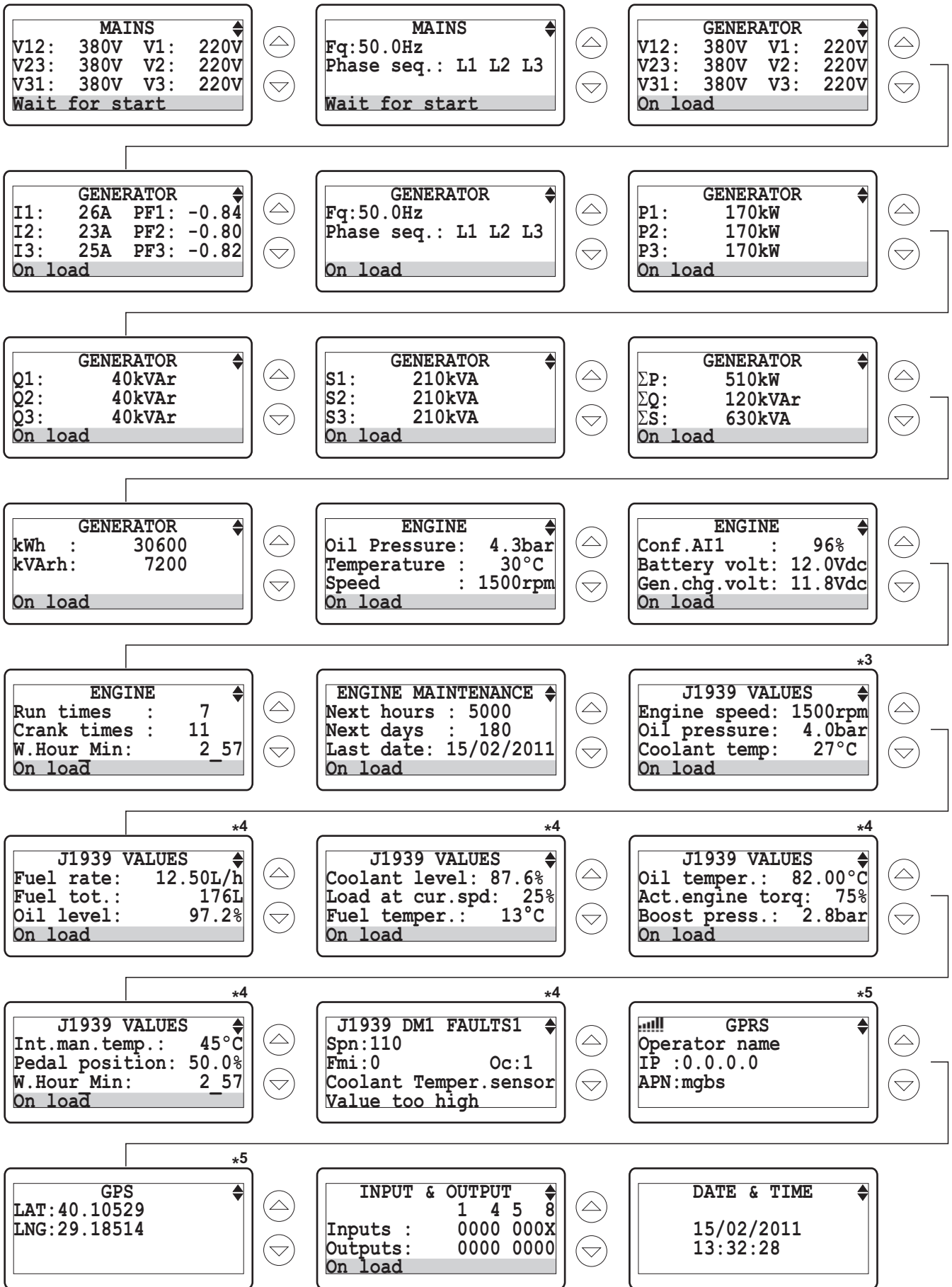

**Note:** \*4 = These J1939 pages are only available at Trans-MidiAMF.CAN  
 \*5 = GPRS page is only available on devices with GPRS feature  
 \*5 = GPS page only available on devices with GPRS/GPS feature

## Example-2: Displaying all Event Log display pages

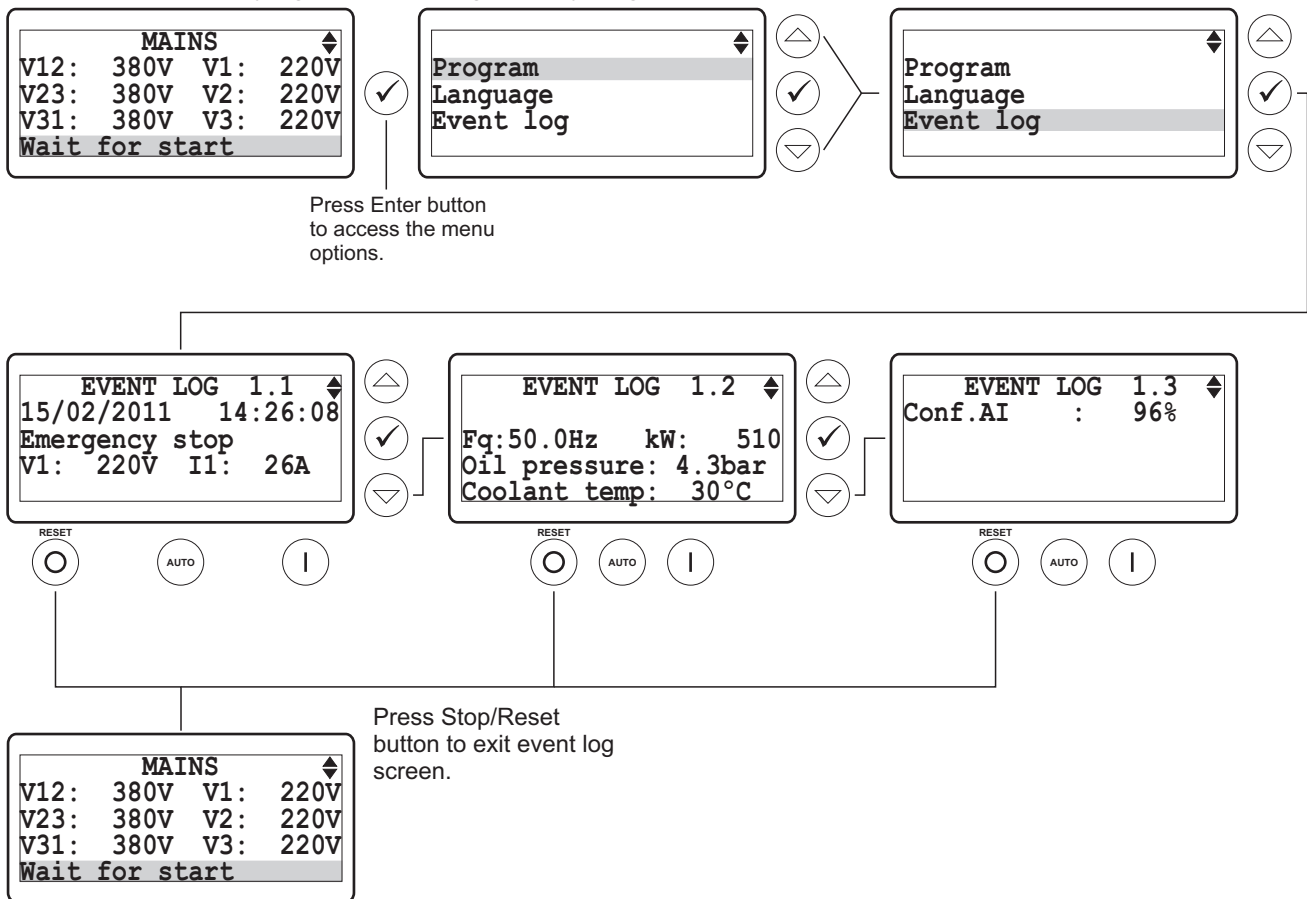

## LCD display language selection

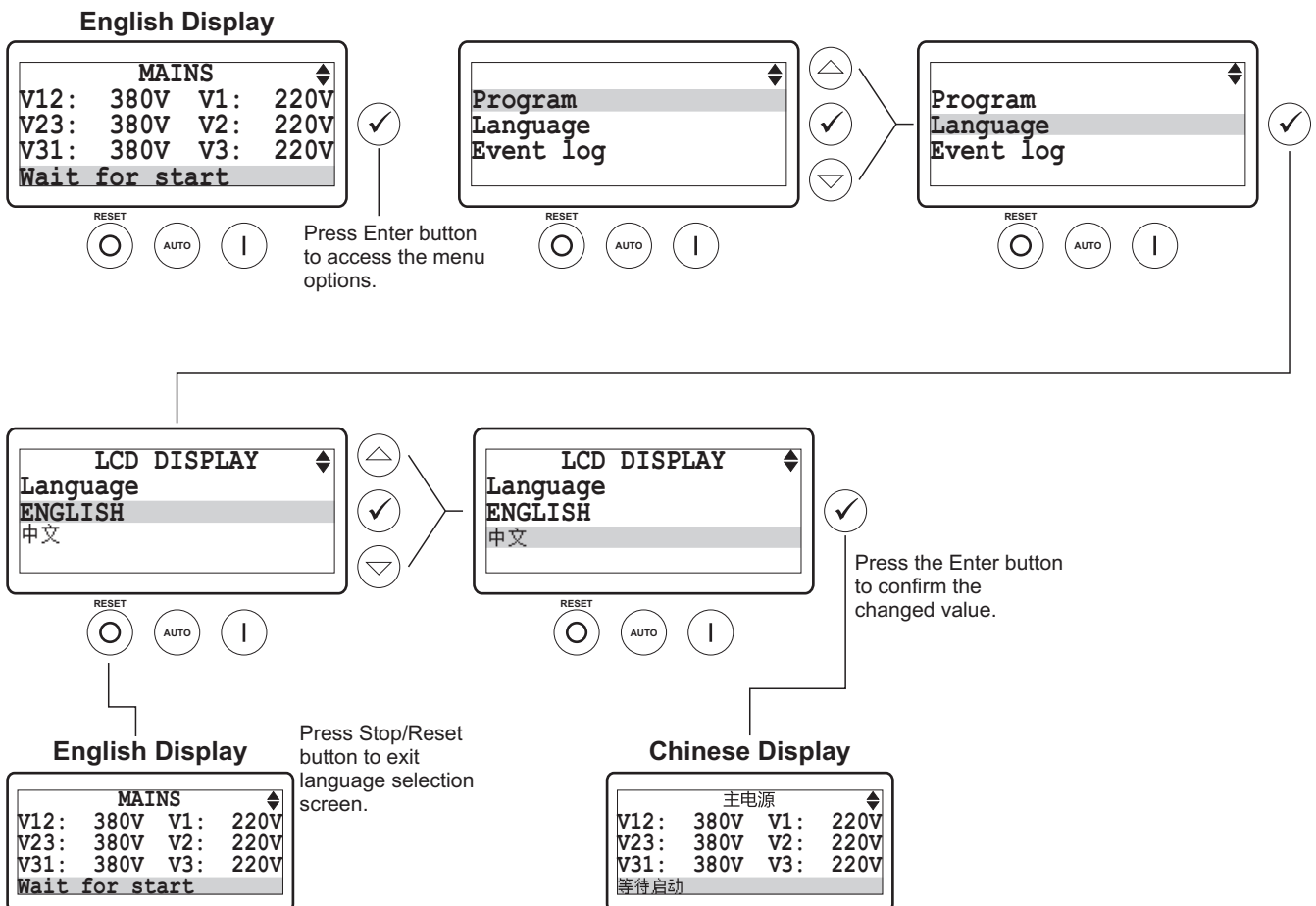



# Breaker Control in Manual Mode

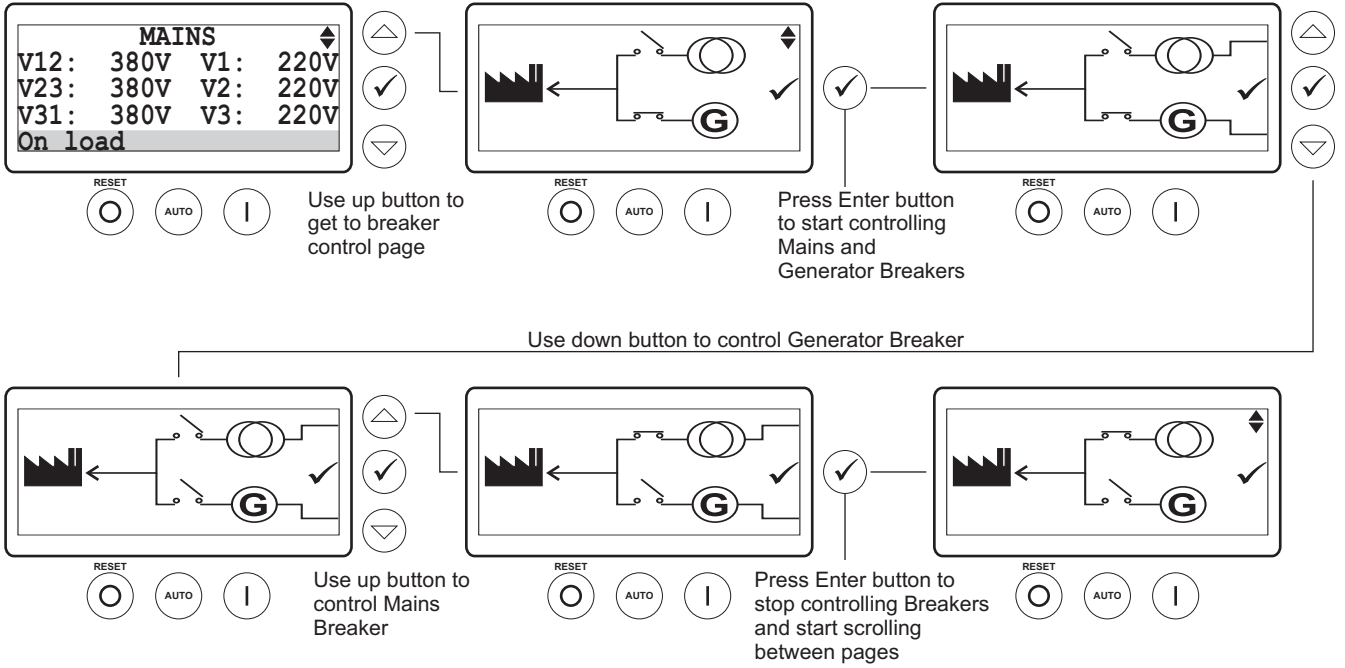

## 3.2 Accessing To The Operator Parameters

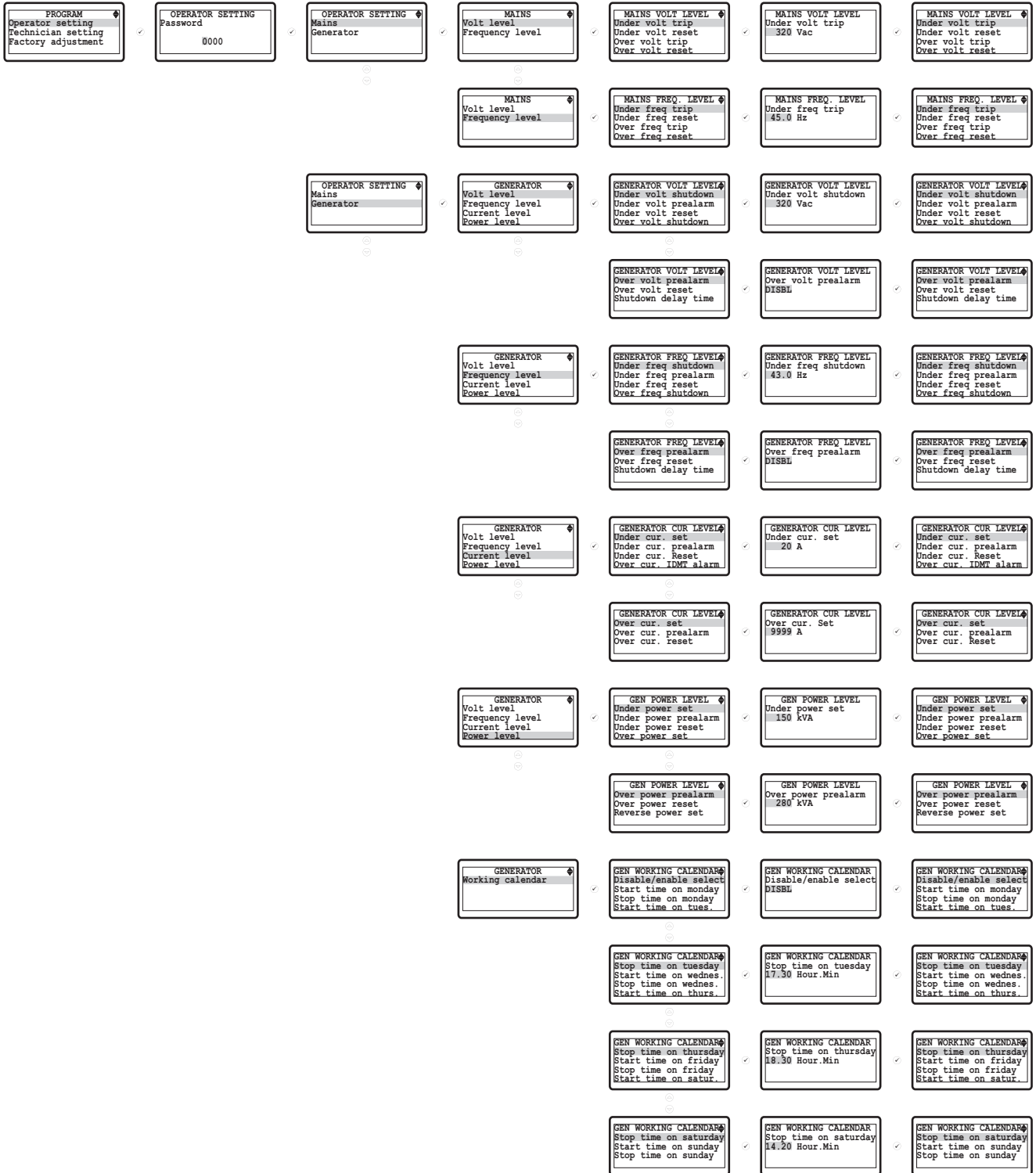

### 3.3 Accessing To The Technician Parameters

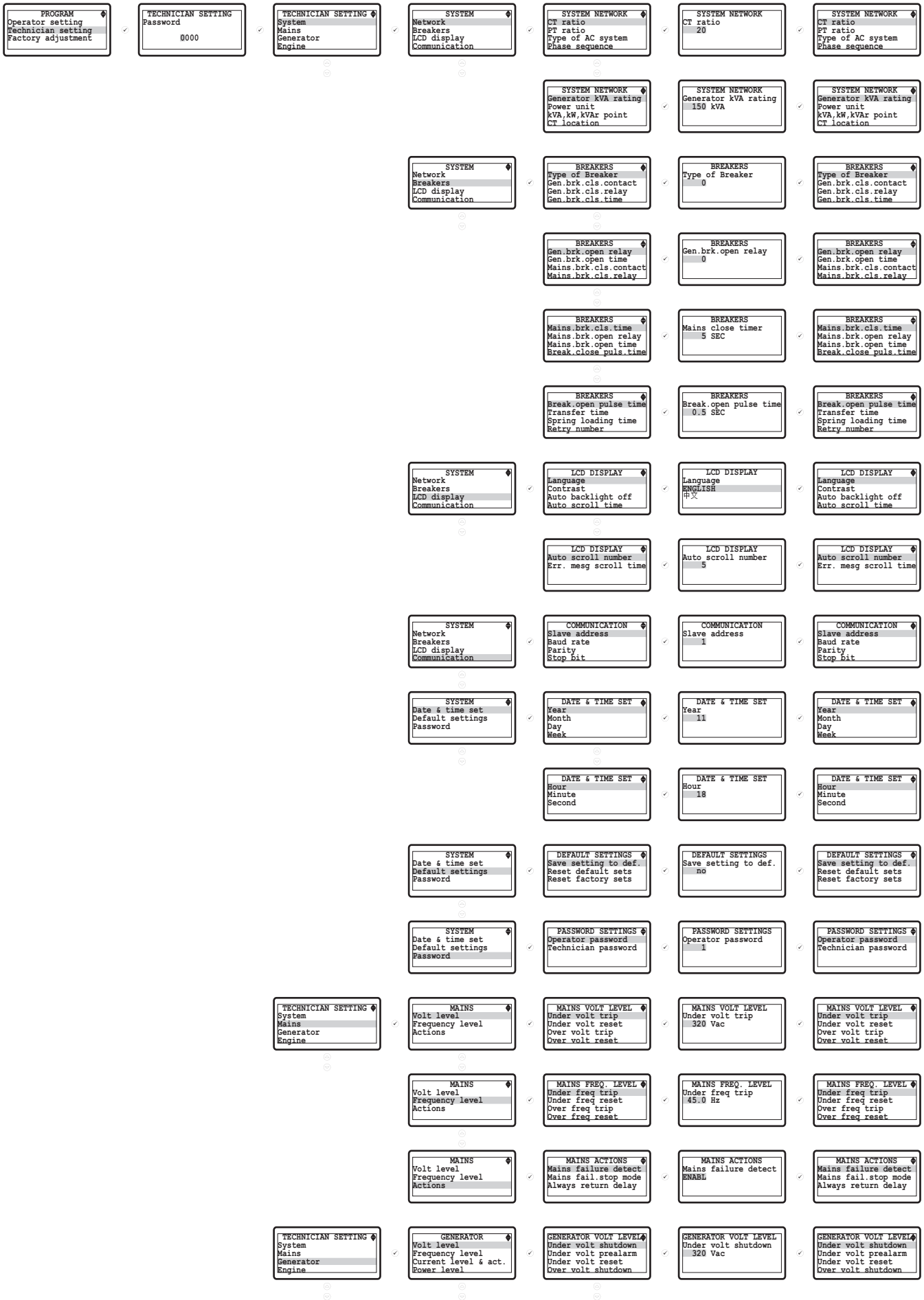

		GENERATOR VOLT LEVEL Over volt prealarm Over volt reset Shutdown delay time	GENERATOR VOLT LEVEL Over volt prealarm DYSEI	GENERATOR VOLT LEVEL Over volt prealarm Over volt reset Shutdown delay time
GENERATOR Volt level Frequency level Current level & act. Power level		GENERATOR FREQ LEVEL Nominal frequency Under freq shutdown Under freq prealarm Under freq reset	GENERATOR FREQ LEVEL Nominal frequency 50.0 Hz	GENERATOR FREQ LEVEL Nominal frequency Under freq shutdown Under freq prealarm Under freq reset
		GENERATOR FREQ LEVEL Over freq shutdown Over freq prealarm Over freq reset Shutdown delay time	GENERATOR FREQ LEVEL Over freq shutdown 58.0 Hz	GENERATOR FREQ LEVEL Over freq shutdown Over freq prealarm Over freq reset Shutdown delay time
GENERATOR Volt level Frequency level Current level & act. Power level		GEN CUR LEVEL & ACT Under cur. set Under cur. prealarm Under cur. reset Under cur. act.	GEN CUR LEVEL & ACT Under cur. set 20 A	GEN CUR LEVEL & ACT Under cur. set Under cur. prealarm Under cur. reset Under cur. act.
		GEN CUR LEVEL & ACT Under act. delay time Over cur. IDMT alarm Over cur. set Over cur. prealarm	GEN CUR LEVEL & ACT Under act. delay time 2 SEC	GEN CUR LEVEL & ACT Under act. delay time Over cur. IDMT alarm Over cur. set Over cur. prealarm
		GEN CUR LEVEL & ACT Over cur. reset Over cur. act. Over act. delay time Short circuit cur.	GEN CUR LEVEL & ACT Over cur. reset 9980 A	GEN CUR LEVEL & ACT Over cur. reset Over cur. act. Over act. delay time Short circuit cur.
		GEN CUR LEVEL & ACT Unbalance load set Unbalance load act. Unbalance act. delay	GEN CUR LEVEL & ACT Unbalance load set 0 A	GEN CUR LEVEL & ACT Unbalance load set Unbalance load act. Unbalance act. delay
GENERATOR Volt level Frequency level Current level & act. Power level		GEN POWER LEVEL Under power set Under power prealarm Under power reset Under power act.	GEN POWER LEVEL Under power shutdown 150 kVA	GEN POWER LEVEL Under power set Under power prealarm Under power reset Under power act.
		GEN POWER LEVEL Under act. delay time Over power set Over power prealarm Over power reset	GEN POWER LEVEL Under act. delay time 2 SEC	GEN POWER LEVEL Under act. delay time Over power set Over power prealarm Over power reset
		GEN POWER LEVEL Over power act. Over act. delay time Reverse power set Reverse power act.	GEN POWER LEVEL Over power act. DISBL	GEN POWER LEVEL Over power act. Over act. delay time Reverse power set Reverse power act.
		GEN POWER LEVEL Rv.pow.act.delay time	GEN POWER LEVEL Rv.pow.act.delay time 2 SEC	GEN POWER LEVEL Rv.pow.act.delay time
GENERATOR Working calendar General		GEN WORKING CALENDAR Disable/enable select Start time on monday Stop time on monday Start time on tues.	GEN WORKING CALENDAR Disable/enable select DISBL	GEN WORKING CALENDAR Disable/enable select Start time on monday Stop time on monday Start time on tues.
		GEN WORKING CALENDAR Stop time on tuesday Start time on wednes. Stop time on wednes. Start time on thurs.	GEN WORKING CALENDAR Stop time on tuesday 17.30 Hour.Min	GEN WORKING CALENDAR Stop time on tuesday Start time on wednes. Stop time on wednes. Start time on thurs.
		GEN WORKING CALENDAR Stop time on thursday Start time on friday Stop time on friday Start time on satur.	GEN WORKING CALENDAR Stop time on thursday 18.30 Hour.Min	GEN WORKING CALENDAR Stop time on thursday Start time on friday Stop time on friday Start time on satur.
		GEN WORKING CALENDAR Stop time on saturday Start time on sunday Stop time on sunday	GEN WORKING CALENDAR Stop time on saturday 14.20 Hour.Min	GEN WORKING CALENDAR Stop time on saturday Start time on sunday Stop time on Sunday
GENERATOR Working calendar General		GENERATOR GENERAL Sens.option gen.freq Sens.opt.pickup&flywh All warning are latch	GENERATOR GENERAL Sens.option gen.freq DISBL	GENERATOR GENERAL Sens.option gen.freq Sens.opt.pickup&flywh All warning are latch
TECHNICIAN SETTING System Mains Generator Engine	ENGINE Starting options Crank disconnect Speed settings Elant battery	ENGINE START OPTIONS Horn prior start No. of start attempt Cranking time Crank rest time	ENGINE START OPTIONS Horn prior start DISBL	ENGINE START OPTIONS Horn prior start No. of start attempt Cranking time Crank rest time
		ENGINE START OPTIONS Pickup fail delay	ENGINE START OPTIONS Pickup fail delay 3.0 sec	ENGINE START OPTIONS Pickup fail delay

Note: \*6 = "Sens.opt.pickup&flywh" and "Pickup fail delay" parameters are only available at Trans-MidiAMF.MPU

ENGINE Starting options Crank disconnect Speed settings Plant battery	ENG.CRANK DISCONNECT Generator frequency Engine speed Generator volt Alt. Charge.volt	ENG.CRANK DISCONNECT Generator frequency 30.0 Hz	ENG.CRANK DISCONNECT Generator frequency Engine speed Generator volt Alt. Charge.volt
	ENG.CRANK DISCONNECT Oil pres. Enab./dis. Oil pressure value Check oil befor.start	ENG.CRANK DISCONNECT Oil pres. Enab./dis. DISBL	ENG.CRANK DISCONNECT Oil pres. Enab./dis. Oil pressure value Check oil befor.start
ENGINE Starting options Crank disconnect Speed settings Plant battery	ENGINE SPEED SETS Nominal speed Under speed shutdown Under speed prealarm Under speed reset	ENGINE SPEED SETS Nominal speed 1500 RPM	ENGINE SPEED SETS Nominal speed Under speed shutdown Under speed prealarm Under speed reset
	ENGINE SPEED SETS Over speed shutdown Over speed prealarm Over speed reset Shutdown delay time	ENGINE SPEED SETS Over speed shutdown DISBL	ENGINE SPEED SETS Over speed shutdown Over speed prealarm Over speed reset Shutdown delay time
ENGINE Starting options Crank disconnect Speed settings Plant battery	ENGINE PLANT BATTERY Under volt shutdown Under volt warning Under volt reset Under volt delay	ENGINE PLANT BATTERY Under volt shutdown 11.0 Vdc	ENGINE PLANT BATTERY Under volt shutdown Under volt warning Under volt reset Under volt delay
	ENGINE PLANT BATTERY Over volt shutdown Over volt warning Over volt reset Over volt delay	ENGINE PLANT BATTERY Over volt shutdown DISBL	ENGINE PLANT BATTERY Over volt shutdown Over volt warning Over volt reset Over volt delay
	ENGINE PLANT BATTERY Alt. chg. warning	ENGINE PLANT BATTERY Alt. chg. Warning DISBL	ENGINE PLANT BATTERY Alt. chg. warning
*7 ENGINE CanBus ECU CanBus error set Maintenance Load exercise	*7 CANBUS ECU Baud rate J1939 ECU type Device address SPN version	CANBUS ECU Baud rate 4	CANBUS ECU Baud rate J1939 ECU type Device address SPN version
	*7 CANBUS ECU ECU remote control Speed control enable Oil Pres cont. enab Temp_control enable	CANBUS ECU ECU remote control DISBL	CANBUS ECU ECU remote control Speed control enable Oil Pres cont. enab Temp_control enable
	*7 CANBUS ECU Speed set point Speed correction	CANBUS ECU Speed set point 1500 RPM	CANBUS ECU Speed set point Speed correction
*7 ENGINE CanBus ECU CanBus error set Maintenance Load exercise	*7 CANBUS ERROR SET CAN fault actions CAN fault activation CAN fault delay Amber warn.actions	CANBUS ERROR SET CAN fault actions DISBL	CANBUS ERROR SET CAN fault actions CAN fault activation CAN fault delay Amber warn.actions
	*7 CANBUS ERROR SET Amber warn.activation Amber warn.delay Red stop actions Red stop activation	CANBUS ERROR SET Amber warn.activation 2	CANBUS ERROR SET Amber warn.activation Amber warn.delay Red stop actions Red stop activation
	*7 CANBUS ERROR SET Red stop delay	CANBUS ERROR SET Red stop delay 2 SEC	CANBUS ERROR SET Red stop delay
*7 ENGINE CanBus ECU CanBus error set Maintenance Load exercise	*7 ENGINE MAINTENANCE Running hour interval Maint. date interval Eng. stop when maint Eng.running hour (lsb)	ENGINE MAINTENANCE Running hour interval 600 HOUR	ENGINE MAINTENANCE Running hour interval Maint. date interval Eng. stop when maint Eng.running hour (lsb)
	ENGINE MAINTENANCE Eng.running hour Eng.running hour (msb) Maintenance okay	ENGINE MAINTENANCE Eng. running hour 0	ENGINE MAINTENANCE Eng. running hour (msb) Maintenance okay
*7 ENGINE CanBus ECU CanBus error set Maintenance Load exercise	*7 LOAD EXERCISE Disable/enable select	LOAD EXERCISE Disable/enable select DISBL	LOAD EXERCISE Disable/enable select

Note: \*7 = "CanBus ECU" and "CanBus error set" parameter pages are only available at Trans-MidiAMF.CAN

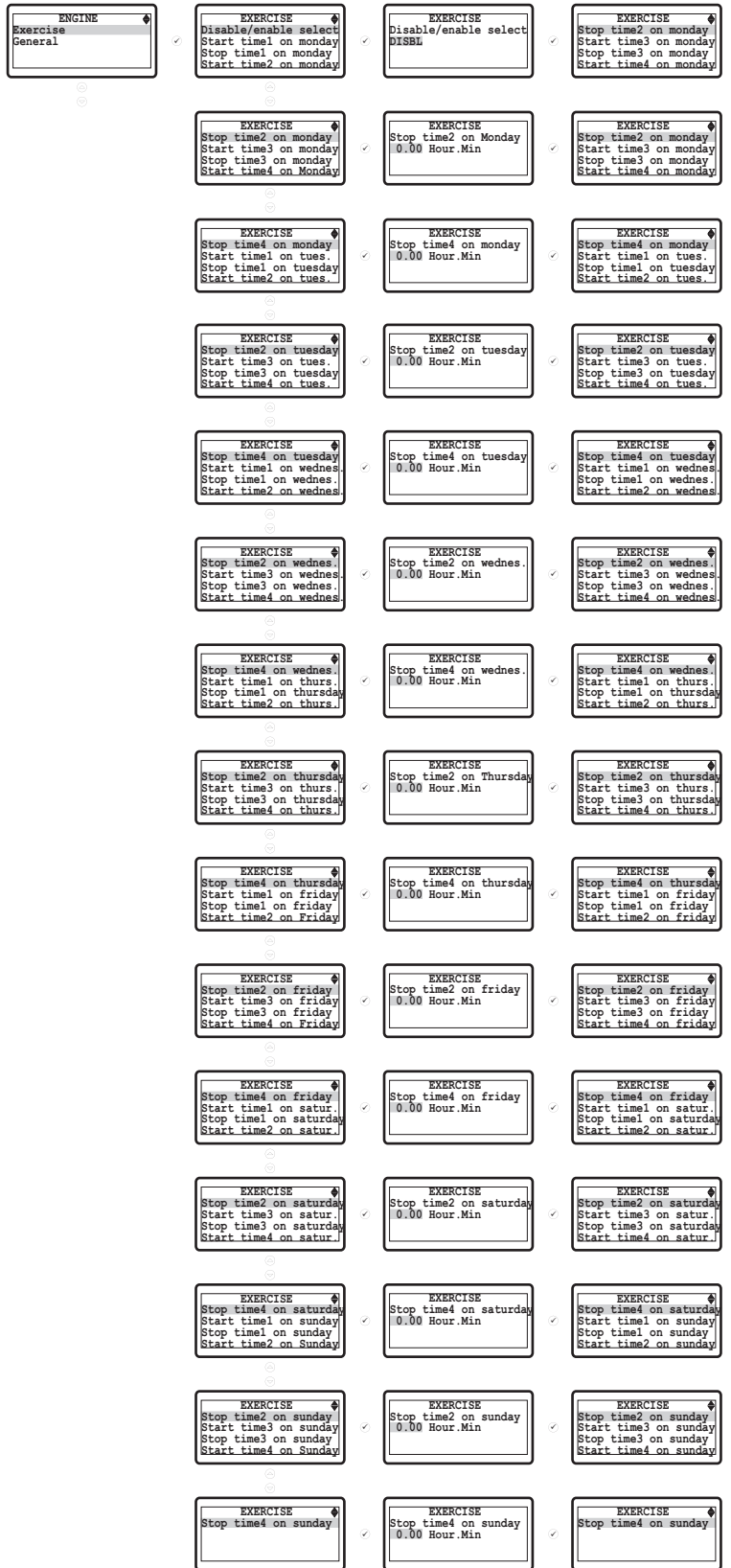

	ENGINE Exercise General	ENGINE GENERAL Fuel selection Stop solenoid time Ignition delay Gas valve delay	ENGINE GENERAL Fuel selection 1-DIESEL	ENGINE GENERAL Fuel selection Stop solenoid time Ignition delay Gas valve delay
		ENGINE GENERAL Min. of ignition speed Choke time	ENGINE GENERAL Min. of ignition speed 200 RPM	ENGINE GENERAL Min. of ignition speed Choke time
TECHNICIAN SETTING Inputs Outputs Timers Expansion modules	INPUTS Sender inputs Sender linearisations Conf. input-1 Conf. input-2	SENDER INPUTS Oil pressure unit Oil press. input type Oil pressure prealarm Oil pressure reset	SENDER INPUTS Oil pressure unit Bar	SENDER INPUTS Oil pressure unit Oil press. input type Oil pressure prealarm Oil pressure reset
		SENDER INPUTS Oil pressure shutdown Temperature unit Temp. input type High temp. prealarm	SENDER INPUTS Oil press. shutdown 1.0 Bar	SENDER INPUTS Oil pressure shutdown Temperature unit Temp. input type High temp. Pxsalarm
		SENDER INPUTS High temp. reset High temp. shutdown Low temp. Warning Heater control ON	SENDER INPUTS High temp. reset 88 °C	SENDER INPUTS High temp. reset High temp. shutdown Low temp. Warning Heater control ON
		SENDER INPUTS Heater control OFF Water pump on time Water pump off time Conf. All unit	SENDER INPUTS Heater control OFF 45 °C	SENDER INPUTS Heater control OFF Water pump on time Water pump off time Conf. All unit
		SENDER INPUTS Conf. All type Conf. All low prealarm Conf. All low reset Conf. All low shutdown	SENDER INPUTS Conf. All type 0=NOT USED	SENDER INPUTS Conf. All type Conf. All low prealarm Conf. All low reset Conf. All low shutdown
		SENDER INPUTS Conf. All high prealarm Conf. All high reset Conf. All high shutdown Conf. All control ON	SENDER INPUTS Conf. All high prealarm DISBL	SENDER INPUTS Conf. All high prealarm Conf. All high reset Conf. All high shutdown Conf. All control ON
		SENDER INPUTS Conf. All control OFF	SENDER INPUTS Conf. All control OFF 75 %	SENDER INPUTS Conf. All control OFF
	INPUTS Sender inputs Sender linearisations Conf. input-1 Conf. input-2	SENDER LINEARISATION Oil pressure sender 1 Oil pressure 1 Oil pressure sender 2 Oil pressure 2	SENDER LINEARISATION Oil pressure sender 1 10 R	SENDER LINEARISATION Oil pressure sender 1 Oil pressure 1 Oil pressure sender 2 Oil pressure 2
		SENDER LINEARISATION Oil pressure sender 3 Oil pressure 3 Oil pressure sender 4 Oil pressure 4	SENDER LINEARISATION Oil pressure sender 3 62 R	SENDER LINEARISATION Oil pressure sender 3 Oil pressure 3 Oil pressure sender 4 Oil pressure 4
		SENDER LINEARISATION Oil pressure sender 5 Oil pressure 5 Oil pressure sender 6 Oil pressure 6	SENDER LINEARISATION Oil pressure sender 5 111 R	SENDER LINEARISATION Oil pressure sender 5 Oil pressure 5 Oil pressure sender 6 Oil pressure 6
		SENDER LINEARISATION Oil pressure sender 7 Oil pressure 7 Oil pressure sender 8 Oil pressure 8	SENDER LINEARISATION Oil pressure sender 7 156 R	SENDER LINEARISATION Oil pressure sender 7 Oil pressure 7 Oil pressure sender 8 Oil pressure 8
		SENDER LINEARISATION Oil pressure sender 9 Oil pressure 9 Oil press. sender 10 Oil pressure 10	SENDER LINEARISATION Oil pressure sender 9 205 R	SENDER LINEARISATION Oil pressure sender 9 Oil pressure 9 Oil press. sender 10 Oil pressure 10
		SENDER LINEARISATION Temperature sender 1 Temperature 1 Temperature sender 2 Temperature 2	SENDER LINEARISATION Temperature sender 1 360 R	SENDER LINEARISATION Temperature sender 1 Temperature 1 Temperature sender 2 Temperature 2
		SENDER LINEARISATION Temperature sender 3 Temperature 3 Temperature sender 4 Temperature 4	SENDER LINEARISATION Temperature sender 3 145 R	SENDER LINEARISATION Temperature sender 3 Temperature 3 Temperature sender 4 Temperature 4
		SENDER LINEARISATION Temperature sender 5 Temperature 5 Temperature sender 6 Temperature 6	SENDER LINEARISATION Temperature sender 5 50 R	SENDER LINEARISATION Temperature sender 5 Temperature 5 Temperature sender 6 Temperature 6

SENDER LINEARISATION Temperature sender 7 Temperature 7 Temperature sender 8 Temperature 8	SENDER LINEARISATION Temperature sender 7 43 R	SENDER LINEARISATION Temperature sender 7 Temperature 7 Temperature sender 8 Temperature 8		
SENDER LINEARISATION Temperature sender 9 Temperature 9 Temperature sender 10 Temperature 10	SENDER LINEARISATION Temperature sender 9 10 R	SENDER LINEARISATION Temperature sender 9 Temperature 9 Temperature sender 10 Temperature 10		
SENDER LINEARISATION Conf. All sender 1 Conf. All value 1 Conf. All sender 2 Conf. All value 2	SENDER LINEARISATION Conf. All sender 1 10 R	SENDER LINEARISATION Conf. All sender 1 Conf. All value 1 Conf. All sender 2 Conf. All value 2		
SENDER LINEARISATION Conf. All sender 3 Conf. All value 3 Conf. All sender 4 Conf. All value 4	SENDER LINEARISATION Conf. All sender 3 50 R	SENDER LINEARISATION Conf. All sender 3 Conf. All value 3 Conf. All sender 4 Conf. All value 4		
SENDER LINEARISATION Conf. All sender 5 Conf. All value 5 Conf. All sender 6 Conf. All value 6	SENDER LINEARISATION Conf. All sender 5 90 R	SENDER LINEARISATION Conf. All sender 5 Conf. All value 5 Conf. All sender 6 Conf. All value 6		
SENDER LINEARISATION Conf. All sender 7 Conf. All value 7 Conf. All sender 8 Conf. All value 8	SENDER LINEARISATION Conf. All sender 7 130 R	SENDER LINEARISATION Conf. All sender 7 Conf. All value 7 Conf. All sender 8 Conf. All value 8		
SENDER LINEARISATION Conf. All sender 9 Conf. All value 9 Conf. All sender 10 Conf. All value 10	SENDER LINEARISATION Conf. All sender 9 170 R	SENDER LINEARISATION Conf. All sender 9 Conf. All value 9 Conf. All sender 10 Conf. All value 10		
INPUTS Sender inputs Sender linearisations Conf. input-1 Conf. input-2	CONF. INPUT-1 Dis,user conf.or list Polarity Indication Activation	CONF. INPUT-1 Dis,user conf.or list 1	CONF. INPUT-1 Dis,user conf.or list Polarity Indication Activation	
	CONF. INPUT-1 Select from list Active delay	CONF. INPUT-1 Select from list 2= AUX. MAINS FAIL	CONF. INPUT-1 Select from list Active delay	
INPUTS Sender inputs Sender linearisations Conf. input-1 Conf. input-2	CONF. INPUT-2 Dis,user conf.or list Polarity Indication Activation	CONF. INPUT-2 Dis,user conf.or list 1	CONF. INPUT-2 Dis,user conf.or list Polarity Indication Activation	
	CONF. INPUT-2 Select from list Active delay	CONF. INPUT-2 Select from list 3=SIM.LAMP TEST BUT	CONF. INPUT-2 Select from list Active delay	
INPUTS Conf. input-3 Conf. input-4 Conf. input-5	CONF. INPUT-3 Dis,user conf.or list Polarity Indication Activation	CONF. INPUT-3 Dis,user conf.or list 1	CONF. INPUT-3 Dis,user conf.or list Polarity Indication Activation	
	CONF. INPUT-3 Select from list Active delay	CONF. INPUT-3 Select from list 4=SIM.HORN REST BUT	CONF. INPUT-3 Select from list Active delay	
TECHNICIAN SETTING Inputs Outputs Timers Expansion modules	OUTPUTS Conf. output-1 Conf. output-2 Conf. output-3 Conf. output-4	CONF. OUTPUT-1 Polarity Function	CONF. OUTPUT-1 Polarity NO	CONF. OUTPUT-1 Polarity Function
	OUTPUTS Conf. output-5 Conf. output-6	CONF. OUTPUT-5 Polarity Function	CONF. OUTPUT-5 Polarity NO	CONF. OUTPUT-5 Polarity Function
TECHNICIAN SETTING Inputs Outputs Timers Expansion modules	TIMERS Start timers Stopping timers	START TIMERS Mains transient delay Mains fail start delay Remote start delay Pre-heat	START TIMERS Mains transient delay 2.0 SEC	START TIMERS Mains transient delay Mains fail start delay Remote start delay Pre-heat
	START TIMERS Pre-heat bypass Safety on delay Warming up time Horn duration	START TIMERS Pre-heat bypass 0 MIN	START TIMERS Pre-heat bypass Safety on delay Warming up time Horn duration	



		START TIMERS Chg. excitation time Cooling fan time Idle mode time Idle mode time off	START TIMERS Chg. excitation time 15 SEC	START TIMERS Chg. excitation time Cooling fan time Idle mode time Idle mode time off
	TIMERS Start timers Stopping timers	STOPPING TIMERS Mains return delay Remote stop delay Cooling time Fail to stop delay	STOPPING TIMERS Mains return delay 5 SEC	STOPPING TIMERS Mains return delay Remote stop delay Cooling time Fail to stop delay
TECHNICIAN SETTING Inputs Outputs Timers Synchronization	SYNCHRONIZATION Synch check	SYNCH CHECK Synchronization check Synced working time Synch. fail time Max voltage diff.	SYNCH CHECK Synchronization check DISBL	GPRS MODULE Synchronization check Synced working time Synch. fail time Max voltage diff.
		SYNCH CHECK Voltage type Max frequency diff. Max angle difference Angle offset	SYNCH CHECK Voltage type 0	SYNCH CHECK Voltage type Max frequency diff. Max angle difference Angle offset
TECHNICIAN SETTING Expansion modules User adjustment	EXPANSION MODULES GPRS	GPRS MODULE Disable/enable select Call back selection GPS	GPRS MODULE Disable/enable select 1=GPRS SERVER	GPRS MODULE Disable/enable select Call back selection GPS
TECHNICIAN SETTING Expansion modules User adjustment	USER ADJUSTMENT Mains voltage offset Gen. voltage offset Current offset Battery&chrg. gen. vol	MAINS VOLTAGE OFFSET Mains V1 offset Mains V2 offset Mains V3 offset	MAINS VOLTAGE OFFSET Mains V1 offset 0 Vac	MAINS VOLTAGE OFFSET Mains V1 offset Mains V2 offset Mains V3 offset
	USER ADJUSTMENT Mains voltage offset Gen. voltage offset Current offset Battery&chrg. gen. vol	GEN. VOLTAGE OFFSET Gen. V1 offset Gen. V2 offset Gen. V3 offset	GEN. VOLTAGE OFFSET Gen. V1 offset 0 Vac	GEN. VOLTAGE OFFSET Gen. V1 offset Gen. V2 offset Gen. V3 offset
	USER ADJUSTMENT Mains voltage offset Gen. voltage offset Current offset Battery&chrg. gen. vol	CURRENT OFFSET Current I1 offset Current I2 offset Current I3 offset	CURRENT OFFSET Current I1 offset 0 A	CURRENT OFFSET Current I1 offset Current I2 offset Current I3 offset
	USER ADJUSTMENT Mains voltage offset Gen. voltage offset Current offset Battery&chrg. gen. vol	BATTERY&CHRG GEN. VOL Batt.volt offset Gen.chg.volt offset	BATTERY&CHRG GEN. VOL Batt.volt offset 0.0 Vdc	BATTERY&CHRG GEN. VOL Batt.volt offset Gen.chg.volt offset
	USER ADJUSTMENT Sender inputs offset	SENDER INPUTS OFFSET Oil pressure offset Temperature offset Conf. All offset	SENDER INPUTS OFFSET Oil pressure offset 0.0 Bar	SENDER INPUTS OFFSET Oil pressure offset Temperature offset Conf. All offset

### 3.4 Changing And Saving Parameters Values

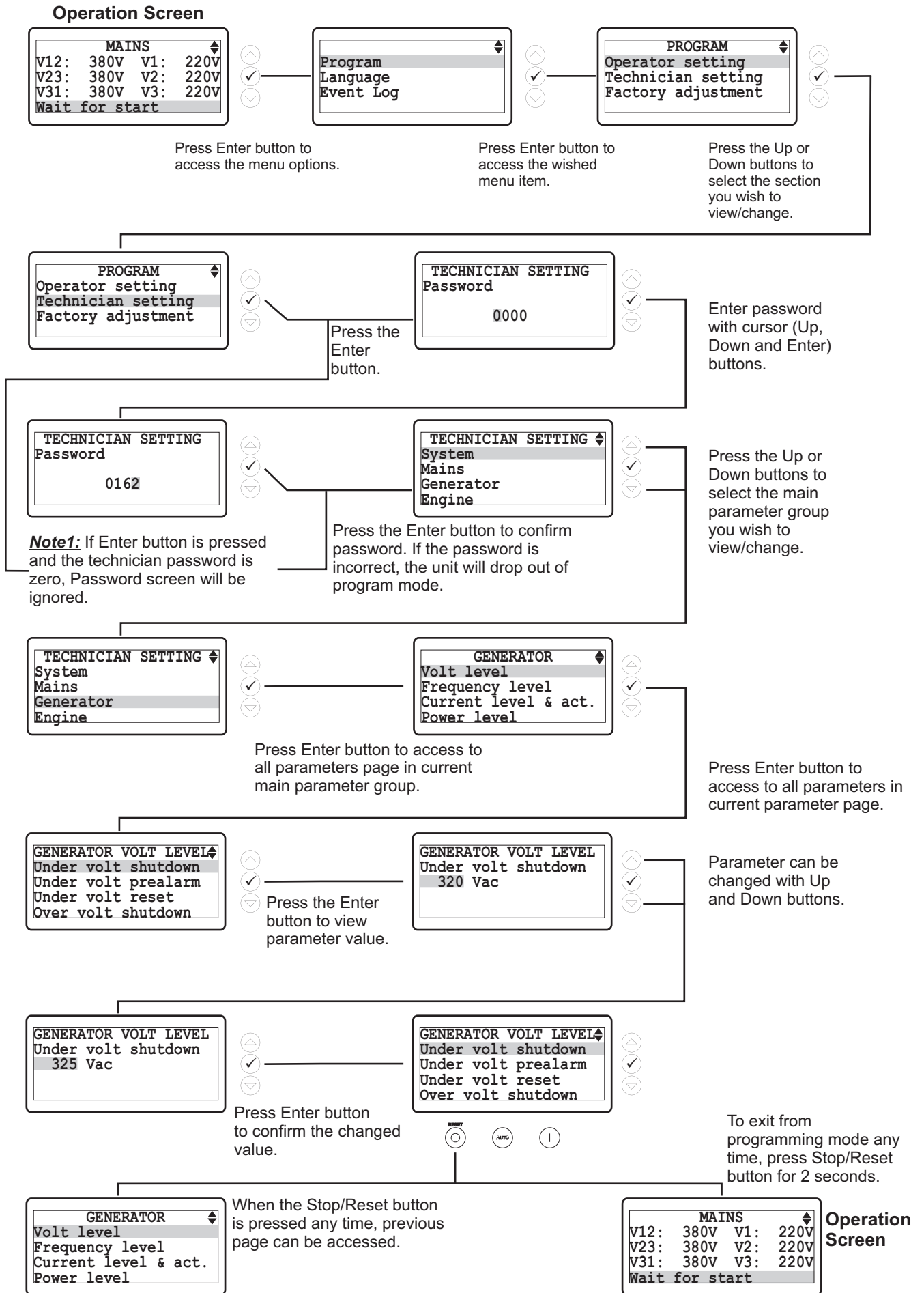

## 4. Parameters

### 4.1 Operator Parameters

#### 4.1.1 Mains

<b>MAINS VOLT LEVEL (<i>Mains-&gt;Volt level</i>)</b>		<b>Min</b>	<b>Max</b>	<b>Default</b>	<b>Unit</b>
<b>Under volt trip</b>	Mains Under Voltage	60	600	320	V $\sim$
<b>Under volt reset</b>	Mains Under Voltage Reset	60	600	340	V $\sim$
<b>Over volt trip</b>	Mains Over Voltage	60	600	440	V $\sim$
<b>Over volt reset</b>	Mains Over Voltage Reset	60	600	420	V $\sim$

<b>MAINS FREQ. LEVEL (<i>Mains-&gt;Frequency level</i>)</b>		<b>Min</b>	<b>Max</b>	<b>Default</b>	<b>Unit</b>
<b>Under freq trip</b>	Mains Under Frequency	20.0	75.0	45.0	Hz
<b>Under freq reset</b>	Mains Under Frequency Reset	20.0	75.0	48.0	Hz
<b>Over freq trip</b>	Mains Over Frequency	20.0	75.0	55.0	Hz
<b>Over freq reset</b>	Mains Over Frequency Reset	20.0	75.0	52.0	Hz

#### 4.1.2 Generator

<b>GENERATOR VOLT LEVEL (<i>Generator-&gt;Volt level</i>)</b>		<b>Min</b>	<b>Max</b>	<b>Default</b>	<b>Unit</b>
<b>Under volt shutdown</b>	Generator Under Voltage Shutdown	60(dis)	600	320	V $\sim$
<b>Under volt prealarm</b>	Generator Under Voltage Pre-Alarm	60(dis)	600	dis	V $\sim$
<b>Under volt reset</b>	Generator Under Voltage Pre-Alarm Reset	60	600	350	V $\sim$
<b>Over volt shutdown</b>	Generator Over Voltage Shutdown	60	600	440	V $\sim$
<b>Over volt prealarm</b>	Generator Over Voltage Pre-Alarm	60(dis)	600	dis	V $\sim$
<b>Over volt reset</b>	Generator Over Voltage Pre-Alarm Reset	60	600	400	V $\sim$
<b>Shutdown delay time</b>	Generator Voltage Shutdown Delay Time	0.0	10.0	1.0	Sec

<b>GENERATOR FREQ LEVEL (<i>Generator-&gt;Frequency level</i>)</b>		<b>Min</b>	<b>Max</b>	<b>Default</b>	<b>Unit</b>
<b>Nominal frequency</b>	Nominal Alternator Frequency	30.0	75.0	50.0	Hz
<b>Under freq shutdown</b>	Generator Under Frequency Shutdown	30.0(dis)	75.0	43.0	Hz
<b>Under freq prealarm</b>	Generator Under Frequency Pre-Alarm	30.0(dis)	75.0	dis	Hz
<b>Under freq reset</b>	Generator Under Frequency Pre-Alarm Reset	30.0	75.0	46.0	Hz
<b>Over freq shutdown</b>	Generator Over Frequency Shutdown	30.0(dis)	75.0	58.0	Hz
<b>Over freq prealarm</b>	Generator Over Frequency Pre-Alarm	30.0(dis)	75.0	dis	Hz
<b>Over freq reset</b>	Generator Over Frequency Pre-Alarm Reset	30.0	75.0	54.0	Hz
<b>Shutdown delay time</b>	Generator Frequency Shutdown Delay Time	0.0	10.0	1.0	Sec

<b>GENERATOR CUR LEVEL (<i>Generator-&gt;Current level</i>)</b>		<b>Min</b>	<b>Max</b>	<b>Default</b>	<b>Unit</b>
<b>Under cur. set</b>	Generator Under Current Set	0	9999	1	A $\sim$
<b>Under cur. prealarm</b>	Generator Under Current Pre-Alarm	0(dis)	9999	dis	A $\sim$
<b>Under cur. reset</b>	Generator Under Current Pre-Alarm Reset	0	9999	5	A $\sim$
<b>Over cur. IDMT alarm</b>	Generator Over Current IDMT Alarm	ENABL/DISBL		DISBL	
<b>Over cur. set</b>	Generator Over Current Set	0	9999	9999	A $\sim$
<b>Over cur. prealarm</b>	Generator Over Current Pre-Alarm	0(dis)	9999	dis	A $\sim$
<b>Over cur. reset</b>	Generator Over Current Pre-Alarm Reset	0	9999	9980	A $\sim$

**Note:** dis = disable

<b>GEN POWER LEVEL (Generator-&gt;Power level)</b>		<b>Min</b>	<b>Max</b>	<b>Default</b>	<b>Unit</b>
<b>Under power set</b>	Generator Under Power Set	0	9999	0	kVA
<b>Under power prealarm</b>	Generator Under Power Pre-Alarm	0(dis)	9999	dis	kVA
<b>Under power reset</b>	Generator Under Power Pre-Alarm Reset	0	9999	5	kVA
<b>Over power set</b>	Generator Over Power Set	0	9999	0	kVA
<b>Over power prealarm</b>	Generator Over Power Pre-Alarm	0(dis)	9999	dis	kVA
<b>Over power reset</b>	Generator Over Power Pre-Alarm Reset	0	9999	0	kVA
<b>Reverse power set</b>	Reverse Power Set	-9999	0	0	kW

<b>GEN WORKING CALENDAR (Generator-&gt;Working calendar)</b>		<b>Min</b>	<b>Max</b>	<b>Default</b>	<b>Unit</b>
<b>Disable/enable select</b>	Working Calendar Disable or Enable	DISBL/ENABL		DISBL	
<b>Start time on monday</b>	Working Calendar Work Start Time on Monday	0.00	23.59	0.00	H.Min
<b>Stop time on monday</b>	Working Calendar Work Stop Time on Monday	0.00	23.59	23.59	H.Min
<b>Start time on tues.</b>	Working Calendar Work Start Time on Tuesday	0.00	23.59	0.00	H.Min
<b>Stop time on tuesday</b>	Working Calendar Work Stop Time on Tuesday	0.00	23.59	23.59	H.Min
<b>Start time on wednes.</b>	Working Calendar Work Start Time on Wednesday	0.00	23.59	0.00	H.Min
<b>Stop time on wednes.</b>	Working Calendar Work Stop Time on Wednesday	0.00	23.59	23.59	H.Min
<b>Start time on thurs.</b>	Working Calendar Work Start Time on Thursday	0.00	23.59	0.00	H.Min
<b>Stop time on thursday</b>	Working Calendar Work Stop Time on Thursday	0.00	23.59	23.59	H.Min
<b>Start time on friday</b>	Working Calendar Work Start Time on Friday	0.00	23.59	0.00	H.Min
<b>Stop time on friday</b>	Working Calendar Work Stop Time on Friday	0.00	23.59	23.59	H.Min
<b>Start time on satur.</b>	Working Calendar Work Start Time on Saturday	0.00	23.59	0.00	H.Min
<b>Stop time on saturday</b>	Working Calendar Work Stop Time on Saturday	0.00	23.59	23.59	H.Min
<b>Start time on sunday</b>	Working Calendar Work Start Time on Sunday	0.00	23.59	0.00	H.Min
<b>Stop time on sunday</b>	Working Calendar Work Stop Time on Sunday	0.00	23.59	23.59	H.Min

Please enter the days of the weekly workdays for Working Function. Example:

**Disable/enable select**

DISBL The working calendar is disable  
ENABL The working calendar is enable

**Start time on monday**

08.30 The working function is every Monday started at 08.30 o'clock  
(if it is enabled)

**Stop time on monday**

17.30 The working function is every Monday stopped at 17.30 o'clock  
(if it is enabled)

**Start time on tues.**

08.30 The working function is every Tuesday started at 08.30 o'clock  
(if it is enabled)

**Stop time on tuesday**

17.30 The working function is every Tuesday stopped at 17.30 o'clock  
(if it is enabled)

**Start time on wednes.**

08.30 The working function is every Wednesday started at 08.30 o'clock  
(if it is enabled)

**Stop time on wednes.**

17.30 The working function is every Wednesday stopped at 17.30 o'clock  
(if it is enabled)

**Start time on thurs.**

08.30 The working function is every Thursday started at 08.30 o'clock  
(if it is enabled)

**Stop time on thursday**

17.30 The working function is every Thursday stopped at 17.30 o'clock  
(if it is enabled)

**Start time on friday**

08.30 The working function is every Friday started at 08.30 o'clock  
(if it is enabled)

**Stop time on friday**

17.30 The working function is every Friday stopped at 17.30 o'clock  
(if it is enabled)

**Start time on satur.**

08.30 The working function is every Saturday started at 08.30 o'clock  
(if it is enabled)

**Stop time on saturday**

17.30 The working function is every Saturday stopped at 17.30 o'clock  
(if it is enabled)

**Start time on sunday**

08.30 The working function is every Sunday started at 08.30 o'clock  
(if it is enabled)

**Stop time on sunday**

17.30 The working function is every Sunday stopped at 17.30 o'clock  
(if it is enabled)

## 4.2 Technician Parameters

### 4.2.1 System

SYSTEM NETWORK ( <i>System-&gt;Network</i> )		Min	Max	Default	Unit
<b>CT ratio</b>	Current Transformer Ratio	1	9999	20	
<b>PT ratio</b>	Voltage Transformer Ratio	1	100	1	
<b>Type of AC system</b>	Select AC system; 0- 1 Phase 2 Wire 1- 3 Phase 4 Wire 2- 2 Phase 3 Wire L1-L2 3- 2 Phase 3 Wire L1-L3	0	3	1	
<b>Phase sequence</b>	Generator Phase Sequence (dis, L123 or L321)	DISBL, L123, L321		DISBL	
<b>Generator kVA rating</b>	Generator kVA rating set	0	9999	150	kVA
<b>Power unit</b>	Power unit	kVA/kW		kVA	
<b>kVA,kW,kVAr point</b>	kVA, kW, kVAr point position; 0-> 0 1-> 0.0 2-> 0.00 3-> 0.000	0	3	0	
<b>CT location</b>	Current Transformer Location; 0-> Generator 1-> Load	0	1	0	

#### CT ratio

Load current transformers transfer ratio(Primary current/Secondary current) value must be entered to this parameter.

Example:

If Current Transformer Primary=500A and Current Transformer Secondary=5A, Current Transformer Ratio should be entered CT Primary/CT Secondary=100.

#### PT ratio

Defines the scaling factor applied to voltage readout and associated fault conditions.

This PT ratio is for additional voltage transformers mounted the unit.

#### CT location

**Generator:** The CTs are located to the generator side, so will show only generator load.

**Load:** The CTs are located to the load side, so will show generator or mains load provided by supply.

BREAKERS ( <i>System-&gt;Breakers</i> )		Min	Max	Default	Unit
<b>Type of Breaker</b>	Hardware Breaker Selection	0	2	0	
<b>Gen.brk.cls.contact</b>	Gen Close Breaker Contact Type	NO / NC		0	
<b>Gen.brk.cls.relay</b>	Gen Close Breaker Relay Type	NOR / PULS		0	
<b>Gen.brk.cls.time</b>	Gen Close Timer	1	250	5	Sec
<b>Gen.brk.open relay</b>	Gen Open Breaker Relay Type	NOR / PULS		0	
<b>Gen.brk.open time</b>	Gen Open Timer	1	250	5	Sec
<b>Mains.brk.cls.contact</b>	Mains Close Breaker Contact Type	NO / NC		0	
<b>Mains.brk.cls.relay</b>	Mains Close Breaker Relay Type	NOR / PULS		0	
<b>Mains.brk.cls.time</b>	Mains Close Timer	1	250	5	Sec
<b>Mains.brk.open relay</b>	Mains Open Breaker Relay Type	NOR / PULS		0	
<b>Mains.brk.open time</b>	Mains Open Timer	1	250	5	Sec
<b>Break.close puls.time</b>	Breaker Close Pulse Time	0.0	10.0	0.5	Sec
<b>Break.open pulse time</b>	Breaker Open Pulse Time	0.0	10.0	0.5	Sec
<b>Transfer time</b>	Transfer Time	0	250	2	Sec
<b>Spring loading time</b>	Spring Loading Time	1	250	3	Sec
<b>Retry number</b>	Retry Number	1	250	5	

#### Hardware Breaker Selection

**0- Breakers:** Mains and Gen breakers have only close drives and if close drive off breaker will open. Parameters; GEN CLOSE BREAKER CONTACT TYPE, GEN CLOSE TIMER(if gen closed input selected), GEN OPEN TIMER(if gen closed input selected), MAIN CLOSE BREAKER CONTACT TYPE, MAINS CLOSE TIMER(if mains closed input selected), MAINS OPEN TIMER(if mains closed input selected), TRANSFER TIME.

**Note-1 :** NO / NC : Normally Open / Normally Close

2 : NOR / PULS : Normal / Pulse

**Example:** If Hardware Breaker Selection parameter is selected as 0;

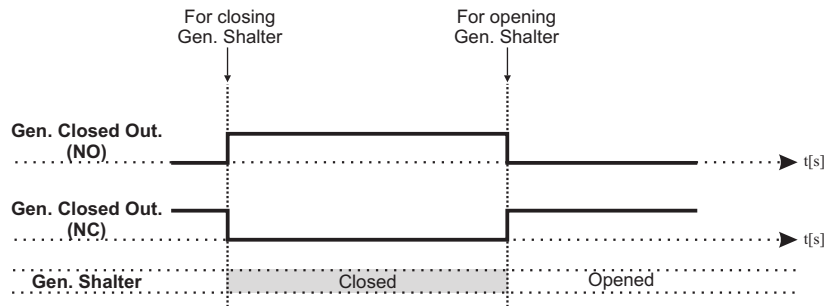

**1- User Configured:** Mains and Gen breakers have only close drives, when want to breaker close, close breaker output on and after 1 sec. open breaker output on and after breaker close pulse time open breaker output will off. When want to breaker open close breaker output and open breaker output will off.

Parameters; GEN CLOSE BREAKER CONTACT TYPE, GEN CLOSE TIMER(if gen closed input selected), GEN OPEN TIMER(if gen closed input selected), MAIN CLOSE BREAKER CONTACT TYPE, MAINS CLOSE TIMER(if mains closed input selected), MAINS OPEN TIMER(if mains closed input selected),BREAKER CLOSE PULSE TIME, TRANSFER TIME.

**Example:** If Hardware Breaker Selection parameter is selected as 1;

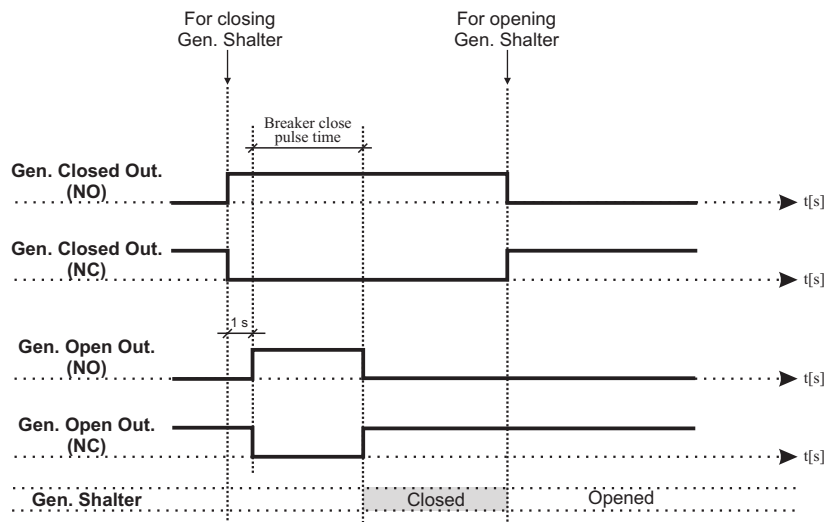

**2- Motorised Breakers:** User can select all the breaker types.

Parameters; GEN CLOSE BREAKER CONTACT TYPE, GEN CLOSE BREAKER RELAY TYPE, GEN CLOSE TIMER(if gen closed input selected), GEN OPEN BREAKER RELAY TYPE, GEN OPEN TIMER(if gen closed input selected), MAIN CLOSE BREAKER CONTACT TYPE, MAIN CLOSE BREAKER RELAY TYPE, MAINS CLOSE TIMER(if mains closed input selected), MAIN OPEN BREAKER RELAY TYPE, MAINS OPEN TIMER(if mains closed input selected), BREAKER CLOSE PULSE TIME(if Gen Close Breaker Relay Type or Main Close Breaker Relay Type parameter is selected as 1), BREAKER OPEN PULSE TIME(if Gen Open Breaker Relay Type or Main Open Breaker Relay Type parameter is selected as 1), TRANSFER TIME, SPRING LOADING TIME, RETRY NUMBER.

**Example-1: GCB Close Diagram.**

If Hardware Breaker Selection parameter is selected as 2 (user configured), Gen. Close Breaker Relay Type parameter is selected as 1 (PULSE) and Gen. Open Breaker Relay Type parameter is selected as 1 (PULSE);

**GbCt:** Gen close timer

**brCP:** Breaker close pulse time

**brOP:** Breaker open pulse time

**sPLD:** Spring loading time

**rtNB:** Retry number



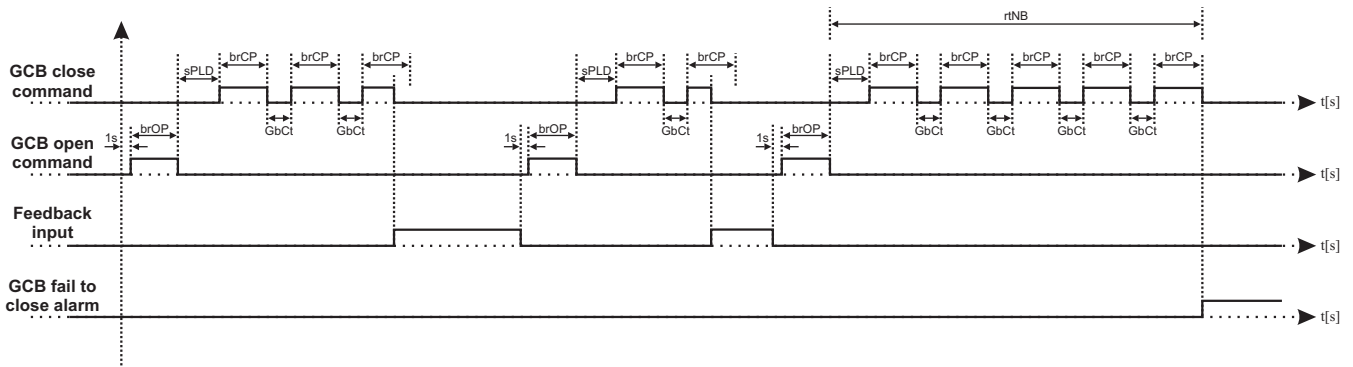

### Example-2: GCB Open Diagram.

If Hardware Breaker Selection parameter is selected as 2 (user configured), Gen. Close Breaker Relay Type parameter is selected as 1 (PULSE) and Gen. Open Breaker Relay Type parameter is selected as 1 (PULSE);

**GbOt:** Gen open timer

**brOP:** Breaker open pulse time

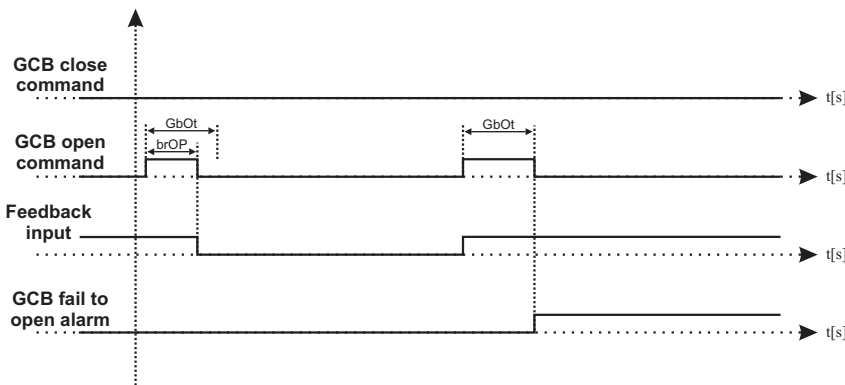

### Gen Close Timer

This is used to monitor the closure of the generator contactor or breaker. It will only operate if an auxiliary input is configured as 'Generator Closed Auxiliary' and connected to the auxiliary on the generator contactor or breaker. Once a generator closed signal is issued the 'gen close timer' is initiated. Should the 'Generator Closed Auxiliary' input become active the timer the 'gen close timer' is cancelled. If the timer expires and the 'Generator Closed Auxiliary' has not become active the module will issue a 'generator failed to close' alarm.

### Gen Open Timer

This is used to monitor the opening of the generator contactor or breaker. It will only operate if an auxiliary input is configured as 'Generator Closed Auxiliary' and connected to the auxiliary on the generator contactor or breaker. Once a generator open signal is issued the 'gen open timer' is initiated. Should the 'Generator Closed Auxiliary' input become in-active the timer 'gen open timer' is cancelled. If the timer expires and the 'Generator Closed Auxiliary' has not become in-active the module will issue a 'generator failed to open' alarm.

### Mains Close Timer

This is used to monitor the closure of the mains contactor or breaker. It will only operate if an auxiliary input is configured as 'Mains Closed Auxiliary' and connected to the auxiliary on the mains contactor or breaker. Once a mains closed signal is issued the 'mains close timer' is initiated. Should the 'Mains Closed Auxiliary' input become active the timer the 'mains close timer' is cancelled. If the timer expires and the 'Mains Closed Auxiliary' has not become active the module will issue a 'mains failed to close' alarm.

### Mains Open Timer

This is used to monitor the opening of the mains contactor or breaker. It will only operate if an auxiliary input is configured as 'Mains Closed Auxiliary' and connected to the auxiliary on the mains contactor or breaker. Once a mains open signal is issued the 'mains open timer' is initiated. Should the 'Mains Closed Auxiliary' input become in-active the timer the 'mains open timer' is cancelled. If the timer expires and the 'Mains closed auxiliary' has not become in-active the module will issue a 'mains failed to open' alarm.

### Breaker Close Pulse Time

This is used to determine the duration of the Mains and Generator close signals. This timer is only used if Pulsed outputs are configured to be used.

### Breaker Open Pulse Time

This is used to determine the duration of the Mains and Generator close signals. This timer is only used if Pulsed outputs are configured to be used.

### Transfer Time

This is used to allow for fixed duration transfer breaks when switching from mains to generator and back. It can be used to ensure that the supply is removed from the load for fixed period of time to allow pumps/motors to come to rest etc.

### Spring Loading Time

When the unit give open command to the (GCB or MCB) breaker and after that the unit want to give close command the same breaker, this time for between open and close commands, because if there is no delay between open and close commands can be problem the motorized switches.

### Retry Number

The unit try to close (GCB or MCB) breaker number of this parameter. If each try there is no close feedback, after last try the alarm will be activated.

<b>LCD DISPLAY (System-&gt;LCD display)</b>		<b>Min</b>	<b>Max</b>	<b>Default</b>	<b>Unit</b>
<b>Language</b>	Language Selection	ENGLISH/CHINESE		ENGLISH	
<b>Contrast</b>	Contrast Setting	4	9	5	
<b>Auto backlight off</b>	Auto Backlight Off	ENABL/DISBL		DISBL	
<b>Auto scroll time</b>	Auto Scroll Time	0 (dis)	250	0	Sec
<b>Auto scroll number*<sup>8</sup></b>	Auto Scroll Number	1	20	5	
<b>Err. mesg scroll time</b>	Scroll Time For Error Messages	1	250	2	Sec

### Language Selection

Language selection: English or Chinese.

### Digital Contrast

It is used to change contrast of LCD Display.

### Auto Backlight Off

ENABL: If any button is not pressed during 120 secs, LCD backlight is automatically changed power safety mode.

DISBL: LCD backlight is on continuously.

### Auto Scroll Time

The scroll time between all data display pages.

### Auto Scroll Number

The number of data display pages that will be scrolled.

### Scroll Time For Error Messages

Error messages are displayed the last line of LCD Display. If more than one error condition is present, each of them is displayed during time defined by Auto Scroll Timer parameter.

**Note:** \*<sup>8</sup> = Max. value of this parameter is equal to 26 at Trans-MidiAMF.CAN devices



<b>COMMUNICATION (System-&gt;Communication)</b>		<b>Min</b>	<b>Max</b>	<b>Default</b>	<b>Unit</b>
<b>Slave address</b>	Slave Address	1	247	1	
<b>Baud rate</b>	Baud Rate: 0 - 1200 baud 1 - 2400 baud 2 - 4800 baud 3 - 9600 baud 4 - 19200 baud 5 - 38400 baud	0	5	3	
<b>Parity</b>	Parity: 0 - NONE 1 - ODD 2 - EVEN	0	2	0	
<b>Stop bit</b>	Stop Bit (0-> 1 stop bit,1-> 2 stop bit)	0	1	0	
<b>Datalog period</b>	Datalog Period	0.0(dis)	999.9	1.0	Min
<b>Timeout</b>	Timeout	0(dis)	999	3	Min
<b>Local/Remote select.</b>	Local/Remote selection	LOCAL/REMOTE	0-LOCAL		

#### Timeout

This parameter is used for the modem hardware reset.

If the data communication is interrupted and this situation continues as this parameter, the modem hardware reset is performed.

#### Local/Remote selection

When this parameter selected as "0-LOCAL", device works as usual gen-set controller.

When this parameter selected as "1-REMOTE", device can be used for remote monitoring and remote controlling another TRANS-midiAMF.

If this parameter selected as "1-REMOTE"; during startup of the device, "REMOTE" message will be indicated.

<b>DATE &amp; TIME SET (System-&gt;Date &amp; time set)</b>		<b>Min</b>	<b>Max</b>	<b>Default</b>	<b>Unit</b>
<b>Year</b>	Year	0	99		
<b>Month</b>	Month	1	12		
<b>Day</b>	Date	1	31		
<b>Week</b>	Day of week	1	7		
<b>Hour</b>	Hour	0	23		
<b>Minute</b>	Minute	0	59		
<b>Second</b>	Second	0	59		

**Day of week** 1=Monday,2=Tuesday,3=Wednesday,4=Thursday,5=Friday,6=Saturday,7=Sunday

<b>DEFAULT SETTINGS (System-&gt;Default settings)</b>		<b>Min</b>	<b>Max</b>	<b>Default</b>	<b>Unit</b>
<b>Save setting to def.</b>	Save setting to default	YES / NO		NO	
<b>Reset default sets</b>	Reset default sets	YES / NO		NO	
<b>Reset factory sets</b>	Reset factory sets	YES / NO		NO	

#### Save setting to default

If this parameter is selected as "Yes", the unit's currently parameters save as default sets.

After this parameter is reset automatically to "No".

#### Reset default sets

If this parameter is selected as "Yes", the unit's parameters back to default sets.

After this parameter is reset automatically to "No".

#### Reset factory sets

If this parameter is selected as "Yes", the unit's parameters back to factory sets.

After this parameter is reset automatically to "No".

**Note:** dis = disable

<b>PASSWORD SETTINGS (System-&gt;Password settings)</b>		<b>Min</b>	<b>Max</b>	<b>Default</b>	<b>Unit</b>
<b>Operator password</b>	Operator Password	0	9999	0	
<b>Technician password</b>	Technician Password	0	9999	0	

#### Operator Password

Use this option to change the Operator password. This password allows access to operator parameters section.

#### Technician Password

Use this option to change the Technician password. It allows access to both operator and technician parameters section.

### 4.2.2 Mains

<b>MAINS VOLT LEVEL (Mains-&gt;Volt level)</b>		<b>Min</b>	<b>Max</b>	<b>Default</b>	<b>Unit</b>
<b>Under volt trip</b>	Mains Under Voltage	60	600	320	V $\sim$
<b>Under volt reset</b>	Mains Under Voltage Reset	60	600	340	V $\sim$
<b>Over volt trip</b>	Mains Over Voltage	60	600	440	V $\sim$
<b>Over volt reset</b>	Mains Over Voltage Reset	60	600	420	V $\sim$

<b>MAINS FREQ. LEVEL (Mains-&gt;Frequency level)</b>		<b>Min</b>	<b>Max</b>	<b>Default</b>	<b>Unit</b>
<b>Under freq trip</b>	Mains Under Frequency	20.0	75.0	45.0	Hz
<b>Under freq reset</b>	Mains Under Frequency Reset	20.0	75.0	48.0	Hz
<b>Over freq trip</b>	Mains Over Frequency	20.0	75.0	55.0	Hz
<b>Over freq reset</b>	Mains Over Frequency Reset	20.0	75.0	52.0	Hz

<b>MAINS ACTIONS (Mains-&gt;Actions)</b>		<b>Min</b>	<b>Max</b>	<b>Default</b>	<b>Unit</b>
<b>Mains failure detect</b>	Mains Failure Detection En/Dis	ENABL/DISBL		ENABL	
<b>Mains fail.stop mode</b>	Look Mains Failure at Stop Mode En/Dis	ENABL/DISBL		ENABL	
<b>Always return delay</b>	Always Look Mains Return Delay	ENABL/DISBL		DISBL	

#### Mains Failure Detection En/Dis

ENABLE: The module will monitor the mains supply. If the mains supply go out side of limits, the module will initiate its automatic mains failure sequence.

#### Look Mains Failure at Stop Mode En/Dis

ENABLE: As soon as the module detects a mains failure the mains contactor or breaker relay will be opened to remove the supply from the load. This is to prevent damage to the load in case of single-phase failure.

DISABLE: In the event of a mains failure the unit will attempt to maintain the supply to the load for the incoming AC mains supply until the generator is available to go on load. In the event of a generator failure the module will default back to the incoming AC mains supply.

#### Always Look Mains Return Delay

ENABLE: The module will always wait the Mains Return Delay parameter before transferring the load back to mains.

DISABLE: The module will wait the Mains Return Delay parameter while only the engine is running and the generator is available to go on load before transferring the load back to mains.

### 4.2.3 Generator

<b>GENERATOR VOLT LEVEL (Generator-&gt;Volt level)</b>		<b>Min</b>	<b>Max</b>	<b>Default</b>	<b>Unit</b>
<b>Under volt shutdown</b>	Generator Under Voltage Shutdown	60(dis)	600	320	V $\sim$
<b>Under volt prealarm</b>	Generator Under Voltage Pre-Alarm	60(dis)	600	dis	V $\sim$
<b>Under volt reset</b>	Generator Under Voltage Pre-Alarm Reset	60	600	350	V $\sim$
<b>Over volt shutdown</b>	Generator Over Voltage Shutdown	60	600	440	V $\sim$
<b>Over volt prealarm</b>	Generator Over Voltage Pre-Alarm	60(dis)	600	dis	V $\sim$
<b>Over volt reset</b>	Generator Over Voltage Pre-Alarm Reset	60	600	400	V $\sim$
<b>Shutdown delay time</b>	Generator Voltage Shutdown Delay Time	0.0	10.0	1.0	Sec

<b>GENERATOR FREQ LEVEL (<i>Generator-&gt;Frequency level</i>)</b>		<b>Min</b>	<b>Max</b>	<b>Default</b>	<b>Unit</b>
<b>Nominal frequency</b>	Nominal Alternator Frequency	30.0	75.0	50.0	Hz
<b>Under freq shutdown</b>	Generator Under Frequency Shutdown	30.0(dis)	75.0	43.0	Hz
<b>Under freq prealarm</b>	Generator Under Frequency Pre-Alarm	30.0(dis)	75.0	dis	Hz
<b>Under freq reset</b>	Generator Under Frequency Pre-Alarm Reset	30.0	75.0	46.0	Hz
<b>Over freq shutdown</b>	Generator Over Frequency Shutdown	30.0(dis)	75.0	58.0	Hz
<b>Over freq prealarm</b>	Generator Over Frequency Pre-Alarm	30.0(dis)	75.0	dis	Hz
<b>Over freq reset</b>	Generator Over Frequency Pre-Alarm Reset	30.0	75.0	54.0	Hz
<b>Shutdown delay time</b>	Generator Frequency Shutdown Delay Time	0.0	10.0	1.0	Sec

<b>GEN CUR LEVEL &amp; ACT (<i>Generator-&gt;Current level &amp; act.</i>)</b>		<b>Min</b>	<b>Max</b>	<b>Default</b>	<b>Unit</b>
<b>Under cur. set</b>	Generator Under Current Set	0	9999	1	A~
<b>Under cur. prealarm</b>	Generator Under Current Pre-Alarm	0(dis)	9999	dis	A~
<b>Under cur. reset</b>	Generator Under Current Pre-Alarm Reset	0	9999	5	A~
<b>Under cur. act.</b>	Generator Under Current Actions 0 - Disable 1 - Warning (Alarm Only, No Shutdown) 2 - Electrical Trip (Alarm/Off Load Generator Followed By Shutdown After Cooling) 3 - Shutdown (Alarm And Shutdown)	0(dis)	3	dis	
<b>Under act. delay time</b>	Generator Under Current Actions Delay Time	0	9999	2	Sec
<b>Over cur. IDMT alarm</b>	Generator Over Current IDMT Alarm	ENABL/DISBL		DISBL	
<b>Over cur. set</b>	Generator Over Current Set	0	9999	9999	A~
<b>Over cur. prealarm</b>	Generator Over Current Pre-Alarm	0(dis)	9999	dis	A~
<b>Over cur. reset</b>	Generator Over Current Pre-Alarm Reset	0	9999	9980	A~
<b>Over cur. act.</b>	Generator Over Current Actions 0 - Disable 1 - Warning (Alarm Only, No Shutdown) 2 - Electrical Trip (Alarm/Off Load Generator Followed By Shutdown After Cooling) 3 - Shutdown (Alarm And Shutdown)	0(dis)	3	dis	
<b>Over act. delay time</b>	Generator Over Current Actions Delay Time	0	99	2	Sec
<b>Short circuit cur.</b>	Generator Short Circuit Current Set	0	9999	9999	A~
<b>Unbalance load set</b>	Unbalance Load Set	0	9999	0	A~
<b>Unbalance load act.</b>	Unbalance Load Actions 0 - Disable 1 - Warning (Alarm Only, No Shutdown) 2 - Electrical Trip (Alarm/Off Load Generator Followed By Shutdown After Cooling) 3 - Shutdown (Alarm And Shutdown)	0(dis)	3	dis	
<b>Unbalance act. delay</b>	Unbalance Load Actions Delay Time	0	99	2	Sec

#### **Over cur. IDMT alarm**

DISABLE: If the measurement value of current more than “Over cur. set” parameter and this condition is go on more than “Over act. delay time” parameter, the unit will give a “Over current” alarm.

ENABLE: If the measurement value of current more than “Over cur. set” parameter and this condition is go on more than “**Tripping time**”, the unit will give a “Over current” alarm.

$$\text{Tripping time} = \frac{(\text{“Over act. delay time” parameter}) \times (\text{“Over cur. set” parameter})}{(\text{Measured current}) - (\text{“Over cur. set” parameter})}$$

<b>GEN POWER LEVEL (Generator-&gt;Power level)</b>		<b>Min</b>	<b>Max</b>	<b>Default</b>	<b>Unit</b>
<b>Under power set</b>	Generator Under Power Set	0	9999	0	kVA
<b>Under power prealarm</b>	Generator Under Power Pre-Alarm	0(dis)	9999	dis	kVA
<b>Under power reset</b>	Generator Under Power Pre-Alarm Reset	0	9999	5	kVA
<b>Under power act.</b>	Generator Under Power Actions 0 - Disable 1 - Warning (Alarm Only, No Shutdown) 2 - Electrical Trip (Alarm/Off Load Generator Followed By Shutdown After Cooling) 3 - Shutdown (Alarm And Shutdown)	0(dis)	3	0(dis)	
<b>Under act. delay time</b>	Generator Under Power Action Delay Time	0	9999	2	Sec
<b>Over power set</b>	Generator Over Power Set	0	9999	0	kVA
<b>Over power prealarm</b>	Generator Over Power Pre-Alarm	0(dis)	9999	dis	kVA
<b>Over power reset</b>	Generator Over Power Pre-Alarm Reset	0	9999	0	kVA
<b>Over power act.</b>	Generator Over Power Actions 0 - Disable 1 - Warning (Alarm Only, No Shutdown) 2 - Electrical Trip (Alarm/Off Load Generator Followed By Shutdown After Cooling) 3 - Shutdown (Alarm And Shutdown)	0(dis)	3	0(dis)	
<b>Over act. delay time</b>	Generator Over Power Action Delay Time	0	99	2	Sec
<b>Reverse power set</b>	Reverse Power Set	-9999	0	0	kW
<b>Reverse power act.</b>	Reverse Power Actions 0 - Disable 1 - Warning (Alarm Only, No Shutdown) 2 - Electrical Trip (Alarm/Off Load Generator Followed By Shutdown After Cooling) 3 - Shutdown (Alarm And Shutdown)	0(dis)	3	0(dis)	
<b>Rv.pow.act.delay time</b>	Reverse Power Action Delay Time	0	99	2	Sec

<b>GEN WORKING CALENDAR (Generator-&gt;Working calendar)</b>		<b>Min</b>	<b>Max</b>	<b>Default</b>	<b>Unit</b>
<b>Disable/enable select</b>	Working Calendar Disable or Enable	DISBL/ENABL		DISBL	
<b>Start time on monday</b>	Working Calendar Work Start Time on Monday	0.00	23.59	0.00	H.Min
<b>Stop time on monday</b>	Working Calendar Work Stop Time on Monday	0.00	23.59	23.59	H.Min
<b>Start time on tues.</b>	Working Calendar Work Start Time on Tuesday	0.00	23.59	0.00	H.Min
<b>Stop time on tuesday</b>	Working Calendar Work Stop Time on Tuesday	0.00	23.59	23.59	H.Min
<b>Start time on wednes.</b>	Working Calendar Work Start Time on Wednesday	0.00	23.59	0.00	H.Min
<b>Stop time on wednes.</b>	Working Calendar Work Stop Time on Wednesday	0.00	23.59	23.59	H.Min
<b>Start time on thurs.</b>	Working Calendar Work Start Time on Thursday	0.00	23.59	0.00	H.Min
<b>Stop time on thursday</b>	Working Calendar Work Stop Time on Thursday	0.00	23.59	23.59	H.Min
<b>Start time on friday</b>	Working Calendar Work Start Time on Friday	0.00	23.59	0.00	H.Min
<b>Stop time on friday</b>	Working Calendar Work Stop Time on Friday	0.00	23.59	23.59	H.Min
<b>Start time on satur.</b>	Working Calendar Work Start Time on Saturday	0.00	23.59	0.00	H.Min
<b>Stop time on saturday</b>	Working Calendar Work Stop Time on Saturday	0.00	23.59	23.59	H.Min
<b>Start time on sunday</b>	Working Calendar Work Start Time on Sunday	0.00	23.59	0.00	H.Min
<b>Stop time on sunday</b>	Working Calendar Work Stop Time on Sunday	0.00	23.59	23.59	H.Min

<b>GENERATOR GENERAL (<i>Generator-&gt;General</i>)</b>		<b>Min</b>	<b>Max</b>	<b>Default</b>	<b>Unit</b>
<b>Sens.option gen.freq</b>	Sensing Options Generator Frq En/Dis	ENABL/DISBL		ENABL	
<b>Sens.opt.pickup&amp;flywh*<sup>9</sup></b>	Sensing Opt Pickup En/Dis & Flywheel	0(dis)	1000	DISBL	
<b>All warning are latch</b>	All Warnings Are Latched En/Dis	ENABL/DISBL		DISBL	

#### **Sensing Options Generator Frq En/Dis**

ENABLE: Speed sensing will be derived from the generator output frequency.

DISABLE: Speed sensing not will be derived from the generator output frequency.

#### **Sensing Options Pickup En/Dis & Flywheel**

DISABLE: Speed sensing will not be derived from the magnetic pickup.

1-1000: Speed sensing will be derived from the magnetic pickup and the number is flywheel teeth on the engine.

#### **All Warnings Are Latched En/Dis**

ENABLE: Warnings and pre-alarms will latched when triggered. To reset the alarm either an external reset must be applied to one of the inputs or the 'Reset' pushbutton operated, once the triggering condition has cleared.

DISABLE: Normal operation, the warnings and pre-alarms (except spare inputs, because they have their latching or non-latching selections) will automatically reset once the triggering condition has cleared.

### **4.2.4 Engine**

<b>ENGINE START OPTIONS (<i>Engine-&gt;Starting options</i>)</b>		<b>Min</b>	<b>Max</b>	<b>Default</b>	<b>Unit</b>
<b>Horn prior start</b>	Audible Alarm Prior To Starting En/Dis	ENABL/DISBL		DISBL	
<b>No. of crank attemp</b>	Number Of Start Attempts	1	10	3	
<b>Cranking time</b>	Cranking Time	1	99	5	Sec
<b>Crank rest time</b>	Crank Rest Time	5	99	10	Sec
<b>Pickup fail dely*<sup>9</sup></b>	Pickup Sensor Fail Delay	0.1	10.0	3.0	Sec

#### **Audible Alarm Prior To Starting En/Dis**

ENABLE: The audible alarm will sound before the engine starts. The sounder will become active once the start delay is initialised, it will remain active until either the engine reaches crank disconnect speed or pre-heat timers are cancelled.

#### **Number Of Start Attempts**

This value is the number of times the module will attempt to start the generator. Should the generator start the module will not attempt further starts. If the generator does not start after the final attempt, the module will give a 'Fail to start' alarm.

#### **Cranking Time**

This is the maximum amount of time that the module will energise the starter motor for during starting attempts once the starter has engaged.

#### **Crank Rest Time**

This is the amount of time the module will wait for between start attempts. This is to allow the starter motor to cool and the starter batteries to recover.

**Note:** \*<sup>9</sup> = These parameters is only available at Trans-MidiAMF.MPU  
dis = disable



<b>ENG. CRANK DISCONNECT (<i>Engine-&gt;Crank disconnect</i>)</b>		<b>Min</b>	<b>Max</b>	<b>Default</b>	<b>Unit</b>
<b>Generator frequency</b>	Crank Disconnect On Gen. Frequency	10.0	75.0	30.0	Hz
<b>Engine speed</b>	Crank Disconnect On Engine RPM	100	6000	500	RPM
<b>Generator volt</b>	Crank Disconnect On Gen. Voltage	60 (dis)	600	300	V~
<b>Charge alt. volt</b>	Crank Disconnect On Charge Alt. Voltage	6.0 (dis)	30.0	dis	V---
<b>Oil pres. enab./dis.</b>	Crank Disconnect On Oil Pressure En/Dis	ENABL/DISBL		DISBL	
<b>Oil pressure value</b>	Oil Pressure Value	1.0	30.0	1.0	BAR
<b>Check oil befor.start</b>	Check Oil Pressure Before Start	ENABL/DISBL		ENABL	

The parameters in this page are used for engine started signals. If any of the selected signals appears, the unit assumes that the engine has started.

#### **Crank Disconnect On Gen. Frequency**

If the generator frequency over than 30.0 Hz, the unit assumes that the engine has started and the unit stop cranking.

#### **Crank Disconnect On Engine RPM**

If the generator speed over than 500 Rpm, the unit assumes that the engine has started and the unit stop cranking.

#### **Crank Disconnect On Gen. Voltage**

If the generator voltage over than 300 Vac, the unit assumes that the engine has started and the unit stop cranking.

#### **Crank Disconnect On Charge Alt. Voltage**

If the charge alternator voltage over than 6.1 Vdc, the unit assumes that the engine has started and the unit stop cranking. **Note:** If the charge generator input (terminal #35) is disconnect, this parameter selected as disabled (6.0 Vdc).

#### **Crank Disconnect On Oil Pressure En/Dis**

This parameter is used for to activate of the crank disconnect on oil pressure feature.

#### **Oil Pressure Value**

If the oil pressure sender over than this value, the unit assumes that the engine has started and the unit stop cranking.

#### **Check Oil Pressure Before Start**

If this parameter is enabled, the unit will not be allowed to crank if the oil pressure isn't seen as being low.

<b>ENGINE SPEED SETS (<i>Engine-&gt;Speed settings</i>)</b>		<b>Min</b>	<b>Max</b>	<b>Default</b>	<b>Unit</b>
<b>Nominal speed</b>	Nominal Speed	500	5000	1500	RPM
<b>Under speed shutdown</b>	Engine Under Speed Shutdown	500(dis)	5000	dis	RPM
<b>Under speed prealarm</b>	Engine Under Speed Prealarm	500(dis)	5000	dis	RPM
<b>Under speed reset</b>	Engine Under Speed Prealarm Reset	500	5000	500	RPM
<b>Over speed shutdown</b>	Engine Over Speed Shutdown	500(dis)	5000	dis	RPM
<b>Over speed prealarm</b>	Engine Over Speed Prealarm	500(dis)	5000	dis	RPM
<b>Over speed reset</b>	Engine Over Speed Prealarm Reset	500	5000	500	RPM
<b>Shutdown delay time</b>	Engine Speed Shutdown Delay Time	0.0	10.0	1.0	Sec

The parameters in this page are used for the generator speed low and high alarms.

**Note:** dis = disable

<b>ENGINE PLANT BATTERY (<i>Engine-&gt;Plant battery</i>)</b>		<b>Min</b>	<b>Max</b>	<b>Default</b>	<b>Unit</b>
<b>Under volt shutdown</b>	Battery Undervolts Shutdown	6.0(dis)	30.0	dis	V <sub>---</sub>
<b>Under volt warning</b>	Battery Undervolts Warning	6.0(dis)	30.0	11.0	V <sub>---</sub>
<b>Under volt reset</b>	Battery Undervolts Warning Reset	6.0	30.0	11.5	V <sub>---</sub>
<b>Under volt delay</b>	Battery Undervolts Volts Delay	0.0	9.9	1.0	Sec
<b>Over volt shutdown</b>	Battery Overvolts Shutdown	6.0(dis)	30.0	dis	V <sub>---</sub>
<b>Over volt warning</b>	Battery Overvolts Warning	6.0(dis)	30.0	29.0	V <sub>---</sub>
<b>Over volt reset</b>	Battery Overvolts Warning Reset	6.0	30.0	28.5	V <sub>---</sub>
<b>Over volt delay</b>	Battery Overvolts Delay	0.0	9.9	1.0	Sec
<b>Alt. chg. warning</b>	Charge Alternator Warning	6.0(dis)	30.0	dis	V <sub>---</sub>

The parameters in this page are used for the battery voltage low and high alarms and the charge alternator voltage warning.

<b>CANBUS ECU (Engine-&gt;CanBus ECU)*<sup>10</sup></b>		<b>Min</b>	<b>Max</b>	<b>Default</b>	<b>Unit</b>
<b>Baud rate</b>	Baud Rate: 0 - 20 1 - 50 2 - 100 3 - 125 4 - 250 5 - 500 6 - 800 7 - 1.000	0	7	4	kBaud
<b>J1939 ECU type</b>	J1939 ECU Type Selection: 0 - Disable 1 - Standard 2 - Volvo EMS1 3 - Volvo EMS2 4 - Volvo EMS2b 5 - Volvo EDC3 6 - Volvo EDC4 7 - Deutz EMR2 8 - Deutz EMR3 9 - Perkins 1300 10 - Perkins ADEM3 11 - Perkins ADEM4 12 - Scania S6 13 - MAN MFR	0(dis)	13	3	
<b>Device address</b>	Device Address	0	255	17	
<b>SPN version</b>	SPN version	1	3	1	
<b>ECU remote control</b>	ECU Remote Control via J1939	ENABL/DISBL	ENABL		
<b>Speed control enable</b>	Speed Control via J1939	ENABL/DISBL	ENABL		
<b>Oil pres cont. enab</b>	Oil Pressure Control via J1939	ENABL/DISBL	DISBL		
<b>Temp. control enable</b>	Coolant Temperature Control via J1939	ENABL/DISBL	DISBL		
<b>Speed set point</b>	Speed Set Point Selection	1500 / 1800	1500		RPM
<b>Speed correction</b>	Speed Correction Value	0	100	50	%

### Baud Rate

It defines the used Baud rate.

**Note:** All participants on the CAN bus must use the same Baud rate.

### J1939 ECU Type Selection

The J1939 interface of this unit can be operated with different ECUs. This parameter determines the operating mode of the used ECUs. If this parameter is selected as "disable", No messages will be sent or received.

**Note:** Volvo EMS2 engine types: TAD734, TAD940, TAD941, TAD1640, TAD1641, TAD1642.  
Volvo EDC3 engine types: TAD1240, TAD1241, TAD1242.  
Volvo EDC4 engine types: TD520, TAD520, TD720, TAD720, TAD721, TAD722.  
Perkins engines fitted with the ADEM3 / ADEM4: 2306, 2506, 1106, 2806.  
Scania S6 engine types: DC 9, DC 12, DC 16.  
MAN MFR type: EDC7.

**Note:** Changing above mentioned parameter becomes only effective after restarting the unit.

**Note:** \*<sup>10</sup> = Parameters in this table are only available at Trans-MidiAMF.CAN  
dis = disable



### ECU Device Address

The unit sends J1939 request and control messages with this ID. It must be changed for different ECU types according to the following table. The ECU listens only to control messages, if they are sent to the correct address.

<i>Volvo EMS1, Volvo EMS2, Volvo EMS2b, Volvo EDC3</i>	<i>Volvo EDC4, Deutz EMR2, Deutz EMR3</i>	<i>Perkins 1300, Perkins ADEM3, Perkins ADEM4</i>	<i>Scania S6</i>	<i>MAN MFR</i>
17	3	43	39	253

### SPN Version

There are 4 different Suspect Parameter Number versions with J1939 protocol. The device has ability to detecting version 4 automatically. Therefore, this parameter is important to show alarm messages correctly except version 4.

### ECU Remote Control Via J1939

If this parameter is selected as "Enable", The unit sends remote control messages to the ECU if the selected ECU type is supporting the J1939 Remote control Messages. Available messages are engine start-stop, 50/60 Hz selection or Idle mode. For some ECUs;

Parameter	<i>Volvo EMS1, Volvo EMS2, Volvo EMS2b, Volvo EDC3</i>	<i>Volvo EDC4, Deutz EMR2, Deutz EMR3</i>	<i>Perkins 1300, Perkins ADEM3, Perkins ADEM4</i>	<i>Scania S6</i>	<i>MAN MFR</i>	Standard
<b>Remote Start</b>	Yes	No	No	Yes	Yes	No
<b>Remote Stop</b>	Yes	No	No	Yes	Yes	No
<b>50/60 Hz Selection</b>	Yes	No	No	Yes	No	No
<b>Idle Mode</b>	Yes	No	No	Yes	Yes	No

If this parameter is selected as "Disable", The ECU remote control via the J1939 protocol will be disabled.

### Speed Control via J1939

If this parameter is selected as "Enable", The speed sensing from J1939 ECU will be used for the speed (Rpm) failures.

### Oil Pressure Control via J1939

If this parameter is selected as "Enable", The oil pressure sensing from J1939 ECU will be used for the oil pressure failures and the engine started signal.

### Coolant Temperature Control via J1939

If this parameter is selected as "Enable", The coolant temperature sensing from J1939 ECU will be used for the coolant temperature failures.

### Speed Set Point Selection (50/60 Hz)

This parameter used for to select the requested engine speed as 1500Rpm (50Hz) or 1800Rpm (60Hz). **Note:** The scenario; first change the parameter, next wait at least 5 seconds, and then start the engine.

### Speed Correction Value

This parameter can be changed between 0 and 100%. The engine should change the speed as follows:

0% = rated speed – speed deviation ECU e.g. 1500 – 120 = 1380rpm

50% = rated speed e.g. = 1500rpm

100% = rated speed + speed deviation ECU e.g. 1500 + 120 = 1620rpm

<b>CANBUS ERROR SET (Engine-&gt;CanBus error set)*11</b>		<b>Min</b>	<b>Max</b>	<b>Default</b>	<b>Unit</b>
<b>CAN fault actions</b>	Can Fault Actions: 0- Disable 1- Warning Non-Latching 2- Warning (Alarm Only, No Shutdown) 3- Electrical Trip (Alarm/Off Load Generator Followed By Shutdown After Cooling) 4- Shutdown (Alarm And Shutdown)	0(dis)	4	0	
<b>CAN fault activation</b>	Can Fault Activation: 0- Active From Starting 1- Active From Safety On 2- Always Active	0	2	0	
<b>CAN fault delay</b>	Can Fault Delay	2	250	10	Sec
<b>Amber warn.actions</b>	J1939 Amber Warning Lamp Actions: 0- Disable 1- Warning Non-Latching 2- Warning (Alarm Only, No Shutdown) 3- Electrical Trip (Alarm/Off Load Generator Followed By Shutdown After Cooling) 4- Shutdown (Alarm And Shutdown)	0(dis)	4	0	
<b>Amber warn.activation</b>	J1939 Amber Warning Lamp Activation: 0- Active From Starting 1- Active From Safety On 2- Always Active	0	2	2	
<b>Amber warn.delay</b>	J1939 Amber Warning Lamp Delay	0	250	2	Sec
<b>Red stop actions</b>	J1939 Red Stop Lamp Actions: 0- Disable 1- Warning Non-Latching 2- Warning (Alarm Only, No Shutdown) 3- Electrical Trip (Alarm/Off Load Generator Followed By Shutdown After Cooling) 4- Shutdown (Alarm And Shutdown)	0(dis)	4	0	
<b>Red stop activation</b>	J1939 Red Stop Lamp Activation: 0- Active From Starting 1- Active From Safety On 2- Always Active	0	2	2	
<b>Red stop delay</b>	J1939 Red Stop Lamp Delay	0	250	2	Sec

**Note:** \*11 = Parameters in this table are only available at Trans-MidiAMF.CAN  
dis = disable

<b>ENGINE MAINTENANCE (<i>Engine-&gt;Maintenance</i>)</b>		<b>Min</b>	<b>Max</b>	<b>Default</b>	<b>Unit</b>
<b>Running hour interval</b>	Running Hours Interval	0(dis)	9999	600	Hour
<b>Maint. date interval</b>	Maintenance Date Interval	0(dis)	12	6	Month
<b>Eng. stop when maint</b>	Force Engine Shutdown When Maintenance Is Due	ENABL/DISBL		DISBL	
<b>Engine running hour</b>	Engine Running Hour	0	30000	0	
<b>Maintenance okay</b>	Maintenance Okay	YES/NO		NO	

**Engine Running Hour:** The user can change the engine running hours value by using this parameter.

<b>LOAD EXERCISE (<i>Engine-&gt;Load exercise</i>)</b>		<b>Min</b>	<b>Max</b>	<b>Default</b>	<b>Unit</b>
<b>Disable/enable select</b>	Disable, No Load or On Load Selection	0-DISABLE 1-NO LOAD 2-ON LOAD		1-NO LOAD	

**Disable, No Load or On Load Selection**

DISABLE: Test mode disable.

NO LOAD: The generator will be running without taking the load in test mode.

ON LOAD: The generator will be running with load in test mode.

**Note:** dis = disable

<b>EXERCISE (Engine-&gt;Exercise)</b>		<b>Min</b>	<b>Max</b>	<b>Default</b>	<b>Unit</b>
<b>Disable/enable select</b>	Exercise Disable or Enable	DISBL/ENABL		DISBL	
<b>Start time1 on monday</b>	Exercise Start Time 1 on Monday	0.00	23.59	0.00	H.Min
<b>Stop time1 on monday</b>	Exercise Stop Time 1 on Monday	0.00	23.59	0.00	H.Min
<b>Start time2 on monday</b>	Exercise Start Time 2 on Monday	0.00	23.59	0.00	H.Min
<b>Stop time2 on monday</b>	Exercise Stop Time 2 on Monday	0.00	23.59	0.00	H.Min
<b>Start time3 on monday</b>	Exercise Start Time 3 on Monday	0.00	23.59	0.00	H.Min
<b>Stop time3 on monday</b>	Exercise Stop Time 3 on Monday	0.00	23.59	0.00	H.Min
<b>Start time4 on monday</b>	Exercise Start Time 4 on Monday	0.00	23.59	0.00	H.Min
<b>Stop time4 on monday</b>	Exercise Stop Time 4 on Monday	0.00	23.59	0.00	H.Min
<b>Start time1 on tues.</b>	Exercise Start Time 1 on Tuesday	0.00	23.59	0.00	H.Min
<b>Stop time1 on tuesday</b>	Exercise Stop Time 1 on Tuesday	0.00	23.59	0.00	H.Min
<b>Start time2 on tues.</b>	Exercise Start Time 2 on Tuesday	0.00	23.59	0.00	H.Min
<b>Stop time2 on tuesday</b>	Exercise Stop Time 2 on Tuesday	0.00	23.59	0.00	H.Min
<b>Start time3 on tues.</b>	Exercise Start Time 3 on Tuesday	0.00	23.59	0.00	H.Min
<b>Stop time3 on tuesday</b>	Exercise Stop Time 3 on Tuesday	0.00	23.59	0.00	H.Min
<b>Start time4 on tues.</b>	Exercise Start Time 4 on Tuesday	0.00	23.59	0.00	H.Min
<b>Stop time4 on tuesday</b>	Exercise Stop Time 4 on Tuesday	0.00	23.59	0.00	H.Min
<b>Start time1 on wednes</b>	Exercise Start Time 1 on Wednesday	0.00	23.59	0.00	H.Min
<b>Stop time1 on wednes.</b>	Exercise Stop Time 1 on Wednesday	0.00	23.59	0.00	H.Min
<b>Start time2 on wednes</b>	Exercise Start Time 2 on Wednesday	0.00	23.59	0.00	H.Min
<b>Stop time2 on wednes.</b>	Exercise Stop Time 2 on Wednesday	0.00	23.59	0.00	H.Min
<b>Start time3 on wednes</b>	Exercise Start Time 3 on Wednesday	0.00	23.59	0.00	H.Min
<b>Stop time3 on wednes.</b>	Exercise Stop Time 3 on Wednesday	0.00	23.59	0.00	H.Min
<b>Start time4 on wednes</b>	Exercise Start Time 4 on Wednesday	0.00	23.59	0.00	H.Min
<b>Stop time4 on wednes.</b>	Exercise Stop Time 4 on Wednesday	0.00	23.59	0.00	H.Min
<b>Start time1 on thurs.</b>	Exercise Start Time 1 on Thursday	0.00	23.59	0.00	H.Min
<b>Stop time1 on thurs.</b>	Exercise Stop Time 1 on Thursday	0.00	23.59	0.00	H.Min
<b>Start time2 on thurs.</b>	Exercise Start Time 2 on Thursday	0.00	23.59	0.00	H.Min
<b>Stop time2 on thurs.</b>	Exercise Stop Time 2 on Thursday	0.00	23.59	0.00	H.Min
<b>Start time3 on thurs.</b>	Exercise Start Time 3 on Thursday	0.00	23.59	0.00	H.Min
<b>Stop time3 on thurs.</b>	Exercise Stop Time 3 on Thursday	0.00	23.59	0.00	H.Min
<b>Start time4 on thurs.</b>	Exercise Start Time 4 on Thursday	0.00	23.59	0.00	H.Min
<b>Stop time4 on thurs.</b>	Exercise Stop Time 4 on Thursday	0.00	23.59	0.00	H.Min
<b>Start time1 on friday</b>	Exercise Start Time 1 on Friday	0.00	23.59	0.00	H.Min
<b>Stop time1 on friday</b>	Exercise Stop Time 1 on Friday	0.00	23.59	0.00	H.Min
<b>Start time2 on friday</b>	Exercise Start Time 2 on Friday	0.00	23.59	0.00	H.Min
<b>Stop time2 on friday</b>	Exercise Stop Time 2 on Friday	0.00	23.59	0.00	H.Min
<b>Start time3 on friday</b>	Exercise Start Time 3 on Friday	0.00	23.59	0.00	H.Min
<b>Stop time3 on friday</b>	Exercise Stop Time 3 on Friday	0.00	23.59	0.00	H.Min
<b>Start time4 on friday</b>	Exercise Start Time 4 on Friday	0.00	23.59	0.00	H.Min
<b>Stop time4 on friday</b>	Exercise Stop Time 4 on Friday	0.00	23.59	0.00	H.Min
<b>Start time1 on satur.</b>	Exercise Start Time 1 on Saturday	0.00	23.59	0.00	H.Min
<b>Stop time1 on satur.</b>	Exercise Stop Time 1 on Saturday	0.00	23.59	0.00	H.Min
<b>Start time2 on satur.</b>	Exercise Start Time 2 on Saturday	0.00	23.59	0.00	H.Min
<b>Stop time2 on satur.</b>	Exercise Stop Time 2 on Saturday	0.00	23.59	0.00	H.Min
<b>Start time3 on satur.</b>	Exercise Start Time 3 on Saturday	0.00	23.59	0.00	H.Min
<b>Stop time3 on satur.</b>	Exercise Stop Time 3 on Saturday	0.00	23.59	0.00	H.Min
<b>Start time4 on satur.</b>	Exercise Start Time 4 on Saturday	0.00	23.59	0.00	H.Min
<b>Stop time4 on satur.</b>	Exercise Stop Time 4 on Saturday	0.00	23.59	0.00	H.Min

Note: dis = disable

<b>Start time1 on sunday</b>	Exercise Start Time 1 on Sunday	0.00	23.59	0.00	H.Min
<b>Stop time1 on sunday</b>	Exercise Stop Time 1 on Sunday	0.00	23.59	0.00	H.Min
<b>Start time2 on sunday</b>	Exercise Start Time 2 on Sunday	0.00	23.59	0.00	H.Min
<b>Stop time2 on sunday</b>	Exercise Stop Time 2 on Sunday	0.00	23.59	0.00	H.Min
<b>Start time3 on sunday</b>	Exercise Start Time 3 on Sunday	0.00	23.59	0.00	H.Min
<b>Stop time3 on sunday</b>	Exercise Stop Time 3 on Sunday	0.00	23.59	0.00	H.Min
<b>Start time4 on sunday</b>	Exercise Start Time 4 on Sunday	0.00	23.59	0.00	H.Min
<b>Stop time4 on sunday</b>	Exercise Stop Time 4 on Sunday	0.00	23.59	0.00	H.Min

<b>ENGINE GENERAL (Engine-&gt;General)</b>		<b>Min</b>	<b>Max</b>	<b>Default</b>	<b>Unit</b>
<b>Fuel selection</b>	Engine Fuel Selection	0-GAS 1-DIESEL 2-GASOLINE		1-DIESEL	
<b>Stop solenoid time</b>	Stop Solenoid Time	1	99	20	Sec
<b>Ignition delay</b>	Ignition Delay	1	99	5	Sec
<b>Gas valve delay</b>	Gas Valve Delay	1	99	5	Sec
<b>Min. of ignition speed</b>	Minimum Ignition Speed	10	1500	200	RPM
<b>Choke time</b>	Choke Time	0.0	30.0	0.8	Sec

### Engine Fuel (Gas/ Diesel/Gasoline) Selection

Gas, Diesel or Gasoline engines can be selected.

### Stop Solenoid Time

This timer is used if the unit is configured to operate an Energise to stop engine. It dictates the duration that the Stop Solenoid output will remain active after the module has detected the engine has come to rest. If the Stop Solenoid output is not configured, this timer will still operate, preventing an immediate restart.

### Ignition Delay

With gas engines often a purging operation is desired before starting. With the engaging of the starter the ignition delay is started. If the 'min ignition speed' is reached after expiry of this time, the configurable relay output 'ignition' is set.

### Gas Valve Delay

By setting the ignition relay the gas valve delay is started. After the expiry of the set time as long as the number of revolutions is higher than the minimum ignition speed, the gas valve is set. When the necessary engine shutdown process, gas valve is de-energised.

### Minimum Ignition Speed

After expiry of the ignition delay the number of revolutions set must be reached, so that the configurable relay output 'ignition' will be set.

### Choke Time

This timer dictates that how long choke output will be active in gasoline engines.

[s]  
[s]  
[s]  
[s]

$t_r$   
 $t_{ID}$   
 $t_{GV}$   
 $t_D$

Interval between 2 start attempts  
Ignition delay  
Gas valve delay  
Engine delayed monitoring

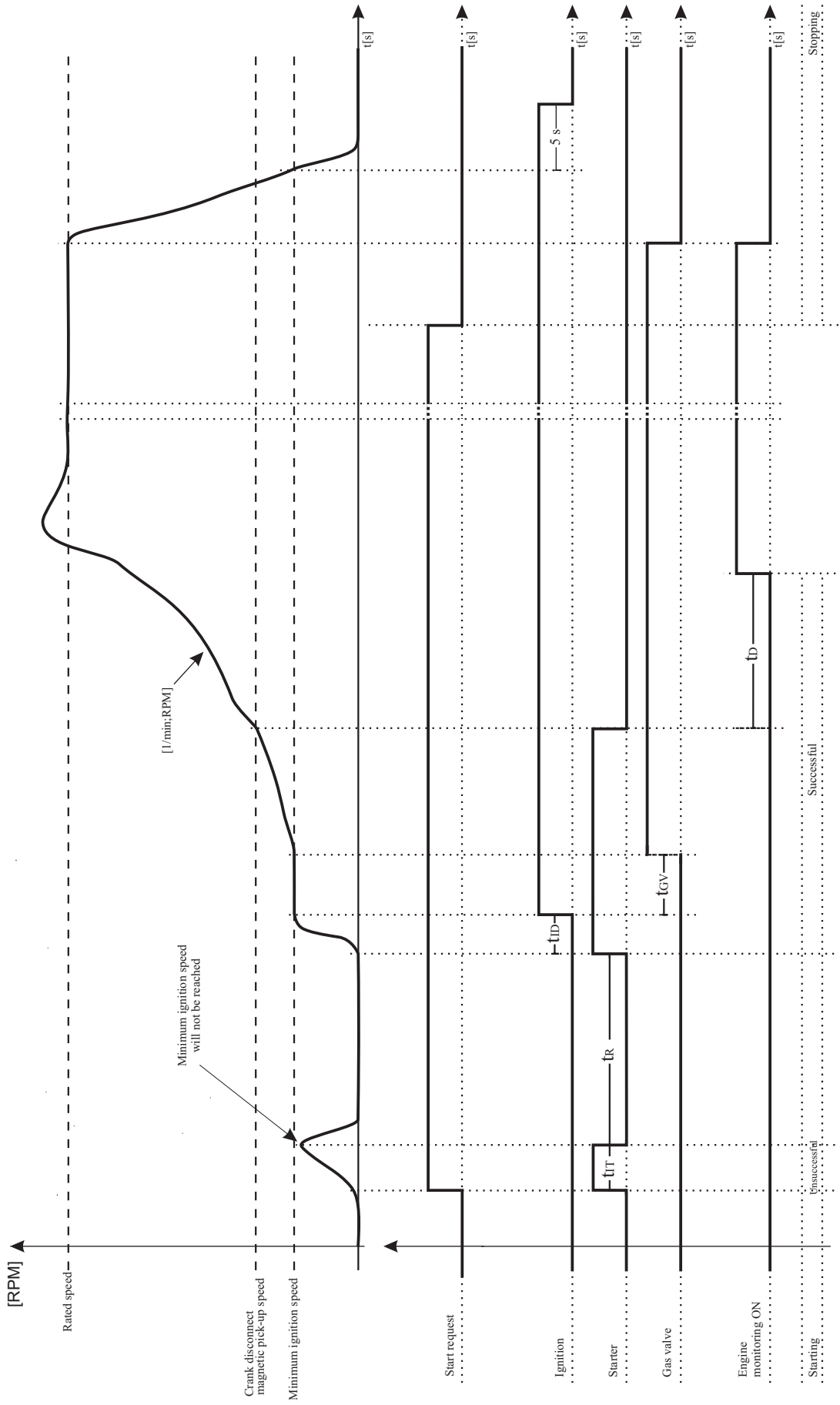

# Start/Stop Diagram for GAS ENGINE

$t_{PH}$  Preheating time [s]  
 $t_{CR}$  Engagement time [s]  
 $t_R$  Interval between 2 start attempts [s]  
 $t_D$  Engine delayed monitoring [s]

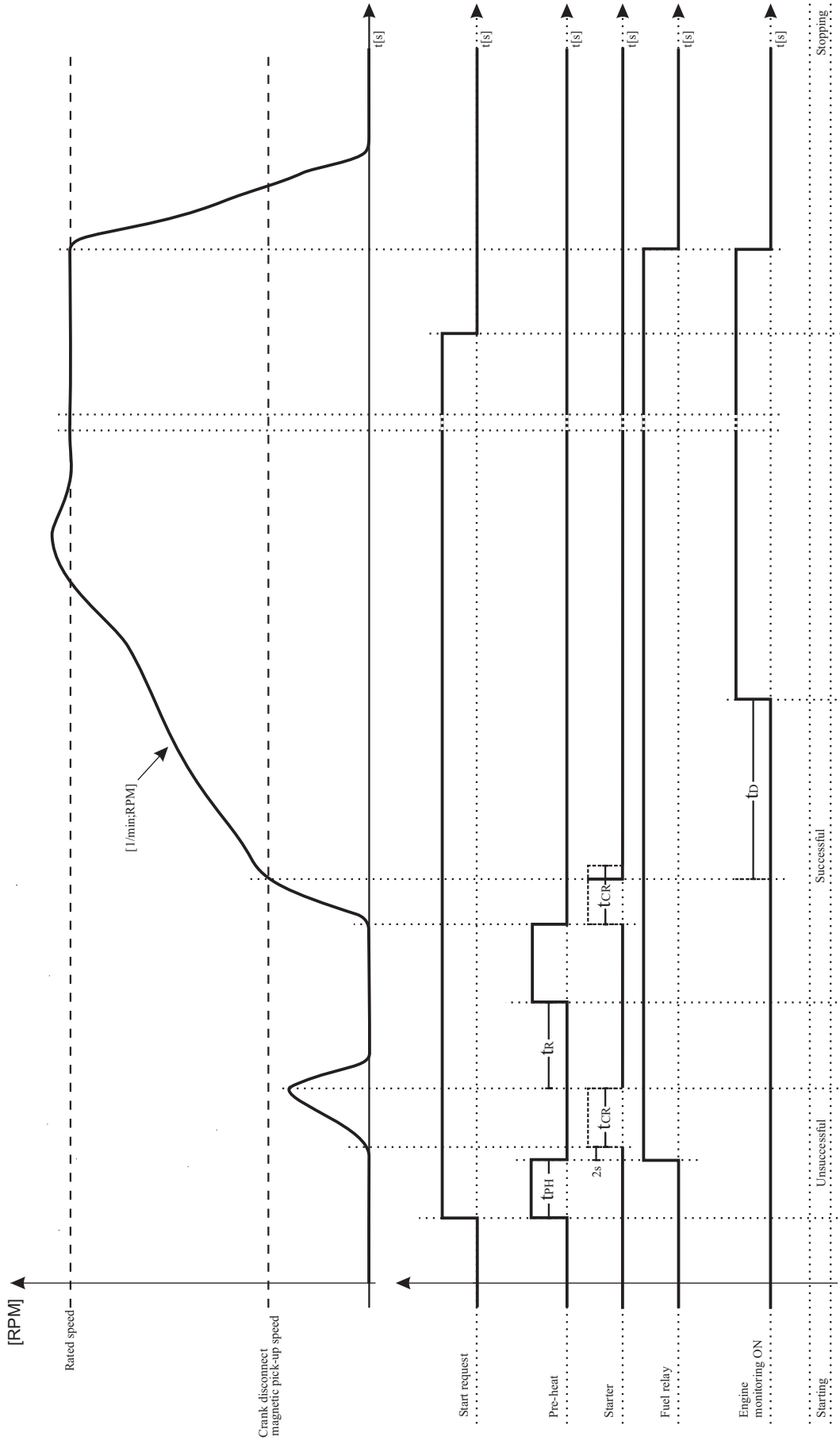

Start/Stop Diagram for DIESEL ENGINE

$t_{PH}$  Preheating time [s]  
 $t_{CR}$  Engagement time [s]  
 $t_{TR}$  Interval between 2 start attempts [s]  
 $t_D$  Engine delayed monitoring [s]  
 $t_{CH}$  Choke time [s]

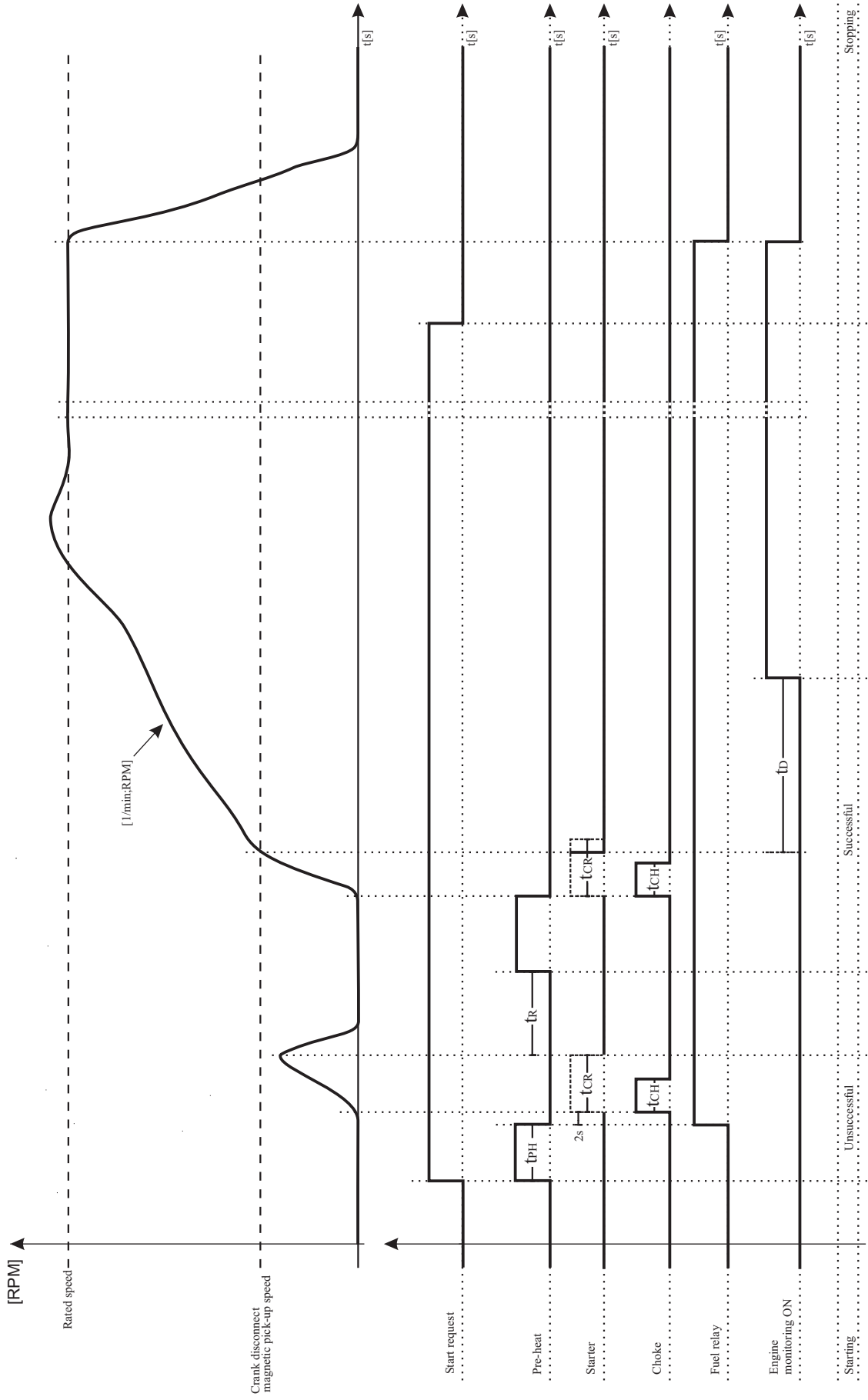

Start/Stop Diagram for GASOLINE ENGINE



## 4.2.5 Inputs

<b>SENDER INPUTS (<i>Inputs-&gt;Sender inputs</i>)</b>		<b>Min</b>	<b>Max</b>	<b>Default</b>	<b>Unit</b>
<b>Oil pressure unit</b>	Oil Pressure Unit	BAR/PSI/KPA		BAR	
<b>Oil press. input type</b>	Oil Pressure Input Type	0 - Not Used (Disable) 1 - Digital NC 2 - Digital NO 3 - VDO 5 BAR 4 - VDO 7 BAR 5 - VDO 10 BAR 6 - DATCON 5 BAR 7 - DATCON 7 BAR 8 - MURPHY 7 BAR 9 - User Configured		0 (dis)	
<b>Oil pres.sensor break</b>	Oil Pressure Sensor Break	DISBL/ENABL		ENABL	
<b>Oil pressure prealarm</b>	Oil Pressure Pre-Alarm	0.0 (dis)	30.0	1.2	BAR
<b>Oil pressure reset</b>	Oil Pressure Pre-Alarm Reset	0.0	30.0	1.4	BAR
<b>Oil pressure shutdown</b>	Oil Pressure Shutdown	0.0	30.0	1.0	BAR
<b>Temperature unit</b>	Coolant Temperature Unit	°C/°F		°C	
<b>Temp. input type</b>	Coolant Temperature Input Type	0 - Not Used (Disable) 1 - Digital NC 2 - Digital NO 3 - VDO 120 °C 4 - VDO 150 °C 5 - DATCON 6 - MURPHY 7 - PT100 8 - User Configured		0 (dis)	
<b>Temp. sensor break</b>	Temperature Sensor Break	0 - Disable 1 - Enable From Safety On (3min. delayed) 2 - Always Enable		0 (dis)	
<b>High temp. prealarm</b>	High Temperature Pre-Alarm	0 (dis)	300	90	°C
<b>High temp. reset</b>	High Temp. Pre-Alarm Reset	0	300	88	°C
<b>High temp. shutdown</b>	High Temperature Shutdown	0	300	95	°C
<b>Low temp. warning</b>	Low Temperature Warning	0 (dis)	70	0 (dis)	°C
<b>Heater control ON</b>	Coolant Heater Control On	0 (dis)	300	0 (dis)	°C
<b>Heater control OFF</b>	Coolant Heater Control Off	0	300	45	°C
<b>Water pump on time</b>	Water Pump On Time	0	9999	5	Sec
<b>Water pump off time</b>	Water Pump Off Time	0	9999	5	Sec
<b>Conf. AI1 unit</b>	Configurable Analog Input-1 Unit	BAR/PSI/KPA/°C/°F/%/Lt		%	
<b>Conf. AI1 type</b>	Configurable Analog Input-1 Type	0 - Not Used (Disable) 1 - Digital NC 2 - Digital NO 3 - VDO OHM (10-180) 4 - VDO TUBE (90-0) 5 - US OHM (240-33) 6 - EMS OHM (0-190) 7 - FORD (73-10) 8 - User Configured		0 (dis)	
<b>Cnf.AI1 sens err.shut</b>	Configurable Analog Input-1 Sensor error shutdown	DISBL/ENABL		ENABL	
<b>Conf. AI1 low prealm</b>	Configurable Analog Input-1 Low Pre-Alarm	0 (dis)	3000	0 (dis)	%
<b>Conf. AI1 low reset</b>	Configurable Analog Input-1 Low Reset	0	3000	60	%
<b>Conf. AI1 low shutdwn</b>	Configurable Analog Input-1 Low Shutdown	0 (dis)	3000	0 (dis)	%

<b>Conf. AI1 high prealr</b>	Configurable Analog Input-1 High Pre-Alarm	0 (dis)	3000	0 (dis)	%
<b>Conf. AI1 high reset</b>	Configurable Analog Input-1 High Reset	0	3000	90	%
<b>Conf. AI1 high shutd.</b>	Configurable Analog Input-1 High Shutdown	0 (dis)	3000	0 (dis)	%
<b>Conf. AI1 control ON</b>	Configurable Analog Input-1 control ON	0 (dis)	3000	0 (dis)	%
<b>Conf. AI1 control OFF</b>	Configurable Analog Input-1 control OFF	0	3000	75	%

**Note:** dis = disable

### Oil Pressure Input Type

This section is used to configure the Oil Pressure sender input.

**0-NOT USED:** The Oil Pressure input will not be monitored.

**1-DIGITAL NC:** The Oil pressure input is fed from an engine mounted digital pressure switch. This switch returns a closed signal during low oil pressure conditions (and engine at rest), once oil pressure is established the switch will open.

**2-DIGITAL NO:** The Oil pressure input is fed from an engine mounted digital pressure switch. This switch returns an open signal during low oil pressure conditions (and engine at rest), once oil pressure is established the switch will close.

**3, 4, 5, 6, 7, 8 and 9:** Oil pressure input is connected to a resistive type engine mounted oil pressure transducer. If this parameter selected as "**9-USER CONFIGURED**", the user can input the data manually according to the sensor curve.

### Oil Pressure Sensor Break

**DISABLE:** Oil Pressure Temperature sensor break will not be monitored.

**ENABLE:** Oil Pressure Temperature sensor break will be monitored if the engine runs at least 3 minutes.

### Temperature Input Type

This section is used to configure the Coolant Temperature sender input.

**0-NOT USED:** The Coolant Temperature input will not be monitored.

**1-DIGITAL NC:** The Coolant Temperature input is fed from an engine mounted digital temperature switch. This switch returns a closed signal during low temperature, should the temperature rise above the switch manufacturers trip point the switch contact will open.

**2-DIGITAL NO:** The Coolant Temperature input is fed from an engine mounted digital temperature switch. This switch returns an open signal during low temperature, should the temperature rise above the switch manufacturers trip point the switch contact will close.

**3, 4, 5, 6, 7 and 8:** The Coolant Temperature input is connected to a resistive type engine mounted temperature transducer. If this parameter selected as "**8-USER CONFIGURED**", the user can input the data manually according to the sensor curve.

### Temperature Sensor Break

**Disable:** The Coolant Temperature sensor break will not be monitored.

**Enable From Safety On (3min. delayed):** The Coolant Temperature sensor break will be monitored if the engine runs at least 3 minutes.

**Always Enable:** The Coolant Temperature sensor break always will be monitored.

### Configurable Analog Input-1 Type

This section is used to configure the Configurable Analog Input-1 sender input.

**0-NOT USED:** The Configurable Analog Input-1 will not be monitored.

**1-DIGITAL NC:** open for low Configurable Analog Input-1.

**2-DIGITAL NO:** close for low Configurable Analog Input-1.

**3, 4, 5, 6, 7 and 8:** The Configurable Analog Input-1 input is connected to a resistive type engine mounted level/temperature/pressure transducer. If this parameter selected as "**8-USER CONFIGURED**", the user can input the data manually according to the sensor curve.

### Configurable Analog Input-1 Sensor Error Shutdown

**DISABLE:** Configurable Analog Input-1 sensor break will be monitored but engine will not shutdown in case of sensor error.

**ENABLE:** Configurable Analog Input-1 sensor break will be monitored and engine will shutdown in case of sensor error.

<b>SENDER LINEARISATION (Inputs-&gt;Sender linearisation)</b>		<b>Min</b>	<b>Max</b>	<b>Default</b>	<b>Unit</b>
<b>Oil pressure sender 1</b>	Oil Pressure Sender Point-1	0	1300	15	R
<b>Oil pressure 1</b>	Oil Pressure Point-1	0.0	30.0	0.0	BAR
<b>Oil pressure sender 2</b>	Oil Pressure Sender Point-2	0	1300	31	R
<b>Oil pressure 2</b>	Oil Pressure Point-2	0.0	30.0	1.0	BAR
<b>Oil pressure sender 3</b>	Oil Pressure Sender Point-3	0	1300	49	R
<b>Oil pressure 3</b>	Oil Pressure Point-3	0.0	30.0	2.0	BAR
<b>Oil pressure sender 4</b>	Oil Pressure Sender Point-4	0	1300	66	R
<b>Oil pressure 4</b>	Oil Pressure Point-4	0.0	30.0	3.0	BAR
<b>Oil pressure sender 5</b>	Oil Pressure Sender Point-5	0	1300	85	R
<b>Oil pressure 5</b>	Oil Pressure Point-5	0.0	30.0	4.0	BAR
<b>Oil pressure sender 6</b>	Oil Pressure Sender Point-6	0	1300	101	R
<b>Oil pressure 6</b>	Oil Pressure Point-6	0.0	30.0	5.0	BAR
<b>Oil pressure sender 7</b>	Oil Pressure Sender Point-7	0	1300	117	R
<b>Oil pressure 7</b>	Oil Pressure Point-7	0.0	30.0	6.0	BAR
<b>Oil pressure sender 8</b>	Oil Pressure Sender Point-8	0	1300	132	R
<b>Oil pressure 8</b>	Oil Pressure Point-8	0.0	30.0	7.0	BAR
<b>Oil pressure sender 9</b>	Oil Pressure Sender Point-9	0	1300	149	R
<b>Oil pressure 9</b>	Oil Pressure Point-9	0.0	30.0	8.0	BAR
<b>Oil pressure sender 10</b>	Oil Pressure Sender Point-10	0	1300	178	R
<b>Oil pressure 10</b>	Oil Pressure Point-10	0.0	30.0	10.0	BAR
<b>Temperature sender 1</b>	Temperature Sender Point-1	0	1300	579	R
<b>Temperature 1</b>	Temperature Point-1	0	300	28	°C
<b>Temperature sender 2</b>	Temperature Sender Point-2	0	1300	404	R
<b>Temperature 2</b>	Temperature Point-2	0	300	35	°C
<b>Temperature sender 3</b>	Temperature Sender Point-3	0	1300	342	R
<b>Temperature 3</b>	Temperature Point-3	0	300	40	°C
<b>Temperature sender 4</b>	Temperature Sender Point-4	0	1300	250	R
<b>Temperature 4</b>	Temperature Point-4	0	300	50	°C
<b>Temperature sender 5</b>	Temperature Sender Point-5	0	1300	179	R
<b>Temperature 5</b>	Temperature Point-5	0	300	60	°C
<b>Temperature sender 6</b>	Temperature Sender Point-6	0	1300	136	R
<b>Temperature 6</b>	Temperature Point-6	0	300	70	°C
<b>Temperature sender 7</b>	Temperature Sender Point-7	0	1300	103	R
<b>Temperature 7</b>	Temperature Point-7	0	300	80	°C
<b>Temperature sender 8</b>	Temperature Sender Point-8	0	1300	77	R
<b>Temperature 8</b>	Temperature Point-8	0	300	90	°C
<b>Temperature sender 9</b>	Temperature Sender Point-9	0	1300	67	R
<b>Temperature 9</b>	Temperature Point-9	0	300	95	°C
<b>Temperature sender 10</b>	Temperature Sender Point-10	0	1300	63	R
<b>Temperature 10</b>	Temperature Point-10	0	300	98	°C
<b>Conf. AI1 sender 1</b>	Configurable Analog Input-1 Sender Point-1	0	1300	10	R
<b>Conf. AI1 value 1</b>	Configurable Analog Input-1 Point-1	0	3000	0	%
<b>Conf. AI1 sender 2</b>	Configurable Analog Input-1 Sender Point-2	0	1300	30	R
<b>Conf. AI1 value 2</b>	Configurable Analog Input-1 Point-2	0	3000	11	%
<b>Conf. AI1 sender 3</b>	Configurable Analog Input-1 Sender Point-3	0	1300	50	R
<b>Conf. AI1 value 3</b>	Configurable Analog Input-1 Point-3	0	3000	22	%
<b>Conf. AI1 sender 4</b>	Configurable Analog Input-1 Sender Point-4	0	1300	70	R
<b>Conf. AI1 value 4</b>	Configurable Analog Input-1 Point-4	0	3000	33	%
<b>Conf. AI1 sender 5</b>	Configurable Analog Input-1 Sender Point-5	0	1300	90	R
<b>Conf. AI1 value 5</b>	Configurable Analog Input-1 Point-5	0	3000	44	%

<b>Conf. AI1 sender 6</b>	Configurable Analog Input-1 Sender Point-6	0	1300	110	R
<b>Conf. AI1 value 6</b>	Configurable Analog Input-1 Point-6	0	3000	55	%
<b>Conf. AI1 sender 7</b>	Configurable Analog Input-1 Sender Point-7	0	1300	130	R
<b>Conf. AI1 value 7</b>	Configurable Analog Input-1 Point-7	0	3000	66	%
<b>Conf. AI1 sender 8</b>	Configurable Analog Input-1 Sender Point-8	0	1300	150	R
<b>Conf. AI1 value 8</b>	Configurable Analog Input-1 Point-8	0	3000	77	%
<b>Conf. AI1 sender 9</b>	Configurable Analog Input-1 Sender Point-9	0	1300	170	R
<b>Conf. AI1 value 9</b>	Configurable Analog Input-1 Point-9	0	3000	88	%
<b>Conf. AI1 sender 10</b>	Configurable Analog Input-1 Sender Point-10	0	1300	190	R
<b>Conf. AI1 value 10</b>	Configurable Analog Input-1 Point-10	0	3000	100	%

<b>CONF. INPUT-1 (Inputs-&gt;Conf. input-1)</b>		<b>Min</b>	<b>Max</b>	<b>Default</b>	<b>Unit</b>
<b>Dis,user conf.or list</b>	0- Disable 1- User Configured 2- Select From List	0(dis)	2	2	
<b>Polarity</b>	0- Normally Open (Close To Activate) 1- Normally Close (Open To Activate)	0	1	1	
<b>Indication</b>	If User Configured 0- Status 1- Warning Non-Latching 2- Warning Latching 3- Electrical Trip 4- Shutdown	0	4	0	
<b>Activation</b>	If User Configured 0- Active From Starting 1- Active From Safety On 2- Always Active	0	2	2	
<b>Select from list</b>	If Select From List 0-Remote Start On Load 1-Remote Start Off Load 2-Auxiliary Mains Fail 3-Remote control active 4-Reserved 5-Reserved 6-Simulate Auto Button 7-Simulate Test Button 8-Reserved 9-Simulate Start Button 10-Simulate Stop Button 11-Generator Closed Auxiliary 12-Generator Load Inhibit 13-Mains Closed Auxiliary 14-Mains Load Inhibit 15-Auto Restore Inhibit 16-Auto Start Inhibit 17-Panel Lock 18-Scheduled Runs(Exercise) Inhibited 19-Reserved 20-Transfer To Generator/Open Mains 21-Transfer To Mains/Open Generator 22-Remote Inhibit 23-Being Found Alive 24-Low Battery 25-Emergency Stop 26-Emergency Stop No-Latching	0	26	25	
<b>Active delay</b>	Input active delay	0	250	0	Sec

**Note:** dis = disable

<b>CONF. INPUT-2 (Inputs-&gt;Conf. input-2)</b>		<b>Min</b>	<b>Max</b>	<b>Default</b>	<b>Unit</b>
<b>Dis,user conf.or list</b>	0- Disable 1- User Configured 2- Select From List	0(dis)	2	1	
<b>Polarity</b>	0- Normally Open (Close To Activate) 1- Normally Close (Open To Activate)	0	1	0	
<b>Indication</b>	If User Configured 0- Status 1- Warning Non-Latching 2- Warning Latching 3- Electrical Trip 4- Shutdown	0	4	0	
<b>Activation</b>	If User Configured 0- Active From Starting 1- Active From Safety On 2- Always Active	0	2	2	
<b>Select from list</b>	If Select From List 0-Remote Start On Load 1-Remote Start Off Load 2-Auxiliary Mains Fail 3-Remote control active 4-Reserved 5-Reserved 6-Simulate Auto Button 7-Simulate Test Button 8-Reserved 9-Simulate Start Button 10-Simulate Stop Button 11-Generator Closed Auxiliary 12-Generator Load Inhibit 13-Mains Closed Auxiliary 14-Mains Load Inhibit 15-Auto Restore Inhibit 16-Auto Start Inhibit 17-Panel Lock 18-Scheduled Runs(Exercise) Inhibited 19-Reserved 20-Transfer To Generator/Open Mains 21-Transfer To Mains/Open Generator 22-Remote Inhibit 23-Being Found Alive 24-Low Battery	0	24	3	
<b>Active delay</b>	Input active delay	0	250	5	Sec

**Note:** dis = disable

<b>CONF. INPUT-3 (Inputs-&gt;Conf. input-3)</b>		<b>Min</b>	<b>Max</b>	<b>Default</b>	<b>Unit</b>
<b>Dis,user conf.or list</b>	0- Disable 1- User Configured 2- Select From List	0(dis)	2	1	
<b>Polarity</b>	0- Normally Open (Close To Activate) 1- Normally Close (Open To Activate)	0	1	1	
<b>Indication</b>	If User Configured 0- Status 1- Warning Non-Latching 2- Warning Latching 3- Electrical Trip 4- Shutdown	0	4	4	
<b>Activation</b>	If User Configured 0- Active From Starting 1- Active From Safety On 2- Always Active	0	2	2	
<b>Select from list</b>	If Select From List 0-Remote Start On Load 1-Remote Start Off Load 2-Auxiliary Mains Fail 3-Remote control active 4-Reserved 5-Reserved 6-Simulate Auto Button 7-Simulate Test Button 8-Reserved 9-Simulate Start Button 10-Simulate Stop Button 11-Generator Closed Auxiliary 12-Generator Load Inhibit 13-Mains Closed Auxiliary 14-Mains Load Inhibit 15-Auto Restore Inhibit 16-Auto Start Inhibit 17-Panel Lock 18-Scheduled Runs(Exercise) Inhibited 19-Reserved 20-Transfer To Generator/Open Mains 21-Transfer To Mains/Open Generator 22-Remote Inhibit 23-Being Found Alive 24-Low Battery	0	24	4	
<b>Active delay</b>	Input active delay	0	250	5	Sec

**Note:** dis = disable



<b>CONF. INPUT-4 (Inputs-&gt;Conf. input-4)</b>		<b>Min</b>	<b>Max</b>	<b>Default</b>	<b>Unit</b>
<b>Dis,user conf.or list</b>	0- Disable 1- User Configured 2- Select From List	0(dis)	2	2	
<b>Polarity</b>	0- Normally Open (Close To Activate) 1- Normally Close (Open To Activate)	0	1	0	
<b>Indication</b>	If User Configured 0- Status 1- Warning Non-Latching 2- Warning Latching 3- Electrical Trip 4- Shutdown	0	4	0	
<b>Activation</b>	If User Configured 0- Active From Starting 1- Active From Safety On 2- Always Active	0	2	2	
<b>Select from list</b>	If Select From List 0-Remote Start On Load 1-Remote Start Off Load 2-Auxiliary Mains Fail 3-Remote control active 4-Reserved 5-Reserved 6-Simulate Auto Button 7-Simulate Test Button 8-Reserved 9-Simulate Start Button 10-Simulate Stop Button 11-Generator Closed Auxiliary 12-Generator Load Inhibit 13-Mains Closed Auxiliary 14-Mains Load Inhibit 15-Auto Restore Inhibit 16-Auto Start Inhibit 17-Panel Lock 18-Scheduled Runs(Exercise) Inhibited 19-Reserved 20-Transfer To Generator/Open Mains 21-Transfer To Mains/Open Generator 22-Remote Inhibit 23-Being Found Alive 24-Low Battery 25-Low Oil Pressure 26-Low Oil Level	0	26	25	
<b>Active delay</b>	Input active delay	0	250	0	Sec

**Note:** dis = disable

<b>CONF. INPUT-5 (Inputs-&gt;Conf. input-5)</b>		<b>Min</b>	<b>Max</b>	<b>Default</b>	<b>Unit</b>
<b>Dis,user conf.or list</b>	0- Disable 1- User Configured 2- Select From List	0(dis)	2	2	
<b>Polarity</b>	0- Normally Open (Close To Activate) 1- Normally Close (Open To Activate)	0	1	0	
<b>Indication</b>	If User Configured 0- Status 1- Warning Non-Latching 2- Warning Latching 3- Electrical Trip 4- Shutdown	0	4	0	
<b>Activation</b>	If User Configured 0- Active From Starting 1- Active From Safety On 2- Always Active	0	2	2	
<b>Select from list</b>	If Select From List 0-Remote Start On Load 1-Remote Start Off Load 2-Auxiliary Mains Fail 3-Remote control active 4-Reserved 5-Reserved 6-Simulate Auto Button 7-Simulate Test Button 8-Reserved 9-Simulate Start Button 10-Simulate Stop Button 11-Generator Closed Auxiliary 12-Generator Load Inhibit 13-Mains Closed Auxiliary 14-Mains Load Inhibit 15-Auto Restore Inhibit 16-Auto Start Inhibit 17-Panel Lock 18-Scheduled Runs(Exercise) Inhibited 19-Reserved 20-Transfer To Generator/Open Mains 21-Transfer To Mains/Open Generator 22-Remote Inhibit 23-Being Found Alive 24-Low Battery 25-High Temperature	0	25	25	
<b>Active delay</b>	Input active delay	0	250	0	Sec

**Note:** dis = disable

## CONFIGURABLE INPUTS SELECTIONS

### 0 REMOTE START ON LOAD

In AUTO mode, if one of the configurable inputs are selected as 0 (Remote Start On Load), the unit doesn't perform the mains failure control in order to start the generator. In AUTO mode, if one of the configurable inputs are selected as 0 (Remote Start On Load) and this input is active, then the unit will perform the start sequence and transfer load to the generator. If the input is passive, the unit will perform the stop sequence.

### 1 REMOTE START OFF LOAD

If this input is active, operation will be similar to the 'Remote Start On Load' function except that the generator will not be instructed to take the load. This function can be used where an engine only run is required e.g. for exercise.

### 2 AUXILIARY MAINS FAIL

The unit will monitor the incoming single or three phase supply for Over Voltage, Under Voltage, Over Frequency or Under Frequency. It may be required to monitor a different mains supply or some aspect of the incoming mains not monitored by the unit. If the devices providing this additional monitoring are connected to operate this input, the unit will operate as if the incoming mains supply has fallen outside of limits, the generator will be instructed to start and take load. Removal of the input signal will cause the unit to act if the mains has returned to within limits.

### 3 REMOTE CONTROL ACTIVE

This input is used to allow or prevent the remote controlling of the device.

### 4 RESERVED

### 5 RESERVED

### 6 SIMULATE AUTO BUTTON

This input mimic's the operation of the 'Auto' button and is used to provide a remotely located Auto mode push button.

### 7 SIMULATE TEST BUTTON

This input mimic's the operation of the 'Test' button and is used to provide a remotely located Test mode push button.

### 8 RESERVED

### 9 SIMULATE START BUTTON

This input mimic's the operation of the 'Start' button and is used to provide a remotely located start push button.

### 10 SIMULATE STOP BUTTON

This input mimic's the operation of the 'Stop' button and is used to provide a remotely located Stop push button.

### 11 GENERATOR CLOSED AUXILIARY

This input is used to provide feedback to allow the unit to give true indication of the contactor or circuit breaker switching status. It should be connected to the generator load switching device auxiliary contact.

### 12 GENERATOR LOAD INHIBIT

This input is used to prevent the unit from loading the generator. If the generator is already on load, activating this input will cause the unit to unload the generator. Removing the input will allow the generator to be loaded again. **Note:** This input only operates to control the generator-switching device if the unit load switching logic is attempting load the generator. It will not control the generator-switching device when the mains is on load.

### 13 MAINS CLOSED AUXILIARY

This input is used to provide feedback to allow the unit to give true indication of the contactor or circuit breaker switching status. It should be connected to the generator load switching device auxiliary contact.

### 14 MAINS LOAD INHIBIT

This input is used to prevent the unit from loading the mains supply. If the mains supply is already on load, activating this input will cause the unit to unload the mains supply. Removing the input will allow the mains to be loaded again. **Note:** This input only operates to control the mains-switching device if the unit load switching logic is attempting to load the mains. It will not control the mains-switching device when the generator is on load.

### **15 AUTO RESTORE INHIBIT**

When module in the AUTO mode. In the event of a remote start or mains failure, the generator will be instructed to start and take load. On removal of the remote start signal or mains return, the module will continue to run the generator on load until this AUTO RESTORE INHIBIT input is removed. Once the input is removed the unit will transfer the load back to the mains supply and follow a normal generator stop sequence. This input allows the module to be fitted as part of a system where the manual restoration to mains is controlled remotely or by an automated system.

### **16 AUTO START INHIBIT**

This input is used to provide an over-ride function to prevent the unit from starting the generator in the event of a remote start or mains out of limits condition occurring. If this input is active and a remote start signal or mains failure occurs the unit will not give a start command to the generator. If this input signal is then removed, the unit will operate as if a remote start or mains failure has occurred, starting and loading the generator. This function can be used to give an 'AND' function so that a generator will only be called to start if the mains fails and another condition exists which requires the generator to run. If the 'Auto Start Inhibit' signal become active once more it will be ignored until the unit has returned the mains supply on load and shutdown.

### **17 PANEL LOCK**

This input is used to provide security to the installation. If the panel lock input is active, the unit will not respond to operation of the mode select or start buttons. This allows the unit to be placed into a specific mode (such as Auto) and then secured. The operation of the unit is not affected and the operator will still be able to view the various instrumentation pages etc. **Note:** External control sources (i.e. Simulate Start Button) are not affected by the panel lock input and will continue to operate normally.

### **18 SCHEDULED RUNS(EXERCISE) INHIBITED**

This input is used to prevent the generator for starting in the event of a programmed scheduled (exercise) run occurring. While the input is active no scheduled runs will occur. If the input is active when a schedule run is called for, and is removed during the running period the gen-set will start and complete any remaining scheduled running time.

### **19 RESERVED**

### **20 TRANSFER TO GENERATOR/OPEN MAINS**

This input is used to transfer the load to the generator when in Manual mode.

### **21 TRANSFER TO MAINS/OPEN GENERATOR**

This input is used to transfer the load to the mains supply when in Manual mode.

### **22 REMOTE INHIBIT**

In AUTO mode, if one of the configurable inputs are selected as 22 (Remote Inhibit) and this input is active, the module will inhibit the generator for starting. In the other hand, if this input is active while the generator was starting, the module will stop the generator.

### **23 BEING FOUND ALIVE**

When this input is active, controlling the engine remotely is not possible.

### **24 LOW BATTERY**

If this input is active when the unit is in AUTO mode and if mains is not okay, the unit will perform the start sequence and transfer load to the generator.

### **25 EMERGENCY STOP (FOR CONFIGURABLE INPUT-1)**

This input is used as the emergency stop input.

### **25 LOW OIL PRESSURE (FOR CONFIGURABLE INPUT-4)**

This input is used as the oil pressure failure input. It will be checked while starting or stopping attempts.

### **25 HIGH TEMPERATURE (FOR CONFIGURABLE INPUT-5)**

This input is used as the temperature failure input.

### **26-LOW OIL LEVEL (FOR CONFIGURABLE INPUT-4)**

This input is used as the oil pressure failure input. It won't be checked while starting or stopping attempts.

### **26 EMERGENCY STOP NO-LATCHING (FOR CONFIGURABLE INPUT-1)**

This input is used as the non-latching emergency stop input.

## 4.2.6 Outputs

CONF. OUTPUT-1 ( <i>Outputs-&gt;Conf. output-1</i> )		Min	Max	Default	Unit
<b>Polarity</b>	0- Normally Open (Close To Activate) 1- Normally Close (Open To Activate)	0	1	0	
<b>Function</b>	0-NOT USED 1-AIR FLAP CONTROL 2-ALARM RESET 3-AUDIBLE ALARM 4-AUTO START INHIBIT 5-AUXILIARY MAINS FAILURE 6-BATTERY HIGH VOLTAGE 7-BATTERY LOW VOLTAGE 8-CALLING FOR SCHEDULED RUN(EXERCISE) 9-CAN ECU POWER(only available at Trans-MidiAMF.CAN) 10-CAN ECU STOP(only available at Trans-MidiAMF.CAN) 11-CHARGE ALTERNATOR FAILURE 12-COMMON ALARM 13-COMMON ELECTRICAL TRIP ALARM 14-COMMON SHUTDOWN ALARM 15-COMMON WARNING ALARM 16-COOLING FAN AFTER START 17-COOLING FAN AFTER STOP 18-COOLANT TEMPERATURE HIGH PRE-ALARM 19-COOLANT TEMPERATURE HIGH SHUTDOWN 20-COOLING DOWN TIMER IN PROGRESS 21-CRANK RELAY ENERGISED 22-DELAYED ALARMS ACTIVE 23-DIGITAL INPUT1 ALARM 24-DIGITAL INPUT2 ALARM 25-DIGITAL INPUT3 ALARM 26-DIGITAL INPUT4 ALARM 27-DIGITAL INPUT5 ALARM 28-RESERVED 29-RESERVED 30-RESERVED 31-RESERVED 32-RESERVED 33-RESERVED 34-RESERVED 35-RESERVED 36-RESERVED 37-RESERVED 38-RESERVED 39-EMERGENCY STOP 40-FAIL TO START ALARM 41-FAIL TO STOP ALARM 42-CONF.A11 CONTROL 43-FUEL RELAY ENERGISED 44-GAS ENGINE IGNITION OUTPUT 45-GENERATOR AT REST 46-GENERATOR AVAILABLE 47-GENERATOR CLOSED AUXILIARY 48-GENERATOR FAILED TO CLOSE 49-GENERATOR FAILED TO OPEN 50-GENERATOR HIGH FREQUENCY PRE-ALARM 51-GENERATOR HIGH FREQUENCY SHUTDOWN 52-GENERATOR HIGH VOLTAGE PRE-ALARM 53-GENERATOR HIGH VOLTAGE SHUTDOWN 54-GENERATOR LOAD INHIBIT 55-GENERATOR LOW FREQUENCY PRE-ALARM 56-GENERATOR LOW FREQUENCY SHUTDOWN 57-GENERATOR LOW VOLTAGE PRE-ALARM 58-GENERATOR LOW VOLTAGE SHUTDOWN 59-GENERATOR STOPPING 60-GENERATOR OPEN BREAKER 61-HORN OUTPUT LATCHED 62-HORN OUTPUT PULSED 63-LAMP TEST 64-RESERVED 65-LOSS OF MAGNETIC PICK-UP SPEED SIGNAL (only available at Trans-MidiAMF.MPU) 66-LOW TEMPERATURE 67-MAINTENANCE DUE ALARM 68-MAINS CLOSED AUXILIARY 69-MAINS FAILED TO CLOSE 70-MAINS FAILED TO OPEN 71-MAINS FAILURE 72-MAINS HIGH FREQUENCY 73-MAINS HIGH VOLTAGE 74-MAINS LOAD INHIBIT 75-MAINS LOW FREQUENCY 76-MAINS LOW VOLTAGE 77-MAINS OPEN BREAKER 78-NO LOADING COMMAND 79-OIL PRESSURE LOW PRE-ALARM 80-OIL PRESSURE LOW SHUTDOWN 81-CONF.A11.HIGH PREA 82-CONF.A11.HIGH SHUT 83-OVER CURRENT PRE-ALARM 84-OVER CURRENT 85-OVER POWER PRE-ALARM 86-OVER POWER SHUTDOWN 87-OVER SPEED PRE-ALARM 88-OVER SPEED SHUTDOWN 89-PANEL LOCK 90-PRE-HEAT(during preheat timer) 91-PRE-HEAT(untill end of cranking) 92-PRE-HEAT(untill end of warming) 93-PRE-HEAT(untill end safety on) 94-REMOTE START PRESENT 95-REMOTE STOP DELAY IN PROGRESS 96-SHORT CIRCUIT 97-SMOKE LIMITING 98-STARTING ALARM 99-STARTING ALARMS ARMED 100-STOP RELAY ENERGISED 101-SYSTEM IN AUTO MODE 102-SYSTEM IN MANUAL MODE 103-SYSTEM IN STOP MODE 104-SYSTEM IN TEST MODE 105-UNDER CURRENT PRE-ALARM 106-UNDER CURRENT 107-UNDER POWER PRE-ALARM 108-UNDER POWER SHUTDOWN 109-UNDERSPEED PRE-ALARM 110-UNDERSPEED SHUTDOWN 111-WAITING FOR GENERATOR 112-RESERVED 113-LOAD SUPPLY FROM GENERATOR 114-LOAD SUPPLY FROM MAINS 115-CONFIGURABLE ANALOG INPUT 1 LOW PRE-ALARM 116-CONFIGURABLE ANALOG INPUT 1 LOW SHUTDOWN 117-RESERVED 118-RESERVED 119-RESERVED 120-RESERVED 121-CHOKE ACTIVE 122-REMOTE CONTROL ACTIVE 123-REVERSE POWER 124-RESERVED 125-RESERVED 126-RESERVED 127-ATS OPEN(0) 128-HEATER CONTROL 129-REMOTE OUTPUT 130-UNBALANCE LOAD	0	131	43	

<b>CONF. OUTPUT-2 (Outputs-&gt;Conf. output-2)</b>		<b>Min</b>	<b>Max</b>	<b>Default</b>	<b>Unit</b>
<b>Polarity</b>	0- Normally Open (Close To Activate) 1- Normally Close (Open To Activate)	0	1	0	
<b>Function</b>	The same as Configurable Output-1 options	0	131	21	

<b>CONF. OUTPUT-3 (Outputs-&gt;Conf. output-3)</b>		<b>Min</b>	<b>Max</b>	<b>Default</b>	<b>Unit</b>
<b>Polarity</b>	0- Normally Open (Close To Activate) 1- Normally Close (Open To Activate)	0	1	0	
<b>Function</b>	The same as Configurable Output-1 options	0	131	62	

<b>CONF. OUTPUT-4 (Outputs-&gt;Conf. output-4)</b>		<b>Min</b>	<b>Max</b>	<b>Default</b>	<b>Unit</b>
<b>Polarity</b>	0- Normally Open (Close To Activate) 1- Normally Close (Open To Activate)	0	1	0	
<b>Function</b>	The same as Configurable Output-1 options	0	131	9	

<b>CONF. OUTPUT-5 (Outputs-&gt;Conf. output-5)</b>		<b>Min</b>	<b>Max</b>	<b>Default</b>	<b>Unit</b>
<b>Polarity</b>	0- Normally Open (Close To Activate) 1- Normally Close (Open To Activate)	0	1	0	
<b>Function</b>	The same as Configurable Output-1 options	0	131	10	

<b>CONF. OUTPUT-6 (Outputs-&gt;Conf. output-6)</b>		<b>Min</b>	<b>Max</b>	<b>Default</b>	<b>Unit</b>
<b>Polarity</b>	0- Normally Open (Close To Activate) 1- Normally Close (Open To Activate)	0	1	0	
<b>Function</b>	The same as Configurable Output-1 options	0	131	12	

## CONFIGURABLE OUTPUTS SELECTIONS

### 0 NOT USED

Output is not used

### 1 AIR FLAP CONTROL

Normally used to control an air flap, this output becomes active upon an Engine shutdown failure situation. Inactive when the set has come to rest.

### 2 ALARM RESET

The output indicates that an alarm reset being performed. Once the alarm reset has been completed, the output become inactive again. The output could be used to give an external reset signal to external systems.

### 3 AUDIBLE ALARM

The output indicates that the internal sounder is operating. It may be use for external sounder.

### 4 AUTO START INHIBIT

This output indicates that a digital input that has been configured as 'auto start inhibit' is active.

### 5 AUXILIARY MAINS FAILURE

This output indicates that a digital input that has been configured as 'auxiliary mains failure' is active.

### 6 BATTERY HIGH VOLTAGE

This output indicates that a battery high voltage alarm has occurred.

### 7 BATTERY LOW VOLTAGE

This output indicates that a battery low voltage alarm has occurred.

### 8 CALLING FOR SCHEDULED RUN(EXERCISE)(only available at Trans-MidiAMF.CAN)

This output indicates that a scheduled run(exercise) has been called for. If the unit is in the 'auto' and mains okay, the unit will change mode to 'test' and the generator will run if no shutdown alarms are present.

### 9 CAN ECU POWER(only available at Trans-MidiAMF.CAN)

This output normally used to turn on the ECU (sometimes via an external slave relay). Some engine ECUs are permanently powered in which case the ECU Power output is used to give input to a Run (or similarly named) input on the ECU.

## **10 CAN ECU STOP**

This output used to give input to a Stop (or similarly named) input on the ECU. This is used as a backup stop system should the ECU Data link fail. In this instance, it is not possible to stop the engine using a data command as the link is not operative. As a backup, the STOP signal is given to the engine via a separate hardwired connection.

## **11 CHARGE ALTERNATOR FAILURE**

This output indicates that a charging alternator failure has occurred.

## **12 COMMON ALARM**

This output indicates that a warning, electrical trip or shutdown alarm has been activated.

## **13 COMMON ELECTRICAL TRIP ALARM**

This output indicates that an electrical trip alarm has been activated. This output can only be reset by removal of the fault and by then pressing the RESET button.

## **14 COMMON SHUTDOWN ALARM**

This output indicates that a shutdown alarm has been activated. This output can only be reset by removal of the fault and by then pressing the RESET button or by using an external 'alarm reset' input.

## **15 COMMON WARNING ALARM**

This output indicates that a warning alarm has been activated. This output is normally self-resetting on removal of the fault.

## **16 COOLING FAN AFTER START**

This output should energise as soon as engine has started so the fan should be running when the engine is running. This output should continue to operate for Cooling Fan Time parameter after engine has stopped.

## **17 COOLING FAN AFTER STOP**

This output indicates that can be made to energise for Cooling Fan Time parameter after the engine shuts down (to run an electric cooling fan on the radiator).

## **18 COOLANT TEMPERATURE HIGH PRE-ALARM**

This output indicates that a high engine coolant temperature warning (pre-alarm) has occurred.

## **19 COOLANT TEMPERATURE HIGH SHUTDOWN**

This output indicates that a high engine coolant temperature shutdown has occurred.

## **20 COOLING DOWN TIMER IN PROGRESS**

This output source will be active when the cooling off-load timer is running.

## **21 CRANK RELAY ENERGISED**

The output mimics the operation of the crank relay. Can be used to control external logic circuitry.

## **22 DELAYED ALARMS ACTIVE**

The output indicates that the delayed alarms now enabled. Can be used to control external logic circuitry.

## **23 DIGITAL INPUT1 ALARM**

This output indicates that digital input 1 alarm has occurred.

## **24 DIGITAL INPUT2 ALARM**

This output indicates that digital input 2 alarm has occurred.

## **25 DIGITAL INPUT3 ALARM**

This output indicates that digital input 3 alarm has occurred.

## **26 DIGITAL INPUT4 ALARM**

This output indicates that digital input 4 alarm has occurred.

## **27 DIGITAL INPUT5 ALARM**

This output indicates that digital input 5 alarm has occurred.

## **28 RESERVED**

## **29 RESERVED**

## **30 RESERVED**

**31 RESERVED**

**32 RESERVED**

**33 RESERVED**

**34 RESERVED**

**35 RESERVED**

**36 RESERVED**

**37 RESERVED**

**38 RESERVED**

**39 EMERGENCY STOP**

This output indicates that an emergency stop alarm has occurred.

**40 FAIL TO START ALARM**

This output indicates that the engine has not started after the specified number of attempts.

**41 FAIL TO STOP ALARM**

This output indicates that the generator has failed to stop within the selected time

**42 CONFIGURABLE ANALOG INPUT-1 CONTROL**

Becomes active when the Analog Input-1 falls below the "ANALOG INPUT-1 ON" setting. If the output is already active it will become inactive when the Analog Input-1 is above the "ANALOG INPUT-1 OFF" setting.

**43 FUEL RELAY ENERGISED**

The output mimics the operation of the fuel relay. It can be used to control external logic circuitry.

**44 GAS ENGINE IGNITION OUTPUT**

With the engaging of the starter the ignition delay is started. If the 'minimum ignition speed' is reached after expiry of this time, the configurable relay output 'ignition' is set. When the necessary engine shutdown process, firstly gas valve is de-energised. Then ignition output is de-energised that after 5 seconds when the engine speed become lower than 'minimum ignition speed'

**45 GENERATOR AT REST**

The output indicates that the generator is not running.

**46 GENERATOR AVAILABLE**

This output indicates when the generator is ready to accept load, i.e. after safety on and warm up timers have timed out.

**47 GENERATOR CLOSED AUXILIARY**

This output indicates that a digital input that has been configured as 'generator closed auxiliary' is active.

**48 GENERATOR FAILED TO CLOSE**

This output source has intended to be used to indicate a failure of the generator contactor or breaker. It can only be used if the unit is configured to use 'generator closed auxiliary' feedback.

**49 GENERATOR FAILED TO OPEN**

This output source has intended to be used to indicate a failure of the generator contactor or breaker. It can only be used if the unit is configured to use 'generator closed auxiliary' feedback.

**50 GENERATOR HIGH FREQUENCY PRE-ALARM**

This output indicates that a generator high frequency warning (pre-alarm) has occurred.

**51 GENERATOR HIGH FREQUENCY SHUTDOWN**

This output indicates that a generator high frequency shutdown has occurred.

**52 GENERATOR HIGH VOLTAGE PRE-ALARM**

This output indicates that a generator high voltage warning (pre-alarm) has occurred.

**53 GENERATOR HIGH VOLTAGE SHUTDOWN**

This output indicates that a generator high voltage shutdown has occurred.



**54 GENERATOR LOAD INHIBIT**

This output indicates that a digital input has been configured as 'generator load inhibit' is active.

**55 GENERATOR LOW FREQUENCY PRE-ALARM**

This output indicates that a generator low frequency warning (pre-alarm) has occurred.

**56 GENERATOR LOW FREQUENCY SHUTDOWN**

This output indicates that a generator low frequency shutdown has occurred.

**57 GENERATOR LOW VOLTAGE PRE-ALARM**

This output indicates that a generator low voltage warning (pre-alarm) has occurred.

**58 GENERATOR LOW VOLTAGE SHUTDOWN**

This output indicates that a generator low voltage shutdown has occurred.

**59 GENERATOR STOPPING**

This output indicates that the engine has been instructed to stop but has not come to rest.

**60 GENERATOR OPEN BREAKER**

This output used to control the load switching device. For Details see: "BREAKERS Page" section.

**61 HORN OUTPUT LATCHED**

This output indicates that the latched horn alarm has occurred.

**62 HORN OUTPUT PULSED**

This output indicates that the pulsed horn alarm has occurred.

**63 LAMP TEST**

This output indicates that the module is performing a lamp test. Once the lamp test completed, the output will become inactive again. The output can be used to feed a lamp test on external modules or panel lamps.

**64 RESERVED****65 LOSS OF MAGNETIC PICK-UP SPEED SIGNAL(only available at Trans-MidiAMF.MPU)**

This output indicates that the magnetic pick up signal is not sufficient to be used by the unit for speed monitoring. The alarm can only operate if the speed signal fails to appear during cranking. It is disabled if 'multiple attempts to engage' is selected. If the MPU fails during engine running this would result in an under speed alarm.

**66 LOW TEMPERATURE**

This output indicates that a low temperature warning has occurred.

**67 MAINTENANCE DUE ALARM**

This output indicates that the generator is now due for maintenance either because it has used all the available running hours or the periodic maintenance time has expired. To clear the output a maintenance reset must be performed.

**68 MAINS CLOSED AUXILIARY**

This output indicates that a digital input that has been configured as 'mains closed auxiliary' is active.

**69 MAINS FAILED TO CLOSE**

This output source has intended to be used to indicate a failure of the mains contactor or breaker. It can only be used if the unit is configured to use 'mains closed auxiliary' feedback.

**70 MAINS FAILED TO OPEN**

This output source has intended to be used to indicate a failure of the mains contactor or breaker. It can only be used if the unit is configured to use 'mains closed auxiliary' feedback.

**71 MAINS FAILURE**

This output indicates that the unit has sensed that a failure of the incoming AC mains supply. This output will become active whenever the mains voltage or frequency goes out of limits, or if the auxiliary mains failure input active (if used) and the mains transient timer has expired.

**72 MAINS HIGH FREQUENCY**

This output indicates that the unit has sensed that the incoming AC mains supply frequency has exceeded the frequency limit setting.

**73 MAINS HIGH VOLTAGE**

This output indicates that the unit has sensed that the incoming AC mains supply voltage has exceeded the voltage limit setting.

**74 MAINS LOAD INHIBIT**

This output indicates that a digital input has been configured as 'mains load inhibit' is active.

**75 MAINS LOW FREQUENCY**

This output indicates that the unit has sensed that the incoming AC mains supply frequency has fallen below the frequency setting.

**76 MAINS LOW VOLTAGE**

This output indicates that the unit has sensed that the incoming AC mains supply voltage has fallen below the voltage limit setting.

**77 MAINS OPEN BREAKER**

This output used to control the load switching device. For Details see: "BREAKERS Page" section.

**78 NO LOADING COMMAND**

This output indicates that the unit is not calling of the generator contactor or breaker to be closed. Should the unit close the generator contactor this output will become inactive.

**79 OIL PRESSURE LOW PRE-ALARM**

This output indicates that a low oil pressure warning (pre-alarm) has occurred.

**80 OIL PRESSURE LOW SHUTDOWN**

This output indicates that a low oil pressure shutdown has occurred.

**81 CONFIGURABLE ANALOG INPUT-1 HIGH PRE-ALARM**

This output indicates that a high analog input-1 warning (pre-alarm) has occurred.

**82 CONFIGURABLE ANALOG INPUT-1 HIGH SHUTDOWN**

This output indicates that a high analog input-1 shutdown has occurred.

**83 OVER CURRENT PRE-ALARM**

This output indicates that the over current pre-alarm has been reached.

**84 OVER CURRENT ALARM**

This output indicates that the over current trip level has been reached.

**85 OVER POWER PRE-ALARM**

This output indicates that the over power pre-alarm has been reached.

**86 OVER POWER SHUTDOWN**

This output indicates that the over power shutdown has been reached.

**87 OVER SPEED PRE-ALARM**

This output indicates that the over speed warning (pre-alarm) has occurred.

**88 OVER SPEED SHUTDOWN**

This output indicates that the over speed shutdown has occurred.

**89 PANEL LOCK**

This output indicates that the unit 'panel lock' is active. If the panel lock input is active, the unit will not respond to operation of the Mode select or start buttons. This allows the unit to be placed into a specific mode (such as auto) and then secured.

**90 PRE-HEAT(during preheat timer)**

The output controls the pre-heater. Pre-heat output is available for the duration of pre-heat timer, which terminates prior to cranking.

**91 PRE-HEAT(until end of cranking)**

The output controls the pre-heater. As 'Pre-heat (during pre-heat timer)' mode but pre-heat is also available during cranking.

**92 PRE-HEAT(until end of warming)**

The output controls the pre-heater. As 'Pre-heat (until safety on)' but pre-heat continues to be available until the warm-up timer has elapsed.

**93 PRE-HEAT(until end safety on)**

The output controls the pre-heater. As 'Pre-heat (until end of cranking)' but pre-heat is also available while waiting for the delayed alarms to become active.

**94 REMOTE START PRESENT**

This output indicates that a digital input that has been configured as 'remote start' is active. This output could be used to pass the remote start signal on to else where in the control system.

**95 REMOTE STOP DELAY IN PROGRESS**

This output source will be active to indicate that the return timer is running.

**96 SHORT CIRCUIT**

This output indicates that the module has detected a short circuit on the generator output.

**97 SMOKE LIMITING**

This output is used to supply a smoke-limiting signal to an Electronic Governor to limit smoke emissions on start-up. It is used in conjunction with the Smoke limit timer (Idle mode timer) settings. Once the timer has expired, the Smoke limit output will cease to operate allowing the engine to accelerate to normal running speed.

**98 STARTING ALARM**

This output is used to supply an external sounder with a signal that the engine is about to start. The output will be active during the start delay and pre-heat timer (if used).

**99 STARTING ALARMS ARMED**

The output indicates that the starting alarms are now enabled. It can be used to control external logic circuitry. Starting alarms are armed as soon as the unit commences starting of the engine and remain armed until the engine at rest.

**100 STOP RELAY ENERGISED**

The output mimics the operation of the stop relay. Can be used to control external logic circuitry.

**101 SYSTEM IN AUTO MODE**

The output indicates that the unit is in the Auto mode.

**102 SYSTEM IN MANUAL MODE**

The output indicates that the unit is in the Manual mode.

**103 SYSTEM IN STOP MODE**

The output indicates that the unit is in the Stop mode.

**104 SYSTEM IN TEST MODE**

The output indicates that the unit is in the Test mode.

**105 UNDER CURRENT PRE-ALARM**

This output indicates that the under current pre-alarm has been reached.

**106 UNDER CURRENT ALARM**

This output indicates that the under current trip level has been reached.

**107 UNDER POWER PRE-ALARM**

This output indicates that the under power pre-alarm has been reached.

**108 UNDER POWER SHUTDOWN**

This output indicates that the under power shutdown has been reached.

**109 UNDER SPEED PRE-ALARM**

This output indicates that an under speed warning (pre-alarm) has occurred.

**110 UNDER SPEED SHUTDOWN**

This output indicates that an under speed shutdown has occurred.

**111 WAITING FOR GENERATOR**

This output indicates that the engine has been instructed to start but has not yet become available. Once the generator becomes available this output will be in-active.

**112 RESERVED****113 LOAD SUPPLY FROM GENERATOR**

This output indicates that the load is supplying from generator.

**114 LOAD SUPPLY FROM MAINS**

This output indicates that the load is supplying from mains.

**115 CONFIGURABLE ANALOG INPUT-1 LOW PRE-ALARM**

This output indicates that a low configurable analog input-1 warning (pre-alarm) has occurred.

**116 CONFIGURABLE ANALOG INPUT-1 LOW SHUTDOWN**

This output indicates that a low analog input-1 shutdown has occurred.

**117 RESERVED****118 RESERVED****119 RESERVED****120 RESERVED****121 CHOKE ACTIVE**

This output becomes active everytime generator cranks and stays active until the choke time expires.

**122 REMOTE CONTROL ACTIVE**

This output indicates that the engine is being controlled remotely.

**123 REVERSE POWER**

This output becomes active when generator's active power drops below the Reverse Power Set value.

**124 RESERVED****125 RESERVED****126 RESERVED****127-ATS OPEN(0)**

This output is used to return the ATS to the "Open (0)" position.

**128 HEATER CONTROL**

Becomes active when the Coolant Temperature falls below the "Heater control ON" setting. If the output is already active it will become inactive when the Coolant Temperature is above the "Heater control OFF" setting.

**129 REMOTE OUTPUT**

This output indicates that the output can be energised or de-energised remotely.

**130 UNBALANCE LOAD**

This output indicates "out of balance" current loading of the generator. Sometimes also called Negative Sequence Current or Symmetry Fault.

**131 WATER PUMP**

This output becomes active for the "Water pump on time" parameter and passive for the "Water pump off time" parameter while the "Heater control output" was active.

## 4.2.7 Timers

<b>START TIMERS (<i>Timers-&gt;Start timers</i>)</b>		<b>Min</b>	<b>Max</b>	<b>Default</b>	<b>Unit</b>
<b>Mains transient delay</b>	Mains Transient Delay	0.0	20.0	2.0	Sec
<b>Mains fail start delay</b>	Mains Fail Start Delay	0	9999	0	Sec
<b>Remote start delay</b>	Remote Start Delay	0	3600	4	Sec
<b>Pre-heat</b>	Pre-Heat	0	250	3	Sec
<b>Pre-heat bypass</b>	Pre-Heat Bypass	0	250	0	Min
<b>Safety on delay</b>	Safety On Delay	0	99	5	Sec
<b>Warming up time</b>	Warmup Time	0	250	3	Sec
<b>Horn duration</b>	Horn Duration	0 (dis)	999	60	Sec
<b>Chg. excitation time</b>	Charge Excitation Time	0	99(cont)	15	Sec
<b>Cooling fan time</b>	Cooling Fan Time	0	250	180	Sec
<b>Idle mode time</b>	Idle Mode Time (Smoke Limiting)	0 (dis)	3600	dis	Sec
<b>Idle mode time off</b>	Idle Mode Time Off (Smoke Limiting Off)	0	250	5	Sec

### **Mains Transient Delay**

The unit uses this parameter to decide the mains fail.

### **Mains Fail Start Delay**

This timer dictates how long the unit will wait after it has received a mains failure signal before it will attempt to start. This prevent un-necessary starting on a fluctuating mains supply etc.

### **Remote Start Delay**

This timer dictates how long the unit will wait after it has received a remote start signal before it will attempt to start. This prevent un-necessary starting on a fluctuating mains supply etc.

### **Pre-Heat**

This timer dictates the duration that the pre-heat output will be active before an attempt is made to start the engine. Once this timer is expired cranking will commence.

### **Pre-Heat Bypass**

This feature allows the unit to start a hot engine without performing an un-necessary pre-heat delay. The bypass timer is triggered by the generator starting and actually being loaded. If the generator started but does not achieve loading then the timer will not be triggered. The bypass timer is initiated once the engine has come to rest. If any attempts to start are requested within the duration of the bypass timer the start sequence will bypass the pre-heat timer.

### **Safety On Delay**

This timer dictates how long the unit will ignore the Low Oil Pressure, High Engine Temperature, Underspeed, Undervolts and any other inputs configured as active from safety on. It allows the values such as oil pressure to rise to their operating values on starting without triggering an alarm. Once the timer has expired all alarm conditions are monitored again. If configured to use 'fast loading', should all the monitored conditions, such as oil pressure, come to expected state prior to the end of the safety on timer, the timer will be terminated prematurely ensuring maximum protection as soon as possible.

### **Warmup Time**

This timer is initiated once the engine is up and running. It delays loading the generator until it has stabilised. Once this timer is expired the 'Close generator' signal will be given and the generator is available to be loaded.

### **Horn Duration**

This timer dictates how long the external horn and the internal sounder will work after the last error detected. Once after this timer ended unit will do the external horn and the internal sounder reset.

### **Charge Excitation Time**

Charge excitation was selectable as momentary / continuous operation. This timer dictates how long the Charge excitation will active.

**Note:** dis = disable                      cont = continuous

### Cooling Fan Time

This timer dictates how long the Cooling Fan will continue to operate.

### Idle Mode Time (Smoke Limiting)

This is the amount of time that the smoke limiting output will remain active for once the engine has started. While the smoke limiting output is active the engine will be held at a reduced speed to minimise smoke emissions on start-up. (Only if fitted with an appropriate Electronic Control Module). Once the timer has expired the engine will be allowed to accelerate up to its normal operating speed.

### Idle Mode Time Off (Smoke Limiting Off)

This timer is started after the Idle mode timer (smoke limit timer) was expired. This is to allow the engine to accelerate to its normal running speed without triggering an underspeed alarm, etc.

<b>STOPPING TIMERS (<i>Timers-&gt;Stopping timers</i>)</b>		<b>Min</b>	<b>Max</b>	<b>Default</b>	<b>Unit</b>
<b>Mains return delay</b>	Mains Return Delay	0	3600	5	Sec
<b>Remote stop delay</b>	Remote Stop Delay	0	250	4	Sec
<b>Cooling time</b>	Cooling Time	0 (dis)	3600	60	Sec
<b>Fail to stop delay</b>	Fail To Stop Time	15	999	30	Sec
<b>Battery charging time</b>	Battery Charging Time	1	9999	5	Min
<b>Engine stopping delay</b>	Engine stopping delay	0	999	0	Sec

### Mains Return Delay

This timer dictates how long the unit will wait before it will un-load the generator (back to the mains supply if AMF) and initialise it's run-on and shutdown cycle. This is ensure that the mains supply has stabilised before transferring the load back to mains.

### Remote Stop Delay

This timer dictates how long the unit will wait after it has received a remote stop signal before it will attempt to stop. This prevent un-necessary stopping on a fluctuating mains supply etc.

### Cooling Timer

This is the time the generator is to run off-load once the load transfer signal has ceased. This gives the engine time to cool down before shutdown.

### Fail To Stop Time

Once the unit has given a shutdown signal to the engine it expects the engine to come to rest. It monitors the Oil pressure and speed sensing sources and if they still indicate engine movement when this timer expires a 'Fail To Stop' alarm signal is generated.

### Battery Charging Time

In AUTO mode and no mains, if one of the configurable inputs are selected as "24-Low Battery" and this input is active, the unit will perform the start sequence. When the mains back or "Battery Charging Time" parameter is expired, the unit will perform the stop sequence.

### Engine stopping delay

When a shutdown alarm occurs, the engine stop sequence is delayed by the value in this parameter. Typically this is used parameter to make sure that the ATS has returned to the "Open (0)" position before the engine stops.

**Note:** dis = disable

GPRS module should not be mounted or dismounted, when device is energized!!!

## 4.2.8 Expansion Modules

GPRS MODULE ( <i>Expansion modules-&gt;GPRS</i> )		Min	Max	Default	Unit
Disable/enable select	Expansion GPRS Module Selection	0-DISABLE 1-GPRS SERVER 2-GPRS CLIENT 3-SMS		1-GPRS SERVER	
Call back selection	Call Back Selection	ENABL/DISBL		DISBL	
Cell inf refresh rate	Cell info refresh rate	0(dis)	999	2	Min
Location data	Location data	ENABL/DISBL		DISBL	
Location warning	Location warning	1(dis)	999	1(dis)	Km

## 4.2.9 Synchronization

SYNCH CHECK ( <i>Synchronization-&gt;Synch Check</i> )		Min	Max	Default	Unit
Synchronization check	Synchronization check enable/disable	ENABL/DISBL		DISBL	
Synced working time	Synced working time	0.0	25.0	0.5	Sec
Synch. fail time	Synchronization fail time	0	250	30	Sec
Max voltage diff.	Max voltage difference	0	20	5	V <sub>~</sub>
Voltage type	Voltage type	0=Ph-N / 1=Ph-Ph		0=Ph-N	
Max frequency diff.	Max frequency difference	0.0	2.0	0.5	Hz
Max angle difference	Max angle difference	0	20	10	°
Angle offset	Angle offset	-60	+60	0	°

### Synchronization check

You can enable/disable synchronized uninterrupted load transfer .

### Synced working time

During this timer, both contactors will be active.

### Synch. fail time

When this timer is expired, if the Generator L1 and Mains L1 voltages are still not synchronized; the unit gives synchronization error and performs interrupted load transfer.

### Maximum voltage differences

Synchronization limit value. During synchronization process, difference between average Generator voltage and average Mains voltage must be in the limit.

### Voltage type

With this parameter you can select voltage difference type to be calculated.

0= Average Ph-N voltage

1= Average Ph-Ph voltage

### Maximum frequency differences

Synchronization limit value. During synchronization process, frequency difference between Generator and Mains voltages must be in the limit.

### Maximum angle differences

Synchronization limit value. During synchronization process, angle difference between Generator L1 and Mains L1 must be in the limit.

### Angle offset

With this parameter you can give offset to angle difference between Generator L1 and Mains L1 voltages.



## 4.2.10 User Adjustment

<b>MAINS VOLTAGE OFFSET (User adjustment-&gt;Mains voltage offset)</b>		<b>Min</b>	<b>Max</b>	<b>Default</b>	<b>Unit</b>
<b>Mains V1 offset</b>	Mains V1 Offset	-20	20	0	V $\sim$
<b>Mains V2 offset</b>	Mains V2 Offset	-20	20	0	V $\sim$
<b>Mains V3 offset</b>	Mains V3 Offset	-20	20	0	V $\sim$

<b>GEN. VOLTAGE OFFSET (User adjustment-&gt;Gen. voltage offset)</b>		<b>Min</b>	<b>Max</b>	<b>Default</b>	<b>Unit</b>
<b>Gen. V1 offset</b>	Generator V1 Offset	-20	20	0	V $\sim$
<b>Gen. V2 offset</b>	Generator V2 Offset	-20	20	0	V $\sim$
<b>Gen. V3 offset</b>	Generator V3 Offset	-20	20	0	V $\sim$

<b>CURRENT OFFSET (User adjustment-&gt;Current offset)</b>		<b>Min</b>	<b>Max</b>	<b>Default</b>	<b>Unit</b>
<b>Current I1 offset</b>	Current I1 Offset	-20	20	0	A $\sim$
<b>Current I2 offset</b>	Current I2 Offset	-20	20	0	A $\sim$
<b>Current I3 offset</b>	Current I3 Offset	-20	20	0	A $\sim$

<b>BATTERY&amp;CHRG GEN.VOL (User adjustment-&gt;Battery&amp;chrg gen.vol)</b>		<b>Min</b>	<b>Max</b>	<b>Default</b>	<b>Unit</b>
<b>Batt.volt offset</b>	Battery Voltage Offset	-5.0	5.0	0	V $\text{---}$
<b>Gen.chg.volt offset</b>	Charge Generator Voltage Offset	-5.0	5.0	0	V $\text{---}$

<b>SENDER INPUTS OFFSET (User adjustment-&gt;Sender inputs offset)</b>		<b>Min</b>	<b>Max</b>	<b>Default</b>	<b>Unit</b>
<b>Oil Pressure offset</b>	Oil Pressure Offset	-2.0	2.0	0.0	BAR
<b>Temperature offset</b>	Coolant Temperature Offset	-20	20	0	°C
<b>Conf. AI1 offset</b>	Configurable Analog Input-1 Offset	-200	200	0	%



## Error Messages And Explanations:

Battery high error! : Battery high error  
Battery low error! : Battery low error  
Battery high warning! : Battery high error  
Battery low warning! : Battery low error  
Can bus warning! : Can bus error (only available at Trans-MidiAMF.CAN)  
Charge alterntr fail! : Charge alternator fail  
Communication error!: Master device communication error  
Conf. AI1 high error! : Configurable analogue input-1 high error  
Conf. AI1 high preal! : Configurable analogue input-1 high pre-alarm  
Conf. AI1 low error! : Configurable analogue input-1 low error  
Conf. AI1 low prealr! : Configurable analogue input-1 low pre-alarm  
Conf. AI1 sensor err! : Configurable analogue input-1 sensor break  
Emergency stop! : Emergency stop error  
Fail to start alarm! : Fail to start alarm  
Gen break.close fail! : Generator breaker not closed alarm  
Gen break.open fail! : Generator breaker not opened alarm  
Gen over frq.prealr! : Generator over frequency pre-alarm  
Gen over frq.shutdwn! : Generator over frequency shutdown  
Gen over vol.shutdwn! : Generator over voltage shutdown  
Gen over volt.prealr! : Generator over voltage prealarm  
Gen phase seq.wrong! : Generator phase sequence wrong  
Gen stop fail! : Generator stop error  
Gen under frq.prealr! : Generator under frequency pre-alarm  
Gen under frq.shtdwn! : Generator under frequency shutdown  
Gen under vol.shtdwn! : Generator under voltage shutdown  
Gen under volt.preal! : Generator under voltage pre-alarm  
High temp.prealarm! : Temp pre-alarm  
High temp.shutdown! : High temp. shutdown  
J1939 ECU warning! : Amber warning lamp error (only available at Trans-MidiAMF.CAN)  
Low temperature! : Low temperature  
Mains break.cls fail! : Mains breaker not closed alarm  
Mains break.opn fail! : Mains breaker not opened alarm  
Mains phase seq. err! : Mains phase sequence error  
Maintenance alarm! : Maintenance error  
Oil press.shutdown! : Pressure shutdown  
Over curr.trip cool.! : Over current electrical trip  
Over current prealr! : Over current pre-alarm  
Over current trip! : Over current error  
Over current warnng! : Over current warning  
Over power alarm! : Under power error  
Over power prealarm! : Under power pre-alarm  
Over power trip cool! : Over power electrical trip  
Over power warning! : Over power warning  
Over speed alarm! : Over speed error  
Over speed prealarm! : Over speed pre-alarm  
Pressure prealarm! : Pressure prealarm  
Pressure sensor err! : Oil pressure sensor break  
Red stop lamp! : Red stop lamp error (only available at Trans-MidiAMF.CAN)  
Reverse power warnng! : Reverse power Warning  
Rev.power trip cool.! : Reverse power Electrical Trip  
Reverse power trip! : Reverse power Error  
Short circuit trip! : Short circuit error  
Spare-1 alarm! : Spare 1 error  
Spare-2 alarm! : Spare 2 error  
Spare-3 alarm! : Spare 3 error  
Spare-4 alarm! : Spare 4 error  
Spare-5 alarm! : Spare 5 error  
Speed loss alarm! : Speed loss error (only available at Trans-MidiAMF.MPU)  
Temperat. sensor err! : Temperature sensor break  
Unbalance load trip! : Unbalance load error  
Unbal.load trip cool! : Unbalance load electrical trip  
Unbalance load warn.! : Unbalance load warning  
Under curr.trip cool! : Under current electrical trip  
Under current prealr! : Under current pre-alarm  
Under current trip! : Under Current error

## **Error Messages And Explanations:**

Under current warnng! : Under Current Warning  
Under power prealarm! : Under power prealarm  
Under power trip! : Under power error  
Under pow.trip cool! : Under power electrical trip  
Under power warning! : Under power warning  
Under speed prealarm! : Under speed prealarm  
Under speed trip! : Under speed error

## **Event Messages And Explanations:**

Battery high alarm : Battery high error  
Battery low alarm : Battery low error  
Can bus warning : Can bus error (only available at Trans-MidiAMF.CAN)  
Changed mode to auto : Changed mode to auto  
Changed mode to man : Changed mode to manual  
Changed mode to stop : Changed mode to off  
Changed mode to test : Changed mode to test  
Charge alternter fail : Charge alternator fail  
Conf. AI1 high error : Configurable analogue input-1 high error  
Conf. AI1 high preal : Configurable analogue input-1 high pre-alarm  
Conf. AI1 low error : Configurable analogue input-1 low error  
Conf. AI1 low prealr : Configurable analogue input-1 low pre-alarm  
Conf. AI1 sensor err : Configurable analogue input-1 sensor break  
Emergency stop : Emergency stop error  
Engine started  
Engine stopped  
Fail to start alarm : Fail to start alarm  
Gen break.close fail : Generator breaker not closed alarm  
Gen break.open fail : Generator breaker not opened alarm  
Gen over frq.prealr : Generator over frequency pre-alarm  
Gen over frq.shutdwn : Generator over frequency shutdown  
Gen over vol.prealr : Generator over voltage pre-alarm  
Gen over vol.shutdwn : Generator over voltage shutdown  
Gen phase seq.wrong : Generator phase sequence wrong  
Gen stop fail : Generator stop error  
Gen under frq.preal : Generator under frequency pre-alarm  
Gen under frq.shtdwn : Generator under frequency shutdown  
Gen under vol.preal : Generator under voltage pre-alarm  
Gen under vol.shtdwn : Generator under voltage shutdown  
GPRS IP not found : Gprs no IP alarm  
GPRS reset fail : Gprs reset fail  
High temp.prealarm : High temp. pre-alarm  
High temp.shutdown : High temp. shutdown  
J1939 ECU warning : Amber warning lamp error  
Low temperature : Low temperature (only available at Trans-MidiAMF.CAN)  
Mains break.cls fail : Mains breaker not closed alarm  
Mains break.opn fail : Mains breaker not opened alarm  
Mains phase seq. err : Mains phase sequence error  
Maintenance alarm : Maintenance error  
Maintenance warning : Maintenance warning  
Modem response: error : Gprs error response alarm  
No respons.from modem : Gprs no response alarm  
Oil press.shutdown : Pressure shutdown  
Over current alarm : Over current alarm  
Over current prealr : Over current pre-alarm  
Over power alarm : Under power error  
Over power prealarm : Under power pre-alarm  
Over speed prealarm : Over speed pre-alarm  
Over speed shutdown : Over speed shutdown  
Pressure prealarm : Pressure prealarm  
Pressure sensor err : Oil pressure sensor break  
Red stop lamp : Red stop lamp error (only available at Trans-MidiAMF.CAN)  
Reverse power alarm : Reverse power alarm  
Short circuit alarm : Short circuit alarm  
SMS was not sent : Sms wasn't sent

## Event Messages And Explanations:

SMS was sent : Sms was successfully sent

Spare-1 alarm : Spare 1 error

Spare-2 alarm : Spare 2 error

Spare-3 alarm : Spare 3 error

Spare-4 alarm : Spare 4 error

Spare-5 alarm : Spare 5 error

Speed loss alarm : Magnetic pickup loss f speed error (only available at Trans-MidiAMF.MPU)

Temperat. sensor err : Temperature sensor break

Unbalance load alarm : Unbalance load alarm

Under current alarm : Under current error

Under current prealr : Under current pre-alarm

Under power alarm : Under power error

Under power prealarm : Under power pre-alarm

Under speed prealarm : Under speed pre-alarm

Under speed shutdown : Under speed shutdown

## 5. Specifications

<b>Equipment use</b>	: Electrical control equipment for generating sets.
<b>Housing &amp; Mounting</b>	: 158 mm x 111 mm x 67 mm. (including connectors). Plastic housing for panel mounting.
<b>Panel Cut-Out</b>	: 120mm x 94mm.
<b>Protection</b>	: IP65 at front panel.
<b>Weight</b>	: Approximately 0,26 Kg.
<b>Environmental rating</b>	: Standard, indoor at an altitude of less then 2000 meters with non-condensing humidity.
<b>Operating/Storage Temperature</b>	: -20°C to +70°C / -30°C to +80°C
<b>Operating/Storage Humidity</b>	: 95 % max. (Non-condensing)
<b>Vibration</b>	: EN 60068-2-6 Ten sweeps in each of three major axes 5Hz to 8Hz @ +/-7.5mm, 8Hz to 500Hz @ 2gn.
<b>Shock</b>	: EN 60068-2-27 Three shocks in each of three major axes 15gn in 11mS.
<b>Installation Over Volt. Category</b>	: II Appliances, portable equipment
<b>Pollution Degree</b>	: II, Normal office or workplace, non conductive pollution
<b>Mode of Operation</b>	: Continuous.
<b>DC Battery Supply Voltage</b>	: 8 to 32 V <sub>DC</sub> (Peak: 36V <sub>DC</sub> ). Max. Operating current is 370 mA
<b>Cranking Dropouts</b>	: Battery voltage can be "0" VDC for max. 50 ms during cranking (battery voltage should be at least nominal voltage before cranking).
<b>Battery Voltage Measurement</b>	: 8 to 32 V <sub>DC</sub> , accuracy: 1 % FS, resolution: 0,1 V
<b>Mains Voltage Measurement</b>	: 3 to 300 VAC Ph-N, 5 to 99.9 Hz. Accuracy: 1 % FS, Resolution: 1 V.
<b>Mains Frequency</b>	: 5 to 99.9Hz (min. 20 VAC Ph-N) Accuracy: 0,25 % FS, Resolution: 0,1 Hz.
<b>Generator Voltage Measurement</b>	: 3 to 300 VAC Ph-N, 5 to 99.9 Hz. Accuracy: 1 % FS, Resolution: 1 V.
<b>Generator Frequency</b>	: 5 to 99.9Hz (min. 20 VAC Ph-N) Accuracy: 0,25 % FS, Resolution: 0,1 Hz.
<b>Magnetic Pickup Input</b>	: 35 to 10000 Hz (1 to 35 volts peak continuously). Accuracy: 0,25 % FS.(Only available at Trans-MidiAMF.MPU devices)
<b>CT secondary</b>	: 5A.
<b>Charge Generator Excitation</b>	: 210mA @12V, 105mA @24V. Nominal 2.5W.
<b>Charge Gen. Vol. Measurement</b>	: 8 to 32 V <sub>DC</sub> , accuracy: 1 % FS, resolution: 0,1 V.
<b>Sender Measurement</b>	: 0 to 1300 ohm, accuracy: 1 % FS, resolution: 1 ohm.
<b>Communication interface</b>	: RS-232 communication port, RS-485 (optional), CanBus communication with 1939 ECU (optional).
<b>Optional Comm. Modules</b>	: GSM/GPRS/GPS.
<b>Relay Outputs</b>	: Generator contactor relay output 8A@250V <sub>AC</sub> Mains contactor relay output 8A@250V <sub>AC</sub>
<b>Transistor Outputs</b>	: Fuel or Configurable output-1 1A at DC supply voltage Crank or Configurable output-2 1A at DC supply voltage Configurable output-3 1A at DC supply voltage Configurable output-4 1A at DC supply voltage Configurable output-5 1A at DC supply voltage Configurable output-6 1A at DC supply voltage All transistor outputs supplied from DC supply terminal 19
<b>Approvals</b>	: EAC , CE

## 6. Other Informations

### **Manufacturer Information:**

Emko Elektronik Sanayi ve Ticaret A.Ş.  
Demirtaş Organize Sanayi Bölgesi Karanfil Sk. No:6 16369  
BURSA/TURKEY

Phone : +90 224 261 1900  
Fax : +90 224 261 1912

### **Repair and maintenance service information:**

Emko Elektronik Sanayi ve Ticaret A.Ş.  
Demirtaş Organize Sanayi Bölgesi Karanfil Sk. No:6 16369  
BURSA/TURKEY

Phone : +90 224 261 1900  
Fax : +90 224 261 1912



*Thank you very much for your preference to use Emko Elektronik Products.*

[www.emkoelektronik.com.tr](http://www.emkoelektronik.com.tr)