

WARRANTY

We warrant that the products will be free from defects in material and workmanship for 2 years from the date of bill. The warranty above shall not apply for any failure caused by the use of the product not in line with the instructions reported on this manual.

PACK LIST

Please visual check

- 1 piece of EMO-900 relay output module
- 1 piece of EMO-900 module presenting label

EMO-900 Relay Output Module

Code	: EMO-900 Relay output module
Function	: Relay output
Output rating	: max.5A @ 250 V ~
Dielectric strength	: From device supply to module output _2kV ~ From device ground to module output _2kV ~
Insulation resistance	: From device supply to module output >999,9MΩ From device ground to module output >999,9MΩ
Overall size of the equipment	: 18mm x 75,2mm x 41,4mm
Applicable products	: ESM-9950, ESM-9900, EZM-9950

Module labels

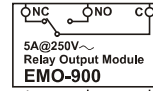

Front side label

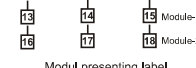

Modul presenting label

Rear side label



! Before the module installation you must read instruction manual of which applicable product.

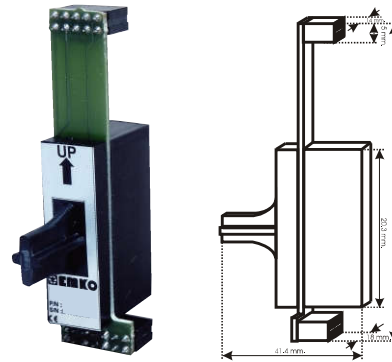

Thank you very much for buying EMKO`s product.



Installing and Pulling Out Input/Output Modules



First, detach all cable connections from the controller and uninstall it from the panel.



Press to the lock pins where top and bottom of the controller.

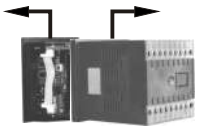

Pull the cover case with your other hand from front panel to rear side.

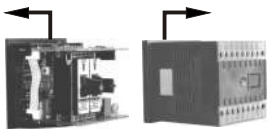

Pull out the cover case from the controller



Slide input/output modules into socket. Pull out the module from its socket, instead of this module install the new one or other module user wants to use.

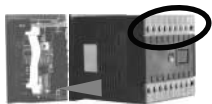

Replace the cover case by taking care of the terminal numbers should be at right orientation.



After adding or changing modules to the unit, these changes must be taken into consideration while mounting of the unit to the system. If mounting is incorrect, it can cause accidents to harm system, operator or person who does the mounting. Responsibility of these kind of harmful events belongs to the user.



After the module installed to the device successfully, please to stick on module presenting label where to participate in the module packet, to suitable module presenting box where on the device label.

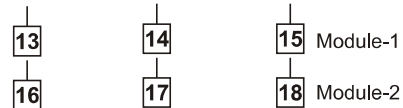
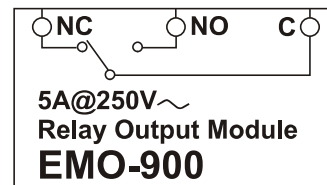
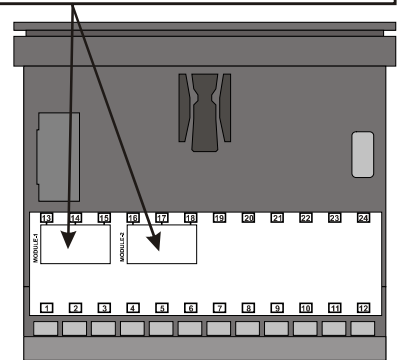

Module presenting label

