

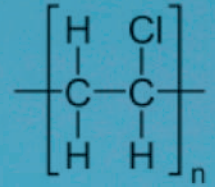

**SAE**  
SOUTH ASIA EXACT

**Flow with Confidence**

— Since 1982 —



# PVC PELLETS

**Polyvinyl chloride**, also known as poly vinyl or vinyl, commonly abbreviated PVC. PVC comes in two basic forms : rigid ( sometimes abbreviated as RPVC ) and flexible. Pure polyvinyl chloride is a white, brittle solid. It is insoluble in alcohol but slightly soluble in tetrahydrofuran.



South Asia Exact (SAE), with over 20 years of experience supplying high quality pipes and fittings specifically for water supply and soil, waste and ventilation (S.W.V.), is one of the leading brand in Malaysia.



SAE pipes and fittings are manufactured at Tasek Industrial Estate, Perak and Balakong, Selangor respectively. We have 2 distinctive brands namely SA for pipes and EXACT for fittings in order to facilitate the learning of the intrinsic quality of SAE products. Through the years, the company has been actively upgrading its technology and production machineries to achieve its objective of improving efficiency, together with product superiority in order to win total customers' confidence and satisfaction.

SAE products are manufactured with stringent quality control. Our effort to continuously improve on quality and reliability over the years has been rewarded with the accreditation of ISO 9001 certification. Our products are also certified to the relevant Malaysia and British standards by SIRIM, the Malaysian standards authority. Along with Ikram and SPAN approval, Malaysian local authorities have approved the use of SAE products in projects under their jurisdiction.

SAE has contributed significantly towards national development over the years. The combined experience and resources of 2 major pipes and fittings manufacturers bring to the market warranty for your S.W.V. and pressure system for all your building and construction needs.

*"The Grass Is Greener Where You Water It."*

草地因您的悉心灌溉而变得绿意盎然。

- Neil Barringham

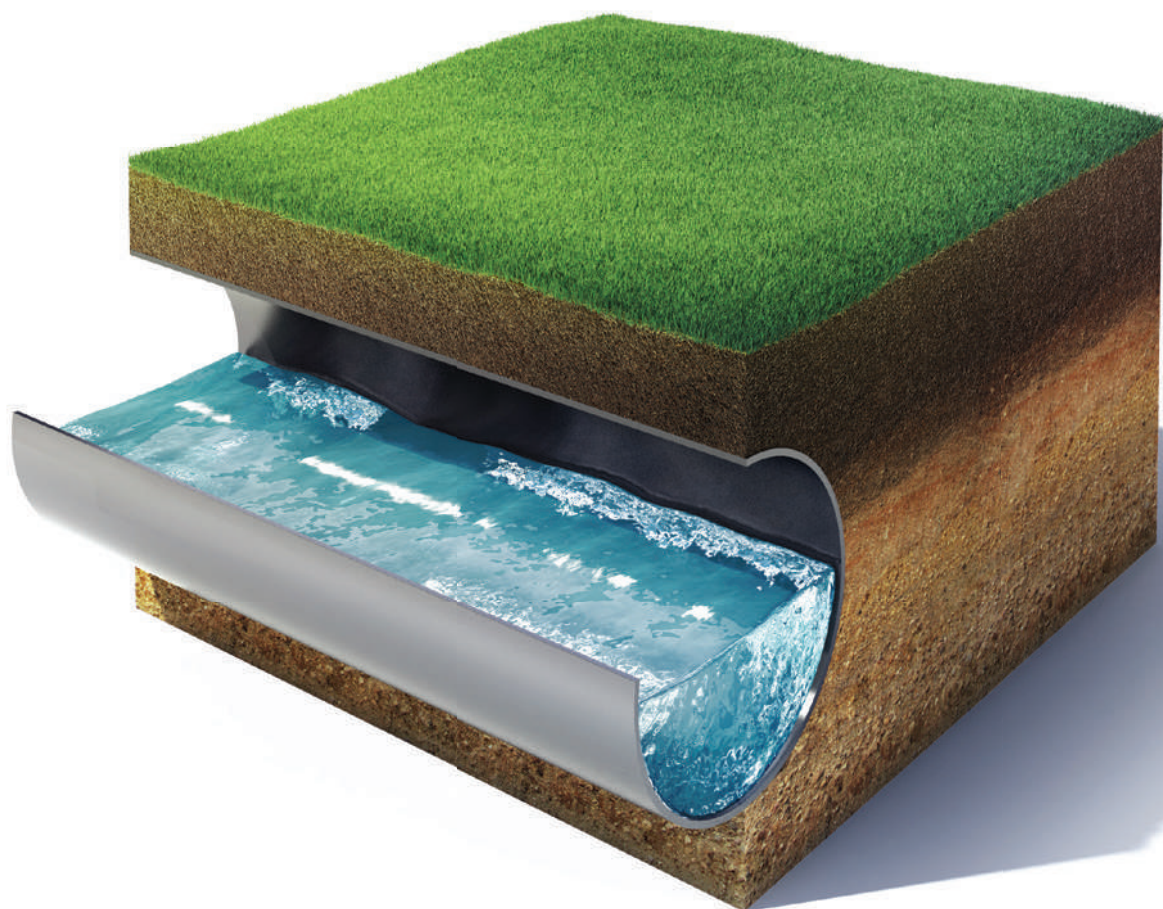

05	Company introduction
09	Physical Properties
12	Quality Control Procedures
13	Installation consideration
16	Storage & Handling
17	Production description
18	Product code
19	Manufacturing Process Flow
20	Product
43	Who is our Clientele
45	Typical soil, waste and vent piping layout for 2 storey house using SAE SWV pipes & fittings
47	Certificate



## COMPANY INTRODUCTION

Early in its history, SAE pipes and fittings were produced under 2 different brands namely SOUTH ASIA for pipes and EXACT for fittings. They were marketed separately by 2 manufacturers from Perak and Selangor respectively in Malaysia.

In early 80s, EXACT had become a leading player in the audio cassette duplication industry. It continued its upstream expansion by investing in plastic injection moulding machinery to produce cassette and Compact Disc (CD) parts and accessories. In 1992, EXACT diversified into manufacturing of uPVC fittings.

SOUTH ASIA, the pipes manufacturer in Perak, focused initially on manufacturing textile fibres, ventured into producing PVC compound before eventually expanded to manufacture uPVC pipes in the early 90s.

Through the years, both manufacturers continued efforts to enhance and optimize its performance to produce PVC pipes and fittings. In 2007, by combining the experience of expertise of both manufacturers, South Asia Exact (SAE) was introduced, now has become one of the nation's leading brand of uPVC complete piping system which is used principally to carry water and wastewater.



1.



2.



3.



4.



1. Injection machines for manufacturing fittings.

2. Handling stock of uPVC fittings.

3. Extrusion machines for manufacturing pipes.

4. Stock checking of uPVC pipes.

5. Measuring dimension of uPVC fittings.

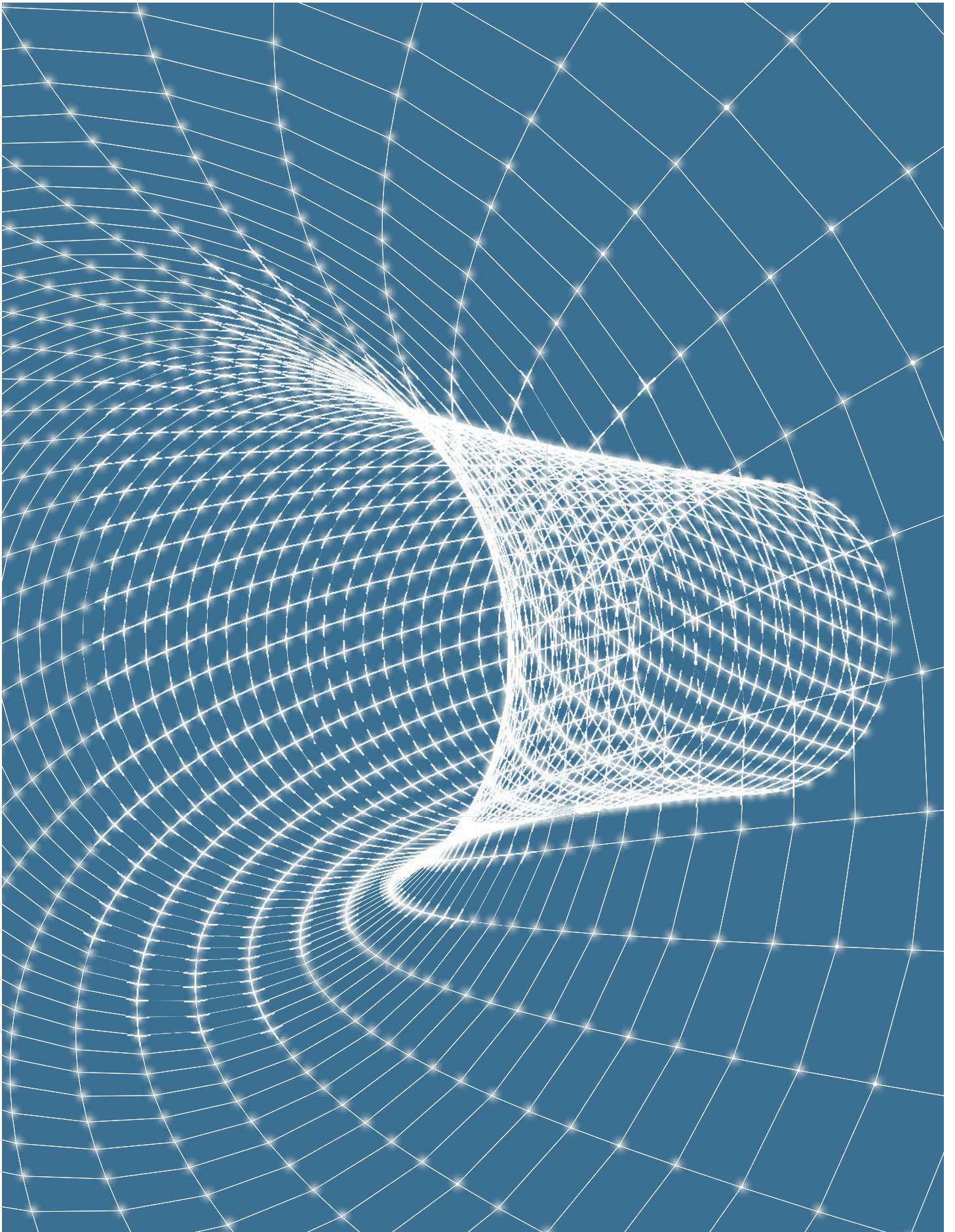

*"For all knowledge and wonder  
(which is the seed of knowledge) is an impression of pleasure in itself."*  
知识是一种快乐，而好奇则是知识的萌芽。

- Francis Bacon 费郎西斯培根



---

## **PHYSICAL PROPERTIES**

*General characteristics*

*Thermal characteristics*

*Chemical resistance*

## **QUALITY CONTROL PROCEDURES INSTALLATION CONSIDERATION**

*Positioning and fixing*

*Joining*

*Inspection and testing*

## **STORAGE AND HANDLING PRODUCT DESCRIPTION PRODUCT CODE MANUFACTURING PROCESS FLOW**

---

## PHYSICAL PROPERTIES

**Unplasticised Polyvinyl Chloride (PVC-U)** is a thermoplastic material which consists of a PVC resin compounded with varying proportions of stabilizers, lubricants, fillers, pigments, and processing aids. A specific formulation of these ingredients is used to obtain desired properties for S.W.V. system in order to meet the requirements of a wide variety of applications and conditions.

**Corrosion resistance** – Sanitary drains generate significant volumes of Hydrogen Sulphide gas from bacterial action, which results in the generation of dilute Sulphuric and sulphurous acids especially in turbulent areas. PVC-u has excellent resistance to Sulphuric Acid.

**Weather Resistance** – SWV pipes and fittings provided long term UV protection when installed above ground.

**Handling / Installation** – The ease of handling, installation and transport provide overall project savings.

**Flexibility** – There is flexibility to cope with water & soil movements, subsidence and expansive clays.

**Superior flow characteristics** – Their very smooth bore and chemical resistance characteristics ensure no scale or built up corrosion, thus producing a high flow capacity.

**Easily Machined / Cut** – It can be cut and machined with simple tools, ready for joints anywhere on the pipe barrel.

**Chemical Resistance** – PVC-u pipe has excellent resistance to a wide range of chemicals at ambient temperatures. PVC should not be used with aldehydes, ethers, aromatics, chlorinated hydrocarbons, ketones, benzene, mixtures or similar solvents.

### 1) GENERAL CHARACTERISTICS

	Units	Value
<b>Physical</b>		
Coefficient of linear expansion	K <sup>-1</sup>	7x 10 <sup>-5</sup>
Density	Kg/m <sup>2</sup>	1.4x 10 <sup>3</sup>
Flammability (Oxygen index)	%	45
Shore hardness		80
Softening point (Vicat - minimum)	°C	Fitting - 76 Pipe - 79
Specific heat	J(kg.K)	1.0 x 10 <sup>3</sup>
Thermal conductivity	W/(m.K)	0.14
<b>Mechanical</b>		
Elastic Modulus (long term - 50 years)	MPa	2800
Elastic Modulus (short term - 100 seconds)	MPa	1400
Elongation at break	%	Fitting - 75 Pipe - min 80
Poisson's Ratio		0.4
Tensile strength (50 year - extrapolated)	MPa	26
Tensile strength (minimum)	MPa	Fitting - 48 Pipe - min 45
<b>Friction Factors</b>		
Manning		0.008 - 0.009
Hazen Williams		150
Nikuradse roughness	mm	0.003 - 0.015

## 2) THERMAL CHARACTERISTICS

All Thermoplastic materials exhibit a relatively high tendency to expand and contract when subjected to a temperature change. Accordingly, the design and installation of plastic piping often requires that special attention be paid to this characteristic.

However, SAE uPVC system has a relatively low rate of thermal expansion compare to other

plastic materials. Moreover, the thermal reaction thrust in uPVC piping is generally of much lower magnitude than that which is generated in metal piping systems for the same temperature differential.

Likewise, uPVC piping can more easily deform laterally due to the significantly lower elastic modulus of uPVC materials.

The movement caused by thermal reaction of the system requires special consideration and, therefore, adequate provision for expansion should be made. Where the system passes through walls or solid floors, sleeves should be provided. Generally, the maximum working temperature of SAE uPVC S.W.V. system when subjected to continuous flow is 70°C.

### Thermal Expansion

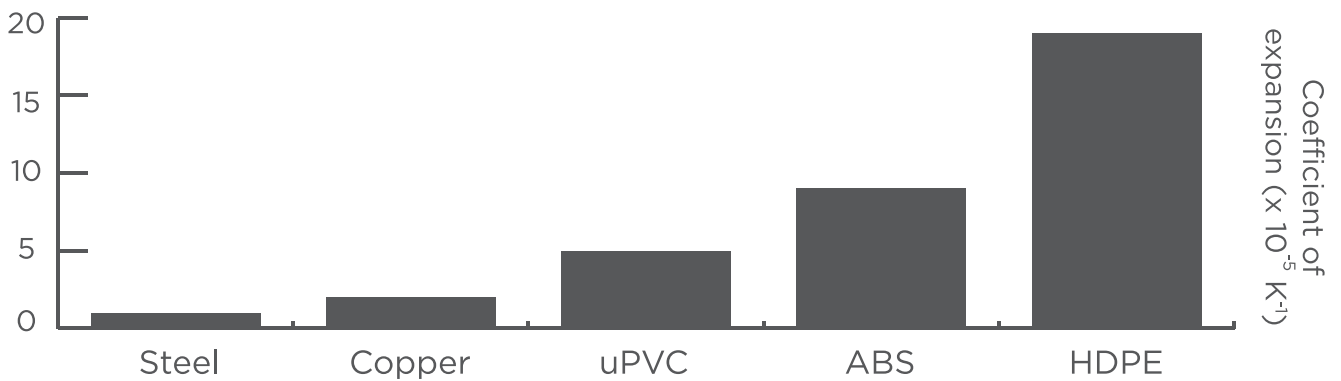

### 3) CHEMICAL RESISTANCE

All Thermoplastic materials exhibit a relatively high tendency to expand and contract when subjected to a temperature change. Accordingly, the design and installation of plastic piping often requires that special attention be paid to this

characteristic.

However, SAE uPVC system has a relatively low rate of thermal expansion compare to other plastic materials. Moreover, the thermal reaction thrust in uPVC piping is generally of much lower

magnitude than that which is generated in metal piping systems for the same temperature differential. Likewise, uPVC piping can more easily deform laterally due to the significantly lower elastic modulus of uPVC materials.

Chemical Type	PVC Reaction/Suitability
Acids	No attack by concentrated or diluted acids at temperature up to 60°C, except for oxidizing acids such as concentrated nitric which attacks PVC above 20°C. In stressed applications, design stress, at 20°C, should be reduced by: from 2.5°C for 10% sulphuric - to 27.5% for concentrated nitric.
Alkalis	No attack at temperatures up to 60°C even by concentrated alkalis. However in stressed applications, design stress must be reduced significantly, e.g. by 40 - 50% for 10% sodium hydroxide.
Aromatic hydrocarbons and highly polar organic materials such as ketones, esters, cyclic ethers, nito - compounds and hydrocarbons.	Not suitable.
Aliphatic hydrocarbons	No effect.
Aliphatic alcohols	No attack at room temperature but design stress must be reduced by half.
Halogens - chlorine	No attack if dry, but not suitable if moist.
Halogens - bromine	Not suitable.
Halogens - flourine	Not suitable.
Halogens - iodine	Not suitable.
Oxidizing agents	Little attack even by the strongest, such as concentrated potassium permanganate, but design stress must be reduced by 25%.
Reducing agents	No effect up to 60°C.
Detergents	No attack.

NOTE: Even though indicated as acceptable with certain temperature limitations, the use of SAE uPVC S.W.V. system with liquid hydrocarbons such as gasoline and jet fuels should be limited to short-term exposure such as secondary containment systems. The system is not recommended by us for long term exposure to liquid hydrocarbons.

## QUALITY CONTROL PROCEDURES



These quality control procedures normally include:

- Raw materials, PVC compound, processing parameters in terms of temperature, pressure and energy input.
- Visual inspection and dimension of diameter, wall thickness and length.
- **Production tests carried out of one sample every 8 hours :**
  - a) Impact Tests - to check the general toughness of the pipe and its ability to withstand the normal shocks which may be expected in handling, transportation and installation during normal use.
  - b) Longitudinal Reversion Tests - designed to show up any excessive built-in (residual) stresses in the pipes and fittings.
  - c) Tensile strength - to determine the strength over elongation characteristics of pipe material when applied tension is forced to the sample pieces.
  - d) Acetone Test - to check the adequacy of the PVC gelation of extruded pipes.
  - e) Short Term Hydrostatic - to check the strength of the pipes during internal pressure is applied to the sample pipes.



## INSTALLATION CONSIDERATION

Soil, Waste and Ventilation (S.W.V.) system should comprise the minimum of pipe work necessary to carry away the discharges from sanitary appliances in the building quickly, quietly and with freedom from nuisance or risk of injury to health. It is essential that air from the system be prevented from entering the building.

### 1) POSITIONING AND FIXING

Branch pipes should be fixed with uniform and adequate gradients according to design of the fittings to drain the pipe efficiently. SAE uPVC S.W.V.

fittings have the minimum gradient of  $1\frac{1}{4}^\circ$  for branch discharge pipes. Proper brackets or hangers should be installed at the

spacing given at table below. It is not recommended to exceed the maximum spacing between fixings for pipes as it will lead to failure of the system.

Nominal Size (mm)	Maximum spacing of supports (m)	
	Vertical pipes	Graded pipes
36 - 56	2	1
82 - 200	2.5	1.2

While fixing the system, it is important to follow to the guidelines below:

- a) Securely attach to the structure of the building and not to any other service (i.e. air conditioner support bracket).
- b) Although SAE uPVC S.W.V system is immune to electrochemical reactions caused by acids, bases, and salts that cause corrosion in metals, it is recommended to protect the system when it is exposed to a corrosive environment.
- c) Clamped securely to restrict lateral movement, but to allow thermal movement.
- d) Brackets or hangers should be designed in such a way that minimal load of the system is taken by the joints.

## 2) JOINTING

The jointing of SAE uPVC S.W.V. system is done by applying solvent cement on both pipes and fittings. It is important to take note of the manufacturer's instructions before application. The solvent cement jointing

procedure with diagram can be found at the following page. Once the installation is done, it is recommended to remove excess cement that left on exposed joints. It is because the softening effect of excess

solvent could permanently distort or weaken the system. Different jointing method is available for pipes and fittings of dissimilar materials.

Material	Jointing method
Cast and ductile iron	1. Bolted Gland 2. Rubber ring 3. Adapter with solvent cement on uPVC pipe and epoxy resin on iron pipe
Copper and brass	1. uPVC threaded adapter with solvent cement at uPVC pipe and screwed to copper or brass adapter then silver brazed at copper or brass pipe. 2. Rubber ring
Galvanised Steel	1. uPVC Threaded adapter with solvent cement on uPVC pipe and screwed to threaded galvanised steel pipe. 2. Adapter with solvent cement on uPVC pipe and epoxy resin on galvanised steel pipe
Polypropylene	1. Rubber ring 2. Threaded adapter with solvent cement on uPVC pipe and screwed to proper threaded PP socket.
Vitrified Clay	1. Epoxy resin

## 3) INSPECTION AND TESTING

Testing and commissioning should be made during the installation of the S.W.V. system as the work proceeds to ensure that the pipework is properly secured and clear of obstructing rubble and superfluous matter and that all work which is to be concealed is free from defects before it is finally enclosed.

### Leak Tests

Detection of leaks can be carried out by smoke test but care is needed not to damage the system by heat or products of combustion. Leakage can also be revealed by soap solution applied to suspect areas.

Water flood test is not normally justified but may be applied at the lowest level of the system up to the spill-over level of the lowest sanitary appliance provided the static head does not exceed 6m.

### Performance Tests

Upon completion of the system, check generally all sanitary appliances should drain speedily, quietly and completely through the installation. After each test a minimum of 25mm of water seal should be retained in every trap. The maximum loss of seal can be measured by a dip stick or small diameter transparent tube.

The number of appliances, which should be discharged together during the performance test, is given in table below.

WARNING: DO NOT use compressed air or gas to test and SAE uPVC S.W.V. system, and do not use devices propelled by compressed air or gas to clear the system. These practices may result in explosive fragmentation of system piping and components causing bodily injury or death.

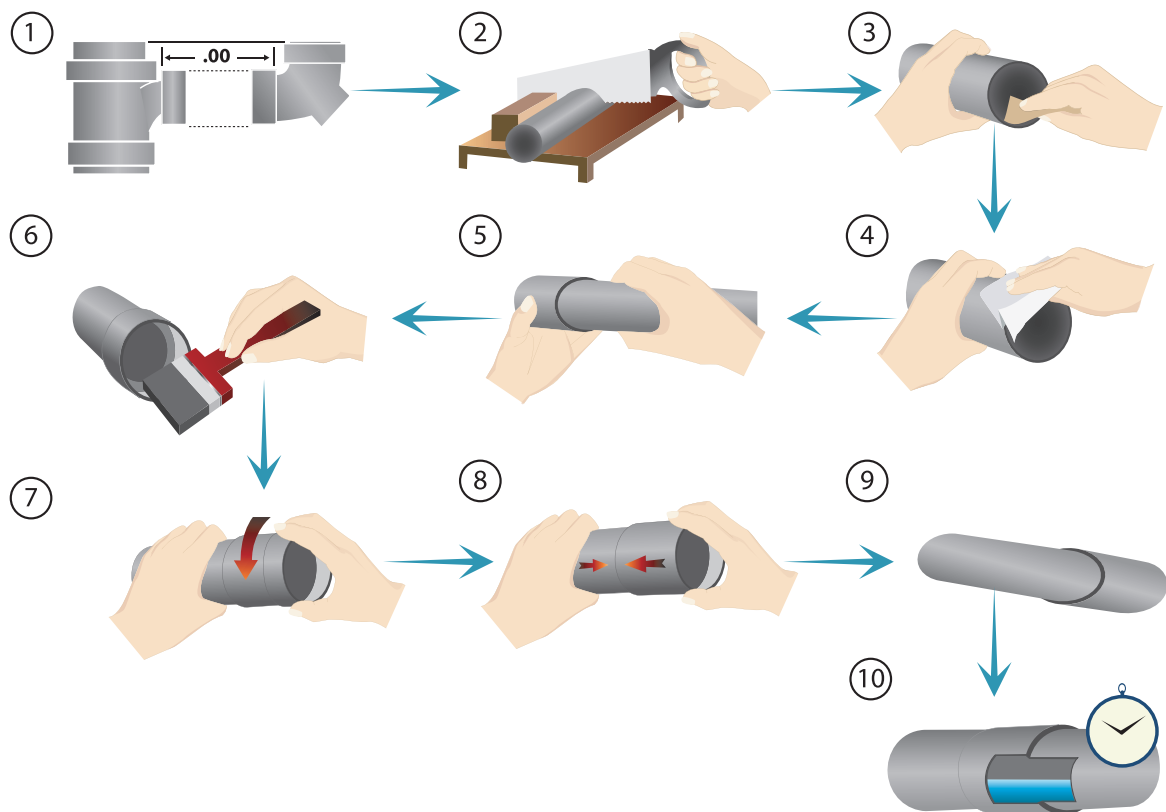

## INSTALLATION OF PIPES AND FITTINGS WITH SOLVENT CEMENT JOINTING PROCEDURE

1. Measure pipe from bottom or shoulder of each socket into which pipe is fit.
2. Cut pipe to required length, making sure cut is square.
3. Ream inside and chamfer outside of pipe to eliminate all burrs and swarf.
4. Sand lightly. Failure to do so lead to failure of the joint. Clean all dirt, moisture, and grease from pipe and fitting socket, using a clean, dry cloth.
5. Check dry fit of pipe in fitting socket. Pipe should enter fitting socket to between 1/2 and 3/4 the socket depth.
6. Be sure to use only approved types of fittings and adapters. Using brush or dauber-type device, apply a light coat of approved solvent cement to the inside of the fitting socket, using straight, outward strikes.
7. Apply solvent cement to the outside of the pipe in a similar manner. Times is important at this stage: apply cement quickly and do not allow it to set before the joint is put together. Always follow safe-handing practices when using solvent cements: use in a well-ventilated area, avoid skin contact (wear gloves) and do not use near heat, sparks or open flame. Immediately insert pipe into fitting socket, giving the pipe a one-quarter turn and making sure it goes all the way to the socket bottom.
8. Hold the joint together until a tight sets is attained.
9. Check cement bead around joint. A proper joint will normally show a bead around its entire perimeter.
10. Any gaps may indicate insufficient cement or the use of light boiled cement on larger diameters where heavy bodied cement was required. After setting, wipe excess cement from the pipe. Don't move the system until the joint have cured(set) at least as long a recommended by the solvent manufacturer.



## STORAGE & HANDLING

### STORAGE

1. Where possible, products should be stored inside their original packaging until ready for use.
2. Store in cool dry conditions, preferably under cover so as to avoid damage of any kind; soiling, UV exposure and contamination by oils, petrol or greases.
3. Rubber items such as O-rings should be stored in a cool, dry, dark place.
4. Store away from excessive heat.
5. If stored for an extended period (more than 3 months), should be completely covered with an opaque UV resistant material.
6. The storage area must be flat and level, with no sharp objects or projections and able to support the complete plan area and weight of the products being stored.
7. Products should be stored in original packaging and stacked not exceeding 3m in height.
8. Products of different sizes and shapes should be stacked separately. Where the situation is not possible, larger fittings should be placed at the bottom.

### HANDLING AND TRANSPORT

1. While uPVC fittings are light and easy to handle, they should not be maltreated. The protection of the sockets is particularly important.
2. Products should never be dropped on hard surfaces.
3. The dragging of bags full of fittings along the ground is not advisable.
4. Products should be transported by a suitable vehicle, having a flat and level load bed with no sharp objects or projections and able to support the complete plan area and weight of the products being transported.

### WE WARRANT

1. **Dimension Match**  
Dimension tolerance of pipe and fitting are match together. Leakage problem is no more a worry.
2. **Colour Match.**  
No more headache about different manufacturer with different colour, shades.
3. **Better Services**  
Immediate response to site complains from our group. Product replacement for any manufacturing defect. Your Satisfaction is Our Commitment.(EXACT motto).
4. **5 Year Product Guarantee**  
Product guarantee free from manufacturing defect and complies with specification.

#### Remark :

Whilst the information, opinions, advice and recommendation contained have been prepared with proper care, they are offered only in pursuance of the object of providing useful information to assist those interested in technical matter associated with 'S.A.E product'.

The 5 Years Product Guarantee is not intended to be an exhaustive guarantee, as the successful system in each case may depend on numerous factors outside of our control. (eg particular design, site preparation, quality of workmanship etc...)

**SAE** offer a complete range of soil, waste discharge and ventilation (S.W.V) applications. It was developed in close consultation with the Malaysian plumbing industry.

A full complement of solvent cement jointed pipes and fitting are available from 36, 43 and 56mm for waste water applications. For soil and vent applications, they are available in 82, 110, 160, 200, 250 and 315mm sizes, including transition to 43 and 56mm waste dimensions.

**SAE S.W.V.** pipes is specified by :  
 Diameter  
 Application

**Nominal size** (pipes Diameter)

This is specified by their nominal diameter or size in millimeter, the size range covers from DN 36mm to 315mm (see Dimension section)

1) Application Area Code

All SWV pipes and fitting marked with code “B” ,“BD” and “D” to indicate the application area for which they are intended as follow:

“B” intended to use above ground inside the building,or for components outside the building fixed into the wall.

“BD” intended for above ground use for both inside the building, or for components outside the building fixed into the wall and buried inbuilding structures.

“D” for the area under and within 1m from the building where the pipes and fittings are buried in ground and are connected to the underground drainage and sewerage system.

*Note : “D” application area is recommended use of Underground Sewerage Pipe (MS 979.1 &MS 979.2 / BS 4660 & BS 5841)as alternative.*

2) Marking

All Swv pipes are marked by printer, the follwing details at approximately meter intervals.

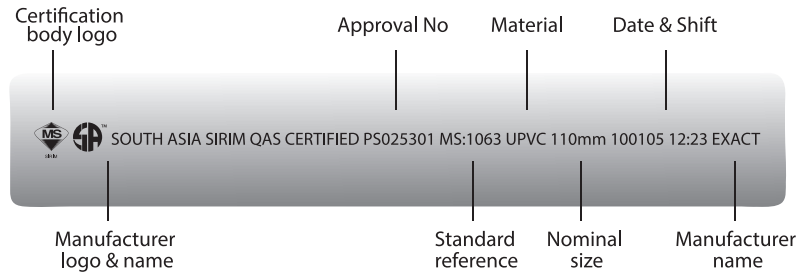

The Swv pipes fitting has been clearly and durably marked by moulded impression for each cavity of products.



	<b>BS 4514 / MS 1063</b>
	CODE E10-110-92
	uPVC S.W.V. (B)
	<b>MADE IN MALAYSIA</b>

**AB 99 – 999 – 99**

**Prefix**

AB – Abbreviation for Product Name

99 – Series Code

**Nominal Size**

Nominal Size in millimeter (eg. "110" for 110mm)

**Nominal Angle**

Nominal Angle (eg. "88" for 88°)

**Sample**

**E10 – 43 – 88**

Equal Single Branch with Nominal Size of 43mm and Nominal Angle of 88°.

**PS10 – 110 – 00**

Pipe Sleeve with Nominal Size of 110mm and Nominal Angle of 0°.

**C10 – 56 – 45**

Bend with Nominal Size of 56mm and Nominal Angle of 45°.

# MANUFACTURING PROCESS FLOW

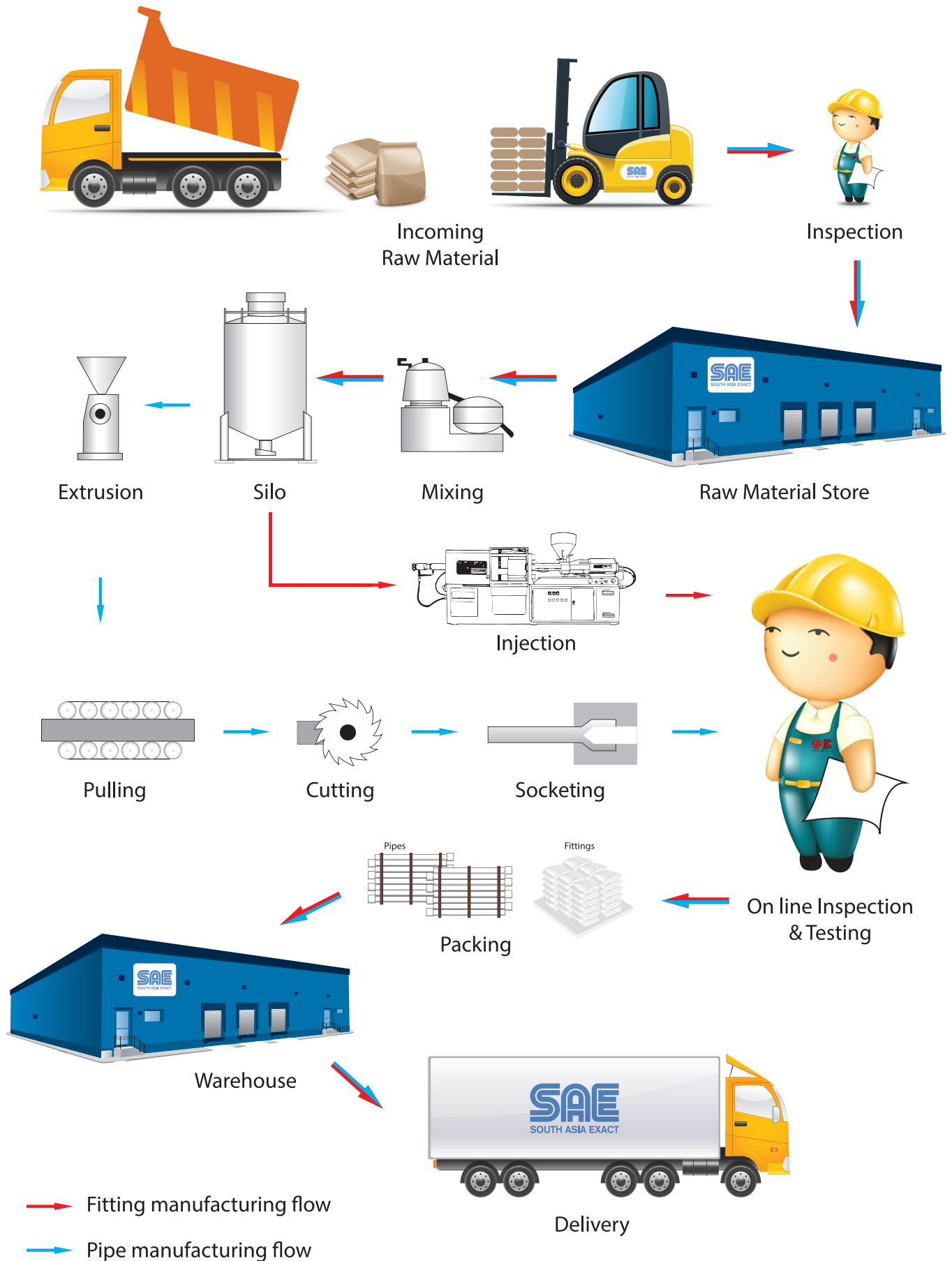

---

**UPVC SOIL,WASTE VENTILATING (S.W.V)PIPES**

*UPVC SOIL, WASTE VENLATING (S.W.V)FITTING\_ Page 22 - 30*

**UPVC UNDERGROUND DRAINAGE  
AND SEWERAGE PIPES**

*UNDERGROUND DRAINAGE & SEWERAGE FITTING\_ Page 32 - 34*

**UPVC PRESSURE PIPES WITH SOLVENT CEMENT JOINT**

*UPVC PRESSURE FITTINGS\_ Page 36 - 40*

**UPVC CONDUITS FOR UNDERGROUND  
TELECOMMUNICATION CABLE**

---

## SPECIFICATIONS OF SOIL, WASTE AND VENT (S.W.V) PIPES



Colour : White  
Length : 4m or 5.8m  
Type of Joint : Solvent Cement Weld Joint

Nominal Size		Outside Diameter		Wall Thickness (MS 1063)			
				'B'		'BD'	
Size		Min	Max	Min	Max	Min	Max
(inches)	(mm)	(mm)		(mm)		(mm)	
1¼	36	36.20	36.50	3.0	3.5	-	-
1½	43	42.80	43.10	3.0	3.5	-	-
2	56	55.80	56.10	3.0	3.5	-	-
3	82	82.40	82.80	3.0	3.5	-	-
4	110	110.00	110.30	3.2	3.8	3.2	3.8
6	160	160.00	160.40	3.2	3.8	4.0	4.6
8	200	200.00	200.50	3.9	4.5	4.9	5.6
10	250	250.00	250.50	-	-	6.2	7.1
12	315	315.00	315.60	-	-	7.7	8.7

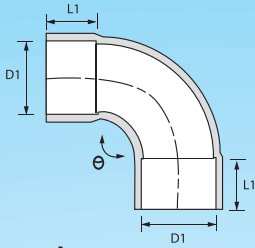

**1. Sweep Bend**

DIMENSION (mm)				
Code No.	Size (mm)	Angle $\theta$	D1	L1
B10-36-88	36	91.25	36.3	20
B10-43-88	43	91.25	42.9	25
B10-56-88	56	91.25	55.9	28
B70-82-92	82	92.5	82.6	45
B70-110-92	110	92.5	110.2	50
B10-160-92	160	92.5	160.4	78
B10-200-92	200	92.5	200.5	80

\*. To solvent weld to pipe or fitting.

1.



2.



3.



4.

**2. Sweep Bend with I/O**

DIMENSION (mm)				
Code No.	Size (mm)	Angle $\theta$	D1	L1
B20-43-88	43	91.25	42.9	21.5
B20-56-88	56	91.25	55.9	28
B20-82-92	82	92.5	82.6	45
B80-110-92	110	92.5	110.2	50
B20-160-92	160	92.5	160.4	78
B20-200-92	200	92.5	200.5	80

\*. To solvent weld to soil pipe or fitting fitted with inspection opening.

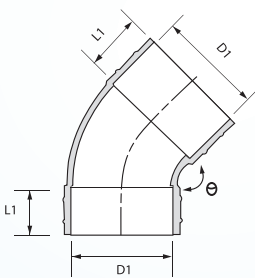
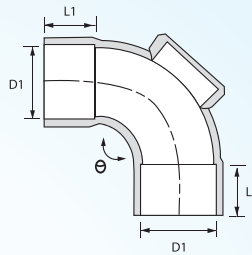

**3. 45° Bend Plain**

DIMENSION (mm)				
Code No.	Size (mm)	Angle $\theta$	D1	L1
C10-36-45	36	45	36.3	24
C10-43-45	43	45	42.9	25
C10-56-45	56	45	55.9	28
C10-82-135	82	45	82.6	45
C10-110-135	110	45	110.2	50
C10-160-135	160	45	160.4	78
C10-200-135	200	45	200.5	80

\*. To solvent weld to soil pipe.

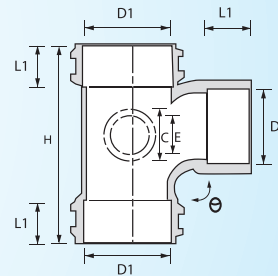

**4. Equal Single Branch**

DIMENSION (mm)							
Code No.	Size (mm)	Angle $\theta$	D1	L1	H	C	E
E10-36-88	36	91.25	36.3	24	89	-	-
E10-43-88	43	91.25	42.9	25	109	-	-
E10-56-88	56	91.25	55.9	28	135	-	-
E10-82-92	82	92.5	82.6	45	205	-	42.9
E10-110-92	110	92.5	110.2	50	250	-	55.9
E10-160-92	160	92.5	160.4	75	350.5	82.6	55.9
E10-200-92	200	90	200.5	80	404	82.6	55.9

\*. To solvent weld to soil pipe.

\*. 92° branches have integrally moulded boss adaptor socket to accept waste pipe or fitting.

### 5. Equal Single Branch with I/O

Code No.	Size (mm)	Angle $\theta$	DIMENSION (mm)				
			D1	L1	H	C	E
E20-43-88	43	91.25	42.9	25	110	-	-
E20-56-88	56	91.25	55.9	28	135	-	-
E20-82-92	82	92.5	82.6	45	205	-	42.9
E20-110-92	110	92.5	110.2	50	250	-	55.9
E20-160-92	160	92.25	160.4	75	350.5	82.6	55.9

\*. To solvent weld to soil pipe.

\*. 92° branches have integrally moulded boss adaptor socket to accept waste pipe or fitting with inspection opening.

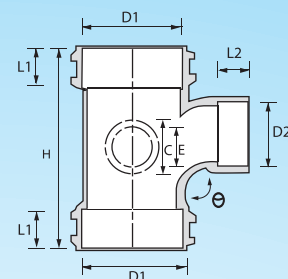
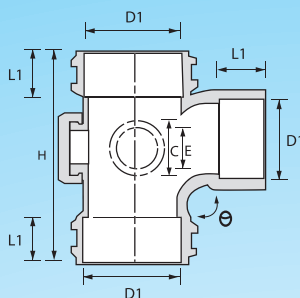

5.



6.

### 6. Reducing Branch

Code No.	Size (mm)	Angle $\theta$	DIMENSION (mm)						
			D1	D2	L1	L2	H	C	E
E10-82x56	82x56	91.25	82.6	55.9	45	30	208	-	42.9
E10-110x56	110x56	91.25	110.2	55.9	50	30	230	-	55.9
E10-110x82	110x82	92.5	110.2	82.6	50	45	230	-	55.9
E10-160x110	160x110	92.25	160.4	110.2	75	50	310	-	55.9
E10-200x110	200x110	92.5	200.5	110.2	80	50	404	82.6	55.9
E10-200x160	200x160	92.5	200.5	160.2	80	75	404	82.6	55.9

\*. 92° branches have integrally moulded boss adaptor socket to accept waste pipe or fitting with inspection opening.

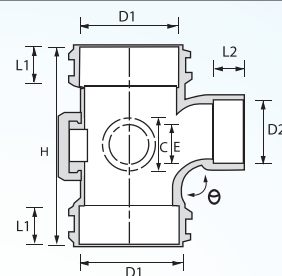

### 7. Reducing Branch with I/O

Code No.	Size (mm)	Angle $\theta$	DIMENSION (mm)						
			D1	D2	L1	L2	H	C	E
E20-160x110	160x110	92.5	160.4	110.2	75	50	310	-	55.9

\*. 92° branches have integrally moulded boss adaptor socket to accept waste pipe or fitting with inspection opening.



7.



8.

### 8. 45° Y-Branch

Code No.	Size (mm)	DIMENSION (mm)				
		D1	L1	H	C	E
EY10-82-135	82	82.6	45	208	-	42.9
EY10-110-135	110	110.2	50	265	-	55.9

\*. To solvent weld to soil pipe.

\*. 45° branches have integrally moulded boss adaptor socket to accept waste pipe or fitting with inspection opening.

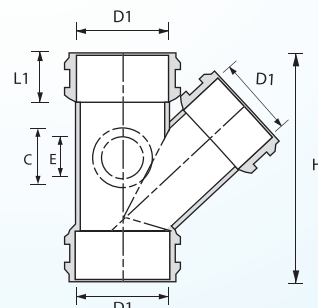



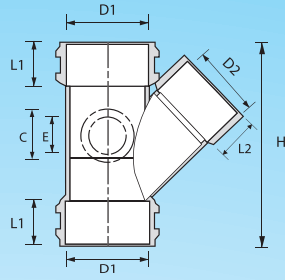

**9. 45° Reducing Y-Branch (Reducing Y-Tee)**

**DIMENSION (mm)**

Code No.	Size (mm)	Angle θ	D1	D2	L1	L2	H	C	E
EY10-160x110	160x110	45	160.4	110.2	75	50	310	82.6	55.9

\*. To solvent weld to pipe.

\*. 45° branches have integrally moulded boss adaptor socket to accept waste pipe or fitting.

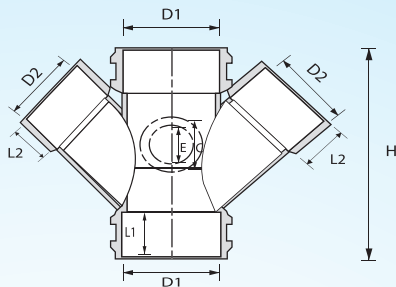

**10. 45° Reducing Double Y-Branch (Reducing Cross Y-Tee)**

**DIMENSION (mm)**

Code No.	Size (mm)	Angle θ	D1	D2	L1	L2	H	C	E
ET10-160x110	160x110	45	160.4	110.2	75	50	310	82.6	55.9

\*. To solvent weld to pipe.

\*. 45° branches have integrally moulded boss adaptor socket to accept waste pipe or fitting.

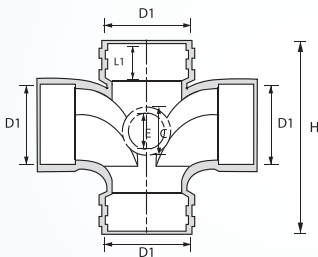

**11. Equal Double Branch (Cross Tee)**

**DIMENSION (mm)**

Code No.	Size (mm)	D1	L1	H	C	E
ED10-110-92	110	110.2	50	250	-	55.9

\*. To solvent weld to soil pipe.

\*. 92° branches have integrally moulded boss adaptor socket to accept waste pipe or fitting.

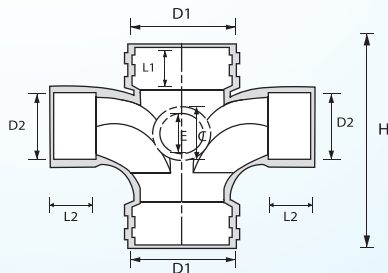

**12. Reducing Double Branch (Reducing Cross Tee)**

**DIMENSION (mm)**

Code No.	Size (mm)	Angle θ	D1	D2	L1	L2	H	C	E
ED10-160x110	160x110	92.5	160.4	110.2	75	50	310	-	55.9

\*. To solvent weld to soil pipe.

\*. 92° branches have integrally moulded boss adaptor socket to accept waste pipe or fitting.





13.

**13. Straight Coupler**

**DIMENSION (mm)**

Code No.	Size (mm)	D1	L1
L10-36-00	36	36.3	24
L10-43-00	43	42.9	25
L10-56-00	56	55.9	28
L10-82-00	82	82.6	45
L10-110-00	110	110.2	50
L10-160-00	160	160.4	78
L10-200-00	200	200.5	80

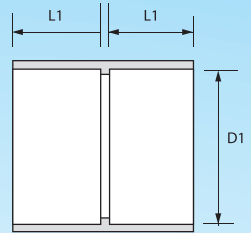

\*. To solvent weld together two length of uPVC soil or waste pipes.



14.

**14. Straight Coupler (Plain)**

**DIMENSION (mm)**

Code No.	Size (mm)	D1	L1
L30-110-00	110	110.2	50

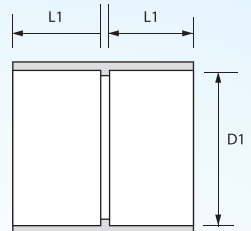

\*. To solvent weld together two length of uPVC soil or waste pipes.



15.

**15. Pipe Sleeve**

**DIMENSION (mm)**

Code No.	Size (mm)	D1	H
PS10-36-00	36	36.3	110
PS10-43-00	43	42.9	110
PS10-56-00	56	55.9	110
PS10-82-00	82	82.6	110
PS10-110-00	110	110.2	110
PS10-160-00	160	160.4	161
PS10-200-00	200	200.5	175

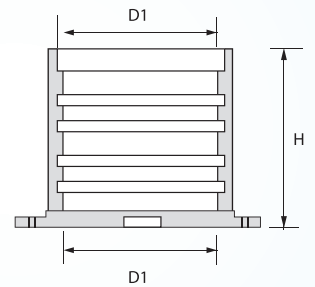

\*. Fpr cast into RC floor slab / concrete wall to provide a through socket for pipes



16.

**16. Pipe Sleeve (Short)**

**DIMENSION (mm)**

Code No.	Size (mm)	D1	H
PS30-160-00	160	160.4	110.1

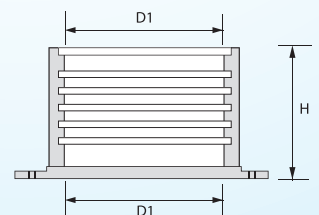

\*. Fpr cast into RC floor slab / concrete wall to provide a through socket for pipes.



17.



18.



20.

19.

**17. Bush / Socket Reducer**

Code No.	Size (mm)	DIMENSION(mm)			
		D1	D2	L1	L2
Q10-43x36	43x36	42.9	36.3	22	19
Q10-56x36	56x36	55.9	36.3	28	19
Q10-56x43	56x43	55.9	42.9	28	22
Q10-82x56	82x56	82.6	55.9	45	28
Q10-110x56	110x56	110.2	55.9	50	28
Q10-110x82	110x82	110.2	82.6	50	45
Q10-160x82	160x82	160.4	82.6	78	43
Q10-160x110	160x110	160.4	110.2	78	50
Q10-200x110	200x110	200.5	110.2	82	50
Q10-200x160	200x160	200.5	160.4	82	78

\*. To allow for change in fitting socket diameter.

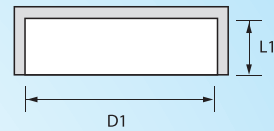
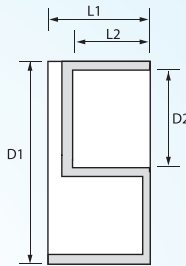

**19. End Cap**

Code No.	Size (mm)	DIMENSION(mm)	
		D1	L1
EC10-56-00	56	55.9	31
EC10-82-00	82	82.6	31
EC10-110-00	110	110.2	25
EC10-160-00	160	160.4	75

\*. To cover up the open-end of a pipe line for later accessibility.

**18. Level Invert Reducer**

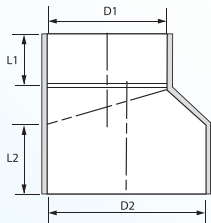

Code No.	Size (mm)	DIMENSION(mm)			
		D1	D2	L1	L2
Q30-82x56	82x56	55.9	82.6	31	46
Q30-110x56	110x56	55.9	110.2	31	53
Q30-110x82	110x82	82.6	110.2	46.5	53
Q30-200x110	200x110	110.2	200.4	60	50
Q30-200x160	200x160	160.4	200.5	60	60

\*. To allow for change in pipe diameter with larger end spigot to fitting and other end socket to pipe.

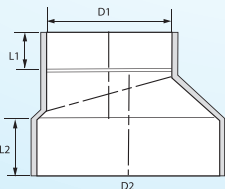

Code No.	Size (mm)	D1	D2	L1	L2
Q30-160x110	160x110	110.2	160.4	48	51.5

\*. To allow for change in pipe diameter with larger end spigot to fitting and other end socket to pipe.

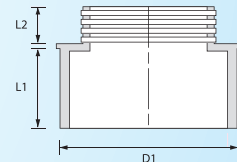

**20. Access Plug(M)**

Code No.	Size (mm)	DIMENSION(mm)	
		D1	L1
AP10-82-00	82	82.6	45
AP10-110-00	110	110.2	50

\*. To plug up the socket to allow for later accessibility.



21.

**21. Boss Connector**

DIMENSION (mm)					
Code No.	Size (mm)	D1	D2	L	
Y20-82x56	82x56	82.6	55.9	28	
Y20-160x82	160x82	160.4	82.6	45	
Y20-160x110	160x110	160.4	110.2	50	
Y30-110x56	110x56	110.2	55.9	28	
Y30-110x82	110x82	110.2	82.6	45	

\*. To connect waste pipe to soil pipe and for venting by solvent cement. Incorporates a bracket specially designed to hold boss connector firmly in place during installation.

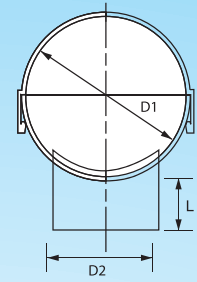

22.

**22. Pipe Holder**

DIMENSION (mm)				
Code No.	Size (mm)	D1	L2	W1
PH10-110-00	110	110.4	28.7	3.0

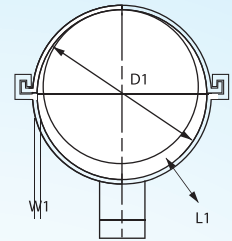

23.

**23. PT Socket**

DIMENSION (mm)					
Code No.	Size (mm)	D1	D2	L1	L2
PT10-36-00	36	36	42	33.5	24
PT10-43-00	43	43	48	39	28.5

\*. To connect basin joint directly to PVC pipe.

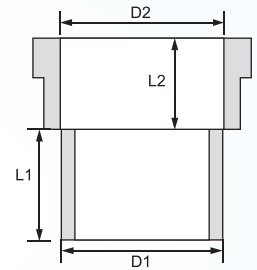

24.

**24. PT Elbow**

DIMENSION (mm)							
Code No.	Size (mm)	Angle θ	D1	D2	L1	L2	W
PE10-36-00	36	92.5	34	40	33.5	24	2.2
PE10-43-00	43	92.5	42	47	39	28.5	2.6

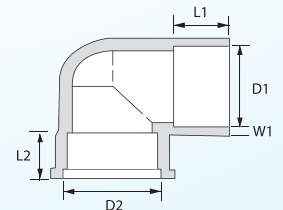

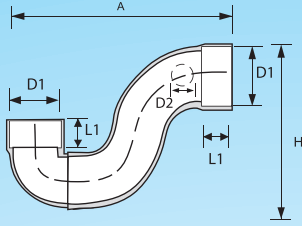

**25. "P" Trap Plain**

**DIMENSION (mm)**

Code No.	Size (mm)	D1	D2	L1	A	H
Z30-110-92	110	110.2	55.9	50	380	270

\*. "P" Trap with water seal for gas-tight connection to SWV system.



**25.**

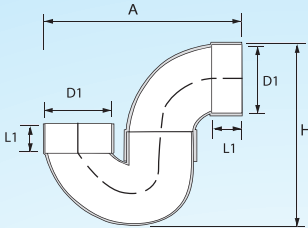

**26. "P" Trap Plain (U Body)**

**DIMENSION (mm)**

Code No.	Size (mm)	D1	L1	A	H
Z50-110-90	110	110.2	50	300	280

\*. "P" Trap with water seal for gas-tight connection to SWV system.



**26.**

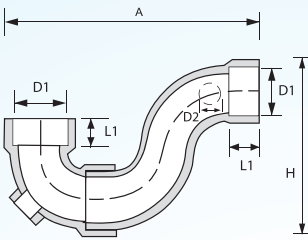

**27. "P" Trap with I/O**

**DIMENSION (mm)**

Code No.	Size (mm)	D1	D2	L1	A	H
Z10-56-88	56	55.9	55.9	28	240	180
Z10-110-92	110	110.2	55.9	50	380	270

\*. "P" Trap with water seal for gas-tight connection to SWV system with inspection opening.



**27.**

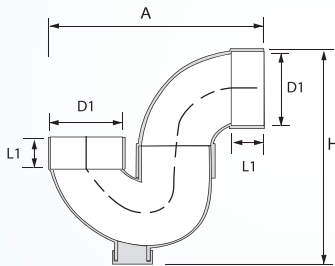

**28. "P" Trap with I/O ( U body)**

**DIMENSION (mm)**

Code No.	Size (mm)	D1	D2	L1	A	H
Z60-110-90	110	110.2	55.9	50	300	290

\*. "P" Trap with water seal for gas-tight connection to SWV system with inspection opening.



**28.**

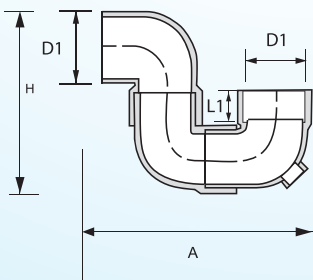

**29. "P" Trap with I/O ( offset)**

**DIMENSION (mm)**

Code No.	Size (mm)	D1	D2	L1	A	H
Z10-110-OFF	110	110.2	110.2	50	320	280

\*. "P" Trap with water seal for gas-tight connection to SWV system with inspection opening.



**29.**



30.

**30. "S" Trap Plain**

DIMENSION(mm)						
Code No.	Size (mm)	D1	L1	A	H	
S30-110-92	110	110.2	50	470	280	

\*. "S" Trap with water seal for gas-tight connection to SWV system.

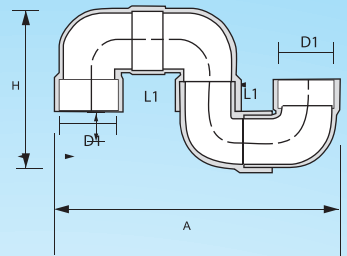

31.

**31. "S" Trap Plain (U Body)**

DIMENSION(mm)						
Code No.	Size (mm)	D1	L1	A	H	
S50-110-90	110	110.2	50	390	260	

\*. "S" Trap with water seal for gas-tight connection to SWV system.

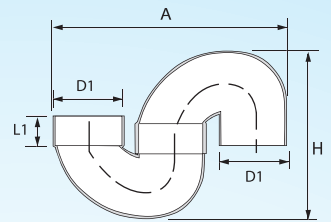

32.

**32. "S" Trap with I/O**

DIMENSION(mm)						
Code No.	Size (mm)	D1	L1	A	H	
S20-110-92	110	110.2	50	470	280	

\*. "S" Trap with water seal for gas-tight connection to SWV system with inspection opening.

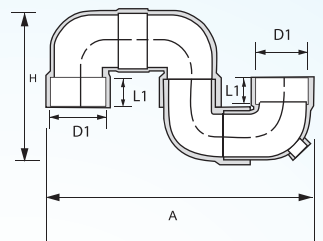

33.

**33. "S" Trap with I/O ( U body)**

DIMENSION(mm)						
Code No.	Size (mm)	D1	L1	A	H	
S60-110-90	110	110.2	50	390	270	

\*. "S" Trap with water seal for gas-tight connection to SWV system with inspection opening.

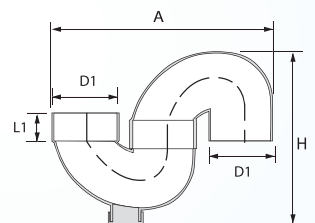

34.

**34. "S" Trap with I/O ( Offset)**

DIMENSION (mm)						
Code No.	Size (mm)	D1	D2	L1	A	W
S20-110-OFF	110	110.2	55.9	48	495	270

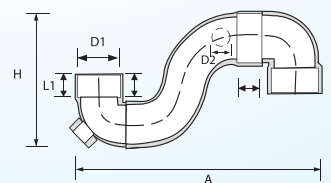

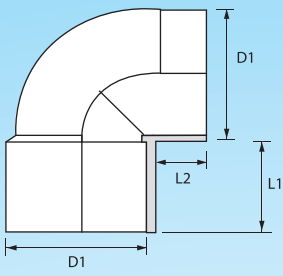

**35. Bossed Bend (M/F)**

DIMENSION(mm)					
Code No.	Size (mm)	Angle $\theta$	D1	L1	L2
B50-110-90	110	90	110.2	50	25

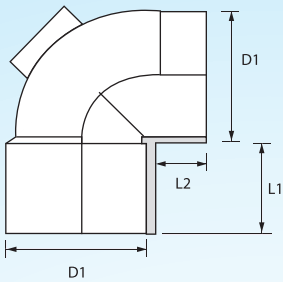

**36. Bossed Bend with I/O (M/F)**

DIMENSION (mm)					
Code No.	Size (mm)	Angle $\theta$	D1	L1	L2
B60-110-90	110	90	110.2	50	25

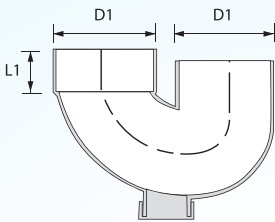

**37. U Body with I/O (M/F)**

DIMENSION(mm)				
Code No.	Size (mm)	D1	L1	
U20-110-90	110	110.2	50	

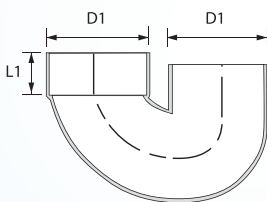

**38. U Body (M/F)**

DIMENSION (mm)				
Code No.	Size (mm)	D1	L1	
U10-110-90	110	110.2	50	

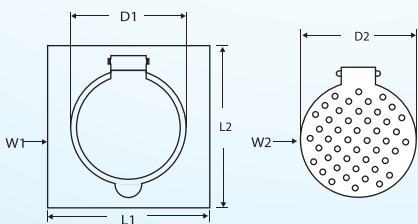

**39. Floor Grating**

DIMENSION (mm)						
Code No.	L1	L2	D1	D2	W1	W2
G10-160-00	144	144	100.5	100	2.5	4.0



39.



40.



41.



42.



43.

**40. Vent Cowl**

**DIMENSION (mm)**

Code No.	Size (mm)	D1	L1
AB10-56-00	56	55.9	30
AB10-82-00	82	82.6	25
AB10-110-00	110	110.2	25.5
AB10-160-00	160	160.4	38

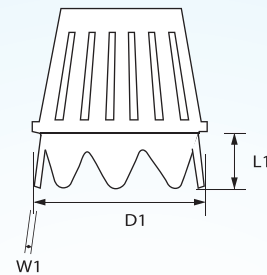
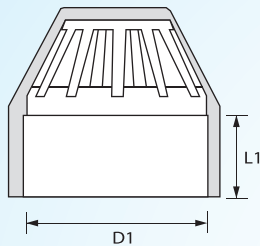

**41. Dome Filter**

**DIMENSION (mm)**

Code No.	Size (mm)	D1	L1	W1
AB30-110-00	110	110.2	28.5	4
AB30-160-00	160	155	50	5
AB30-200-00	200	192	62	5

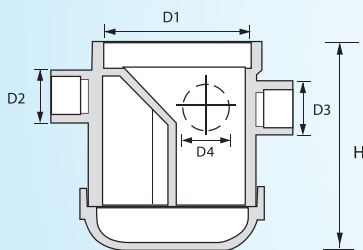

**42. Floor Gully with Trap & I/O (i)**

Floor Gully with Trap & I/O (56mm) x 3

**DIMENSION (mm)**

Code No.	Size (mm)	D1	D2	D3	D4	H
AG30-110x56	110x56	110.2	55.9	55.9	55.9	194.2

Floor Gully with Trap & I/O (82mm x 56mm)

**DIMENSION (mm)**

Code No.	Size (mm)	D1	D2	D3	D4	H
AG30-110x82	110x82	110.2	82.6	55.9	55.9	194.2

\*. Integrally moulded boss adaptor with 56mm socket to accept waste pipe or other fittings.

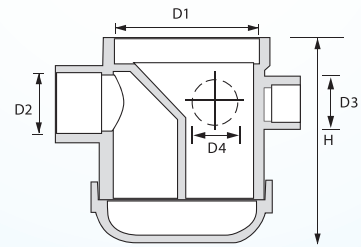

**43. Floor Gully with Trap & I/O (ii)**

**DIMENSION (mm)**

Code No.	Size (mm)	D1	D2	D3	D4	H
AG10-110x56	110x56	110.2	55.9	55.9	42.9	212
AG10-110x82	110x82	110.2	82.6	55.9	42.9	212

\*. Integrally moulded boss adaptor with 56mm socket to accept waste pipe or other fittings.



## SPECIFICATIONS UNDERGROUND DRAINAGE AND SEWERAGE PIPES



Colour : Golden Brown  
Length : 5.8m  
Type of Joint : Solvent Cement Weld Joint

### MS 979

Nominal Size		Outside Diameter		Wall Thickness (mm)		
(inches)	(mm)	Min	Max	Min	Max	
MS 979 PT 1	4	100	110.00	110.40	3.2	-
	6	155	160.00	160.60	4.1	-
MS 979 PT 2	8	200	200.00	200.60	4.9	-
	10	250	250.00	250.70	6.1	-
	12	315	315.00	315.90	7.7	-

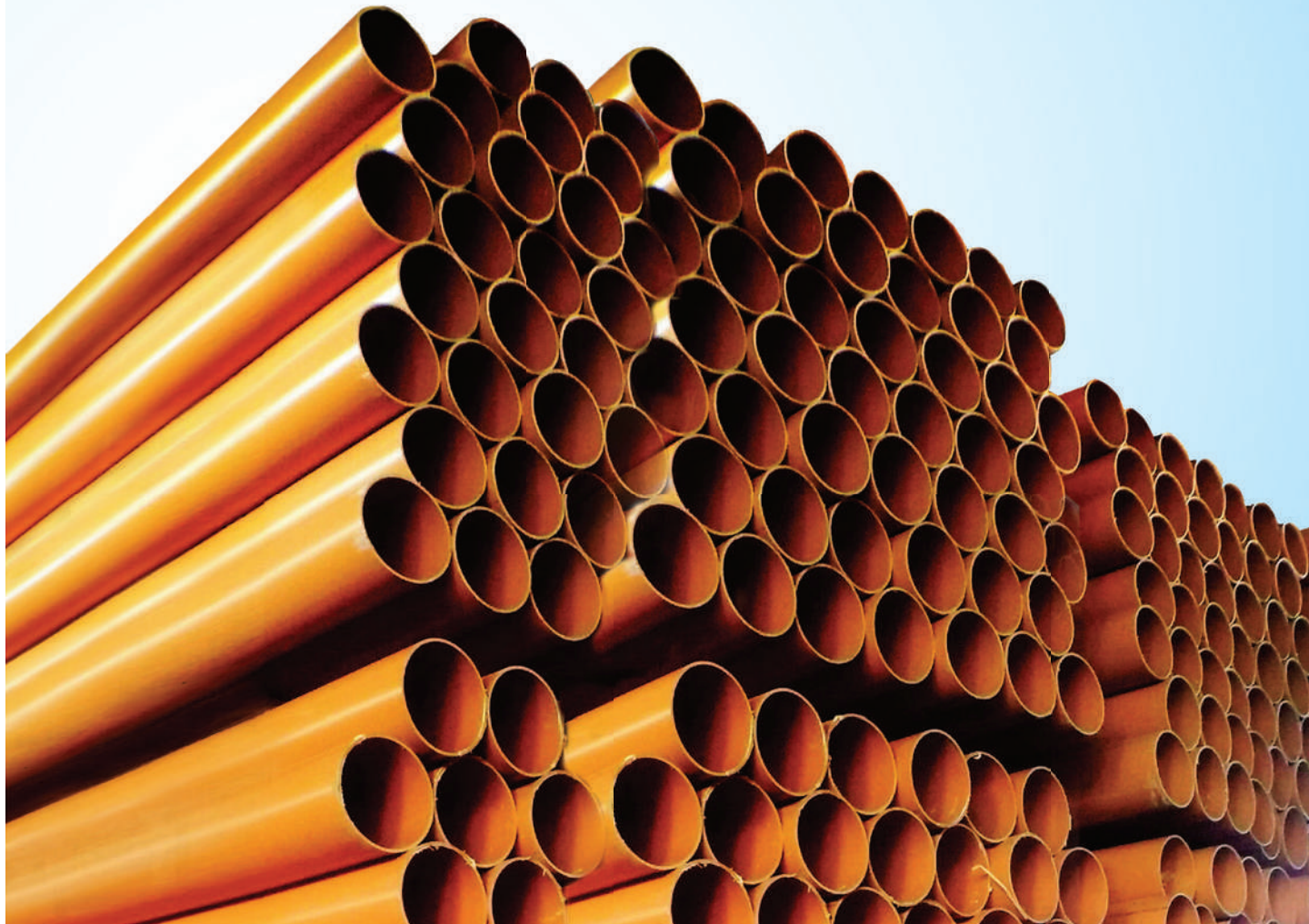



### 1. Underground Sweep Bend

DIMENSION (mm)				
Code No.	Size (mm)	Angle $\theta$	D1	L1
UB70-110-92	110	92.5	110.2	50
UB10-160-92	160	92.5	160.4	78
UB10-200-92	200	92.5	200.5	80

\*. To solvent weld to soil pipe.

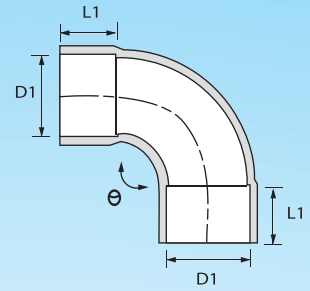

### 2. 45° Underground Bend Plain

DIMENSION (mm)				
Code No.	Size (mm)	Angle $\theta$	D1	L1
UC10-110-135	110	45	110.2	50
UC10-160-135	160	45	160.4	78
UC10-200-135	200	45	200.5	80

\*. To solvent weld to soil pipe.

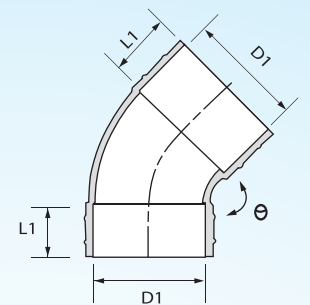

### 3. Underground Straight Coupling

DIMENSION (mm)			
Code No.	Size (mm)	D1	L1
UL10-110-00	110	110.2	50
UL10-160-00	160	160.4	78
UL10-200-00	200	200.5	80

\*. To solvent weld together two length of uPVC soil or waste pipe.

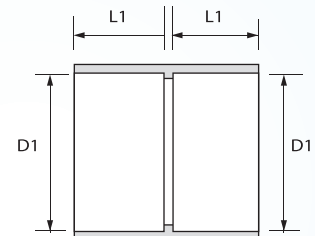

### 4. Underground Equal Single Branch

DIMENSION (mm)					
Code No.	Size (mm)	Angle $\theta$	D1	L1	H
UE10-110-92	110	92.5	110.2	50	250
UE10-160-92	160	92.5	160.4	78	350.5
UE10-200-92	200	92.5	200.5	80	404

\*. To solvent weld to soil pipe.

\*. 92° branches have integrally moulded boss adaptor socket to accept waste pipes or fitting.

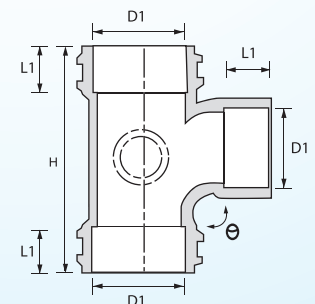

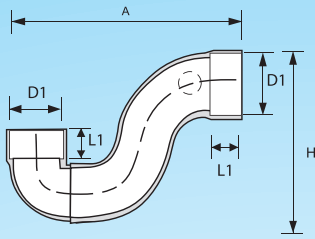

**5. Underground "P" Trap Plain**

DIMENSION (mm)					
Code No.	Size (mm)	D1	L1	A	H
UZ30-110-92	110	110.2	50	380	270

\*. Underground "P" Trap with water seal for gas-tight connection to SWV system.

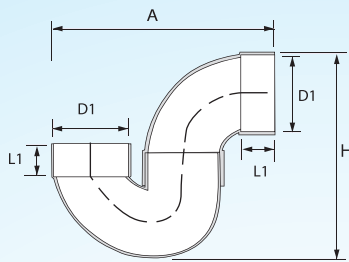

**6. Underground "P" Trap Plain (U body)**

DIMENSION (mm)					
Code No.	Size (mm)	D1	L1	A	H
UZ50-110-90	110	110.2	50	300	280

\*. Underground "P" Trap with water seal for gas-tight connection to SWV system.

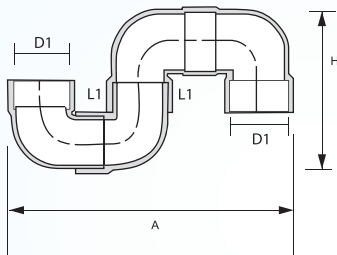

**7. Underground "S" Trap Plain**

DIMENSION (mm)					
Code No.	Size (mm)	D1	L1	A	H
US30-110-92	110	110.2	50	470	280

\*. Underground "S" Trap with water seal for gas-tight connection to SWV system.

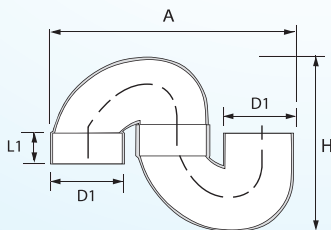

**8. Underground "S" Trap Plain (U Body)**

DIMENSION (mm)					
Code No.	Size (mm)	D1	L1	A	H
US50-110-90	110	110.2	50	390	250

\*. Underground "S" Trap with water seal for gas-tight connection to SWV system.





**9. Underground Reducing Branch**

DIMENSION (mm)							
Code No.	Size (mm)	Angle $\theta$	D1	L1	H	C	E
UE10-160x110	160x110	92.5	160.4	75	110.2	50	350

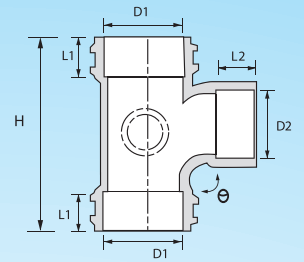

**10. 45° Underground Y-Branch**

DIMENSION (mm)					
Code No.	Size (mm)	D1	L1	H	E
UEY10-110-135	110	110.2	50	265	55.9

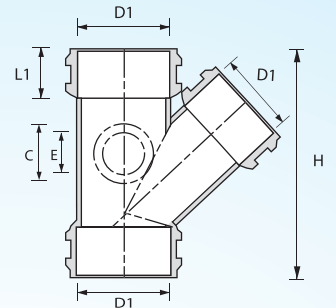

**11. Underground Bossed Bend (M/F)**

DIMENSION (mm)					
Code No.	Size (mm)	Angle $\theta$	D1	L1	L2
UB50-110-90	110	90	110.2	50	25

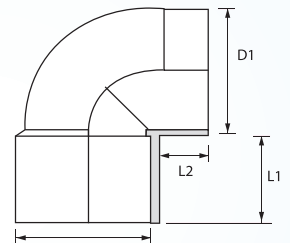

**12. Underground U Body (M/F)**

DIMENSION (mm)			
Code No.	Size (mm)	D1	L1
UU10-110-90	110	110.2	50

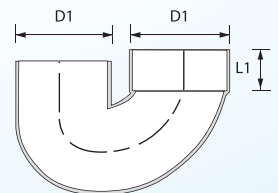

## SPECIFICATIONS OF PRESSURE PIPES



Colour : Grey  
Length : 5.8m  
Type of Joint : Solvent Cement Weld Joint

STANDARD		Wall Thickness													
		MS762				MS628								MS762	
Nominal Size	Outside Diameter (mm)	Class O		Class B (PN 6)		Class C (PN 9)		Class D (PN 12)		Class E (PN 15)		Class 7			
		Min	Max	Min	Max	Min	Max	Min	Max	Min	Max	Min	Max		
1/2	15	21.2	21.5							1.7	2.1	3.7	4.3		
3/4	20	26.6	26.9							1.9	2.5	3.9	4.5		
1	25	33.4	33.7							2.2	2.7	4.5	5.2		
1 1/4	32	42.1	42.4					2.2	2.7	2.7	3.2	4.8	5.5		
1 1/2	40	48.1	48.4	1.8	2.2			2.5	3.0	3.1	3.7	5.1	5.9		
2	50	60.2	60.5	1.8	2.2			2.5	3.0	3.1	3.7	3.9	4.5	5.5	6.3
2 1/2	65	75.0	75.3	1.8	2.2			3.0	3.5	3.9	4.5	4.8	5.5		
3	80	88.7	89.1	1.8	2.2	2.9	3.4	3.5	4.1	4.6	5.3	5.7	6.6		
4	100	114.1	114.5	2.3	2.8	3.4	4.0	4.5	5.2	6.0	6.9	7.3	8.4		
5	125	140.0	140.4	2.6	3.1	3.8	4.4	5.5	6.4	7.3	8.4	9.0	10.4		
6	155	168.0	168.5	3.1	3.7	4.5	5.2	6.6	7.6	8.8	10.2	10.8	12.5		
8	200	218.8	219.4	3.1	3.7	5.3	6.1	7.8	9.0	10.3	11.9	12.6	14.5		
10	250	272.6	273.4	3.1	3.7	6.6	7.6	9.7	11.2	12.8	14.8	15.7	18.1		
12	300	323.4	324.3	3.1	3.7	7.8	9.0	11.5	13.3	15.2	17.5	18.7	21.6		



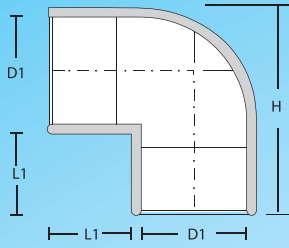

**1. Equal Elbow**

**DIMENSION (mm)**

Code No.	Size (mm)	D1	L1	H
H-B10-15	15	21.3	25	51
H-B10-20	20	26.7	26.5	57
H-B10-25	25	33.5	28	67
H-B10-32	32	42.2	32.1	81.5
H-B10-40	40	48.2	34	91.5
H-B10-50	50	60.3	40	110.5

**2. 45° Elbow**

**DIMENSION (mm)**

Code No.	Size (mm)	D1	L1
H-C10-15	15	21.3	21
H-C10-20	20	26.7	26.5
H-C10-25	25	33.5	28

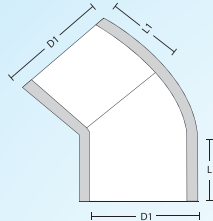

**3. Equal Tee**

**DIMENSION (mm)**

Code No.	Size (mm)	D1	L1	H
H-E10-15	15	21.3	25	73.5
H-E10-20	20	26.7	26.5	84.5
H-E10-25	25	33.5	28	102
H-E10-32	32	42.2	37.1	114.6
H-E10-40	40	48.2	34	117
H-E10-50	50	60.3	40	141

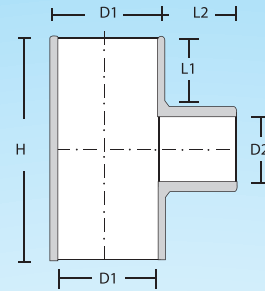
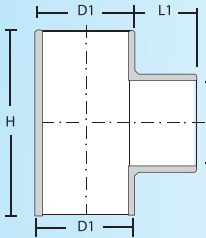

**4. Reducing Tee**

**DIMENSION (mm)**

Code No.	Size (mm)	D1	D2	H	L1	D2
H-E10-20x15	20x15	26.7	21.3	84.8	26.5	25.5
H-E10-25x15	25x15	33.5	21.3	102.5	29.5	30
H-E10-25x20	25x20	33.5	26.7	102.5	29.5	30
H-E10-32x20	32x20	42.2	26.7	114.4	50.2	28.1 *
H-E10-32x25	32x25	42.2	33.5	114.4	50.2	28.1 *
H-E10-40x15	40x15	48.2	21.3	121.5	56.5	34.1 *
H-E10-40x20	40x20	48.2	26.7	121.5	56.5	34.1 *
H-E10-40x25	40x25	48.2	33.5	121.5	56.5	34.1
H-E10-40x32	40x32	48.2	42.2	121.5	56.5	34.1 *
H-E10-50x15	50x15	60.3	21.3	145.4	69.4	42.3 *
H-E10-50x20	50x20	60.3	26.7	145.4	69.4	42.3 *
H-E10-50x25	50x25	60.3	33.5	145.4	69.4	42.3 *
H-E10-50x32	50x32	60.3	42.2	145.4	69.4	42.3 *
H-E10-50x40	50x40	60.3	48.2	145.4	69.4	42.3

\*. Coming soon



1.



2.



3.



4.



5.



6.



7.



8.

**5. Double End (DE) Socket**  
DIMENSION (mm)

Code No.	Size (mm)	D1	L1
H-L10-15	15	21.3	21.1
H-L10-20	20	26.7	22.3
H-L10-25	25	33.5	22.7
H-L10-32	32	42.2	42.5
H-L10-40	40	48.2	42.5
H-L10-50	50	60.3	51

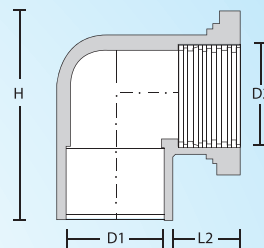
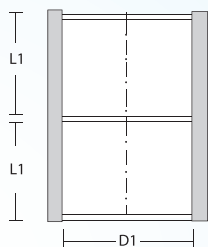

**7. Faucet (P/T) Elbow**

DIMENSION (mm)

Code No.	Size (mm)	D1	D2	L1	L2	H
H-PE10-15	15	21.3	21.2	25	16.5	59.5
H-PE10-20	20	26.7	26.8	26.5	25.5	66
H-PE10-25	25	33.5	33.5	30	29.5	71
H-PE10-32	32	42.2	42.8	41.9	24.3	75 *
H-PE10-40	40	48.2	48.8	45.1	27.2	95.1 *
H-PE10-50	50	60.3	60.2	60.0	33	106.4 *

\* Coming Soon

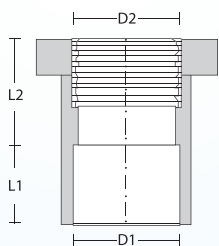

**6. Faucet (P/T) Socket**

DIMENSION (mm)

Code No.	Size (mm)	D1	D2	L1	L2
H-PT10-15	15	21.3	21.2	25	19
H-PT10-20	20	26.7	26.8	26.5	25.5
H-PT10-25	25	33.5	33.5	30	29.5
H-PT10-32	32	42.2	42.8	41.9	26.5
H-PT10-40	40	48.2	48.4	45.1	33.8
H-PT10-50	50	60.3	60.2	60.0	37.7

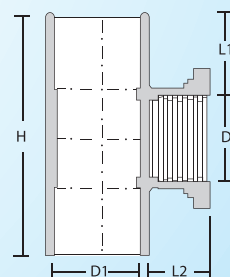

**8. Faucet (P/T) Tee**

DIMENSION (mm)

Code No.	Size (mm)	D1	D2	H	L1	L2
H-PA10-15	15	21.3	21.2	66.5	22	16



### 9. Valve Socket

DIMENSION (mm)					
Code No.	Size (mm)	D1	L1	L2	
H-VL10-15	15	21.3	26.5	17.3	
H-VL10-20	20	26.7	29.3	20	
H-VL10-25	25	33.5	31.3	23.8	
H-VL10-32	32	42.2	36.3	24.3	
H-VL10-40	40	48.2	42.6	26.3	
H-VL10-50	50	60.3	67.8	30.6	

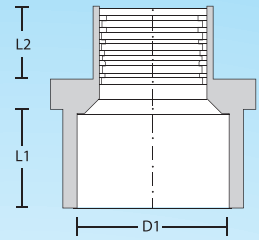

### 10. V-Tank Connector

DIMENSION (mm)					
Code No.	Size (mm)	D1	L1	L2	
H-VT10-15	15	21.3	32.8	32.8	
H-VT10-20	20	26.7	33.2	33.2	
H-VT10-25	25	33.5	42.4	40	
H-VT10-32	32	42.2	51.5	57.9	
H-VT10-40	40	48.2	62.8	56.9	
H-VT10-50	50	60.3	64.5	34.6	

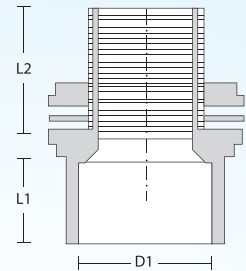

### 11. Reducing Socket

DIMENSION (mm)						
Code No.	Size (mm)	D1	D2	L1	L2	
H-Q10-20x15	20x15	21.3	26.7	17.3	20.9	
H-Q10-25x15	25x15	21.3	33.5	20	25	
H-Q10-25x20	25x20	26.7	33.5	22	25	
H-Q10-32x15	32x15	21.3	42.2	25.7	27.2 *	
H-Q10-32x20	32x20	26.7	42.2	25.9	27.2 *	
H-Q10-32x25	32x25	33.5	42.2	25.9	28.0	
H-Q10-40x15	40x15	21.3	48.2	28.0	28.7 *	
H-Q10-40x20	40x20	26.7	48.2	28.0	28.7 *	
H-Q10-40x25	40x25	33.5	48.2	28.0	28.6	
H-Q10-40x32	40x32	42.2	48.2	28.1	28.6	
H-Q10-50x15	50x15	21.3	60.3	33.4	35.5 *	
H-Q10-50x20	50x20	26.7	60.3	33.3	35.6 *	
H-Q10-50x25	50x25	33.5	60.3	36.1	34.4 *	
H-Q10-50x32	50x32	42.2	60.3	33.3	38.1	
H-Q10-50x40	50x40	48.2	60.3	33.1	35.5	

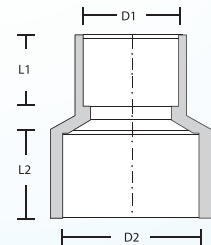

\* Coming Soon



### 12. Reducing Bush

#### DIMENSION (mm)

Code No.	Size (mm)	D1	D2	L1
H-Q30-20x15	20x15	26.7	21.3	21.2
H-Q30-25x15	25x15	33.5	21.3	26.8
H-Q30-25x20	25x20	33.5	26.7	26.8
H-Q30-32x15	32x15	42.2	21.3	31.7 *
H-Q30-32x20	32x20	42.2	26.7	31.7 *
H-Q30-32x25	32x25	42.2	33.5	31.7
H-Q30-40x15	40x15	48.2	21.3	34 *
H-Q30-40x20	40x20	48.2	26.7	34 *
H-Q30-40x25	40x25	48.2	33.5	34
H-Q30-40x32	40x32	48.2	42.2	34
H-Q30-50x15	50x15	60.3	21.3	39 *
H-Q30-50x20	50x20	60.3	26.7	39 *
H-Q30-50x25	50x25	60.3	33.5	39 *
H-Q30-50x32	50x32	60.3	42.2	39
H-Q30-50x40	50x40	60.3	48.2	39

\* Coming Soon

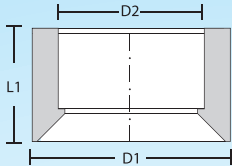

12.

### 13. End Cap

#### DIMENSION (mm)

Code No.	Size (mm)	D1	L1
H-EC10-15	15	21.3	18
H-EC10-20	20	26.7	21.1
H-EC10-25	25	33.5	25
H-EC10-32	32	42.2	31.6
H-EC10-40	40	48.2	31.7
H-EC10-50	50	60.3	32

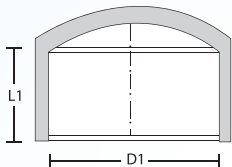

13.

### 14. Plug

#### DIMENSION (mm)

Code No.	Size (mm)	L1
H-P10-15	15	12.5

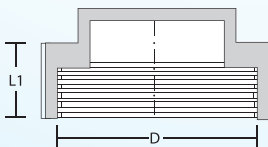

14.



## SPECIFICATIONS OF CONDUITS FOR UNDERGROUND TELECOMMUNICATION CABLE

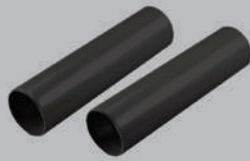

Colour : Black  
Length : 6m  
Type of Joint : Solvent Cement Weld Joint

### MS 1034

Nominal Size		Outside Diameter (mm)		Wall Thickness (mm)		Internal Diameter			
(inches)	(mm)	Min	Max	Min	Max	S		M	
						Min	Max	Min	Max
4	107	107.0	108.0	2.6	3.0	106.0	107.0	109.0	110.0

YTL, The Fennel, Sentul East



One residences @ chan sow lin



Westside 1 desa park city



KL GATEWAY @ Bangsar



The Henge @ Kepong



Ekocheras



Novum



Icon City



Sunway Geo



---

**Typical soil, waste and vent  
piping layout for 2 storey house  
using SAE SWV pipes & fittings**

---

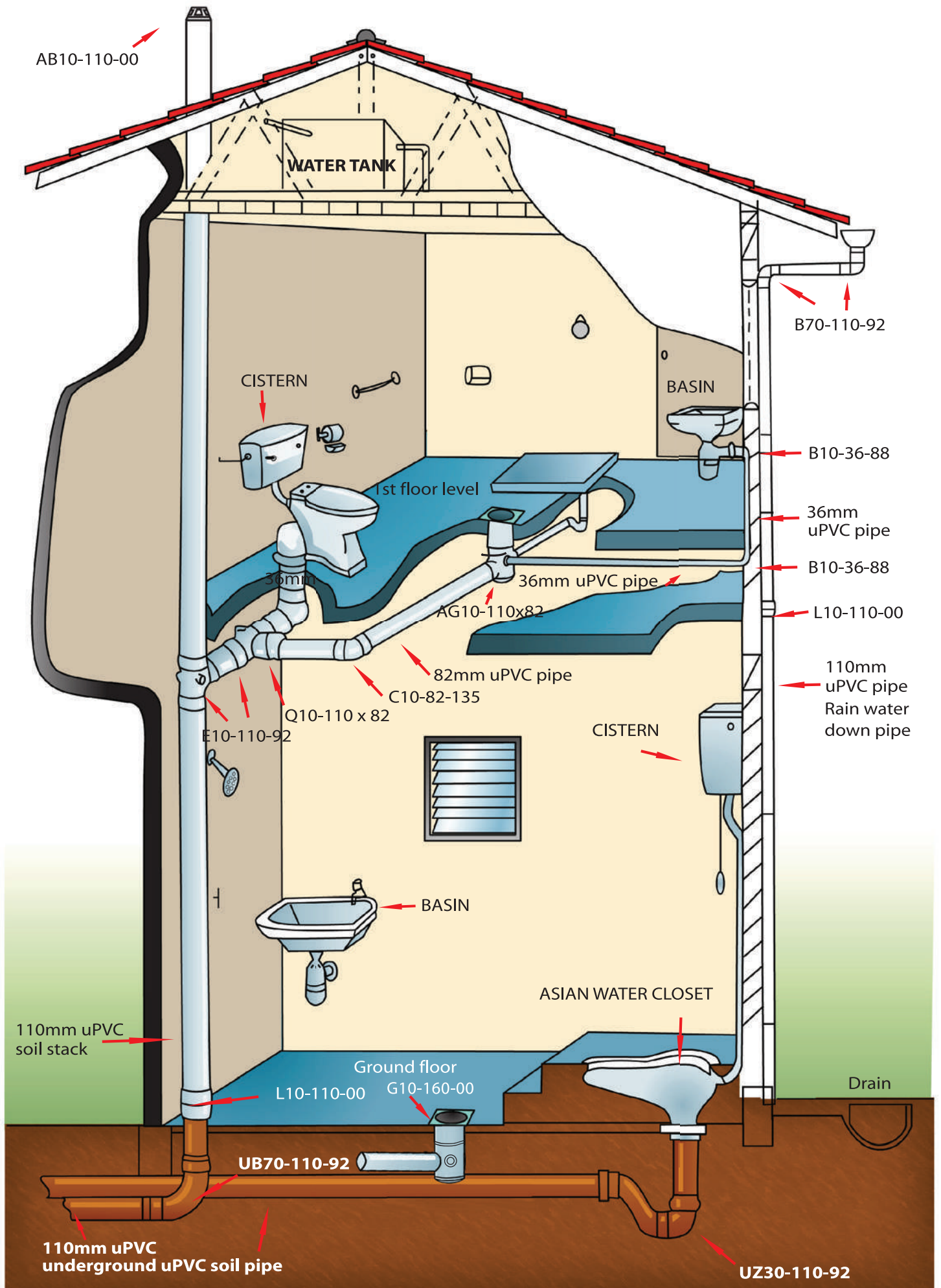

# Range of certification

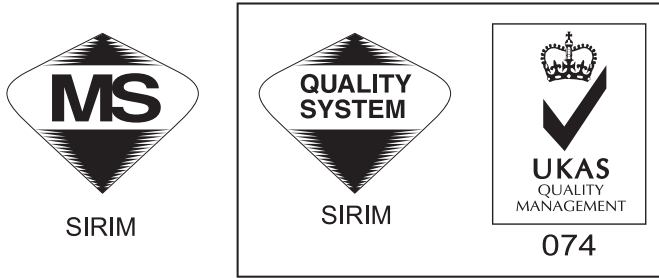

MS ISO 9001 REG. NO. AR2032





---

## The Quality Policy

We are committed to comply with ISO 9001:2015 requirements and to enhance our customers' satisfaction through continuous improvement on product quality, JIT delivery and competitive pricing.

---

## Achievement

1. uPVC soil, waste and vent applications  
MS 1063 : 2002 Application area code : B & BD  
( BS 5255 / BS 4514 / BS EN 1329 )
2. uPVC underground drainage applications - Fitting  
MS 1063 : 2002 Application area code : D  
( BS EN 1329 )
3. uPVC underground drainage applications - Pipe  
MS 979 : 1985  
( BS 4660 )
4. uPVC water supply applications - Pipe  
MS 628 : PART 1 :1999
5. uPVC water supply applications - Fitting  
MS 628 : PART 2 : SECTION 2.1 : 1999
6. uPVC rainwater applications  
BS EN 12200 - 1 : 2016
7. PVC conduit for underground telecommunication cables  
MS 1034 : 1986
8. Quality Management Systems  
ISO 9001 : 2015
9. SPAN approval
10. IKRAM listing
11. Local authorities approval





### **Disclaimer Statement**

1. All information and illustrations contained in this catalogue are for reference purpose and does not constitute endorsement to any party(ies).
2. Information and illustrations contained in this catalogue are subject to change without notice.
3. Actual product sizes may differ from the illustration due to rationing and spacing alignment.
4. Without limiting the rights under copyright, no part of this catalogue may be reproduced, store into a retrieval system or transmitted in any form or by any means.



---

**ANSON EXACT CORPORATION (M) SDN BHD (654633-W)**

Lot 19089, Jalan Taming Jaya 1, Taman Taming Jaya,  
43300 Balakong, Selangor Darul Ehsan, Malaysia  
Tel : +603 8961 1999 Fax : +603 8961 1000  
Website : [www.sae.com.my](http://www.sae.com.my)  
Email : [enquiry@sae.com.my](mailto:enquiry@sae.com.my)

**SOUTH ASIA FIBRE INDUSTRIES SDN BHD (21764-V)**

Lot 69, Jalan Portland, Tasek Industrial Estate,  
31400 Ipoh, Perak Darul Ridzuan, Malaysia  
Tel : +605 2919 961 Fax : +605 2919 963  
Ver.3 (Oct 19)