

Hygienic Progressing Cavity Pumps  
**WANGEN MX**

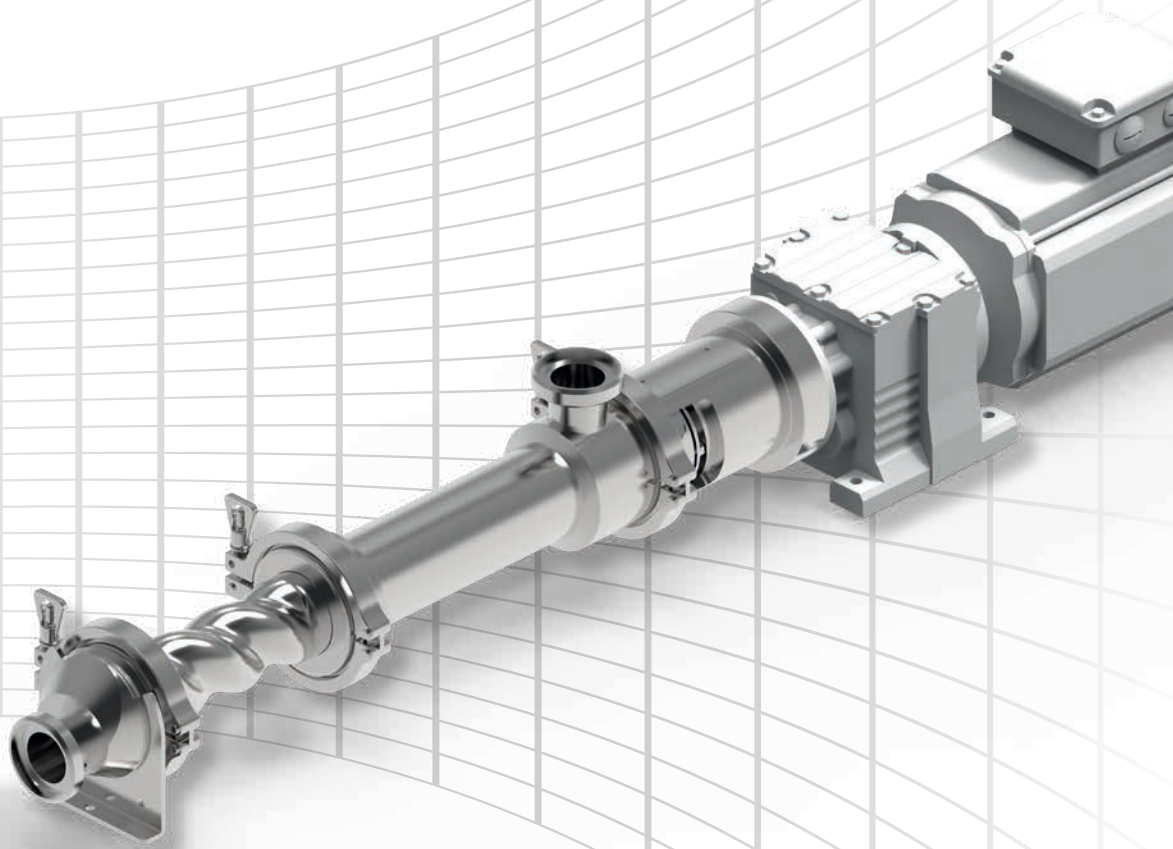

For demanding hygienic conveying  
and dosing in the food & beverage-,  
pharmaceutical and cosmetics industry

# WANGEN MX



The WANGEN MX progressing cavity pump precisely fulfills the demanding requirements of the food, pharmaceutical and cosmetics industries. State-of-the-art design features allow excellent ease of cleaning and maintenance. Therefore, the pump is available with all common certificates. And thanks to its great pressure stability, the MX can also be used in many ways in the chemical, paint and paper industries, among others.



MX 20S





















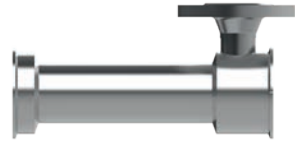

Designation \_\_\_\_\_  
Size \_\_\_\_\_  
Model \_\_\_\_\_

Size: Drive shaft diameter

Models: Suction, submersible, hopper, follower plate versions

## Modular design

The modular design of the MX makes it suitable for numerous applications and extremely easy to maintain. The wide variety of components enable the pump to be modified in the optimum way to suit customers' specific applications.

				
Discharge nozzle DIN32676	Stator EW40/10	Suction housing DIN32676	Hygienic mechanical seal MXHS	
				
Discharge nozzle tangential outlet	Stator EW25/10 with double jacket	Suction housing with CIP nozzle and double jacket	Double acting mechanical seal for quench MXHS-MXEB	
				
Discharge nozzle DIN11851	Stator EW30/10	Suction housing DIN11851	Elastomer bellow mechanical seal MXEB	Gear motor in aseptic design
				
Discharge nozzle EN1092-1	Stator EW15/40	Suction housing EN1092-1	PS shaft seal with flushing	Spur gear motor
				
Discharge nozzle DIN11864-1	Stator EW20/20	Rectangular hopper housing with two CIP nozzles	Gland packing with flushing	Servo gear motor

# Design characteristics

---

## Advantages

1. 10 bar per pressure stage thanks to EvenWall® technology
2. Compact assembly length at high pressures
3. Low-impact product delivery
4. Quick and easy to clean
5. Captive connecting elements
6. Modular design
7. Outstanding stability under pressure

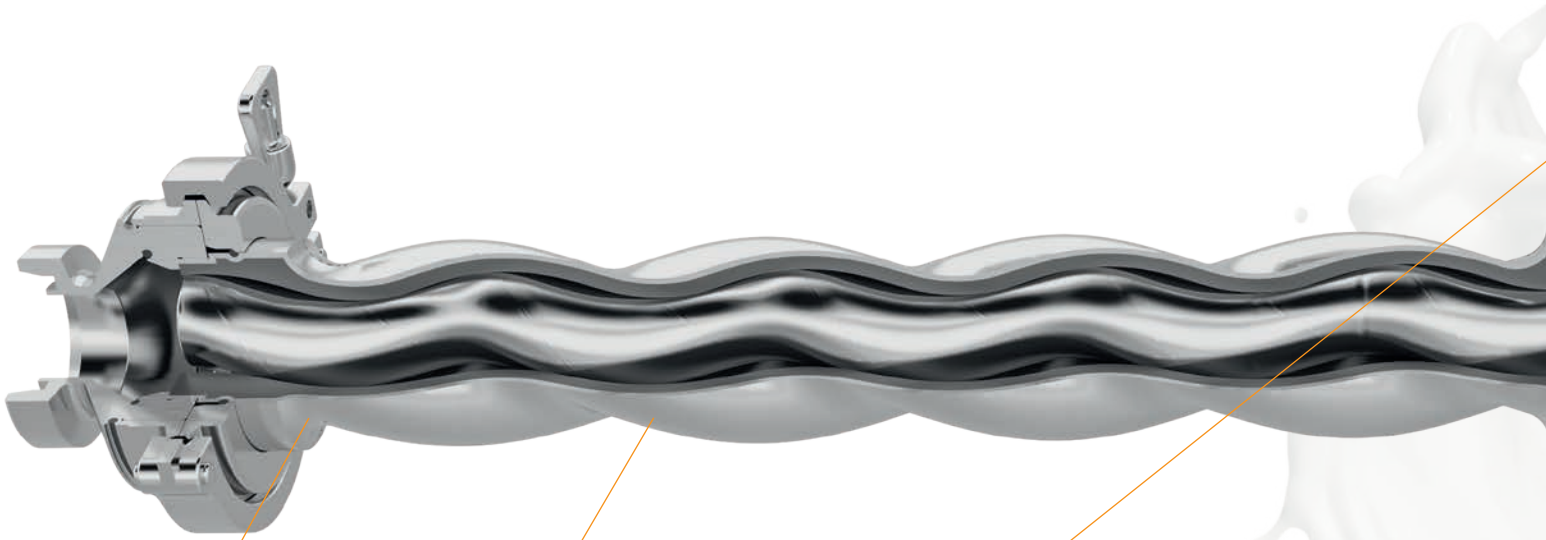

Modular design  
(various pump  
assemblies can  
be adapted)

Stators in EvenWall®  
design (uniform  
elastomer wall  
thickness)

Fast disassembly and  
assembly by means of  
clamping closures

Cardan joint,  
covered with  
hygienic collar

### Characteristics

- Compatible with CIP and SIP
- Hygienic design
- Design with minimal dead space
- Extremely easy to service
- Intelligent interfaces

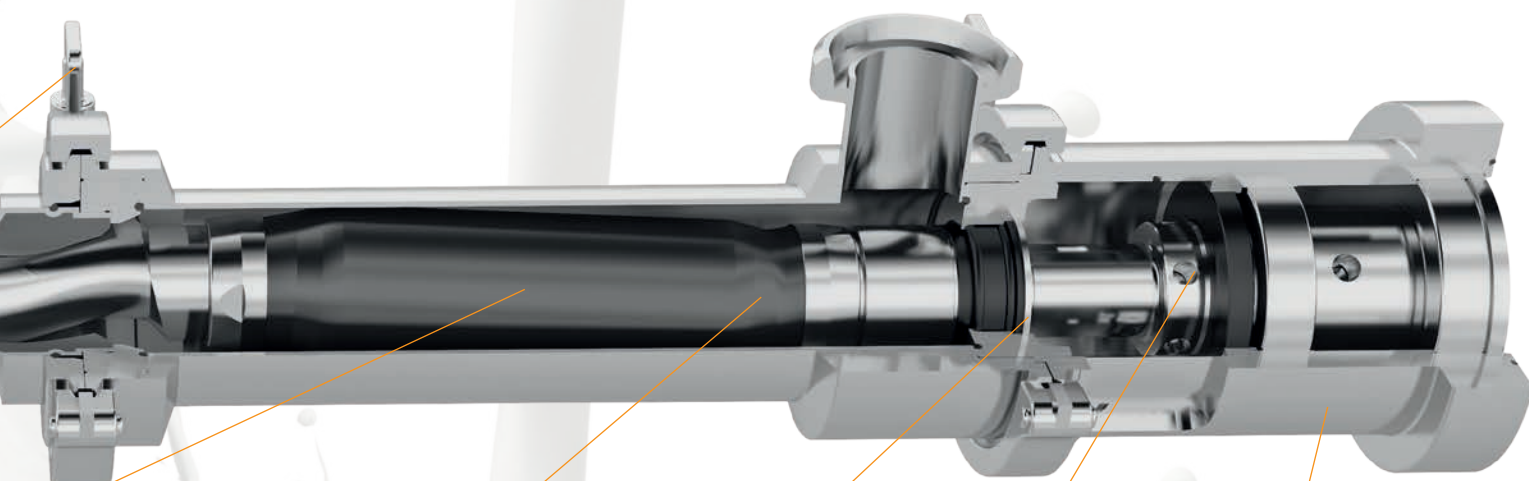

Non-slip cylindrical connection elements prevent the unintentional loosening of pump components

Spacious sealing chamber for all seal assemblies

Wear parts can be replaced quickly via a separation point opposite the product

Robust and splash-resistant bearing housing enables a fully assembled „standby pump“ to be fitted even without a drive

# MX-F

Pump size	Maximum completely free passage (mm)	Flowrate (l/h)	Maximum differential pressure (bar)
10	6	1 to 75	20
20	22	5 to 5.600	20
30	48	50 to 20.000	20
50	76	500 to 100.000	20

### Application

- Drum and hopper drained via follower plate
- Low-impact delivery of products containing solids

### Features

- Self-priming pump
- Short assembly length
- Uniform metering with low pulsation

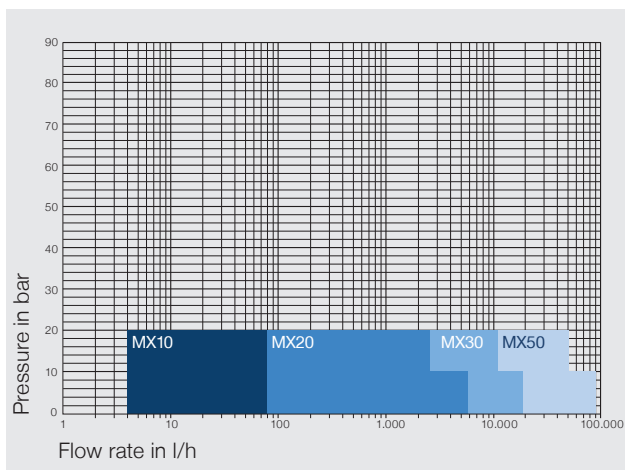

Details based on a medium with a viscosity of 1 mPas and a density of 1.0 kg/dm³

Pump size	Maximum completely free passage (mm)	Flowrate (l/h)	Maximum differential pressure (bar)
20	22	5 to 5.600	40
30	48	50 to 20.000	80
50	76	500 to 100.000	60



### Application

- Highly viscous to airtight media
- Suitable for media with a high solids content
- Metering and transferring applications

### Features

- Conical screw conveyor ensures optimum emptying of the hopper floor
- Position of the mechanical seal ensures excellent cleanability
- Well-designed separation points for easy disassembly
- Trough shape prevents deposits from forming on the hopper walls
- Additional extension hopper can be adapted
- Reliable delivery of the medium to the pump assembly thanks to stable screw conveyor shortly before the pump assembly
- Overfeeding in the pump tunnel ensures efficient conveying

### Example MX50R: Baked goods industry

Medium: dough  
 Flow rate: 5,800 l/h  
 Pressure: 6 bar  
 Viscosity: 12,000 mPas

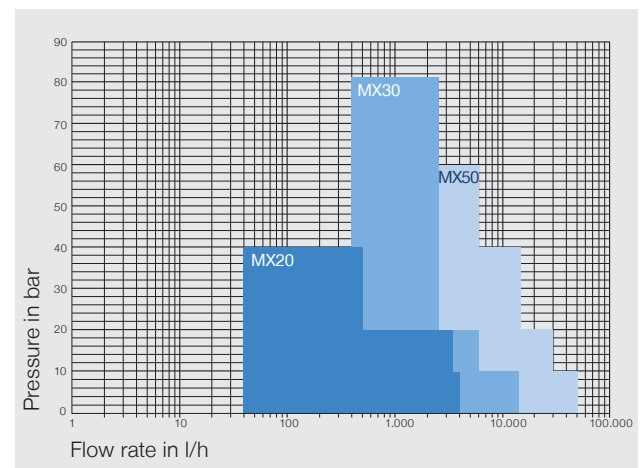
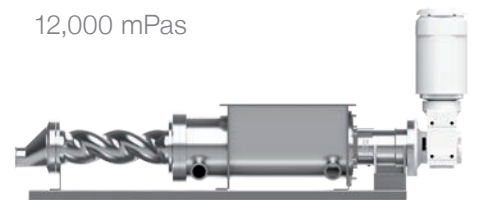

Details based on a medium with a viscosity of 1 mPas and a density of 1.0 kg/dm<sup>3</sup>

# MX-S

Pump size	Maximum completely free passage (mm)	Flowrate (l/h)	Maximum differential pressure (bar)
10	6	1 to 75	40
20	22	5 to 5.600	40
30	48	50 to 20.000	80
50	76	500 to 100.000	60

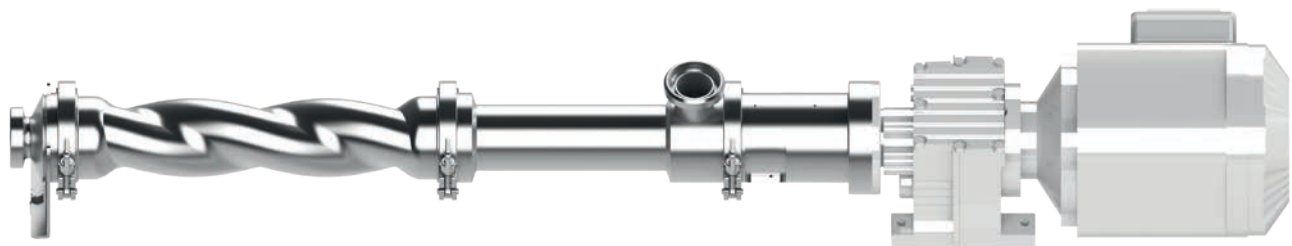

### Application

- Metering and transferring applications
- Suitable for aqueous to highly viscous media
- Low-impact delivery of products containing solids

### Features

- Vertical and horizontal configuration possible
- Can be used regardless of the direction of rotation
- Self-priming pump to 0.8 bar absolute
- Available as a mobile or stationary pump
- CIP and SIP cleaning possible
- Ability to control the temperature of the entire pump
- Short assembly length

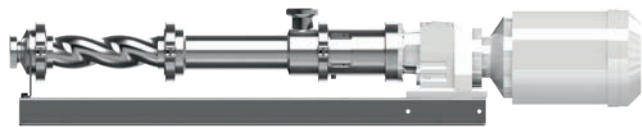

#### Example MX20S: Pet food industry

Medium: Meat Slurry  
 Flow rate: 78 l/h  
 Pressure: 10 bar  
 Viscosity: 1,500 mPas

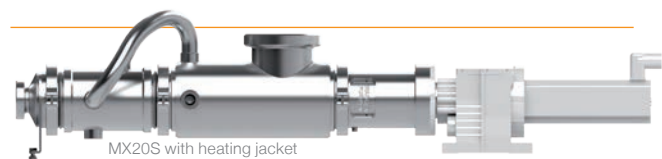

#### Example MX20S: Confectionary industry

Medium: fat / fruit puree  
 Flow rate: 450 l/h  
 Pressure: 7 bar  
 Viscosity: 70,000 mPas

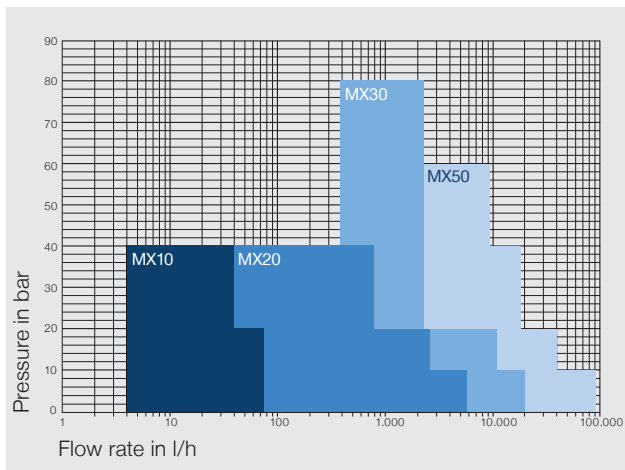

Details based on a medium with a viscosity of 1 mPas and a density of 1.0 kg/dm³



#### Example MX50S: Food industry

Medium: Dairy products  
 Flow rate: 300 – 3,000 l/h  
 Pressure: 30 bar  
 Viscosity: 1,300 mPas



Pump size	Maximum completely free passage (mm)	Flowrate (l/h)	Maximum differential pressure (bar)
20	22	5 to 5.600	10
30	48	50 to 20.000	10

### Application

- Metering and transferring applications
- Suitable for aqueous to highly viscous media
- Low-impact delivery of products containing solids

### Features

- Easy to drain drums, mixers, agitators and big bags
- Short assembly length
- Cassette design with minimal dead space
- Uniform metering with low pulsation
- Quick and easy to clean

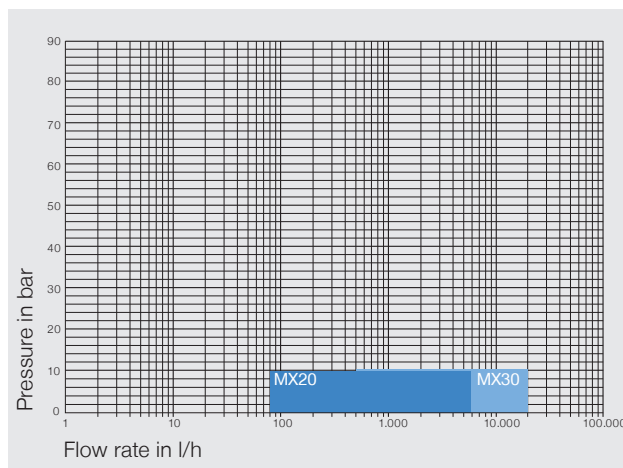

Details based on a medium with a viscosity of 1 mPas and a density of 1.0 kg/dm<sup>3</sup>

# Options and Materials

## Double jacket for tempering



Pump assembly with double jacket



Suction housing with double jacket



Hopper housing with double jacket

## Base plates



Base plate in cap profile



Base plate with height adjustable feet



Hygienic base frame



Mobile base plate

## Materials

### Materials in contact with the product:

1.4571, 1.4404, 1.4301

### Elastomer parts:

Elastomers in different qualities, with conformity FDA 21 CFR 177.2600 and EU 1935/2004

### Connections:

DIN11851, DIN32676, DIN11864-1, DIN11864-2, DIN11864-3, DIN EN1092-1



# The MX Pumps in Use

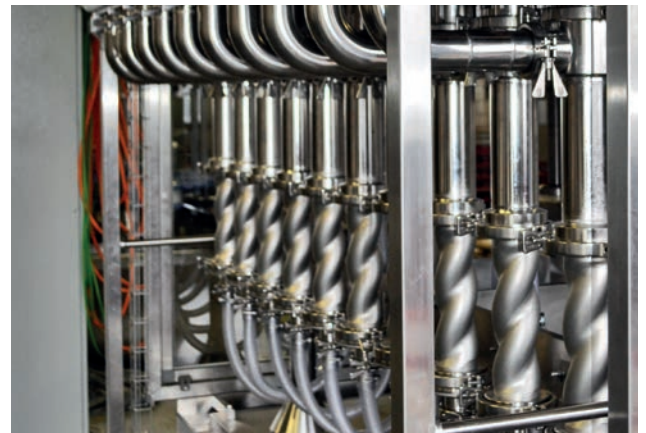



**WANGEN PUMPEN is certified to:**

ISO 9001 (Quality management)

ISO 14001 (Environmental management)

ISO 45001 (Occupational safety and health protection)

Your contact:

**Pumpenfabrik Wangen GmbH**

Simoniusstrasse 17  
88239 Wangen im Allgäu  
Germany  
www.wangen.com

Technical advice: +49 7522 997-0  
Service hotline: +49 7522 997-997  
Spare parts: +49 7522 997-896