

LIEW KAH SIN SDN BHD'S KERB PROFLE

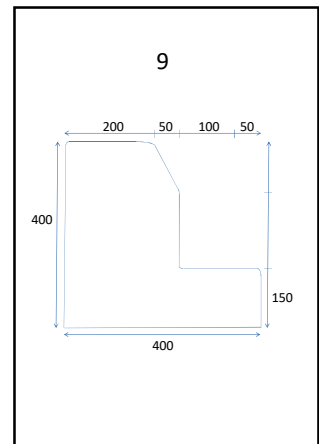

LIEW KAH SIN SDN BHD'S KERB PROFLE

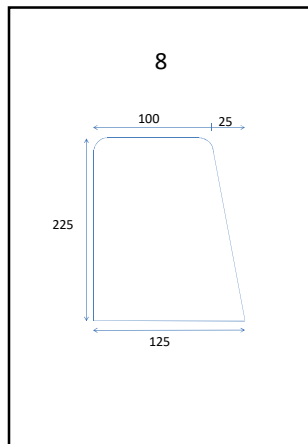
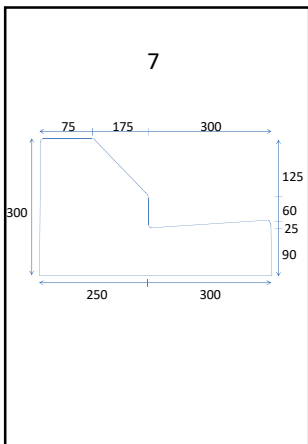
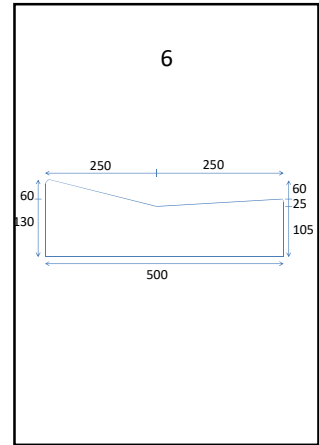
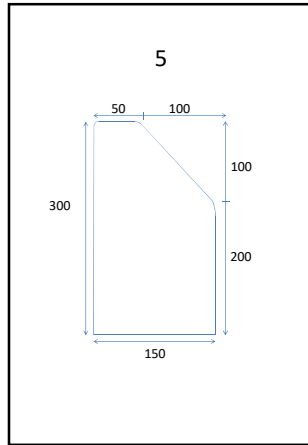
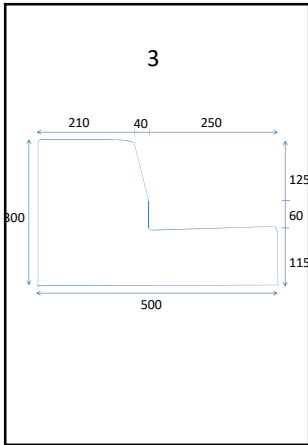
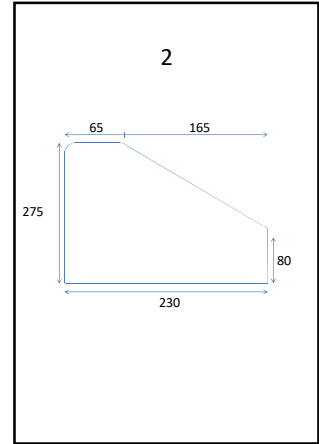
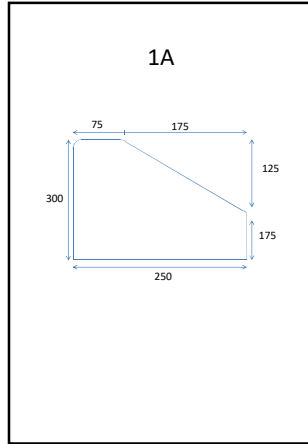
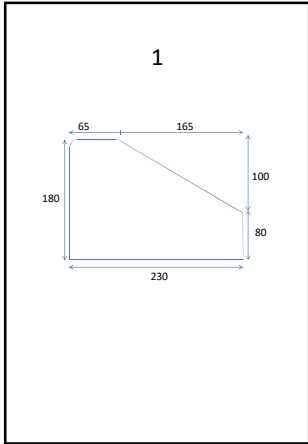
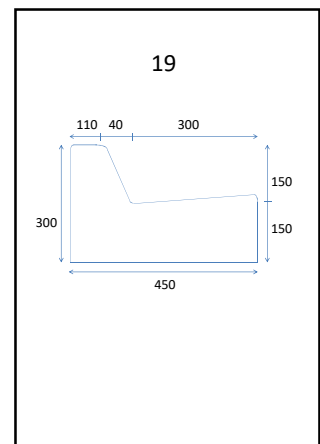
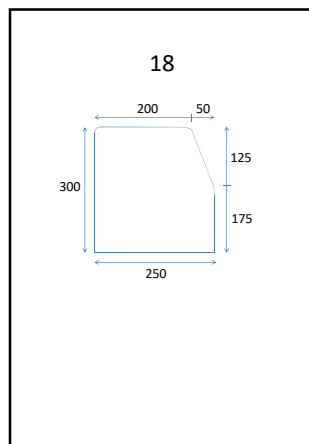
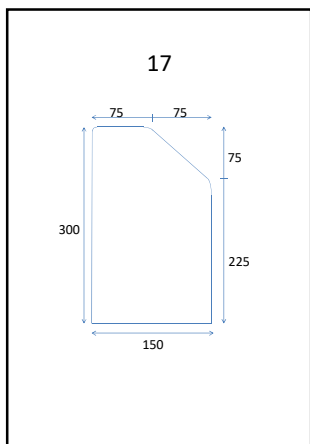
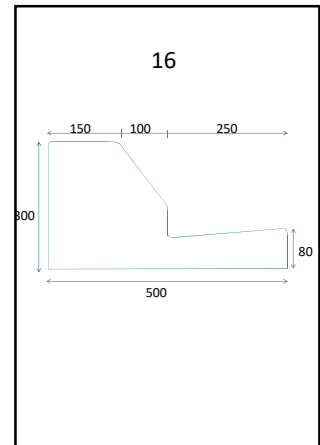
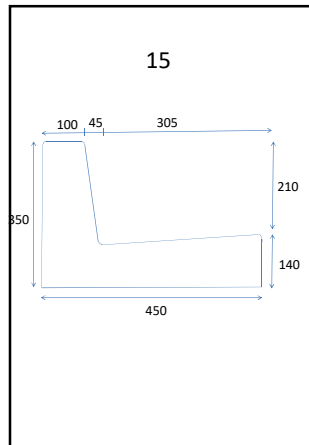
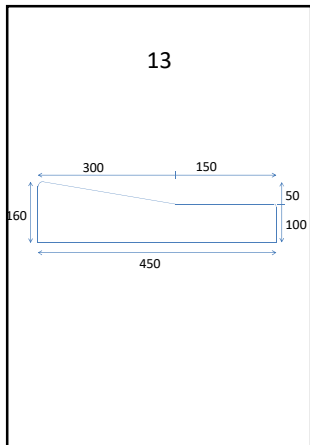
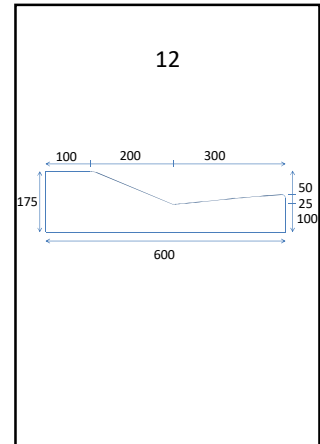
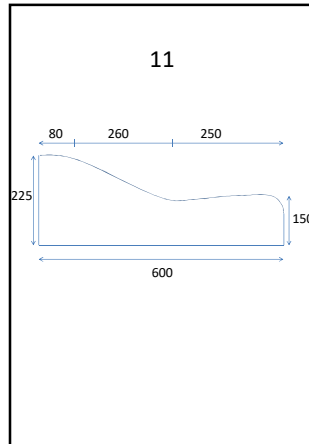
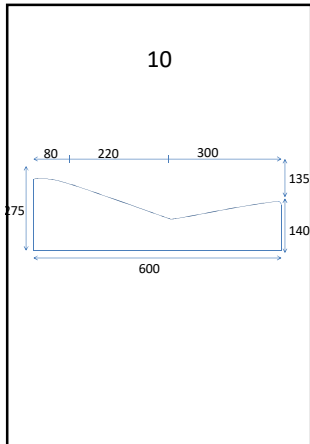

LIEW KAH SIN SDN BHD'S KERB PROFLE

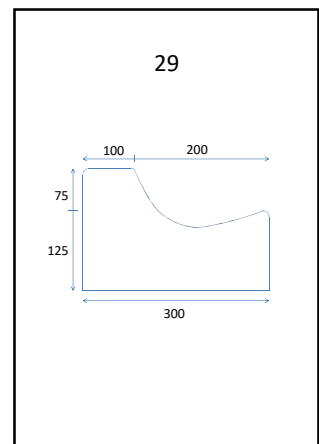
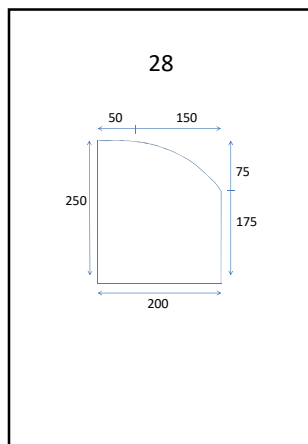
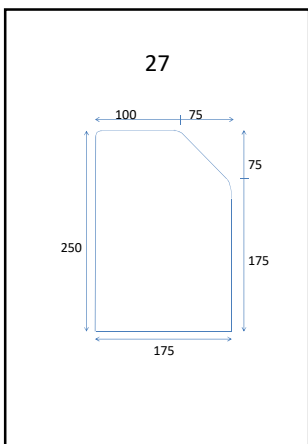
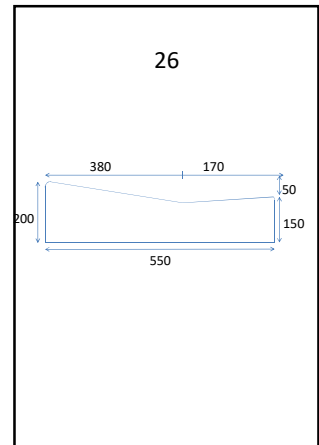
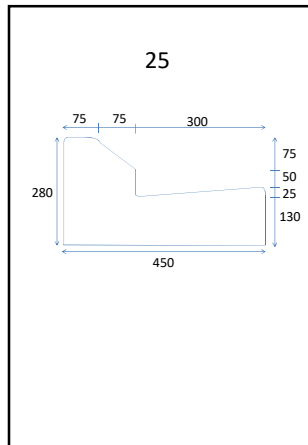
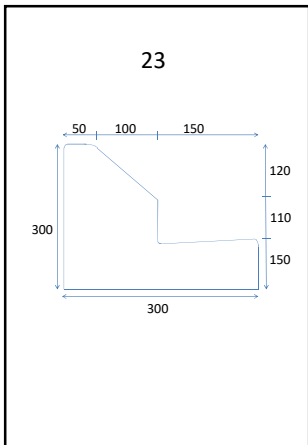
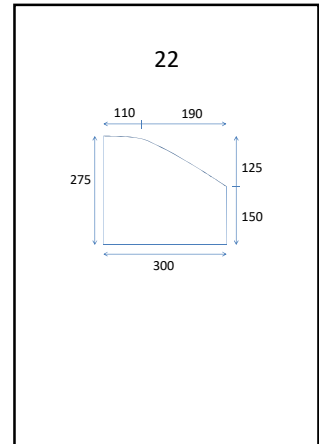
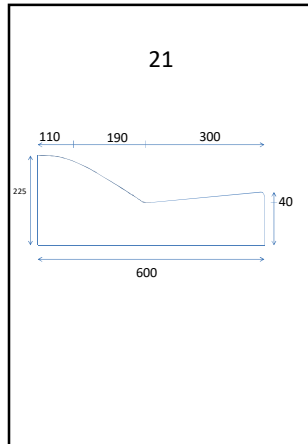
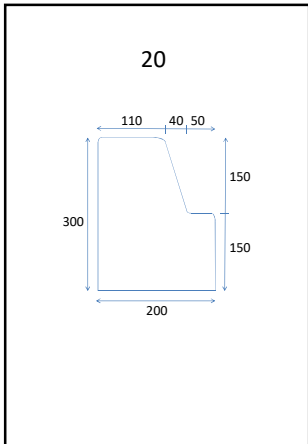

LIEW KAH SIN SDN BHD'S KERB PROFLE

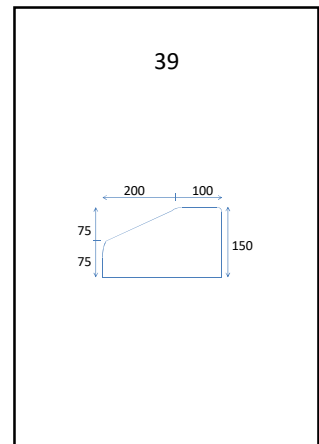
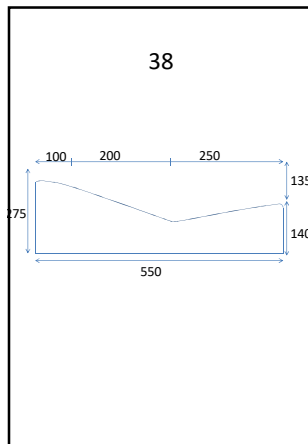
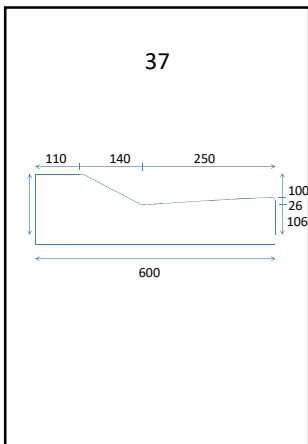
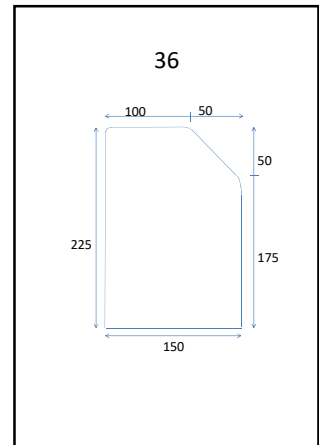
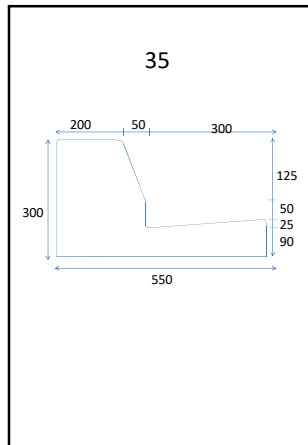
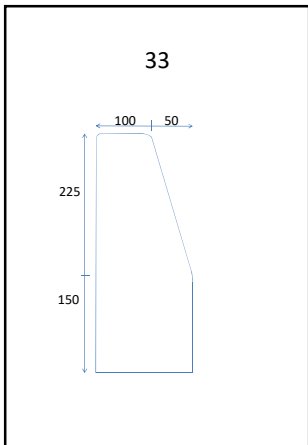
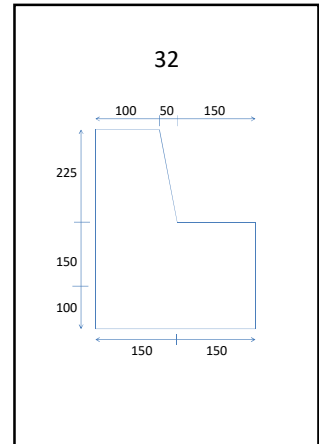
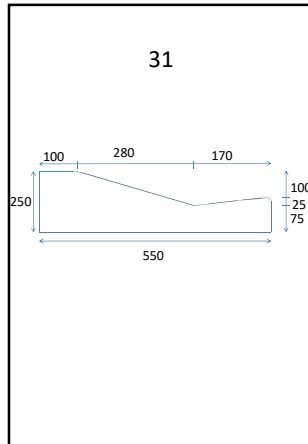
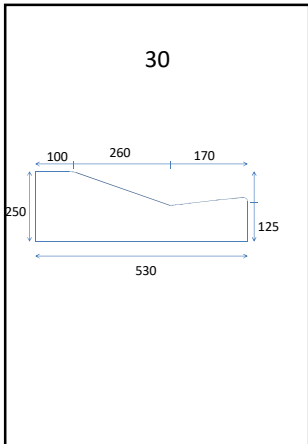

LIEW KAH SIN SDN BHD'S KERB PROFLE

41

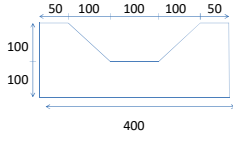

43

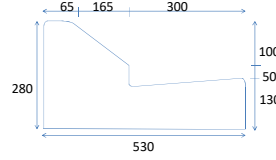

44

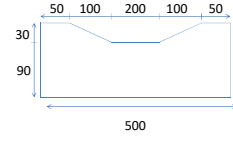

45

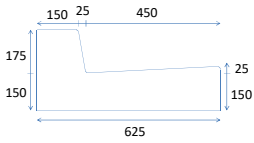

46

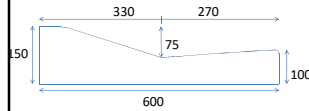

47

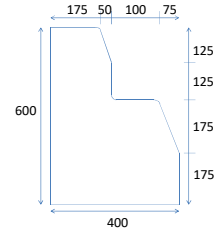

48

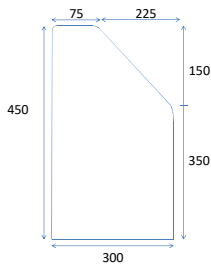

49

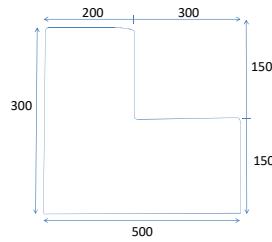

50

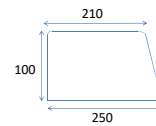

LIEW KAH SIN SDN BHD'S KERB PROFLE

