

# MineralPURE®

*The Healthy Alternative to Chlorine*

## INSTALLATION & POOL CARE MANUAL

### MODELS

CS-75, CS-150, CS-225, CS-300, CS-450 & CS-600



**CS-75**  
handles up to 75,000 gallons



**CS-150**  
handles up to 150,000 gallons



**CS-225**  
handles up to 225,000 gallons



**CS-300**  
handles up to 300,000 gallons



**CS-450**  
handles up to 450,000 gallons



**CS-600**  
handles up to 600,000 gallons



## COMMERCIAL POOLS





# Table of Contents



## Models CS-75 thru CS-600 Commercial Models Series

	<u>Page</u>
A.) Important Safety Instructions .....	4
B.) Identifying the CS Components .....	5
C.) Tools and Materials Required.....	6
D.) Site Survey .....	6
E.) Installing the Electrode Chambers .....	7-10
F.) Installing the Control Box.....	11-12
G.) Balancing the Pool's Water.....	13
H.) Starting Up the System / Operating Instructions .....	14
I.) Proper Procedures of Maintaining a Healthy Pool .....	15
J.) Cleaning and/or Replacing the Electrode(s) / User Maintenance.....	16
K.) CS Control Box Features.....	17-20
L.) Troubleshooting.....	21-22
M.) Sample Installation Drawing for State and Local Authorities .....	23
N.) Optional Components for CS Units .....	24
O.) Commercial Ionizer Specifications .....	25-26



## A.) Important Safety Instructions

# IMPORTANT SAFETY INSTRUCTIONS

When installing and using this electrical equipment, basic safety precautions should always be followed, including the following:

## 1. READ AND FOLLOW ALL INSTRUCTIONS.

2. For Models: CS-75, CS-150, CS-225, CS-300, CS-450, and CS-600

**WARNING** - To reduce the risk of injury, do not permit children to use this product unless they are closely supervised at all times.

3. For all permanently-installed units intended for use on 15 or 20 ampere, 110 through 240 volt, single phase branch circuits

**WARNING - Risk of Electric Shock.** Connect only to a branch circuit protected by a ground-fault circuit-interrupter (GFCI). Contact a qualified electrician if you cannot verify that the circuit is protected by a GFCI.

4. (For all permanently installed units intended for use on 15 or 20 ampere, 110 through 240 volt, single phase branch circuits.)

The unit must be connected only to a supply circuit that is protected by a ground-fault circuit-interrupter (GFCI). Such a GFCI should be provided by the installer and should be tested on a routine basis. To test the GFCI, push the test button. The GFCI should interrupt power. Push the reset button. Power should be restored. If the GFCI fails to operate in this manner, the GFCI is defective. If the GFCI interrupts power to the unit without the test button being pushed, a ground current is flowing, indicating the possibility of an electric shock. Do not use this unit. Disconnect the unit and have the problem corrected by a qualified service representative before using.

## 5. SAVE THESE INSTRUCTIONS.

6. (only on metal enclosures)

A wire connector is provided on this unit to connect a minimum No. 8 AWG (8.4 mm<sup>2</sup>) solid copper conductor between this unit and any metal equipment, metal enclosures of electrical equipment, metal water pipe, or conduit within 5 feet (1.5 m) of the unit.

7. **DANGER - Risk of electric shock.**

Install at least 5 feet (1.5 m) from all metal surfaces. As an alternative, a spa may be installed within 5 feet of metal surfaces, if each metal surface is permanently connected by a minimum No. 8 AWG (8.4 mm<sup>2</sup>) solid copper conductor to the wire connector on the terminal box that is provided for this purpose.

## B.) Identifying the CS Components

It is the installer's responsibility insure any city, state or national health code/ swimming pool regulations be followed in accordance for installation of this equipment. This product is approved by NSF International Standard 50 and UL/cUL listed under file number E354947.



Control Box



Enclosure Lid  
Securing Screws (2)



Copper Test Kit  
(CLA-41)



CS Models Quick Chart  
(Blue Sheet)



Installation Manual

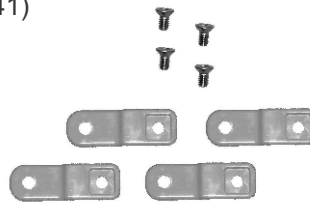

Control Unit Mounting Brackets (4)  
Mounting Bracket Screws (4)



3-Year Warranty Card



6" long copper  
electrode, 3" (CLE-05)



PVC Tee 3" (CLF-57)



15 feet coil(s) of  
grey electrode cable per channel

CS-75	1 electrode	1 PVC Tee	1 Coil of Grey Electrode Cable
CS-150	2 electrodes	2 PVC Tees or 1 Cross Tee*	2 Coils of Grey Electrode Cable
CS-225	3 electrodes	3 PVC Tees or 1 Tee and 1 Cross Tee*	3 Coils of Grey Electrode Cable
CS-300	4 electrodes	4 PVC Tees or 2 PVC Cross Tees*	4 Coils of Grey Electrode Cable
CS-450	6 electrodes	6 PVC Tees or 3 PVC Cross Tees*	6 Coils of Grey Electrode Cable
CS-600	8 electrodes	8 PVC Tees or 4 PVC Cross Tees*	8 Coils of Grey Electrode Cable

\* Customers option between tee's and crosses

**Optional Components for CS units see page 24**

## C.) Tools and Materials Required



- Bullet Level
- Conduit Connector, ½" Straight
- Crescent Wrench
- Hacksaw or Pipe Cutter
- PVC Cement
- Screwdrivers, Flat & Phillips
- Teflon Tape or Liquid Teflon
- Voltage Meter
- Channel Lock Wrench
- Conduit, Flexible/Electric hookup cable
- Drill & Drill Bits
- Hammer
- PVC Cleaner/Primer
- Screws & Anchors
- Utility Knife
- Wire Stripper
- Other tools may be required

## D.) Site Survey

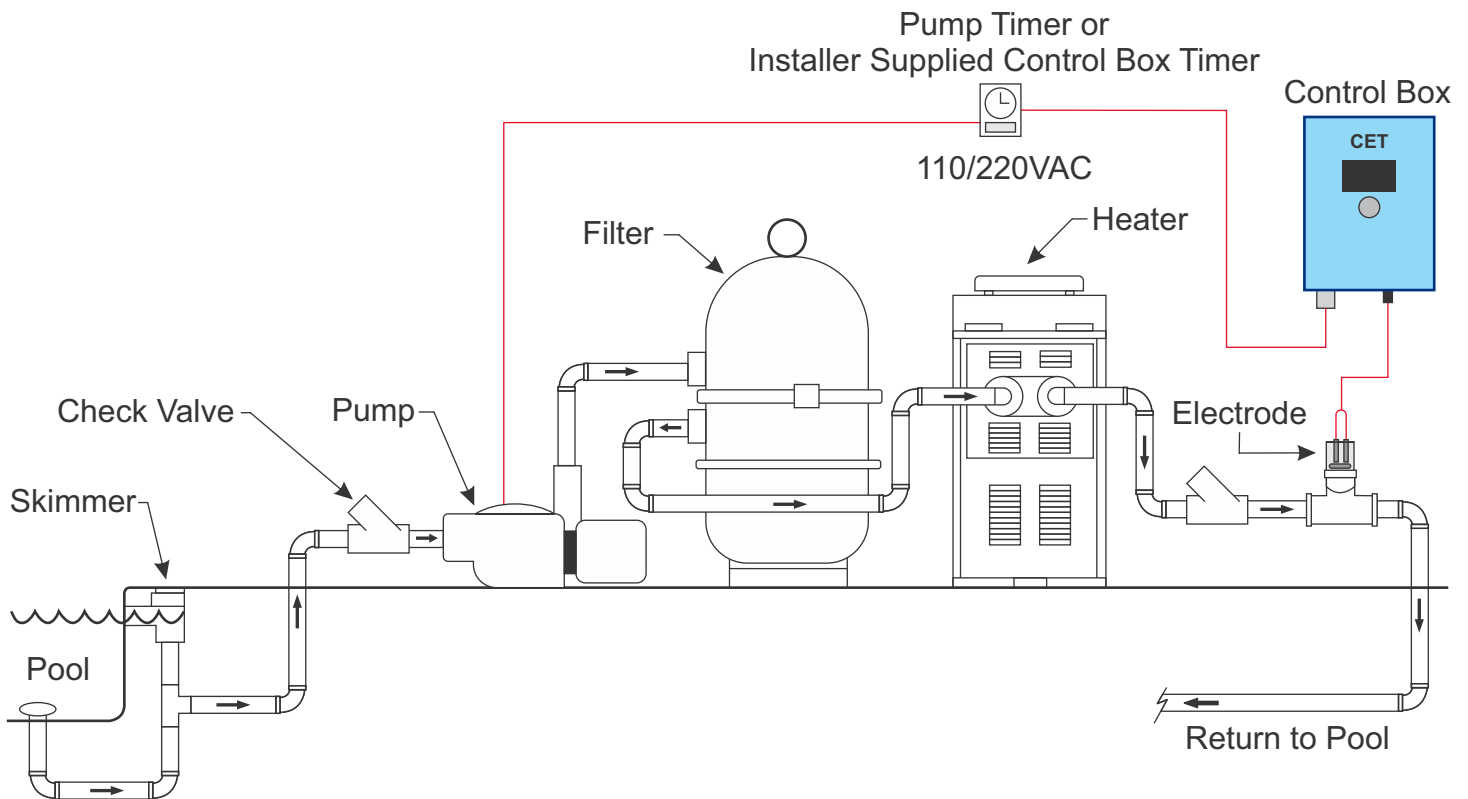

The MineralPURE unit should be installed at the pool's pump and filter area. The preferable location to mount the electrode chamber(s) is after the pools pump and filter, but it can be installed before the pools pump and filter if needed. The chamber(s) will need to be within 15 feet of the control box for an electrical connection. The control box will need to be within 11 feet of an electrical source.

## E.) Installing the Electrode Chamber(s)

After determining the location to plum in the electrodes you will have to decide the best way to accomplish this task. It is usually pretty simple with a one or two electrode install but can get trickier with the multi electrode installs. The pictures below should help the installer by supplying some ideas from actual installs.



<<< The picture to the left shows an install of a CS-75 on a 3" PVC line using a compression fitting, 3" sch 40 tee (CLF-49) and 6" set of electrodes (CLE-05).

The picture to the right shows an install of a CS-75 on a 3" PVC line using a 3" sch 40 tee (CLF-49) and 6" set of electrodes (CLE-05). The installer used split loom tubing as a conduit for the electrode cable run back to the control unit. >>>



<<< The picture to the left shows an install of a CS-75 on a 3" PVC line using a 3" sch 40 tee (CLF-49) and 6" set of electrodes (CLE-05).

## E.) Installing the Electrode Chamber(s)

(continued)



<<< The picture to the left shows an install of a CS-150 on a 3" PVC line using two sets of 3" sch 40 tees (CLF-49) and two sets of 6" electrodes (CLE-05). Notice the compression fitting at the bottom of the second electrode.

The picture to the right shows an install of a CS-150 on a 6" PVC line using two sets of 6"x6"x3" sch 40 tees (custom) and two 6" sets of electrodes (CLE-05). Notice the compression fitting to the right side of the electrodes and the flow meter between the two. >>>



<<< The picture to the left shows an install of a CS-150 on a 6" PVC line using two sets of 6"x6"x3" sch 40 tees (custom) and 6" sets of electrodes (CLE-05). Notice the compression fitting to the right side of the electrodes.



## E.) Installing the Electrode Chamber(s)

(continued)



<<< The picture to the left shows an install of a CS-150 on a 2.5" PVC line using two sets of 3" sch 40 tees (CLF-49) and two sets of 6" electrodes (CLE-05). Notice the two reducer bushing from 3" to 2.5" on the tee, and the use of a compression fitting at the bottom of the second electrode.

The picture to the right shows an install of a CS-300 on a 6" PVC line using four sets of 6"x6"x3" sch 40 tees (custom) and four sets of 6" electrodes (CLE-05). Notice the use of a union fitting. >>>



<<< The picture to the left shows an install of one CS-600, one CS-300, and one CS-75 on a 4" PVC side stream line using 6 sets of 4" sch 40 cross tees (CLF-52), one 4" tee (CLF-48), and 13 sets of 6" electrodes (CLE-05). Notice this whole assembly is part of side stream using ball valves on both ends to allow changing the electrodes without shutting down the pool pump(s).

## E.) Installing the Electrode Chamber(s)

(continued)



<<< The picture to the right shows an install of one CS-600 and one CS-300 on a 4" PVC side stream line using 6 sets of 4" sch 40 cross tees (CLF-52), and 12 sets of 6" electrodes (CLE-05). Notice this whole assembly is part of side stream using ball valves on both ends to allow changing the electrodes without shutting down the pool pump(s). The side stream mounts to the existing plumbing using saddle clamps.

### Installing the electrodes into the flow cell tee

Once the electrode chamber(s) have been plumbed in, wrap Teflon tape around the electrode assembly threads several times (Fig. A), and tighten into the flow cell tee (Fig. B) using a PVC wrench (Fig. C). Be sure to check for leaks when firing up the system.



Fig. A



Fig. B



Fig. C

### Connecting the grey electrode wire from the electrodes to the control box

Included with every electrode and tee is a 30 foot grey cable connection. Connect the terminals to the electrodes (Fig. D) and to the terminals coming out of the control box (Fig. E). It does not matter if you are screwing into the red or black terminals, just have one on each end.



Fig. D

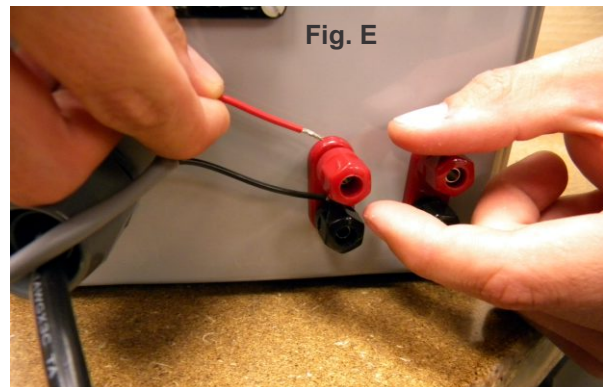

Fig. E

## F.) Installing the Control Box

### INSTALLING THE MICROPROCESSOR CONTROL BOX

#### 1.) Connecting the control box to a power source.

When locating the power source, it should be one that turns on and off as the pump and motor does. The best location is the pool's timer box. If no timer box exists, you unit can use the pump motor as its power source by removing the back plate.

If the swimming pools pump stays on 24 hours a day, then connect to the circuit that supplies power to the pools pump motor. This may change the size of the circuit breaker required, a certified electrician may be required.

We recommend adding a timer box if the swimming pools pump is on 24 hours a day. The control box would be wired directly into this timer. This will help prolong the life expectancy of the control box. Also by having control of how long the control box is on allows the use to regulate the copper ion production more precisely.

**YOU MUST FOLLOW ALL LOCAL, STATE, NATIONAL OR INTERNATIONAL CODES WHEN INSTALLING. A CERTIFIED ELECTRICIAN MAY BE REQUIRED.**

**It is the installer's responsibility insure any city, state or national health code/ swimming pool regulations be followed in accordance for installation of this equipment. This product is approved by NSF International Standard 50 and UL/cUL listed under file number E354947.**

**The control box auto switches between 110VAC and 220VAC so there is no need to make any internal adjustments.**

#### - WHEN CONNECTING TO THE TIMER BOX

**220 VAC** - Connect the black (3 stranded) wire cable to the 220 VAC timer box by splicing the 3 wires and connecting the black and white wires to the LOAD side on the timer box. It makes no difference which colored wire goes to the two load screws. Connect the green wire to GROUND. When installed correctly, the unit should come on and off when the power comes on and off. If this fails to happen, you have installed the unit improperly.

**110 VAC** - Connect either the white wire or the black wire to the LOAD side on the timer box. It makes no difference which colored wire goes to the two load screws. Connect the green wire to ground. When installed properly, the unit should come on and off when the power comes on and off. If this fails to happen, you have installed the unit improperly.

#### - WHEN CONNECTING TO PUMP MOTOR

Disconnect the back plate to the motor where the electrical connections are. You will notice two connections where the power source is connected to. Connect the ionizers black, white and green wires to the same as the motor. If connected properly, the ionizer will come on and off with the motor.

#### - WHEN CONNECTING TO A REGULAR OUTLET OR ELECTRICAL JUNCTION BOX.

It is possible to connect the control box to a regular outlet or junction box. Although this is not recommended because the control box should shut off whenever the swimming pools pump motor is off. If the control box is left running when there is no water flowing past the electrodes, damage to the electrode(s) or electrode cell chamber(s) could result.

The control box has a ½" flexible conduit connector on it, so provisions will have to be made for the outlet or the junction box to be similarly equipped. The wiring color codes scheme is the same as the North American Standard.

Black is line  
White is neutral  
Green is ground

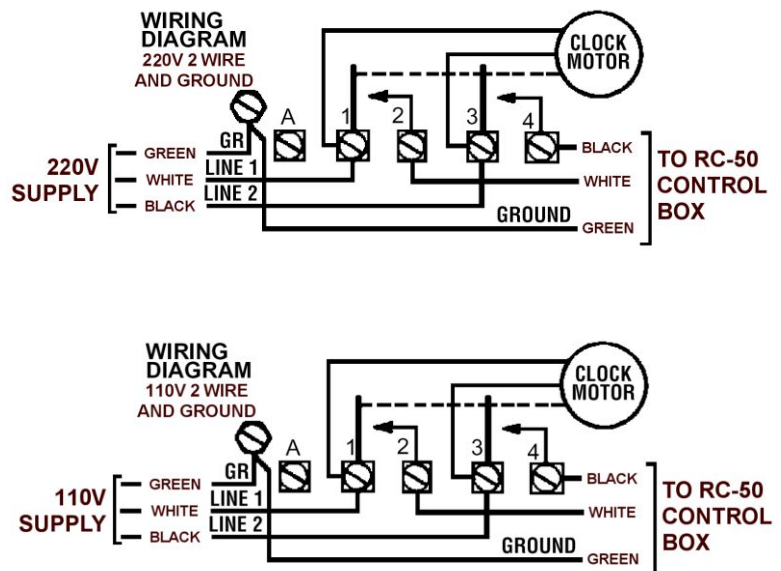

## F.) Installing the Control Box

(continued)

### - CONDUIT CONNECTIONS

You should use a flexible conduit from connection to connection on the power cable. The size of the connector already on the control box is 1/2". There is no need to cover up the electrode wire.

Once this is all complete, open up all valves and turn the power on. Check for water leaks and all electrical connections for proper and firm connections.

— TO KEEP THE CLEAR LID FROM SCRATCHING, KEEP PLASTIC SHEET ON UNTIL INSTALLED. —

2.) Mount the brackets to the back of the Microprocessor control box. Use enclosed screws.

3.) Mount the Microprocessor control box to the wall allowing for the power cable wire to reach the source of power, and the electrode wire to reach the electrode chamber. Use proper anchors and screws to mount. If the wires/cables will not reach, it is better to extend the power line than the electrode line.

4.) Make sure the surface is flat, firm and as close to the power source as possible.



To ensure the maximum NEMA 4 rating, please use the included screws (Enclosure Lid Securing Screws (2)) in the top right and bottom right holes on the lid (see arrows in above photo) of the unit once it has been shut and locked in place with the lid latch.

## G.) Balancing the Pool's Water

Before installing the **CS-Series MineralPURE**, the pools water must be clear and balanced properly. It is extremely important that the following guidelines are implemented - so please read thoroughly.



### RECOMMENDED POOL CHEMISTRY READINGS

- pH - MAINTAIN BETWEEN	7.2 – 7.6	<b><u>VERY IMPORTANT</u></b>
The copper-ions will fall out of solution if the pH gets over 7.6. For best results, keep the pH on the lower end.		
- Total Alkalinity	80 – 120 ppm	
- Calcium Hardness	150 – 350 ppm	
- Total Dissolved Solids (TDS)	300 – 2000 ppm	
- Chlorine Levels	This is generally 1 ppm	
Always maintain the local, state or country requirements of chlorine. MineralPURE operators will be able to cut chlorine back 50-75% of their normal usage.		
- Copper-Ion Levels	0.15 – 0.2 ppm	
see next chapter, "Starting up the System"		

## H.) Starting up the System/Operating Instructions

When all of the previous steps have been completed, it is time to start up the system.

Open all valves and turn the power on. Check for water leaks and all electrical connections for proper connections. Remove the clear protective sheet from the control unit. When starting the system, the **Clearwater Enviro Tech** logo will come on, followed by a loading progress bar and then a three digit number.

To get better acquainted with the unit, turn the control knob counter-clockwise till the unit reads "OFF". By turning the control knob clockwise, the unit will read a three-digit number. These are actually **milliamp (mA) readouts**, and they go from **005** to **1000** in 5 mA increments.

**THE DESIRED ION LEVEL IN THE POOL IS 0.15 – 0.2**

### - Using the Ion-Test Kit -

Included with every manual is an Ion Test Kit. The easy-to-use instructions are located on the inside cover of the lid. Please follow the instructions carefully, as the reading you get is most important in where you set the control knob.

Important notes: Wait 3 minutes for the test to develop. When comparing the water in the test tube to the chart, always look down from the top, not from the side of the tube. If the water is very warm in humid areas, it may be best to keep the ions closer to the 0.2 range.

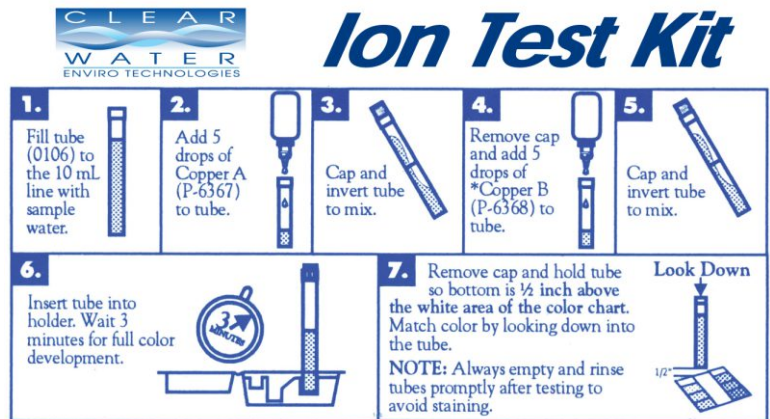

The diagram shows the seven steps for using the Ion Test Kit. Step 1: Fill tube (0106) to the 10 mL line with sample water. Step 2: Add 5 drops of Copper A (P-6367) to tube. Step 3: Cap and invert tube to mix. Step 4: Remove cap and add 5 drops of \*Copper B (P-6368) to tube. Step 5: Cap and invert tube to mix. Step 6: Insert tube into holder. Wait 3 minutes for full color development. Step 7: Remove cap and hold tube so bottom is 1/2 inch above the white area of the color chart. Match color by looking down into the tube. A color chart with a 3-minute timer icon is shown. A note states: "NOTE: Always empty and rinse tubes promptly after testing to avoid staining." A color chart with a 1/2 inch scale is also shown.

To reorder: Contact your dealer or **Clearwater® 1.800.756.7946 • 727.562.5186**

### - Setting the Control Knob to the Desired Level -

In order to get the **MineralPURE** system as those levels in the quickest time possible, set the control knob to its highest setting (usually 1000 ppm). As a rule of thumb, it generally takes 24 hours to get a pool of 15,000-20,000 gallons to reach the desired copper levels of 0.15 to 0.2 . This is assuming the pool water was in good condition and balanced properly.

You should then be testing the ion level every 8-12 hours during this initial set up period. Once this level has been obtained, lower the computer setting to the amount 1/2 it was to start up the system. In other words, if the computer was set to 1000 initially, lower it to 500. Continue to test every 8-12 hours. If the ion level continues to raise over the desired levels of 0.15 to 0.2 ppm, lower the setting again in half. Continue the testing on a request basis. If the copper levels are decreasing, raise the setting a bit. Once you get the pool's copper-ion leveled off, the computer will generally need to set on that same setting throughout the season. The only time it will need to be turned up or down is due to changes in bather load or water temperature.

### What if the control box reading won't go all the way to 1000?

The only reason the control box will not get to 1000 is if the TDS levels in the water are too low (550 ppm or lower). **There is no reason to be alarmed.** The **MineralPURE** unit will work fine, and a lower TDS reading is actually preferred. A low TDS level in commercial pools would only occur with the pool was entirely filled with fresh water. The TDS level will rapidly increase in time as anything you add to the pool increases TDS. Even at a TDS level of 300 ppm, the ionizer should be able to easily produce enough ions for reach the desired levels while initially starting up, but only at a slightly slower pace.

# I.) Proper Procedures of Maintaining a Healthy Pool

INCLUDED WITH THIS PACKAGE IS A "QUICK CHART" THAT GIVES YOU THE BASICS OF MAINTAINING A PROPER POOL. PLEASE REFER TO THAT SHEET WHENEVER POSSIBLE. IF YOU EVER HAVE ANY QUESTIONS, CONTACT YOUR DEALER OR CLEARWATER ENVIRO FOR ANY ASSISTANCE.

Ionizers are designed for supplementary disinfection and therefore are intended for use with appropriate residual levels of EPA registered disinfecting chemicals. Specific residual levels of EPA registered disinfecting chemicals may be required by the regulatory agency having authority.

**WARNING: Excessive amounts of Copper may cause staining of pool and spa surfaces**

## – QUICK CHART COMMERCIAL MODELS –

### 1.) Maintain Water Chemistry as Normal

**Keep pH between 7.2 and 7.6** This is very important!

Never allow the pH to get above 7.6, as the copper and silver ions fall out of solution and the water will get cloudy. If possible, keep the pH on the lower end of the scale. If the pH is too high, use an acid demand test with your regular test kit to determine the amount of dry or muriatic acid needed to lower the pH down to 7.2. If the pH is too low, use a base demand test to determine the amount of soda ash needed to raise the pH to 7.2. -- **Test daily** --

**Keep Total Alkalinity between 80-120 ppm**

Using a normal Total Alkalinity tester, determine the reading and adjust. If the reading is below 80ppm, add the proper amount of sodium bicarbonate (baking soda). If the reading is above 120ppm, lower it by adding the proper amount of muriatic acid. -- **Test daily** --

### 2.) Maintain Ion level between .15 and .2 ppm

Follow directions located inside the "Ion Test Kit" that is included with your unit to determine the ion level in your pool. If the reading is too high, lower the ionizer output level by turning the control knob counter-clockwise. Wait a couple of days before testing again. If the reading is too low, raise the ionizer output level by turning the control knob clockwise. Always keep the Ion test kit indoors and out of direct sunlight.

-- **Test at least once a week** --

#### Test Kit Reordering Information:

**Replacement Ion Test Kit - Part # CLE-41** - Includes new complete test kit as supplied with unit.

**Replacement Reagents - Part # CLE-42** - Includes new reagent bottles of "A" and "B" only.

### 3.) Maintain Normal Pool Maintenance

Always maintain the pool like you normally would. Keep the filter cleaned and backwash on a regular basis. Empty the skimmer and strainer baskets as needed and keep the pool vacuumed. Good circulation is extremely important especially since you are no longer using a lot of chlorine to keep the water clear.

### 4.) Maintain state-regulated chlorine levels

Even though the MineralPURE swimming pool models are all NSF listed, you are still required to maintain the levels of free available chlorine as specified by your local or state laws. Generally, this level is 1 ppm in swimming pools, however some states will allow lower levels with NSF approval. Regardless, you will still be able to cut back on chlorine use dramatically (50-75% in most cases).

### 5.) Cleaning and/or Replacing the Electrodes

The only part of the MineralPURE Ionizer that will need maintenance or replacement is the electrodes. They should last up to a year or longer depending on your pool size, length of swimming season, water temperature and how well the water was balanced (ion level, pH, etc.). To inspect the electrodes, simply unscrew the electrode chamber with your hands and visually inspect the electrode bars. A blue greenish coating is normal, however, if there is a heavy build-up, you may need to clean the electrode. Using an old toothbrush and lemon juice or a muriatic acid/water solution, scrub the build-up off the electrode. If the electrodes are thin and worn out, they will need to be replaced.

#### Electrode Reordering Information:

Replacement Electrode - **Part # CLE-05** - 6" electrode in 3" threaded cap, copper only

Replacement Electrode - **Part # CLE-20** - 7" electrode in 3" threaded cap, 90% copper, 10% silver

Replacement Electrode - **Part # CLE-14** - 6" electrode in 3" threaded cap, 80% copper, 20% silver

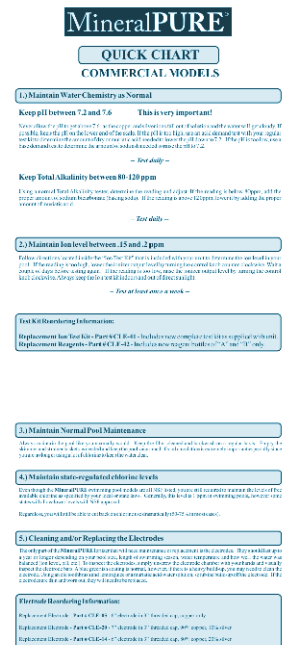

## J.) Cleaning and/or Replacing the Electrodes/User Maintenance

The only part of the **MineralPURE** Ionizer that will need maintenance or replacement is the electrodes. They should last about 1-5 years depending on your pool size, length of swimming season, water temperature and how well the water was balanced (ion level, pH, etc.). If the LCD display reads a warning to "Check Electrodes", it may be time to clean or replace them. To inspect the electrodes, simply unscrew the electrode chamber and visually inspect the electrode bars. A blue greenish coating is normal, however, if there is a heavy buildup, you may need to clean the electrode. Using an old toothbrush and lemon juice or a muriatic acid/water solution, scrub the buildup off the electrode. If the electrodes are thin and worn out, they will need to be replaced.

### Electrode Reordering Information:

Replacement Electrode  
- Part # **CLE-05** - 6"  
electrode in 3" threaded  
cap, copper only



Replacement Electrode  
- Part # **CLE-20** - 7"  
electrode in 3" threaded cap,  
90% copper, 10% silver



Replacement Electrode  
- Part # **CLE-14** - 6"  
electrode in 3" threaded cap,  
80% copper, 20% silver



### Copper Ion Test Kit Replacement

You should replace the reagents at least once a year. You can either replace the entire test kit (exactly as supplied in the box when you received the **MineralPURE** unit) or replace the reagents.

Order # **CLA-41**  
- **MineralPURE**  
complete test kit

Order # **CLA-42**  
- Replacement  
reagents "A"  
and "B"



### Silver Portable Photometer

The HI96737 Silver Portable Photometer (CLM-662) combines accuracy and ease of use in an ergonomic, portable design. A user can accurately determine the concentration of silver within a 0.000 to 1.000 mg/L (ppm) range using the HI93737-0 ready made reagents. The HI96737 offers many advanced features including the exclusive CAL Check™ function used for performance verification and calibration of the meter.

Order # **CLM-662**  
- Silver Portable  
Photometer



Contact your dealer or **Clearwater Enviro Technologies, Inc.** for more ordering information or visit [www.ElectrodeWarehouse.com](http://www.ElectrodeWarehouse.com)



# K.) CS Control Box Features

## CS-75

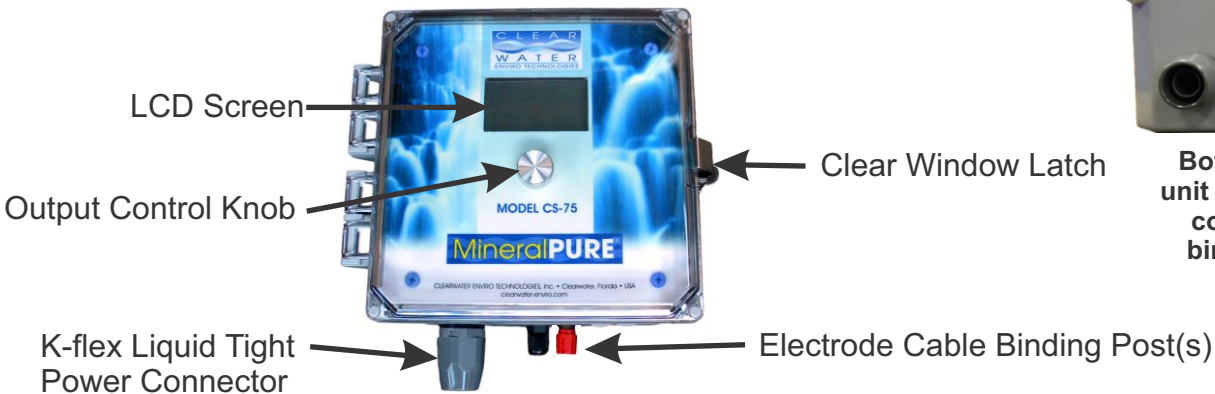

**Bottom of CS-75 unit showing K-flex connector and binding post(s)**

## CS-150 • CS-225

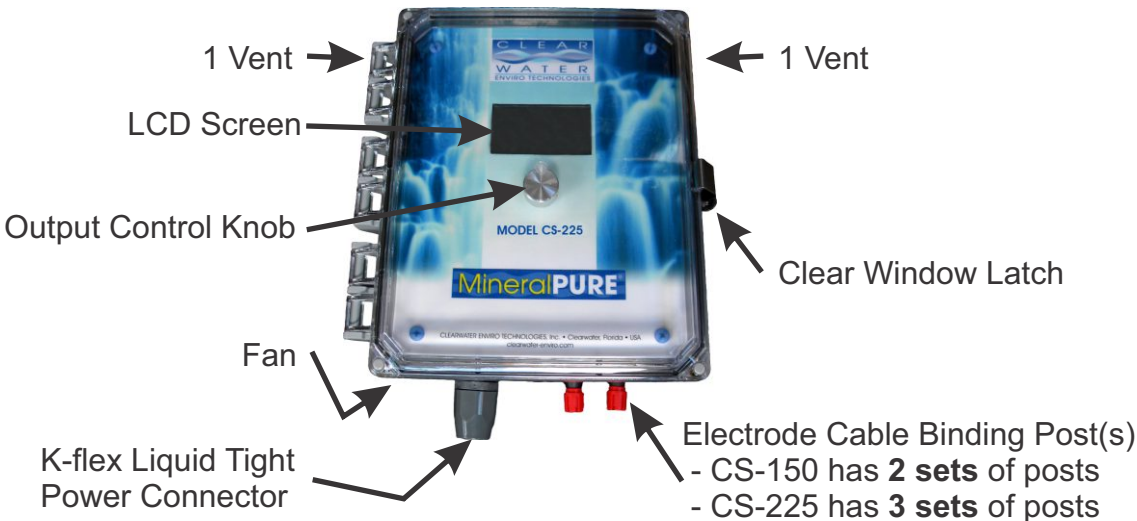

## CS-300 • CS-450 • CS-600

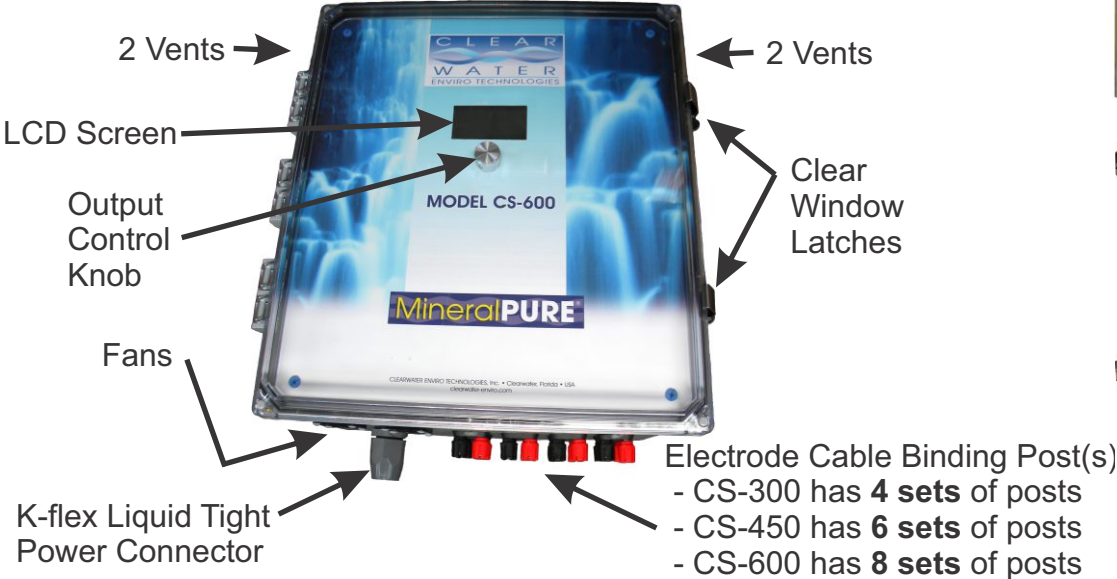

## Splash Screen - All Units



During the splash screen the unit performs a self diagnostic test. If an error is found an error number 5 will be displayed (see section on error screens).

## Main Screen(s)

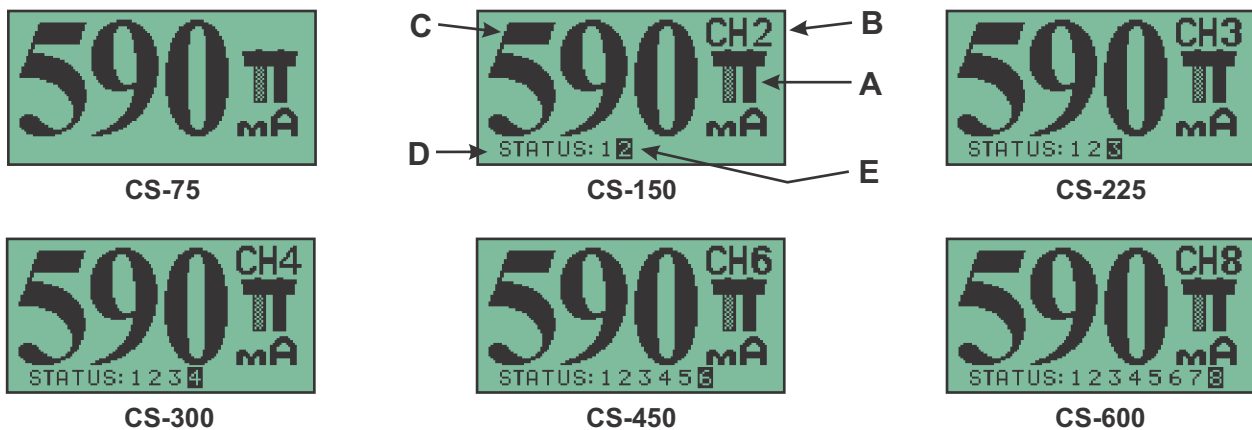

- A - Electrode status icon
- B - Output channel being displayed
- C - Output current set to value in milliamps (mA)
- D - All channels status indicator
- E - Black box around number indicates current channel being displayed. A blinking channel indicates an error on that channel.

## Output Current Indicator

This value indicates the output current flowing through the electrodes. It is adjustable from zero (OFF) to one thousand milliamps (mA), in five ma increments. The display back light will automatically turn OFF after 5 minutes. A turn of the control knob will turn ON the back light again

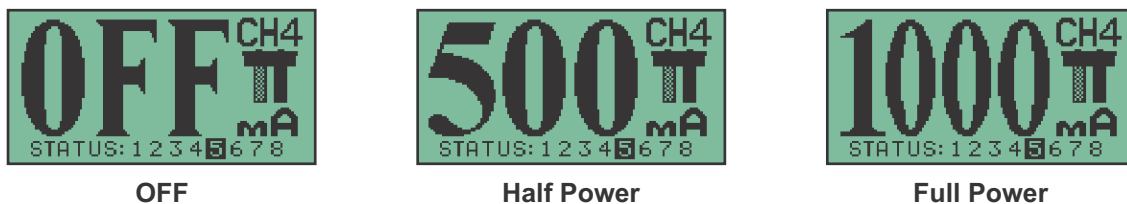

## Electrode Status Icon & Error Screens

### STEADY ON - NORMAL OPERATION

The electrode icon on the upper right side of the main screen indicates the electrical polarity as well as its operational status. The pictures to the right show the electrode icon switching from one polarity to the other. This will occur every five minutes and allow the electrodes to wear evenly to maximize the life of the electrodes.

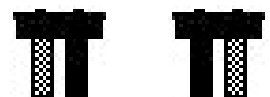

## Electrode Status Icon & Error Screens (continued)

### BLINKING with TDS - CHECK ELECTRODE or WATER TDS TOO LOW

In this mode the electrode icon will blink. The output current indicator will also change from the set to current value to the actual current value. The main cause for this to occur is the TDS level of the water is too low. In most cases the TDS level will rise and no action is required. Another reason for this warning is that the electrodes are worn out and need replacing. See the section on Inspecting and Replacing the Electrodes for more information.



### BLINKING with SHORT - SHORT CIRCUIT on ELECTRODE & ERROR SCREEN 3

This error mode is very unlikely to occur. If it should happen, most likely it will be caused by something (usually a piece of metal) bridging (shorting) the electrode terminals. To correct the error check the electrode terminals and wiring to make sure they are not touching each other. Also make sure no foreign material is shorting out the electrode from inside the electrode chamber.



### BLINKING with OPEN - OPEN CIRCUIT on ELECTRODE & ERROR SCREEN 2

This will most likely happen if one of the wires gets cut or otherwise disconnected from the electrode. Check both terminals on the electrode, making sure they are connected and not excessively corroded. Also make sure there are no nicks or cuts in the electrode cable.

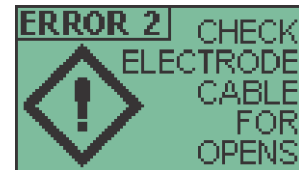

### ERROR SCREEN 5

This error indicates an internal error has occurred. This error can occur at start up during the self diagnostic test or during the course of normal operation. The error usually means that an internal printed circuit assembly has failed. The circuit assembly will correspond with the channel number that displays the error message. It should be noted, unless the otherwise indicated, that only that channel is malfunctioning and the other channels should be operating normally. This error could be caused by a blown fuse or one of the components on the board itself. If this error happens please contact **Clearwater Enviro Technologies** for technical assistance.



## Diagnostic Screen

	<b>DIAG SCREEN</b>	CH:04	
Output Current Set -	OUTPUT SET TO-600mA		- Output Channel Being Displayed
Actual Output Current Reading -	ACT. CURRENT-1200mA		
Duty Cycle of Output -	DUTY CYCLE-050%		
Total Hours Unit Has been On -	HOURS ON-000860		
Output Voltage -	ELE. VOLTAGE-16.5VDC		
LCD Display Contrast % -	LCD CONTRST-075%		
Error Status Number -	ERROR STATUS-123456		

This screen is used to display more technical information to the user or service technician. The following code will access the Diagnostic Screen:

1) Turn the output current knob until the output current indicator is **005**, wait about two seconds and you will notice the electrode icon will switch polarities.



2) Next dial in **030**, and wait 2 seconds



3) Next dial in **015**, and wait 2 seconds



The screen above (Diagnostic Screen) should now be displayed.

The diagnostic screen monitors seven different operational values. Each value is described in detail below.

**OUTPUT CURRENT SET** This is the set point for the output current (in milliampere). The unit will maintain this amperage setting thru the electrodes.

**OUTPUT CURRENT READING** This is a measured current value (in milliampere) of the current flowing thru the electrodes. This value is an instantaneous value and may or may not indicate a steady state current value. When in Analog Mode this reading will be the same as the current set value. When in Pulse Width Modulation Mode this value divided by the Duty Cycle Value will equal the current set value.

# K.) CS Control Box Features

(continued)

**DUTY CYCLE OF OUTPUT** When in the pulse width modulation mode, this is the ON time of the current output to the electrodes.

**TOTAL HOURS UNIT HAS BEEN ON** Total time (in hours) the control unit has been in operation.

**OUTPUT VOLTAGE** This is the output voltage across the electrodes. This voltage can range from 2VDC to 20VDC depending on the electrode conditions, water TDS, and output current setting.

**LCD DISPLAY CONTRAST** The LCD display's contrast setting, in percentage.

**ERROR STATUS NUMBERS** This is a numerical representation of the present status. The Values and the meaning are written below.

- 1) Normal Mode
- 2) Electrode Open Circuit
- 3) Electrode Short Circuit
- 4) Electrode Resistance Too High
- 5) Internal Error

**Output channel being displayed** is the current information on the LCD screen as it relates to this channel.

## Return to Main Screen

The control box will return to the main screen when power is removed and then reapplied. Alternately the user can also dial in the following code to return to the main screen:

1) Turn the output current knob until the output set value is **000** wait about two seconds and you will notice the electrode icon will switch polarities.



2) Next dial in **025**, and wait 2 seconds

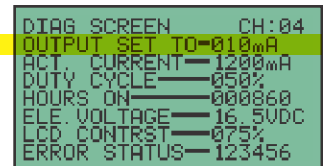
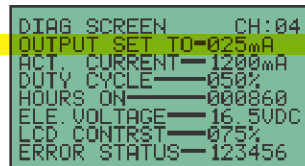
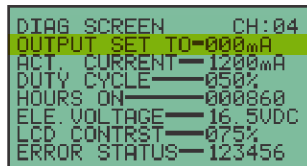

3) Next dial in **010**, and wait 2 seconds

The control unit's LCD display should now show the main screen.

## LCD Contrast Adjust Screen

The LCD contrast adjustment screen allows the user to adjust the darkness of the LCD display. To access this screen the user must dial-in the correct code on the output adjust knob. The following code will access the LCD contrast adjustment screen.

1) Turn the output current knob until the output current indicator is **010**, wait about two seconds and you will notice the electrode icon will switch polarities.



2) Next dial in **035**, and wait 2 seconds



3) Next dial in **020**, and wait 2 seconds

The display will now look like the picture to the right. The LCD display's contrast can now be adjusted. The display will now show the percentage of contrast on the screen. Adjustments will make the display easier to read in different light levels. After nine seconds of inactivity on the control knob the unit will return to the main screen. After the screen switches back, the new LCD contrast level will be recorded in the control unit and will then always return to this new level when powering up. Of course, the operator can always change it again if needed.



## L.) Trouble Shooting

### CAN'T OBTAIN PROPER COPPER-ION LEVEL

If you are unable to obtain the proper ion level, check all of the following factors to solve the problem:

- 1.) High algae growth and cloudy water / Ion level too low.** A high algae growth or cloudy water will use up all available copper and silver ions in the water that the unit can produce. This would result in a low ion level. Make sure the pool water is balanced (see the rest of this section) and turn up the control knob to a higher reading. Oxidize the water with chlorine.
- 2.) Correct sizing of the pool.** Make sure the pool size does not exceed the recommended limits of the control box.
- 3.) Check electrode light comes on right away or unable to maintain desired readout on the display**  
A blue-greenish coating around the electrodes is normal. However, a build up of scale, dirt or debris around the electrodes can prevent the unit from producing ions. Simply unscrew the electrodes and clean the buildup using an old toothbrush and use a lemon juice or muriatic acid/water solution. **See details in section I, page 14.**
- 4.) Can't get a high reading on the display/ TDS is too low.** If your pool has brand new water in it, and you are unable to obtain a desirable reading on the control unit, chances are the TDS level is too low. **See detailed section on page 12.**
- 5.) Improper test kit readings.** Make sure you follow the proper Ion-Test kit procedures. Many people look at the side of the test tubes instead of looking down from the top. Also, be sure to wait three minutes for the reagents to develop. These reagents should be replaced yearly and kept out of direct sunlight and stored at normal room temperature. Failure to do so will cause faulty readings. Never let the reagents freeze or be exposed to extreme heat.
- 6.) Improper pH readings.** This is usually the main reason for a low copper-ion level. Make sure the pH is maintained between 7.2 - 7.6 , with the power end preferred. When the pH goes over 7.6, the ions fall out of solution. Make sure your test kit is updated with fresh reagents and kept out of direct sunlight and in normal room temperatures. Never mix different manufacturer's reagents with the test kit.
- 7.) Too much chlorine in the pool.** If the pool was just shocked with a lot of chlorine, this can give you an improper test kit reading on the Ion Test Kit. The high chlorine level will "bleach" out the reading and appear to read zero.
- 8.) Sequestering Agents or Metal Out Removers in the water.** Sometimes pool owners will add a flocking or sequestering agent to the water to remove stains or scaling in a pool or remove undesired minerals that are in the source water. Some of these will interfere with the **MineralPURE's** ions such as Sequasol, Cop-Out, Metal Magnet, Aluminum Sulfate or Alum. Products that won't cause problems and that are actually recommended to use with Mineral Pure include Pool Stain Treat by *United Chemical* or *Jack's Magic*. All polymer based products like Super Blue and Sea-Klear do not cause problems either. If you are unsure if a sequestering agent is causing a low ion level, send **Clearwater Enviro Technologies** a water sample to test. If it is a problem (these agents can stay in the water for up to a year) add a lot of chlorine to shock it out of the pool water.
- 9.) Steel plumbing.** Never install the electrodes on steel piping. Cut out a section of this and replace with PVC pipe.
- 10.) Improper installation.** Sometimes installers will mount the electrodes on a bypass line and not on the actual return line that goes back to the pool's water. Make sure unit is on properly with correct connections.

## L.) Trouble Shooting

(continued)

### NO OUTPUT READING ON THE CONTROL BOX

If there is no reading on the LCD display when the control box is powered up, and assuming all connections are correct, you should check the fuses. Improper installation, a power surge, or lightning strikes can cause the fuses to blow. In the example below we will use a CS-150 unit, although your control box may differ the process will be essentially the same. Also if the unit just has a dim reading on the LCD display than it is a LCD contrast issue, consult Section K, LCD Contrast Adjust Screen.



To check the fuses, open up the unit and remove the four (4) screws holding the top collar in place.

Lift face plate assembly, with printed circuit board attached, up and turn over. Do not disconnect any wires. **Very important.**

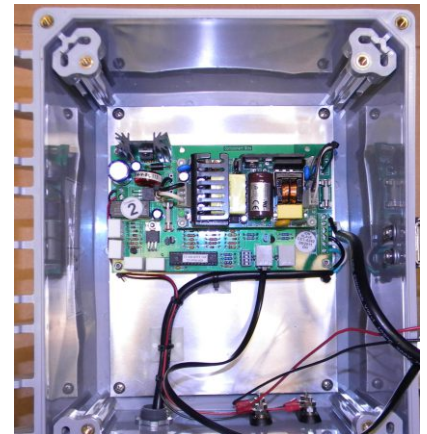
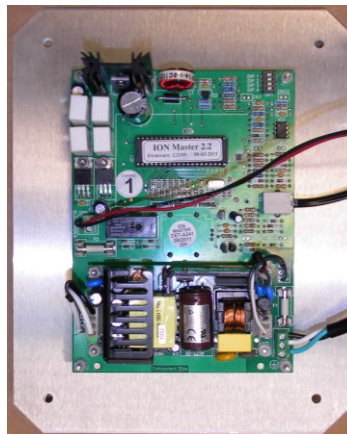

Locate fuses on back of circuit boards (indicated by the pictures) and check fuses to see if blown. Replace any blown fuses and reassemble control box in reverse of the disassembly instructions. If the fuse blows again or you still have a blank display call Clearwater Enviro Tech to obtain a RMA, DO NOT KEEP REPLACING FUSES!

**F1 Fuse, 5X20mm Slow Blow 2A, 250V**  
**F2 Fuse, 5X20mm Slow Blow 4A, 250V**

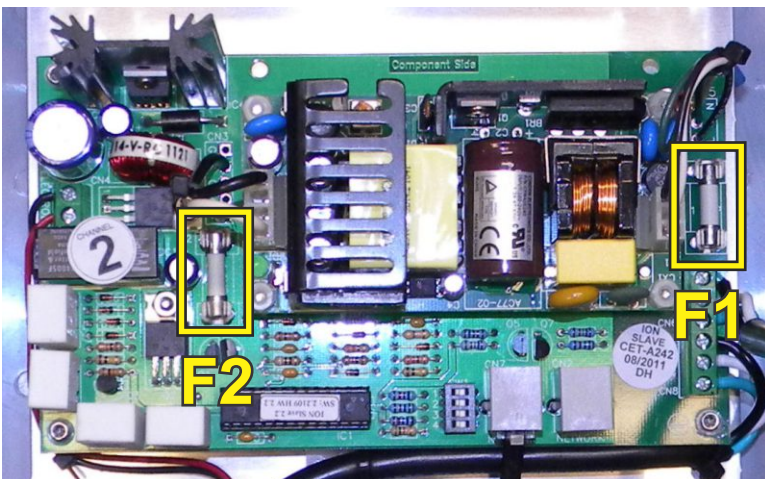
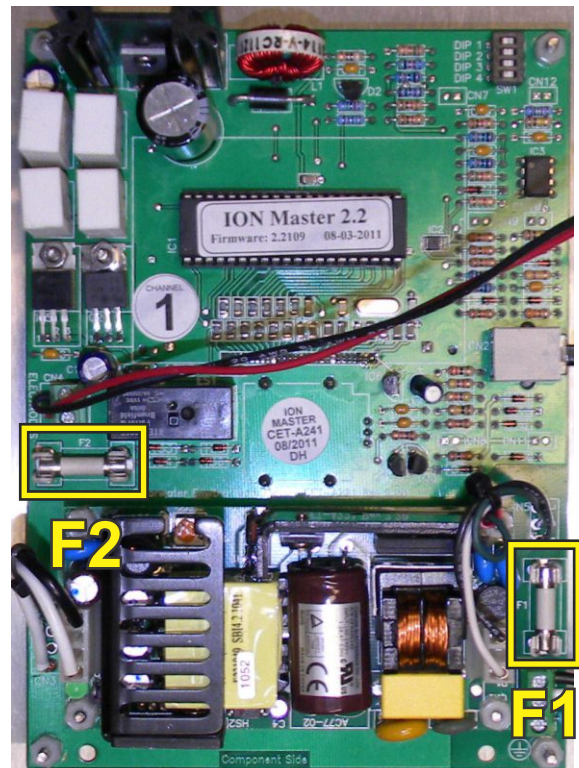



## N.) Optional Components for CS Units

### OPTIONAL COMPONENTS



6" long 80% copper, 20% silver electrode, 3" sch 80 (CLE-14)



7" long 90% copper, 10% silver electrode, 3" sch 80 (CLE-20)



PVC Tee 3" (CLF-57)  
or  
PVC Tee 4" (CLF-58)



PVC Cross Tee 3" (CLF-83)  
or  
PVC Cross Tee 4" (CLF-84)

CS-75	1 electrode	1 PVC Tee	1 Coil of Grey Electrode Cable
CS-150	2 electrodes	2 PVC Tees or 1 Cross Tee*	2 Coils of Grey Electrode Cable
CS-225	3 electrodes	3 PVC Tees or 1 Tee and 1 Cross Tee*	3 Coils of Grey Electrode Cable
CS-300	4 electrodes	4 PVC Tees or 2 PVC Cross Tees*	4 Coils of Grey Electrode Cable
CS-450	6 electrodes	6 PVC Tees or 3 PVC Cross Tees*	6 Coils of Grey Electrode Cable
CS-600	8 electrodes	8 PVC Tees or 4 PVC Cross Tees*	8 Coils of Grey Electrode Cable

\* Customers option between tee's and crosses



## O.) Commercial Ionizer Specifications

### **POOL SIZE:**

CS-75 up to 75,000 U.S. gallons  
CS-150 up to 150,000 U.S. gallons  
CS-225 up to 225,000 U.S. gallons  
CS-300 up to 300,000 U.S. gallons  
CS-450 up to 450,000 U.S. gallons  
CS-600 up to 600,000 U.S. gallons

**INPUT VOLTAGE:** 90 to 264 VAC, at 47 to 63 HZ, auto switching

**INPUT CURRENT and WATTAGE:** With electrode output set to 1000mA (Max.)

CS-75 - 375mA @ 120VAC	350mA @ 240VAC
CS-150 - 550mA @ 120VAC	500mA @ 240VAC
CS-225 - 1A @ 120VAC	800mA @ 240VAC
CS-300 - 1.3A @ 120VAC	1A @ 240VAC
CS-450 - 1.6A @ 120VAC	1.4A @ 240VAC
CS-600 - 2.2A @ 120VAC	1.8A @ 240VAC

**OUTPUT VOLTAGE (all outputs):** 2.5VDC to 20VDC, Auto Ranging, Dynamically Adjusted

**OUTPUT CURRENT:** Adjustable in 5mA increments

0 TO 1000mA DC in analog mode (each output)

0 TO 1000mA DC average in pulse width modulation mode (each output)

**CIRCUIT PROTECTION:** internal input fuse, both on high side and low side, input line spike/surge immunity to IEC 1000-4-5, level 3

### **FUSES:**

F1 - 2A, 250VAC, 5x20mm, Slow Blow  
F2 - 4A, 250VAC, 5x20mm, Slow Blow

**IONIZATION METHOD:** electrolysis of copper, copper/silver alloy electrodes by a microprocessor control circuit

### **ELECTRODES:**

CS-75 – One 6” set of Electrodes, comprised of copper (CLE-05)  
CS-150 – Two sets of Electrodes, comprised of copper (CLE-05)  
CS-225 – Three sets of Electrodes, comprised of copper (CLE-05)  
CS-300 – Four sets of Electrodes, comprised of copper (CLE-05)  
CS-450 – Six sets of Electrodes, comprised of copper (CLE-05)  
CS-600 – Eight sets of Electrodes, comprised of copper (CLE-05)

**Copper/silver electrodes are available:**

CLE-20 - 7” long 90/10 Copper/Silver Electrodes

CLE-14 - 6” long 80/20 Copper/Silver Electrodes

**Contact Clearwater Enviro for details**

**ELECTRODE CHAMBER:** Customers choice between 3” or 4” Schedule 80 tees or cross tees.

Tee takes one electrode and cross tee takes two electrodes

**ENCLOSURE:** weather resistant NEMA 4X (IP65) rated, UL 94 Flame Rating, UL UV rated, high impact corrosion resistant thermoplastic with hinged polycarbonate cover

**ENCLOSURE DIMENSIONS:**

- CS-75 – 8" x 8" x 4"
- CS-150 – 8" x 10" x 6"
- CS-225 – 8" x 10" x 6"
- CS-300 – 16" x 14" x 7"
- CS-450 – 16" x 14" x 7"
- CS-600 – 18" x 16" x 10"

**OPERATING TEMPERATURE RANGE:** 32 - 110 degrees F

**WARRANTY:** 3 years, parts and labor - excluding electrodes

**HEAD LOSS:**

When using:

- CLF-49 – 3" Sch. 80 Tee – Flow Rate of 25 GPM Total Head Loss (psi) is < .20 PSI
- CLF-51 – 3" Sch. 80 Cross Tee – Flow Rate of 25 GPM Total Head Loss (psi) is < .20 PSI
- CLF-48 – 4" Sch. 80 Tee – Flow Rate of 25 GPM Total Head Loss (psi) is < .20 PSI
- CLF-52 – 4" Sch. 80 Cross Tee – Flow Rate of 25 GPM Total Head Loss (psi) is < .20 PSI

**HYDROSTATIC PRESSURE:** Maximum Recommended Pressure: 50PSI

**ION PRODUCTION WITH THE FOLLOWING WATER CONDITIONS:**

- Water Temperature: 72.7 °F
- Total Chlorine: None
- pH: 7.45
- TDS: 347 mg/L
- Hardness: 215 mg/L
- Total Alkalinity: 85 mg/L

**USING THE CLE-05 ELECTRODE:**

Model	Current Output @ 500mA	Current Output @ 1000mA
CS-75	358 mg of copper/hour	716 mg of copper/hour
CS-150	716 mg of copper/hour	1.432 g of copper/hour
CS-225	1.074 g of copper/hour	2.148 g of copper/hour
CS-300	1.432 g of copper/hour	2.864 g of copper/hour
CS-450	2.148 g of copper/hour	4.296 g of copper/hour
CS-600	2.864 g of copper/hour	5.728 g of copper/hour

**Post Life Output (CLE-20)**

Copper - 42.77g/day Cu, Silver - 0.05g/day Ag.

This unit has not demonstrated an ability to provide three log reduction of *Pseudomonas aeruginosa*. This unit has not demonstrated an ability to provide three log reduction of *Enterococcus faecium*. This product is designed to be operated with no less than 0.4 ppm free chlorine or 0.8 ppm free bromine. Additional residual levels of EPA registered disinfecting chemicals may be required by the regulatory agency having authority.

## Notes

# MineralPURE<sup>®</sup>

*The Healthy Alternative to Chlorine*

Manufactured by



Licensed Technology



Certified to  
NSF/ANSI Standard 50

Phone: 727-562-5186 • Toll Free: 800-756-7946 • Fax: 727-562-5187  
[www.ClearwaterEnviro.com](http://www.ClearwaterEnviro.com) • [ClearwaterPoolSystems.com](http://ClearwaterPoolSystems.com)