



ドリル&タップ

高硬度鋼・金型用シリーズ

Drill & Tap Series for High Hardness Steels and Dies

Vol.2

新価格
体系
New Price
2022年8月



金型全般（モールドベース、金型）の すべての穴加工を強力にバックアップ！

Quality cutting tool solutions for all of your die/mold machining needs!

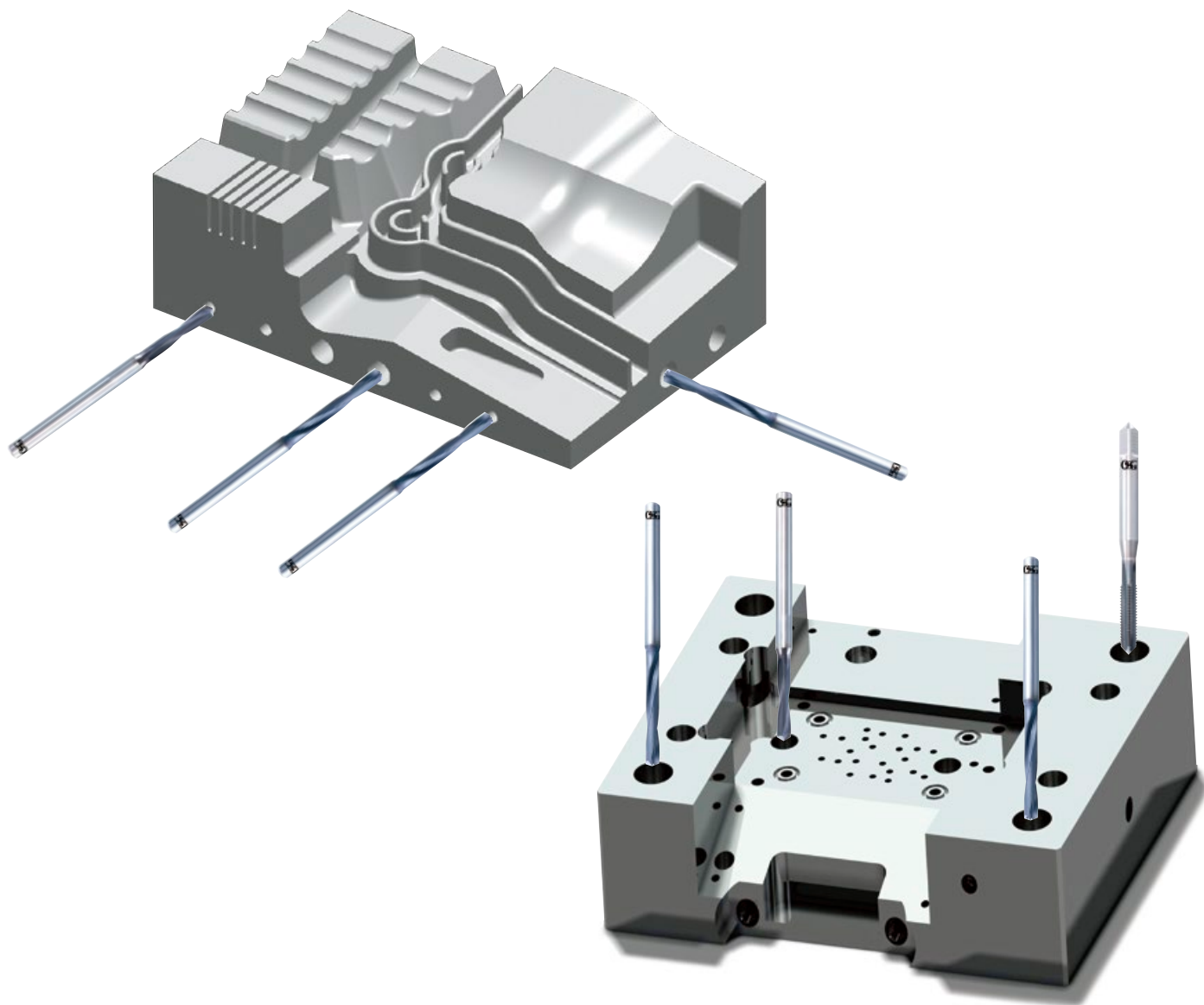

■ マークの種類について Guide for Icons

1 材質 Tool Materials

CARBIDE 超硬合金
Tungsten Carbide

XPM 高級粉末ハイス
High Grade Powder Metallurgy HSS (XPM)

2 表面処理 Surface Treatment

WXS WXスーパーコート
WX Super Coating

V Vコーティング(複合多層コーティング)
V (Composite Multi-layered) Coating

3 直径の許容差 Tolerance for Drill Diameter

h8 ドリル直径の許容差を表示します。
Tolerance for drill diameter.

3 シャンク Shank

SHRINK FIT シュリンクフィット（焼きばめ）システムにもお奨めします。
Suitable for the shrink holder system.

5 ねじれ角 Helix Angle

12~20° ドリル、タップの溝のねじれ角を表示します。
Display helix angle of flute for drills and taps.

INDEX

高硬度鋼・金型用 穴加工工具マップ Cutting Tool Selection Map

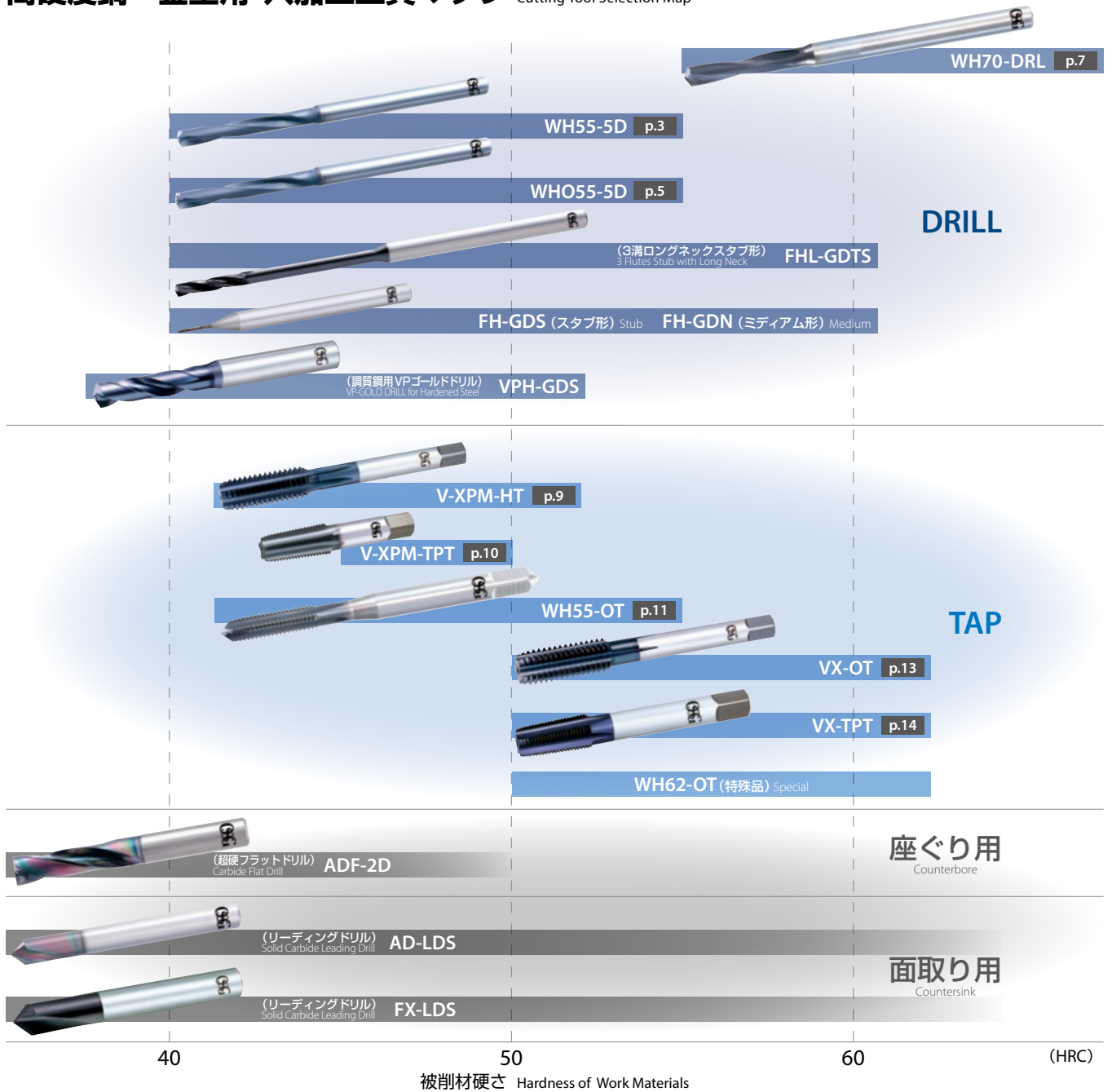

※不水溶性切削油剤でドリルをご使用の場合は、基準切削速度より20%下げてください。When using non-water-soluble oil, reduce cutting speed by 20% of the recommended condition.

従来製品との組合せで、金型加工をトータルにサポートします！

Along with our conventional products, these tools provide total support for your die machining needs!



超硬ドリル
Carbide Drill



メガマッスルドリル
Mega Muscle Drills



A-TAP
Highly Efficient Multi-Purpose Tap

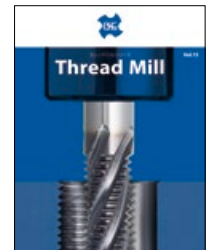

スレッドミル
Thread Mill

WH55-5D

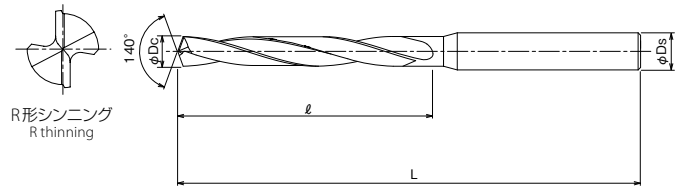

単位:mm Unit:mm

ツールNo. EDP No.	直径 Dc	溝長 ℓ	全長 L	シャンク径 Ds	在庫 Stock	標準価格 (Yen)
3312200	2	18	68	4	B	7,330
3312250	2.5	23	73			7,330
3312280	2.8	27				7,330
3312300	3	29	7,330			
3312330	3.3	32	78	7,910		
3312350	3.5			7,910		
3312380	3.8	36	88	8,320		
3312400	4			8,320		
3312420	4.2	38		8,880		
3312450	4.5	41		8,880		
3312480	4.8	45	92	9,500		
3312500	5			9,500		
3312510	5.1	42	102	10,100		
3312550	5.5	44		10,100		
3312580	5.8	48		10,600		
3312600	6			10,600		
3312650	6.5	52	10,600			
3312680	6.8	56	11,300			

ツールNo. EDP No.	直径 Dc	溝長 ℓ	全長 L	シャンク径 Ds	在庫 Stock	標準価格 (Yen)
3312700	7	56	102	8	B	11,300
3312750	7.5	60	118			11,900
3312780	7.8	64				12,600
3312800	8	64	12,600			
3312850	8.5	68	128	10		13,200
3312870	8.7	70				13,900
3312880	8.8	72	136			13,900
3312900	9					13,900
3312950	9.5	76	146	12		14,500
3312980	9.8	80				15,100
3313000	10	84				15,100
3313030	10.3					15,800
3313050	10.5	88	156	15,800		
3313080	10.8			16,400		
3313100	11	92	16,400			
3313150	11.5	96	17,000			
3313180	11.8	96	156	17,600		
3313200	12			17,600		

●マークの説明はp.1をご覧ください。 ● See p. 1 for explanation of marks.

B=標準在庫品 B=Standard stock item

当社営業まで問い合わせ下さい
Please contact our sales staff for more information.

外径・長さ・精度違いの特品も承ります
Custom order with specific requests on diameter, length and accuracy is accepted.

切削条件基準表 Cutting Conditions

被削材 Work Material	特殊鋼・調質鋼・プリハードン鋼 SKD61 (非調質) Special Alloy Steels・Hardened Steels・Prehardened Steels SKD61 (unquenched) 40~45HRC		DAC55、DH31S、SKD61、SKD11、STAVAXなど			
			45~50HRC		50~55HRC	
切削速度 Cutting Speed	30~50m/min		20~30m/min		20~30m/min	
直径 Drill Dia. (mm)	回転速度 Speed (min ⁻¹)	送り量 Feed Rate (mm/rev)	回転速度 Speed (min ⁻¹)	送り量 Feed Rate (mm/rev)	回転速度 Speed (min ⁻¹)	送り量 Feed Rate (mm/rev)
2	6,400	0.02 ~ 0.04	4,000	0.02 ~ 0.04	4,000	0.02 ~ 0.04
3	4,200	0.03 ~ 0.06	2,700	0.03 ~ 0.06	2,700	0.03 ~ 0.06
4	3,200	0.04 ~ 0.08	2,000	0.04 ~ 0.08	2,000	0.04 ~ 0.08
5	2,500	0.05 ~ 0.1	1,600	0.05 ~ 0.1	1,600	0.05 ~ 0.1
6	2,100	0.06 ~ 0.12	1,300	0.06 ~ 0.12	1,300	0.06 ~ 0.12
8	1,600	0.08 ~ 0.16	1,000	0.08 ~ 0.16	1,000	0.08 ~ 0.16
10	1,300	0.1 ~ 0.2	800	0.1 ~ 0.2	800	0.1 ~ 0.2
12	1,100	0.12 ~ 0.24	700	0.12 ~ 0.24	700	0.12 ~ 0.24

- この切削条件基準表は、水溶性切削油剤を使用する場合のものです。
- 水溶性切削油剤は、希釈倍率20倍以下の良質のものをご使用下さい。
- 不水溶性切削油剤または20倍を超える水溶性切削油剤の時は、切削速度を30%下げてください。
- ドリル装着に際しては、傷や汚れの無いコレットを用い、ドリルの振れは0.02mm以下に抑えて下さい。
- 被削材の保持はしっかりと行ない、変形、たわみ、振動が起こらない状態にしてください。

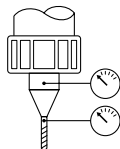

- The indicated speeds and feeds are for water-soluble oil.
- Suitable cutting fluid is water-soluble high density oil (less than 20 times dilution).
- When using non-water-soluble oil or water-soluble oil (over 20 times dilution), reduce cutting speed by 30%.
- When inserting a drill into the machine, use a collet that does not have any scratches or dust located within internal bore. Also, reduce deflection of drill to less than 0.02mm.
- Fasten the work material to reduce the possibility of work deformation, deflection of machined surface, or vibration.



DAC55を安定加工、しかも高性能!

Stable machining on DAC55 even high performance.

使用工具 Tool	WH55-5D φ5.1	従来品 φ5.1 Conventional
被削材 Work Material	DAC55(48HRC)	
切削速度 Cutting Speed	30m/min (1,872min ⁻¹)	18m/min (1,123min ⁻¹)
送り速度 Feed Rate	131mm/min (0.07mm/rev)	74mm/min (0.06mm/rev)
穴深さ Depth of Hole	15mm (2.9D 止り) Blind	
切削油剤 Coolant	水溶性切削油剤 塩素フリー (外部給油) Water-Soluble Chlorine-Free (External)	
使用機械 Machine	立形マシニングセンタ (BT30) Vertical Machining Center	

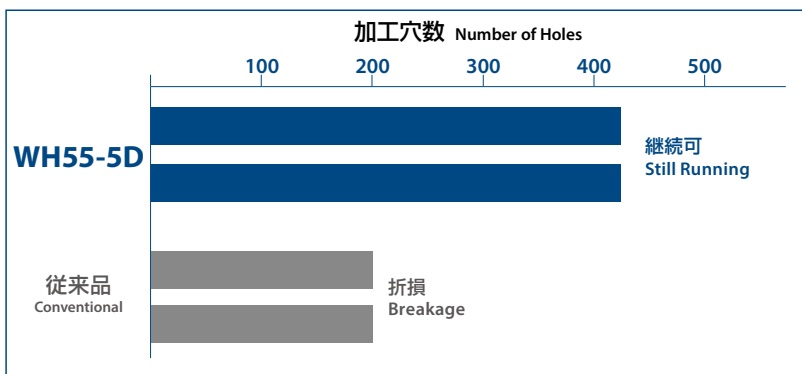

WH55-5Dは安定して加工できており、400穴加工しても損傷は見られなかった。従来品は損傷が激しく200穴以下で折損。

WH55-5D showed a stable drilling, no damage after 400 holes. Conventional tool showed a big damage and less than 200 holes tool life.

STAVAXも安定加工で長寿命!

A stable and a long tool life against STAVAX.

使用工具 Tool	WH55-5D φ5.1
被削材 Work Material	STAVAX (52HRC)
切削速度 Cutting Speed	17.5m/min (1,092min ⁻¹)
送り速度 Feed Rate	76mm/min (0.07mm/rev)
ステップ量 Step Feed	3mm (0.6D)
穴深さ Depth of Hole	15mm (2.9D 止り) Blind
切削油剤 Coolant	水溶性切削油剤 塩素フリー (外部給油) Water-Soluble Chlorine-Free (External)
使用機械 Machine	立形マシニングセンタ (BT30) Vertical Machining Center

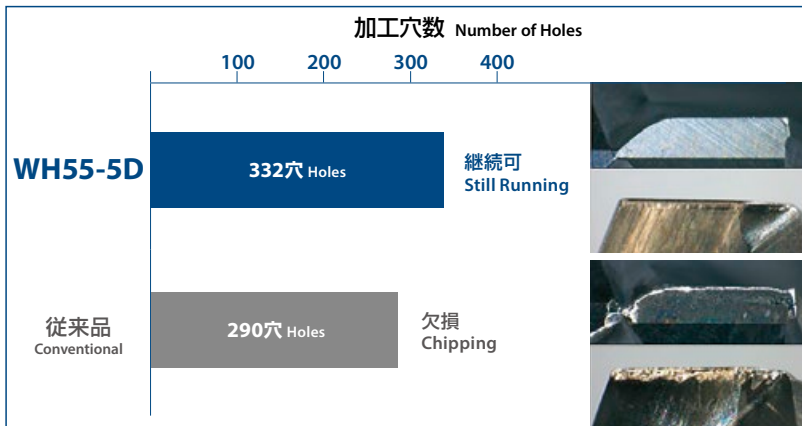

WH55-5Dは欠損無く300穴以上の継続加工が可能。損耗の違いをご確認下さい。WH55-5D shows no damage and capable continued operation after 300 holes. Please see above for the difference of wear.

加工困難なDH31Sを安定加工

Stable operation on difficult to machine DH31S.

使用工具 Tool	WH55-5D φ8.5
被削材 Work Material	DH31S (53HRC)
切削速度 Cutting Speed	30m/min (1,123min ⁻¹)
送り速度 Feed Rate	191mm/min (0.17mm/rev)
穴深さ Depth of Hole	25mm (2.9D 通り) Through
切削油剤 Coolant	水溶性切削油剤 塩素フリー (外部給油) Water-Soluble Chlorine-Free (External)
使用機械 Machine	立形マシニングセンタ (BT40) Vertical Machining Center

100穴加工後 After Drilling 100 Holes

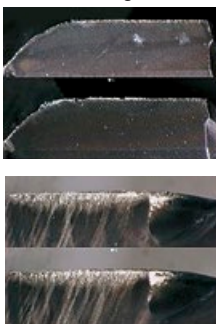

耐久性性能 Durability Performance

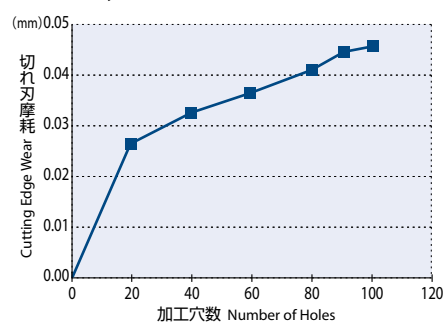

加工が難しいDH31Sを100穴加工して微小摩耗。欠損もなく、抜群の安定性。After 100 holes, minor wear against tough DH31S. No chipping and excellent stableness.

WHO55-5D

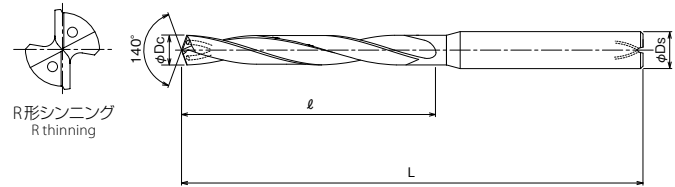

単位:mm Unit:mm

ツールNo. EDP No.	直径 Dc	溝長 ℓ	全長 L	シャンク径 Ds	在庫 Stock	標準価格 (Yen)	
3316330	3.3	32	78	6	B	13,400	
3316340	3.4					13,400	
3316349	3.49					13,400	
3316350	3.5					13,400	
3316360	3.6					13,500	
3316370	3.7					13,500	
3316380	3.8		34			13,500	
3316390	3.9					13,500	
3316400	4					13,500	
3316410	4.1					88	13,900
3316415	4.15						13,900
3316420	4.2						13,900
3316430	4.3	13,900					
3316440	4.4	13,900					
3316450	4.5	41	13,900				
3316460	4.6		43			14,200	
3316470	4.7					14,200	
3316480	4.8					14,200	
3316490	4.9					14,200	
3316500	5					14,200	
3316510	5.1	42				15,000	
3316520	5.2		15,000				
3316530	5.3		92			15,000	
3316540	5.4					15,000	
3316550	5.5			15,000			
3316556	5.56			15,800			
3316560	5.6	15,800					

ツールNo. EDP No.	直径 Dc	溝長 ℓ	全長 L	シャンク径 Ds	在庫 Stock	標準価格 (Yen)	
3316570	5.7	46	92	6	B	15,800	
3316580	5.8	48				15,800	
3316590	5.9					15,800	
3316600	6	15,800					
3316650	6.5	52				8	15,800
3316680	6.8	102					16,800
3316700	7		16,800				
3316750	7.5	60	17,700				
3316780	7.8	118	18,700				
3316800	8		18,700				
3316850	8.5	68	10	19,700			
3316858	8.58	128		20,800			
3316870	8.7			20,800			
3316880	8.8	20,800					
3316900	9	72		20,800			
3316950	9.5	76		12		21,700	
3316980	9.8	136	22,000				
3316997	9.97		22,000				
3317000	10	22,000					
3317030	10.3	146	23,300				
3317050	10.5		23,300				
3317080	10.8	88	24,100				
3317100	11		24,100				
3317150	11.5	92	25,200				
3317156	11.56		26,800				
3317180	11.8	96	26,300				
3317200	12		26,300				

●マークの説明はp.1をご覧ください。 ● See p. 1 for explanation of marks.

B=標準在庫品 B=Standard stock item

当社営業までお問い合わせ下さい

Please contact our sales staff for more information.

外径・長さ・精度違いの特品も承ります

Custom order with specific requests on diameter, length and accuracy is accepted.

切削条件基準表 Cutting Conditions

被削材 Work Material	特殊鋼・調質鋼・プリハードン鋼 SKD61 (非調質) Special Alloy Steels・Hardened Steels・Prehardened Steels SKD61 (unquenched)		DAC55、DH31S、SKD61、SKD11、STAVAXなど			
	40~45HRC		45~50HRC		50~55HRC	
切削速度 Cutting Speed	30~50m/min		20~30m/min		20~30m/min	
直径 Drill Dia. (mm)	回転速度 Speed (min ⁻¹)	送り量 Feed Rate (mm/rev)	回転速度 Speed (min ⁻¹)	送り量 Feed Rate (mm/rev)	回転速度 Speed (min ⁻¹)	送り量 Feed Rate (mm/rev)
3.3	3,900	0.03 ~ 0.07	2,400	0.03 ~ 0.07	2,400	0.03 ~ 0.07
4	3,200	0.04 ~ 0.08	2,000	0.04 ~ 0.08	2,000	0.04 ~ 0.08
5	2,500	0.05 ~ 0.1	1,600	0.05 ~ 0.1	1,600	0.05 ~ 0.1
6	2,100	0.06 ~ 0.12	1,300	0.06 ~ 0.12	1,300	0.06 ~ 0.12
8	1,600	0.08 ~ 0.16	1,000	0.08 ~ 0.16	1,000	0.08 ~ 0.16
10	1,300	0.1 ~ 0.2	800	0.1 ~ 0.2	800	0.1 ~ 0.2
12	1,100	0.12 ~ 0.24	700	0.12 ~ 0.24	700	0.12 ~ 0.24

- この切削条件基準表は、水溶性切削油剤を使用する場合のものです。
- 水溶性切削油剤は、希釈倍率20倍以下の良質のものをご使用下さい。
- 不溶性切削油剤または20倍を超える水溶性切削油剤の時は、切削速度を30%下げてください。
- ドリル装着に際しては、傷や汚れの無いコレットを用い、ドリルの振れは0.02mm以下に抑えて下さい。
- 被削材の保持はしっかりと行ない、変形、たわみ、振動が起こらない状態にしてください。
- 油穴の詰まりは折損トラブルの原因になります。給油装置のフィルタは必ず装着して下さい。

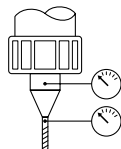

- The indicated speeds and feeds are for **water-soluble oil**.
- Suitable cutting fluid is water-soluble high density oil (less than 20 times dilution).
- When using non-water-soluble oil or water-soluble oil (over 20 times dilution), reduce cutting speed by 30%.
- When inserting a drill into the machine, use a collet that does not have any scratches or dust located within internal bore. Also, **reduce deflection of drill to less than 0.02mm**.
- Fasten the work material to reduce the possibility of work deformation, deflection of machined surface, or vibration.
- A clogged oil hole can lead to a breakage. Make sure that a filter is attached to the oil feeder.



■ 抜群の耐久性能 Outstanding durability

使用工具 Tool	WHO55-5D φ8.5
被削材 Work Material	DH31S (53HRC)
切削速度 Cutting Speed	30m/min (1,123min ⁻¹)
送り速度 Feed Rate	191mm/min (0.17mm/rev)
穴深さ Depth of Hole	24.5mm (2.9D 止り) Blind
切削油剤 Coolant	水溶性切削油剤 塩素フリー (内部給油) Water-Soluble Chlorine-Free (Internal)
使用機械 Machine	立形マシニングセンタ (BT40) Vertical Machining Center

■ 摩耗推移 Wear Changes

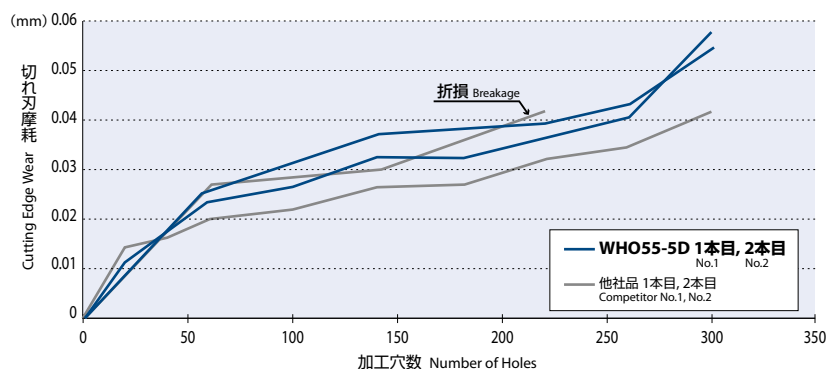

■ 300穴加工後 After Drilling 300 Holes

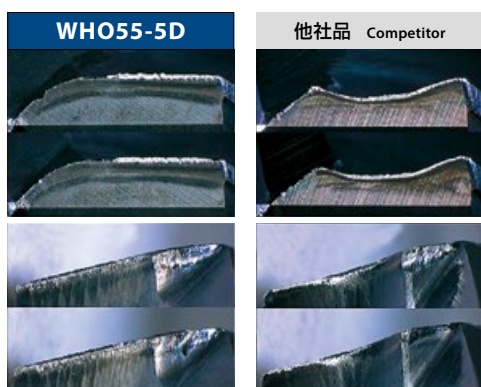

他社品の場合、1本目は300穴加工可能もばらつきが大きく、WHO55-5Dでは安定した耐久であった。

加工穴径の拡大傾向にある他社品と比べ、WHO55-5Dでは拡大を小さく抑えることができた。

The first trial by the competitor tool drilled 300 holes with large variances in cutting wear. The WHO55-5D, on the other hand, exhibited stable durability throughout the trial. Moreover, the competitor tool exhibited hole enlargement tendency, while the WHO55-5D was able to suppress the amount of oversize margin to a minimum.

■ 穴拡大量の分布 Distribution of Hole Enlargement

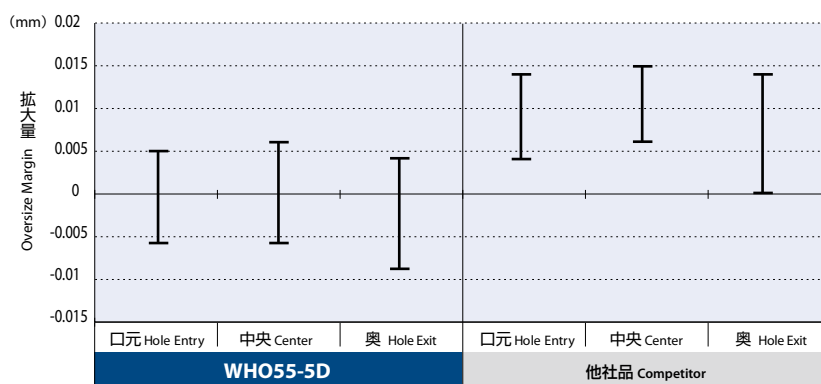

■ 再研磨品における性能比較 Performance comparison of reground products.

使用工具 Tool	WHO55-5D (特殊品・再研磨品) φ8.5 Special Order Product・Reground
被削材 Work Material	DH31S (53HRC)
切削速度 Cutting Speed	30m/min (1,123min ⁻¹)
送り速度 Feed Rate	191mm/min (0.17mm/rev)
穴深さ Depth of Hole	24.5mm (2.9D 止り) Blind
切削油剤 Coolant	水溶性切削油剤 塩素フリー (内部給油) Water-Soluble Chlorine-Free (Internal)
使用機械 Machine	立形マシニングセンタ (BT40) Vertical Machining Center

■ すくい面の写真 Photo of Rake Face



■ 逃げ面の写真 Photo of Flank Face

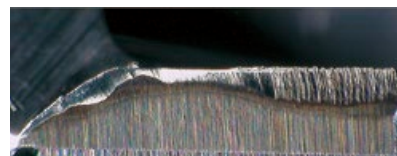

■ 外周マージンの写真 Photo of Peripheral Margin

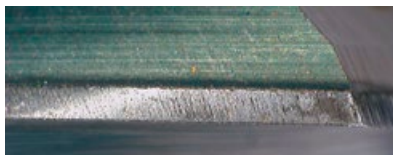

再研磨品でもDH31Sを80穴加工可能。初期折損はなく、市販の研磨機で再研磨可能。さらに、再コーティングにより寿命の向上が見込める。It was able to machine 80 holes. There was no initial breakage and only ordinary wear was exhibited. It is possible to extend its tool life by recoating.

WH70-DRL

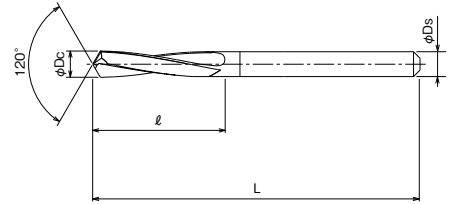

単位:mm Unit:mm

ツールNo. EDP No.	直径 Dc	溝長 ℓ	全長 L	シャンク径 Ds	在庫 Stock	標準価格 (Yen)				
3318200	2	12	42	3	B	8,590				
3318210	2.1					9,340				
3318220	2.2	13	43			9,340				
3318230	2.3					9,340				
3318240	2.4	14	44			9,340				
3318250	2.5					9,340				
3318260	2.6					9,340				
3318270	2.7					9,340				
3318280	2.8	16	46			9,340				
3318290	2.9					9,340				
3318300	3			9,340						
3318310	3.1	18	48	4	B	10,100				
3318320	3.2					10,100				
3318330	3.3	20	50			10,100				
3318340	3.4					10,100				
3318350	3.5					10,100				
3318360	3.6					10,600				
3318370	3.7	22	52			10,600				
3318380	3.8					10,600				
3318390	3.9					10,600				
3318400	4	25	54			10,600				
3318410	4.1			12,000						
3318420	4.2	28	68	5	B	12,000				
3318430	4.3					12,000				
3318440	4.4					12,000				
3318450	4.5					12,000				
3318460	4.6					13,600				
3318470	4.7					32	72	13,600		
3318480	4.8							13,600		
3318490	4.9							13,600		
3318500	5					35	74	6	B	13,600
3318510	5.1									15,100
3318520	5.2	15,100								
3318530	5.3	15,100								
3318540	5.4	40	83	7	B	15,100				
3318550	5.5					15,100				
3318560	5.6					16,200				
3318570	5.7					16,200				
3318580	5.8					16,200				
3318590	5.9					16,200				
3318600	6	45	85	7	B	16,200				
3318610	6.1					18,200				
3318620	6.2					18,200				
3318630	6.3					18,200				
3318640	6.4	45	83	7	B	18,200				
3318650	6.5					16,200				
3318660	6.6					19,200				
3318670	6.7	45	83	7	B	19,200				
3318680	6.8					17,100				
3318690	6.9	45	83	7	B	19,200				
3318700	7					17,100				

ツールNo. EDP No.	直径 Dc	溝長 ℓ	全長 L	シャンク径 Ds	在庫 Stock	標準価格 (Yen)
3318710	7.1	45	94	8	B	20,300
3318720	7.2					20,300
3318730	7.3					20,300
3318740	7.4					20,300
3318750	7.5					17,900
3318760	7.6					21,300
3318770	7.7					21,300
3318780	7.8					21,300
3318790	7.9					21,300
3318800	8					50
3318810	8.1	22,200				
3318820	8.2	22,200				
3318830	8.3	22,200				
3318840	8.4	22,200				
3318850	8.5	19,500				
3318860	8.6	23,100				
3318870	8.7	20,400				
3318880	8.8	23,100				
3318890	8.9	23,100				
3318900	9	57	106	10	B	20,400
3318910	9.1					24,900
3318920	9.2					24,900
3318930	9.3					24,900
3318940	9.4					24,900
3318950	9.5					22,000
3318960	9.6					25,700
3318970	9.7					25,700
3318980	9.8					25,700
3318990	9.9					25,700
3319000	10	63	113	11	B	22,900
3319010	10.1					26,800
3319020	10.2					26,800
3319030	10.3					23,800
3319040	10.4					26,800
3319050	10.5					23,800
3319060	10.6					27,500
3319070	10.7					27,500
3319080	10.8					27,500
3319090	10.9					27,500
3319100	11	71	120	12	B	24,300
3319110	11.1					28,800
3319120	11.2					28,800
3319130	11.3					28,800
3319140	11.4					28,800
3319150	11.5					25,600
3319160	11.6					29,900
3319170	11.7					29,900
3319180	11.8					29,900
3319190	11.9					29,900
3319200	12	26,500				

B=標準在庫品 B=Standard stock item

●マークの説明はp.1をご覧ください。 ● See p. 1 for explanation of marks.

当社営業までお問い合わせ下さい
Please contact our sales staff for more information.

外径・長さ・精度違いの特殊品も承ります
Custom order with specific requests on diameter, length and accuracy is accepted.



切削条件基準表 Cutting Conditions

被削材 Work Material	特殊鋼・調質鋼・(マルテンサイト系)ステンレス鋼 SKD11・SKT・SUS440 Special Alloy Steels・Hardened Steels・(Martensitic)Stainless Steel 55~60HRC		高速度工具鋼・特殊鋼・調質鋼 SKH・SKD11・SKS High-Speed Steel・Special Alloy Steels・Hardened Steels 60~70HRC	
	10~16m/min		8~13m/min	
切削速度 Cutting Speed	10~16m/min		8~13m/min	
直径 Drill Dia. (mm)	回転速度 Speed (min ⁻¹)	送り量 Feed Rate (mm/rev)	回転速度 Speed (min ⁻¹)	送り量 Feed Rate (mm/rev)
2	2,000	~0.04	1,900	~0.04
3	1,330	~0.04	1,250	~0.04
4	1,000	~0.04	950	~0.04
5	800	~0.04	750	~0.04
6	670	~0.04	630	~0.04
8	500	~0.04	480	~0.04
10	400	~0.04	380	~0.04
12	330	~0.04	320	~0.04

1. 水溶性切削油剤は希釈倍率5~10倍の良質のものをご使用下さい。
 2. ホルダは振れ精度が良く、把握力の大きなものをお使い下さい。
 3. 穴深さが直径の3倍を超える場合は、ステップ送りを行って下さい。
 4. 切りくずがドリルにからみつくような被削材の場合はステップ送りを行って下さい。
1. Use a **water-soluble oil** with high density (5 - 10 times dilution).
 2. Tight clamping is critical.
 3. For drilling depth > 3D, use a step feed.
 4. For materials susceptible to chip packing in the flute, apply a step feed.

60HRCで60穴 60 hole on 60HRC

使用工具 Tool	WH70-DRL φ5.1
被削材 Work Material	SKD11 (60HRC)
切削速度 Cutting Speed	10m/min (624min ⁻¹)
送り速度 Feed Rate	25mm/min (0.04mm/rev)
穴深さ Depth of Hole	19mm (3.7D通り) Through
切削油剤 Coolant	水溶性切削油剤 塩素フリー10倍(外部給油) Water-Soluble Chlorine-Free 10% (External)
使用機械 Machine	立形マシニングセンタ (BT40) Vertical Machining Center

WH70-DRLは従来品に比べ3倍の耐久性能であった。
WH70-DRL showed 3 times better tool life than conventional tool.

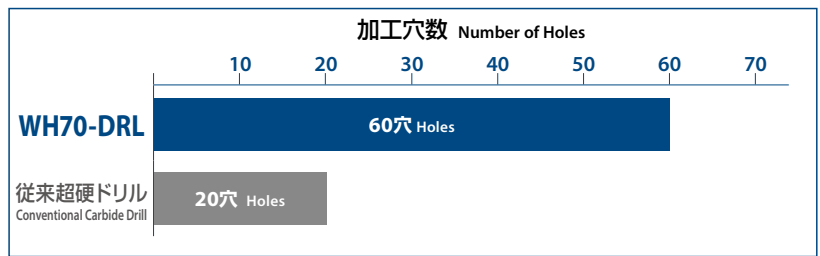

60穴加工後 After Drilling 60 Holes



他社の半分の摩耗量 A half of wear amount against the competition.

使用工具 Tool	WH70-DRL φ8
被削材 Work Material	SKD11 (60HRC)
切削速度 Cutting Speed	12.6m/min (501min ⁻¹)
送り速度 Feed Rate	20mm/min (0.04mm/rev)
穴深さ Depth of Hole	24mm (3D止り) Blind
切削油剤 Coolant	水溶性切削油剤 塩素フリー10倍(外部給油) Water-Soluble Chlorine-Free 10% (External)
使用機械 Machine	立形マシニングセンタ (BT40) Vertical Machining Center

摩耗は他社品に比べ半分程度。
WH70-DRLは220穴まで加工可能であった。
WH70-DRL showed a half amount of wear against a competition. Completed 220 holes.

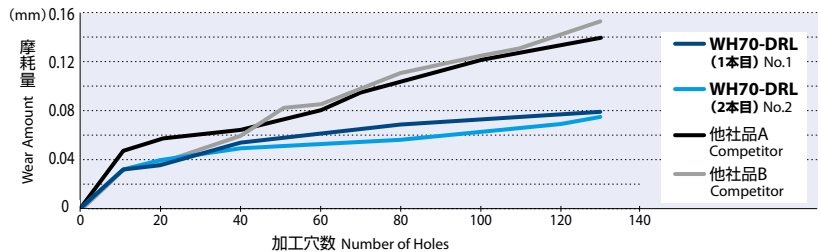

130穴加工後 After Drilling 130 Holes



V-XPM-HT

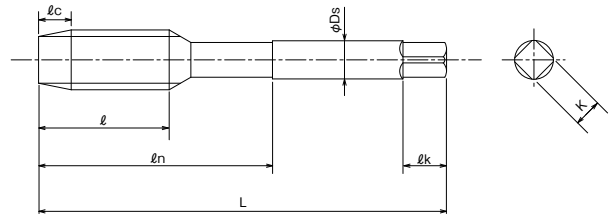

単位:mm Unit:mm

ツールNo. EDP No.	呼び Thread Size	食付 ℓ_c	精度表記 Grade	精度 TAP Limit	全長 L	ねじ長 ℓ	首下長 ℓ_n	シャンク径 D _s	溝数 Flutes	突出しセクタ External Center	推奨下穴径 Recommended Drill Hole Dia.	在庫 Stock	標準価格 (Yen)
8330255	M 3 × 0.5	5P	STD	OH3	46	11	19	4	4	○	2.5	D	5,050
8330256		2.5P											5,050
8330261	M 4 × 0.7	5P	STD	OH3	52	13	21	5	4	○	3.3	D	4,890
8330262		2.5P											4,890
8330267	M 5 × 0.8	5P	STD	OH3	60	16	24	5.5	4	○	4.2	D	4,980
8330268		2.5P											4,980
8330273	M 6 × 1	5P	STD	OH3	62	19	29	6	4	○	5	D	5,120
8330274		2.5P											5,120
8330285	M 8 × 1.25	5P	STD	OH3	70	22	37	6.2	5	-	6.8	D	6,570
8330286		2.5P											6,570
8330291	M 8 × 1	5P	STD	OH3	70	22	37	6.2	5	-	7	D	8,250
8330292		2.5P											8,250
8330297	M 10 × 1.5	5P	STD	OH3	75	24	41	7	5	-	8.5	D	7,960
8330298		2.5P											7,960
8330303	M 10 × 1.25	5P	STD	OH3	75	24	41	7	5	-	8.8	D	7,960
8330304		2.5P											7,960
8330309	M 10 × 1	5P	STD	OH3	75	24	41	7	5	-	9	D	9,950
8330310		2.5P											9,950
8330315	M 12 × 1.75	5P	STD	OH3	82	29	48	8.5	5	-	10.3	D	10,600
8330316		2.5P											10,600
8330321	M 12 × 1.5	5P	STD	OH3	82	29	48	8.5	5	-	10.5	D	10,600
8330322		2.5P											10,600
8330327	M 12 × 1.25	5P	STD	OH4	82	29	48	8.5	5	-	10.8	D	10,600
8330328		2.5P											10,600

D=在庫センター標準在庫品 D=Inventory center stock item ○=Yes

●マークの説明はp.1をご覧ください。

1. 精度欄 は2級めねじ相当適応のタップ推奨精度です。
2. タップ精度はめねじ精度を保証するものではありません。
3. シャンク四角部寸法、 ℓ_k 、Kは総合カタログ「穴加工・ねじ加工工具」を参照下さい。

● See p. 1 for explanation of marks.

1. The recommended TAP Limit corresponds to JIS class 2 internal thread standard.
2. TAP Limit does not guarantee thread limit for the internal thread after tapping.
3. Refer to OSG's "Drilling and Threading Tools" general catalog for lengths of the ℓ_k and K of the square shank.

切削条件基準表 Cutting Conditions

被削材 Work Material	高硬度鋼 (合金鋼・ダイス鋼・工具鋼 等) Hardened Steels (Alloy Steels, Die Steels, Tool Steels, etc.)
	42~52HRC
切削速度 Cutting Speed	1~3m/min
切削油剤 Coolant	不水溶性切削油剤 Non-Water-Soluble
使用機械 Machine	マシニングセンタ Machining Center



V-XPM-TPT

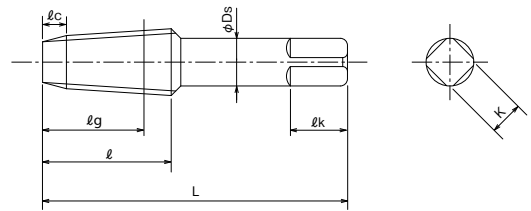

ねじの種類 : PT (Rc)

単位 : mm Unit: mm

ツールNo. EDP No.	呼び Thread Size	精度 TAP Limit	食付 ℓ_c	全長 L	ねじ長 ℓ	基準径位置 ℓ_g	シャンク径 D _s	溝数 Flutes	在庫 Stock	標準価格 (Yen)
8313801	PT 1/8 - 28	JIS2	3P	59	19	13	8	5	D	8,800
8313802	PT 1/4 - 19	JIS2	3P	67	28	21	11	5	D	11,300
8313803	PT 3/8 - 19	JIS2	3P	75	28	21	14	5	D	17,600
8313804	PT 1/2 - 14	JIS2	3P	87	35	25	18	5	D	26,700
8313806	PT 3/4 - 14	JIS2	3P	96	35	25	23	5	D	40,700
8313808	PT 1 - 11	JIS2	3P	109	45	32	26	5	D	73,000

D=在庫センター標準在庫品 D=Inventory center stock item

●マークの説明はp.1をご覧ください。

1. タップ精度はめねじ精度を保証するものではありません。
2. シャンク四角部寸法、 ℓ_k 、Kは総合カタログ「穴加工・ねじ加工工具」を参照下さい。

● See p. 1 for explanation of marks.

1. TAP Limit does not guarantee thread limit for the internal thread after tapping.
2. Refer to OSG's "Drilling and Threading Tools" general catalog for lengths of the ℓ_k and K of the square shank.

切削条件基準表 Cutting Conditions

被削材 Work Material	高硬度鋼 (合金鋼・ダイス鋼・工具鋼 等) Hardened Steels (Alloy Steels, Die Steels, Tool Steels, etc.) 45~50HRC
切削速度 Cutting Speed	1~3m/min
切削油剤 Coolant	不水溶性切削油剤 Non-Water-Soluble
使用機械 Machine	マシニングセンタ Machining Center

1982年、ISO導入によりJISの管用ねじ規格が改正され、ねじの呼び記号が変更されましたが、ねじ精度の変更はないため、タップは新旧記号を共有することが可能です。

The JIS pipe thread standard was revised in 1982 to meet ISO standards. Although thread symbols changed, the limits were not changed. Therefore, it is still acceptable to use taps with both new and old symbols.

種類 Type	旧記号 Old Symbol	新記号 New Symbol
耐密用テーパめねじ Taper pipe threads for pressure-tight joints	PT	Rc
耐密用平行めねじ Parallel pipe threads for pressure-tight joints	PS	Rp
機械的結合用平行めねじ Parallel pipe threads for mechanical joints	PF	G

(JIS B 0202-1982)
JIS B 0203-1982)

従来のハイスでは加工の難しかった45HRCを超える高硬度材にも抜群の切削性能

It exhibited outstanding cutting performance on hardened materials exceeding 45HRC, which could not be worked easily with conventional high speed steel taps.

使用工具 Tool	V-XPM-TPT PT1/4-19
被削材 Work Material	SKD61 (45HRC)
下穴 Drill Hole Size	10.9mm
ねじ立て長さ Tapping Length	21mm (基準径位置まで) Till Position of Gauge Diameter
切削速度 Cutting Speed	2.9m/min (70min ⁻¹)
切削油剤 Coolant	不水溶性切削油剤 Non-Water-Soluble
使用機械 Machine	立形マシニングセンタ Vertical Machining Center

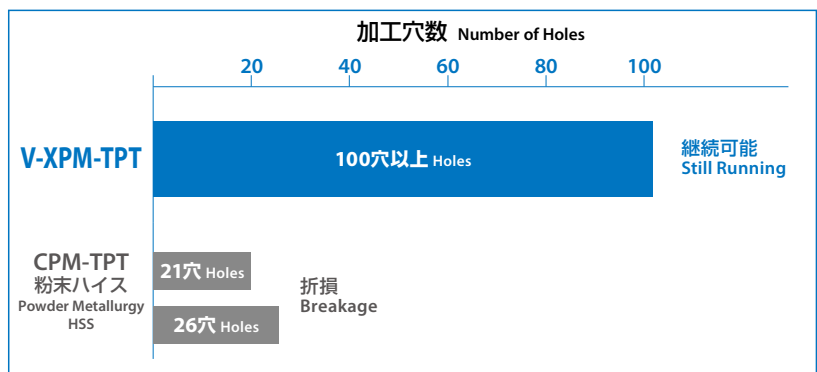

WH55-OT

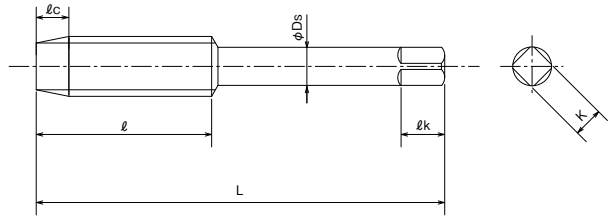

単位:mm Unit:mm

ツールNo. EDP No.	呼び Thread Size	食付 ℓ_c	精度表記 Grade	精度 TAP Limit	全長 L	ねじ長 ℓ	首下長 ℓ_n	シャンク径 D_s	溝数 Flutes	突出しセンタ External Center	推奨下穴径 Recommended Drill Hole Dia	在庫 Stock	標準価格 (Yen)
3901010	M 3 × 0.5	5P	STD	OH3	46	11	19	4	4	○	2.5	B	13,900
3901011		2.5P											13,900
3901014	M 4 × 0.7	5P	STD	OH3	52	13	21	5	4	○	3.3	B	14,400
3901015		2.5P											14,400
3901018	M 5 × 0.8	5P	STD	OH3	60	16	24	5.5	4	○	4.2	B	15,000
3901019		2.5P											15,000
3901022	M 6 × 1	5P	STD	OH3	62	19	29	6	4	○	5	B	16,300
3901023		2.5P											16,300
3901026	M 8 × 1.25	5P	STD	OH3	70	22	-	6.2	5	-	6.8	B	20,100
3901027		2.5P											20,100
3901030	M 10 × 1.5	5P	STD	OH3	75	24	-	7	5	-	8.5	B	27,200
3901031		2.5P											27,200
3901034	M 12 × 1.75	5P	STD	OH3	82	29	-	8.5	5	-	10.3	B	35,000
3901035		2.5P											35,000

B=標準在庫品 B=Standard stock item ○=Yes

●マークの説明はp.1をご覧ください。

● See p. 1 for explanation of marks.

1. 精度欄 は2級めねじ相当適応のタップ推奨精度です。
2. タップ精度はめねじ精度を保証するものではありません。
3. シャンク四角部寸法、 ℓk 、 K は総合カタログ「穴加工・ねじ加工工具」を参照下さい。

1. The recommended TAP Limit corresponds to JIS class 2 internal thread standard.
2. TAP Limit does not guarantee thread limit for the internal thread after tapping.
3. Refer to OSG's "Drilling and Threading Tools" general catalog for lengths of the ℓk and K of the square shank.

当社営業まで問い合わせ下さい
Please contact our sales staff for more information.

硬い被削材用にWH62-OT(特殊品)も承ります
We take orders of WH62-OT for higher hardness materials.

切削条件基準表 Cutting Conditions

被削材 Work Material	高硬度鋼(合金鋼・ダイス鋼・工具鋼等) Hardened Steels (Alloy Steels, Die Steels, Tool Steels, etc.)	
	42~50HRC	50~55HRC
切削速度 Cutting Speed	2~4m/min	1~3m/min
切削油剤 Coolant	水溶性切削油剤、不水溶性切削油剤 Water-Soluble, Non-Water-Soluble	
使用機械 Machine	マシニングセンタ Machining Center	

1. WH55-OTは切削速度と切削油剤の選定に注意して下さい。ペーストは推奨致しません。
2. 水溶性切削油剤を使用する場合、水溶性切削油剤の中でもより潤滑性に優れた切削油剤をご使用下さい。
3. 手立てによるタッピングは、切りくずの噛み込みがあり、タップの欠けが予想されますので、避けて下さい。

1. Make sure to select the correct cutting speed and cutting fluids. Tapping paste is not recommended.
2. When using a water-soluble oil, use one with the highest lubricity level.
3. The WH55-OT is designed for machine use only. Tapping by hand will cause chips to get stuck between the tool and the work material, and result in chipping of the taps.

DAC55を安定加工 Stable machining on DAC55

使用工具 Tool	WH55-OT M6×1 5P
被削材 Work Material	DAC55 (48HRC)
下穴 Drill Hole Size	φ5.1×21mm (通り) Through
ねじ立て長さ Tapping Length	12mm (2D 止り) Blind
切削速度 Cutting Speed	3m/min (159min ⁻¹)
切削油剤 Coolant	水溶性切削油剤 塩素フリー10倍 Water-Soluble Chlorine-Free 10%
使用機械 Machine	立形マシニングセンタ (同期送り機構付き) Vertical Synchronized Machining Center

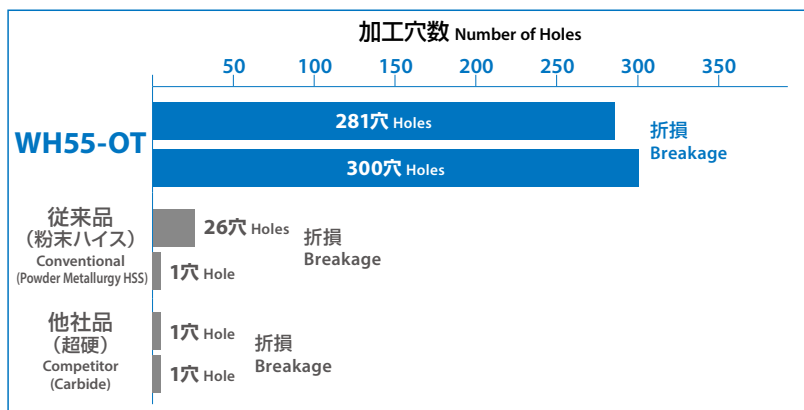

従来タップ(粉末ハイス)の10倍以上の耐久性と安定性を実現! 他社品(超硬)が対応不能の加工が、300穴近くまで加工可能に!

WH55-OT achieved more than 10 times the durability and stability versus the conventional tap (Powder Metallurgy HSS). Moreover, WH55-OT was able to machine close to 300 holes, while the competitor's carbide drill broke in less than 30 holes.

STAVAXも安定加工! しかも、水溶性切削油剤! Stable machining on STAVAX, even with water-soluble coolant.

使用工具 Tool	WH55-OT M6×1 5P
被削材 Work Material	STAVAX (52HRC)
下穴 Drill Hole Size	φ5.1×17.5mm (止り) Blind
ねじ立て長さ Tapping Length	9mm (1.5D止り) Blind
切削速度 Cutting Speed	3m/min (159min ⁻¹)
切削油剤 Coolant	水溶性切削油剤 塩素フリー10倍 Water-Soluble Chlorine-Free 10%
使用機械 Machine	立形マシニングセンタ (同期送り機構付き) Vertical Synchronized Machining Center



従来タップ(粉末ハイス)では10穴程度で折損していたものが、1,000穴近く加工可能となった。

Conventional tap (Powder Metallurgy HSS) broke after 10 holes while WH55-OT has completed almost 1,000 holes.

58HRCで他社の15倍以上 Over 15 times better tool life on 58HRC against a competition.

使用工具 Tool	WH62-OT (特殊品) M6×1 5P Special
被削材 Work Material	SKD11 (58HRC)
下穴 Drill Hole Size	φ5.1×21mm (通り) Through
ねじ立て長さ Tapping Length	12mm (2D 止り) Blind
切削速度 Cutting Speed	2m/min (106min ⁻¹)
切削油剤 Coolant	水溶性切削油剤 塩素フリー10倍 Water-Soluble Chlorine-Free 10%
使用機械 Machine	立形マシニングセンタ (同期送り機構付き) Vertical Synchronized Machining Center

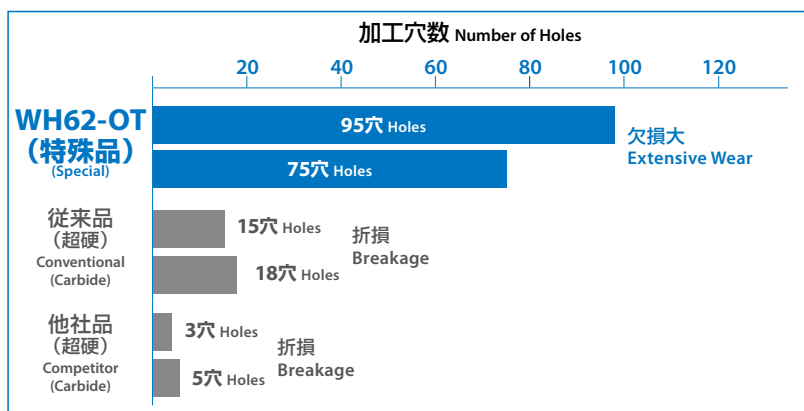

WXSコーティングを施した特殊タップで、従来不可能であった「58HRCを超える高硬度材の水溶性切削油剤でのタッピング」を実現。

The WH62-OT (special) with WXS coating made the tapping of over 58HRC tough steel with water-soluble oil possible, which is a process that cannot be achieved by the conventional tap and competitor tool.

VX-OT

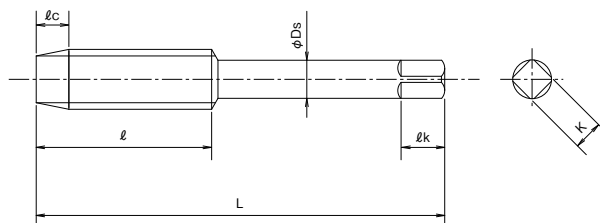

単位:mm Unit:mm

ツールNo. EDP No.	呼び Thread Size	食付 ℓ_c	精度表記 Grade	精度 TAP Limit	全長 L	ねじ長 ℓ	首下長 ℓ_n	シャンク径 D_s	溝数 Flutes	突出しセクタ External Center	推奨下穴径 Recommended Drill Hole Dia.	在庫 Stock	標準価格 (Yen)
8330029	M 2 × 0.4	3P	STD	OH3	40	12	—	3	3	○	1.6	D	15,000
8330039	M 2.3 × 0.4	3P	STD	OH3	42	13	—	3	4	○	1.9	D	16,100
8330045	M 2.5 × 0.45	3P	STD	OH3	44	14	—	3	4	○	2.05	D	15,800
8330049	M 2.6 × 0.45	3P	STD	OH3	44	14	—	3	4	○	2.15	D	14,600
8330055	M 3 × 0.5	3P	STD	OH3	46	11	19	4	4	○	2.5	B	13,900
8330061	M 4 × 0.7	3P	STD	OH3	52	13	21	5	4	○	3.3	B	14,400
8330067	M 5 × 0.8	3P	STD	OH3	60	16	24	5.5	4	○	4.2	B	15,000
8330073	M 6 × 1	3P	STD	OH3	62	19	29	6	5	○	5	B	16,300
8330085	M 8 × 1.25	3P	STD	OH3	70	22	—	6.2	5	—	6.8	B	20,100
8330087	M 8 × 1	3P	STD	OH3	70	22	—	6.2	5	—	7	B	20,100
8330097	M 10 × 1.5	3P	STD	OH3	75	24	—	7	5	—	8.5	B	27,200
8330099	M 10 × 1.25	3P	STD	OH3	75	24	—	7	5	—	8.8	B	27,200
8330101	M 10 × 1	3P	STD	OH3	75	24	—	7	5	—	9	B	27,200
8330115	M 12 × 1.75	3P	STD	OH3	82	29	—	8.5	5	—	10.3	B	35,000
8330117	M 12 × 1.5	3P	STD	OH3	82	29	—	8.5	5	—	10.5	B	35,000
8330119	M 12 × 1.25	3P	STD	OH4	82	29	—	8.5	5	—	10.8	B	35,000
8330121	M 12 × 1	3P	STD	OH3	82	29	—	8.5	5	—	11	B	35,000
8330123	M 14 × 2	3P	STD	OH4	88	30	—	10.5	6	—	12	D	53,800
8330125	M 14 × 1.5	3P	STD	OH3	88	30	—	10.5	6	—	12.5	D	53,800
8330131	M 16 × 2	3P	STD	OH4	95	32	—	12.5	6	—	14	D	64,800
8330133	M 16 × 1.5	3P	STD	OH3	95	32	—	12.5	6	—	14.5	D	64,800
8330139	M 18 × 2.5	3P	STD	OH4	100	37	—	14	6	—	15.5	D	78,100
8330141	M 18 × 1.5	3P	STD	OH4	100	37	—	14	6	—	16.5	D	78,100
8330147	M 20 × 2.5	3P	STD	OH4	105	37	—	15	6	—	17.5	D	90,700
8330149	M 20 × 1.5	3P	STD	OH4	105	37	—	15	6	—	18.5	D	90,700

B=標準在庫品 B=Standard stock item D=在庫センター標準在庫品 D=Inventory center stock item ○=Yes

●マークの説明はp.1をご覧ください。

1. 精度欄 は2級めねじ相当適応のタップ推奨精度です。
2. タップ精度はめねじ精度を保証するものではありません。
3. シャンク四角部寸法、 ℓ_k 、 K は総合カタログ「穴加工・ねじ加工工具」を参照下さい。

●See p. 1 for explanation of marks.

1. The recommended TAP Limit corresponds to JIS class 2 internal thread standard.
2. TAP Limit does not guarantee thread limit for the internal thread after tapping.
3. Refer to OSG's "Drilling and Threading Tools" general catalog for lengths of the ℓ_k and K of the square shank.

切削条件基準表 Cutting Conditions

被削材 Work Material	高硬度鋼 (合金鋼・ダイス鋼・工具鋼 等) Hardened Steels (Alloy Steels, Die Steels, Tool Steels, etc.)
	50~62HRC
切削速度 Cutting Speed	1~3m/min
切削油剤 Coolant	不水溶性切削油剤 Non-Water-Soluble
使用機械 Machine	マシニングセンター Machining Center

1. VX-OTは切削速度と切削油剤の選定に注意して下さい。ペーストは推奨致しません。
2. 手立てによるタッピングは、切りくずの噛み込みがあり、タップの欠けが予想されますので、避けて下さい。

1. Make sure to select the correct cutting speed and cutting fluids. Tapping paste is not recommended.
2. The VX-OT is designed for machine use only. Tapping by hand would cause chips to get stuck between the tool and the work material, and result in chipping of the taps.

当社営業まで問い合わせ下さい 水溶性切削油剤の場合はVH62-OT(特殊品)も承ります
Please contact our sales staff for more information. For water-soluble oil, use VH62-OT by special order.



VX-TPT

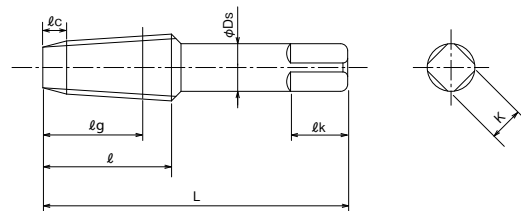

ねじの種類 : PT (Rc)

単位:mm Unit:mm

ツールNo. EDP No.	呼び Thread Size	精度 TAP Limit	食付 ℓ_c	全長 L	ねじ長 ℓ	基準径位置 ℓ_g	シャンク径 D _s	溝数 Flutes	在庫 Stock	標準価格 (Yen)
8330692	PT 1/8 - 28	JIS2	3P	59	19	13	8	5	D	37,500
8330693	PT 1/4 - 19	JIS2	3P	67	28	21	11	5	D	53,800
8330694	PT 3/8 - 19	JIS2	3P	75	28	21	14	6	D	60,700
8330695	PT 1/2 - 14	JIS2	3P	87	35	25	18	6	D	82,400

D=在庫センター標準在庫品 D=Inventory center stock item

●マークの説明はp.1をご覧ください。

1. タップ精度はめねじ精度を保証するものではありません。
2. シャンク四角部寸法、 ℓ_k 、Kは総合カタログ「穴加工・ねじ加工工具」を参照下さい。

● See p. 1 for explanation of marks.

1. TAP Limit does not guarantee thread limit for the internal thread after tapping.
2. Refer to OSG's "Drilling and Threading Tools" general catalog for lengths of the ℓ_k and K of the square shank.

切削条件基準表 Cutting Conditions

被削材 Work Material	高硬度鋼 (合金鋼・ダイス鋼・工具鋼 等) Hardened Steels (Alloy Steels, Die Steels, Tool Steels, etc.) 50~62HRC
切削速度 Cutting Speed	1~3m/min
切削油剤 Coolant	不水溶性切削油剤 Non-Water-Soluble
使用機械 Machine	マシニングセンタ Machining Center

1982年、ISO導入によりJISの管用ねじ規格が改正され、ねじの呼び記号が変更されましたが、ねじ精度の変更はないため、タップは新旧記号を共有することが可能です。

The JIS pipe thread standard was revised in 1982 to meet ISO standards. Although thread symbols changed, the limits were not changed. Therefore, it is still acceptable to use taps with both new and old symbols.

種類 Type	旧記号 Old Symbol	新記号 New Symbol
耐密用テーパめねじ Taper pipe threads for pressure-tight joints	PT	Rc
耐密用平行めねじ Parallel pipe threads for pressure-tight joints	PS	Rp
機械的結合用平行めねじ Parallel pipe threads for mechanical joints	PF	G

(JIS B 0202-1982)
(JIS B 0203-1982)

1. VX-TPTは切削速度と切削油剤の選定に注意して下さい。
ペーストは推奨致しません。

2. 手立てによるタッピングは、切りくずの噛み込みがあり、
タップの欠けが予想されますので、避けて下さい。

1. Make sure to select the correct cutting speed and cutting fluids. Tapping paste is not recommended.

2. The VX-TPT is designed for machine use only. Tapping by hand will cause chips to get stuck between the tool and the work material, and result in chipping of the taps.

54HRCに対して50穴以上の耐久

VX-TPT tapped more than 50 holes in 54HRC.

使用工具 Tool	VX-TPT PT1/8-28
被削材 Work Material	SKD11 (54HRC)
下穴 Drill Hole Size	$\phi 8.22 \times 20\text{mm}$ (通り) Through
ねじ立て長さ Tapping Length	13mm (基準径位置まで) Till Position of Gauge Diameter
切削速度 Cutting Speed	2.1m/min (70min ⁻¹)
切削油剤 Coolant	不水溶性切削油剤 Non-Water-Soluble
使用機械 Machine	立形マシニングセンタ Vertical Machining Center

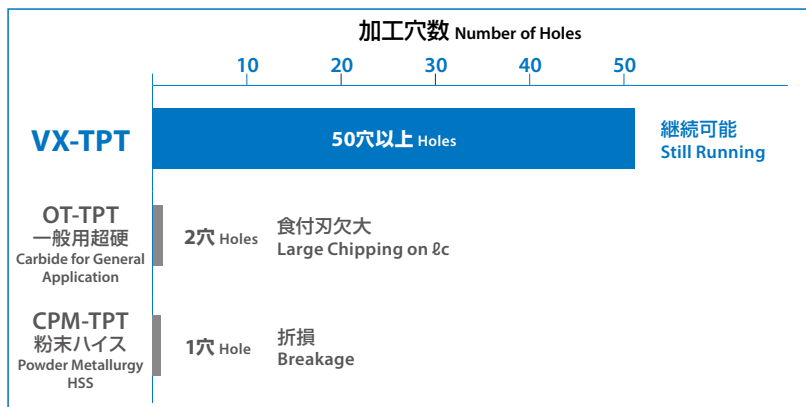



shaping your dreams

本 社
〒442-8543 愛知県豊川市本野ケ原三丁目22番地 TEL(0533)82-1111
E-mail : cs-info@osg.co.jp Web : https://www.osg.co.jp/
International Headquarters
3-22 Honnogahara, Toyokawa, Aichi, 442-8543, JAPAN
TEL : +81-533-82-1118 FAX : +81-533-82-1136

東部営業部
〒140-0002 東京都品川区東品川4-12-6
品川シーサイドキャナルタワー 19階 TEL(03)5715-2966

中部営業部
〒465-0058 愛知県名古屋市中東区貴船1-9 TEL(052)703-6131

西部営業部
〒550-0013 大阪府大阪市西区新町2-4-2 405号 TEL(06)6538-3880

〈工具の技術的なご相談は…〉 コミュニケーションダイヤル

よい 工 具 は 一 番

0120-41-5981 土日祝日、会社休日を除く

コミュニケーション FAX 0533-82-1134 コミュニケーションE-mail hp-info@osg.co.jp

仙 台 TEL(022) 390-9701
郡 山 TEL(024) 991-7485
新 潟 TEL(025) 288-3888
上 田 TEL(0268) 28-7381
諏 訪 TEL(0266) 58-0152
岡 毛 TEL(0270) 40-5855
宇都宮 TEL(028) 651-2720
八王子 TEL(042) 645-5406
茨 城 TEL(029) 354-7017
東 京 TEL(03) 5715-2966
厚 木 TEL(046) 230-5030
静 岡 TEL(054) 283-6651
浜 松 TEL(053) 461-1121
豊 川 TEL(0533) 82-1145
安 城 TEL(0566) 77-2366

名古屋 TEL(052) 703-6131
岐 阜 TEL(058) 259-6055
トヨタ TEL(0533) 82-1145
三 重 TEL(0594) 26-0416
金 沢 TEL(076) 268-0830
京 滋 TEL(077) 553-2012
大 阪 TEL(06) 4308-3411
明 石 TEL(078) 927-8212
岡 山 TEL(086) 241-0411
四 国 TEL(087) 868-4003
広 島 TEL(082) 507-1227
九 州 TEL(092) 504-1211
北九州 TEL(093) 922-8190
熊 本 TEL(096) 386-5120

安全にお使いいただくために

- 工具を使用する時は、破損する危険があるので、必ずカバー・保護眼鏡・安全靴等を使用して下さい。
• 切れ刃は素手で触らないで下さい。
• 切りくずは素手で触らないで下さい。
• 工具の切れ味が悪くなったら使用を中止して下さい。
• 異常音・異常振動が発生したら、直ちに使用を中止して下さい。
• 工具には手を加えないで下さい。
• 加工前に工具の寸法確認を行って下さい。

Safe use of cutting tools

- Use safety cover, safety glasses and safety shoes during operation.
• Do not touch cutting edges with bare hands.
• Do not touch cutting chips with bare hands. Chips will be hot after cutting.
• Stop cutting when the tool becomes dull.
• Stop cutting operation immediately if you hear any abnormal cutting sounds.
• Do not modify tools.
• Please use appropriate tools for the operation. Check dimensions to ensure proper selection.

OSG代理店

Copyright © 2016 OSG Corporation. All rights reserved.

- 製品については、常に研究・改良を行っておりますので、予告なく本カタログ掲載仕様を変更する場合があります。 Tool specifications are subject to change without notice.
• 本書掲載内容の無断転載・複製を禁じます。

C-91.web(DN) 22.08

オーエスジー株式会社

OSG