

TRUCK CRANE

TG-350M

TG

JAPANESE SPECIFICATIONS

CARRIER MODEL	OUTLINE	SPEC. NO.
NISSAN DIESEL W-KG520TN	4-section Boom 2-staged swingaround boom extension which stores below boom base section	TG-350M-4-10102
mitsubishi W-KS506S		TG-350M-4-20102

Control No. JA-02

TG-350M

CRANE SPECIFICATIONS

MAXIMUM TOTAL RATED LOAD

11.0m Boom	35,000kg	at 3.5m	(9 part-line)
15.0m Boom	28,000kg	at 4.0m	(7 part-line)
19.0m Boom	22,000kg	at 5.0m	(6 part-line)
27.0m Boom	15,000kg	at 6.5m	(4 part-line)
35.0m Boom	9,000kg	at 8.5m	(4 part-line)
9.0m Jib	4,000kg	at 77°	(1 part-line)
14.6m Jib	2,700kg	at 79°	(1 part-line)
Single top	4,000kg		(1 part-line)

MAX. LIFTING HEIGHT

Boom	34.5m
Jib	49.0m

MAX. WORKING RADIUS

Boom	32.0m
Jib	38.7m

BOOM LENGTH

11.0m – 35.0m

BOOM EXTENSION

24.0m

BOOM EXTENSION SPEED

24.0m / 88s

JIB LENGTH

9.0m, 14.6m

MAIN WINCH SINGLE LINE SPEED

High range:	102m/min	(3rd layer)
Low range:	48m/min	(3rd layer)

MAIN WINCH HOOK SPEED

High range:	11.3m/min	(9th layer)
Low range:	5.3m/min	(9th layer)

AUXILIARY WINCH SINGLE LINE SPEED

High range:	95m/min	(2nd layer)
Low range:	45m/min	(2nd layer)

AUXILIARY WINCH HOOK SPEED

High range:	95m/min	(1 part-line)
Low range:	45m/min	(1 part-line)

BOOM ELEVATION ANGLE

-3° – 80°

BOOM ELEVATION SPEED

-3° – 80° / 68s

SWING ANGLE

360° continue

SWING SPEED

2.0 rpm

WIRE ROPE

Main Winch

18mm × 190m (Diameter×Length)
7×7+6×Fi(29) Class C ordinary · Z twist
Spin-resistant wire rope
Breaking strength 24.3t

Auxiliary Winch

18mm × 110m (Diameter×Length)
7×7+6×Fi(29) Class B ordinary · Z twist
Spin-resistant wire rope
Breaking strength 22.3t

BOOM

4-section power telescoping boom of hexagonal box construction
(stages 2: sequential; stages 3,4: synchronized)

BOOM EXTENSION

2 double-acting hydraulic cylinder
1 wire rope type telescoping device
With flow regulator valve with pressure compensation

JIB

2-staged swingaround boom extension which stores below boom base section.
(2nd stage: pull-out type)
Triple offset (5°,25°,45°) type

SINGLE TOP

Single sheave. Mounted to main boom head for single line work.

HOIST

Driven by hydraulic motor and via planetary gear reducer.
With free-fall device.

Automatic brake (with foot brake for free-fall device)

2 single winches

With flow regulator valve with pressure compensation

BOOM ELEVATION

2 double-acting hydraulic cylinders

With flow regulator valve with pressure compensation

SWING

Hydraulic motor driven planetary gear reducer

Swing bearing

Hand brake

Swing free/lock changeover type

OUTRIGGERS

Fully hydraulic H-type (floats mounted integrally)

Slides and jacks each provided with independent operation device.

Full extended width 6.6m

Middle extended width 4.6m

FRONT JACK

Hydraulic operated type

MAX. OUTRIGGER LOAD

38.0t

HYDRAULIC PUMPS

4 variable gear pumps

HYDRAULIC OIL TANK CAPACITY

675 liters

SAFETY DEVICES

Automatic moment limiter (AML)

With working range limiting function

Over-winding cutout

Level gauge

Working area control device

Outrigger extension width detector

Hook safety latch

Cable follower

Winch drum lock

Winch drum rotation indicator

Swing lock

Hydraulic safety valve

Telescopic counterbalance valve

Elevation counterbalance valve

Jack pilot check valve

Front jack ground contact detector

Frontjack over load alarm

EQUIPMENTS

Crane cab heater

Oil cooler

Boom angle indicator

Radio

Fan

Block

CARRIER SPECIFICATIONS

MANUFACTURER

NISSAN DIESEL MOTOR CO., LTD

CARRIER MODEL

W-KG520TN

ENGINE

Model RF8

Type 4-cycle V8-cylinder, direct-injection, water-cooled diesel engine

Piston displacement 16,991cc

Max. output 340PS at 2,200rpm

Max. torque 120kg·m at 1,400rpm

CLUTCH

Dry multi-plate coil spring type

TRANSMISSION

7-forward and 1-reverse speeds

Synchromized - mesh gear (for 2nd-7th speeds)

REDUCER

Hypoid gear type

FRONT AXLE

Reverse Elliot-type steel pipe cross section

REAR AXLE

Full-floating type, cast-steel housing

SUSPENSION

Front Laminated leaf spring type

Rear Equalizer and torque rods

STEERING

Recirculating ball screw type with linkage power assistance

BRAKE SYSTEM

Service Brake

2-circuit air brake, 8-wheels internal expanding brake

Parking Brake

Machanically operated, duo-servo shoe type acting on drum at transmission case rear.

Auxiliary Brake

Electro-pneumatic operated exhaust brake

Emergency

Spring brake

ELECTRIC SYSTEM

24 V DC. 2 batteries of 12V- 115F51 (120Ah)

FUEL TANK CAPACITY

300 liters

CAB

Two-man type

TIRES

Front 12.00-20-18PR

Rear 11.00-20-14PR

STANDARD EQUIPMENTS

Car heater

Car radio

GENERAL DATA

DIMENSIONS

Overall length 13,190mm

Overall width 2,750mm

Overall height 3,700mm

Wheel base 1,470mm + 3,780mm + 1,400mm = 6,650mm

Tread Front 2,230mm

Rear 2,110mm

WEIGHTS

Gross vehicle weight

Total 35,390kg

Front 13,760kg

Rear 21,630kg

PERFORMANCE

Max. traveling speed 65km/h

Min. traveling speed 1.2km/h

Gradeability (tan θ) 0.62

Min. turning radius (Outermost wheel) 11.0m

CARRIER SPECIFICATIONS

MANUFACTURER

MITSUBISHI MOTOR CORPORATION

CARRIER MODEL

W-KS506S

ENGINE

Model 8DC10

Type 4-cycle V8-cylinder, direct-injection, water-cooled diesel engine

Piston displacement 16,752cc

Max. output 335PS at 2,200rpm

Max. torque 120kg-m at 1,300rpm

CLUTCH

Dry single-plate type, hydraulic control with clutch booster

TRANSMISSION

10-forward and 2-reverse speeds

Constant-mesh gear (1st speed, 2nd speed, reverse)

Synchronized-mesh gear (3rd-10th speeds)

REDUCER

1-stage speed reduction type

Hypoid gear type

FRONT AXLE

Reverse-elliot type steering knuckles

I-shape cross-section

REAR AXLE

Full-floating type, cast-steel housing, Sheet-metal housing

SUSPENSION

Front Laminated semi-elliptical leaf spring type

With torsion bar stabilizer (Front front axel only)

Rear Equalizer beam and torque rod type

STEERING

Recirculating ball screw type

With linkage type hydraulic power booster

BRAKE SYSTEM

Service Brake

Air brake on all wheels (dual air line system)

Parking Brake

Spring brake, acting on 4 rear wheels

Auxiliary Brake

Exhaust brake

ELECTRIC SYSTEM

24 V DC. 2 batteries of 12V-145F51 (112Ah)

FUEL TANK CAPACITY

300 liters

CAB

Two-man type

TIRES

Front 12.00-20-18PR

Rear 11.00-20-14PR

STANDARD EQUIPMENTS

Car heater

Car radio

GENERAL DATA

DIMENSIONS

Overall length 13,200mm

Overall width 2,750mm

Overall height 3,700mm

Wheel base 1,450mm + 3,850mm + 1,350mm = 6,650mm

Tread Front 2,240mm

Rear 2,050mm

WEIGHTS

Gross vehicle weight

Total 35,430kg

Front 13,735kg

Rear 21,695kg

PERFORMANCE

Max. traveling speed 70km/h

Min. traveling speed 1.9km/h

Gradeability (tan θ) 0.36

Min. turning radius (Outermost wheel) 11.0m

TOTAL RATED LOADS

Unit:ton

· Outriggers fully extended + Front jack (360°) · Outriggers fully extended (Over the Rear · Over the Sides)					
A B (m)	11.0 m	15.0 m	19.0 m	27.0 m	35.0 m
3.0	35.00	28.00	22.00		
3.5	35.00	28.00	22.00		
4.0	31.50	28.00	22.00		
4.5	28.50	26.60	22.00	15.00	
5.0	26.00	24.40	22.00	15.00	
5.5	23.80	22.50	21.00	15.00	
6.0	21.60	20.50	19.10	15.00	
6.5	20.00	19.20	17.70	15.00	9.00
7.0	18.40	18.00	16.60	14.00	9.00
7.5	17.00	16.80	15.60	13.10	9.00
8.0	15.60	15.70	14.60	12.30	9.00
8.5	14.30	14.20	13.70	11.55	9.00
9.0	13.10	12.90	12.80	10.90	8.60
10.0		10.75	10.60	9.90	8.00
11.0		8.90	8.75	9.00	7.40
12.0		7.45	7.35	8.15	6.80
13.0		6.35	6.20	7.05	6.25
14.0			5.30	6.10	5.80
16.0			3.90	4.70	5.00
18.0				3.65	4.00
20.0				2.85	3.20
22.0				2.20	2.60
24.0				1.65	2.10
26.0					1.65
28.0					1.25
30.0					0.90
32.0					0.65

A = Boom length

B = Working radius

Unit:ton

· Outriggers middle extended (360°) · Outriggers fully extended (Over the Front)						Without outriggers (Over the Rear)	
A B (m)	11.0 m	15.0 m	19.0 m	27.0 m	35.0 m	A B (m)	11.0 m
3.0	35.00	28.00	22.00			3.0	8.00
3.5	31.00	28.00	22.00			3.5	6.40
4.0	27.50	27.50	22.00			4.0	5.10
4.5	24.50	24.50	22.00	15.00		4.5	4.20
5.0	21.30	20.95	21.00	15.00		5.0	3.40
5.5	16.85	16.55	16.35	15.00		5.5	2.80
6.0	13.75	13.50	13.25	14.55		6.0	2.30
6.5	11.50	11.25	11.05	12.25	9.00	6.5	1.90
7.0	9.80	9.55	9.35	10.45	9.00	7.0	1.60
7.5	8.40	8.20	8.00	9.05	9.00	7.5	1.25
8.0	7.30	7.10	6.90	7.90	8.35	8.0	1.00
8.5	6.40	6.20	6.00	6.95	7.40		
9.0	5.60	5.40	5.25	6.20	6.60		
10.0		4.20	4.05	4.95	5.35		
11.0		3.30	3.15	4.00	4.40		
12.0		2.55	2.35	3.25	3.60		
13.0		1.90	1.70	2.65	3.00		
14.0			1.20	2.10	2.50		
16.0				1.25	1.70		
18.0					1.05		

A = Boom length
 B = Working radius

Unit:ton

· Outriggers fully extended + Front jack (360°) · Outriggers fully extended (Over the Rear · Over the Sides)							
E (°)	9.0 m			14.6 m			
	D C	5°	25°	45°	5°	25°	45°
80		4.00	2.20	1.26	2.70	1.30	0.70
79		4.00	2.20	1.26	2.70	1.30	0.70
78		4.00	2.20	1.26	2.57	1.30	0.70
77		4.00	2.20	1.25	2.45	1.30	0.69
76		3.86	2.20	1.24	2.30	1.30	0.68
75		3.68	2.20	1.22	2.17	1.30	0.67
73		3.34	2.20	1.20	1.96	1.30	0.65
70		2.91	2.03	1.16	1.70	1.16	0.63
68		2.68	1.90	1.14	1.56	1.10	0.61
65		2.40	1.75	1.10	1.38	1.05	0.60
63		2.24	1.66	1.08	1.27	1.01	0.59
60		2.02	1.54	1.05	1.13	0.98	0.58
58		1.90	1.46	1.03	1.06	0.96	0.58
55		1.53	1.34	1.00	0.96	0.94	0.57
53		1.29	1.16	0.98	0.93	0.91	0.57
50		0.99	0.89	0.84	0.79	0.69	0.56
48		0.82	0.73	0.70	0.64	0.57	0.54
45		0.59	0.53	0.50	0.45	0.40	0.38
43		0.46	0.42	0.39			

· Outriggers middle extended (360°) · Outriggers fully extended (Over the Front)							
E (°)	9.0 m			14.6 m			
	D C	5°	25°	45°	5°	25°	45°
80		4.00	2.20	1.26	2.70	1.30	0.70
79		4.00	2.20	1.26	2.70	1.30	0.70
78		4.00	2.20	1.26	2.57	1.30	0.70
77		4.00	2.20	1.25	2.45	1.30	0.69
76		3.74	2.20	1.24	2.30	1.30	0.68
75		3.35	2.20	1.22	2.17	1.30	0.67
73		2.66	1.98	1.20	1.96	1.30	0.65
70		1.80	1.32	1.14	1.33	1.00	0.63
68		1.32					

C = Jib length

D = Jib offset

E = Boom angle

NOTES:

1. The total rated loads shown are for the case when the outriggers are set horizontally on firm ground. The values are based on the crane strength.
2. The weights of slings and hooks (350kg for a 35 ton capacity hook and 100kg for a 4 ton capacity hook) are included in the total rated loads shown.
3. The total rated load is based on the actual working radius including the deflection of the boom.
4. The number of part lines for each boom length should not exceed the values below. The load per line should not exceed 4 tons for both the main winch and the auxiliary winch.

A	11.0 m	15.0 m	19.0 m	27.0 m	35.0 m	J
H	9	7	6	4	4	1

A = Boom length H = No. of part-line J = Jib / Single top

5. The total rated loads for free-fall operations is 1/5 of the total rated loads given above. The load per line should not exceed 0.8 ton for both the main winch and the auxiliary winch. Free-fall operations should not be performed without the outriggers.
6. The total rated load for the single top is the same as that of the main boom and must not exceed 4 tons. However, when hooks, slings, etc. are mounted on the main boom, one should work with the total rated load obtained by subtracting the weights of the hooks, slings, etc. mounted on the main boom from the total rated load of the main boom.

WORKING RADIUS - LIFTING HEIGHT

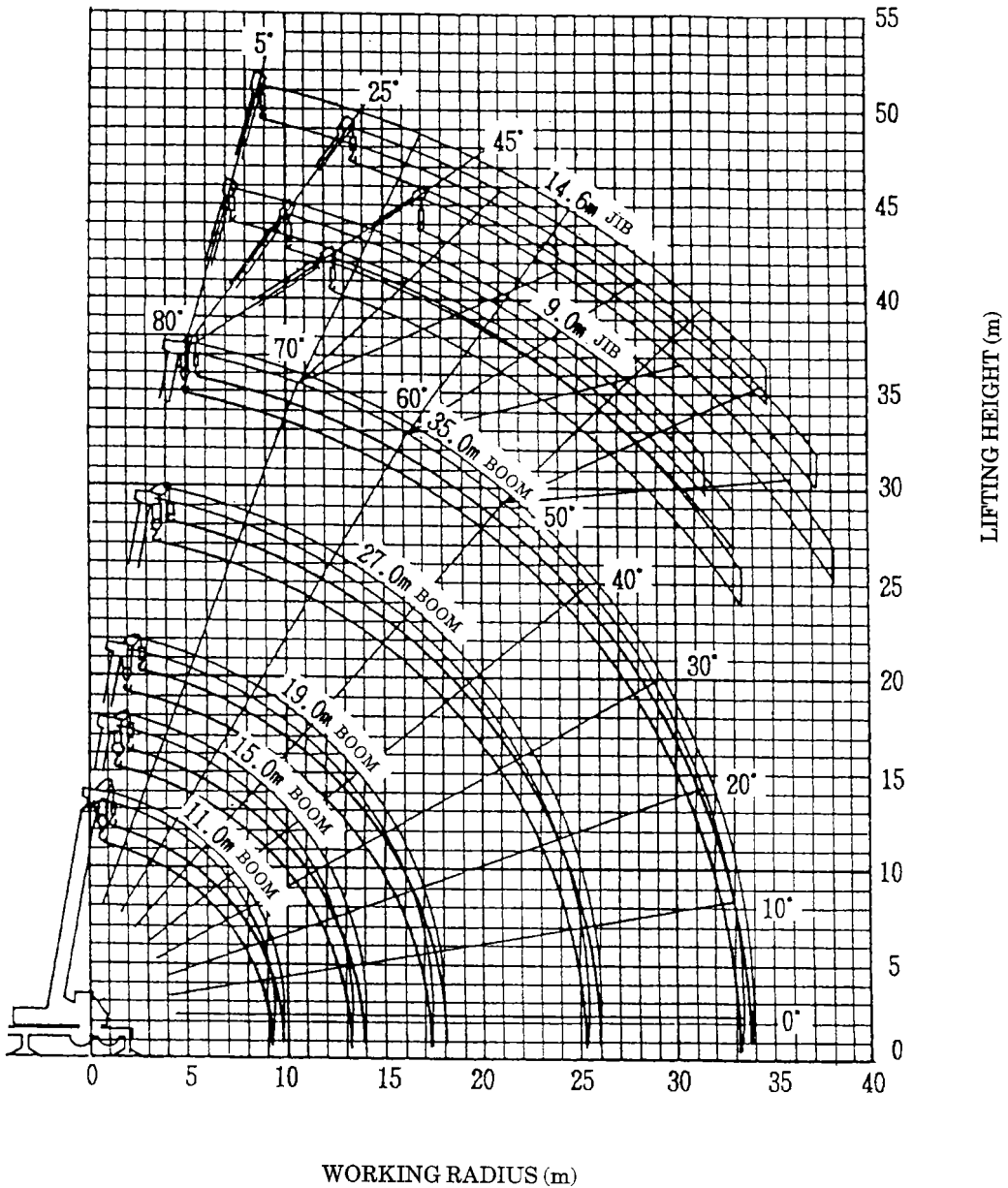

NOTES:

1. The deflection of the boom is not incorporated in the figure above.
2. The figure above is for the case when the outriggers are fully extended and where the front jack are used (over 360°).

DIMENSIONS (1/100)

W-KG520TN

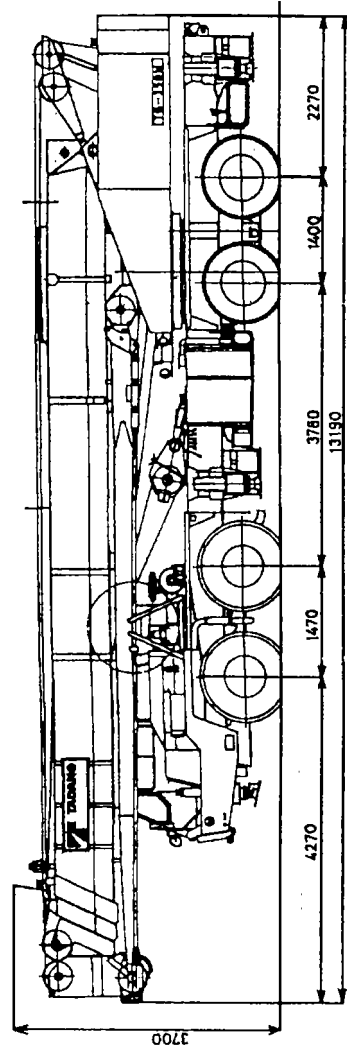
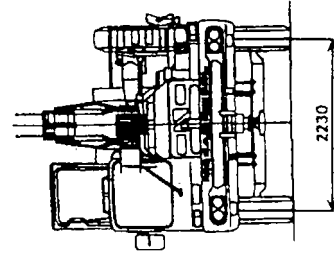
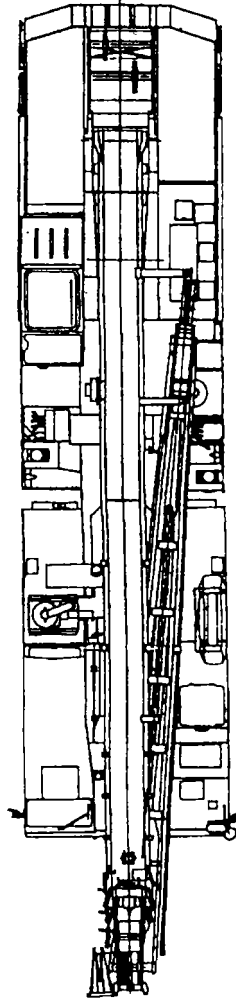
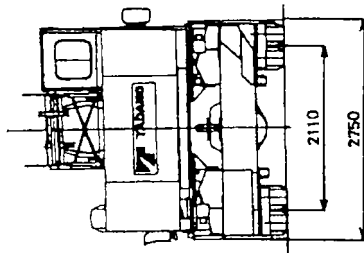

DIMENSIONS (1/100)

W-KS506S

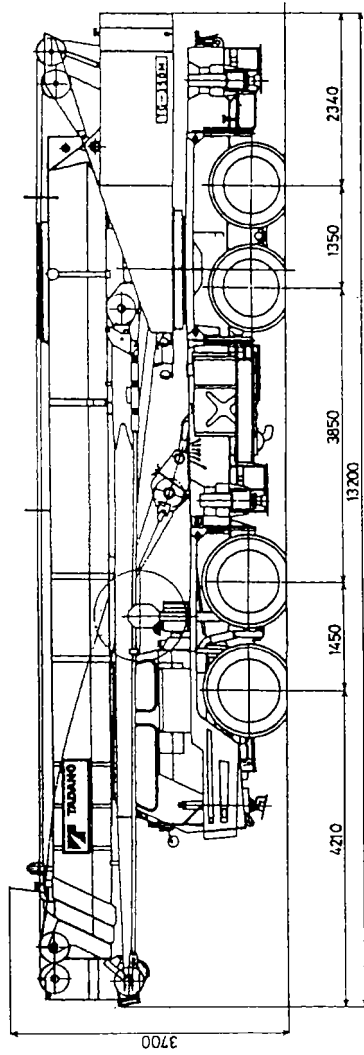
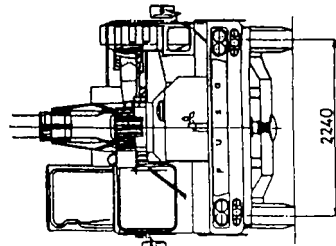
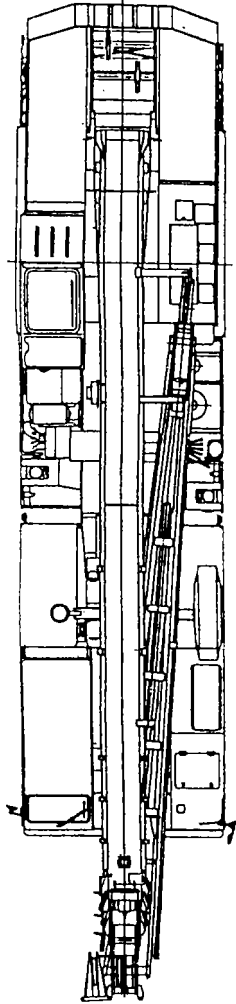
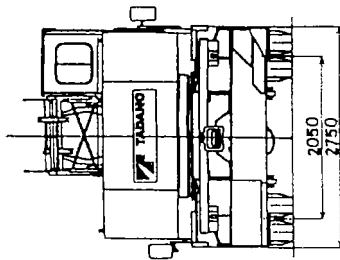

◆ MEMO ◆

A series of horizontal dashed lines for writing.