

Reversible Ratcheting Wrench

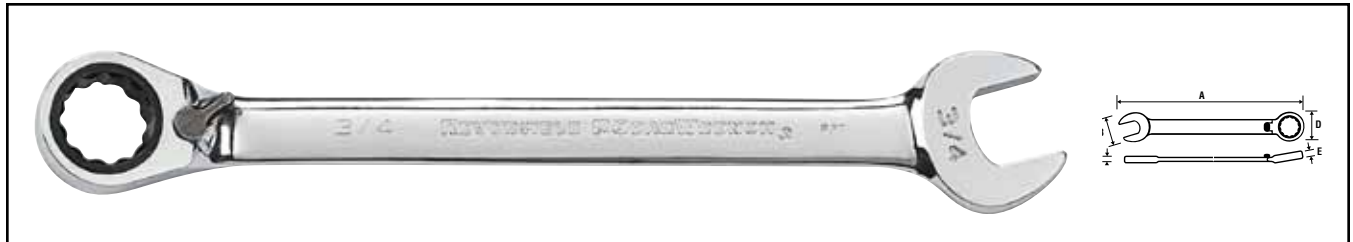

Open Stock - Combination Ratcheting Wrench SAE/METRIC

Item No.	Opening Inches/Metric	Overall Length (inch) A	Width Open End (inch) B	Thickness Open End (inch) C	Width Box End (inch) D	Thickness Box End (inch) E	Weight (lbs)
9525	5/16"	5.433	0.768	0.197	0.665	0.272	0.08
9521	11/32"	5.795	0.768	0.213	0.701	0.272	0.901
9526	3/8"	6.169	0.862	0.224	0.780	0.303	0.137
9527	7/16"	6.413	0.953	0.252	0.854	0.323	0.156
9528	1/2"	6.902	1.146	0.319	0.984	0.339	0.207
9529	9/16"	7.398	1.228	0.327	1.035	0.370	0.242
9530	5/8"	8.087	1.358	0.346	1.201	0.406	0.344
9531	11/16"	8.740	1.492	0.362	1.272	0.421	0.399
9532	3/4"	9.594	1.626	0.374	1.339	0.441	0.536
9534	13/16"	11.476	1.811	0.390	1.535	0.512	0.785
9538	7/8"	11.476	1.811	0.390	1.535	0.512	0.76
9539	15/16"	14.000	2.055	0.429	1.791	0.571	1.174
9540	1"	14.000	2.055	0.429	1.791	0.571	1.317
9608	8 mm	5.433	0.768	0.197	0.665	0.272	0.073
9609	9 mm	5.795	0.768	0.213	0.701	0.272	0.09
9610	10 mm	6.169	0.862	0.224	0.780	0.303	0.115
9611	11 mm	6.413	0.953	0.252	0.854	0.323	0.16
9612	12 mm	6.657	1.047	0.291	0.906	0.339	0.166
9613	13 mm	6.902	1.146	0.319	0.984	0.339	0.193
9614	14 mm	7.398	1.228	0.327	1.035	0.370	0.244
9615	15 mm	7.748	1.327	0.327	1.130	0.390	0.281
9616	16 mm	8.087	1.358	0.346	1.201	0.406	0.35
9617	17 mm	8.740	1.492	0.362	1.272	0.421	0.401
9618	18 mm	9.169	1.583	0.370	1.307	0.441	0.461
9619	19 mm	9.594	1.626	0.374	1.339	0.441	0.536
9621	21 mm	11.476	1.811	0.390	1.535	0.512	0.785
9622	22 mm	11.476	1.811	0.390	1.535	0.512	0.76
9624	24 mm	14.000	2.055	0.429	1.791	0.571	1.174
9625	25 mm	14.000	2.055	0.429	1.791	0.571	1.15

OPEN STOCK

WRENCHES

XL Locking Flex Ratcheting Wrench

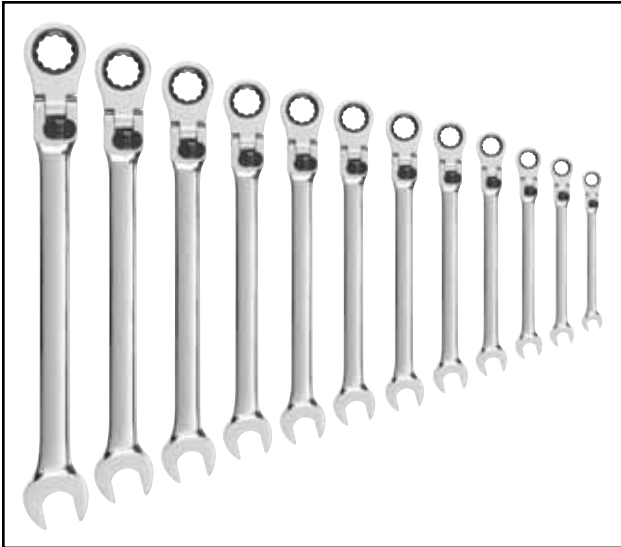

85698 - 12 Pc. XL Locking Flex Combination Ratcheting Wrench Set METRIC

Item No.	Description
85608	8 mm XL Locking Flex Combination Ratcheting Wrench
85609	9 mm XL Locking Flex Combination Ratcheting Wrench
85610	10 mm XL Locking Flex Combination Ratcheting Wrench
85611	11 mm XL Locking Flex Combination Ratcheting Wrench
85612	12 mm XL Locking Flex Combination Ratcheting Wrench
85613	13 mm XL Locking Flex Combination Ratcheting Wrench
85614	14 mm XL Locking Flex Combination Ratcheting Wrench
85615	15 mm XL Locking Flex Combination Ratcheting Wrench
85616	16 mm XL Locking Flex Combination Ratcheting Wrench
85617	17 mm XL Locking Flex Combination Ratcheting Wrench
85618	18 mm XL Locking Flex Combination Ratcheting Wrench
85619	19 mm XL Locking Flex Combination Ratcheting Wrench



85698R - 12 Pc. XL Locking Flex Combination Ratcheting Wrench Set Roll METRIC



85798 - 8 Pc. XL Locking Flex Combination Ratcheting Wrench Set SAE

Item No.	Description
85710	5/16" XL Locking Flex Combination Ratcheting Wrench
85712	3/8" XL Locking Flex Combination Ratcheting Wrench
85714	7/16" XL Locking Flex Combination Ratcheting Wrench
85716	1/2" XL Locking Flex Combination Ratcheting Wrench
85718	9/16" XL Locking Flex Combination Ratcheting Wrench
85720	5/8" XL Locking Flex Combination Ratcheting Wrench
85722	11/16" XL Locking Flex Combination Ratcheting Wrench
85724	3/4" XL Locking Flex Combination Ratcheting Wrench



85798 - 8 Pc. XL Locking Flex Combination Ratcheting Wrench Set Roll SAE

SETS

WRENCHES

PATENTED

XL Locking Flex Ratcheting Wrench



Open Stock - XL Locking Flex Combination Ratcheting Wrench SAE/METRIC

Item No.	Opening Inches/Metric	Overall Length (inch) A	Width Open End (inch) B	Thickness Open End (inch) C	Width Box End (inch) D	Thickness Box End (inch) E	Weight (lbs)
85710	5/16"	5.750	0.770	0.980	0.670	0.270	0.090
85712	3/8"	6.730	0.860	1.040	0.780	0.300	0.150
85714	7/16"	7.200	0.950	0.250	0.850	0.320	0.180
85716	1/2"	8.150	1.150	0.320	0.980	0.340	0.260
85718	9/16"	8.620	1.230	0.670	1.040	0.370	0.320
85720	5/8"	9.530	1.360	0.700	1.200	0.410	0.440
85722	11/16"	10.00	1.490	0.780	1.270	0.420	0.500
85724	3/4"	11.020	1.630	0.850	1.340	0.440	0.660
85608	8 mm	5.750	0.770	0.200	0.670	0.270	0.090
85609	9 mm	6.260	0.770	0.210	0.700	0.270	0.110
85610	10 mm	6.730	0.860	0.220	0.780	0.300	0.150
85611	11 mm	7.200	0.950	0.250	0.850	0.320	0.180
85612	12 mm	7.680	1.050	0.290	0.910	0.340	0.220
85613	13 mm	8.150	1.150	0.320	0.980	0.340	0.260
85614	14 mm	8.620	1.230	0.330	1.040	0.370	0.320
85615	15 mm	9.090	1.330	0.330	1.130	0.390	0.360
85616	16 mm	9.530	1.360	0.350	1.200	0.410	0.440
85617	17 mm	10.00	1.490	0.360	1.270	0.420	0.500
85618	18 mm	10.510	1.580	0.370	1.310	0.440	0.560
85619	19 mm	11.020	1.630	0.370	1.340	0.440	0.660

OPEN STOCK
WRENCHES

XL Locking Flex Ratcheting Wrench



9902 - 16 Pc. Flex Combination Ratcheting Wrench Set METRIC

Item No.	Description	
9908	8 mm	Flex Combination Ratcheting Wrench
9909	9 mm	Flex Combination Ratcheting Wrench
9910	10 mm	Flex Combination Ratcheting Wrench
9911	11 mm	Flex Combination Ratcheting Wrench
9912	12 mm	Flex Combination Ratcheting Wrench
9913	13 mm	Flex Combination Ratcheting Wrench
9914	14 mm	Flex Combination Ratcheting Wrench
9915	15 mm	Flex Combination Ratcheting Wrench
9916	16 mm	Flex Combination Ratcheting Wrench
9917	17 mm	Flex Combination Ratcheting Wrench
9918	18 mm	Flex Combination Ratcheting Wrench
9919	19 mm	Flex Combination Ratcheting Wrench
9921	21 mm	Flex Combination Ratcheting Wrench
9922	22 mm	Flex Combination Ratcheting Wrench
9924	24 mm	Flex Combination Ratcheting Wrench
9925	25 mm	Flex Combination Ratcheting Wrench



9702 - 13 Pc. Flex Combination Ratcheting Wrench Set SAE

Item No.	Description	
9705	5/16"	Flex Combination Ratcheting Wrench
9704	11/32"	Flex Combination Ratcheting Wrench
9706	3/8"	Flex Combination Ratcheting Wrench
9707	7/16"	Flex Combination Ratcheting Wrench
9708	1/2"	Flex Combination Ratcheting Wrench
9709	9/16"	Flex Combination Ratcheting Wrench
9710	5/8"	Flex Combination Ratcheting Wrench
9711	11/16"	Flex Combination Ratcheting Wrench
9712	3/4"	Flex Combination Ratcheting Wrench
9713	13/16"	Flex Combination Ratcheting Wrench
9714	7/8"	Flex Combination Ratcheting Wrench
9715	15/16"	Flex Combination Ratcheting Wrench
9716	1"	Flex Combination Ratcheting Wrench

SETS
WRENCHES

Flex Ratcheting Wrench

9901 - 12 Pc. Flex Combination Ratcheting Wrench Set METRIC

Item No.	Description	
9908	8 mm	Flex Combination Ratcheting Wrench
9909	9 mm	Flex Combination Ratcheting Wrench
9910	10 mm	Flex Combination Ratcheting Wrench
9911	11 mm	Flex Combination Ratcheting Wrench
9912	12 mm	Flex Combination Ratcheting Wrench
9913	13 mm	Flex Combination Ratcheting Wrench
9914	14 mm	Flex Combination Ratcheting Wrench
9915	15 mm	Flex Combination Ratcheting Wrench
9916	16 mm	Flex Combination Ratcheting Wrench
9917	17 mm	Flex Combination Ratcheting Wrench
9918	18 mm	Flex Combination Ratcheting Wrench
9919	19 mm	Flex Combination Ratcheting Wrench



9701 - 8 Pc. Flex Combination Ratcheting Wrench Set SAE

Item No.	Description	
9705	5/16"	Flex Combination Ratcheting Wrench
9706	3/8"	Flex Combination Ratcheting Wrench
9707	7/16"	Flex Combination Ratcheting Wrench
9708	1/2"	Flex Combination Ratcheting Wrench
9709	9/16"	Flex Combination Ratcheting Wrench
9710	5/8"	Flex Combination Ratcheting Wrench
9711	11/16"	Flex Combination Ratcheting Wrench
9712	3/4"	Flex Combination Ratcheting Wrench



9700 - 7 Pc. Flex Combination Ratcheting Wrench Set SAE

Item No.	Description	
9706	3/8"	Flex Combination Ratcheting Wrench
9707	7/16"	Flex Combination Ratcheting Wrench
9708	1/2"	Flex Combination Ratcheting Wrench
9709	9/16"	Flex Combination Ratcheting Wrench
9710	5/8"	Flex Combination Ratcheting Wrench
9711	11/16"	Flex Combination Ratcheting Wrench
9712	3/4"	Flex Combination Ratcheting Wrench



SETS
WRENCHES

Flex Ratcheting Wrench



9900 - 7 Pc. Flex Combination Ratcheting Wrench Set METRIC

Item No.	Description	
9910	10 mm	Flex Combination Ratcheting Wrench
9912	12 mm	Flex Combination Ratcheting Wrench
9913	13 mm	Flex Combination Ratcheting Wrench
9914	14 mm	Flex Combination Ratcheting Wrench
9915	15 mm	Flex Combination Ratcheting Wrench
9917	17 mm	Flex Combination Ratcheting Wrench
9919	19 mm	Flex Combination Ratcheting Wrench



9703 - 4 Pc. Flex Combination Ratcheting Wrench Completer Set SAE

Item No.	Description	
9713	13/16"	Flex Combination Ratcheting Wrench
9714	7/8"	Flex Combination Ratcheting Wrench
9715	15/16"	Flex Combination Ratcheting Wrench
9716	1"	Flex Combination Ratcheting Wrench



9903 - 4 Pc. Flex Combination Ratcheting Wrench Completer Set METRIC

Item No.	Description	
9921	21 mm	Flex Combination Ratcheting Wrench
9922	22 mm	Flex Combination Ratcheting Wrench
9924	24 mm	Flex Combination Ratcheting Wrench
9925	25 mm	Flex Combination Ratcheting Wrench

PATENTED

SETS
WRENCHES

Flex Ratcheting Wrench



Open Stock - Flex Combination Ratcheting Wrench SAE/METRIC

Item No.	Opening Inches/Metric	Overall Length (inch) A	Width Open End (inch) B	Thickness Open End (inch) C	Width Box End (inch) D	Thickness Box End (inch) E	Weight (lbs)
9704	11/32"	5.882	0.768	0.213	0.701	0.272	0.11
9705	5/16"	5.508	0.768	0.197	0.665	0.272	0.087
9706	3/8"	6.252	0.862	0.224	0.780	0.303	0.138
9707	7/16"	6.504	0.953	0.252	0.854	0.323	0.168
9708	1/2"	7.004	1.146	0.319	0.984	0.339	0.238
9709	9/16"	7.504	1.228	0.327	1.035	0.370	0.282
9710	5/8"	8.197	1.358	0.346	1.201	0.406	0.383
9711	11/16"	8.878	1.492	0.362	1.272	0.421	0.448
9712	3/4"	9.764	1.626	0.374	1.339	0.441	0.588
9713	13/16"	11.476	1.811	0.390	1.535	0.512	0.9
9714	7/8"	11.476	1.811	0.390	1.535	0.512	0.864
9715	15/16"	13.114	2.055	0.429	1.791	0.571	1.316
9716	1"	13.114	2.055	0.429	1.791	0.571	1.292
9908	8 mm	5.508	0.768	0.197	0.665	0.272	0.086
9909	9 mm	5.882	0.768	0.213	0.701	0.272	0.103
9910	10 mm	6.252	0.862	0.224	0.780	0.303	0.138
9911	11 mm	6.504	0.953	0.252	0.854	0.323	0.162
9912	12 mm	6.756	1.047	0.291	0.906	0.339	0.197
9913	13 mm	7.004	1.146	0.319	0.984	0.339	0.238
9914	14 mm	7.504	1.228	0.327	1.035	0.370	0.279
9915	15 mm	7.854	1.327	0.327	1.130	0.390	0.334
9916	16 mm	8.197	1.358	0.346	1.201	0.406	0.383
9917	17 mm	8.878	1.492	0.362	1.272	0.421	0.451
9918	18 mm	9.315	1.583	0.370	1.307	0.441	0.517
9919	19 mm	9.764	1.626	0.374	1.339	0.441	0.59
9921	21 mm	11.476	1.811	0.390	1.535	0.512	0.886
9922	22 mm	11.476	1.811	0.390	1.535	0.512	0.868
9924	24 mm	13.114	2.055	0.429	1.791	0.571	1.31
9925	25 mm	14.000	2.055	0.429	1.791	0.571	1.15

OPEN STOCK

WRENCHES

Stubby Flex *Ratcheting Wrench*



9550 - 10 Pc. Stubby Flex Combination Ratcheting Wrench Set *METRIC*

Item No.	Description	
9551	10 mm	Stubby Flex Combination Ratcheting Wrench
9552	11 mm	Stubby Flex Combination Ratcheting Wrench
9553	12 mm	Stubby Flex Combination Ratcheting Wrench
9554	13 mm	Stubby Flex Combination Ratcheting Wrench
9555	14 mm	Stubby Flex Combination Ratcheting Wrench
9556	15 mm	Stubby Flex Combination Ratcheting Wrench
9557	16 mm	Stubby Flex Combination Ratcheting Wrench
9558	17 mm	Stubby Flex Combination Ratcheting Wrench
9559	18 mm	Stubby Flex Combination Ratcheting Wrench
9560	19 mm	Stubby Flex Combination Ratcheting Wrench

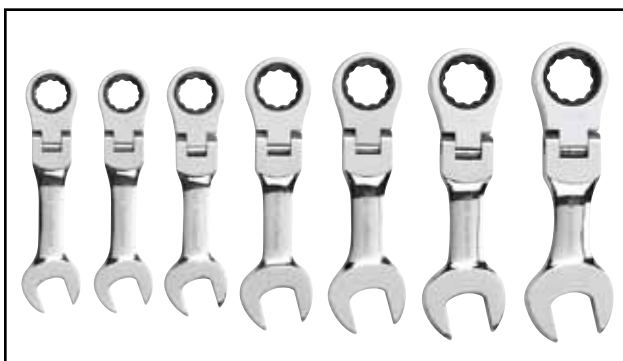

9570 - 7 Pc. Stubby Flex Combination Ratcheting Wrench Set *SAE*

Item No.	Description	
9571	3/8"	Stubby Flex Combination Ratcheting Wrench
9572	7/16"	Stubby Flex Combination Ratcheting Wrench
9573	1/2"	Stubby Flex Combination Ratcheting Wrench
9574	9/16"	Stubby Flex Combination Ratcheting Wrench
9575	5/8"	Stubby Flex Combination Ratcheting Wrench
9576	11/16"	Stubby Flex Combination Ratcheting Wrench
9577	3/4"	Stubby Flex Combination Ratcheting Wrench

SETS
WRENCHES

Stubby Flex Ratcheting Wrench

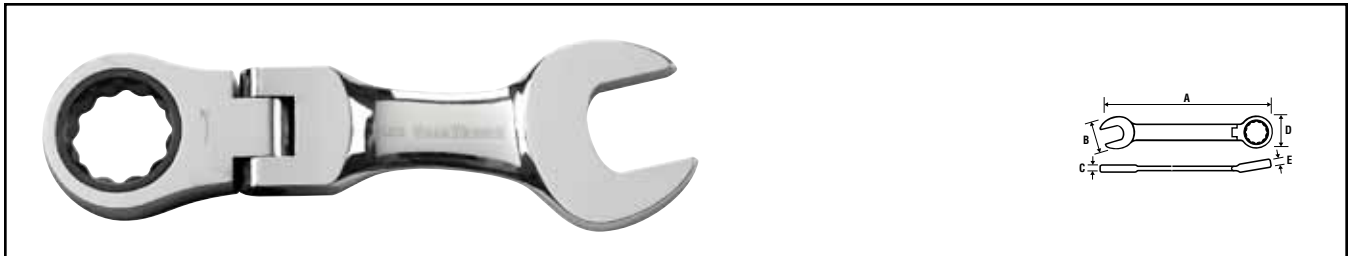

Open Stock - Stubby Flex Combination Ratcheting Wrench SAE

Item No.	Opening Inches/Metric	Overall Length (inch) A	Width Open End (inch) B	Thickness Open End (inch) C	Width Box End (inch) D	Thickness Box End (inch) E	Weight (lbs)
9571	3/8"	3.701	0.862	0.224	0.780	0.303	0.101
9572	7/16"	4.016	0.953	0.252	0.854	0.323	0.121
9573	1/2"	4.213	1.146	0.319	0.984	0.339	0.167
9574	9/16"	4.488	1.228	0.327	1.035	0.370	0.203
9575	5/8"	4.803	1.358	0.346	1.201	0.406	0.268
9576	11/16"	4.961	1.492	0.362	1.272	0.421	0.308
9577	3/4"	5.433	1.626	0.374	1.339	0.441	0.41
9551	10 mm	3.701	0.862	0.224	0.780	0.303	0.102
9552	11 mm	4.016	0.953	0.252	0.854	0.323	0.12
9553	12 mm	4.134	1.047	0.291	0.906	0.339	0.144
9554	13 mm	4.213	1.146	0.319	0.984	0.339	0.167
9555	14 mm	4.488	1.228	0.327	1.035	0.370	0.202
9556	15 mm	4.646	1.327	0.327	1.130	0.390	0.232
9557	16 mm	4.803	1.358	0.346	1.201	0.406	0.268
9558	17 mm	4.961	1.492	0.362	1.272	0.421	0.314
9559	18 mm	5.118	1.583	0.370	1.307	0.441	0.361
9560	19 mm	5.433	1.626	0.374	1.339	0.441	0.408

OPEN STOCK

WRENCHES

XL GearBox™ Ratcheting Wrenches



85988 - 12 Pc. XL GearBox™ Double Box Ratcheting Wrench Set METRIC

Item No.	Description	
85908	8 mm	XL GearBox™ Double Box Ratcheting Wrench
85909	9 mm	XL GearBox™ Double Box Ratcheting Wrench
85910	10 mm	XL GearBox™ Double Box Ratcheting Wrench
85911	11 mm	XL GearBox™ Double Box Ratcheting Wrench
85912	12 mm	XL GearBox™ Double Box Ratcheting Wrench
85913	13 mm	XL GearBox™ Double Box Ratcheting Wrench
85914	14 mm	XL GearBox™ Double Box Ratcheting Wrench
85915	15 mm	XL GearBox™ Double Box Ratcheting Wrench
85916	16 mm	XL GearBox™ Double Box Ratcheting Wrench

85917	17 mm	XL GearBox™ Double Box Ratcheting Wrench
85918	18 mm	XL GearBox™ Double Box Ratcheting Wrench
85919	19 mm	XL GearBox™ Double Box Ratcheting Wrench



85989 - 17 Pc. XL GearBox™ Double Box Ratcheting Wrench Set METRIC

Item No.	Description	
85908	8 mm	XL GearBox™ Ratcheting Wrench
85909	9 mm	XL GearBox™ Ratcheting Wrench
85910	10 mm	XL GearBox™ Ratcheting Wrench
85911	11 mm	XL GearBox™ Ratcheting Wrench
85912	12 mm	XL GearBox™ Ratcheting Wrench
85913	13 mm	XL GearBox™ Ratcheting Wrench
85914	14 mm	XL GearBox™ Ratcheting Wrench
85915	15 mm	XL GearBox™ Ratcheting Wrench
85916	16 mm	XL GearBox™ Ratcheting Wrench
85917	17 mm	XL GearBox™ Ratcheting Wrench
85918	18 mm	XL GearBox™ Ratcheting Wrench
85919	19 mm	XL GearBox™ Ratcheting Wrench

MASTER SET

85920	20 mm	XL GearBox™ Ratcheting Wrench
85921	21 mm	XL GearBox™ Ratcheting Wrench
85922	22 mm	XL GearBox™ Ratcheting Wrench
85924	24 mm	XL GearBox™ Ratcheting Wrench
85925	25 mm	XL GearBox™ Ratcheting Wrench



85987 - 5 Pc. XL GearBox™ Double Box Ratcheting Wrench Add-On Set METRIC

Item No.	Description	
85920	20 mm	XL GearBox™ Ratcheting Wrench
85921	21 mm	XL GearBox™ Ratcheting Wrench
85922	22 mm	XL GearBox™ Ratcheting Wrench
85924	24 mm	XL GearBox™ Ratcheting Wrench
85925	25 mm	XL GearBox™ Ratcheting Wrench

ADD-ON SET (Complement to 85988)

XL GearBox™ Ratcheting Wrenches

85999 - 13 Pc. XL GearBox™ Double Box Ratcheting Wrench Set SAE

Item No.	Description	
85950	5/16"	XL GearBox™ Ratcheting Wrench
85951	11/32"	XL GearBox™ Ratcheting Wrench
85952	3/8"	XL GearBox™ Ratcheting Wrench
85954	7/16"	XL GearBox™ Ratcheting Wrench
85956	1/2"	XL GearBox™ Ratcheting Wrench
85958	9/16"	XL GearBox™ Ratcheting Wrench
85960	5/8"	XL GearBox™ Ratcheting Wrench
85962	11/16"	XL GearBox™ Ratcheting Wrench
85964	3/4"	XL GearBox™ Ratcheting Wrench
85966	13/16"	XL GearBox™ Ratcheting Wrench
85968	7/8"	XL GearBox™ Ratcheting Wrench
85970	15/16"	XL GearBox™ Ratcheting Wrench
85972	1"	XL GearBox™ Ratcheting Wrench



MASTER SET

85998 - 9 Pc. XL GearBox™ Double Box Ratcheting Wrench Set SAE

Item No.	Description	
85950	5/16"	XL GearBox™ Double Box Ratcheting Wrench
85951	11/32"	XL GearBox™ Double Box Ratcheting Wrench
85952	3/8"	XL GearBox™ Double Box Ratcheting Wrench
85954	7/16"	XL GearBox™ Double Box Ratcheting Wrench
85956	1/2"	XL GearBox™ Double Box Ratcheting Wrench
85958	9/16"	XL GearBox™ Double Box Ratcheting Wrench
85960	5/8"	XL GearBox™ Double Box Ratcheting Wrench
85962	11/16"	XL GearBox™ Double Box Ratcheting Wrench
85964	3/4"	XL GearBox™ Double Box Ratcheting Wrench



85996 - 4 Pc. XL GearBox™ Double Box Ratcheting Wrench Add-On Set SAE

Item No.	Description	
85966	13/16"	XL GearBox™ Ratcheting Wrench
85968	7/8"	XL GearBox™ Ratcheting Wrench
85970	15/16"	XL GearBox™ Ratcheting Wrench
85972	1"	XL GearBox™ Ratcheting Wrench



ADD-ON SET (Complement to 85998)

SETS

WRENCHES

XL GearBox™ Ratcheting Wrenches



Open Stock - XL GearBox™ Double Box Ratcheting Wrench SAE/METRIC

Item No.	Opening Inches/Metric	Overall Length (inch) A	Width Box End (inch) B	Thickness Box End (inch) C	Width Box End (inch) D	Thickness Box End (inch) E	Weight (lbs)
85950	5/16"	8.71	0.67	0.27	0.46	0.24	0.121
85951	11/32"	8.91	0.7	0.27	0.52	0.26	0.125
85952	3/8"	9.5	0.78	0.3	0.57	0.27	0.167
85954	7/16"	9.89	0.85	0.32	0.62	0.31	0.196
85956	1/2"	11.31	0.98	0.34	0.74	0.35	0.260
85958	9/16"	12.02	1.04	0.37	0.8	0.39	0.378
85960	5/8"	13.71	1.2	0.41	0.9	0.43	0.497
85962	11/16"	14.7	1.27	0.42	0.94	0.43	0.667
85964	3/4"	15.6	1.34	0.44	1.04	0.47	0.768
85966	13/16"	16.54	1.54	0.51	1.18	0.57	1.415
85968	7/8"	17.01	1.54	0.51	1.22	0.57	2.062
85970	15/16"	18.03	1.75	0.57	1.34	0.59	2.709
85972	1"	18.5	1.75	0.57	1.42	0.59	3.356
85908	8 mm	8.71	0.67	0.27	0.46	0.24	0.121
85909	9 mm	8.91	0.7	0.27	0.52	0.26	0.125
85910	10 mm	9.5	0.78	0.3	0.57	0.27	0.167
85911	11 mm	9.89	0.85	0.32	0.62	0.31	0.196
85912	12 mm	10.52	0.91	0.34	0.68	0.33	0.260
85913	13 mm	11.31	0.98	0.34	0.74	0.35	0.330
85914	14 mm	12.02	1.04	0.37	0.8	0.39	0.378
85915	15 mm	12.72	1.13	0.39	0.86	0.43	0.462
85916	16 mm	13.71	1.2	0.41	0.9	0.43	0.497
85917	17 mm	14.7	1.27	0.42	0.94	0.43	0.667
85918	18 mm	15.13	1.31	0.44	0.98	0.45	0.691
85919	19 mm	15.6	1.34	0.44	1.04	0.47	0.768
85920	20 mm	15.98	1.54	0.51	1.14	0.52	1.415
85921	21 mm	16.54	1.54	0.51	1.18	0.57	2.062
85922	22 mm	17.01	1.54	0.51	1.22	0.57	2.709
85924	24 mm	18.03	1.75	0.57	1.34	0.59	3.356
85925	25 mm	18.5	1.75	0.57	1.42	0.59	4.003

PATENTED

OPEN STOCK

WRENCHES

XL Spline Ratcheting Wrenches

85598 - 9 Pc. XL Spline Combination Ratcheting Wrench Set SAE

Item No.	Description
85548	#8 x 1/4" XL Spline Combination Ratcheting Wrench
85550	#10 x 5/16" XL Spline Combination Ratcheting Wrench
85552	#12 x 3/8" XL Spline Combination Ratcheting Wrench
85554	#14 x 7/16" XL Spline Combination Ratcheting Wrench
85556	#16 x 1/2" XL Spline Combination Ratcheting Wrench
85558	#18 x 9/16" XL Spline Combination Ratcheting Wrench
85560	#20 x 5/8" XL Spline Combination Ratcheting Wrench
85562	#22 x 11/16" XL Spline Combination Ratcheting Wrench
85564	#24 x 3/4" XL Spline Combination Ratcheting Wrench



Open Stock - XL Spline Combination Ratcheting Wrench SAE

Item No.	Opening Inches	Overall Length (inch) A	Width Open End (inch) B	Thickness Open End (inch) C	Width Box End (inch) D	Thickness Box End (inch) E	Weight (lbs)
85548	#8 x 1/4"	5.315	0.610	0.256	0.567	0.181	0.121
85550	#10 x 5/16"	5.906	0.665	0.272	0.768	0.197	0.196
85552	#12 x 3/8"	7.087	0.780	0.303	0.862	0.224	0.227
85554	#14 x 7/16"	7.677	0.854	0.323	0.953	0.252	0.296
85556	#16 x 1/2"	8.661	0.984	0.339	1.146	0.319	0.347
85558	#18 x 9/16"	9.252	1.035	0.370	1.228	0.327	0.385
85560	#20 x 5/8"	10.236	1.201	0.406	1.358	0.346	0.517
85562	#22 x 11/16"	10.827	1.272	0.421	1.492	0.362	0.577
85564	#24 x 3/4"	12.008	1.339	0.441	1.626	0.374	0.771

SETS

WRENCHES

Indexing Ratcheting Wrenches



85488 - 12 Pc. Indexing Combination Wrench Set METRIC

Item No.	Description	
85418	8 mm	Indexing Combination Wrench
85439	9 mm	Indexing Combination Wrench
85440	10 mm	Indexing Combination Wrench
85441	11 mm	Indexing Combination Wrench
85442	12 mm	Indexing Combination Wrench
85443	13 mm	Indexing Combination Wrench
85444	14 mm	Indexing Combination Wrench
85445	15 mm	Indexing Combination Wrench
85446	16 mm	Indexing Combination Wrench
85447	17 mm	Indexing Combination Wrench
85448	18 mm	Indexing Combination Wrench
85449	19 mm	Indexing Combination Wrench



85498 - 8 Pc. Indexing Combination Wrench Set SAE

Item No.	Description	
85450	5/16"	Indexing Combination Wrench
85452	3/8"	Indexing Combination Wrench
85454	7/16"	Indexing Combination Wrench
85456	1/2"	Indexing Combination Wrench
85458	9/16"	Indexing Combination Wrench
85460	5/8"	Indexing Combination Wrench
85462	11/16"	Indexing Combination Wrench
85464	3/4"	Indexing Combination Wrench

SETS
WRENCHES

Indexing Ratcheting Wrenches

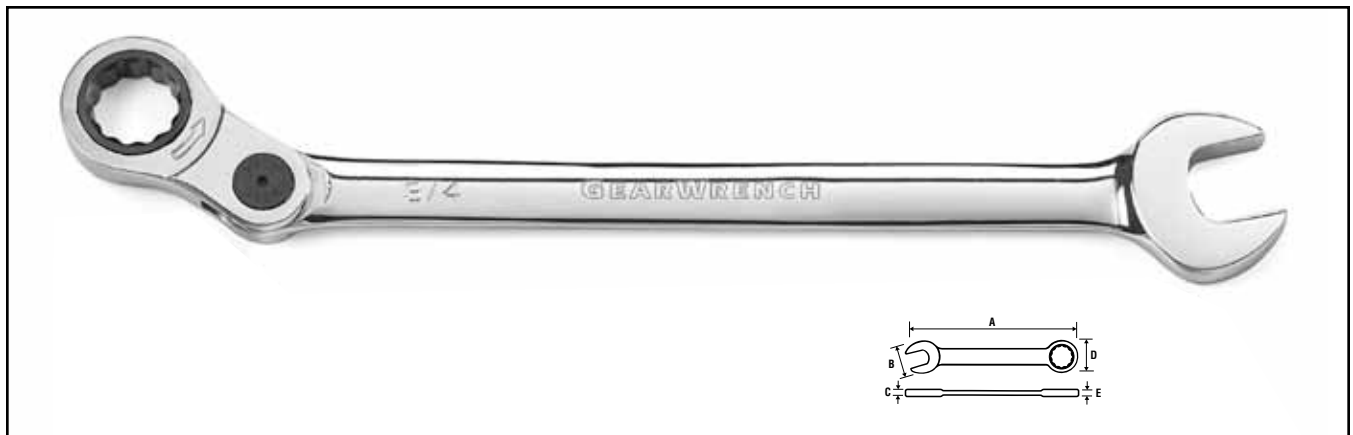

Open Stock - Indexing Combination Wrenches SAE/METRIC

Item No.	Opening Inches/Metric	Overall Length (inch) A	Width Open End (inch) B	Thickness Open End (inch) C	Width Box End (inch) D	Thickness Box End (inch) E	Weight (lbs)
85450	5/16"	4.949	0.709	0.197	0.535	0.127	0.046
85452	3/8"	5.909	0.906	0.220	0.574	0.127	0.062
85454	7/16"	6.417	0.984	0.240	0.618	0.127	0.071
85456	1/2"	7.217	1.102	0.303	0.685	0.171	0.093
85458	9/16"	7.665	1.260	0.307	0.728	0.171	0.121
85460	5/8"	8.508	1.378	0.346	0.813	0.197	0.143
85462	11/16"	9.016	1.496	0.370	0.844	0.197	0.196
85464	3/4"	10.122	1.654	0.386	0.883	0.197	0.273
85418	8 mm	4.949	0.709	0.197	0.535	0.127	0.064
85439	9 mm	5.394	0.787	0.209	0.543	0.127	0.090
85440	10 mm	5.909	0.906	0.220	0.574	0.127	0.123
85441	11 mm	6.417	0.984	0.240	0.618	0.127	0.141
85442	12 mm	6.783	1.063	0.260	0.660	0.171	0.176
85443	13 mm	7.217	1.102	0.303	0.685	0.171	0.185
85444	14 mm	7.665	1.260	0.307	0.728	0.171	0.236
85445	15 mm	8.185	1.299	0.315	0.766	0.171	0.287
85446	16 mm	8.508	1.378	0.346	0.813	0.197	0.340
85447	17 mm	9.016	1.496	0.370	0.844	0.197	0.414
85448	18 mm	9.555	1.535	0.370	0.851	0.197	0.428
85449	19 mm	10.122	1.654	0.386	0.883	0.197	0.708

OPEN STOCK

WRENCHES

Open End *Ratcheting* Wrenches



85597 - 12 Pc. Open End Ratcheting Set METRIC

Item No.	Description	
85508	8 mm	Ratcheting Open End Wrench
85509	9 mm	Ratcheting Open End Wrench
85510	10 mm	Ratcheting Open End Wrench
85511	11 mm	Ratcheting Open End Wrench
85512	12 mm	Ratcheting Open End Wrench
85513	13 mm	Ratcheting Open End Wrench
85514	14 mm	Ratcheting Open End Wrench
85515	15 mm	Ratcheting Open End Wrench
85516	16 mm	Ratcheting Open End Wrench
85517	17 mm	Ratcheting Open End Wrench
85518	18 mm	Ratcheting Open End Wrench
85519	19 mm	Ratcheting Open End Wrench



85599 - 8 Pc. Open End Ratcheting Set SAE

Item No.	Description	
85570	5/16"	Ratcheting Open End Wrench
85572	3/8"	Ratcheting Open End Wrench
85574	7/16"	Ratcheting Open End Wrench
85576	1/2"	Ratcheting Open End Wrench
85578	9/16"	Ratcheting Open End Wrench
85580	5/8"	Ratcheting Open End Wrench
85582	11/16"	Ratcheting Open End Wrench
85584	3/4"	Ratcheting Open End Wrench

SETS
WRENCHES

Open End Ratcheting Wrenches



Open Stock - Open End Ratcheting Wrenches SAE/METRIC

Item No.	Opening Inches/Metric	Overall Length (inch) A	Width Open End (inch) B	Thickness Open End (inch) C	Width Box End (inch) D	Thickness Box End (inch) E	Weight (lbs)
85570	5/16"	5.508	0.658	0.197	0.625	0.256	0.046
85572	3/8"	6.256	0.822	0.220	0.750	0.287	0.062
85574	7/16"	6.508	0.905	0.240	0.811	0.303	0.071
85576	1/2"	7.008	1.069	0.303	0.930	0.339	0.093
85578	9/16"	7.504	1.152	0.307	1.020	0.354	0.121
85580	5/8"	8.201	1.316	0.346	1.130	0.390	0.143
85582	11/16"	8.878	1.399	0.370	1.201	0.406	0.196
85584	3/4"	9.764	1.563	0.386	1.278	0.441	0.273
85508	8 mm	5.508	0.658	0.197	0.625	0.256	0.064
85509	9 mm	5.882	0.741	0.209	0.689	0.272	0.090
85510	10 mm	6.256	0.822	0.220	0.750	0.287	0.123
85511	11 mm	6.508	0.905	0.240	0.811	0.303	0.141
85512	12 mm	6.756	0.988	0.260	0.855	0.323	0.176
85513	13 mm	7.008	1.069	0.303	0.930	0.339	0.185
85514	14 mm	7.504	1.152	0.307	1.020	0.354	0.236
85515	15 mm	7.854	1.233	0.315	1.070	0.370	0.287
85516	16 mm	8.201	1.316	0.346	1.130	0.390	0.340
85517	17 mm	8.878	1.399	0.370	1.201	0.406	0.414
85518	18 mm	9.315	1.480	0.370	1.239	0.421	0.428
85519	19 mm	9.764	1.563	0.386	1.278	0.441	0.708

OPEN STOCK
WRENCHES

QuadBox™ Ratcheting Wrenches



85200 - 13 Pc. QuadBox™ Double Box Ratcheting Wrench Set SAE

Item No.	Description
85201	5/16", 3/8", 7/16", 1/2" QuadBox™ Ratcheting Wrench
85202	9/16", 5/8", 11/16", 3/4" QuadBox™ Ratcheting Wrench
	1/4" Access Bit Adapter
#1	Phillips Bit 1/4"
#2	Phillips Bit 1/4"
#3	Phillips Bit 1/4"
5/32	Slotted Bit 1/4"
7/32	Slotted Bit 1/4"
1/4	Slotted Bit 1/4"
T-15	Torx® Bit 1/4"
T-20	Torx® Bit 1/4"
T-25	Torx® Bit 1/4"
T-27	Torx® Bit 1/4"

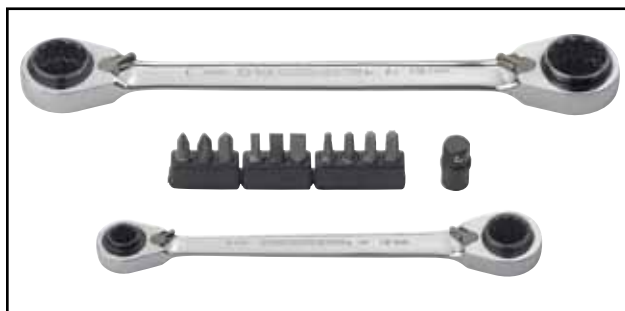

85210 - 13 Pc. QuadBox™ Double Box Ratcheting Wrench Set METRIC

Item No.	Description
85211	8, 10, 12, 13 mm QuadBox™ Ratcheting Wrench
85212	16, 17, 18, 19 mm QuadBox™ Ratcheting Wrench
	1/4" Access Bit Adapter
#1	Phillips Bit 1/4"
#2	Phillips Bit 1/4"
#3	Phillips Bit 1/4"
5/32	Slotted Bit 1/4"
7/32	Slotted Bit 1/4"
1/4	Slotted Bit 1/4"
T-15	Torx® Bit 1/4"
T-20	Torx® Bit 1/4"
T-25	Torx® Bit 1/4"
T-27	Torx® Bit 1/4"

SETS
WRENCHES

QuadBox™ Ratcheting Wrenches

85204 - 3 Pc. QuadBox™ Double Box Ratcheting Wrench Set SAE

Item No.	Description
85201	5/16", 3/8", 7/16", 1/2" QuadBox™ Ratcheting Wrench
85202	9/16", 5/8", 11/16", 3/4" QuadBox™ Ratcheting Wrench
85203	13/16", 7/8", 15/16", 1" QuadBox™ Ratcheting Wrench



85215 - 4 Pc. QuadBox™ Double Box Ratcheting Wrench Set METRIC

Item No.	Description
85211	8, 10, 12, 13 mm QuadBox™ Ratcheting Wrench
85212	16, 17, 18, 19 mm QuadBox™ Ratcheting Wrench
85213	9, 11, 14, 15 mm QuadBox™ Ratcheting Wrench
85214	20, 21, 22, 24 mm QuadBox™ Ratcheting Wrench

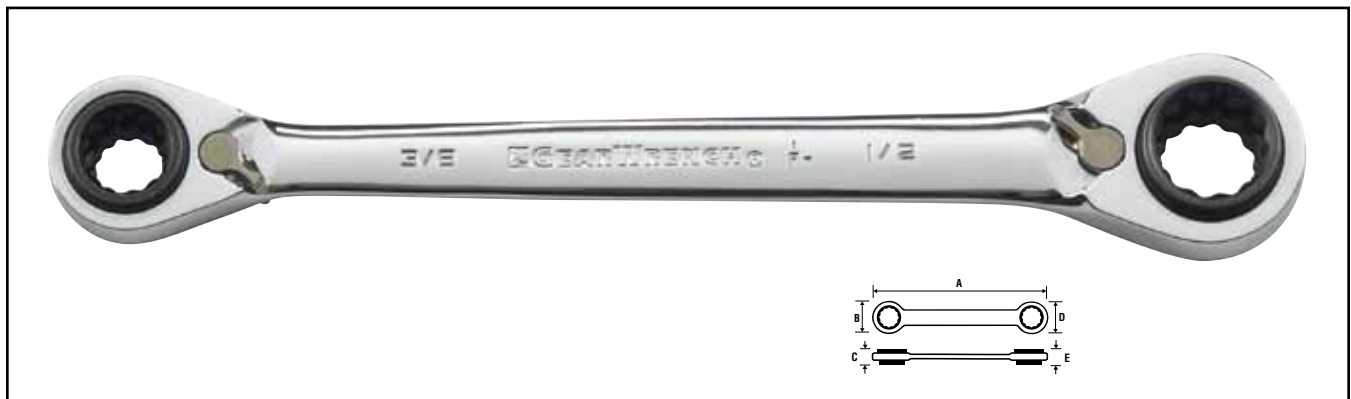

Open Stock - QuadBox™ Ratcheting Wrench SAE/METRIC

Item No.	Opening Inches/Metric	Overall Length (inch) A	Width Box End (inch) B	Thickness Box End (inch) C	Width Box End (inch) D	Thickness Box End (inch) E	Weight (lbs)
85201	5/16", 3/8", 7/16", 1/2"	6.3	0.78	0.47	0.98	0.59	0.185
85202	9/16", 5/8", 11/16", 3/4"	8.27	1.2	0.67	1.34	0.75	0.449
85203	13/16", 7/8", 15/16", 1"	11.42	1.54	0.91	1.79	1.1	1.10
85211	8, 10, 12, 13 mm	6.3	0.78	0.47	0.98	0.59	0.189
85212	16, 17, 18, 19 mm	9.06	1.27	0.71	1.34	0.79	0.491
85213	9, 11, 14, 15 mm	7.09	0.85	0.51	1.13	0.63	0.253
85214	20, 21, 22, 24 mm	11.42	1.54	0.91	1.79	1.1	1.056

SETS
WRENCHES

QuadBox™ Ratcheting Wrenches

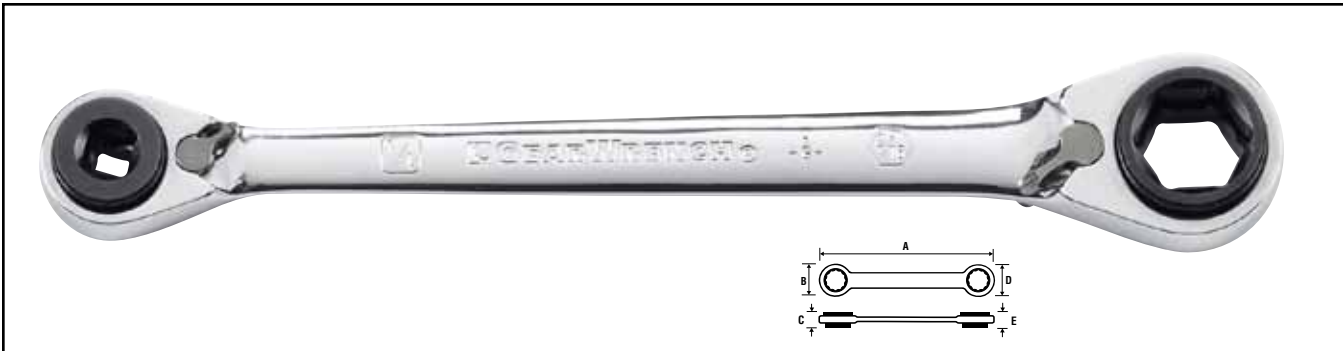

Open Stock - QuadBox™ HVAC Ratcheting Wrench SAE

Item No.	Opening Inches	Overall Length (inch) A	Width Box End (inch) B	Thickness Box End (inch) C	Width Box End (inch) D	Thickness Box End (inch) E	Weight (lbs)
85220	1/4" x 3/16" (Square) 3/8" x 5/16" (Square)	5.512	0.780	0.496	0.850	0.488	0.176
85221	1/4" x 3/16" (Square) 9/16" x 1/2" (Hex)	6.890	0.780	0.496	1.035	0.598	0.240



9260 - 6 Pc. Double Box Ratcheting Wrench Set METRIC

Item No.	Description
9210	8 X 9 mm Double Box Ratcheting Wrench
9211	10 X 11 mm Double Box Ratcheting Wrench
9212	12 X 13 mm Double Box Ratcheting Wrench
9213	14 X 15 mm Double Box Ratcheting Wrench
9214	16 X 18 mm Double Box Ratcheting Wrench
9215	17 X 19 mm Double Box Ratcheting Wrench



9240 - 4 Pc. Double Box Ratcheting Wrench Set SAE

Item No.	Description
9201	5/16" x 3/8" Double Box Ratcheting Wrench
9202	7/16" x 1/2" Double Box Ratcheting Wrench
9203	9/16" x 5/8" Double Box Ratcheting Wrench
9204	11/16" x 3/4" Double Box Ratcheting Wrench

PATENTED

OPEN STOCK
WRENCHES