

大大牌

RAYACO®

• TOGETHER, WE CLEAN BETTER •



**HARDLINE AND
HOUSEHOLD PLASTIC
PRODUCTS**

ABOUT US



Established in 1987, **RAYACO®** has become one of the leading household brand name in Malaysia. In addition, we also have VIP, VIP MEDPRO and RAYACO PRO brands. As a pioneer in the broom and brush, and household product supply industry in the country, we have come through changes and challenges, from the technology and exposure we acquired over the past three decades, to successfully establish ourselves as one of the leading names in the household products industry providing full range of cleaning products for household and industry needs under various brands name. Our range of products includes broom, brush, mop scouring pad with sponge, scouring pad, household sponge, household plastic product etc.

To pursue continuous advancement, at the year 2002, we expanded and moved into a modern factory in Rawang Integrated Park with total build up area of 210,000 square feet and equipped with new facilities and equipment to meet the increasing market demand as well as further strengthen our position in the household supplies industry. In 2016, to meet the increasing demand of the market for the foreseeable future, we acquired 2 pieces of land and factory, which almost double up our total build up area to 400,000 square feet. In addition, our newly build warehouse expected to be ready at the end of year 2019, this expanded production and warehousing capability will aid our growth strongly and organically at least for the next 5 years.

We believe in a clean and healthy environment for household as well as industrial premises, therefore, **RAYACO®** brand and our other brand of cleaning products ensures value for money purchase as well as comfort usage. Thus we come up with our own motto:

“TOGETHER, WE CLEAN BETTER”

To continue our excellent in cleaning industry and to tap and expand our expertise in plastic and metal technology, we are transforming ourselves into providing a full range of household product supplier.

We are committed to produce excellent quality, user friendly and reliable household products. Our innovation on product design and continuous improvement on product quality has guaranteed many satisfactions of our customers.

We are one of the few manufacturers who can supply full range of above products to our distributors as well as retailers which carry our own brand name. We also provide OEM services as well which include some worldwide brand name.

We believe that through our innovation in product design and continuous improvement of product quality, we have ensured a lot of customer satisfaction. Currently, we are supplying to 18 countries worldwide, include Middel east, Southeast Asia, Africa, East Asia, as well as Northern America.

We sincerely hope that we can be your partners and be part of your supply chain provider. Do send us enquiry and we will try our best to fulfil your needs. As our motto speaks:

“TOGETHER, WE CLEAN BETTER” And we believe together, we will be better!

Looking forward your journey with us in the near term.

New Office & Warehouse

Nationwide Logistic Team



CONTENTS

HOUSEHOLD PRODUCTS



3-25

Pail, Basin, Basket & Bin Series
水桶, 塑料盆,
纸篓与垃圾桶系列



26-51

Kitchenware & Household Series
厨房及家居用品系列



52-57

Hardware Plastic Series
工业塑料产品系列

HARDLINE PRODUCTS



58-63

Industry Products Series
工业产品系列



64-68

Canopy Series
帐篷产品系列

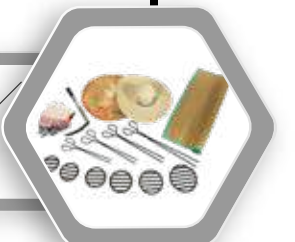

69-70

Hardware Series
工业产品系列



71-76

Stone Series
石臼&刀石系列



77-82

Disposable Series
一次性用品系列



83-87

Bamboo Steamer & Basket Series
竹蒸笼&篮子系

PAIL, BASIN, BASKET & BIN SERIES

水桶，塑料盆，纸篓与垃圾桶系列

HOUSEHOLD





PLASTIC BASIN 平底塑料盆				
	7"	8.5"	10"	12"
Model Code	6070	6085	6100	6120
Barcode	9555221304679	9555221304686	9555221304693	9555221305560
Packing	24 dzs / carton	24 dzs / carton	24 dzs / carton	12 dzs / carton
Size (cm)	18 (∅) x 6.5 (H)	21 (∅) x 7.5 (H)	24.5 (∅) x 8.5 (H)	30 (∅) x 11 (H)
Color				



PLASTIC BASIN 平底塑料盆				
	14"	16"	18"	20"
Model Code	6140	6160	6180	6200
Barcode	9555221304907	9555221304709	9555221305577	9555221306200
Packing	8 dzs / carton	6 dzs / carton	48 pcs / carton	36 pcs / carton
Size (cm)	35 (∅) x 13 (H)	40 (∅) x 14.5 (H)	45 (∅) x 21.5 (H)	49 (∅) x 24.5 (H)
Color				



PLASTIC BASIN WITH HANDLE 双耳平底塑料盆			
	22"	24"	26"
Model Code	6220	6240	6260
Barcode	9555221305942	9555221305959	9555221305966
Packing	24 pcs / carton	18 pcs / carton	15 pcs / carton
Size (cm)	55 (∅) x 26 (H)	61 (∅) x 29 (H)	66 (∅) x 32 (H)
Color			



PLASTIC BASIN WITH HANDLE 双耳平底塑料盆		
	28"	32"
Model Code	6280	6320
Barcode	9555221307083	9555221307076
Packing	8 pcs / carton	8 pcs / carton
Size (cm)	70 (∅) x 32 (H)	80 (∅) x 34 (H)
Color		

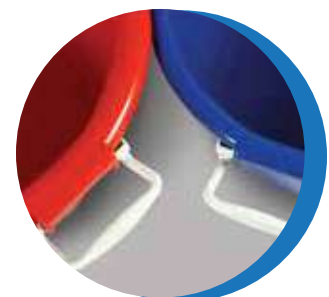

Heavy-duty handle
Easy to carry



ECONOMY PLASTIC BASIN 经济平底塑料盆

	14"	16"	18"	20"
Model Code	V6140	V6160	V6180	V6200
Barcode	9555221305232	9555221305249	9555221305638	9555221305256
Packing	8 dzs / carton	6 dzs / carton	48 dzs / carton	36 dzs / carton
Size (cm)	35 (∅) x 13 (H)	40 (∅) x 14 (H)	45 (∅) x 21.5 (H)	49.5 (∅) x 24 (H)
Color				

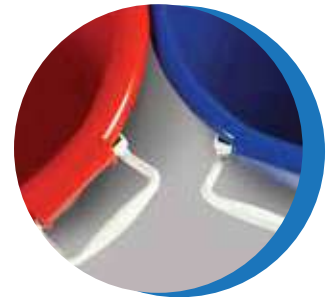

Heavy-duty handle
Easy to carry

PLASTIC BASIN WITH HANDLE 双耳平底塑料盆

	20" (S)	24" (L)
Model Code	EB6200	EB6240
Barcode	9555221304921	9555221304914
Size	510mm(L) x 255mm(H)	610mm(L) x 280mm(H)
Packing	18 pcs / carton	24 pcs / carton
Color		



PAIL 水桶				
	0.5 Gallon	1 Gallon	2 Gallon	3 Gallon
Model Code	9050	9100	9200	9300
Barcode	9555221306512	9555221304273	9555221304280	9555221304297
Packing	48 pcs / carton	48 pcs / carton	48 pcs / carton	36 pcs / carton
Size (cm)	16 (∅) x 13.5 (H)	20.5 (∅) x 16 (H)	25.5 (∅) x 25 (H)	28.5 (∅) x 28.5 (H)
Color				



PAIL 水桶				
	4 Gallon	5 Gallon	6 Gallon	8 Gallon
Model Code	9400	9500	9600	9800
Barcode	9555221303566	9555221303573	9555221303580	9555221303597
Packing	36 pcs / carton	24 pcs / carton	24 pcs / carton	24 pcs / carton
Size (cm)	31 (∅) x 31 (H)	33.5 (∅) x 33.5 (H)	35.5 (∅) x 36 (H)	37.5 (∅) x 38 (H)
Color				



ECONOMY PAIL 经济水桶				
	1 Gallon	2 Gallon	3 Gallon	4 Gallon
Model Code	V1000	V2000	V3000	V4000
Barcode	9555221305201	9555221305669	9555221305539	9555221304778
Packing	144 pcs / carton	144 pcs / carton	36 pcs / carton	36 pcs / carton
Size (cm)	20.5 (∅) x 16 (H)	25 (∅) x 25 (H)	28 (∅) x 25 (H)	31 (∅) x 30 (H)
Color				



ECONOMY PAIL 经济水桶			
	5 Gallon	6 Gallon	8 Gallon
Model Code	V5000	V6000	V8000
Barcode	9555221304884	9555221305225	9555221306260
Packing	24 pcs / carton	24 pcs / carton	24 pcs / carton
Size (cm)	33.5 (∅) x 34 (H)	36 (∅) x 36 (H)	37.5 (∅) x 38 (H)
Color			



ECONOMY MOP PAIL 经济地拖水桶		
	4 Gallon	5 Gallon
Model Code	V4000-1	V5000-1
Packing	24 pcs / carton	18 pcs / carton
Size (cm)	31 (∅) x 30 (H)	33.5 (∅) x 34 (H)
Color		



MOP PAIL 地拖水桶				
	4 Gallon	5 Gallon	6 Gallon	8 Gallon
Model Code	9400-1	9500-1	9600-1	9800-1
Packing	24 pcs / carton	24 pcs / carton	18 pcs / carton	18 pcs / carton



MOP COVER				
	4 Gallon	5 Gallon	6 Gallon	8 Gallon
Model Code	9401	9501	9601	9801
Barcode	9555221303603	9555221303610	9555221303627	9555221303634
Size (cm)	31.5 (∅) x 12 (H)	34 (∅) x 12 (H)	36 (∅) x 12 (H)	38 (∅) x 12 (H)
Packing	48 pcs / carton	48 pcs / carton	48 pcs / carton	48 pcs / carton



EXTRA LARGE MOP COVER 加大桶盖		
	6 Gallon	8 Gallon
Model Code	9601B	9801B
Barcode	9555221305102	9555221305119
Size (cm)	36 (∅)	38 (∅)
Packing	48 pcs / carton	48 pcs / carton

EXTRA LARGE MOP PAIL 加大地拖水桶		
	6 Gallon	8 Gallon
Model Code	9600-1B	9800-1B
Packing	18 pcs / carton	18 pcs / carton



360° rotation industry wheel



20 LITRE MOP BUCKET WITH WHEEL 20L 有轮地拖水桶	
Model Code	9540-1
Barcode	9555221307090
Packing	12 pcs / box; 144 units / carton
Size (cm)	41 (L) x 25.5 (H)
Color	

MOP PAIL COVER 桶盖	
Model Code	9541
Barcode	9555221307106
Size (cm)	23 (L) x 29.5 (W)
Packing	12 pcs / box; 144 units / carton



Special design



Easy to push downward



For extra squeeze to drain



A durable metal handle enables easy lifting on and off hanitor carts.



With mop drying wringer make cleaning more efficient.



Rotatable wheels for easy mopping works.



360° Rotatable wheels for easy mopping works.

Features:

- Safety caution symbol.
- Save energy and hygiene.
- Heavy duty durable plastic material.
- Recommended to using in hospital, retail, office and etc.
- Removable wringer allows for easy disposal of dirty mop water.

Suitable various types of mops



MOP BUCKET WITH WRINGER		
	20L	32L
Model	9520-1	9532-1
Barcode	9555221311387	9555221311394
Packing	1 sets/ carton; 20 sets/ pallet	1 sets/ carton; 20 sets/ pallet



MULTIPURPOSE BUCKET WITH COVER 多用途盖桶				
	4 Gallon	5 Gallon	6 Gallon	8 Gallon
Model Code	9400-2	9500-2	9600-2	9800-2
Barcode	9555221305195	9555221305164	9555221305171	9555221305188
Packing	12 pcs / carton	12 pcs / carton	12 pcs / carton	12 pcs / carton
Size (cm)	31 (Ø) x 31 (H)	33.5 (Ø) x 33.5 (H)	35.5 (Ø) x 36 (H)	37.5 (Ø) x 38 (H)
Color				



BUCKET COVER 桶盖				
	4 Gallon	5 Gallon	6 Gallon	8 Gallon
Model Code	9402	9502	9602	9802
Packing	48 pcs / carton	48 pcs / carton	48 pcs / carton	48 pcs / carton
Size (cm)	31.5 (Ø)	34 (Ø)	36 (Ø)	38 (Ø)
Color				



Both sides handle for easy carrying

12G MULTIPURPOSE BUCKET W HANDLE 12G提手多用途水桶	
Model Code	8120
Barcode	9555221305874
Size (cm)	42.5(∅) x 55.5(H)
Packing	12 pcs / carton; 120 pcs / pallet
Color	

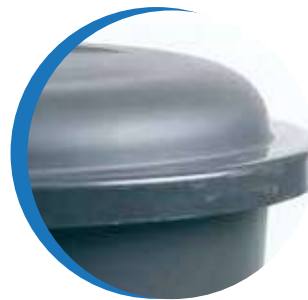

Round top surface to avoid water retention

12G MULTIPURPOSE BUCKET WITH HANDLE (RECYCLE) 12G提手多用途水桶 (黑色)	
Model Code	V8120
Barcode	9555221305881
Size (cm)	42.5(∅) x 51(H)
Packing	12 pcs / carton; 120 pcs / pallet
Color	



Both sides handle for easy carrying



Round top surface to avoid water retention

MULTIPURPOSE BUCKET WITH HANDLE (RECYCLE) 提手多用途水桶 (黑色)		
	80 L	120 L
Model Code	V8800 - 1S	V8320 - 1
Barcode	9555221306215	9555221307731
Size	48(∅) x 73(H)	60(∅) x 73(H)
Packing	12 pcs / carton; 48 pcs / pallet	6 pcs / carton; 30 pcs / pallet
Color	■	■

MULTIPURPOSE BUCKET WITH HANDLE 提手多用途水桶		
	80 L	120 L
Model Code	8800 - 1	8320 - 1
Barcode	9555221306222	9555221306802
Size (cm)	48(∅) x 73(H)	60(∅) x 73(H)
Packing	12 pcs / carton; 48 pcs / pallet	6 pcs / carton; 30 pcs / pallet
Color	■ ■	■ ■

Push Cover



Square push cover design for model RI40B



RI20B (20L)



RI30B (30L)



RI40B (40L)



RI60B (60L)



DUSTBIN WITH SWING LID 塑料推盖拉		
	20L	30L
Model Code	RI20B	RI30B
Barcode	955522130373	9555221310380
Size (cm)	51cm (H) x 18cm (L) x 35cm (W)	59cm (H) x 19cm (L) x 38cm (D)
Packing	12 sets / carton	12 sets / carton
Color		

DUSTBIN WITH SWING LID 塑料推盖拉		
	40L	60L
Model Code	RI40B	RI60B
Barcode	955522130403	9555221310410
Size (cm)	60cm (H) x 24cm (L) x 39cm (W)	74cm (H) x 22cm (L) x 45cm (D)
Packing	6 sets / carton	6 sets / carton
Color		



Special design ashtray



Customer's logo can be printed upon request



Double sided cover

80 LITRE DOME TOP DOUBLE PUSH IN TRASHBIN 80L拱顶双边盖垃圾桶		80 LITRE DOME TOP DOUBLE PUSH IN TRASHBIN (BLACK) 80L拱顶双边盖垃圾桶 (黑色)	
Model Code	8800-2	V8800-2	
Barcode	9555221307724	9555221307731	
Size (cm)	48(∅) x 98.5(H)	48(∅) x 98.5(H)	
Packing	12 units / carton	12 units / carton	
Color			



SYTLISH ROUND STEP BIN 时尚圆形脚踏垃圾桶			
	4 Gallon	8 Gallon	12 Gallon
Model Code	7040	7080	7120
Barcode	9555221307465	9555221307168	9555221307830
Size (cm)	28.5(Ø)x 31(H)	31(Ø) x 39.5(H)	39.5(Ø) x 53.5(H)
Packing	8 units / carton	6 units / carton	4 units / carton
Color			



SYTLISH SQUARE STEP BIN 时尚方形脚踏垃圾桶			
	4 Gallon	8 Gallon	12 Gallon
Model Code	7044	7084	7124
Barcode	9555221306697	9555221305614	9555221306253
Size (cm)	29.5(H)x21(W)x25.5/23(D)	41(H)x25(W)x31/28.5(D)	52.5(H)x32.5(W)x39/35.5(D)
Packing	8 units / carton	6 units / carton	4 units / carton
Color			



PAPER BASKET WITH RING (S) 纸篓 (小)		PAPER BASKET WITH RING (L) 纸篓 (大)	
Model Code	7300-1	Model Code	7400-1
Barcode	9555221304754	Barcode	9555221304495
Size (mm)	280(D) x 275(H)	Size (mm)	310(D) x 315(H)
Packing	36 pcs / pkt; 144 pcs / carton	Packing	36 pcs / pkt; 72 pcs / carton
Color		Color	



WASTE BASKET 废纸篓	
Model Code	V730
Barcode	9555221305096
Size (mm)	275(D) x 285(H)
Packing	3 dzs / pkt; 12 dzs / carton
Color	



COMMERCIAL PEDAL DUSTBIN		商用垃圾桶
Model Code	RI-120U	RI-240U
Barcode	9555221309209	9555221309216
Volume (Litre)	120	240
Weight (Kg)	9.8	16
Measurement (mm)	560x480x920	730x580x1080
Max Load (Kg)	50	96
Packing	3	3
Color	■	■

- * Feature:
- Manufactured and tested to EN840-DIN30700 standard
 - HDPE material, extra additives for UV, Cold and Chemical Resistance
 - Steel Galvanized wheel axle (2 wheel bins) with solid wheel tyres



68L STEP DUSTBIN WITH LID & WHEELS 双轮脚踏垃圾桶 (68L)	
Model Code	7154
Barcode	9555221307663
Size (cm)	61(H) x 48.5(W) x 48(D)
Packing	3 units / carton
Color	



45 L



30 L

STEP DUSTBIN		
	30 L	45 L
Model Code	7304	7454
Barcode	9555221304235	9555221304242
Size (cm)	43(H) x 42(W) x 39.5(D)	59(H) x 42(W) x 39.5(D)
Packing	3 pcs	3 pcs
Color		

* Yellow is for Medical Waste



COMMERCIAL RECYCLED DUSTBIN		商用垃圾桶				
Model Code	RI-120OR	RI-240OR	RI-120B	RI-240B	RI-120BR	RI-240BR
Barcode	9555221309117	9555221309636	9555221309094	9555221309629	9555221309100	9555221309612
Volume (Litre)	120	240	120	240	120	240
Weight (Kg)	7.3	10.6	7.3	10.6	7.3	10.6
Measurement (mm)	550X470X900	710X560X1010	550X470X900	710X560X1010	550X470X900	710X560X1010
Max Load (Kg)	45	75	45	75	45	75
Packing	3	3	3	3	3	3
Color						

* Note 1: Customize color and logo is available upon request, Terms & Conditions apply
 Note 2: Installation not included, wheel sets can be sold separately



240Y



120Y



7454Y



7304Y

BIOHAZARD MARKED MEDICAL STEP BIN 脚踏医疗垃圾桶		
	30 L	45 L
Model Code	7304Y	7454Y
Barcode	9555221304235	9555221304242
Measurement (mm)	43(H) x 42(W) x 39.5(D)	59(H) x 42(W) x 39.5(D)
Packing	3 pcs	3 pcs
Color		

BIOHAZARD MARKED MEDICAL WASTE BIN 医疗垃圾桶		
	120 Y	240 Y
Model Code	120 Y	240 Y
Barcode	9555221311189	9555221311196
Volume (Litre)	120	240
Weight (Kg)	7.5	13.2
Measurement (mm)	550(H) x 470(W) x 950(D)	720(H) x 570(W) x 1050(D)
Max Load (Kg)	50	90
Packing	3	3
Color		

* Note 1: Customize color and logo is available upon request, Terms & Conditions apply
 Note 2: Installation not included, wheel sets can be sold separately



RI-100A



RI-120A



RI-240A



RI-240G

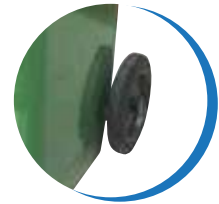

COMMERCIAL DUSTBIN 商用垃圾桶

Model Code	RI-100A	RI-100G	RI-120A	RI-120G	RI-240A	RI-240G
Barcode	9555221309711	95552213099667	9555221309087	9555221309698	9555221309124	9555221309131
Volume (Litre)	100	100	120	120	240	240
Weight (Kg)	6.3	6.5	7.3	7.5	10.6	13.2
Measurement (mm)	530X470X810	530X470X830	550X470X900	550X470X950	710X560X1010	720X570X1050
Max Load (Kg)	40	42	45	50	70	90
Packing	3	3	3	3	3	3
Color	■	■	■	■	■	■

* Note 1: Customize color and logo is available upon request, Terms & Conditions apply
 Note 2: Installation not included, wheel sets can be sold separately



WHEEL SETS FOR DUSTBIN	
For Model	100 L / 120 L
Pcs Per Set	2 rubber wheels + 1 iron rod

Wheel Width : 5 cm



WHEEL SETS FOR DUSTBIN	
For Model	240 L
Pcs Per Set	2 rubber wheels + 1 iron rod



Wheel Width : 4.5 cm



DUSTBIN WHEELS	
For Model	660 L
Pcs Per Set	2 fix + 2 brake



Wheel Width : 5 cm

DUSTBIN WHEELS	
For Model	1100 L
Pcs Per Set	2 fix + 2 brake



COMMERCIAL HEAVY DUTY DUSTBIN 商用垃圾桶		
Model Code	RI-660G	RI-1100G
Barcode	9555221309148	9555221309605
Volume (Litre)	660	1100
Weight (Kg)	42	50
Measurement (mm)	770X1350X1220	1040X1360X1300
Max Load (Kg)	50	96
Packing	1	1
Color		

KITCHENWARE & HOUSEHOLD SERIES

厨房及家居用品系列





MULTIPURPOSE PLASTIC ROUND DEEP COLANDER 多用途塑料圆滤盆			
Model Code	C008	C009	
Barcode	9555221311417	9555221311424	
Size	8"	9"	
Packing	12pcs / bag ; 288pcs / carton	12pcs / bag ; 288pcs / carton	
Color			



MULTIPURPOSE PLASTIC SQUARE COLANDER 多用途塑料方滤盆				
Model Code	C408	C410	C412	C414
Barcode	9555221309261	9555221308721	9555221309278	9555221309285
Size	8"	10"	12"	14"
Packing	144 pcs / carton	144 pcs / carton	144 pcs / carton	144 pcs / carton
Color				



AIRTIGHT ROUND STORAGE CONTAINER 密封储存圆容器			
Model Code	OP3007	OP3004	OP3002
Barcode	9555221309070	9555221309803	9555221309971
Size	23.5cm x 37cm	23.5cm x 18.5cm	23.5cm x 9.5cm
Capacity	7L	4L	2L
Packing	6 pcs / pkt 36 pcs / carton	6 pcs / pkt 48 pcs / carton	6 pcs / pkt 72 pcs / carton
Color			

ROUND DISH COVER 圆形菜罩

Model Code	5120
Barcode	9555221306581
Size	12"
Packing	72 sets / carton
Color	



ROUND DISH COVER 圆形菜罩

Model Code	5220
Barcode	9555221305690
Size	20"
Packing	36 sets / carton
Color	



ROUND DISH COVER 圆形菜罩

Model Code	5240
Barcode	9555221306055
Size	24"
Packing	36 sets / carton
Color	



SQUARE DISH COVER 方形菜罩

Model Code	5224
Barcode	9555221305683
Size	22"
Packing	36 sets / carton
Color	

RECTANGULAR DISH COVER 长方形菜罩

Model Code	5302
Barcode	9555221305850
Size	25" x 19.5"
Packing	36 sets / carton
Color	





FLOWER POT (SMALL) 塑料花盆	
(S)	
Model Code	FP06
Barcode	9555221310229
Size (cm)	17 (∅) x 14 (H)
Packing	12 pcs / bag ; 144 pcs / carton
Color	



FLOWER POT (SMALL) 塑料花盆	
(B)	
Model Code	FP07
Barcode	9555221310236
Size (cm)	25.5 (∅) x 15.3 (H)
Packing	12 pcs / bag ; 144 pcs / carton
Color	

MULTIPURPOSE STAND 多用途脚垫		
	(S)	(B)
Model Code	FS03	FS04
Barcode	9555221304815	9555221304808
Size (cm)	9 (L) x 6 (H)	12 (L) x 8.5 (H)
Packing	72 sets / carton	36 sets / carton



HEAVY DUTY MULTIPURPOSE ROUND TROLLEY (6 WHEELS) 重负多用途	
Model Code	3017
Barcode	9555221307069
Size (cm)	42 (L) x 10 (H)
Packing	48 units / carton



DOOR WEDGE COMBO 胶门尖 (BIG-SMALL BLISTER PACK)	
Model Code	0049
Barcode	9555221306840
Size	150mm (L) / 120mm (L)
Packing	12pkt / bag; 216 units / carton



SMALL DOOR WEDGE 胶门尖 (3 PCS BLISTER PACK)	
Model Code	004-3
Barcode	9555221306987
Size	120mm (L)
Packing	12pkt / bag; 288 units / carton



LARGE DOOR WEDGE 胶门尖 (2 PCS BLISTER PACK)	
Model Code	009-2
Barcode	9555221306970
Size	150mm (L)
Packing	12pkt / bag; 240 units / carton



SMALL DOOR WEDGE 小胶门尖	
Model Code	004
Barcode	9555221301227
Size	120mm (L)
Packing	12pkt / bag; 120 units / carton

LARGE DOOR WEDGE 大胶门尖	
Model Code	009
Barcode	9555221301234
Size	150mm (L)
Packing	12pkt / bag; 58 units / carton





007



008

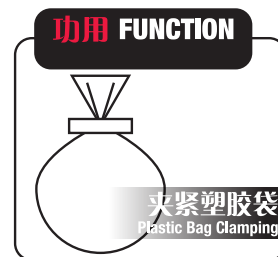

MULTIPURPOSE CLIPPER 万能夹		
Model Code	007	008
Barcode	9555221301241	9555221301258
Size	90mm (L)	150mm (L)
Packing	12 pcs /pkt; 576 units / carton	12 pcs /pkt; 240 units / carton

Patented Product



MAGIC CLOTH PEG 神奇衣夹			
	(S)	(M)	(B)
Model Code	605	603	604
Barcode	9555221306994	9555221303405	9555221304785
Packing	12 pcs /pkt; 288 pcs / carton	12 pcs /pkt; 288 pcs / carton	12 pcs /pkt; 144 pcs / carton

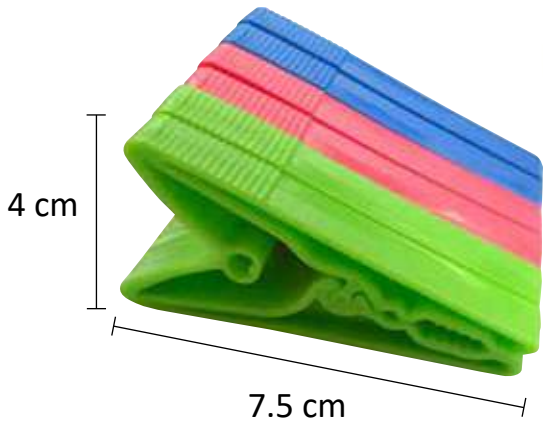

Model : 607-30



Without Spring



Can be used for clamping curtains, quilts and coats etc

Magic Cloth Peg 实用衣夹		
Model Code	607-30	607-20
Barcode	9555221304228	9555221304211
Packing	20 pkt/box, 120 pkt/ctn	24 pkt/box, 144 pkt/ctn
Colors		



Model : 607-20





MULTIPURPOSE DOUBLE PANEL HOOK
多用途塑料双吊钩

Model Code	602
Barcode	9555221304372
Packing	12 pcs/box; 72 pcs/carton

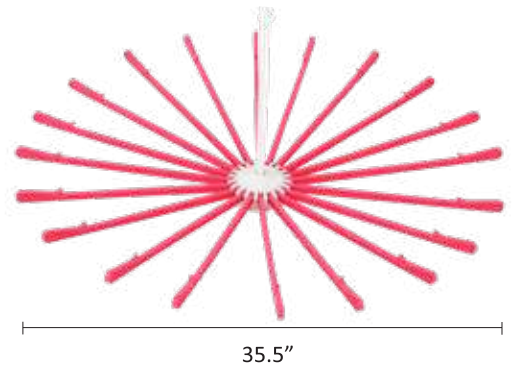

UMBRELLA HANGER
20 头伞形衣架

Model Code	608
Barcode	9555221304938
Packing	36 pcs / carton
Color	

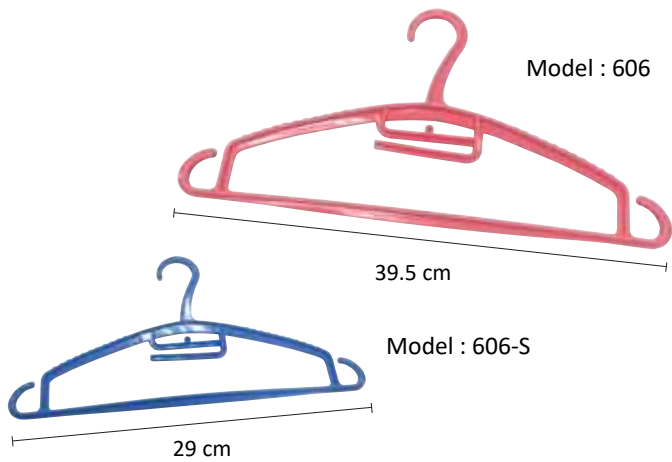

TRENDY HANGER 时尚衣吊

Model Code	606	606-S
Barcode	9555221309179	9555221309186
Packing	6 pcs/pack	12 pcs/pack
Color		

* 饭店厨师都是使用铁锅烹饪，主要是因为它们健康易用并且可以烹制出传统味道

One of the main advantages of using the traditional wok for cooking is that it is considered to be a healthier alternative to cooking with the frying pan.



WOK WITH WOODEN HANDLE 木柄老铁锅		
Model Code	32WH	34WH
Barcode	9555221310069	9555221310076
Diameter (cm)	32 cm	34 cm
Weight (kg)	1.20 kg	1.31 kg
Packing	20 pcs/box	20 pcs/box

WOK WITH WOODEN HANDLE 木柄老铁锅			
Model Code	36WH	38WH	40WH
Barcode	9555221310090	9555221310106	9555221310113
Diameter (cm)	36 cm	38 cm	40 cm
Weight (kg)	1.72 kg	1.85 kg	2.05 kg
Packing	15 pcs/box	15 pcs/box	15 pcs/box

温馨提示 WARM TIPS

- 不要用洗涤剂洗锅，用清水即可。
Do not use detergent to wash the iron wok, just use clean water.
- 铁锅不宜盛过夜食物。
Iron wok should not be used to hold overnight food.
- 不能用铁锅炖中药和酸性果品。
Do not use iron wok to stew traditional chinese medicine and acidic fruits.

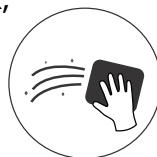

Easy to wash

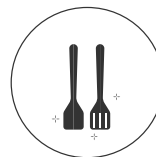

Fits all spatulas



High Quality



Not easy to deform



Easy to wash



Fits all spatulas



High Quality



Not easy to deform

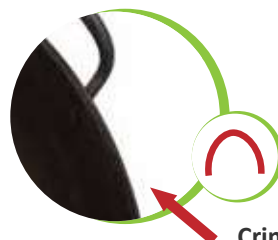

Crimping edge design

DEEP WOK A GRADE WITH DOUBLE HANDLE 双耳A型(卷边)					
Model Code	40WA	45WA	50WA	55WA	60WA
Barcode	9555221310120	9555221310137	9555221310144	9555221310151	9555221310168
Diameter (cm)	40 cm	45 cm	50 cm	55 cm	60 cm
Weight (kg)	2.34 kg	2.76 kg	3.25 kg	3.81 kg	4.41 kg
Packing	10 pcs/box	10 pcs/box	10 pcs/box	8 pcs/box	8 pcs/box



老铁锅
TRADITIONAL WOK
(LONG LASTING)



32WD



60WB



Straight edge design

DEEP WOK WITH DOUBLE HANDLE 双耳B型(直边)				
Model Code	32WD	34WD	36WD	38WD
Barcode	9555221310304	9555221310311	9555221310328	9555221310335
Diameter (cm)	32 cm	34 cm	36 cm	38 cm
Weight (kg)	1.4 kg	1.55 kg	1.7 kg	1.895 kg
Packing	10 pcs/box	10 pcs/box	10 pcs/box	10 pcs/box

DEEP WOK WITH DOUBLE HANDLE 双耳B型(直边)					
Model Code	40WB	45WB	50WB	55WB	60WB
Barcode	9555221310175	9555221310182	9555221310199	9555221310205	9555221310212
Diameter (cm)	40 cm	45 cm	50 cm	55 cm	60 cm
Weight (kg)	1.72 kg	2.15 kg	2.72 kg	3.51 kg	4.30 kg
Packing	10 pcs/box	10 pcs/box	10 pcs/box	8 pcs/box	8 pcs/box

* Wooden handle with hole to hang



FEATURES

- Use high-quality stainless steel, fine sanding treatment.
- Streamlined non-slip wooden handle design.
- Healthier and easier to clean.



ATTENTION

- After use, please rinse with clean water and store in a cool and dry place.
- When using this product for the first time, please wash it fist.

	S/S SUDIP WITH WOODEN HANDLE 木柄不锈钢煲铲	S/S LADLE WITH WOODEN HANDLE 木柄不锈钢钢勺
Model Code	K355	K356
Barcode	9555221310342	9555221310359
Packing	12 pcs / bag; 48 pcs / carton	12 pcs / bag; 48 pcs / carton
Barcode	43cm (L) x 10cm (W)	43cm (L) x 10cm (D)

FEATURES

- Use high-quality stainless steel, fine sanding treatment.
- Black handle design.
- Healthier and easier to clean.

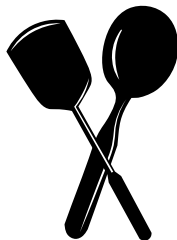

* Black handle with hole to hang



	S/S SUDIP 不锈钢煲铲	S/S LADLE 不锈钢钢勺
Model Code	K353	K354
Barcode	9555221309384	9555221309391
Packing	12 pcs / bag; 300 pcs / carton	12 pcs / bag; 300 pcs / carton



FEATURES

- Use high-quality stainless steel, fine sanding treatment.
- Stainless steel protects against rust and corrosion.
- Fashion with a lustrous mirror finish.
- Healthier and easier to clean.



ATTENTION

- After use, please rinse with clean water and store in a cool and dry place.
- When using this product for the first time, please wash it first.
- Dishwasher safe.



*Special texture design.

ECONOMY S/S SPOON 轻装不锈钢匙		ECONOMY S/S SPOON 轻装不锈钢叉		
Model Code	K768-S12	K769-S6	K768-F12	K769-F6
Barcode	9555221309308	9555221309339	9555221309315	9555221309322
Packing	12 pcs / pkt; 60 pkt / carton	6 pcs / pkt; 120 pkt / carton	12 pcs / pkt; 60 pkt / carton	6 pcs / pkt; 120 pkt / carton

- Wash before using for the first time.
- Dishwasher safe
- Easy to clean
- Long-lasting
- Not easily bent
- Can withstand neat



* Plain pattern best-selling stainless steel cutlery range ideal for restaurant, hotel, home and any related events that requires tableware.



STANDARD S/S SPOON 厚装不锈钢匙		STANDARD S/S SPOON 厚装不锈钢叉		
Model Code	K966-S12	K967-S6	K966-F12	K967-F6
Barcode	9555221309346	9555221309360	9555221309353	9555221309377
Packing	12 pcs / pkt; 120 pkt / carton	6 pcs / pkt; 120 pkt / carton	12 pcs / pkt; 60 pkt / carton	6 pcs / pkt; 120 pkt / carton



PLASTIC LADLE (SMALL) 塑料水杓 (小)

Model Code	9130
Barcode	9555221304440
Packing	12 dzs / carton
Size (cm)	17 (∅) x 8 (H)
Colors	

PLASTIC LADLE (BIG) 塑料水杓 (大)

Model Code	9150
Barcode	9555221304433
Packing	12 dzs / carton
Size (cm)	19 (∅) x 10 (H)
Colors	



PLASTIC LADLE (ROUND) 塑料水杓 (圆形)

Model Code	9170
Barcode	9555221305553
Packing	24 dzs / carton
Size (cm)	18 (∅) x 12 (H)
Colors	



PLASTIC LADLE (SQUARE) 塑料水杓 (方形)

Model Code	9160
Barcode	9555221305546
Packing	24 dzs / carton
Size (cm)	18.5 (L) x 18.5 (W) x 12 (H)
Colors	



MULTIPURPOSE MUG

Model Code	4810
Barcode	9555221309193
Packing	12 pcs / bag; 144pcs / carton
Colors	



- Hand Fan Satay
- Light and easy to use
- High Quality & durable
- Made of wood & fabric
- Convenient to carry around

KIPAS SATAY 沙參扇子

Model Code	BF04
Barcode	9555221310861
Size	45.5cm (L) x 35cm (Ø)
Packing	12pcs / carton; 200pcs



- A bamboo wok brush is a type that is used to clean .
- It is used with the wok still hot and with hot water or water added to a heated wok to clean without so the wok does not rust.
- And at the same time, soft enough that no damage is made to the surface of the wok.

BAMBOO WOK BRUSH 竹锅刷		BAMBOO WOK BRUSH WITH S/S HANDLE 竹锅刷带钢柄	
Model Code	BB630	BB631	
Barcode	9555221309865	9555221309872	
Packing	50 pcs/carton	50 pcs/carton	



- Made with high-quality plastic
- Wash with hot or cold water
- May use detergent or bleach to remove stains.
- Will stand boiling water but keep it away from fire, hot pots, and pans.



Extra Thickness
加厚板



PLASTIC CHOPPING BOARD 塑料占板

Model Code	2001	2012	2002	2003
Barcode	9555221305058	9555221307717	9555221305041	9555221307717
Size	17cm x 27cm x 1cm	20cm x 33cm x 1.1cm	25cm x 35cm x 1.3cm	29cm x 43cm x 1.4cm
Packing	60 pcs / carton	36 pcs / carton	24 pcs / carton	18 pcs / carton



RAYACO TOILET PUMP 厕所泵		
	4.5"	5.5"
Model Code	003	002
Barcode	9555221301210	9555221304389
Handle	1.3P / 2.5R / 4R	1.3P / 2.5R / 4R
Packing	1 dzs / box;12 dzs / carton	1 dzs / box;12 dzs / carton

SANITARY TOILET PUMP 厕所泵			
	3.5"	5"	6"
Model Code	012N	013N	014N
Barcode	9555221302668	9555221302675	9555221302682
Handle	1.3P / 2.5R / 4R	1.3P / 2.5R / 4R	1.3P / 2.5R / 4R
Packing	1 dzs / box;12 dzs / carton	1 dzs / box;12 dzs / carton	1 dzs / box;12 dzs / carton



Easy to pump of softer
synthetic rubber



Wooden Handle

Easy to pump of softer
synthetic rubber



Won't rust, last long time

4.5" RAYACO TOILET PUMP 4.5寸厕所泵	
Model Code	003W
Barcode	9555221311608
Packing	1 dzs / box;12 dzs / carton

5.5" CLASSY TOILET PUMP 5.5寸厕所泵	
Model Code	002M
Barcode	9555221301203
Handle	1.3P / 2.5R / 4R
Packing	1 dzs / box;12 dzs / carton
Color	●●●●

BANQUET TABLE & CHAIR SERIES

折叠桌子及椅子系列



*ALL PICTURES SHOWN ARE FOR ILLUSTRATION PURPOSE ONLY.



BANQUET TABLE SERIES



RED



MARBLE BLUE



WHITE



- Easy to fold and setup.
- Save storage space.
- Hand carry and transport friendly.

Height adjustable and automatic gravity-based leg locking prevent accident collapsing.



Non-marring foot caps

HEIGHT ADJUSTABLE TABLE		
Model Code	AT80W	AT80R / AT80B
Barcode	9555221311127	9555221311479
Kgs	4.5 / 4.1 Kgs	4.5 / 4.1 Kgs
Size	76.5cm x 50cm x 48/65/74cm	76.5cm x 50cm x 48/65/74cm
Packing	30 pcs / pallet	30 pcs / pallet
Color	○	● ○



- Easy to fold and setup.
- Save storage space.
- Hand carry and transport friendly.



3FT SQUARE TABLE		
Model Code	ST90W	ST90B / ST90R
Barcode	9555221311110	9555221311462
Kgs	8.7 / 8 Kgs	8.7 / 8 Kgs
Size	87cm x 87cm x 74cm	87cm x 87cm x 74cm
Packing	20 pcs / pallet	20 pcs / pallet
Color	○	● ○

- Features:
- *Very durable and unbreakable
 - *Suitable for bbq, school, study and etc.



BANQUET TABLE SERIES



ST120R (RED)



ST180W (WHITE)



ST120W (WHITE)



ST120B (MARBLE BLUE)



	4 X 2 FT SOLID TABLE	4 X 2 FT SOLID TABLE	6 FT SOLID TABLE
Model Code	ST120R / ST120B	ST120W	ST180W
Barcode	95552213111455	9555221311103	9555221311356
Kgs	8 / 7.5 kgs	8 / 7.5 Kgs	13 / 12.5 Kgs
Size	122cm x 60cm x 74cm	122cm x 60cm x 74cm	180cm x 75cm x 74cm
Packing	20 pcs / pallet	20 pcs / pallet	20 pcs / pallet
Color	○ ● ○	○	○

Features:

- *Very durable and unbreakable
- *Suitable for bbq, school, study and etc.
- * Automatic Gravity-based leg locking prevent accident collapsing

BANQUET TABLE SERIES

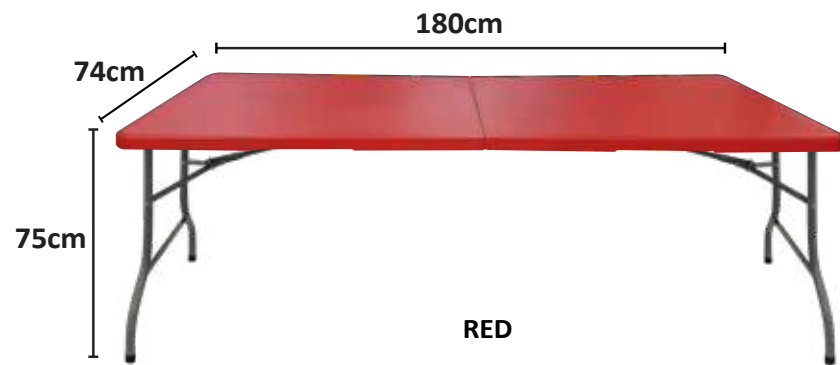

Features:

- *Very durable and unbreakable
- *Suitable for bbq, school, study and etc.

- Easy to fold and setup.
- Save storage space.
- Hand carry and transport friendly.



*Foldable



*Gravity locks keep table legs open when upright, and slide out of the way for folding

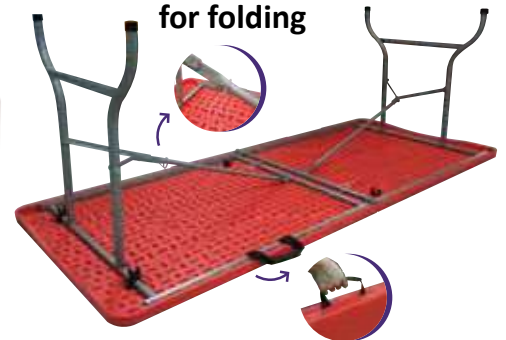

*With carry handle



FOLDING TABLE				
Model Code	FT150W	FT150R / FT150B	FT180W	FT180R / FT180B
Barcode	9555221311097	9555221311431	9555221311066	9555221311431
Kgs	11 / 10.8 Kgs	11 / 10.8 Kgs	13 / 12.8 Kgs	13 / 12.8 Kgs
Size	153.5cm x 70cm x 74cm	153.5cm x 70cm x 74cm	180cm x 75cm x 74cm	180cm x 75cm x 74cm
Packing	20 pcs / pallet	20 pcs / pallet	20 pcs / pallet	20 pcs / pallet
Color	○	● ○	○	● ○



BANQUET TABLE SERIES

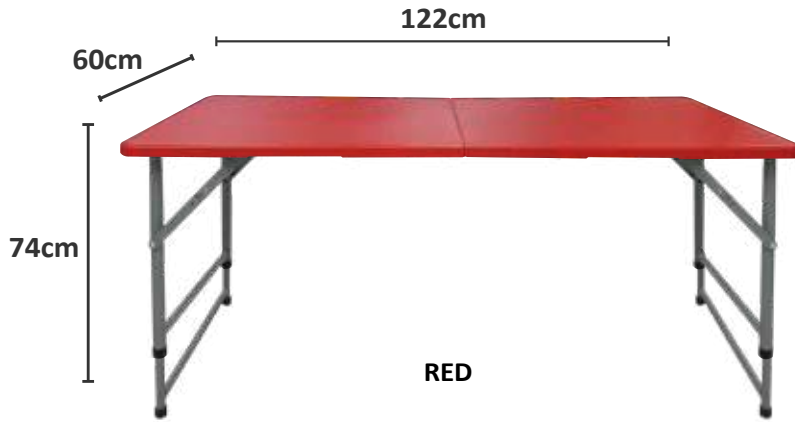

Features:

- *Height adjustable table.
- *Very durable and unbreakable.
- *Suitable for bbq, school, study and etc.



- Easy to fold and setup.
- Save storage space.
- Hand carry and transport friendly.

*Note: please allow 1-3cm difference due to manual measurement.

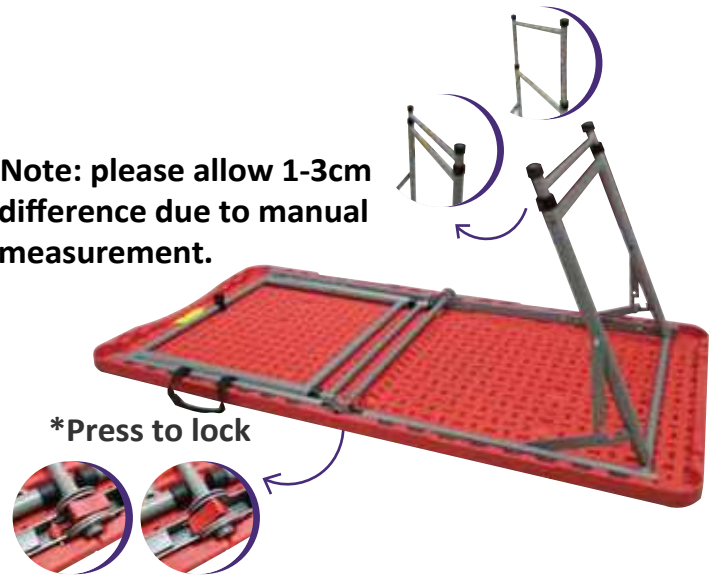

4 FT SOLID TABLE		
Model Code	FT120W	FT120R / FT120B
Barcode	9555221311080	9555221311448
Kgs	9 / 8.5 Kgs	9 / 8.5 Kgs
Size	122cm x 60cm x 53/74cm	122cm x 60cm x 53/74cm
Packing	20 pcs / pallet	20 pcs / pallet
Color	○	● ○

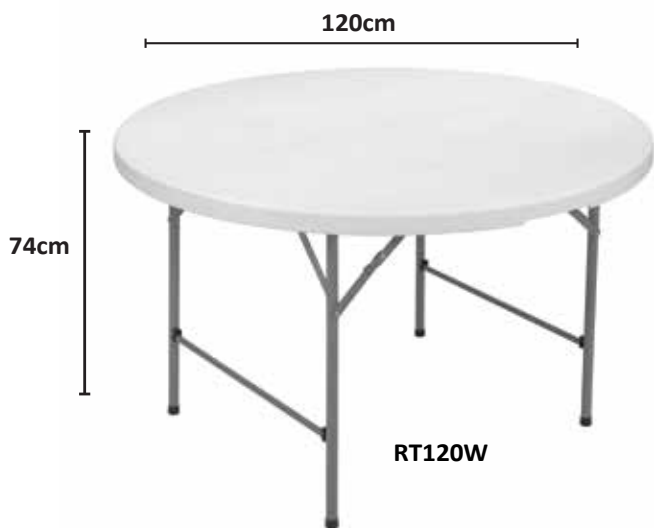

- Save storage space.
- Hand carry and transport friendly.

Easy to fold and setup.

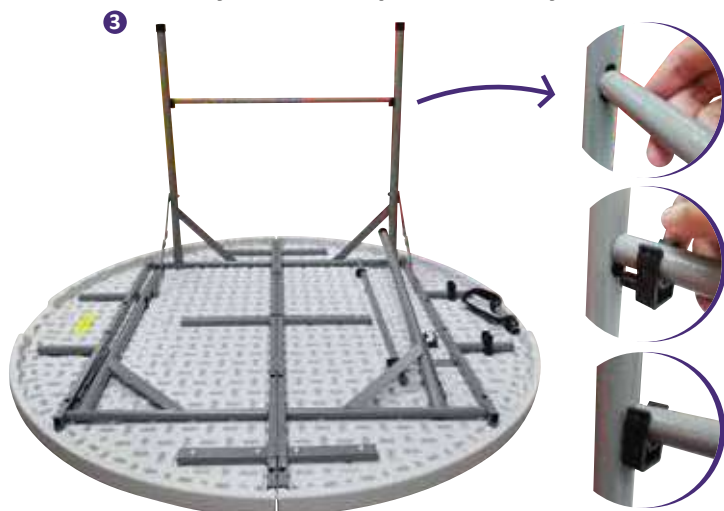

FOLDABLE ROUND TABLE		
Model Code	RT120W	RT150W
Barcode	9555221311363	9555221311370
Size	120cm x 74cm	150cm x 74cm
Packing	4 pcs / pallet	4 pcs / pallet
Color	○	○

- Features:**
- *Very durable and unbreakable.
 - *Suitable for bbq, school, study and etc.

BANQUET TABLE SERIES



***Front**

***Back**



- Easy to fold and setup.
- Save storage space.
- Hand carry and transport friendly.

FOLDABLE ROUND TABLE

Model Code	RT80W	RT80R / RT80B
Barcode	9555221311608	9555221311615
Size	80cm x 74cm	80cm x 74cm
Packing	4 pcs / pallet	4 pcs / pallet
Color	○	○ ●

Features:

- *Very durable and unbreakable.
- *Suitable for bbq, school, study and etc.



Features :

- * Made with high grade raw materia, strong and durable
- * UV & Humidity resistance
- * Support weight more than 150 kg
- * Rubber based for anti-slip
- * Verified no any damage after fall at 10 meter heights

HEAVY-DUTY PLASTIC STACKING CHAIR WITH RUBBER BASE

Model Code	4401R	4401B
Barcode	9555221301135	9555221309957
Packing	12 pcs	12 pcs
Color	●	●

HEAVY-DUTY PLASTIC STACKING CHAIR WITH RUBBER BASE

Model Code	4401M-1	4401B
Barcode	9555221309643	9555221309957
Packing	12 pcs	12 pcs
Color	○	○

HEAVY-DUTY PLASTIC STOOL CHAIR SERIES



Features :

- * Made with high grade raw materia, strong and durable
- * UV & Humidity resistance
- * Support weight more than 150 kg
- * Rubber based for anti-slip
- * Made in Malaysia & Reputable Manufacturer



44 cm

36 cm



HEAVY-DUTY PLASTIC STOOL CHAIR WITH RUBBER BASE

Model Code	4430	V4430
Barcode	9555221309995	9555221309988
Packing	12 pcs	12 pcs
Colors	○ ● ●	●



▶ Easy to store and save space

5 LEGGED STOOL (SMALL) 五脚凳 (小)

Model Code	4200
Barcode	9555221305607
Packing	48 pcs / carton
Size	34cm (L) x 24cm (W) x 20cm (H)
Color	● ● ● ●

5 LEGGED STOOL (TALL) 五脚凳 (高)

Model Code	4300
Barcode	9555221306710
Packing	24 pcs / carton
Size	39cm (L) x 30cm (W) x 31cm (H)
Color	● ● ● ●



▶ Middle leg to withhold heavy weight of up to 250Kg

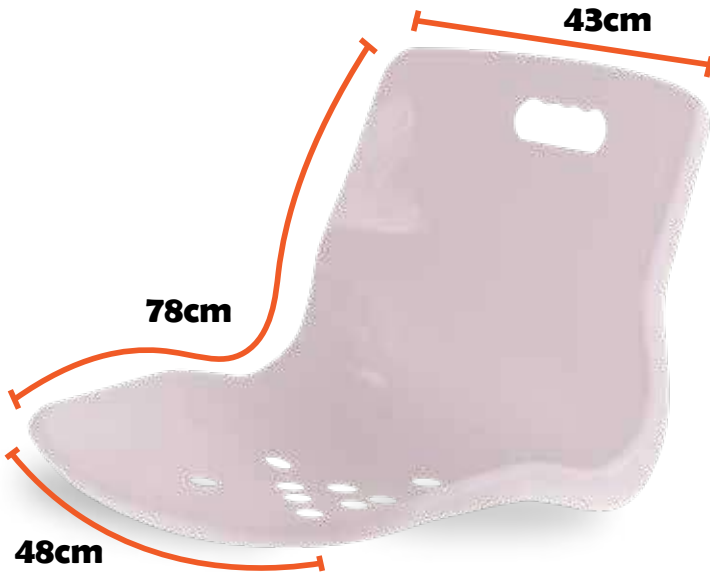

Mengelakkan sakit belakang, kaki kebas atau lenguh dan semut-semut.



*Kerusi ngaji untuk kegunaan masjid, surau, madrasah dan kediaman anda.

KERUSI NGAJI	
Model Code	KN04
Barcode	9555221310878
Packing	10 pcs / carton
Size	● ○

DISTRIBUTED BY : CEMERLANG RAYA (M) SDN BHD

HARDWARE PLASTIC SERIES

工业塑料产品系列

HOUSEHOLD



CEMENT BUCKET (M) 灰桶 (中)

Model Code	8250
Barcode	9555221304303
Packing	144 pcs / carton
Size (cm)	26.5 (Ø) x 18 (H)
Color	



CEMENT BUCKET (L) 灰桶 (大)

Model Code	8260
Barcode	9555221305928
Packing	120 pcs / carton
Size (cm)	29 (Ø) x 18 (H)
Color	



CEMENT BUCKET (XL) 灰桶 (特大)

Model Code	8270
Barcode	9555221305935
Packing	72 pcs / carton
Size (cm)	32 (Ø) x 19.5 (H)
Color	



PAINT TRAY 油漆托盘

Model Code	8017
Barcode	9555221304341
Packing	150 pcs / carton
Size (cm)	33 (L) x 24 (W) x 6.5 (H)



- Gently scrub on cemented wall, for smooth cement wall finishing
可用在打滑洋灰墙壁
- For cleaning mosaic floor or mosaic wall, remove dirt and dust easily
可用于洗刷镶嵌地板或镶嵌墙壁
- For car cleaning and polishing with wax
可用于洗车, 打蜡拖光



SPONGE SCRUB 多用途绵擦	
Model Code	8100
Barcode	9555221304716
Size (cm)	7.5(H) x 20(W) x 12(D)
Packing	48 pcs / pkt; 288 pcs / carton

Scouring Scrubber

Rayaco[®] Floor Scrubber removes heel marks and wax build up quickly and easily! This highly effective cleaning tool has a thick, long lasting scrubber with a comfortable handle that protects your hands and makes cleaning easy and mess free! Rayaco[®] Floor Scrubber also clean:

- Tile
- Laminates
- Vinyl / Linoleum
- Stone

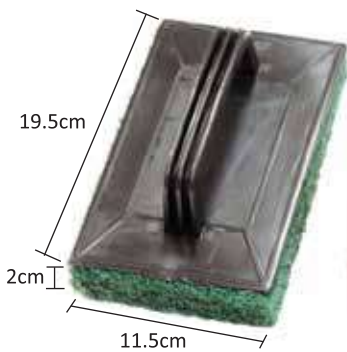

8200

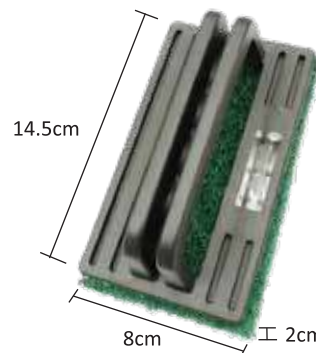

8300



SCOURING SCRUBBER 地板绵擦		
	XL	STANDARD
Model Code	8200	8300
Barcode	9555221304334	9555221309292
Size (cm)	2(H) x 19.5(W) x 11.5(D)	2(H) x 14.5(W) x 8(D)
Packing	12 pkt / box; 144 pcs / carton	12 pkt / box; 144 pcs / carton



CEMENT TRAY (PP) 灰托盘

Model Code	8202 - B
Barcode	9555221304464
Packing	36 pcs / pkt; 216 pcs / carton



CURVY CEMENT TRAY (PP) 灰托盘 (加硬)

Model Code	8203 - B
Barcode	9555221304891
Packing	24 pcs / pkt; 144 pcs / carton



SPRAYER (1000ML)

Model Code	R855
Barcode	955553408557
Packing	12 pcs/bag; 144 pcs/carton
Size (cm)	10 (∅) x 24 (H)
Colors	



HEAVY DUTY PLASTIC SCOOP (S) W HANDLE
塑料重型沙石畚箕 (小)

Model Code	8418B
Barcode	9555221306062
Packing	48 pcs / carton
Colors	

HEAVY DUTY PLASTIC SCOOP (L) W HANDLE
塑料重型沙石畚箕 (大)

Model Code	8419B
Barcode	9555221306079
Packing	48 pcs / carton
Colors	

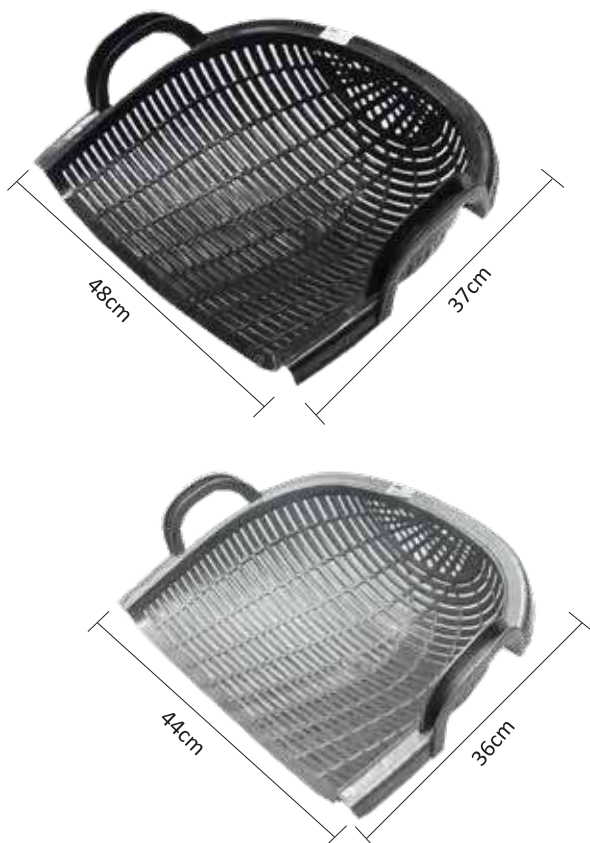

HEAVY DUTY PLASTIC SCOOP (S)
塑料重型沙石畚箕 (小)

Model Code	8418A
Barcode	9555221306725
Packing	48 pcs / carton
Colors	

HEAVY DUTY PLASTIC SCOOP (L)
塑料重型沙石畚箕 (大)

Model Code	8419A
Barcode	9555221306772
Packing	48 pcs / carton
Colors	



HEAVY DUTY DRAIN COVER

DC06



DC09

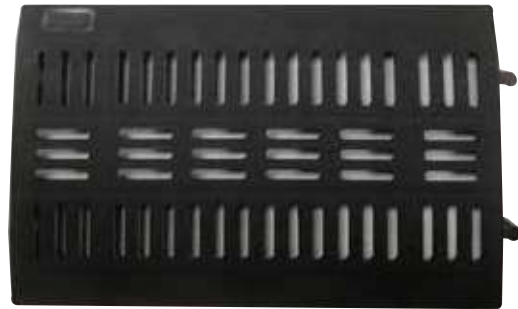

Size:

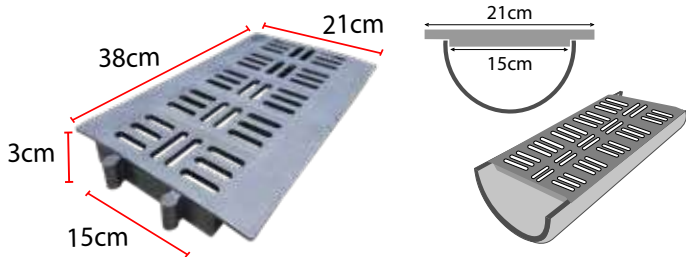

Size:

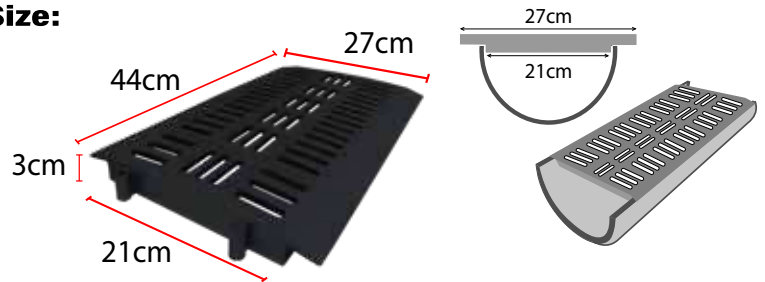

Maximum static load

Special interlocking design for stability.

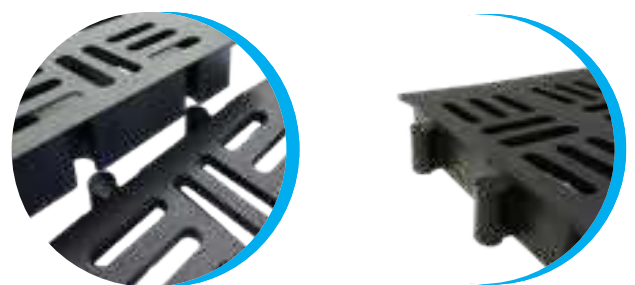
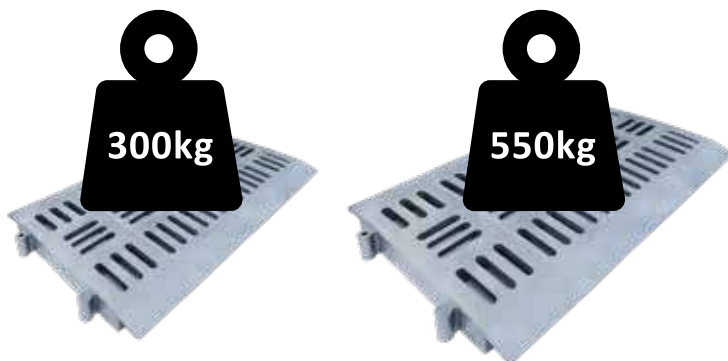

- Suitable to uses at houses, warehouses, gardens, factory side and etc.
- Built tough, easy to install and can be recycled.



HEAVY DUTY DRAIN COVER 沟渠盖		
	SMALL	LARGE
Model Code	DC06	DC09
Barcode	9555221310847	9555221310854
Packing	12pcs / bag ; 144pcs / carton	9pcs / bag; 108pcs/ carton
Size (cm)	6" x 15"	8.5" x 17"
Load Bearing	300kg	550kg
Color	■	■

INDUSTRY PRODUCT SERIES

工业产品系列

HOUSEHOLD





RI-150



RI-300



RI-500



Special designed wheels for heavy loading and better flexibility

RAYACO HEAVY DUTY HANDTRUCK 重型手推车			
Model Code	RI-150	RI-300	RI-500
Barcode	9555221307427	9555221307434	9555221307441
Loading Capacity	150 Kgs	300 Kgs	500 Kgs
Size (mm)	725x475x830	900x595x875	1110x695x875
Total Weight	10.38 kg	13.24 kg	18.24 kg
Packing	50 units / pallet	50 units / pallet	50 units / pallet



VIP HANDTRUCK 手推车		
Model Code	VI-150	VI-300
Barcode	9555221308431	9555221308448
Loading Capacity	150 Kgs	300 Kgs
Size (mm)	725x475x830	900x595x875
Total Weight	9.72 kg	13.56 kg
Packing	50 units / pallet	50 units / pallet

* Note 1: Wheel sets only available

* Note 2: Installation not included, handtruck wheel sets can be sold separately

*ALL PICTURES SHOWN ARE FOR ILLUSTRATION PURPOSE ONLY.

High-quality hook, ▶
much more convenient to
hang things such as umbrella
and others



RAYACO PLASTIC HANDTRUCK	
Model Code	R1-200P
Barcode	9555221309810
Loading Capacity	200 KG
Size (mm)	820x480x840
Packing	50 units / pallet



◀ High-quality wheels,
smooth loading,
noiseless



Economy Wheel



◀ The functional design includes a
convenient storage plastic pocket
put document and other items

VIP HANDTRUCK	
Model Code	VI-155P
Barcode	9555221309858
Loading Capacity	150 KG
Size (mm)	720x480x830
Packing	50 units / pallet

* The world's first fully plastic platform material except the wheels

* Installation not included, handtruck wheel sets can be sold separately





ECONOMIC HANDTRUCK WHEEL SETS	
Model Code	V4100P
For Handtruck Model	VI-155P
Wheel Size	10 cm
Wheels	2 pcs Swivel and 2 pcs Fix

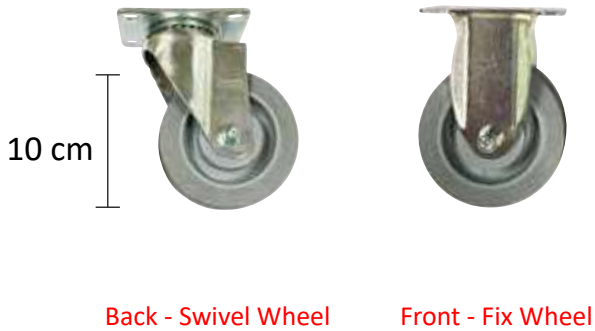

HEAVY DUTY HANDTRUCK WHEEL SETS	
Model Code	R4100
For Handtruck Model	RI-150 / RI-200P
Wheel Size	10 cm
Wheels	2 pcs Swivel and 2 pcs Fix

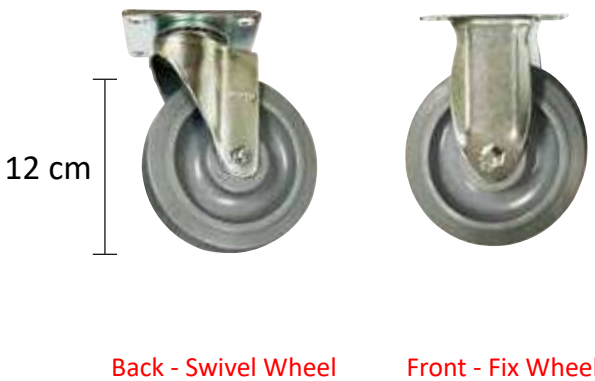

HEAVY DUTY HANDTRUCK WHEEL SETS	
Model Code	R4125
For Handtruck Model	RI-300
Wheel Size	12 cm
Wheels	2 pcs Swivel and 2 pcs Fix



HEAVY DUTY HANDTRUCK WHEEL SETS	
Model Code	R6125
For Handtruck Model	RI-500
Wheel Size	12 cm
Wheels	4 pcs Swivel and 2 pcs Fix

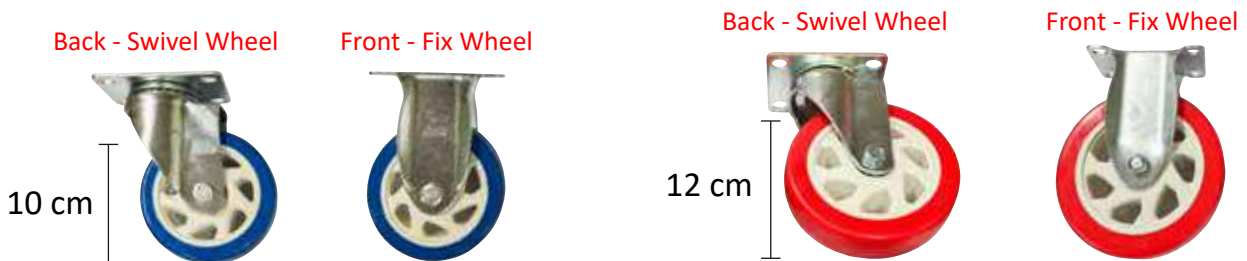

STANDARD HANDTRUCK WHEEL SETS		
Model Code	V4100	V4125
For Handtruck Model	VI-150	VI-300
Wheel Size	10 cm	12 cm
Wheels	2 pcs Swivel and 2 pcs Fix	



HDPE POULTRY INDUSTRIAL TRAY 禽业用篮	
Model Code	114
Barcode	9555221307489
Packing	10 units / pallet
Color	

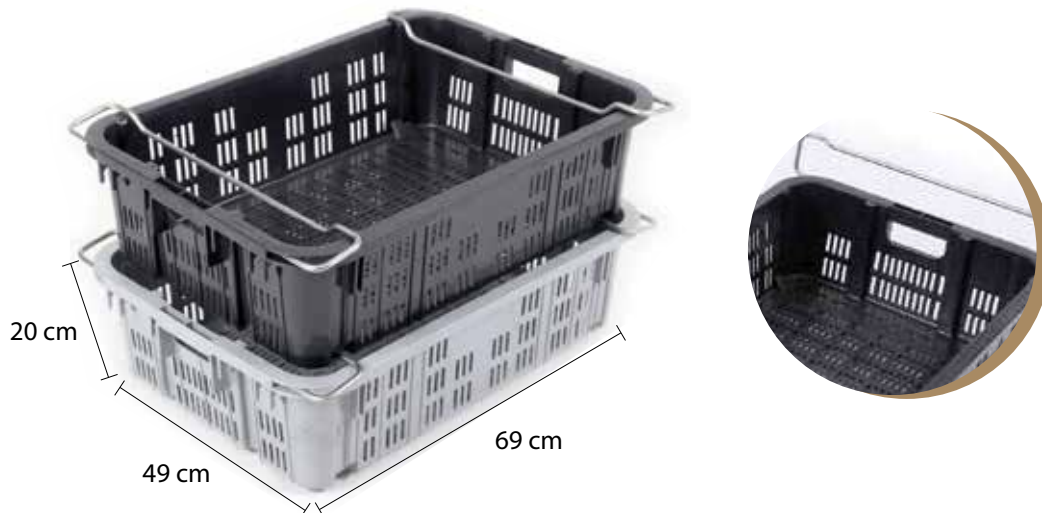

METAL HANDLE INDUSTRIAL CONTAINER 铁柄工业篮	
Model Code	V1052
Barcode	9555221306741
Packing	10 units / pallet
Color	



Metal Handle ▶



METAL HANDLE INDUSTRIAL CONTAINER 铁柄工业篮		
Model Code	103	V103
Barcode	9555221308318	9555221308301
Packing	10 units / pallet	10 units / pallet
Color		

*Note 1: Container can be sold without handle

Note 2: Logo and color can be customized, Terms & Conditions apply



Logo and color ▶
can be customized



◀ **Plastic Handle**

PLASTIC HANDLE INDUSTRIAL CONTAINER 塑柄工业篮		
Model Code	105P	V105P
Barcode	9555221306567	9555221306574
Packing	10 units / pallet	10 units / pallet
Color		

CANOPY SERIES

罩棚产品系列

HOUSEHOLD



VIP SERIES (HEAVY DUTY AAA) 方铁

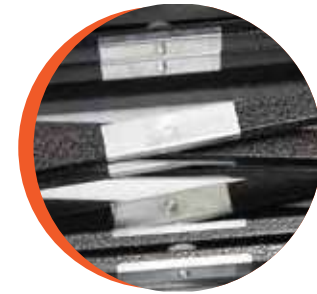

CANOPY BLACK STEEL				
	8"X8" (±19kgs)	10"X10" (±22kgs)	10"X15" (±28kgs)	10"X20" (±35kgs)
Model Code	CB2525	CB3030	CB3045	CB3060
Barcode	9555221307007	9555221307014	9555221307021	9555221309735
Weight	18/19 kg	21/22 kg	27/28 kg	34/35 kg
Packing	50 pcs / pallet	50 pcs / pallet	30 pcs / pallet	30 pcs / pallet

SUPER HEAVY DUTY SERIES

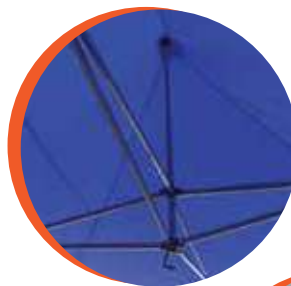

CANOPY BLACK STEEL				
	10"x10" (±33kgs)	10"X15" (±42kgs)	13"X20" (±65kgs)	13"X26" (±80kgs)
Model Code	CM3030	CM3045	CM4060	CM4080
Weight	32/33 kg	41/42 kg	63/65 kg	80/82 kg
Packing	10 pcs / pallet	10 pcs / pallet	6 pcs / pallet	6 pcs / pallet



* Interior canopy top



CANOPY WHITE STEEL 便携式帐篷	
10"X10"	
Model Code	CF3030
Weight	12/13 kg
Packing	50 pcs / pallet

* 关后4尺高。可直接放进车尾箱，配有4套拉绳和插地厚钉，以稳固帐篷。
The canopy will be 4 feet tall when it is closed. It can be put directly into the trunk of the car. Equipped with 4 sets of drawstrings and thick nails inserted in the ground to stabilize the canopy.

BERSATU SERIES (STANDARD AA)
方铁



ECONOMY SERIES (STANDARD B)
扁铁

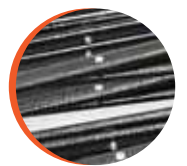

CANOPY BLACK STEEL (STANDARD B) 黑钢扁铁帐篷				
	6"X6" (±11kgs)	8"X8" (±13kgs)	10"X10" (±15kgs)	10"X15" (±20kgs)
Model Code	CA2020	CA2525	CA3030	CA3045
Barcode	9555221307632	9555221309728	9555221308127	9555221310496
Weight	10/11 kg	12/13 kg	14/15 kg	19/20 kg
Packing	50 pcs / pallet	50 pcs / pallet	50 pcs / pallet	50 pcs / pallet

CANOPY BLACK STEEL (STANDARD AA) 黑钢方铁帐篷				
	6"X6" (±15kgs)	8"X8" (±18kgs)	10"X10" (±19kgs)	10"X15" (±25kgs)
Model Code	CS2020	CS2525	CS3030	CS3045
Barcode	9555221307694	9555221307601	9555221307618	9555221307625
Weight	14/15 kg	17/18 kg	18/19 kg	24/25 kg
Packing	50 pcs / pallet	50 pcs / pallet	50 pcs / pallet	50 pcs / pallet

*Disclaimer: Canopy weight might vary due to cloth thickness

*ALL PICTURES SHOWN ARE FOR ILLUSTRATION PURPOSE ONLY.



CANOPY IRON PLATE

Model Code	IP5
Weight	5 kgs
Size	21 cm (H) x 20cm (W)
Packing	4 pcs / carton

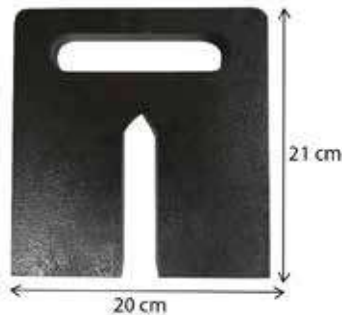

*Suitable for outdoor, can protect canopy from floating up.

MODEL	DESCRIPTION	PACKING
CSW25	8ft Canopy Side Wall	10 pcs / Ctn
CSW25-W	8ft Canopy Side Wall with Window	10 pcs / Ctn
CSW30	10ft Canopy Side Wall	10 pcs / Ctn
CSW30-W	10ft Canopy Side Wall with Window	10 pcs / Ctn
CSW45	15ft Canopy Side Wall	10 pcs / Ctn
CSW45-W	15ft Canopy Side Wall with Window	10 pcs / Ctn
CSW30 x 3	9meter Canopy Side Wall With Window (For 10" x 10" Canopy)	10 pcs / Ctn
CSW30Z	10ft Canopy Side Wall With Zip	10 pcs / Ctn





*Excellent choice to be used at night market, wedding events, catering event and as car park shelter.



CANOPY CLOTH

MODEL	DESCRIPTION	PACKING
CKS2020	Canopy Cloth 600D	10 pcs/ Ctn
CKS2525	Canopy Cloth 600D	10 pcs/ Ctn
CKS3030	Canopy Cloth 600D	10 pcs/ Ctn
CKS3045	Canopy Cloth 600D	5 pcs/ Ctn
CKB2525	Canopy Cloth 600DD (加厚) (8x8)	10 pcs/ Ctn
CKB3030	Canopy Cloth 600DD (加厚) (10x10)	10 pcs/ Ctn
CKB3045	Canopy Cloth 600DD (加厚) (10x15)	5 pcs/ Ctn
CKB3060	Canopy Cloth 600DD (加厚) (10x20)	5 pcs/ Ctn
CKB2525	Canopy Cloth 800DDD (8x8)	10 pcs/ Ctn
CKB3030	Canopy Cloth 800DDD (10x10)	10 pcs/ Ctn
CKB3045	Canopy Cloth 800DDD (10x15)	5 pcs/ Ctn
CKB3060	Canopy Cloth 800DDD (10x20)	5 pcs/ Ctn
CKS2020	Canopy Cloth 420DD (灰胶底) (6x6)	10 pcs/ Ctn
CKS2525	Canopy Cloth 420DD (灰胶底) (8x8)	10 pcs/ Ctn
CKS3030	Canopy Cloth 420DD (灰胶底) (10x10)	10 pcs/ Ctn
CKS3045	Canopy Cloth 420DD (灰胶底) (10x20)	5 pcs/ Ctn
CKA2525	Canopy Cloth 420D (6x6)	10 pcs/ Ctn
CKA3030	Canopy Cloth 420D (8x8)	10 pcs/ Ctn
CKA3045	Canopy Cloth 420D (10x10)	10 pcs/ Ctn

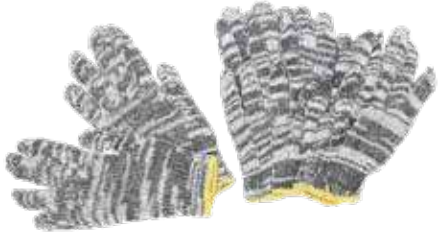

COLOR COTTON GLOVE 彩色幼纱手套

Model Code	GF401C	GF501C
Barcode	9555221305713	9555221305720
Weight	400g	500g
Packing	50 dozens/bag	50 dozens/bag



COLOR COTTON GLOVE 彩色幼纱手套

Model Code	GF760	GF1200
Barcode	9555221305737	9555221305744
Weight	800g	1000g
Packing	50 dozens/bag	50 dozens/bag



WHITE COTTON GLOVE 白色幼纱手套

Model Code	GF401	GF501
Barcode	9555221305713	9555221305720
Weight	400g	500g
Packing	50 dozens/bag	50 dozens/bag



STRAW HAT 花草帽

20"

Model Code	A20
Barcode	9555221306291
Packing	15 dozens / carton



PLASTIC HAT 塑料帽

Model Code	20P	18P
Barcode	9555221304259	9555221304266
Packing	120 pcs / carton	120 pcs / carton

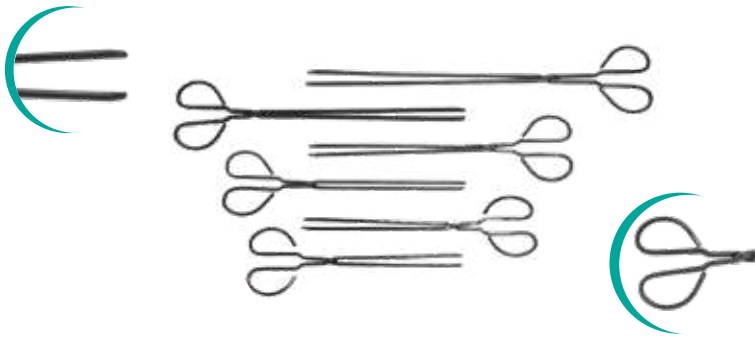

XL TONG 挟子	
Description	Packing
No. 1 Tong (60cm)	50 units / carton
No. 2 Tong (50cm)	50 units / carton
No. 3 Tong (45cm)	50 units / carton
No. 4 Tong (38cm)	100 units / carton
No. 5 Tong (35cm)	100 units / carton

SICKLE 镰刀	
Model Code	S1205
Barcode	9555221304310
Packing	60 units / carton



STRAW MAT WITH BINDING 草席	
Model Code	3x6M
Size	34.5" x 66"
Packing	100 units / carton

GARDEN SCISSORS 花园剪刀		
Model Code	6023 (Branch)	6022 (Leaf)
Barcode	9555221305157	9555221306352
Size (cm)	14cm (L)	16cm (L)
Packing	24 pcs/ box; 144 pcs/ carton	24 pcs/ box; 144 pcs/ carton



6022

6023

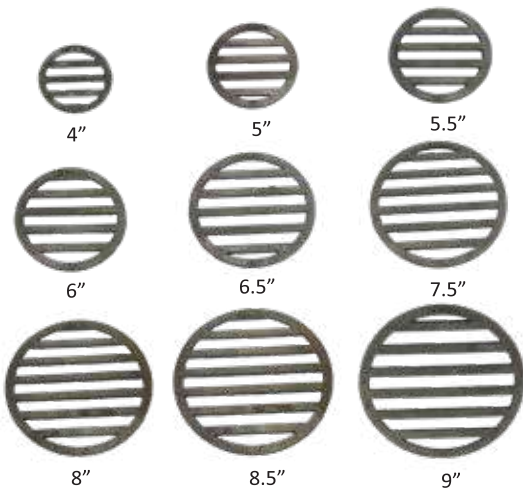

IRON GRATE 铁炉排	
Description	Packing
Iron Grate 4	240 units / carton
Iron Grate 4.5	200 units / carton
Iron Grate 5	150 units / carton
Iron Grate 5.5	150 units / carton
Iron Grate 6	100 units / carton
Iron Grate 6.5	80 units / carton
Iron Grate 7	60 units / carton
Iron Grate 7.5	60 units / carton
Iron Grate 8	50 units / carton
Iron Grate 8.5	50 units / carton
Iron Grate 9	30 units / carton

STONE SERIES

石臼&刀石系列

HOUSEHOLD



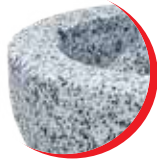

Nature Granite Stone



VIP



Nature Granite Stone



VIP (A)

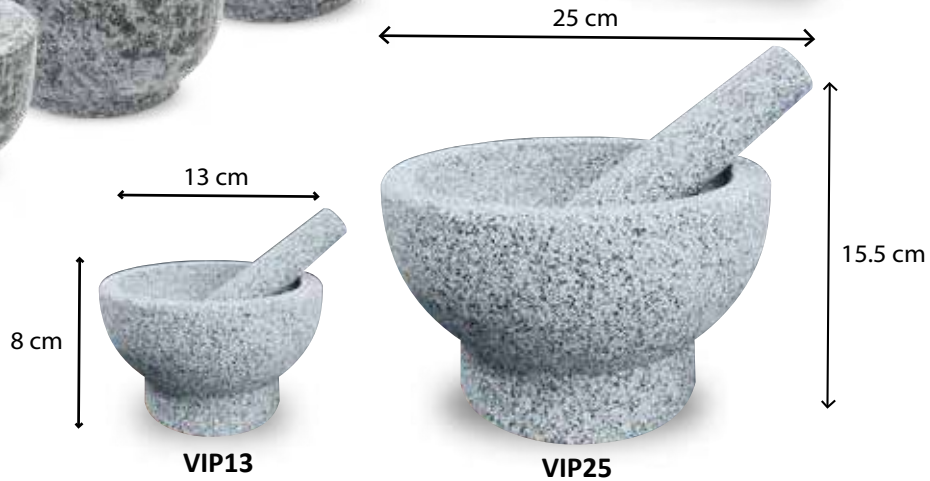

VIP13

VIP25

VIP SERIES - MORTAR & PESTLE 粗石臼				
	VIP13	VIP14.5	VIP16	VIP17.5
Model Code	VIP13 / VIP13 (A)	VIP14.5 / VIP14.5 (A)	VIP16 / VIP16 (A)	VIP17.5 / VIP17.5 (A)
Barcode	9555221307502	9555221307519	9555221307526	9555221307533
Size	13cm (Ø) x 8cm (H)	14.5cm (Ø) x 8.5cm (H)	16cm (Ø) x 10cm (H)	17.5cm (Ø) x 10.5cm (H)
Packing	12 sets /carton	12 sets /carton	12 sets /carton	8 sets /carton

VIP SERIES - MORTAR & PESTLE 粗石臼				
	VIP19	VIP20.5	VIP23.5	VIP25
Model Code	VIP19 / VIP19 (A)	VIP20.5	VIP23.5	VIP25
Barcode	9555221307540	9555221307557	9555221302033	9555221307571
Size	19cm (Ø) x 11.5cm (H)	20.5cm (Ø) x 13cm (H)	23.5cm (Ø) x 14cm (H)	25cm (Ø) x 15.5cm (H)
Packing	8 sets /carton	4 sets /carton	4 sets /carton	2 sets /carton



* Nature Granite Stone

F BLACK SERIES - FINE MORTAR & PESTLE 精磨石臼			
Model Code	F8	F10	F12
Barcode	9555221307595	9555221307175	9555221307199
Size	8cm (Ø) X 7cm (H)	10cm (Ø) X 7.6 cm (H)	12cm (Ø) X 8.3cm
Packing	24 sets / carton	24 sets / carton	24 sets / carton



* Use of stone mortar

- Chili
- Groundnut
- Onion
- Chili Powder
- Red Bean



F BLACK SERIES - FINE MORTAR & PESTLE 精磨石臼					
Model Code	F14.5	F16	F17.5	F19.5	F21.5
Barcode	9555221306864	9555221306871	9555221306888	9555221306895	9555221306901
Size	14.5 cm	16 cm	17.5 cm	19.5 cm	21.5 cm
Packing	12 sets / carton	8 sets / cart	8 sets / carton	6 sets / carton	4 sets / carton

FINE PESTLE 精磨石槌		
Model Code	FP16	FP17.5
Size	16 cm	17.5 cm
Packing	40 sets / carton	30 sets / carton

Rubber pad at the bottom.
Anti-slip and anti-noise



RU SERIES - FINE MORTAR & PESTLE WITH PAD 胶底滑面白&槌				
Model Code	RU13	RU14.5	RU16	RU17.5
Barcode	9555221305294	9555221305300	9555221305317	9555221305324
Size	13 cm	14.5 cm	16 cm	17.5 cm
Packing	12 sets / carton	12 sets / carton	12 sets / carton	8 sets / carton



Smooth Surface

RU SERIES - FINE MORTAR & PESTLE WITH PAD 胶底滑面白&槌			
Model Code	RU19	RU20.5	RU23.5
Barcode	9555221305331	9555221305348	9555221305355
Size	19 cm	20.5 cm	23.5 cm
Packing	8 sets / carton	6 sets / carton	4 sets / carton



PESTLE 滑面槌					
Model Code	R14.5	R16	R17.5	R19	R23.5
Length Size	14.5 cm	16 cm	17.5 cm	19 cm	23.5 cm
Packing	50 sets / carton	40 sets / carton	40 sets / carton	30 sets / carton	20 sets / carton



DIAMOND SHARPENING STONE 钻石牌双面氧化刀石		
	6"	8"
Model Code	DB621	DB821
Barcode	9555221308233	9555221308219
Packing	50 pcs / carton	50 pcs / carton



GOLD FISH SHARPENING STONE 金鱼刀石		
	4"	8"
Model Code	117	118
Barcode	9555221309766	9555221309773
Packing	20 dozen / carton	21 dozen / carton

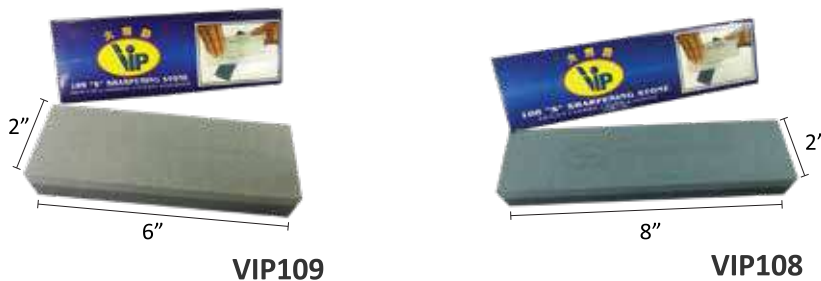

VIP SHARPENING STONE 双面刀石		
	6"	8"
Model Code	VIP109	VIP108
Barcode	9555221306444	9555221306451
Packing	50 pcs / carton	50 pcs / carton





GOLD FISH SHARPENING STONE 金鱼标志刀石		
	6"	8"
Model Code	GF109	GF108
Barcode	9555221305393	9555221305386
Packing	50 pcs / carton	50 pcs / carton



GOLD FISH SHARPENING STONE 金鱼标志刀石		
	6"	8"
Model Code	GF206	GF208
Barcode	9555221308196	9555221308202
Packing	50 pcs / carton	50 pcs / carton



GOLD FISH SHARPENING STONE 金鱼标志刀石	
8" x 3" x 2"	
Model Code	GF823
Barcode	9555221306109
Packing	20 pcs / carton

DISPOSABLE SERIES

一次性用品系列



TOOTHPICKS SERIES 牙签系列



NATURAL COLOR TOOTHPICKS 本色扁木牙签

Model Code	100#	230#
Barcode	9555221301319	9555221301326
Packing	72 boxes / carton	144 boxes / carton

NATURAL COLOR TOOTHPICKS 本色扁木牙签

Model Code	300#	400#
Barcode	9555221301333	9555221301340
Packing	5 gross dz / carton	5 gross dz / carton



ROUND BAMBOO TOOTHPICKS 双头尖竹牙签

Model Code	250#	500#
Barcode	9555221303542	9555221305072
Packing	12 pcs / pkt; 144 boxes / carton	12 pcs / pkt; 72 boxes / carton



**ROUND BAMBOO TOOTHPICKS (BOTTLES)
双头尖竹牙签 (罐装)**

Model Code	255	505
Barcode	9555221308110	9555221308103
Packing	24 pack / carton	24 pack / carton



**PAPER WRAP WOODEN TOOTHPICKS
纸包装双头尖木牙签**

Model Code	1500#
Barcode	9555221303191
Packing	50 boxes / carton



BAMBOO SKEWER 竹串			
	4"	6"	8"
Model Code	SK100	SK150	SK200
Barcode	9555221303221	9555221305508	9555221305492
Packing	350 g ± 10% / bag 80 bags / carton	350 g ± 10% / bag 80 bags / carton	500 g ± 10% / bag 60 bags / carton

BAMBOO SKEWER 竹串				
	8"	8"	10"	12"
Model Code	SK201	SK202	SK250	SK300
Barcode	9555221310434	9555221310441	9555221305515	9555221305522
Packing	400 g ± 10% / bag 75 bags / carton	300 g ± 10% / bag 100 bags / carton	500 g ± 10% / bag 60 bags / carton	700 g ± 10% / bag 40 bags / carton



CHOPSTICKS 筷子			
	4.5	5.0	5.5
Model Code	BC45	BC50	BC55
Barcode	9555221308288	9555221308271	9555221308295
Packing	40 pairs / bag 50 or 100 bags / carton	40 pairs / bag 100 bags / carton	40 pairs / bag 100 bags / carton

*Disclaimer : Weight and quantity indicated just for reference, actual might varies



- 100% Virgin Material
- Non Toxic
- Eco Friendly



100
PCS *100 Pieces per box



- Food Grade
- Multipurpose
- Suitable for both hand
- Extra Thickness
- Good for more heavy duty work

DISPOSABLE PLASTIC PE GLOVE			
Model Code	PG100	PG101	PG102
Barcode	9555221310021	9555221310038	9555221310045
Packing	100 box/ctn	72 box/ctn	48 box/ctn



Standard
(PG100)



Heavy Duty
(PG101)



Super Heavy Duty
(PG102)

DISPOSABLE SERIES 一次性用品



VT10



VT15



VT20



VT35



MT169

PESTICIDE & TRAP SERIES 粘蝇/粘鼠板&捕鼠器					
	Fly Catcher	Mouse Trap	Quality Mouse Trap	Heavy Duty Mouse Trap	Mouse Trap
Model Code	VT10	VT15	VT20	VT35	MT169
Barcode	9555221307977	9555221307960	9555221307809	9555221307816	9555221308162
Packing	100 pcs / box; 20 boxes / carton	20 pcs / box; 200 pcs / carton	24 pcs / box; 144 pcs / carton	24 pcs / box; 144 pcs / carton	2 pcs / pkt; 100 pkt / carton



MOUSE TRAP SERIES 捕鼠器	
Model Code	MT148
Barcode	9555221310830
Size	72mm x 140mm x 75mm
Packing	200pcs / carton

CAUTION: Please be careful when handle the mouse trap. Dont touch the bait adjuster when the trap is engage.

How to use :



Turn the lower bait adjuster counterclockwise and pull it out to view.



Put the bait (ham, peanut, bread, etc.), then put it back.



Push down on the back of the mouse trap press until it engages with the bottom.



Place it in a place where rats often lay eggs in holes, corners, sides of doors, etc. The distance between the placement position must be 1cm away.

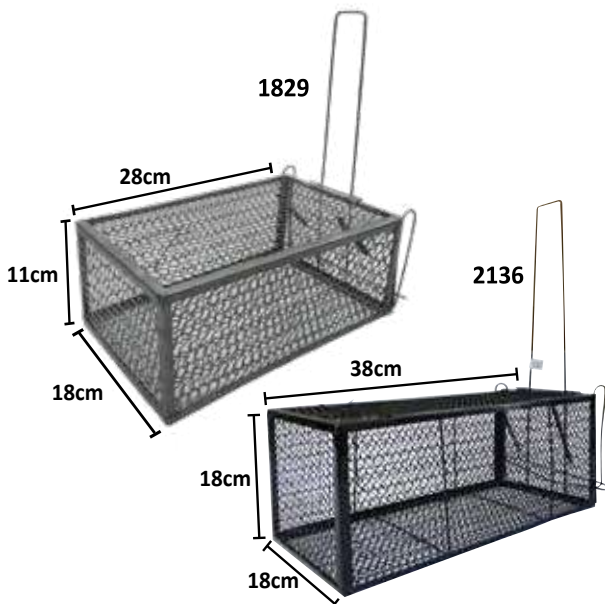

MOUSE TRAP SERIES 捕鼠器		
	Large Mouse Trap	XL Mouse Trap
Model Code	1829	2136
Barcode	9555221307274	9555221307342
Size	28cm (L) x 11cm (H) x 18cm (W)	38cm (L) x 18cm (H) x 18cm (W)
Packing	20 pcs / carton	16 pcs / carton
Color		

CANDLES SERIES

蜡烛系列



209557

259557

6 PCS WHITE CANDLE 蜡烛			
	20g	25g	28g
Model Code	209557	259557	289557
Barcode	9555221304167	9555221303429	9555221303252
Packing	100 boxes / carton	100 boxes / carton	50 boxes / carton



409557

687

686

6 PCS WHITE CANDLE 白蜡烛			
	40g	15g	15g
Model Code	409557	687	686
Barcode	9555221303245	9555221303269	9555221303276
Packing	50 boxes / carton	100 boxes / carton	100 boxes / carton



TEA CANDLE 餐烛		
Model Code	10100	1010
Barcode	9555221305706	9555221303436
Packing	24 boxes / carton	100 boxes / carton



10100



1010

BAMBOO STEAMER & BASKET SERIES

竹蒸籠&竹籃子系列

HOUSEHOLD





BAMBOO STEAMER WITH ALUMINIUM FRAME & LID 铝边竹蒸笼及竹蒸笼盖		
MODEL	DESCRIPTION	PACKING (unit/ctn)
5"	Steamer	300
5"	Lid	300
6"	Steamer	100
6"	Lid	200
7"	Steamer	100
7"	Cover	200
8"	Steamer	60
8"	Lid	120
10"	Steamer	40
10"	Lid	60
12"	Steamer	40
12"	Lid	80
14"	Steamer	20
14"	Lid	34
16"	Steamer	10
16"	Lid	30
18"	Steamer	10
18"	Lid	30
20.5"	Steamer	5
20.5"	Lid	10



***Handmade product, thus size might varies, please allow 5mm to 10mm variance.**





BAMBOO STEAMER WITH YELLOW RUBBER FRAME & LID
黄色塑边竹蒸笼及黄色塑边竹蒸笼盖

MODEL	DESCRIPTION	PACKING (unit/ctn)
PS5"	Steamer (Yellow Slate)	300
PC5"	Lid (Yellow Slate)	300
PS6"	Steamer (Yellow Slate)	100
PC6"	Lid (Yellow Slate)	400
PS7"	Steamer (Yellow Slate)	100
PC7"	Lid (Yellow Slate)	200
PS8"	Steamer (Yellow Slate)	60
PC8"	Lid (Yellow Slate)	120
PS10"	Steamer (Yellow Slate)	60
PC10"	Lid (Yellow Slate)	150
PS12"	Steamer (Yellow Slate)	40
PC12"	Lid (Yellow Slate)	150



*Handmade product, thus size might varies, please allow 5mm to 10mm variance.



BAMBOO STEAMER WITH GREEN RUBBER FRAME & LID
青色塑边竹蒸笼及青色塑边竹蒸笼盖

MODEL	DESCRIPTION	PACKING (unit/ctn)
PS5"	Steamer (Green Slate)	300
PC5"	Lid (Green Slate)	300
PS6"	Steamer (Green Slate)	100
PC6"	Lid (Green Slate)	400

*Handmade product, thus size might varies, please allow 5mm to 10mm variance.

BAMBOO STEAMER WITH STAINLESS STEEL FRAME & LID
钢口竹蒸笼及竹蒸笼盖

MODEL	DESCRIPTION	PACKING (unit/ctn)
SS5"	Steamer	300
SS5"	Lid	300
SS6"	Steamer	100
SS6"	Lid	100
SS6.5"	Steamer	60
SS6.5"	Lid	60
SS7"	Steamer	100
SS7"	Lid	100
SS8"	Steamer	60
SS8"	Lid	60
6.5"	Steamer	100
6.5"	Lid	100



*Handmade product, thus size might varies, please allow 5mm to 10mm variance.



BAMBOO BASKET 竹罗筐	
Model Code	Packing (Unit / Carton)
BB61 - BB40	5 头 pcs per set / 18 set / carton
BB61 - BB56	2 头 pcs per set / 24 set / carton

- Diameter might varied ± 2 cm
- BB61 ϕ 61CM \pm 2CM
 - BB56 ϕ 56CM \pm 2CM
 - BB50 ϕ 50CM \pm 2CM
 - BB47 ϕ 47CM \pm 2CM
 - BB40 ϕ 40CM \pm 2CM

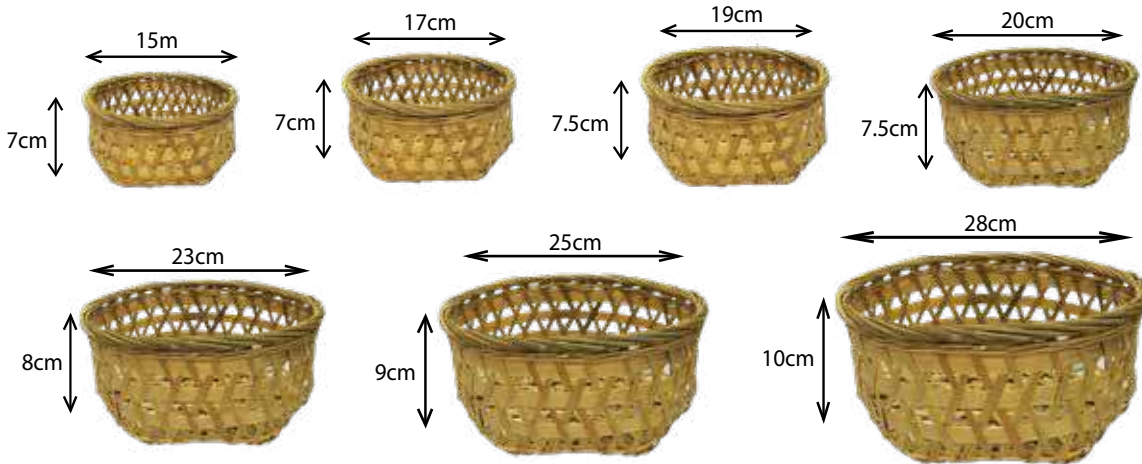

*Bamboo basket for steam sponge cakes, ma lai koh and etc...

BAMBOO BASKET FOR CAKE BAKING 五头竹糕篮	
Model Code	Packing (Unit / Carton)
S2	2 头 pcs per set (6" / 7")
S3	3 头 pcs per set (6" / 7" / 8")
S5	5 头 pcs per set (17" / 20" / 23" / 25" / 28")



*Disclaimer: Measurement might slightly varies with actual product.

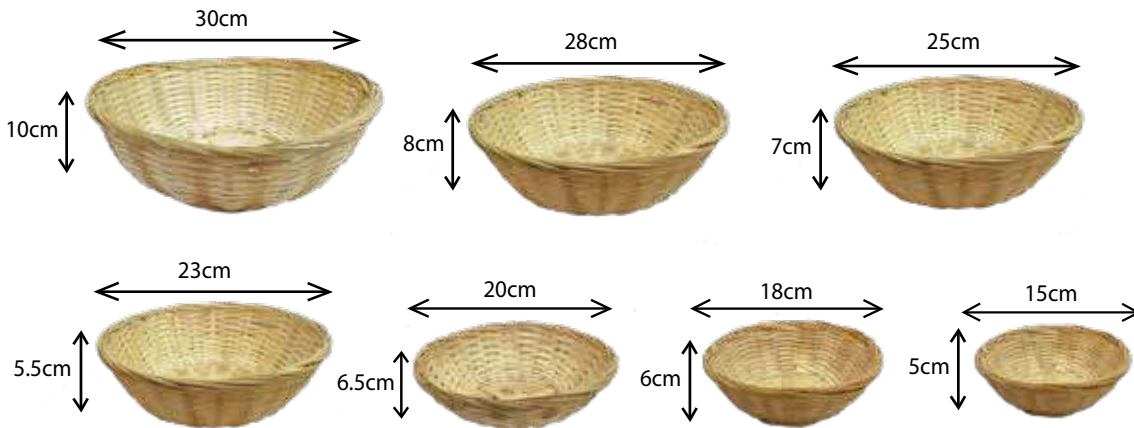

BAMBOO ROTI ROUND BASKET 竹圓形面包籃		
Model Code	Description	Packing (unit / carton)
BBR6	6" (15cm) round bamboo basket	1000 pcs
BBR7	7" (18cm) round bamboo basket	1000 pcs
BBR8	8" (20cm) round bamboo basket	500 pcs
BBR9	9" (23cm) round bamboo basket	500 pcs
BBR10	10" (25cm) round bamboo basket	500 pcs
BBR11	11" (28cm) round bamboo basket	300 pcs
BBR12	12" (30cm) round bamboo basket	300 pcs

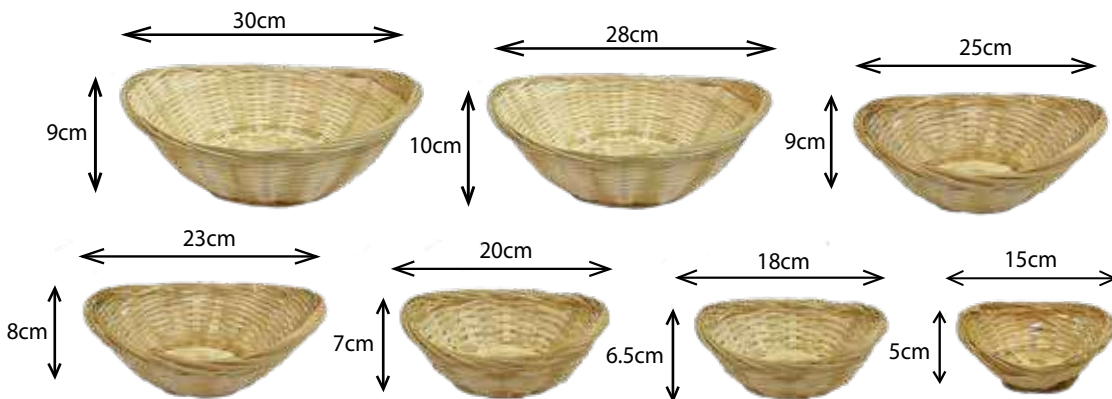

BAMBOO ROTI OVAL BASKET 竹蛋形面包籃		
Model Code	Description	Packing (unit / carton)
BRE6	6" (15cm) oval bamboo basket	1000 pcs
BRE7	7" (18cm) oval bamboo basket	1000 pcs
BRE8	8" (20cm) oval bamboo basket	500 pcs
BRE9	9" (23cm) oval bamboo basket	500 pcs
BRE10	10" (25cm) oval bamboo basket	500 pcs
BRE11	11" (28cm) oval bamboo basket	300 pcs
BRE12	12" (30cm) oval bamboo basket	300 pcs

*Minimum order of 20pcs/bag.

*Disclaimer: Measurement might slightly varies with actual product.



RAYACO®

大大牌

☎ : 603 - 6091 9588, 603 - 6091 8630

☎ : 603 - 6091 9618, 603 - 6091 9619

✉ : rayaco@rayaco.com.my

🌐 : www.rayaco.com.my

