

大大牌

RAYACO®

• TOGETHER, WE CLEAN BETTER •



**HARDLINE AND
HOUSEHOLD PLASTIC
PRODUCTS**

ABOUT US



Established in 1987, **RAYACO®** has become one of the leading household brand name in Malaysia. In addition, we also have VIP, VIP MEDPRO and RAYACO PRO brands. As a pioneer in the broom and brush, and household product supply industry in the country, we have come through changes and challenges, from the technology and exposure we acquired over the past three decades, to successfully establish ourselves as one of the leading names in the household products industry providing full range of cleaning products for household and industry needs under various brands name. Our range of products includes broom, brush, mop scouring pad with sponge, scouring pad, household sponge, household plastic product etc.

To pursue continuous advancement, at the year 2002, we expanded and moved into a modern factory in Rawang Integrated Park with total build up area of 210,000 square feet and equipped with new facilities and equipment to meet the increasing market demand as well as further strengthen our position in the household supplies industry. In 2016, to meet the increasing demand of the market for the foreseeable future, we acquired 2 pieces of land and factory, which almost double up our total build up area to 400,000 square feet. In addition, our newly build warehouse expected to be ready at the end of year 2019, this expanded production and warehousing capability will aid our growth strongly and organically at least for the next 5 years.

We believe in a clean and healthy environment for household as well as industrial premises, therefore, **RAYACO®** brand and our other brand of cleaning products ensures value for money purchase as well as comfort usage. Thus we come up with our own motto:

"TOGETHER, WE CLEAN BETTER"

To continue our excellent in cleaning industry and to tap and expand our expertise in plastic and metal technology, we are transforming ourselves into providing a full range of household product supplier.

We are committed to produce excellent quality, user friendly and reliable household products. Our innovation on product design and continuous improvement on product quality has guaranteed many satisfactions of our customers.

We are one of the few manufacturers who can supply full range of above products to our distributors as well as retailers which carry our own brand name. We also provide OEM services as well which include some worldwide brand name.

We believe that through our innovation in product design and continuous improvement of product quality, we have ensured a lot of customer satisfaction. Currently, we are supplying to 18 countries worldwide, include Middel east, Southeast Asia, Africa, East Asia, as well as Northern America.

We sincerely hope that we can be your partners and be part of your supply chain provider. Do send us enquiry and we will try our best to fulfil your needs. As our motto speaks:

"TOGETHER, WE CLEAN BETTER" And we believe together, we will be better!

Looking forward your journey with us in the near term.

New Office & Warehouse



Nationwide Logistic Team



01

PAIL, BASIN, BIN & BUCKET
水桶, 塑料盆, 垃圾桶与纸篓系列

RAYACO®





PLASTIC BASIN 平底塑料盆				
	7"	8.5"	10"	12"
Model Code	6070	6085	6100	6120
Barcode	9555221304679	9555221304686	9555221304693	9555221305560
Packing	24 dzs / carton	24 dzs / carton	24 dzs / carton	12 dzs / carton
Size (cm)	18 (∅) x 6.5 (H)	21 (∅) x 7.5 (H)	24.5 (∅) x 8.5 (H)	30 (∅) x 11 (H)
Color	●●●●	●●●●	●●●●	●●●●



PLASTIC BASIN 平底塑料盆				
	14"	16"	18"	20"
Model Code	6140	6160	6180	6200
Barcode	9555221304907	9555221304709	9555221305577	9555221306200
Packing	8 dzs / carton	6 dzs / carton	48 pcs / carton	36 pcs / carton
Size (cm)	35 (∅) x 13 (H)	40 (∅) x 14.5 (H)	45 (∅) x 21.5 (H)	49 (∅) x 24.5 (H)
Color	●●●●	●●●●	●●●●	●●●●



PLASTIC BASIN WITH HANDLE 双耳平底塑料盆			
	22"	24"	26"
Model Code	6220	6240	6260
Barcode	9555221305942	9555221305959	9555221305966
Packing	24 pcs / carton	18 pcs / carton	15 pcs / carton
Size (cm)	55 (∅) x 26 (H)	61 (∅) x 29 (H)	66 (∅) x 32 (H)
Color	● ●	● ●	● ●



PLASTIC BASIN WITH HANDLE 双耳平底塑料盆		
	28"	32"
Model Code	6280	6320
Barcode	9555221307083	9555221307076
Packing	8 pcs / carton	8 pcs / carton
Size (cm)	70 (∅) x 32 (H)	80 (∅) x 34 (H)
Color	● ●	● ●

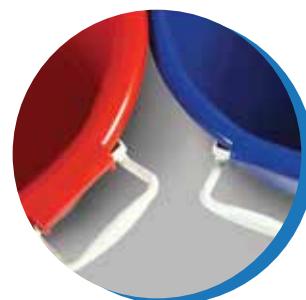



ECONOMY PLASTIC BASIN 经济平底塑料盆				
	14"	16"	18"	20"
Model Code	V6140	V6160	V6180	V6200
Barcode	9555221305232	9555221305249	9555221305638	9555221305256
Packing	8 dzs / carton	6 dzs / carton	48 dzs / carton	36 dzs / carton
Size (cm)	35 (∅) x 13 (H)	40 (∅) x 14 (H)	45 (∅) x 21.5 (H)	49.5 (∅) x 24 (H)
Color	● ● ● ●	● ● ● ●	● ● ● ●	● ● ● ●

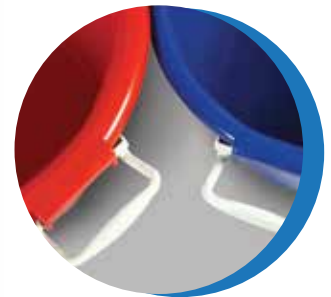

Heavy-duty handle
Easy to carry

PLASTIC BASIN WITH HANDLE 双耳平底塑料盆		
	20" (S)	24" (L)
Model Code	EB6200	EB6240
Barcode	9555221304921	9555221304914
Size	510mm(L) x 255mm(H)	610mm(L) x 280mm(H)
Packing	18 pcs / carton	24 pcs / carton
Color	● ●	● ●





MULTIPURPOSE BUCKET WITH COVER 多用途盖桶				
	15L (1 GALLON)	20L (2 GALLON)	25L (3 GALLON)	30L (4 GALLON)
Model Code	9400-2	9500-2	9600-2	9800-2
Barcode	9555221305195	9555221305164	9555221305171	9555221305188
Packing	12 pcs / carton	12 pcs / carton	12 pcs / carton	12 pcs / carton
Size (cm)	31 (∅) x 31 (H)	33.5 (∅) x 33.5 (H)	35.5 (∅) x 36 (H)	37.5 (∅) x 38 (H)
Color				





BUCKET COVER 桶盖				
	15L (1 GALLON)	20L (2 GALLON)	25L (3 GALLON)	30L (4 GALLON)
Model Code	9402	9502	9602	9802
Packing	48 pcs / carton	48 pcs / carton	48 pcs / carton	48 pcs / carton
Size (cm)	31.5 (∅)	34 (∅)	36 (∅)	38 (∅)
Color				



PAIL 水桶				
	2L (0.5 GALLON)	4L (1 GALLON)	8L (2 GALLON)	11L (3 GALLON)
Model Code	9050	9100	9200	9300
Barcode	9555221306512	9555221304273	9555221304280	9555221304297
Packing	48 pcs / carton	48 pcs / carton	48 pcs / carton	36 pcs / carton
Size (cm)	16 (∅) x 13.5 (H)	20.5 (∅) x 16 (H)	25.5 (∅) x 25 (H)	28.5 (∅) x 28.5 (H)
Color				



PAIL 水桶				
	15L (4 GALLON)	20L (5 GALLON)	25L (6 GALLON)	30L (8 GALLON)
Model Code	9400	9500	9600	9800
Barcode	9555221303566	9555221303573	9555221303580	9555221303597
Packing	36 pcs / carton	24 pcs / carton	24 pcs / carton	24 pcs / carton
Size (cm)	31 (∅) x 31 (H)	33.5 (∅) x 33.5 (H)	35.5 (∅) x 36 (H)	37.5 (∅) x 38 (H)
Color				



ECONOMY PAIL 经济水桶				
	4L (1 GALLON)	8L (2 GALLON)	11L (3 GALLON)	15L (4 GALLON)
Model Code	V1000	V2000	V3000	V4000
Barcode	9555221305201	9555221305669	9555221305539	9555221304778
Packing	144 pcs / carton	144 pcs / carton	36 pcs / carton	36 pcs / carton
Size (cm)	20.5 (∅) x 16 (H)	25 (∅) x 25 (H)	28 (∅) x 25 (H)	31 (∅) x 30 (H)
Color				



ECONOMY PAIL 经济水桶			
	20L (5 GALLON)	25L (6 GALLON)	30L (8 GALLON)
Model Code	V5000	V6000	V8000
Barcode	9555221304884	9555221305225	9555221306260
Packing	24 pcs / carton	24 pcs / carton	24 pcs / carton
Size (cm)	33.5 (∅) x 34 (H)	36 (∅) x 36 (H)	37.5 (∅) x 38 (H)
Color			



ECONOMY MOP PAIL 经济地拖水桶		
	15L (4 GALLON)	20L (5 GALLON)
Model Code	V4000-1	V5000-1
Packing	24 pcs / carton	18 pcs / carton
Size (cm)	31 (∅) x 30 (H)	33.5 (∅) x 34 (H)
Color		

COLOR DUSTBIN WITH SWING LID



Push Cover



Features :

- Lid Can be removed For Cleaning Purpose
- Suitable for office, factory, malls, schools, parks, house.
- Easy to throw rubbish and save more space



DUSTBIN WITH SWING LID 塑料推盖拉

	15L	25L	40L	60L
Model Code	RI20A	RI30A	RI40A	RI60A
Barcode	9555221311554	9555221311561	9555221311578	9555221311585
Size (cm)	48cm (H) x 23cm (L) x 32cm (W)	55cm (H) x 26.2cm (L) x 36.7cm (W)	60.5cm (H) x 29.3cm (L) x 40cm (W)	75.5cm (H) x 32.5cm (L) x 45.5cm (W)
Packing	12 sets / carton	12 sets / carton	6 sets / carton	6 sets / carton
Color	●●●	●●●	●●●	●●●

DUSTBIN WITH SWING LID



Push Cover



Features :

- Lid Can be removed For Cleaning Purpose
- Suitable for office, factory, malls, schools, parks, house.
- Easy to throw rubbish and save more space



DUSTBIN WITH SWING LID 塑料推盖拉				
	20L	30L	40L	60L
Model Code	RI20B	RI30B	RI40B	RI60B
Barcode	955522130373	9555221310380	955522130403	9555221310410
Size (cm)	51cm (H) x 18cm (L) x 35cm (W)	58cm (H) x 19cm (L) x 38cm (W)	62cm (H) x 24cm (L) x 31cm (W)	77cm (H) x 22cm (L) x 45cm (W)
Packing	12 sets / carton	12 sets / carton	6 sets / carton	6 sets / carton
Color	●●	●●	●	●

DUSTBIN WITH SWING LID



Push cover



* COVER SIZE FOR RI-15C & RI-20C

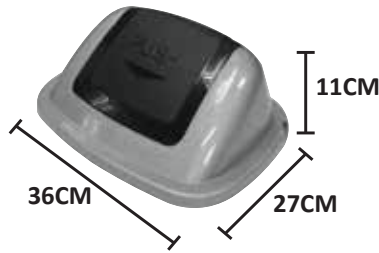

* COVER SIZE FOR RI-40C & RI-60C

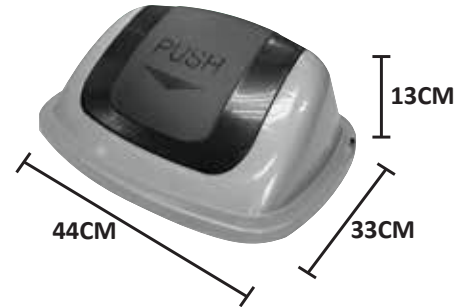

Features :

- Lid can be removed for cleaning purpose.
- Suitable for office, factory, malls, schools, parks.
- Easy to throw rubbish and save more space.

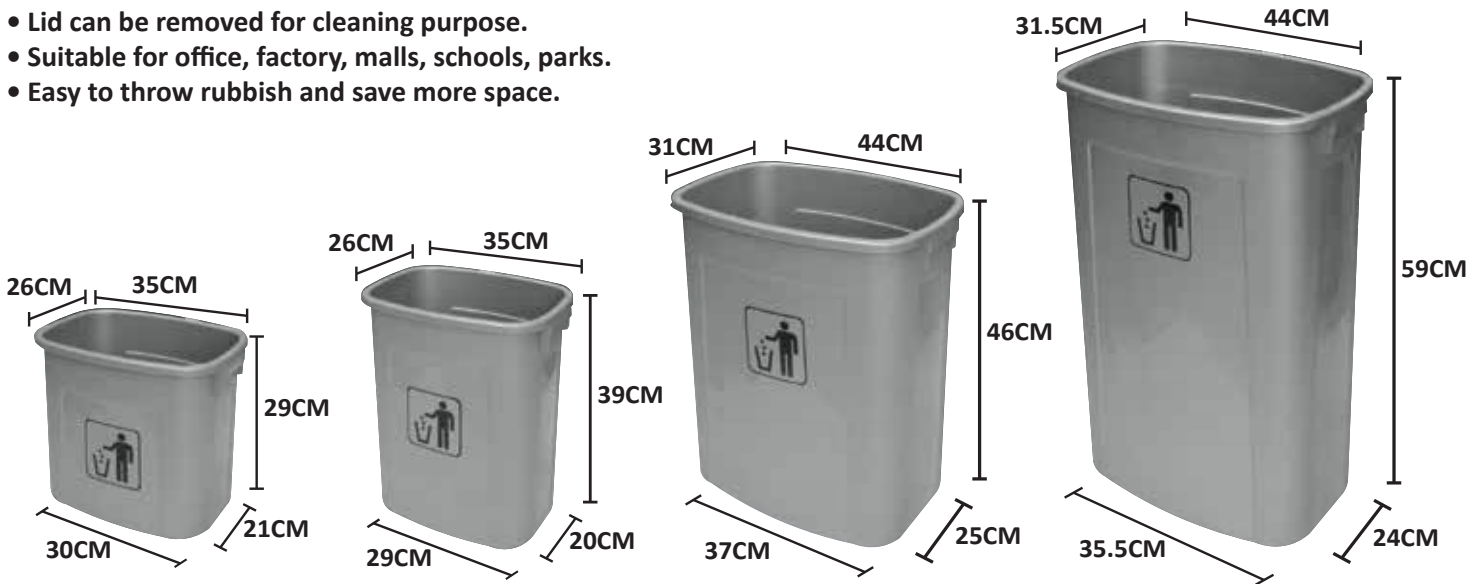

DUSTBIN WITH SWING LID 塑料推盖垃圾桶				
	15L	20L	40L	60L
Model Code	RI-15C	RI-20C	RI-40C	RI-60C
Barcode	9555221311851	9555221311868	9555221311875	9555221311882
Size	40cm (H) x 30cm (W) x 21cm (L)	50cm (H) x 29cm (W) x 20cm (L)	59cm (H) x 37cm (W) x 25cm (L)	72cm (H) x 33.5cm (W) x 24cm (L)
Packing	12 sets / carton	12 sets / carton	12 sets / carton	12 sets / carton
Color	●	●	●	●



STYLISH ROUND STEP BIN 时尚圆形脚踏垃圾桶			
	15L	30L	45L
Model Code	7040	7080	7120
Barcode	9555221307465	9555221307168	9555221307830
Size	28.5cm (ø) x 31cm (H)	31cm (ø) x 39.5cm (H)	39.5cm (ø) x 53.5cm (H)
Packing	28 units / carton	6 units / carton	4 units / carton
Color	●●●●●		



STYLISH SQUARE STEP BIN 时尚方形脚踏垃圾桶			
	15L	30L	45L
Model Code	7044	7084	7124
Barcode	9555221306697	9555221305614	9555221306253
Size	29.5cm (H) x 21cm (W) x 25.5/23cm (D)	41cm (H) x 25cm (W) x 31/28.5cm (D)	52.5cm (H) x 32.5cm (W) x 39/35.5cm (D)
Packing	8 units / carton	6 units / carton	4 units / carton
Color	●●●●●		



68L STEP DUSTBIN WITH LID & WHEELS 双轮脚踏垃圾桶	
Model Code	7154
Barcode	9555221307663
Size	61cm (H) x 48.5cm (L) x 48cm (W)
Packing	3 units / carton
Color	●●●



STEP DUSTBIN			
	100L	45L	30L
Model Code	RI-100G	7454	7304
Barcode	95552213099667	9555221304242	9555221304235
Size	80cm (H) x 44.3cm (W) x 48cm (D)	59cm (H) x 42cm (W) x 39.5cm (D)	43cm (H) x 42cm (W) x 39.5cm (D)
Packing	3 pcs / carton	3 pcs / carton	3 pcs / carton
Color	●●		

PAIL, BASIN, BUCKET & BIN SERIES 水桶, 塑料盆, 纸篓与垃圾桶系列



大大牌

Round top surface to avoid water retention.

Both sides handle for easy carrying.



All 3 bins can paired with trolley 3017, for easier carry and moving.

MULTIPURPOSE BIN WITH HANDLE 提手多用途水桶 (黑色)

	48L	60L	80L
Model Code	V8120-2	V8150-1	V8800-1
Barcode	9555221305881	9555221307403	9555221306208
Size	42.5cm (ø) x 51cm (H)	50cm (ø) x 62cm (H)	50cm (ø) x 73cm (H)
Packing	12 pcs / carton; 120 pcs / pallet	12 pcs / carton; 120 pcs / pallet	12 pcs / carton; 120 pcs / pallet
Color	●		



Both sides handle for easy carrying.



Round top surface to avoid water retention.

MULTIPURPOSE BIN WITH HANDLE 提手多用途水桶

	48L	60L
Model Code	8120	8150-1
Barcode	9555221305874	9555221307410
Size	42.5cm (ø) x 51cm (H)	50cm (ø) x 62cm (H)
Packing	12 pcs / carton; 120 pcs / pallet	12 pcs / carton; 120 pcs / pallet
Color	● ●	



Both sides handle for easy carrying



Round top surface to avoid water retention

MULTIPURPOSE BUCKET WITH HANDLE 提手多用途水桶 (黑色)		
	80 L	120 L
Model Code	V8800-1S	V8320-1
Barcode	9555221306215	9555221307731
Size	42.5cm (ø) x 73cm (H)	60cm (ø) x 73cm (H)
Packing	12 pcs / carton; 48 pcs / pallet	6 pcs / carton; 30 pcs / pallet
Color	●	●

MULTIPURPOSE BUCKET WITH HANDLE 提手多用途水桶		
	80 L	120 L
Model Code	8800-1	8320-1
Barcode	9555221306222	9555221306802
Size	48cm (ø) x 73cm (H)	60cm (ø) x 73cm (H)
Packing	12 pcs / carton; 48 pcs / pallet	6 pcs / carton; 30 pcs / pallet
Color	●●	●●



Special design ashtray



Customer's logo can be printed upon request



Double sided cover

80 LITRE DOME TOP DOUBLE PUSH IN TRASHBIN 80L拱顶双边盖垃圾桶		80 LITRE DOME TOP DOUBLE PUSH IN TRASHBIN (BLACK) 80L拱顶双边盖垃圾桶 (黑色)	
Model Code	8800-2	V8800-2	
Barcode	9555221307724	9555221307731	
Size (cm)	48(∅) x 98.5(H)	48(∅) x 98.5(H)	
Packing	12 units / carton	12 units / carton	
Color	● ● ●	●	



240Y



120Y



7454Y



7304Y

BIOHAZARD MARKED MEDICAL STEP BIN 脚踏医疗垃圾桶		
	30 L	45 L
Model Code	7304Y	7454Y
Barcode	9555221304235	9555221304242
Measurement (mm)	43(H) x 42(W) x 39.5(D)	59(H) x 42(W) x 39.5(D)
Packing	3 pcs	3 pcs
Color	●	●

BIOHAZARD MARKED MEDICAL WASTE BIN 医疗垃圾桶		
	120 Y	240 Y
Model Code	120 Y	240 Y
Barcode	9555221311189	9555221311196
Volume (Litre)	120	240
Weight (Kg)	7.5	13.2
Measurement (mm)	550(H) x 470(W) x 950(D)	720(H) x 570(W) x 1050(D)
Max Load (Kg)	50	90
Packing	3	3
Color	●	●

* Note 1: Customize color and logo is available upon request, Terms & Conditions apply
 Note 2: Installation not included, wheel sets can be sold separately



COMMERCIAL RECYCLED DUSTBIN 商用垃圾桶

Model Code	RI-120OR	RI-240OR	RI-120B	RI-240B	RI-120BR	RI-240BR
Barcode	9555221309117	9555221309636	9555221309094	9555221309629	95552213099100	9555221309612
Volume (Litre)	120	240	120	240	120	240
Weight (Kg)	7.3	10.6	7.3	10.6	7.3	10.6
Measurement (mm)	550X470X900	710X560X1010	550X470X900	710X560X1010	550X470X900	710X560X1010
Max Load (Kg)	45	75	45	75	45	75
Packing	3	3	3	3	3	3
Color	●	●	●	●	●	●

* Note 1: Customize color and logo is available upon request, Terms & Conditions apply
 Note 2: Installation not included, wheel sets can be sold separately



RI-240U



RI-120U



RI-100U

COMMERCIAL PEDAL DUSTBIN 商用垃圾桶

Model Code	RI-100U	RI-120U	RI-240U
Barcode	9555221311592	9555221309209	9555221309216
Volume (Litre)	100	120	240
Weight (Kg)	6.8	9.8	16
Measurement (mm)	565x475x850	560x480x920	730x580x1080
Max Load (Kg)	40	50	96
Packing	3	3	3
Color	●	●	●

* Feature:

- Manufactured and tested to EN840-DIN30700 standard.
- HDPE material, extra additives for UV, Cold and Chemical Resistance.
- Steel Galvanized wheel axle (2 wheel bins) with solid wheel tyres.

* Remark: Wheel Replacement Available upon wear and tear.



RI-100A



RI-120A

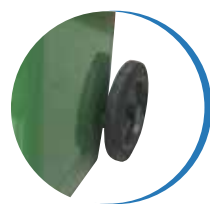

RI-240A



RI-120G



RI-240G

COMMERCIAL DUSTBIN 商用垃圾桶

Model Code	RI-100A	RI-120A	RI-120G	RI-240A	RI-240G
Barcode	9555221309711	9555221309087	9555221309698	9555221309124	9555221309131
Volume (Litre)	100	120	120	240	240
Weight (Kg)	6.3	7.3	7.5	10.6	13.2
Measurement (mm)	530X470X810	550X470X900	572X482X950	710X560X1010	720X570X1050
Max Load (Kg)	40	45	50	70	90
Packing	3	3	3	3	3
Color	●	●	●	●	●

* Note 1: Customize color and logo is available upon request, terms & conditions apply.

Note 2: Installation not included, wheel sets can be sold separately.

Remark: Wheel Replacement Available upon wear and tear.



COMMERCIAL HEAVY DUTY DUSTBIN 商用垃圾桶

Model Code	RI-660A	RI-660G	RI-1100G
Barcode	9555221309148	9555221309148	9555221309605
Volume (Litre)	660	660	1100
Weight (Kg)	42	42	50
Measurement (mm)	770 X 1350 X 1220	770 X 1350 X 1220	1040 X 1360 X 1300
Max Load (Kg)	300kgs+-	300kgs+-	500kgs+-
Packing	1	1	1
Color	■	■	■

*Remark: Wheel Replacement Available upon wear and tear.



**With 2 clip

120L FOR RI120A / RI120G ONLY	
For Model	120L
Barcode	9555221309698



**With 2 clip

240L FOR RI240A / RI240G ONLY	
For Model	240L
Barcode	9555221309124

Wheel Width : 4 cm



WHEEL SETS FOR DUSTBIN	
For Model	100 L / 120 L
Pcs Per Set	2 rubber wheels + 1 iron rod

Wheel Width : 5 cm

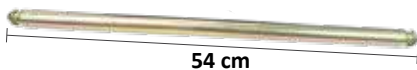

WHEEL SETS FOR DUSTBIN	
For Model	240 L
Pcs Per Set	2 rubber wheels + 1 iron rod

Wheel Width : 5 cm



DUSTBIN WHEELS	
For Model	1100 L
Pcs Per Set	2 fix + 2 brake

Wheel Width : 4.5 cm



DUSTBIN WHEELS	
For Model	660 L
Pcs Per Set	2 fix + 2 brake



PAPER BASKET WITH RING (S) 纸篓 (小)		PAPER BASKET WITH RING (L) 纸篓 (大)	
Model Code	7300-1	7400-1	
Barcode	9555221304754	9555221304495	
Size (mm)	280(D) x 275(H)	310(D) x 315(H)	
Packing	36 pcs / pkt; 144 pcs / carton	36 pcs / pkt; 72 pcs / carton	
Color	● ●	● ●	



WASTE BASKET 废纸篓	
Model Code	V730
Barcode	9555221305096
Size (mm)	275(D) x 285(H)
Packing	3 dzs / pkt; 12 dzs / carton
Color	● ●

02

BANQUET TABLE & CHAIR SERIES
折叠桌子及椅子系列





BANQUET TABLE SERIES



- Easy to fold and setup.
- Save storage space
- Hand carry and transport friendly.

High adjustable and automatic gravity-based leg locking prevent accident collapsing.

HEIGHT ADJUSTABLE TABLE		
Model Code	AT80W	AT80R / AT80B
Barcode	9555221311127	9555221311479
Kgs	4.5 / 4.1 Kgs	4.5 / 4.1 Kgs
Size	76.5cm x 50cm x 48/65/74cm	76.5cm x 50cm x 48/65/74cm
Load Bearing	60kgs	60kgs
Packing	30 pcs / pallet	30 pcs / pallet
Color	○	● ○



*Maximum 60KGS static load

BANQUET TABLE SERIES

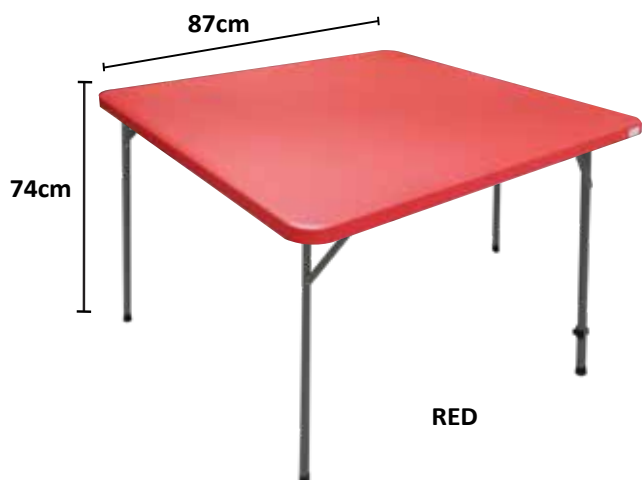

- Easy to fold and setup.
- Save storage space
- Hand carry and transport friendly.

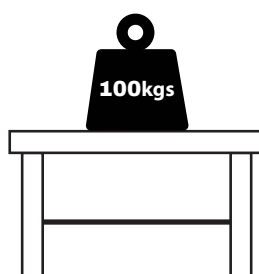

**Maximum 100KGS static load*



- Features:
- Very durable and unbreakable
 - Suitable for bbq, school, study and etc.

3FT SQUARE TABLE			
Model Code	ST90W	ST90R	ST90B
Barcode	9555221311110	9555221311462	9555221311943
Kgs	8.7 / 8 Kgs	8.7 / 8 Kgs	8.7 / 8 Kgs
Size	87cm x 87cm x 74cm	87cm x 87cm x 74cm	87cm x 87cm x 74cm
Load Bearing	100kgs	100kgs	100kgs
Packing	20 pcs / pallet	20 pcs / pallet	20 pcs / pallet
Color	○	●	○



BANQUET TABLE SERIES

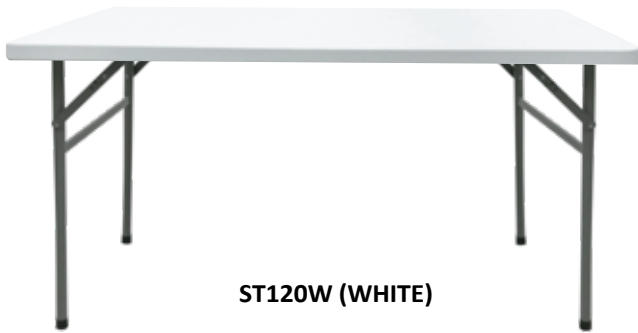
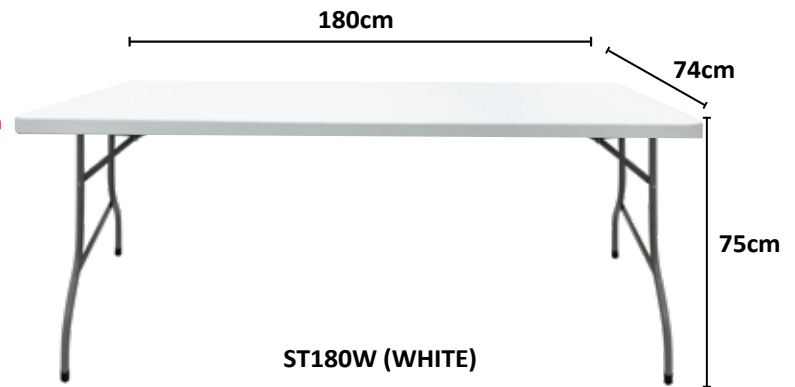

	4 X 2 FT SOLID TABLE	4 X 2 FT SOLID TABLE	4 X 2 FT SOLID TABLE	6 FT SOLID TABLE	6 FT SOLID TABLE
Model Code	ST120R	ST120W	ST120B	ST180W	ST180B
Barcode	9555221311455	9555221311103	9555221311929	9555221311356	9555221311936
Kgs	8 / 7.5 kgs	8 / 7.5 Kgs	13 / 12.5 Kgs	13 / 12.5 Kgs	13 / 12.5 Kgs
Size	122cm x 60cm x 74cm	122cm x 60cm x 74cm	180cm x 75cm x 74cm	180cm x 75cm x 74cm	180cm x 75cm x 74cm
Load Bearing	160kgs	160kgs	160kgs	160kgs	160kgs
Packing	20 pcs / pallet	20 pcs / pallet	20 pcs / pallet	20 pcs / pallet	20 pcs / pallet
Color	●	○	○	○	○

BANQUET TABLE SERIES

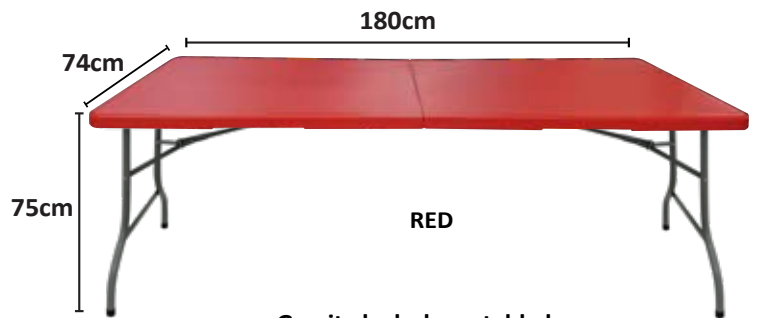
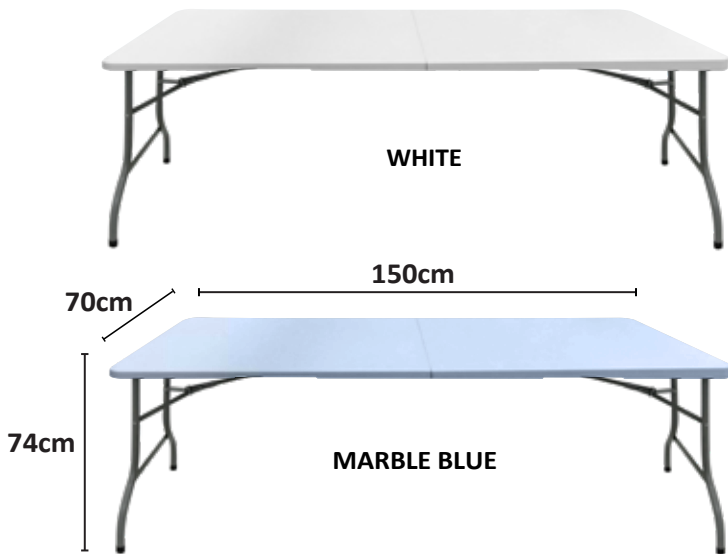

Foldable

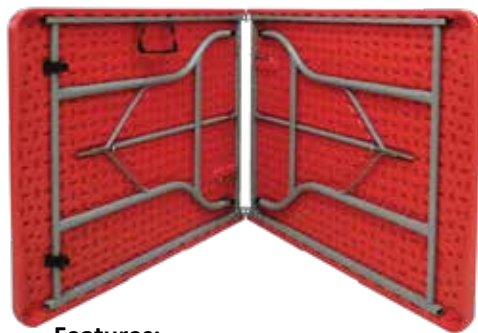

Gravity locks keep table legs open when upright, and slide out of the way for folding.

With carry handle

- Easy to fold and setup.
- Hand carry and transport friendly.

- Features:
- Very durable and unbreakable
 - Suitable for bbq, school, study and etc.



*Save storage space.



*Maximum 160KGS static load

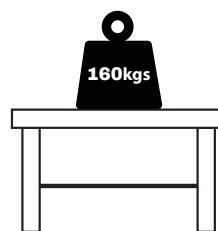

- Features:
- Very durable and unbreakable.
 - Suitable for bbq, school, study and etc.

FOLDING TABLE				
Model Code	FT150W	FT150R / FT150B	FT180W	FT180R / FT180B
Barcode	9555221311097	9555221311431	9555221311066	9555221311073
Kgs	11 / 10.8 Kgs	11 / 10.8 Kgs	13 / 12.8 Kgs	13 / 12.8 Kgs
Size	153.5cm x 70cm x 74cm	153.5cm x 70cm x 74cm	180cm x 75cm x 74cm	180cm x 75cm x 74cm
Load Bearing	160kgs	160kgs	160kgs	160kgs
Packing	20 pcs / pallet	20 pcs / pallet	20 pcs / pallet	20 pcs / pallet
Color	○	● ○	○	● ○



BANQUET TABLE SERIES



MARBLE BLUE



WHITE

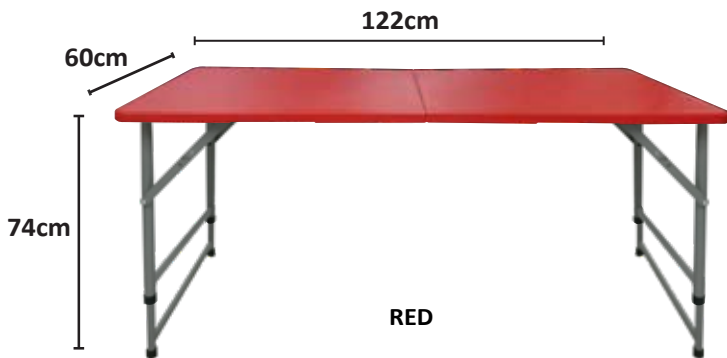

RED



**Maximum 160KGS static load*



**Save storage space.*

- Easy to fold and setup.
- Hand carry and transport friendly.
- Save storage space.

Note: Please allow 1-3cm difference due to manual measurement.

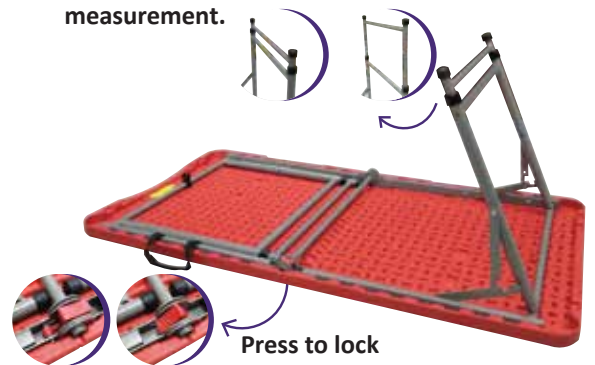

4 FT SOLID TABLE		
Model Code	FT120W	FT120R / FT120B
Barcode	9555221311080	9555221311448
Kgs	9 / 8.5 Kgs	9 / 8.5 Kgs
Size	122cm x 60cm x 53/74cm	122cm x 60cm x 53/74cm
Load Bearing	160kgs	160kgs
Packing	20 pcs / pallet	20 pcs / pallet
Color	○	● ○

Features:

- Height adjustable table.
- Very durable and unbreakable.
- Suitable for bbq, school, study and etc.

BANQUET TABLE SERIES

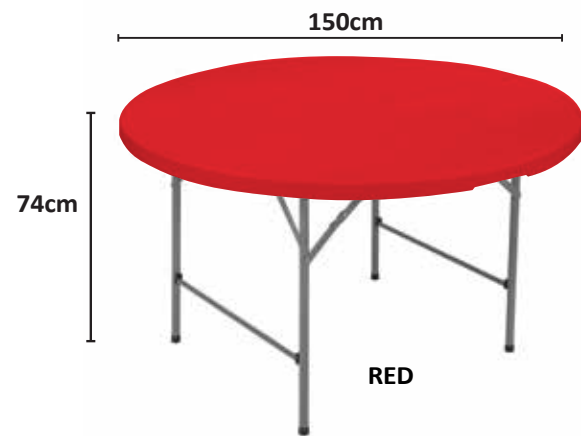

*Maximum 160KGS static load



-Save storage space.
-Hand carry and transport friendly



Easy to fold and setup

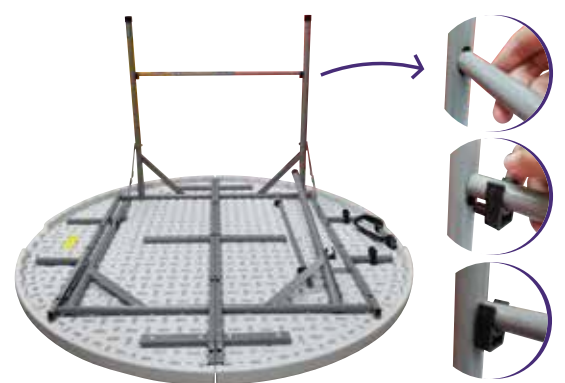

FOLDABLE ROUND TABLE				
Model Code	RT120W	RT120R/RT120B	RT150W	RT150R/RT150B
Barcode	9555221311363	9555221311653	9555221311370	9555221311660
Size	120cm x 74cm	120cm x 74cm	150cm x 74cm	150cm x 74cm
Load Bearing	160kgs	160kgs	160kgs	160kgs
Packing	4 pcs / pallet	4 pcs / pallet	4 pcs / pallet	4 pcs / pallet
Color	○	● ○	○	● ○



BANQUET TABLE SERIES



Features:

- Very durable and unbreakable.
- Suitable for bbq, school, study and etc.
- Easy to fold and setup.
- Save storage space.
- Hand carry and transport friendly.



FOLDABLE ROUND TABLE		
Model Code	RT80W	RT80R / RT80B
Barcode	9555221311639	9555221311646
Size	80cm x 74cm	80cm x 74cm
Load Bearing	160kgs	160kgs
Packing	4 pcs / pallet	4 pcs / pallet
Color	○	○ ●

Features :

- * Made with high grade raw materia, strong and durable
- * UV & Humidity resistance
- * Support weight more than 150 kg
- * Rubber based for anti-slip
- * Verified no any damage after fall at 10 meter heights



HEAVY-DUTY PLASTIC STACKING CHAIR WITH RUBBER BASE		
Model Code	4401R	4401B
Barcode	9555221301135	9555221309957
Packing	12 pcs	12 pcs
Color		



HEAVY-DUTY PLASTIC STACKING CHAIR WITH RUBBER BASE		
Model Code	4401M-1	4401B
Barcode	9555221309643	9555221309957
Packing	12 pcs	12 pcs
Color		



BANQUET TABLE SERIES

Features :

- * Made with high grade raw materia, strong and durable
- * UV & Humidity resistance
- * Support weight more than 150 kg
- * Rubber based for anti-slip
- * Made in Malaysia & Reputable Manufacturer



44 cm

36 cm



HEAVY-DUTY PLASTIC STOOL CHAIR WITH RUBBER BASE

Model Code	4430	V4430
Barcode	9555221309995	9555221309988
Packing	12 pcs	12 pcs
Colors	○ ● ● ●	●



► Easy to store and save space

5 LEGGED STOOL (SMALL) 五脚凳 (小)	
Model Code	4200
Barcode	9555221305607
Packing	48 pcs / carton
Size	34cm (L) x 24cm (W) x 20cm (H)
Color	● ● ● ●



5 LEGGED STOOL (TALL) 五脚凳 (高)	
Model Code	4300
Barcode	9555221306710
Packing	24 pcs / carton
Size	39cm (L) x 30cm (W) x 31cm (H)
Color	● ● ● ●



► Middle leg to withhold heavy weight of up to 250Kg

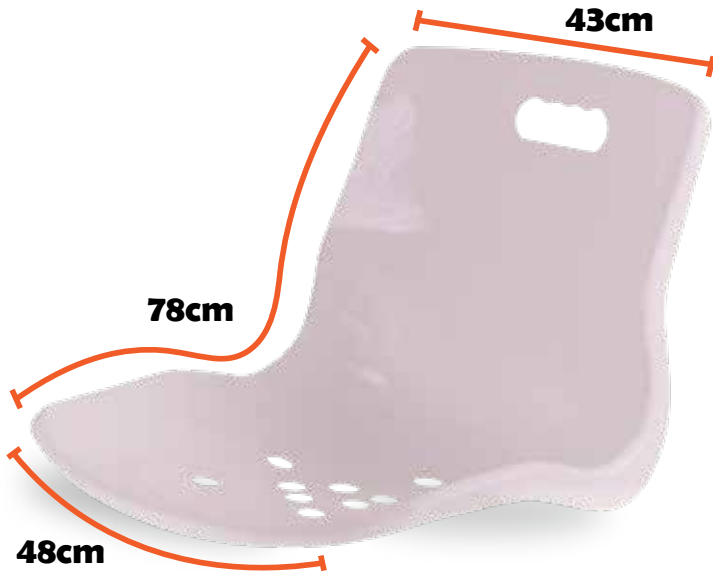

Mengelakkan sakit belakang, kaki kebas atau lenguh dan semut-semut.

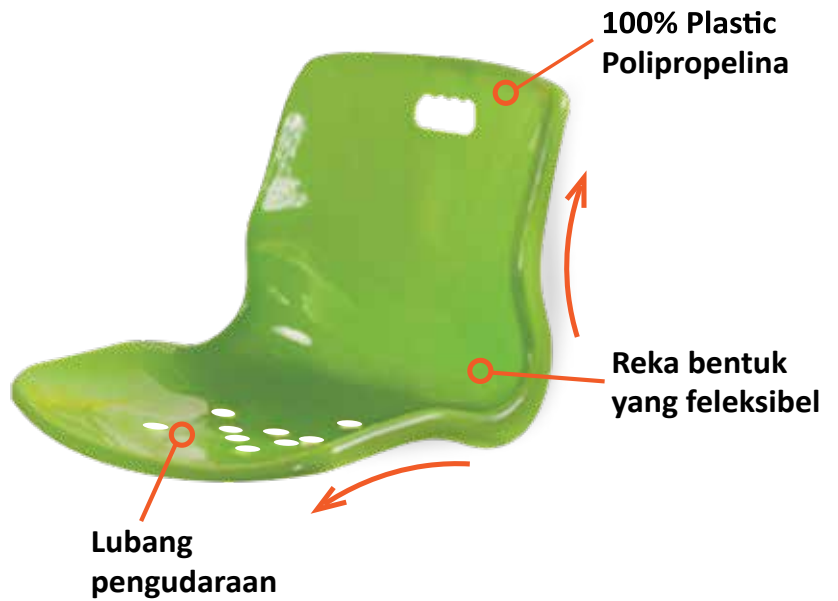

*Kerusi ngaji untuk kegunaan masjid, surau, madrasah dan kediaman anda.

KERUSI NGAJI	
Model Code	KN04
Barcode	9555221310878
Packing	10 pcs / carton
Size	<input checked="" type="radio"/> <input type="radio"/>

DISTRIBUTED BY : CEMERLANG RAYA (M) SDN BHD

03

KITCHENWARE &
HOUSEHOLD SERIES
廚房及家居用品系列

RAYACO®



DRAWER BOX

***DIY self installation.



1300-3



1300-5



*Special design for combination organizer storage box.

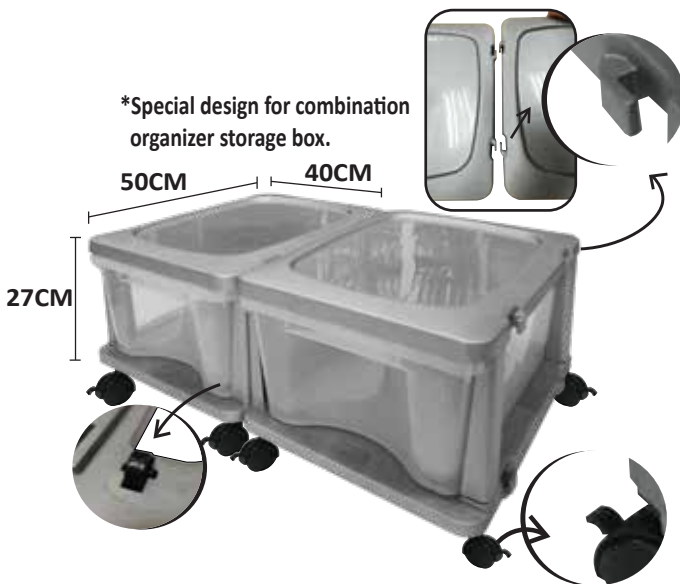

Features:

- Removable drawers.
- DIY easy self installation.
- Easy to clean and maintain.
- Suitable for organizing stationery, tools, small items, electronic accessories, spare parts and etc;

**Perfect for storing and organizing all of your school supplies, carfts, office supplies and more.*

HEAVY DUTY MULTIPURPOSE DRAWER BOX 抽屜式收納柜		
Model Code	1300-3	1300-5
Barcode	9555221312087	9555221312094
Size (cm)	40 (W) x 85 (H) x 50 (L)	40 (W) x 136 (H) x 50 (L)
Load Bearing	50kgs	50kgs
Packing	1 units/carton ; 40 carton/pallet	1 units/carton ; 20 carton/pallet
Packing (m ³)	0.51 x 0.415 x 0.325 (m ³)	0.51 x 0.415 x 0.425 (m ³)
Color	○	○



DRAWER BOX

Features:

- Removable drawers.
- DIY easy self installation.
- Easy to clean and maintain.
- Suitable for organizing stationery, tools, small items, electronic accessories, spare parts and etc;



900-3

95CM

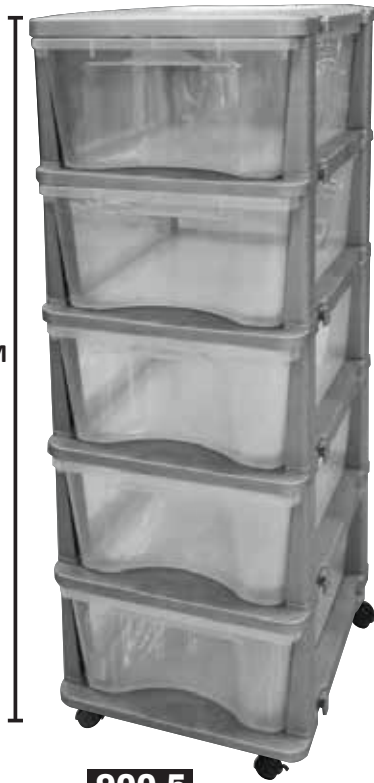

900-5

*****DIY easy installation.**



**Perfect for storing and organizing all of your school supplies, carfts, office supplies and more.*

**Special design for combination organizer storage box.*



HEAVY DUTY MULTIPURPOSE DRAWER BOX 抽屜式收納櫃		
Model Code	900-3	900-5
Barcode	9555221312070	9555221312063
Size (cm)	34 (W) x 60 (H) x 43 (L)	34 (W) x 95 (H) x 43 (L)
Load Bearing	50kgs	50kgs
Packing	1 units/carton ; 50 carton/pallet	1 units/carton ; 30 carton/pallet
Packing (m ³)	0.435 x 0.36 x 0.245 (m ³)	0.435 x 0.36 x 0.325 (m ³)
Color	○	○



COLORFUL DRAWER BOX

Features:

- Removable drawers.
- DIY easy self installation.
- Easy to clean and maintain.
- Suitable for organizing stationery, tools, small items, electronic accessories, spare parts and etc;



***DIY self installation.

**Perfect for storing and organizing all of your school supplies, crafts, office supplies and more.*



*Special design for combination organizer storage box.

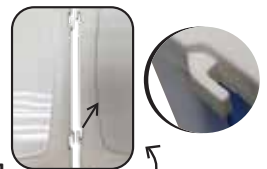

*Internal wheeling system, easy to pull in and out.

HEAVY DUTY MULTIPURPOSE COLORFUL DRAWER BOX 彩色抽屉式收纳柜		
Model Code	1300C-5	1300C-3
Barcode	9555221312094	9555221312087
Size (cm)	40 (W) x 136 (H) x 50 (L)	40 (W) x 85 (H) x 50 (L)
Load Bearing	50kgs	50kgs
Packing	1 units/carton ; 20 carton/pallet	1 units/carton ; 40 carton/pallet
Packing (m ³)	0.51 x 0.415 x 0.425 (m ³)	0.51 x 0.415 x 0.325 (m ³)
Color	○○○○	○○○○

COLORFUL DRAWER BOX

Features:

- Removable drawers.
- DIY easy self installation.
- Easy to clean and maintain.
- Suitable for organizing stationery, tools, small items, electronic accessories, spare parts and etc;

**Perfect for storing and organizing all of your school supplies, crafts, office supplies and more.*

***DIY self installation.



*Special design for combination organizer storage box.

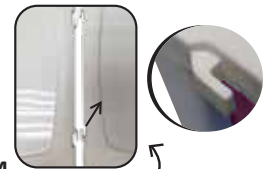

*Internal wheeling system, easy to pull in and out.

HEAVY DUTY MULTIPURPOSE COLORFUL DRAWER BOX 彩色抽屉式收纳柜		
Model Code	900C-5	900C-3
Barcode	9555221312063	9555221312070
Size (cm)	34 (W) x 95 (H) x 43 (L)	34 (W) x 60 (H) x 43 (L)
Load Bearing	50kgs	50kgs
Packing	1 units/carton ; 30 carton/pallet	1 units/carton ; 50 carton/pallet
Packing (m ³)	0.435 x 0.36 x 0.325 (m ³)	0.435 x 0.36 x 0.245 (m ³)
Color	○○○○	○○○○

3 COMPARTMENT AIR-LIQUID TIGHT LUNCH BOX

Features:

- Light weight and easy to carry for children.
- Designed with 3 individual compartments that keep food separate and with lid, sealing performance.

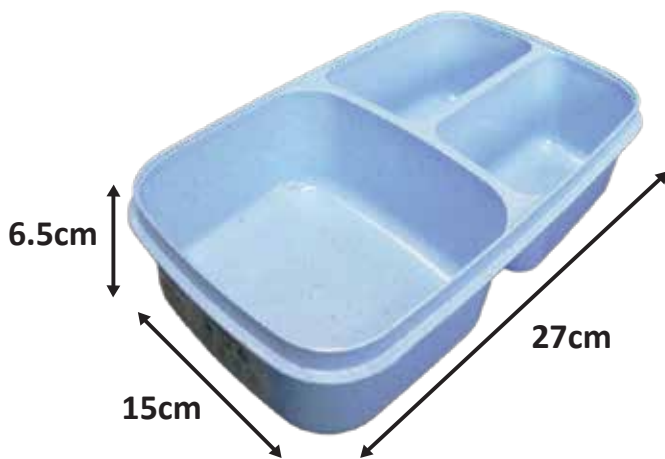
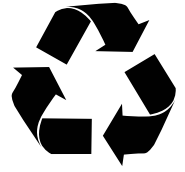

Green



Pink



Blue

AIR-LIQUID TIGHT LUNCH BOX	
Model Code	LB-100
Barcode	9555221309797
Size	15cm (W) x 6.5cm (H) x 27cm (L)
Packing	12pcs/box, 144pcs/ctn
Color	○○○



PLASTIC LADLE (SMALL) 塑料水勺 (小)	
Model Code	9130
Barcode	9555221304440
Size (cm)	17 (ø) x 8 (H)
Packing	12 dzs / carton
Color	● ● ●

PLASTIC LADLE (BIG) 塑料水勺 (大)	
Model Code	9150
Barcode	9555221304433
Size (cm)	19 (ø) x 10 (H)
Packing	12 dzs / carton
Color	● ● ●



PLASTIC LADLE (ROUND) 塑料水勺 (圓形)	
Model Code	9170
Barcode	9555221305553
Size (cm)	18 (ø) x 12 (H)
Packing	24 dzs / carton
Color	● ● ●



PLASTIC LADLE (SQUARE) 塑料水勺 (方形)	
Model Code	9160
Barcode	9555221305546
Size (cm)	18.5 (L) x 18.5 (W) x 12 (H)
Packing	24 dzs / carton
Color	● ● ●



MULTIPURPOSE MUG	
Model Code	4810
Barcode	9555221309193
Packing	12 pcs / bag; 144 pcs / carton
Colors	● ● ●



MULTIPURPOSE PLASTIC ROUND DEEP COLANDER 多用途塑料圓濾盆		
Model Code	C008	C009
Barcode	9555221311417	9555221311424
Size (cm)	8"	9"
Packing	12 pcs / bag; 288pcs / carton	12 pcs / bag; 288pcs / carton
Color	●●●	●●●



MULTIPURPOSE PLASTIC SQUARE DEEP COLANDER 多用途塑料方濾盆				
Model Code	C408	C410	C412	C414
Barcode	9555221309261	9555221308721	9555221309278	9555221309285
Size (cm)	8"	10"	12"	14"
Packing	144 pcs / carton	144 pcs / carton	144 pcs / carton	144 pcs / carton
Color	●●●	●●●	●●●	●●●



AIRTIGHT ROUND STORAGE CONTAINER 密封儲存圓容器			
Model Code	OP3007	OP3004	OP3002
Barcode	9555221309070	9555221309803	9555221309971
Size (cm)	23.5cm x 37cm	23.5cm x 18.5cm	23.5cm x 9.5cm
Capacity	7L	4L	2L
Packing	6 pcs / pkt 36 pcs / carton	6 pcs / pkt 48 pcs / carton	6 pcs / pkt 72 pcs / carton
Color	●●●	●●●	●●●

ROUND DISH COVER 圓形菜罩	
Model Code	5120
Barcode	9555221306581
Size (cm)	12"
Packing	72 sets / carton
Color	● ● ●



ROUND DISH COVER 圓形菜罩	
Model Code	5220
Barcode	9555221306581
Size (cm)	20"
Packing	36 sets / carton
Color	● ● ●



ROUND DISH COVER 圓形菜罩	
Model Code	5240
Barcode	9555221306055
Size (cm)	24"
Packing	36 sets / carton
Color	● ● ●



SQUARE DISH COVER 方形菜罩	
Model Code	5224
Barcode	9555221305683
Size (cm)	22"
Packing	36 sets / carton
Color	● ● ●

RECTANGULAR DISH COVER 长方形菜罩	
Model Code	5302
Barcode	9555221305850
Size (cm)	25" x 19.5"
Packing	36 sets / carton
Color	● ● ●



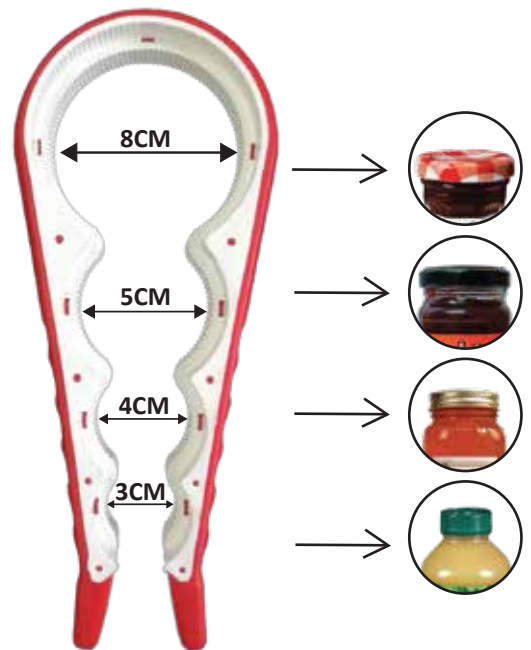
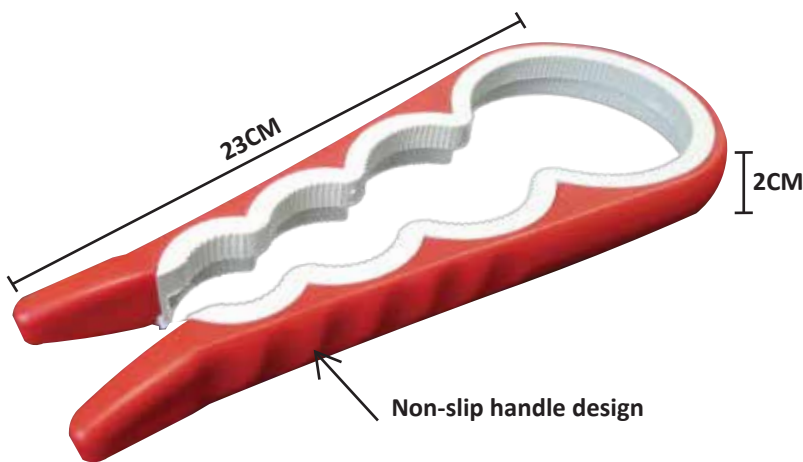
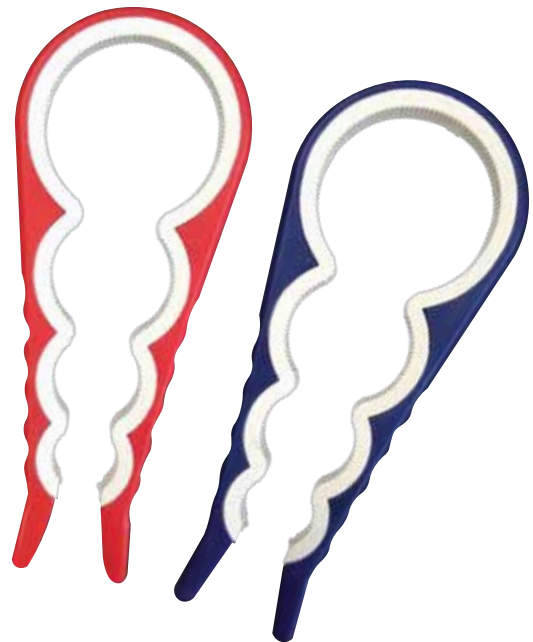

Features

- Fit any size lid or cap
- No slipping, no adjusting, no straining
- Easy grip handle
- Great for children and elderly
- Makes opening any lid a breeze
- Hand-wash recommended



MULTIFUNCTION JAR OPENER	
Model Code	4001
Barcode	9555221304761
Packing	12 pcs / pkt ; 144 pcs / carton
Color	● ●

MATTRESS LIFTER (LIFT & PUSH IN)



**Lift up mattress easily !
(Best for hotel/homestay housekeeping work)**



Features:

- Allows you to quickly tuck in sheets and place a bed skirt. The perfect tool for bed/ sofa cleaning.
- The angled wedge design separates and lifts the mattress as it slides in, reducing body pressure.
- Separates and lifts the mattress as it slides in, reducing body strain incurred with the twist and lift motion on the mattress.



ML40



ML25

MATTRESS LIFTER (BIG)	
Model Code	ML40
Barcode	9555221312353
Size (cm)	38cm (L) x 7cm (W) x 13cm (H)
Packing	6 pcs / packet ; 72 pcs / carton
Color	●●●●

MATTRESS LIFTER (SMALL)	
Model Code	ML25
Barcode	9555221312346
Size (cm)	25cm (L) x 4cm (W) x 10cm (H)
Packing	6 pcs / packet ; 72 pcs / carton
Color	●●●●



007



008



MULTIPURPOSE CLIPPER 万能夹		
Model Code	007	008
Barcode	95552213101241	95552213101258
Size (cm)	90mm (L)	150mm (L)
Packing	12 pcs / pkt; 576 units / carton	12 pcs / pkt; 240 units / carton



Patented Product



MULTIPURPOSE CLIPPER 万能夹			
	(S)	(M)	(B)
Model Code	605	603	604
Barcode	95552213106994	95552213103405	95552213104785
Packing	12 pcs / pkt; 288 pcs / carton	12 pcs / pkt; 288 pcs / carton	12 pcs / pkt; 144 pcs / carton

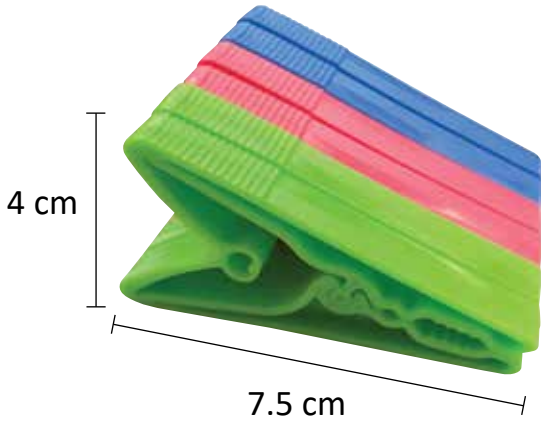

Model : 607-30



Without Spring



Can be used for clamping curtains, quilts and coats etc

MAGIC CLOTH PEG 实用衣夹		
Model Code	607-30	607-30
Barcode	95552213104228	95552213104211
Size (cm)	20 pkt / box; 120 pkt / carton	24 pkt / box; 144 pkt / carton
Colors	●●●	●○○



Model : 607-20





MULTIPURPOSE DOUBLE PANEL HOOK
多用途塑料双吊钩

Model Code	602
Barcode	9555221304372
Packing	12 pcs / box; 72 pcs / carton

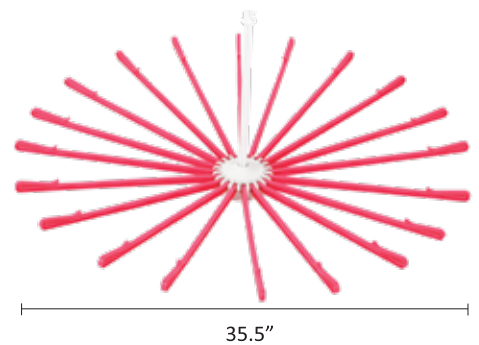

UMBRELLA HANGER
20 头伞形衣架

Model Code	608
Barcode	9555221304938
Packing	36 pcs / carton
Color	● ● ●

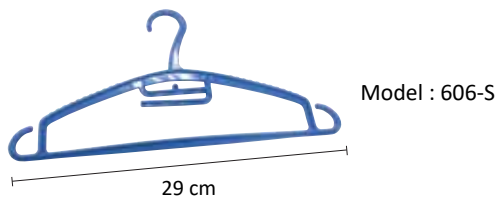
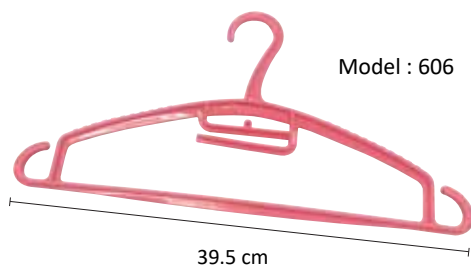

MAGIC CLOTH PEG 实用衣夹

Model Code	606	606-S
Barcode	95552213109179	9555221309186
Packing	6 pcs / pack	12 pcs / pack
Colors	● ● ●	● ● ●



SPRAYER 1000 ML	
Model Code	R855
Barcode	955553408557
Size (cm)	10 (ø) x 24 (H)
Packing	12 pcs / bag; 144pcs / carton
Color	●●●



SPRAYER 500 ML	
Model Code	R850
Barcode	9555221312162
Size (cm)	10 (ø) x 20 (H)
Packing	12 pcs / bag; 144pcs / carton
Color	●●●

Features:

- For easier carry and moving.
- Can used to carry huge dustbin.
- Heavy duty, high durable, compact design, sturdiness.
- 6 compact roller more balancing, support and stability.



*Kaki tong gas



*3018 can paired with bin V8120.



5 Wheels



*Maximum static load

HEAVY DUTY MULTIPURPOSE ROUND TROLLEY (5 WHEELS) 多用途多轮推车	
Model Code	3018
Barcode	955522131198
Size (cm)	37 (ø) x 10 (H)
Load Bearing	100kgs
Packing	48 units / carton
Color	● ●

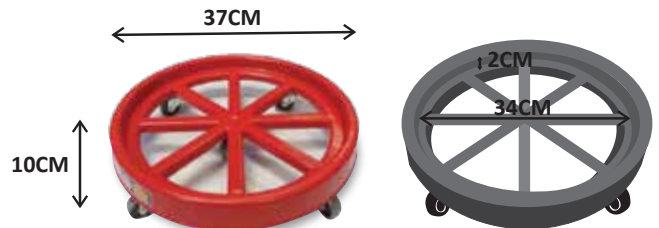

*3017 can paired with bin V8150,V8800 and V8800-2.



6 Wheels

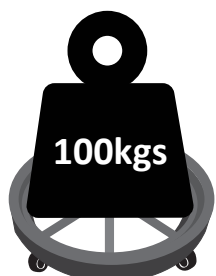

*Maximum static load

HEAVY DUTY MULTIPURPOSE ROUND TROLLEY (6 WHEELS) 多用途多轮推车	
Model Code	3017
Barcode	9555221307069
Size (cm)	42 (ø) x 10 (H)
Load Bearing	100kgs
Packing	48 units / carton
Color	○



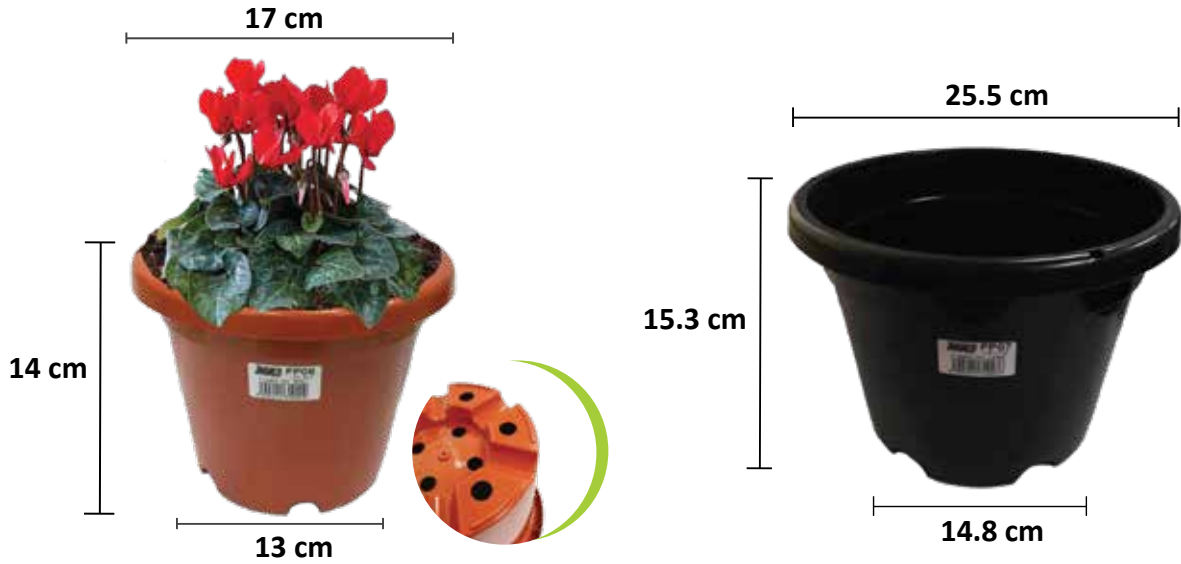

FLOWER POT 塑料花盆		
	(S)	(B)
Model Code	FP06	FP07
Barcode	9555221310229	9555221310236
Size (cm)	17 (Ø) x 14 (H)	25.5 (Ø) x 15.3 (H)
Packing	48 pcs / bag; 144pcs / carton	12 pcs / bag; 144pcs / carton
Color	●	●



- Strong & Durable, excellence supporting
- Allowing easy cleaning of space below cabinet, washing machine, fridge and furniture
- Allow some space to cleaning rust bottom the fridge or washing machine due to moistures



MULTIPURPOSE STAND 多用途脚垫		
	(S)	(B)
Model Code	FS03	FS04
Barcode	95552213104815	95552213104808
Size (cm)	9 (L) x 6 (H)	12 (L) x 8.5 (H)
Packing	72 sets / carton	36 sets / carton



* 饭店厨师都是使用铁锅烹饪，主要是因为它们健康易用并且可以烹制出传统味道

One of the main advantages of using the traditional wok for cooking is that it is considered to be a healthier alternative to cooking with the frying pan.



WOK WITH WOODEN HANDLE 木柄老铁锅		
Model Code	32WH	34WH
Barcode	9555221310069	9555221310076
Diameter (cm)	32 cm	34 cm
Weight (kg)	1.20 kg	1.31 kg
Packing	20 pcs/box	20 pcs/box

WOK WITH WOODEN HANDLE 木柄老铁锅			
Model Code	36WH	38WH	40WH
Barcode	9555221310090	9555221310106	9555221310113
Diameter (cm)	36 cm	38 cm	40 cm
Weight (kg)	1.72 kg	1.85 kg	2.05 kg
Packing	15 pcs/box	15 pcs/box	15 pcs/box

温馨提示 WARM TIPS

不要用洗涤剂洗锅，用清水即可。
Do not use detergent to wash the iron wok, just use clean water.

铁锅不宜盛过夜食物。
Iron wok should not be used to hold overnight food.

不能用铁锅炖中药和酸性果品。
Do not use iron wok to stew traditional chinese medicine and acidic fruits.



Easy to wash

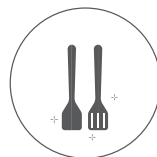

Fits all spatulas



High Quality



Not easy to deform



Easy to wash

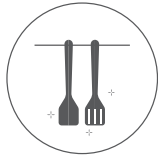

Fits all spatulas



High Quality



Not easy to deform

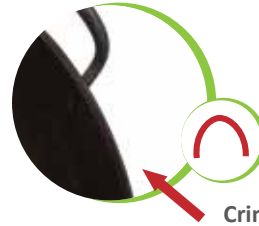

Crimping edge design

DEEP WOK A GRADE WITH DOUBLE HANDLE 双耳A型(卷边)					
Model Code	40WA	45WA	50WA	55WA	60WA
Barcode	9555221310120	9555221310137	9555221310144	9555221310151	9555221310168
Diameter (cm)	40 cm	45 cm	50 cm	55 cm	60 cm
Weight (kg)	2.34 kg	2.76 kg	3.25 kg	3.81 kg	4.41 kg
Packing	10 pcs/box	10 pcs/box	10 pcs/box	8 pcs/box	8 pcs/box



老铁锅
TRADITIONAL WOK
(LONG LASTING)



32WD



60WB



Straight edge design

DEEP WOK WITH DOUBLE HANDLE 双耳B型(直边)				
Model Code	32WD	34WD	36WD	38WD
Barcode	9555221310304	9555221310311	9555221310328	9555221310335
Diameter (cm)	32 cm	34 cm	36 cm	38 cm
Weight (kg)	1.4 kg	1.55 kg	1.7 kg	1.895 kg
Packing	10 pcs/box	10 pcs/box	10 pcs/box	10 pcs/box

DEEP WOK WITH DOUBLE HANDLE 双耳B型(直边)					
Model Code	40WB	45WB	50WB	55WB	60WB
Barcode	9555221310175	9555221310182	9555221310199	9555221310205	9555221310212
Diameter (cm)	40 cm	45 cm	50 cm	55 cm	60 cm
Weight (kg)	1.72 kg	2.15 kg	2.72 kg	3.51 kg	4.30 kg
Packing	10 pcs/box	10 pcs/box	10 pcs/box	8 pcs/box	8 pcs/box

* Wooden handle with hole to hang



FEATURES

- Use high-quality stainless steel, fine sanding treatment.
- Streamlined non-slip wooden handle design.
- Healthier and easier to clean.



ATTENTION

- After use, please rinse with clean water and store in a cool and dry place.
- When using this product for the first time, please wash it first.

	S/S SUDIP WITH WOODEN HANDLE 木柄不锈钢锅铲	S/S LADLE WITH WOODEN HANDLE 木柄不锈钢锅勺
Model Code	K355	K356
Barcode	9555221310342	9555221310356
Size (cm)	43CM (L) x 10CM (W)	43CM (L) x 10CM (D)
Packing	12 pcs / bag; 48 pcs / carton	12 pcs / bag; 48 pcs / carton

FEATURES

- Use high-quality stainless steel, fine sanding treatment.
- Black handle design.
- Healthier and easier to clean.



* Black handle with hole to hang



	S/S SUDIP 不锈钢锅铲	S/S LADLE 不锈钢锅勺
Model Code	K353	K354
Barcode	9555221309384	9555221309391
Packing	12 pcs / bag; 300 pcs / carton	12 pcs / bag; 300 pcs / carton



FEATURES

- Use high-quality stainless steel, fine sanding treatment.
- Stainless steel protects against rust and corrosion.
- Fashion with a lustrous mirror finish.
- Healthier and easier to clean.

ATTENTION

- After use, please rinse with clean water and store in a cool and dry place.
- When using this product for the first time, please wash it first.
- Dishwasher safe.



*Special texture design.

ECONOMY S/S SPOON 轻装不锈钢匙		ECONOMY S/S SPOON 轻装不锈钢叉		
Model Code	K768-S12	K769-S6	K768-F12	K769-F6
Barcode	9555221309308	9555221309339	9555221309315	9555221309322
Packing	12 pcs / pkt; 60 pkt / carton	6 pcs / pkt; 120 pkt / carton	12 pcs / pkt; 60 pkt / carton	6 pcs / pkt; 120 pkt / carton

- Wash before using for the first time.
- Dishwasher safe
- Easy to clean
- Long-lasting
- Not easily bent
- Can withstand heat



* Plain pattern best-selling stainless steel cutlery range ideal for restaurant, hotel, home and any related events that requires tableware.



STANDARD S/S SPOON 厚装不锈钢匙		STANDARD S/S SPOON 厚装不锈钢叉		
Model Code	K966-S12	K967-S6	K966-F12	K967-F6
Barcode	9555221309346	9555221309360	9555221309353	9555221309377
Packing	12 pcs / pkt; 120 pkt / carton	6 pcs / pkt; 120 pkt / carton	12 pcs / pkt; 60 pkt / carton	6 pcs / pkt; 120 pkt / carton

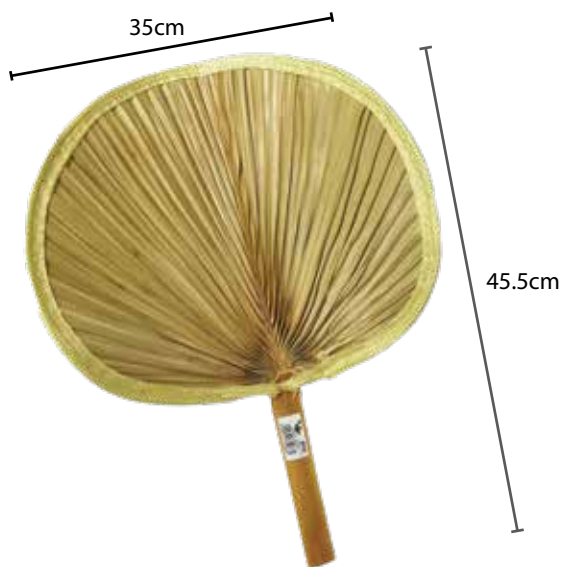

- Hand Fan Satay
- Light and easy to use
- High Quality & durable
- Made of wood & fabric
- Convenient to carry around

KIPAS SATAY 沙爹扇子

Model Code	BF04
Barcode	9555221310861
Size	45.5cm (L) x 35cm (Ø)
Packing	12pcs / carton; 200pcs



- A bamboo wok brush is a type that is used to clean .
- It is used with the wok still hot and with hot water or water added to a heated wok to clean without so the wok does not rust.
- And at the same time, soft enough that no damage is made to the surface of the wok.



BAMBOO WOK BRUSH 竹锅刷		BAMBOO WOK BRUSH WITH S/S HANDLE 竹锅刷带钢柄	
Model Code	BB630	Model Code	BB631
Barcode	9555221309865	Barcode	9555221309872
Packing	50 pcs/carton	Packing	50 pcs/carton

- Made with high-quality plastic
- Wash with hot or cold water
- May use detergent or bleach to remove stains.
- Will stand boiling water but keep it away from fire, hot pots, and pans.



Extra Thickness
加厚板



PLASTIC CHOPPING BOARD 塑料占板				
Model Code	2001	2012	2002	2003
Barcode	9555221305058	9555221307717	9555221305041	9555221307717
Size	17cm x 27cm x 1cm	20cm x 33cm x 1.1cm	25cm x 35cm x 1.3cm	29cm x 43cm x 1.4cm
Packing	60 pcs / carton	36 pcs / carton	24 pcs / carton	18 pcs / carton

TOOTHPICKS SERIES 牙签系列



NATURAL COLOR TOOTHPICKS 本色扁木牙签

Model Code	100#	230#
Barcode	9555221301319	9555221301326
Packing	72 boxes / carton	144 boxes / carton

NATURAL COLOR TOOTHPICKS 本色扁木牙签

Model Code	300#	400#
Barcode	9555221301333	9555221301340
Packing	5 gross dz / carton	5 gross dz / carton



ROUND BAMBOO TOOTHPICKS 双头尖竹牙签

Model Code	250#	500#
Barcode	9555221303542	9555221305072
Packing	12 pcs / pkt; 144 boxes / carton	12 pcs / pkt; 72 boxes / carton



**ROUND BAMBOO TOOTHPICKS (BOTTLES)
双头尖竹牙签(罐装)**

Model Code	255	505
Barcode	9555221308110	9555221308103
Packing	24 pack / carton	24 pack / carton



**PAPER WRAP WOODEN TOOTHPICKS
纸包装双头尖木牙签**

Model Code	1500#
Barcode	9555221303191
Packing	50 boxes / carton



BAMBOO SKEWER 竹串			
	4"	6"	8"
Model Code	SK100	SK150	SK200
Barcode	9555221303221	9555221305508	9555221305492
Packing	350 g ± 10% / bag 80 bags / carton	350 g ± 10% / bag 80 bags / carton	500 g ± 10% / bag 60 bags / carton

BAMBOO SKEWER 竹串				
	8"	8"	10"	12"
Model Code	SK201	SK202	SK250	SK300
Barcode	9555221310434	9555221310441	9555221305515	9555221305522
Packing	400 g ± 10% / bag 75 bags / carton	300 g ± 10% / bag 100 bags / carton	500 g ± 10% / bag 60 bags / carton	700 g ± 10% / bag 40 bags / carton



CHOPSTICKS 筷子			
	4.5	5.0	5.5
Model Code	BC45	BC50	BC55
Barcode	9555221308288	9555221308271	9555221308295
Packing	40 pairs / bag 50 or 100 bags / carton	40 pairs / bag 100 bags / carton	40 pairs / bag 100 bags / carton

*Disclaimer : Weight and quantity indicated just for reference, actual might varies



- 100% Virgin Material
- Non Toxic
- Eco Friendly



- Food Grade
- Multipurpose
- Suitable for both hand
- Extra Thickness
- Good for more heavy duty work

DISPOSABLE PLASTIC PE GLOVE

Model Code	PG100	PG101	PG102
Barcode	9555221310021	9555221310038	9555221310045
Packing	100 box/ctn	72 box/ctn	48 box/ctn



**Standard
(PG100)**



**Heavy Duty
(PG101)**



**Super Heavy Duty
(PG102)**

CANDLES SERIES

蜡烛系列



209557

259557

6 PCS WHITE CANDLE 蜡烛			
	20g	25g	28g
Model Code	209557	259557	289557
Barcode	9555221304167	9555221303429	9555221303252
Packing	100 boxes / carton	100 boxes / carton	50 boxes / carton



409557

687

686

6 PCS WHITE CANDLE 白蜡烛			
	40g	15g	15g
Model Code	409557	687	686
Barcode	9555221303245	9555221303269	9555221303276
Packing	50 boxes / carton	100 boxes / carton	100 boxes / carton



TEA CANDLE 餐烛		
Model Code	10100	1010
Barcode	9555221305706	9555221303436
Packing	24 boxes / carton	100 boxes / carton



10100

1010

BAMBOO STEAMER WITH ALUMINIUM FRAME & LID
铝边竹蒸笼及竹蒸笼盖

MODEL	DESCRIPTION	PACKING (unit/ctn)
5"	Steamer	300
5"	Lid	300
6"	Steamer	100
6"	Lid	200
7"	Steamer	100
7"	Cover	200
8"	Steamer	60
8"	Lid	120
10"	Steamer	40
10"	Lid	60
12"	Steamer	40
12"	Lid	80
14"	Steamer	20
14"	Lid	34
16"	Steamer	10
16"	Lid	30
18"	Steamer	10
18"	Lid	30
20.5"	Steamer	5
20.5"	Lid	10





BAMBOO STEAMER WITH YELLOW RUBBER FRAME & LID
黄色塑边竹蒸笼及黄色塑边竹蒸笼盖

MODEL	DESCRIPTION	PACKING (unit/ctn)
PS5"	Steamer (Yellow Slate)	300
PC5"	Lid (Yellow Slate)	300
PS6"	Steamer (Yellow Slate)	100
PC6"	Lid (Yellow Slate)	400
PS7"	Steamer (Yellow Slate)	100
PC7"	Lid (Yellow Slate)	200
PS8"	Steamer (Yellow Slate)	60
PC8"	Lid (Yellow Slate)	120
PS10"	Steamer (Yellow Slate)	60
PC10"	Lid (Yellow Slate)	150
PS12"	Steamer (Yellow Slate)	40
PC12"	Lid (Yellow Slate)	150



BAMBOO STEAMER WITH GREEN RUBBER FRAME & LID
青色塑边竹蒸笼及青色塑边竹蒸笼盖

MODEL	DESCRIPTION	PACKING (unit/ctn)
PS5"	Steamer (Green Slate)	300
PC5"	Lid (Green Slate)	300
PS6"	Steamer (Green Slate)	100
PC6"	Lid (Green Slate)	400

BAMBOO STEAMER WITH STAINLESS STEEL FRAME & LID
钢口竹蒸笼及竹蒸笼盖

MODEL	DESCRIPTION	PACKING (unit/ctn)
SS5"	Steamer	300
SS5"	Lid	300
SS6"	Steamer	100
SS6"	Lid	100
SS6.5"	Steamer	60
SS6.5"	Lid	60
SS7"	Steamer	100
SS7"	Lid	100
SS8"	Steamer	60
SS8"	Lid	60
6.5"	Steamer	100
6.5"	Lid	100



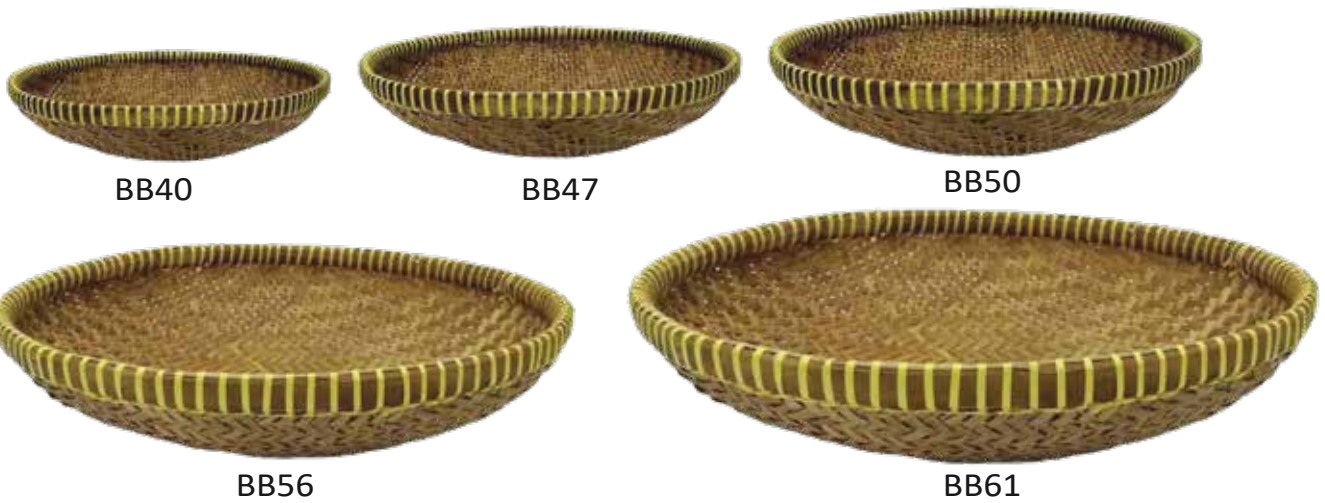

BAMBOO BASKET 竹罗筐	
Model Code	Packing (Unit / Carton)
BB61 - BB40	5 头 pcs per set / 18 set / carton
BB61 - BB56	2 头 pcs per set / 24 set / carton

- Diameter might varied ± 2 cm
- BB61 ϕ 61CM \pm 2CM
 - BB56 ϕ 56CM \pm 2CM
 - BB50 ϕ 50CM \pm 2CM
 - BB47 ϕ 47CM \pm 2CM
 - BB40 ϕ 40CM \pm 2CM

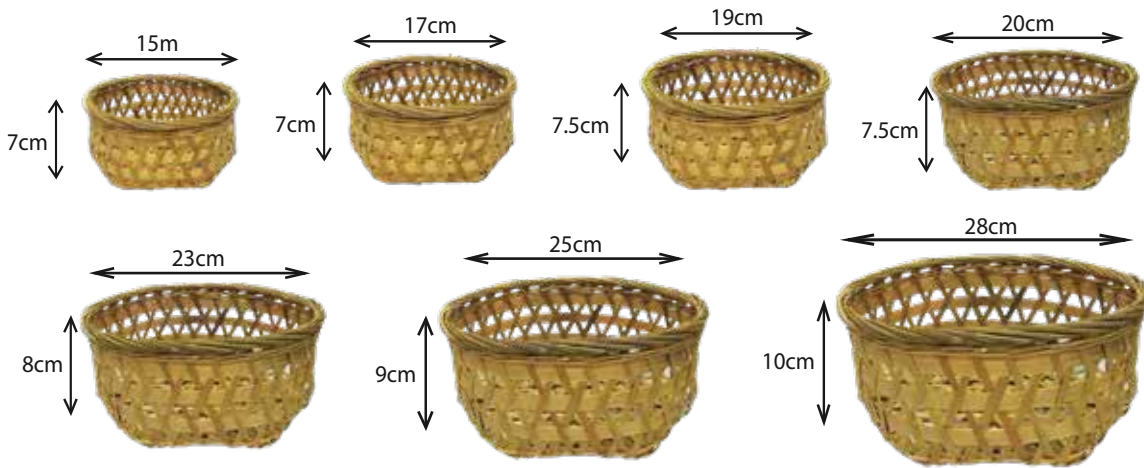

* 2 Pcs per set



* 3 Pcs per set



* 5 Pcs per set



*Bamboo basket for steam sponge cakes, ma lai koh and etc...

BAMBOO BASKET FOR CAKE BAKING 五头竹糕篮	
Model Code	Packing (Unit / Carton)
S2	2 头 pcs per set (6" / 7")
S3	3 头 pcs per set (6" / 7" / 8")
S5	5 头 pcs per set (17" / 20" / 23" / 25" / 28")

*Disclaimer: Measurement might slightly varies with actual product.



BAMBOO ROTI ROUND BASKET 竹圓形面包籃		
Model Code	Description	Packing (unit / carton)
BBR6	6" (15cm) round bamboo basket	1000 pcs
BBR7	7" (18cm) round bamboo basket	1000 pcs
BBR8	8" (20cm) round bamboo basket	500 pcs
BBR9	9" (23cm) round bamboo basket	500 pcs
BBR10	10" (25cm) round bamboo basket	500 pcs
BBR11	11" (28cm) round bamboo basket	300 pcs
BBR12	12" (30cm) round bamboo basket	300 pcs

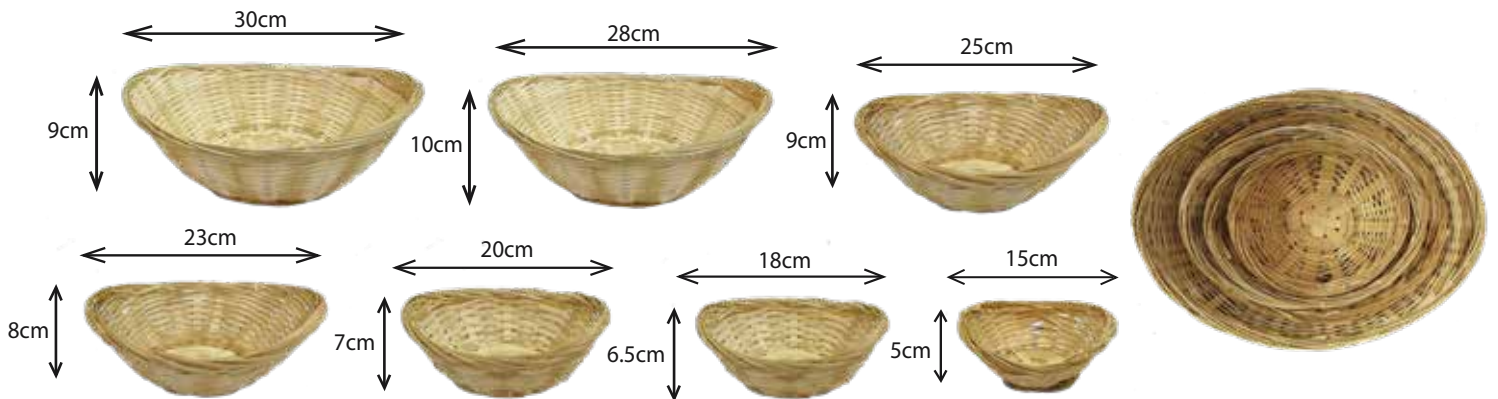

BAMBOO ROTI OVAL BASKET 竹蛋形面包籃		
Model Code	Description	Packing (unit / carton)
BRE6	6" (15cm) oval bamboo basket	1000 pcs
BRE7	7" (18cm) oval bamboo basket	1000 pcs
BRE8	8" (20cm) oval bamboo basket	500 pcs
BRE9	9" (23cm) oval bamboo basket	500 pcs
BRE10	10" (25cm) oval bamboo basket	500 pcs
BRE11	11" (28cm) oval bamboo basket	300 pcs
BRE12	12" (30cm) oval bamboo basket	300 pcs

*Minimum order of 20pcs/bag.

*Disclaimer: Measurement might slightly varies with actual product.

*ALL PICTURES SHOWN ARE FOR ILLUSTRATION PURPOSE ONLY.



VIP SERIES - MORTAR & PESTLE 粗石白				
	VIP13	VIP14.5	VIP16	VIP17.5
Model Code	VIP13 / VIP13 (A)	VIP14.5 / VIP14.5 (A)	VIP16 / VIP16 (A)	VIP17.5 / VIP17.5 (A)
Barcode	9555221307502	9555221307519	9555221307526	9555221307533
Size	13cm (∅) x 8cm (H)	14.5cm (∅) x 8.5cm (H)	16cm (∅) x 10cm (H)	17.5cm (∅) x 10.5cm (H)
Packing	12 sets /carton	12 sets /carton	12 sets /carton	8 sets /carton

VIP SERIES - MORTAR & PESTLE 粗石白				
	VIP19	VIP20.5	VIP23.5	VIP25
Model Code	VIP19 / VIP19 (A)	VIP20.5	VIP23.5	VIP25
Barcode	9555221307540	9555221307557	9555221302033	9555221307571
Size	19cm (∅) x 11.5cm (H)	20.5cm (∅) x 13cm (H)	23.5cm (∅) x 14cm (H)	25cm (∅) x 15.5cm (H)
Packing	8 sets /carton	4 sets /carton	4 sets /carton	2 sets /carton



* Nature Granite Stone



F BLACK SERIES - FINE MORTAR & PESTLE 精磨石臼			
Model Code	F8	F10	F12
Barcode	9555221307595	9555221307175	9555221307199
Size	8cm (∅) X 7cm (H)	10cm (∅) X 7.6cm (H)	12cm (∅) X 8.3cm (H)
Packing	24 sets / carton	24 sets / carton	24 sets / carton



* Natural Polished Granite Stone

F BLACK SERIES - FINE MORTAR & PESTLE 精磨石臼				
Model Code	F14.5	F16	F17.5	F19
Barcode	9555221306864	9555221306871	9555221306888	9555221306895
Size	14.5 cm	16 cm	17.5 cm	19.5 cm
Packing	12 sets / carton	8 sets / cart	8 sets / carton	6 sets / carton



* Use of stone mortar

- Chili
- Groundnut
- Onion
- Chili Powder
- Red Bean



FINE PESTLE 精磨石槌		
Model Code	FP16	FP17.5
Size	16 cm	17.5 cm
Packing	40 sets / carton	30 sets / carton



- * Use of stone mortar
- Chili
- Groundnut
- Onion
- Chili Powder
- Red Bean



*Economical loose pack (no individual packing).

S SERIES - MORTAR & PESTLE 粗石臼					
Model Code	S13	S14.5	S16	S17.5	S19
Size	13 cm	14.5 cm	16 cm	17.5 cm	19 cm
Packing	12 sets / carton	12 sets / carton	12 sets / carton	8 sets / carton	8 sets / carton



Smooth Surface



Rubber pad at the bottom. Anti-slip and anti-noise.

RU SERIES - FINE MORTAR & PESTLE WITH PAD 胶底滑面白&槌				
Model Code	RU13	RU14.5	RU16	RU17.5
Barcode	9555221305294	9555221305300	9555221305317	9555221305324
Size	13 cm	14.5 cm	16 cm	17.5 cm
Packing	12 sets / carton	12 sets / carton	12 sets / carton	8 sets / carton

RU SERIES - FINE MORTAR & PESTLE WITH PAD 胶底滑面白&槌			
Model Code	RU19	RU20.5	RU23.5
Barcode	9555221305331	9555221305348	9555221305355
Size	19 cm	20.5 cm	23.5 cm
Packing	8 sets / carton	6 sets / carton	4 sets / carton



PESTLE 滑面槌					
Model Code	R14.5	R16	R17.5	R19	R23.5
Length Size	14.5 cm	16 cm	17.5 cm	19 cm	23.5 cm
Packing	50 sets / carton	40 sets / carton	40 sets / carton	30 sets / carton	20 sets / carton



D16

D18

D20

D22

D24

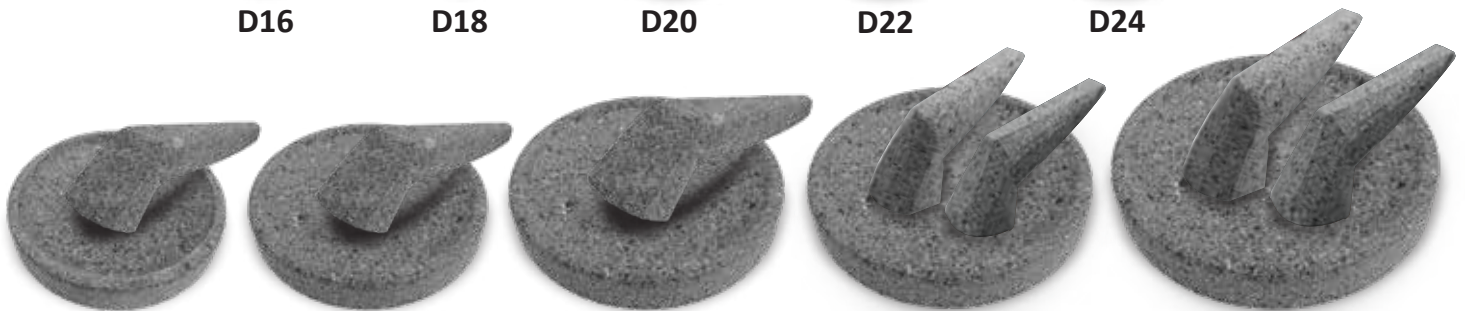

D26

D28

D30

D35

D40

COBEK BATU & ULEKAN

Model Code	D16	D18	D20	D22	D24
Barcode	9555221312100	9555221311264	9555221311271	9555221311288	9555221311295
Size	16 cm (∅)	18 cm (∅)	20 cm (∅)	22 cm (∅)	24 cm (∅)
Packing	6 sets / carton	8 sets / carton	8 sets / carton	8 sets / carton	6 sets / carton

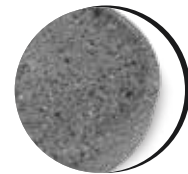

Natural Granite Stone

COBEK BATU & ULEKAN

Model Code	D26	D28	D30	D35	D40
Barcode	9555221311301	9555221311318	9555221311905	9555221311950	9555221311967
Size	26 cm (∅)	28 cm (∅)	30 cm (∅)	35 cm (∅)	40 cm (∅)
Packing	10 sets / carton	8 sets / carton	8 sets / carton	4 sets / carton	2 sets / carton

COBEK BATU WITH 2 ULEKAN

Model Code	D35	D40
Barcode	9555221311950	9555221311967
Size	35 cm (∅)	40 cm (∅)
Packing	2 sets / carton	2 sets / carton



	ULEKAN M SIZE	ULEKAN L SIZE
Model Code	UM	UL
Size	16CM (L)	17CM (L)
Packing	20 pcs / carton	20 pcs / carton

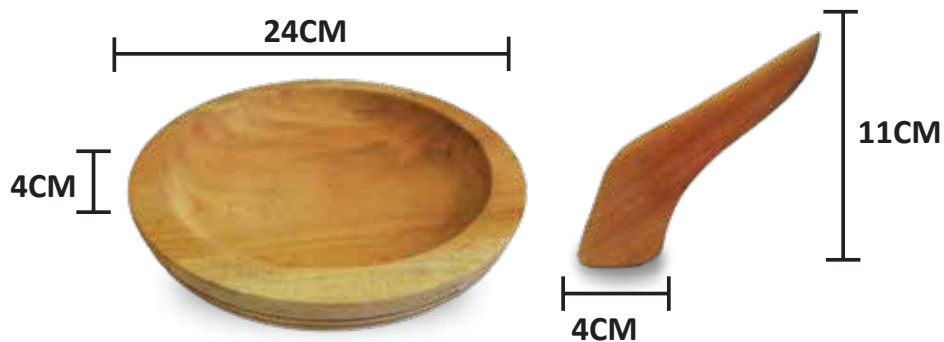

CU16



CU18



CU20



CU22



CU24

COBEK KAYU + ULEKAN					
Model Code	CU16	CU18	CU20	CU22	CU24
Barcode	9555221311752	9555221311769	9555221311776	9555221311783	9555221311790
Size	16 cm (ø)	18 cm (ø)	20 cm (ø)	22 cm (ø)	24 cm (ø)
Packing	6 sets / carton	6 sets / carton	6 sets / carton	20 sets / carton	15 sets / carton

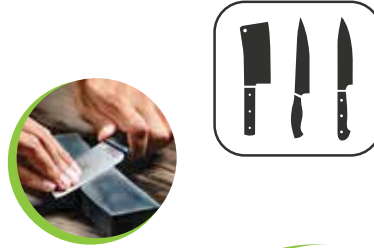

DIAMOND SHARPENING STONE 钻石牌双面氧化刀石		
	6"	8"
Model Code	DB621	DB821
Barcode	9555221308233	9555221308219
Packing	50 pcs / carton	50 pcs / carton



GOLD FISH SHARPENING STONE 金鱼刀石		
	4"	8"
Model Code	117	118
Barcode	9555221309766	9555221309773
Packing	20 dozen / carton	21 dozen / carton

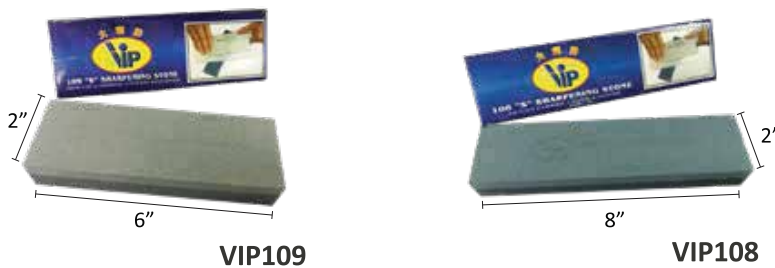

VIP SHARPENING STONE 双面刀石		
	6"	8"
Model Code	VIP109	VIP108
Barcode	9555221306444	9555221306451
Packing	50 pcs / carton	50 pcs / carton





GF109

GF108



GOLD FISH SHARPENING STONE

金鱼标志刀石

	6"	8"
Model Code	GF109	GF108
Barcode	9555221305393	9555221305386
Packing	50 pcs / carton	50 pcs / carton

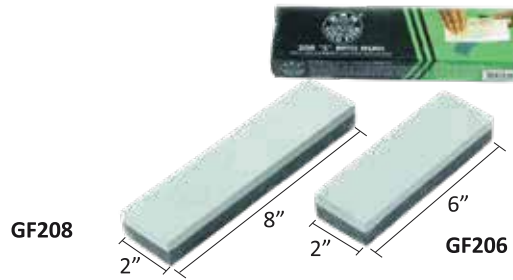

GF208

GF206

GOLD FISH SHARPENING STONE

金鱼标志刀石

	6"	8"
Model Code	GF206	GF208
Barcode	9555221308196	9555221308202
Packing	50 pcs / carton	50 pcs / carton



GOLD FISH SHARPENING STONE

金鱼标志刀石

	8" x 3" x 2"
Model Code	GF823
Barcode	9555221306109
Packing	20 pcs / carton

04

HARDWARE & INDUSTRY SERIES
工业塑料产品系列



CEMENT BUCKET (M) 灰桶 (中)	
Model Code	8250
Barcode	9555221304303
Packing	144 pcs / carton
Size (cm)	26.5 (∅) x 18 (H)
Color	



CEMENT BUCKET (L) 灰桶 (大)	
Model Code	8260
Barcode	9555221305928
Packing	120 pcs / carton
Size (cm)	29 (∅) x 18 (H)
Color	



CEMENT BUCKET (XL) 灰桶 (特大)	
Model Code	8270
Barcode	9555221305935
Packing	72 pcs / carton
Size (cm)	32 (∅) x 19.5 (H)
Color	



PAINT TRAY 油漆托盘	
Model Code	8017
Barcode	9555221304341
Packing	150 pcs / carton
Size (cm)	33 (L) x 24 (W) x 6.5 (H)



HIGH DENSITY & NORMAL DENSITY SPONGE SCRUB

- Gently scrub on cemented wall, for smooth cement wall finishing.
可用在打滑洋灰墙壁
- For cleaning mosaic floor or mosaic wall, remove dirt and dust easily
可用于洗刷镶嵌地板或镶嵌墙壁
- For car cleaning and polishing with wax
可用于洗车，打蜡拖光

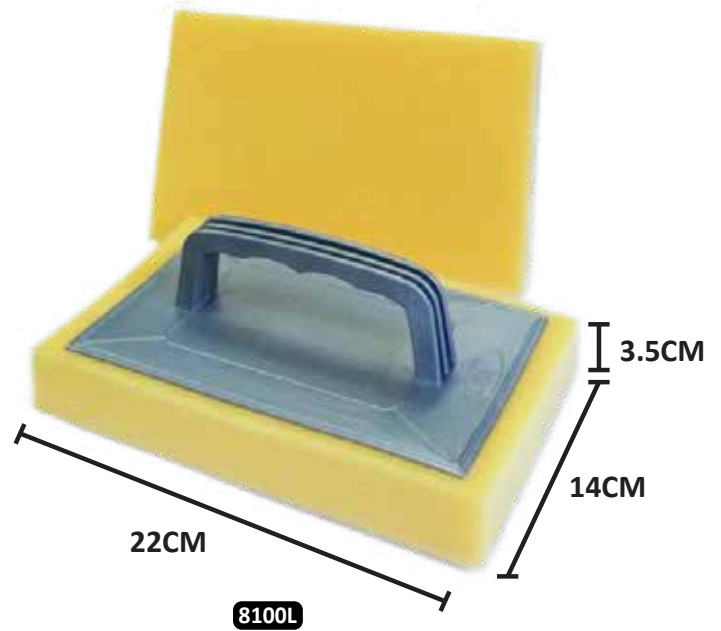
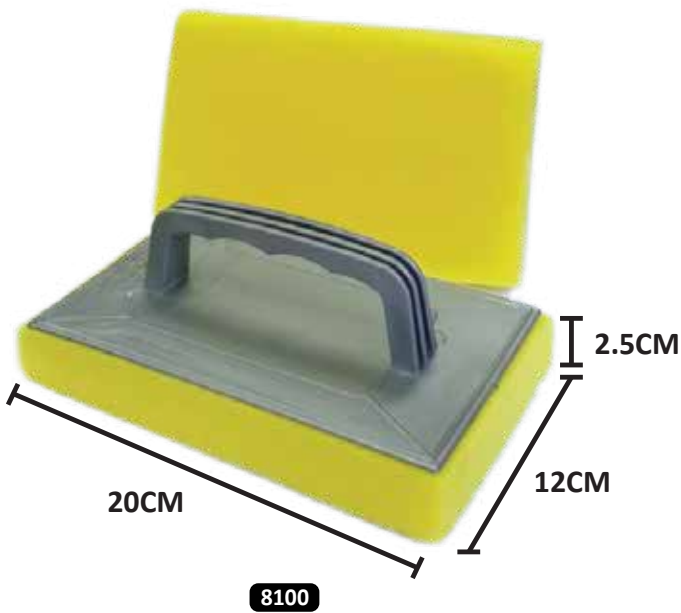

NORMAL DENSITY SPONGE SCRUB 多用途绵擦	
Model Code	8100
Barcode	9555221304716
Size	2.5cm (H) x 20cm (W) x 12cm (D)
Packing	48 pcs / pkt ; 288 pcs / carton

HIGH DENSITY SPONGE SCRUB 多用途绵擦	
Model Code	8100L
Barcode	9555221312056
Size	3.5cm (H) x 22cm (W) x 14cm (D)
Packing	48 pcs / pkt ; 288 pcs / carton

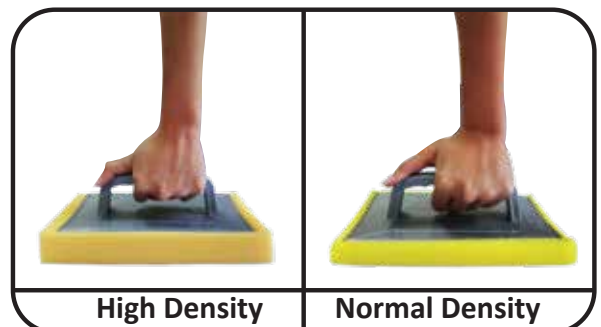

Comparison of flexibility between low density and high density melamine sponges.



CEMENT TRAY (PP) 灰托盘

Model Code	8202 - B
Barcode	9555221304464
Packing	36 pcs / pkt; 216 pcs / carton



CURVY CEMENT TRAY (PP) 灰托盘 (加硬)

Model Code	8203 - B
Barcode	9555221304891
Packing	24 pcs / pkt; 144 pcs / carton



SPRAYER 1000 ML

Model Code	R855
Barcode	955553408557
Size (cm)	10 (ø) x 24 (H)
Packing	12 pcs / bag; 144pcs / carton
Color	●●●



SPRAYER 500 CC

Model Code	R850
Barcode	9555221312162
Size (cm)	10 (ø) x 20 (H)
Packing	12 pcs / bag; 144pcs / carton
Color	●●●



HEAVY DUTY PLASTIC SCOOP (S) W HANDLE 塑料重型沙石畚箕 (小)	
Model Code	8418B
Barcode	9555221306062
Packing	48 pcs / carton
Colors	

HEAVY DUTY PLASTIC SCOOP (L) W HANDLE 塑料重型沙石畚箕 (大)	
Model Code	8419B
Barcode	9555221306079
Packing	48 pcs / carton
Colors	

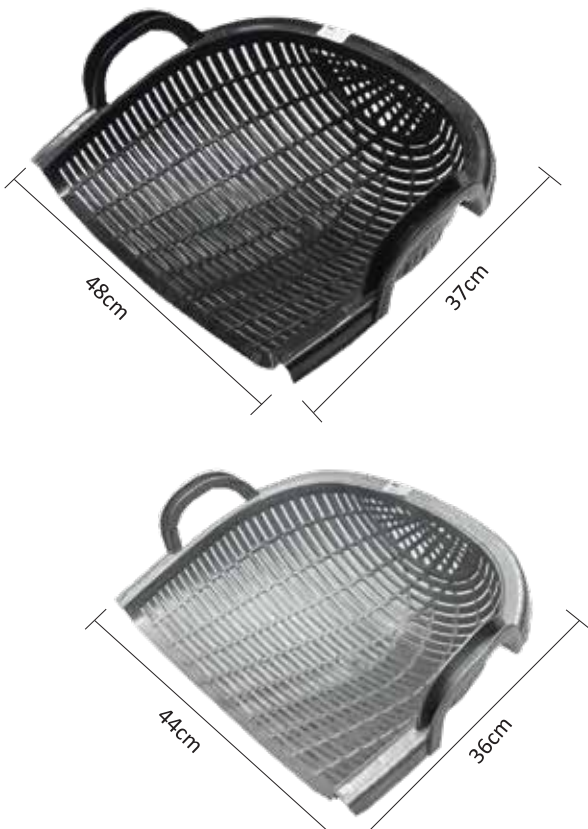

HEAVY DUTY PLASTIC SCOOP (S) 塑料重型沙石畚箕 (小)	
Model Code	8418A
Barcode	9555221306725
Packing	48 pcs / carton
Colors	

HEAVY DUTY PLASTIC SCOOP (L) 塑料重型沙石畚箕 (大)	
Model Code	8419A
Barcode	9555221306772
Packing	48 pcs / carton
Colors	



HEAVY DUTY DRAIN COVER



Special interlocking design for stability.

DCL06

DCL09



Maximum static load

Size:

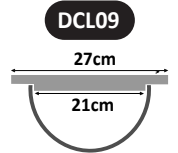
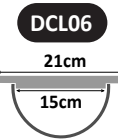
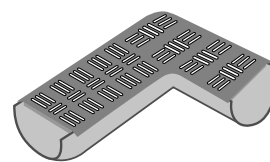
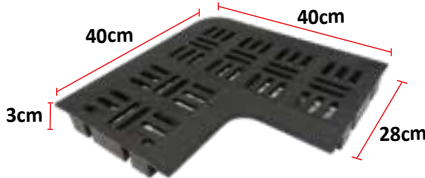
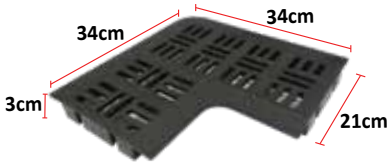

HEAVY DUTY L SHAPE DRAIN COVER 沟渠盖		
	SMALL	LARGE
Model Code	DCL06	DCL09
Barcode	9555221311820	9555221311837
Packing	12pcs / bag; 144pcs / carton	6pcs / carton
Size (cm)	8.5" x 13.5"	11" x 15.5"
Load Bearing	300kg	550kg
Color	■	■

- Suitable to uses at houses, warehouse, gardens, factory side and etc.
- Built tough, easy to install and can be recycled.

DC06

DC09

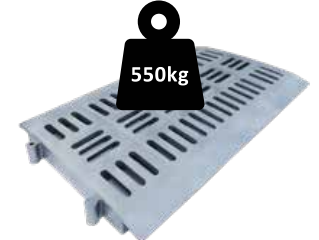
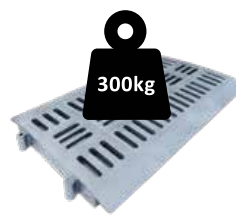

Maximum static load

Size:

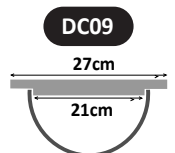
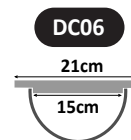
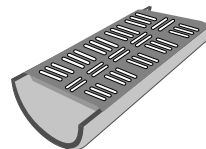
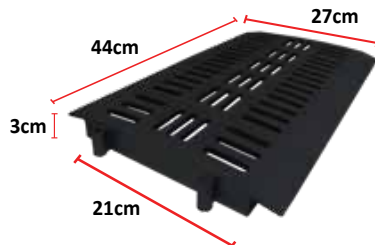
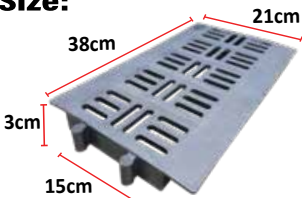

HEAVY DUTY DRAIN COVER 沟渠盖		
	SMALL	LARGE
Model Code	DC06	DC09
Barcode	9555221310847	9555221310854
Packing	12pcs / bag; 144pcs / carton	9pcs / bag; 108pcs / carton
Size (cm)	6" x 15"	8.5" x 17"
Load Bearing	300kg	550kg
Color	■	■

- Suitable to uses at houses, warehouse, gardens, factory side and etc.
- Built tough, easy to install and can be recycled.

Features:

- For easier carry and moving.
- Can used to carry huge dustbin.
- Heavy duty, high durable, compact design, sturdiness.
- 6 compact roller more balancing, support and stability.



*Kaki tong gas



*3018 can paired with bin V8120.



5 Wheels



*Maximum static load

HEAVY DUTY MULTIPURPOSE ROUND TROLLEY (5 WHEELS) 多用途多轮推车	
Model Code	3018
Barcode	955522131198
Size (cm)	37 (ø) x 10 (H)
Load Bearing	100kgs
Packing	48 units / carton
Color	● ●

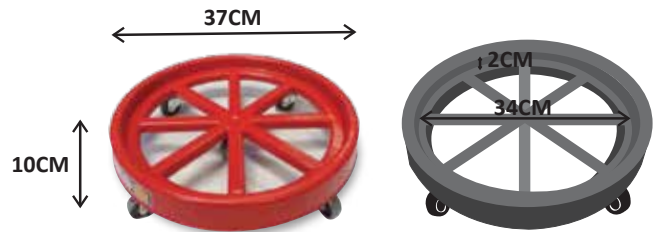

*3017 can paired with bin V8150, V8800 and V8800-2.



6 Wheels

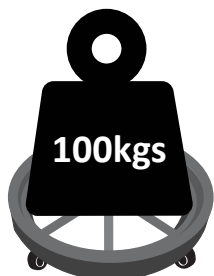

*Maximum static load

HEAVY DUTY MULTIPURPOSE ROUND TROLLEY (6 WHEELS) 多用途多轮推车	
Model Code	3017
Barcode	9555221307069
Size (cm)	42 (ø) x 10 (H)
Load Bearing	100kgs
Packing	48 units / carton
Color	○



High-quality hook, ▶
much more convenient to
hang things such as umbrella
and others



RAYACO PLASTIC HANDTRUCK	
Model Code	R1-200P
Barcode	9555221309810
Loading Capacity	200 KG
Size (mm)	820x480x840
Packing	50 units / pallet



◀ High-quality wheels,
smooth loading,
noiseless



84 cm



Economy Wheel



◀ The functional design includes a
convenient storage plastic pocket
put document and other items

VIP HANDTRUCK	
Model Code	VI-155P
Barcode	9555221309858
Loading Capacity	150 KG
Size (mm)	720x480x830
Packing	50 units / pallet



* The world's first fully plastic platform material except the wheels
* Installation not included, handtruck wheel sets can be sold separately



RAYACO HEAVY DUTY HANDTRUCK		重型手推车	
Model Code	RI-150	RI-300	RI-500
Barcode	9555221307427	9555221307434	9555221307441
Loading Capacity	150 Kgs	300 Kgs	500 Kgs
Size (mm)	725x475x830	900x595x875	1110x695x875
Total Weight	10.38 kg	13.24 kg	18.24 kg
Packing	50 units / pallet	50 units / pallet	50 units / pallet



VIP HANDTRUCK		手推车	
Model Code	VI-150	VI-300	
Barcode	9555221308431	9555221308448	
Loading Capacity	150 Kgs	300 Kgs	
Size (mm)	725x475x830	900x595x875	
Total Weight	9.72 kg	13.56 kg	
Packing	50 units / pallet	50 units / pallet	

* Note 1: Wheel sets only available

* Note 2: Installation not included, handtruck wheel sets can be sold separately

Back - Swivel Wheel

Front - Fix Wheel



ECONOMIC HANDTRUCK WHEEL SETS	
Model Code	V4100P
For Handtruck Model	VI-155P
Wheel Size	10 cm
Wheels	2 pcs Swivel and 2 pcs Fix

Back - Swivel Wheel

Front - Fix Wheel



HEAVY DUTY HANDTRUCK WHEEL SETS	
Model Code	R4100
For Handtruck Model	RI-150 / RI-200P
Wheel Size	10 cm
Wheels	2 pcs Swivel and 2 pcs Fix

Back - Swivel Wheel

Front - Fix Wheel



HEAVY DUTY HANDTRUCK WHEEL SETS	
Model Code	R4125
For Handtruck Model	RI-300
Wheel Size	12 cm
Wheels	2 pcs Swivel and 2 pcs Fix

Back - Swivel Wheel

Front - Fix Wheel



HEAVY DUTY HANDTRUCK WHEEL SETS	
Model Code	R6125
For Handtruck Model	RI-500
Wheel Size	12 cm
Wheels	4 pcs Swivel and 2 pcs Fix

Back - Swivel Wheel

Front - Fix Wheel



Back - Swivel Wheel

Front - Fix Wheel



STANDARD HANDTRUCK WHEEL SETS		
Model Code	V4100	V4125
For Handtruck Model	VI-150	VI-300
Wheel Size	10 cm	12 cm
Wheels	2 pcs Swivel and 2 pcs Fix	



Usage for durian factory, factory warehouse, even transportation use or commercial usage.



◀ Logo and color can be customized

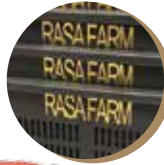

Metal Handle



METAL HANDLE INDUSTRIAL CONTAINER 铁柄工业蓝	
Model Code	103
Barcode	9555221308318
Size (cm)	69cm (L) x 49cm (W) x 42cm (H)
Packing	10 units / pallet
Color	● ● ●

*Note 1: Container can be sold without handle
Note 2: Logo and color can be customized, Terms & Conditions apply



◀ Logo and color can be customized



Usage for durian factory, factory warehouse, even transportation use or commercial usage.

COMMERCIAL INDUSTRIAL CONTAINER 铁柄工业蓝	
Model Code	V103X
Size (cm)	69cm (L) x 49cm (W) x 42cm (H)
Packing	10 units / pallet
Color	●

*Note 1: Container can be sold without handle
Note 2: Logo and color can be customized, Terms & Conditions apply

PLASTIC & METAL HANDLE FRUIT AND VEGETABLE BASKET (BLACK)



*Usage for fruit factory, factory warehouse, even transportation use or commercial usage.



V103 (BIG)



V1034 (SMALL)

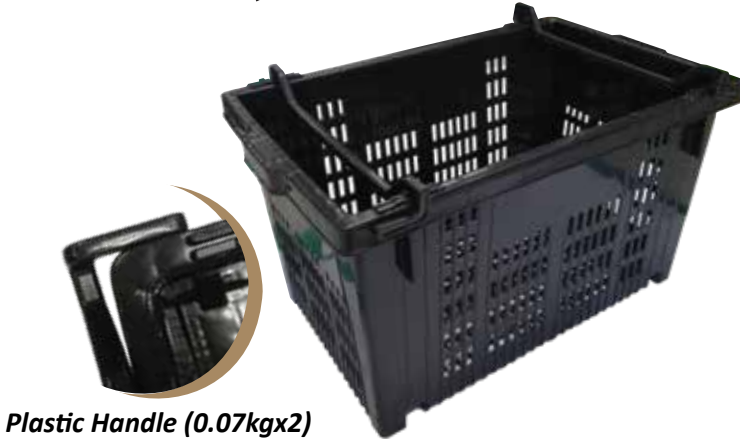

Plastic Handle (0.07kgx2)



Metal Handle

PLASTIC HANDLE FRUIT AND VEGETABLE BASKET (BLACK) 塑料柄工业蓝	
Model Code	VP1034
Barcode	9555221312421
Size (cm)	59cm (L) x 37cm (W) x 32cm (H)
Packing	10 units / pallet
Color	●

*Note 1: Container can be sold without handle
Note 2: Logo and color can be customized, Terms & Conditions apply

METAL HANDLE FRUIT AND VEGETABLE BASKET (BLACK) 铁柄工业蓝	
Model Code	V1034
Barcode	9555221312391
Size (cm)	59cm (L) x 37cm (W) x 32cm (H)
Packing	10 units / pallet
Color	●

*Note 1: Container can be sold without handle
Note 2: Logo and color can be customized, Terms & Conditions apply

METAL HANDLE FRUIT AND VEGETABLE BASKET



Logo and color ▶
can be customized



Metal Handle

*Usage for fruit factory, factory warehouse, even transportation use or commercial usage.



V103 (BIG)

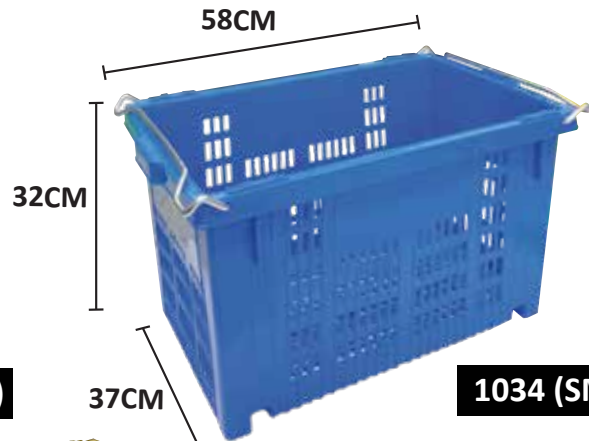

1034 (SMALL)



METAL HANDLE FRUIT AND VEGETABLE BASKET 铁柄工业篮	
Model Code	1034
Size (cm)	58cm (L) x 37cm (W) x 32cm (H)
Packing	10 units / pallet
Color	●●●●

*Note 1: Container can be sold without handle

Note 2: Logo and color can be customized, Terms & Conditions apply

METAL HANDLE FRUIT AND VEGETABLE BASKET (BLACK)



Logo and color ▶
can be customized



Metal Handle

*Usage for fruit factory, factory warehouse, even transportation use or commercial usage.



MODEL V103



***HEAVY DUTY**



MODEL V104



***STANDARD**

METAL HANDLE FRUIT AND VEGETABLE BASKET (HEAVY DUTY) 铁柄工业蓝	
Model Code	V103
Barcode	9555221308301
Size (cm)	69.5cm (L) x 49cm (W) x 42cm (H)
Weight (kg)	3.81kg
Packing	10 units / pallet
Color	●

*Note 1: Container can be sold without handle
Note 2: Logo and color can be customized, Terms & Conditions apply

METAL HANDLE FRUIT AND VEGETABLE BASKET (STANDARD) 铁柄工业蓝	
Model Code	V104
Barcode	9555221312438
Size (cm)	69.5cm (L) x 49cm (W) x 42cm (H)
Weight (kg)	3.80kg
Packing	10 units / pallet
Color	●

*Note 1: Container can be sold without handle
Note 2: Logo and color can be customized, Terms & Conditions apply

METAL HANDLE FRUIT AND VEGETABLE BASKET

*Usage for fruit factory, factory warehouse, even transportation use or commercial usage.



NEW VERSION



OLD VERSION



METAL HANDLE FRUIT AND VEGETABLE BASKET 铁柄工业蓝	
Model Code	103
Size (cm)	69.5cm (L) x 49cm (W) x 42cm (H)
Packing	10 units / pallet
Color	●●●●

*Note 1: Container can be sold without handle

Note 2: Logo and color can be customized, Terms & Conditions apply



- Can use for put vegetable, fruit, bread, stock for easy move and display.
- Usually use at fruit rack, storage rack, store storage, factory.

HDPE POULTRY INDUSTRIAL TRAY 禽业用篮

Model Code	114
Barcode	9555221307489
Packing	10 units / pallet
Color	

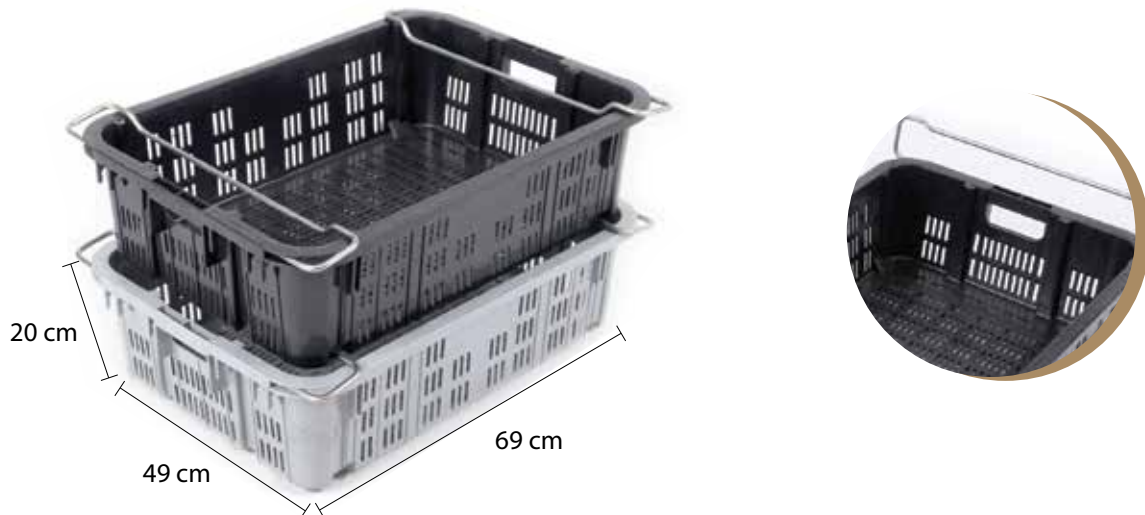

METAL HANDLE INDUSTRIAL CONTAINER 铁柄工业篮

Model Code	V1052
Barcode	9555221306741
Packing	10 units / pallet
Color	

Strong load bearing



Top reinforcement



Avoid hurting hands

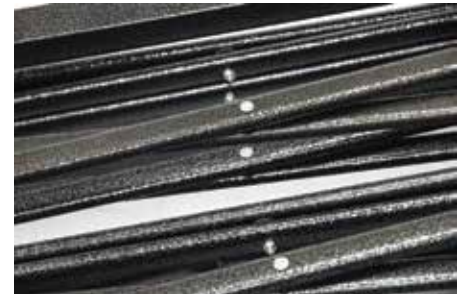

Economy series (STANDARD B) 扁铁



Rain & sun protection canopy cloth



CANOPY BLACK STEEL (STANDARD B) 黑钢扁铁帐篷				
	6" X 6" (±11kgs)	8" X 8" (±13kgs)	10" X 10" (±15kgs)	10" X 15" (±20kgs)
Model Code	CA2020	CA2525	CA3030	CA3045
Barcode	9555221307632	9555221309728	9555221309728	9555221309728
Weight	10/11kg	12/13kg	12/13kg	12/13kg
Packing	50 pcs / pallet	50 pcs / pallet	50 pcs / pallet	50 pcs / pallet

VIP SERIES (HEAVY DUTY AAA) 方铁

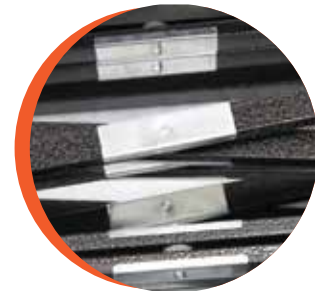

CANOPY BLACK STEEL				
	8"X8" (±19kgs)	10"X10" (±22kgs)	10"X15" (±28kgs)	10"X20" (±35kgs)
Model Code	CB2525	CB3030	CB3045	CB3060
Barcode	9555221307007	9555221307014	9555221307021	9555221309735
Weight	18/19 kg	21/22 kg	27/28 kg	34/35 kg
Packing	50 pcs / pallet	50 pcs / pallet	30 pcs / pallet	30 pcs / pallet

SUPER HEAVY DUTY SERIES



CANOPY BLACK STEEL				
	10"X10" (±33kgs)	10"X15" (±42kgs)	13"X20" (±65kgs)	13"X26" (±80kgs)
Model Code	CM3030	CM3045	CM4060	CM4080
Weight	32/33 kg	41/42 kg	63/65 kg	80/82 kg
Packing	10 pcs / pallet	10 pcs / pallet	6 pcs / pallet	6 pcs / pallet

*Disclaimer: Canopy weight might vary due to cloth thickness



*关后4尺高，可直接放进车尾箱，配有4套拉绳地厚钉以稳固帐篷。
The canopy will be 4 feet tall when it is closed. It can be put directly into the trunk of the car. Equipped with 4 sets of drawstrings and thick nails inserted in the ground to stabilize the canopy.



* Interior canopy top



CANOPY WHITE STEEL 便携式帐篷	
	10' X 10' (±13kgs)
Model Code	CF3030
Weight	12/13 kg
Packing	50 pcs / pallet



CANOPY IRON PLATE

Model Code	IP5
Weight	5 kgs
Size	21cm (H) x 20cm (W)
Packing	4 pcs / carton

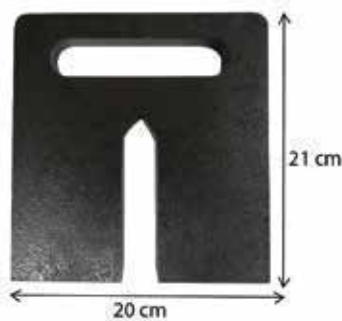

*Suitable for outdoor, can protect canopy from floating up.

MODEL	DESCRIPTION	PACKING
CSW25	8ft Canopy Side Wall	40 pcs / Ctn
CSW25-W	8ft Canopy Side Wall with Window	40 pcs / Ctn
CSW30	10ft Canopy Side Wall	25 pcs / Ctn
CSW30-W	10ft Canopy Side Wall with Window	25 pcs / Ctn
CSW45	15ft Canopy Side Wall	20 pcs / Ctn
CSW45-W	15ft Canopy Side Wall with Window	20 pcs / Ctn
CSW30 x 3	9meter Canopy Side Wall With Window (For 10" x 10" Canopy)	8 pcs / Ctn
CSW30Z	10ft Canopy Side Wall With Zip	25 pcs / Ctn

*Disclaimer: Canopy weight might vary due to cloth thickness





Bersatu series (STANDARD AA) 方铁



Comfortable height adjustment

FEATURES



Suitable for commerce, residence community, places of entertainment, outside wedding, sports event, party, exhibition, trade fair, product show and celebration

CANOPY BLACK STEEL (STANDARD AA) 黑钢方铁帐篷				
	6" X 6" (±15kgs)	8" X 8" (±18kgs)	10" X 10" (±19kgs)	10" X 15" (±25kgs)
Model Code	CS2020	CS2525	CS3030	CS3045
Barcode	9555221307694	9555221307601	9555221307618	9555221307625
Weight	14/15kg	17/18kg	18/19kg	24/25kg
Packing	50 pcs / pallet	50 pcs / pallet	50 pcs / pallet	50 pcs / pallet



*Excellent choice to be used at night market, wedding events, catering event and as car park shelter.



CANOPY CLOTH

MODEL	DESCRIPTION	PACKING
CKA2525	Canopy Cloth 420D (8x8)	10 pcs/ Ctn
CKA3030	Canopy Cloth 420D (10x10)	10 pcs/ Ctn
CKA3045	Canopy Cloth 420D (10x15)	10 pcs/ Ctn
CKS2020	Canopy Cloth 600D (6x6)	10 pcs/ Ctn
CKS2525	Canopy Cloth 600D (8x8)	10 pcs/ Ctn
CKS3030	Canopy Cloth 600D (10x10)	10 pcs/ Ctn
CKS3045	Canopy Cloth 600D (10x15)	5 pcs/ Ctn
CKS2020	Canopy Cloth 420DD (灰胶底) (6x6)	10 pcs/ Ctn
CKS2525	Canopy Cloth 420DD (灰胶底) (8x8)	10 pcs/ Ctn
CKS3030	Canopy Cloth 420DD (灰胶底) (10x10)	10 pcs/ Ctn
CKS3045	Canopy Cloth 420DD (灰胶底) (10x15)	5 pcs/ Ctn
CKB2525	Canopy Cloth 600DD (加厚) (8x8)	10 pcs/ Ctn
CKB3030	Canopy Cloth 600DD (加厚) (10x10)	10 pcs/ Ctn
CKB3045	Canopy Cloth 600DD (加厚) (10x15)	5 pcs/ Ctn
CKB3060	Canopy Cloth 600DD (加厚) (10x20)	5 pcs/ Ctn
CKB2525	Canopy Cloth 800DDD (8x8)	10 pcs/ Ctn
CKB3030	Canopy Cloth 800DDD (10x10)	10 pcs/ Ctn
CKB3045	Canopy Cloth 800DDD (10x15)	5 pcs/ Ctn
CKB3060	Canopy Cloth 800DDD (10x20)	5 pcs/ Ctn

*****Suitable Wear In all Kind Of Outdoor Environment**



●Farmer●



●Orchard Worker●



●Construction Worker●



STRAW HAT 花草帽	
20"	
Model Code	A20-E
Barcode	9555221306291
Packing	6 dozens / bag ; 15 dozens / bag



PLASTIC HAT 塑料帽		
Model Code	20P	18P
Barcode	9555221304259	9555221304266
Packing	120 pcs / carton	120 pcs / carton



FEATURES :

- Durable, light weight, comfortable.
- Suitable for all types of work, especially for plumbing, repairing, gardening and factory work.

COLOR COTTON GLOVE 彩色幼纱手套		
Model Code	GF401C	GF501C
Barcode	9555221305713	9555221305720
Weight	400g	500g
Packing	50 dozens / bag	50 dozens / bag

COLOR COTTON GLOVE 彩色幼纱手套		
Model Code	GF760	GF1200
Barcode	9555221305737	9555221305744
Weight	800g	1000g
Packing	50 dozens / bag	50 dozens / bag



WHITE COTTON GLOVE 白色幼纱手套		
Model Code	GF401	GF501
Barcode	9555221305713	9555221305720
Weight	400g	500g
Packing	50 dozens / bag	50 dozens / bag



XL TONG 挟子	
Description	Packing
No. 1 Tong (60cm)	50 units / carton
No. 2 Tong (50cm)	50 units / carton
No. 3 Tong (45cm)	50 units / carton
No. 4 Tong (38cm)	100 units / carton
No. 5 Tong (35cm)	100 units / carton

SICKLE 镰刀	
Model Code	S1205
Barcode	9555221304310
Packing	60 units / carton



STRAW MAT WITH BINDING 草席	
Model Code	3x6M
Size	34.5" x 66"
Packing	100 units / carton

GARDEN SCISSORS 花园剪刀		
Code	6023 (Branch)	6022 (Leaf)
Barcode	9555221305157	9555221306352
Size (cm)	14cm (L)	16cm (L)
Packing	24 pcs/ box; 144 pcs/ carton	24 pcs/ box; 144 pcs/ carton



6022

6023

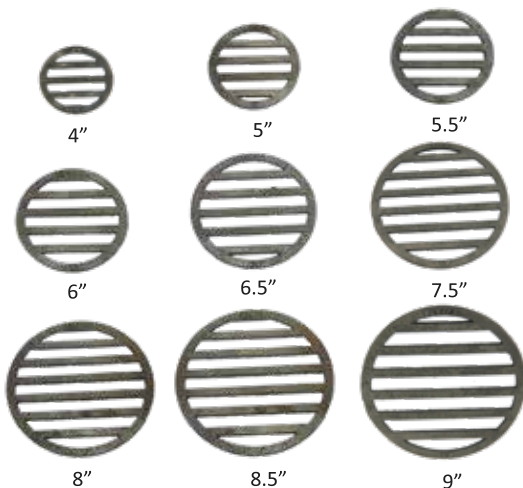

IRON GRATE 铁炉排	
Description	Packing
Iron Grate 4	240 units / carton
Iron Grate 4.5	200 units / carton
Iron Grate 5	150 units / carton
Iron Grate 5.5	150 units / carton
Iron Grate 6	100 units / carton
Iron Grate 6.5	80 units / carton
Iron Grate 7	60 units / carton
Iron Grate 7.5	60 units / carton
Iron Grate 8	50 units / carton
Iron Grate 8.5	50 units / carton
Iron Grate 9	30 units / carton



- 100% Virgin Material
- Non Toxic
- Eco Friendly



- Food Grade
- Multipurpose
- Suitable for both hand
- Extra Thickness
- Good for more heavy duty work

DISPOSABLE PLASTIC PE GLOVE

Model Code	PG100	PG101	PG102
Barcode	9555221310021	9555221310038	9555221310045
Packing	100 box/ctn	72 box/ctn	48 box/ctn



Standard
(PG100)



Heavy Duty
(PG101)



Super Heavy Duty
(PG102)

DISPOSABLE SERIES 一次性用品



VT10

VT15

VT20

VT35

PESTICIDE & TRAP SERIES 粘蝇/粘鼠板&捕鼠器					
	Fly Catcher	Mouse Trap	Quality Mouse Trap	Heavy Duty Mouse Trap	Mouse T
Model Code	VT10	VT15	VT20	VT35	MT169
Barcode	9555221307977	9555221307960	9555221307809	9555221307816	9555221
Packing	100 pcs / box; 20 boxes / carton	20 pcs / box; 200 pcs / carton	24 pcs / box; 144 pcs / carton	24 pcs / box; 144 pcs / carton	2 pcs / p 100 pkt



CAUTION: Please be careful when handle the mou
Dont touch the bait adjuster when the trap is engag



How to use :



Turn the lower bait adjuster counterclockwise and pull it out to view.



Put the bait (ham, peanut, bread, etc.), then put it back.



Push down on the back of the mouse trap press until it engages with the bottom.



Place it in a place where rats often lay eggs in holes, corners, sides of doors, etc. The distance between the placement position must be 1cm away.

MOUSE TRAP SERIES 捕鼠器	
Model Code	MT148
Barcode	9555221310830
Size	72mm x 140mm x 75mm
Packing	200pcs / carton

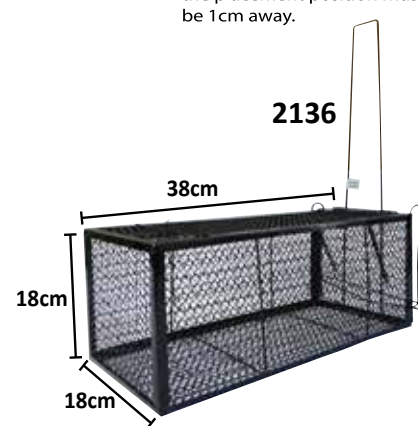
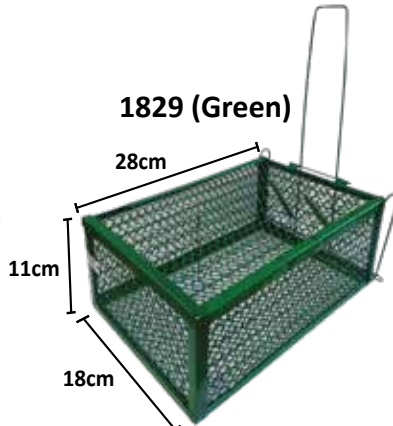
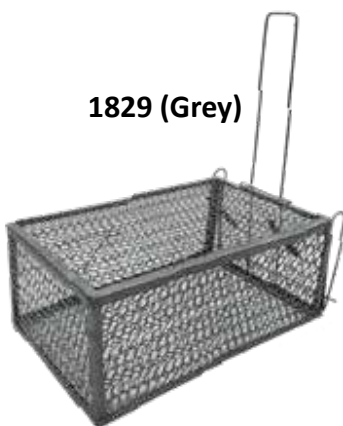

MOUSE TRAP SERIES 捕鼠器		
	Large Mouse Trap	XL Mouse Trap
Model Code	1829	2136
Barcode	9555221307274	9555221307342
Size	28cm (L) x 11cm (H) x 18cm (W)	38cm (L) x 18cm (H) x 18cm (W)
Packing	20 pcs / carton	16 pcs / carton
Color		

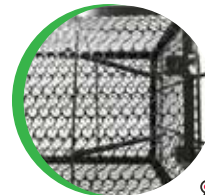

RAYACO®

大大牌

☎ : 603 - 6091 9588, 603 - 6091 8630

☎ : 603 - 6091 9618, 603 - 6091 9619

✉ : rayaco@rayaco.com.my

🌐 : www.rayaco.com.my



All photographs are for visual purposes only. Actual products color may be various.

RAYACO®

vip

vip MEDPRO®

RAYACO PRO®