



MIDK

Rain Gutters
Collection



upvc **RAIN
GUTTERS
& FITTINGS**



Tablet of CONTENTS

02

ABOUT US

- ◆ OUR COMPANY
- ◆ BRAND MISSION

03

WHAT'S RAIN GUTTER

- ◆ WHY CHOOSE MIDDY
- ◆ ABOUT OUR MIDDY RAIN GUTTER

04

HONORS & QUALIFICATIONS

- ◆ CERTIFICATE

05

G100 RAIN GUTTER

- ◆ RAIN GUTTER & FITTINGS

06

G380 RAIN GUTTER

- ◆ RAIN GUTTER & FITTINGS

07

RAIN GUTTER GUIDELINE

- ◆ TECHNICAL GUIDELINE
- ◆ PROJECT SPECIFICATIONS
- ◆ SITE ANALYSIS & CALCULATION
- ◆ INSTALLATION STEPS
- ◆ STORAGE INSTRUCTIONS

About us

OUR COMPANY

Established in 2001, **MIDDY** is a fast-growing manufacturer of rain gutter system products in Malaysia. We are committed to delivering exceptional products and services to exceed our customers' expectations, both locally and globally.



◆ COTTAGE SITE, DENGKIL

“ Responsible Services, Consistent Quality
Reasonable Prices, Continuous Improvements. ”

BRAND MISSION

WHAT'S RAIN GUTTER

MIDDY Rain Gutter System

- ◆ Leads rainwater from roof to the ground level
- ◆ Prevents water damage to the roof and building

efficient rain gutters can enhance your home



◆ PETALING JAYA

WHY CHOOSE MIDDY?

- ◆ Improvement and innovation
- ◆ Focusing in user-friendly design
- ◆ Quality Control - Original uPVC raw material
- ◆ Site visit & professional consultation
- ◆ On-time local deliveries & export services

ABOUT OUR MIDDY uPVC RAIN GUTTER



ENHANCE QUALITY



LONGEVITY & DURABILITY



COST-EFFECTIVE



ECO-FRIENDLY



WEATHER RESISTANCE



RAIN HARVEST SYSTEM

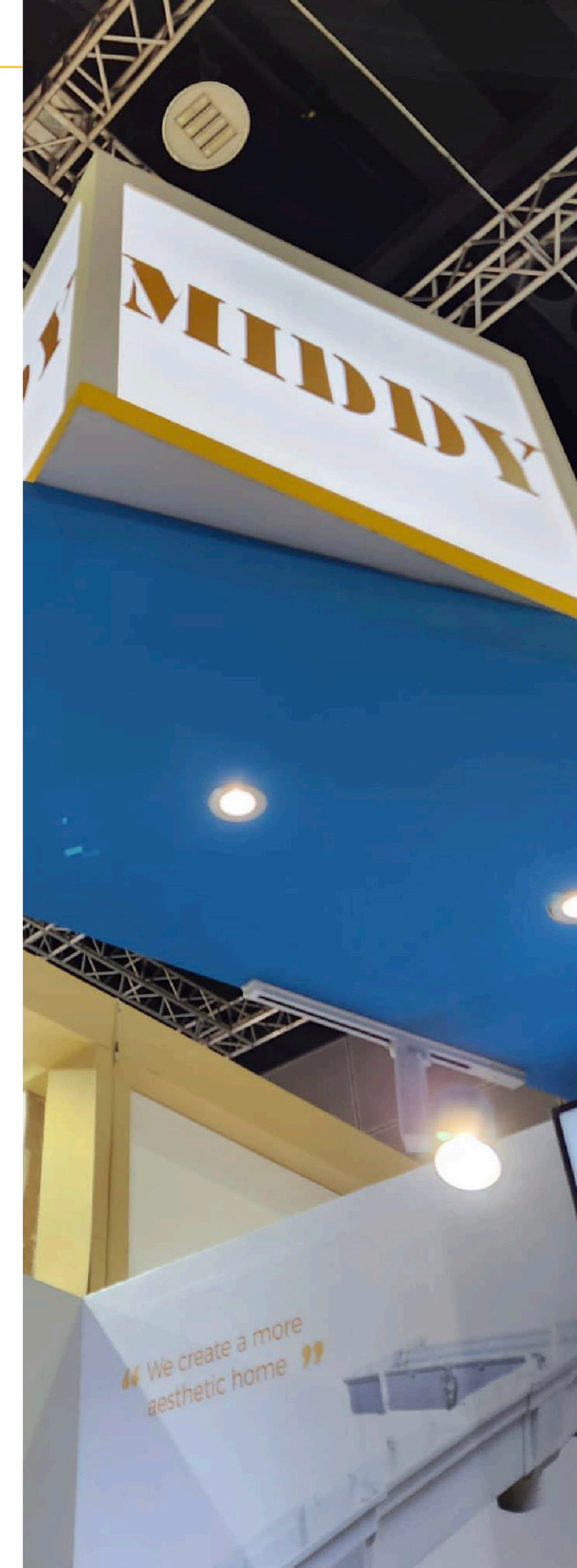

HONORS AND QUALIFICATIONS



No Lesen : PC000047
Licence No :

LESEN PENSIJILAN BARANGAN
Product Certification Licence

SIRIM QAS International Sdn. Bhd. dengan ini menganugerahkan kepada SIRIM QAS International Sdn. Bhd. hereby grants to

MIDDY INDUSTRIES SDN.BHD.
NO.3, JALAN KPK 1/7,
KUNDANG JAYA INDUSTRIAL
48020 RAWANG
SELANGOR, MALAYSIA

Lesen untuk menggunakan Tanda Pensijilan di atas barangan
a licence to use the Certification Mark on

UNPLASTICIZED POLYVINYL CHLORIDE (PVC-U) EAVES GUTTER
Please refer to detail in the SCHEDULE

sebagai mematuhi keperluan
as complying with

BS EN 607 : 2004

Nur Fadhliah binti Muhammad
Ketua Pegawai Eksekutif
Chief Executive Officer
SIRIM QAS International Sdn. Bhd.

SIRIM QAS International Sdn. Bhd.
(No. Syarikat: 1956103798(418334-X))

Tarikh Mula Pensijilan : 06 January 2012
Tarikh Dikeluarkan : 28 December 2023

Certified Since
Sah Sehingga : 06 January 2025
No Siri : 093141
Serial No

1. Penerimaan Dato' Menteri
Sekayen 2. Padi Selayan 7035
40700 Shah Alam
Selangor Darul Ehsan
MALAYSIA.

Tel : 603-3544 6400
Email : cert@qasinternational.com.my
<https://www.malaysiancertified.com.my>

No Lesen : PC000047
Licence No :

SCHEDULE
MIDDY INDUSTRIES SDN.BHD.

Trade Mark : MIDDY
Model : G100
Type : GREY, BROWN, WHITE, GREEN, BLUE
Size : OPENING WIDTH: 170mm; LENGTH : 2.9m, 4m, 5.8m and 6m

Trade Mark : MIDDY
Model : G380
Type : GREY, BROWN, WHITE, GREEN, BLUE
Size : OPENING WIDTH: 205mm; LENGTH : 2.9m, 4m, 5.8m and 6m

— End of page —

SIRIM QAS International Sdn. Bhd.
(No. Syarikat: 1956103798(418334-X))

Tarikh Mula Pensijilan : 06 January 2012
Tarikh Dikeluarkan : 28 December 2023

Certified Since
Sah Sehingga : 06 January 2025
No Siri : 093141
Serial No

1. Penerimaan Dato' Menteri
Sekayen 2. Padi Selayan 7035
40700 Shah Alam
Selangor Darul Ehsan
MALAYSIA.

Tel : 603-3544 6400
Email : cert@qasinternational.com.my
<https://www.malaysiancertified.com.my>

Page 1 of 1

You may contact us for the further assistance.

a classic box gutter

G100 SERIES

Classic Box UPVC gutter combines classic aesthetics with large capacity, customer-friendly price, durability, strong construction and corrosion resistance. It is a reliable and durable choice for building drainage systems.



INDUSTRIAL DESIGN NO.MY01-00372

G100

G100 RAIN GUTTER

DIMENSIONS (mm)				LENGTH (m)
A	B	C	D	
150	170	140	120	4 / 5.8

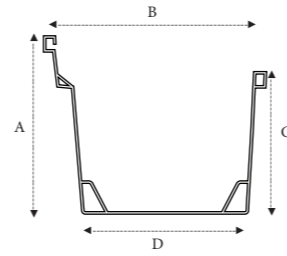

ACCESSORIES ▼

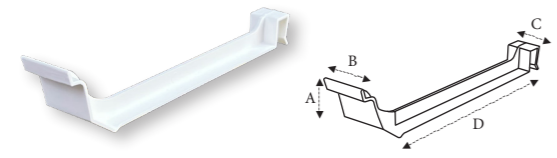

GUTTER STRAP

DIMENSIONS (mm)			
A	B	C	D
40	30	20	190

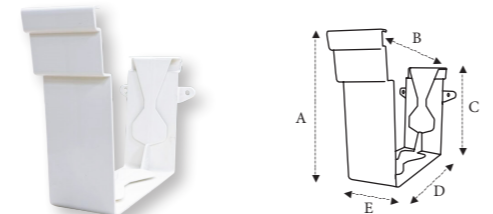

SOCKET

DIMENSIONS (mm)				
A	B	C	D	E
156	195	125	146	58

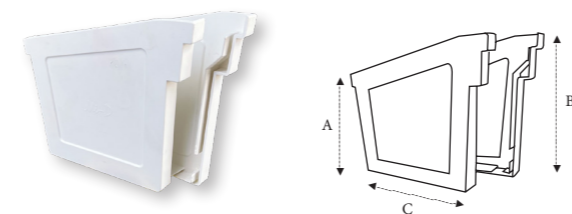

END CAP (RIGHT & LEFT)

DIMENSIONS (mm)		
A	B	C
125	155	145

BRACKET SERIES ▼

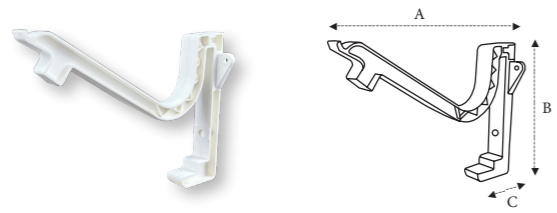

INTERNAL BRACKET

DIMENSIONS (mm)		
A	B	C
202	147	50

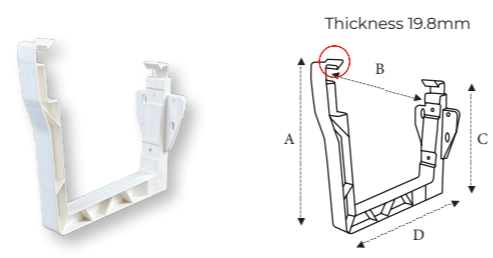

EASY FAST BRACKET

DIMENSIONS (mm)			
A	B	C	D
175	190	147	180

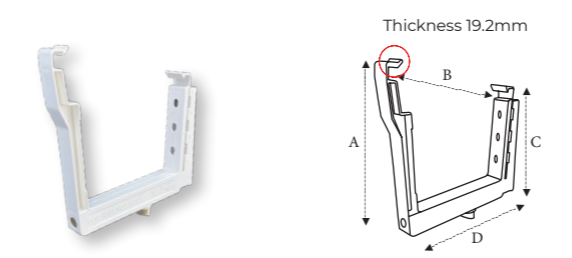

ADJUSTABLE BRACKET

DIMENSIONS (mm)			
A	B	C	D
180	186	150	175

OUTLET SERIES ▼

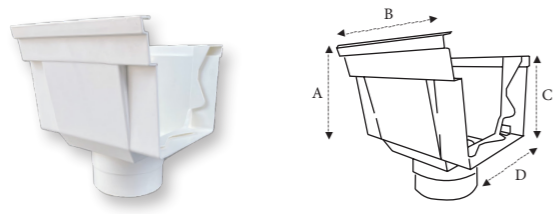

OUTLET FIN 3" AND 4"

DIMENSIONS (mm)				OUTLET SIZE	
A	B	C	D	3"	4"
155	220	125	145	80/82	100/110

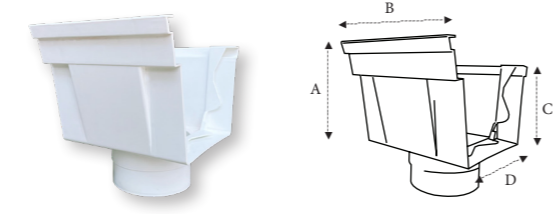

OUTLET FIN V2 3" AND 4"

DIMENSIONS (mm)				OUTLET SIZE	
A	B	C	D	3"	4"
155	185	125	145	80/82	100/110

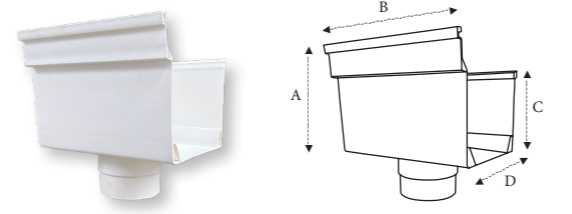

OUTLET FAB

DIMENSIONS (mm)				OUTLET SIZE	
A	B	C	D	3"	4"
155	207	160	120	80/82	100/110

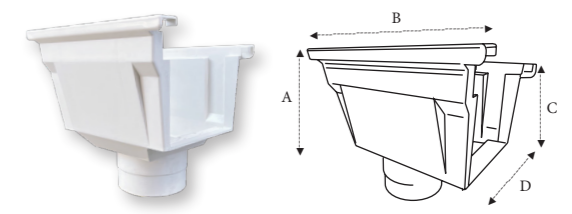

ORIGINAL OUTLET 4"

DIMENSIONS (mm)				OUTLET SIZE	
A	B	C	D	3"	4"
155	220	125	145	80/82	100/110



What is GUTTER STRAP ?

Prevention, Protection, Maintenance
To prevent & protect the shape of gutters from deformation and maintain the qualities of uPVC Rain Gutters.



What is ORIGINAL OUTLET ?

Original Outlet is recommended as it allows spacing for uPVC Rain Gutter to move along during thermal expansion. No silicone, solvent cement or screw needed simplifies the installation process.

CORNER SERIES ▼

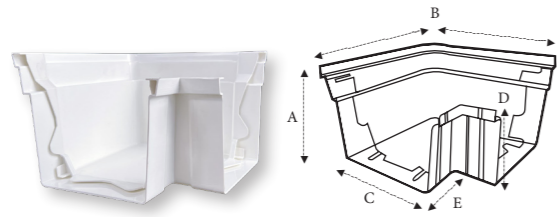

CORNER OUT

DIMENSIONS (mm)				
A	B	C	D	E
135	240	145	125	60

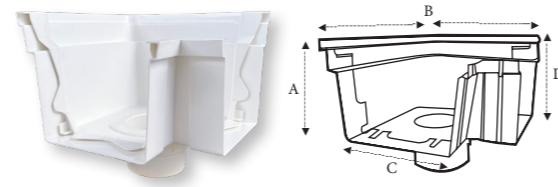

CORNER OUT C/W OUTLET 3" AND 4"

DIMENSIONS (mm)				OUTLET SIZE	
A	B	C	D	3"	4"
135	240	145	125	80/82	100/110

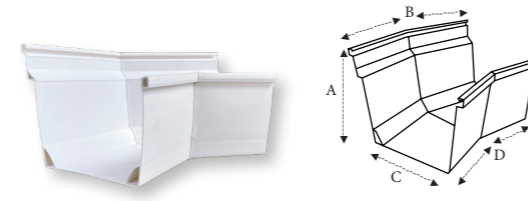

CORNER OUT 45°

DIMENSIONS (mm)			
A	B	C	D
120	440	145	320



What is **CORNER OUT** ?

Corner Out enables changes in direction at outward turns in gutter system.

CORNER SERIES ▼

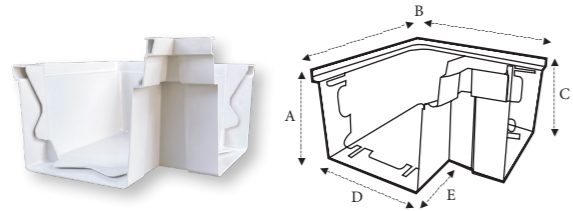

CORNER IN

DIMENSIONS (mm)				
A	B	C	D	E
135	240	135	145	75

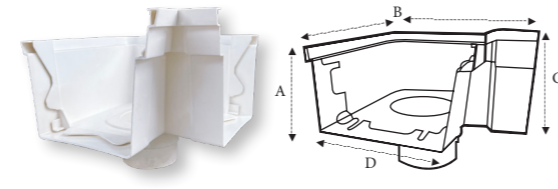

CORNER IN C/W OUTLET 3" AND 4"

DIMENSIONS (mm)				OUTLET SIZE	
A	B	C	D	3"	4"
135	240	155	145	80/82	100/110

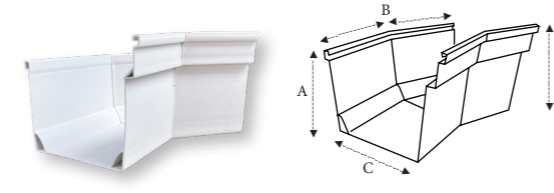

CORNER IN 45°

DIMENSIONS (mm)			
A	B	C	D
120	440	145	320



What is **CORNER IN** ?

Corner In is designed to connect uPVC Rain Gutter at angle turning inward.

“ MIDDY Rain Gutter
Protect your home ”

MASJID AL-MUJAHIDEEN,
PETALING JAYA

DESA VILLA MERAB, KAJANG



White
Trendy Design ▶
♦ MASJID AL-MUJAHIDEEN, PETALING JAYA



G100



a classic box

◀ *Grey*
Classic Design
♦ COTTAGE SITE, DENGKIL

rain gutter

Brown
Elegant Design ▶
♦ RESIDENTIAL AREA, PETALING JAYA



○ ○
G380 SERIES
a modern
wave gutter

The innovation of minimalist gutter design matches different architectural preferences with efficient water flow, the ability to remove debris and low maintenance with long-lasting performance.



INDUSTRIAL DESIGN NO.MY01-00919-0103

G380 RAIN GUTTER

DIMENSIONS (mm)				LENGTH (m)
A	B	C	D	
120	180	100	205	4/5.8

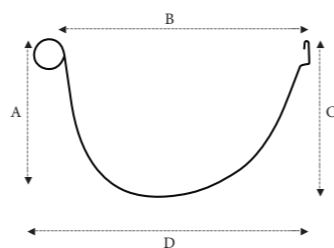

ACCESSORIES

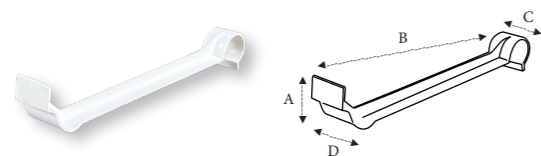

GUTTER STRAP

DIMENSIONS (mm)			
A	B	C	D
35	205	18	28

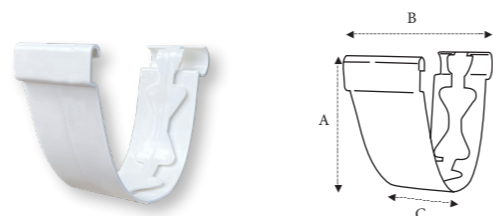

SOCKET

DIMENSIONS (mm)		
A	B	C
130	215	58



END CAP (RIGHT & LEFT)

DIMENSIONS (mm)		
A	B	C
190	10	110

BRACKET SERIES



INTERNAL BRACKET

DIMENSIONS (mm)		
A	B	C
210	135	105

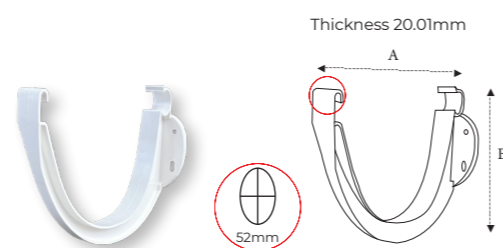

BRACKET

DIMENSIONS (mm)	
A	B
140	220

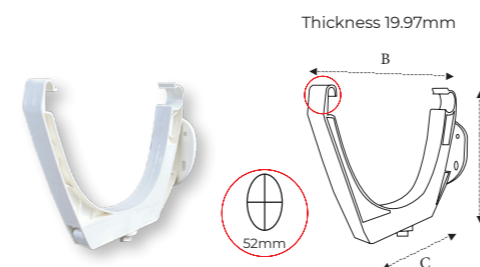

ADJUSTABLE BRACKET

DIMENSIONS (mm)		
A	B	C
150	215	120

OUTLET SERIES

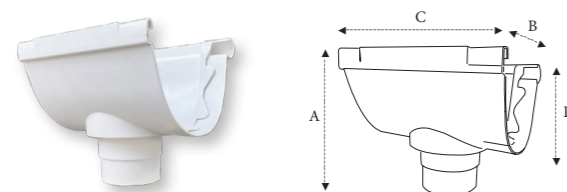

OUTLET FIN 3" AND 4"

DIMENSIONS (mm)				OUTLET SIZE	
A	B	C	D	3"	4"
180	210	210	120	80/82	100/110

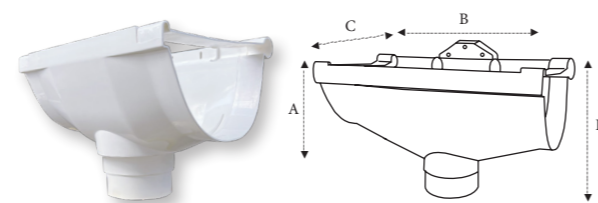

ORIGINAL OUTLET 3" AND 4"

DIMENSIONS (mm)				OUTLET SIZE	
A	B	C	D	3"	4"
130	296	210	210	80/82	100/110



What is **GUTTER STRAP** ?

Prolong, Preserve and Support
To support and preserve the shape of gutters and prolong the life of the gutter system.



What is **BRACKET** ?

Bracket is essential to provide support for the gutter system. Choosing the correct type of bracket is important for different situations.



What is **ORIGINAL OUTLET** ?

Original Outlet allows flexibility for the gutter's movement during thermal expansion. Original Outlet, with no silicone, solvent cement or screw required, reduces the risk of damage.

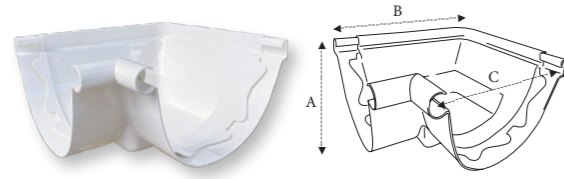

CORNER OUT

DIMENSIONS (mm)		
A	B	C
125	250	205

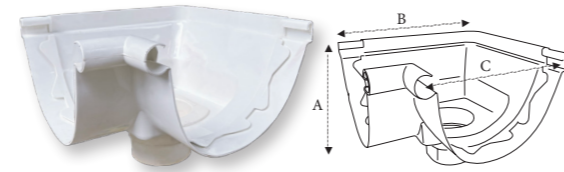

CORNER OUT C/W 3" AND 4"

DIMENSIONS (mm)			OUTLET SIZE	
A	B	C	3"	4"
180	250	205	80/82	100/110

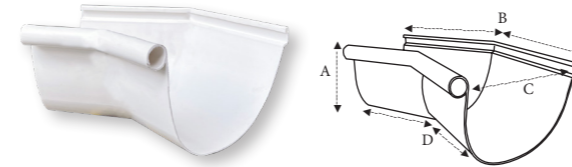

CORNER OUT 45°

DIMENSIONS (mm)			
A	B	C	D
125	345	155	210



What is **CORNER OUT** ?

Corner Out is used fo gutters to turn outward away from building.

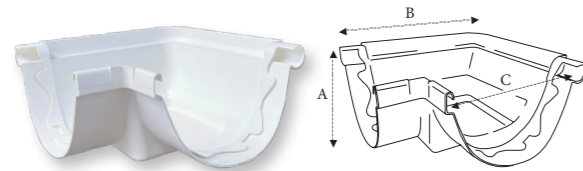

CORNER IN

DIMENSIONS (mm)		
A	B	C
125	265	210

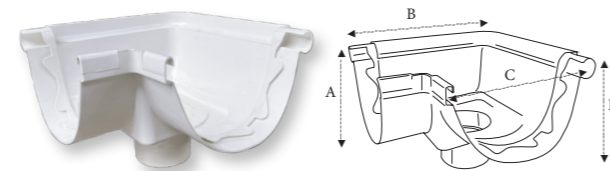

CORNER IN C/W OUTLET 3" AND 4"

DIMENSIONS (mm)			OUTLET SIZE	
A	B	C	3"	4"
185	265	208	80/82	100/110

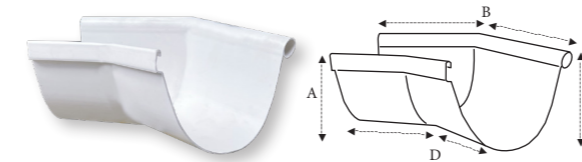

CORNER IN 45°

DIMENSIONS (mm)			
A	B	C	D
130	350	125	208



What is **CORNER IN** ?

Corner In is designed to smoothly transition the gutters around the inward-facing corner.



G380

White
Trendy Design ▶
♦ SMK DATO'S SAGO



a modern wave
rain gutter

Brown
Elegant Design ▶
♦ JKR, KUALA SELANGOR



TECHNICAL GUIDELINE

NOTICE :

2.9 meter MIDDY Rain Gutter System :
DIY - Friendly installation.

5.8 meter MIDDY Rain Gutter System :
Specialist installation recommended.

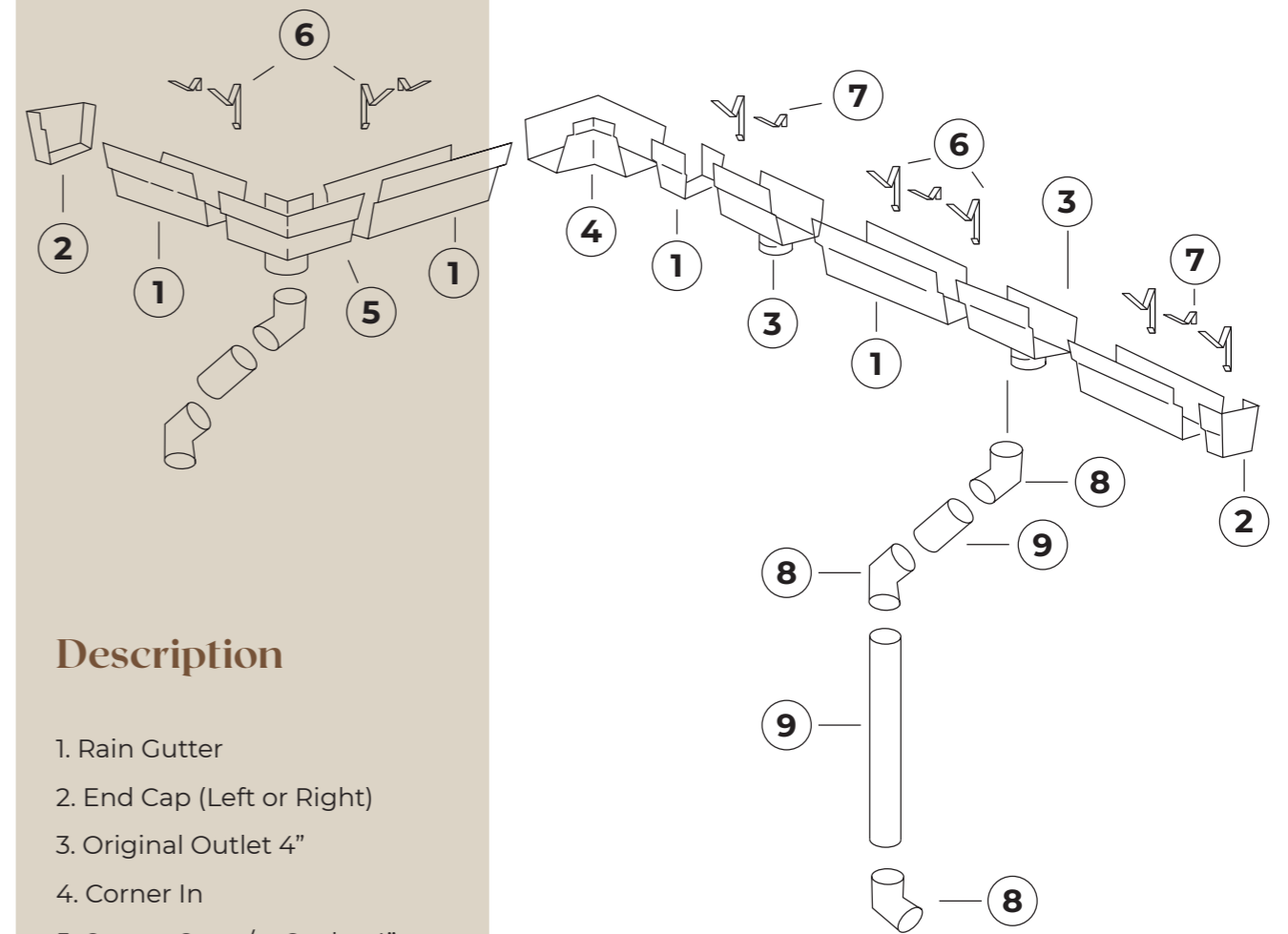

Description

- 1. Rain Gutter
- 2. End Cap (Left or Right)
- 3. Original Outlet 4"
- 4. Corner In
- 5. Corner Out c/w Outlet 4"
- 6. Internal Bracket
- 7. Gutter Strap
- 8. Bend 45°
- 9. Downpipe

PROJECT SPECIFICATIONS

For better maintenance against thermal expansion and contraction,

- ◆ Install brackets along an even fascia board.
- ◆ Every 5.8 meters of uPVC Rain Gutter should be installed with one piece of Original Outlet
- ◆ Both Gutter Straps & Brackets must be installed at 0.6 meters (2feet) intervals.



ORIGINAL OUTLET

- ◆ Proper equipment for installation against thermal expansion and contraction.
- ◆ Easy for installation, no silicone, solvent cement or screw required.





GUTTER STRAP

- ◆ The first manufacturer invented Gutter Strap.
- ◆ To protect the shape of uPVC Rain Gutter from deformation.
- ◆ To strengthen the qualities of uPVC Rain Gutter





INTERNAL BRACKET

- ◆ A hidden and modern solution
- ◆ To protect the shape of uPVC Rain Gutter from deformation.



G100 SERIES
WITH HIDDEN --->
INTERNAL BRACKET

⚠ ESSENTIAL GUIDE

A gutter system is required to drain the heavy rain which lasts at least two minutes. Intense rainfall can occur in Malaysia. The gutter installer must determine if the gutter system can effectively collect rainwater from the roof size.

The calculation below shows how to determine the volume of rainwater running off a roof.

THE CALCULATION

To calculate the volume of rainwater runoff from a roof, multiply the rainfall intensity by the roof area.



Volume of rainwater runoff a roof = **A x B**

THE EFFECTIVE ROOF AREA

The Effective Roof Area (ERA) can be determined by using the following calculations:

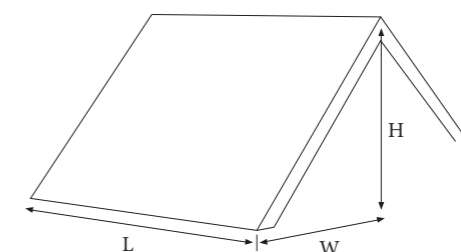

W = eaves under the ridge
H = vertical height from eaves to ridge
L = length of roof section

1

(Width + Height ²) x Length = Area (W + H ²) x L = A (m²)

R1 = (4m + 2.3m²) x 16m = 82.4m²
 R2 = (4m + 2.3m²) x 8m = 41.2m²
 R3 = (4m + 2.3m²) x 6m = 30.9m²
 R4 = (4m + 2.3m²) x 6m = 30.9m²

2

Length x Width x Pitch Factor (refer to table) = Area

L x W x Pitch = A (m²)

R1 = 16m x 4m x 1.288 = 82.4m²
 R2 = 8m x 4m x 1.288 = 41.2m²
 R3 = 6m x 4m x 1.288 = 30.9m²
 R4 = 6m x 4m x 1.288 = 30.9m²

Assume H=2.3m, Roof Pitch = 30° :

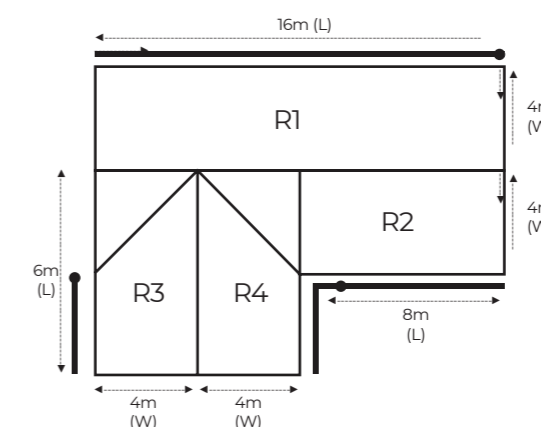

Roof Pitch	Pitch Factor
4.8°	1.003
9.5°	1.014
15°	1.134
17.5°	1.158
20°	1.182
22.5°	1.207
25°	1.233

Roof Pitch	Pitch Factor
27°	1.260
30°	1.288
32.5°	1.319
35°	1.350
37.5°	1.384
40°	1.419
42.5°	1.459

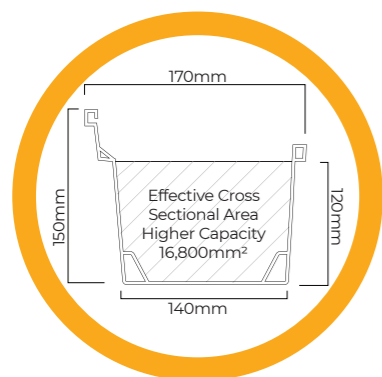

GUTTER PROFILE G100

CAPACITY (MAXIMUM)	GUTTER LENGTH	DOWNPIPE
739.508m ²	5.8m	110mm

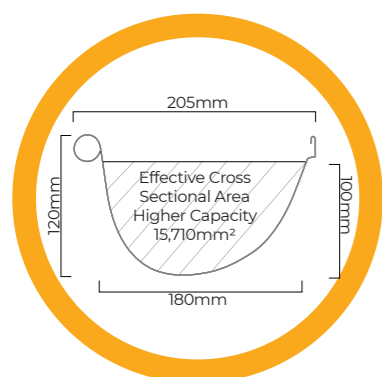

GUTTER PROFILE G380

CAPACITY (MAXIMUM)	GUTTER LENGTH	DOWNPIPE
512.825m ²	5.8m	110mm / 82mm

To determine if the MIDDY uPVC Rain Gutter can support the rainwater runoff, compare the volume of gutter with the volume of rainwater runoff.

Assuming the figure stated for R1, The volume of rainwater runoff = **A x B**

$$R1 = 0.00167m \times 82.4m^2 = 0.1376m^3 / \text{min}$$

$$\text{The volume of G100 Rain Gutter} = 0.0168m^2 \times 16m = 0.2688m^3$$

Volume of Gutter

Cross Sectional Area of Gutter x Length of Gutter needed

Meanwhile, when the volume of rainwater runoff \leq the volume of the gutter, MIDDY G100 Rain Gutter can support the rainfall.

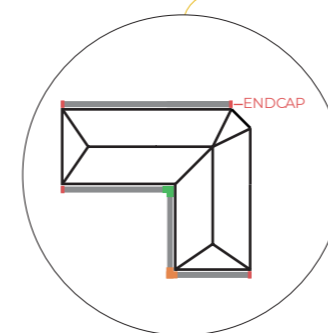

END CAP (L&R)

End Cap is required to be placed at the end of Rain Gutters. If the entire roof is surrounded by Rain Gutters, no end cap is required.

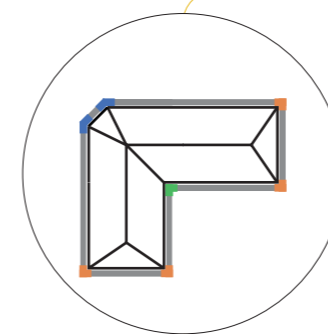

CORNER

Determine the angle of corner and choose the corner correctly with specific degree.

90° Corner Out 90° Corner In 45° Corner Out

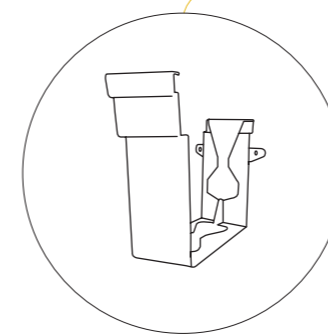

SOCKET

Socket is only required as a connector under a certain situation.

DOWNPIPE & FITTINGS



- DRAIN-DOWPIPE** measure the entire height of the house, dividing by 5.8 meters to determine the number of pipe needed.
- DOWNPIPE SOCKET** the end of each pipe requires a socket as connector.
- ELBOW / BEND** generally each outlet requires two 45° elbows to connect outlet to downpipe, and also one 90° elbow at the bottom of the downpipe to the drain.
- PIPE CLIP** pipe clip could secure and guide the downpipe to the wall

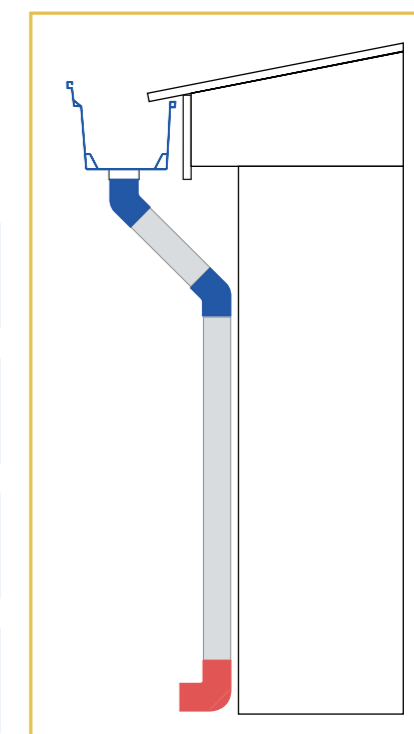

INSTALLATION GUIDE

Tool & Equipment for uPVC Rain Gutter system installation.

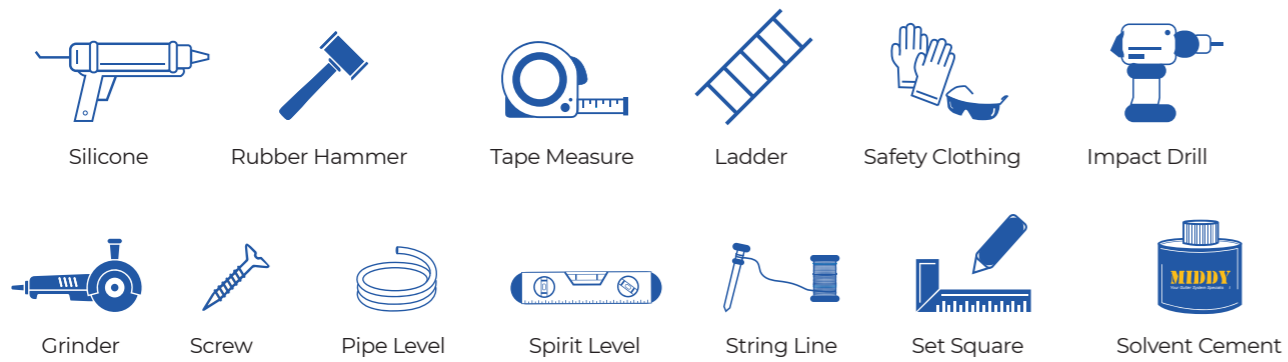

SITE ANALYSIS & CALCULATION

Proper instruction to install uPVC Rain Gutter system

01

Normal Fascia Board
Install Easy Fast Bracket/ Internal Bracket / Bracket

Normal Fascia Board

02

Ueven Fascia Board
Install Adjustable Bracket

Ueven Fascia Board

RAIN GUTTER

The number of **Rain Gutter** needed is determined by measuring the entire length of the roof, then dividing by 5.8 meters (our standard size).

OUTLET

Outlet is required to drain water into the downpipe. One piece of outlet is needed per 5.8 meters of uPVC Rain Gutter.

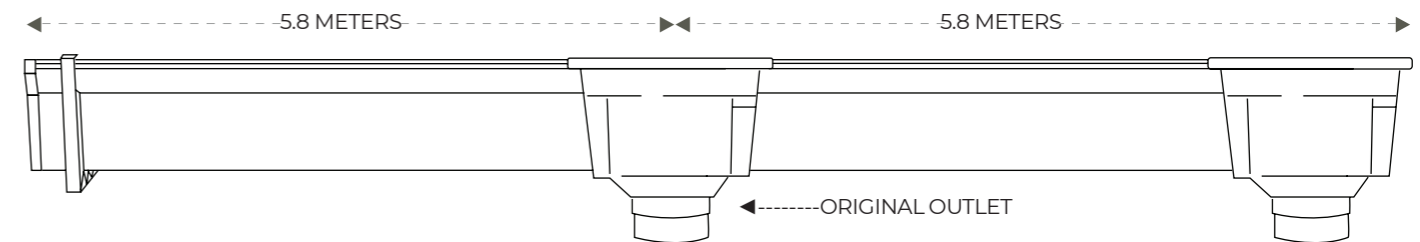

BRACKET & GUTTER STRAP

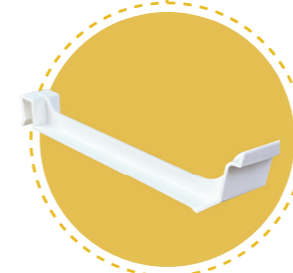
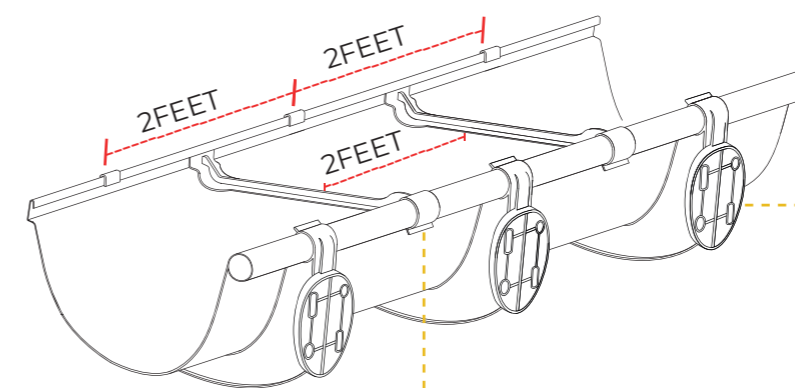

GUTTER STRAP

To maintain the shape and strengthen the uPVC Rain Gutter, Gutter Straps are recommended to install every 0.6 meters (2feet).

BRACKET

Brackets are required to support the Rain Gutters. It is recommended to install at intervals of 0.6 meters (2feet).

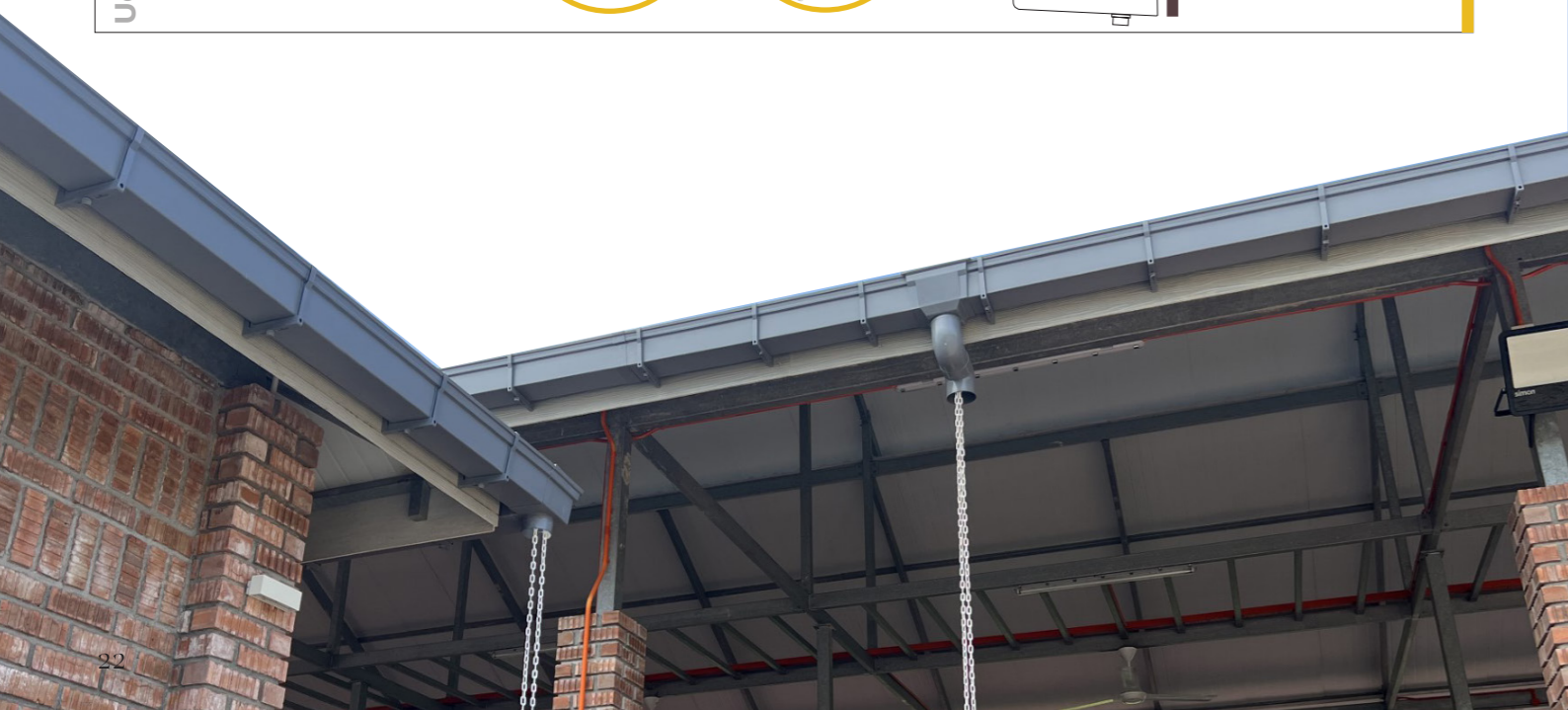



STEP 1

STARTING POINT TO OUTLET

Determine the location of starting point and the outlet point.

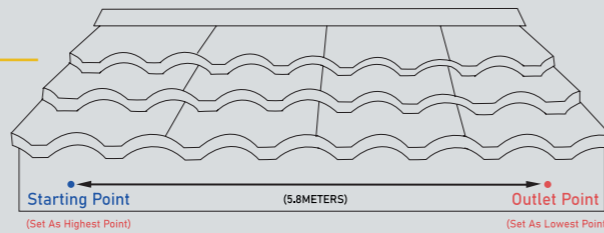

STEP 4

END CAP / CORNER & BRACKET

Install the first bracket near the highest point (starting point), assure the distance between End Cap / Corner and Bracket is $\leq 125\text{mm}$.

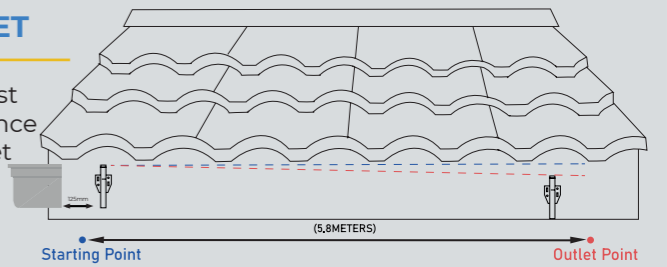

STEP 2

WATER LEVEL ALONG FASCIA BOARD

Use spirit level or level pipe to make sure the water level along fascia board is straight, mark the starting point and outlet point.

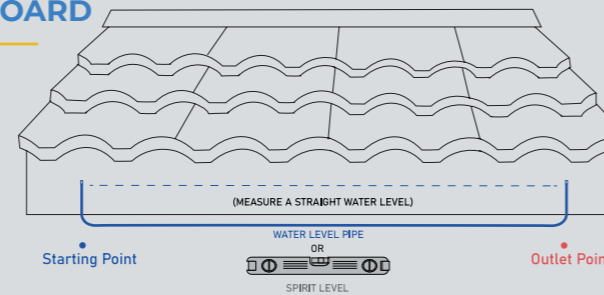

STEP 5

OUTLET & BRACKET

Install the second bracket near the lowest point (outlet point), assure the distance between Outlet and Bracket is $\leq 125\text{mm}$.

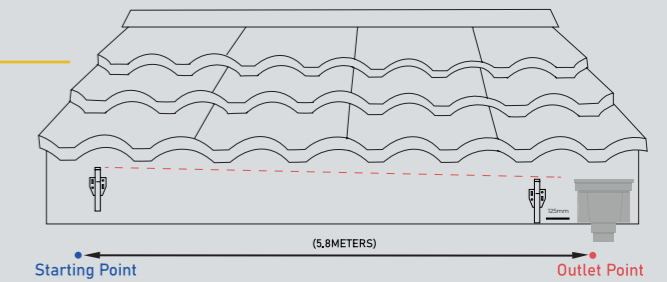

STEP 3

SPEED OF WATERFLOW

To increase the speed of waterflow, mark the lowest point with a 0.64cm (1/4 inch) downward slope from the outlet point, then mark the outlet point as highest point.

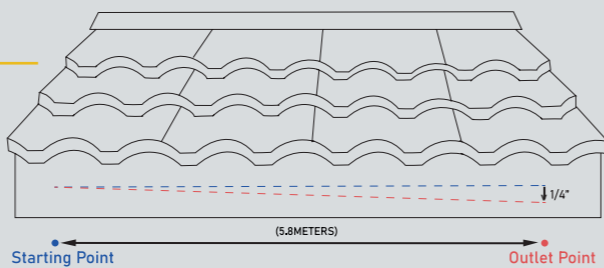

STEP 6

BRACKETS SPACING

Tighten the string line from the first bracket (near starting point) to the second bracket (near outlet point).

Install brackets at 0.6 meters intervals following the string line to ensure a perfect slope.

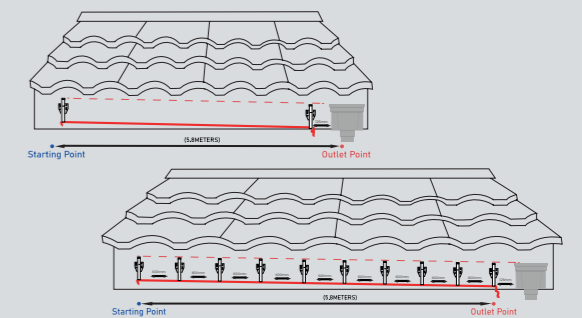

* the distance between Bracket and Outlet / End Cap / Corner / Socket must be $\leq 125\text{mm}$ to give a better support for the uPVC Rain Gutters.

STEP 7

GUTTER INSTALLATION WITH FITTINGS

Measure the length of roof, cut the gutters with a grinder or saw. Removes the burrs and leave a smoother edge, then begin the gutter installation with fittings.

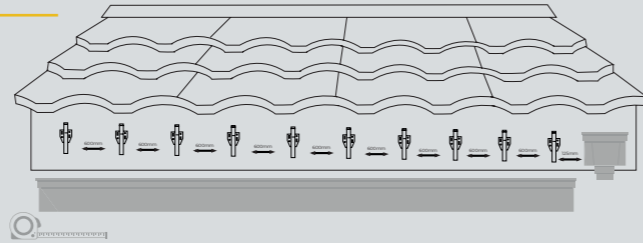

STEP 8

FINAL CHECKING

Make sure there is no gap between each joint. Rubber hammer can be used to make sure that each joint is completely adjoined. Solvent cement and silicon are required for each type of joint : Socket, Outlet Fin, Corner and End Cap

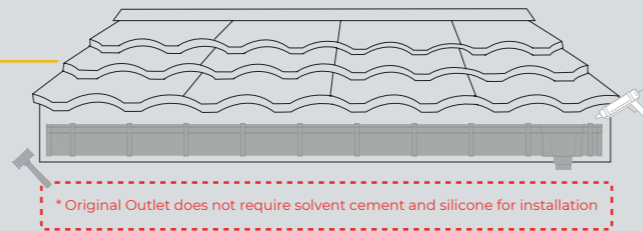

HOW TO *Insert* RAIN GUTTER INTO THE BRACKET

GUTTER G100

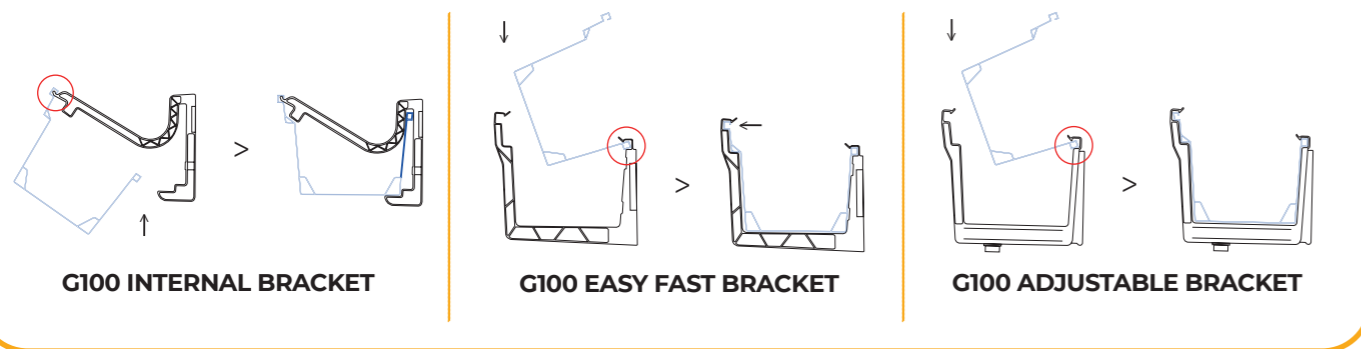

GUTTER G380

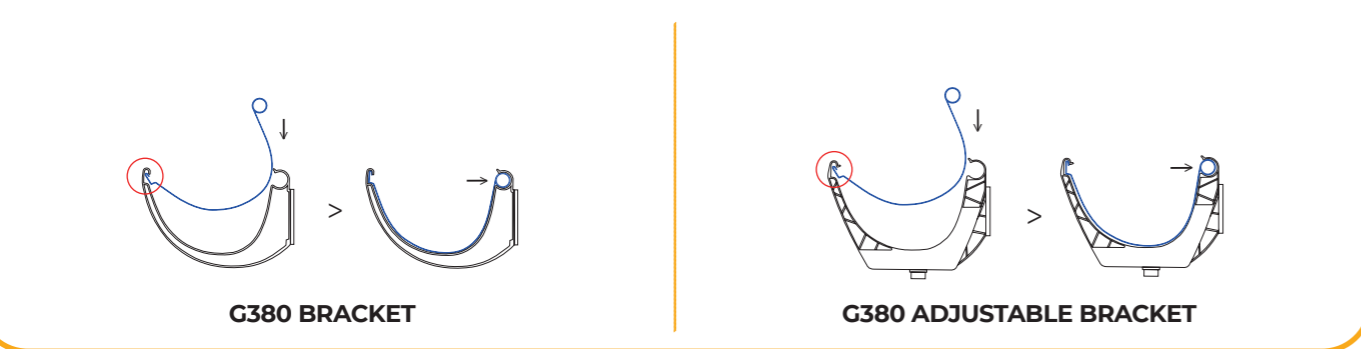

STORAGE INSTRUCTIONS

A proper storage is important to guarantee the quality of the uPVC Rain Gutters, and ensure a seamless service to our customers.

HORIZONTAL PLACEMENT
Load the Rain Gutters horizontally during transportation to distribute the weight evenly and prevent damage.

SHADED STORAGE
To maintain the durability, the uPVC Rain Gutters should be placed on a reasonably flat surface. Store them in a shaded area or cover them with heat-resistant plastic.

AVOID DIRECT HEAT
Avoid storing uPVC Rain Gutters near heat sources or exposing them to direct sunlight as this could damage the uPVC Rain Gutters.

QUALITY ASSURANCE
For best results, please handle the uPVC Rain Gutters according to the instructions in this brochure. Make sure all health and safety procedure guidelines are followed.



uPVC Rain Gutter Systems

Fast • Reliable • Durable

MIDDY

MIDDY INDUSTRIES SDN BHD (549717-T)

35-2 Jalan Pusat BCH 1/1A,
Bandar Country Homes,
48000 Rawang Selangor
www.middy.com.my

