

SLIDING &
SWING
DOOR

300/400/700 series

COMPATIBLE WITH DOOR FRAME



300 SERIES SLIDING DOOR

Ordinary was not on our agenda when we designed our Vitally sliding doors. It will definitely create a spacious home concept by adding an extra dimension with seamless floor look to your living area. Its flexibility of combinations offers unequalled performance and limitless design possibility.



GRAPHIC: M1902283

310A

PCW
colour

NA
colour

PCMB
colour



New Features

Outer Top Bar *4
(Rear View)



GRAPHIC: M1902289

SUSPENDED SLIDING DOOR Without bottom track

DOOR FRAME PROFILE

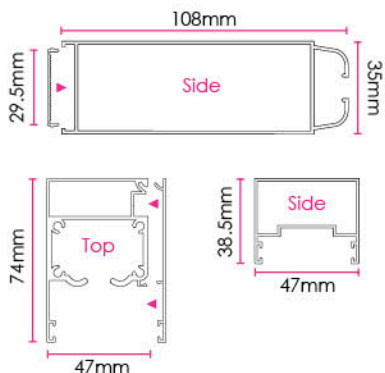
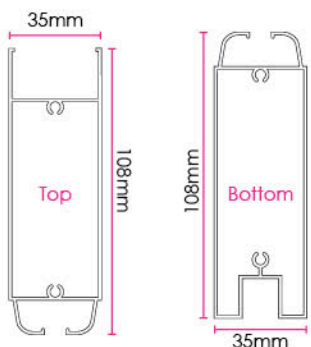

ADD ON ACCESSORIES

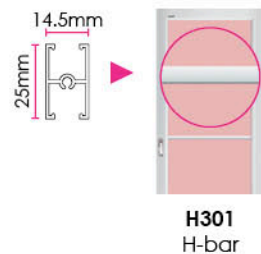

FEATURED ACCESSORIES *4 & *5 please refer to page 14



Enhanced Heavy Duty Roller

- Smooth & silent sliding
- Door withstand up to 48kg
- Roller Height Adjustment



Bottom Guide



F2009
Lock Set



Stopper



ECV-01
Top End Cover *4

310C

PCW
colour



New Features

Outer Top Bar *4
(Rear View)



GRAPHIC: M1902148

SUSPENDED SLIDING DOOR Without bottom track

DOOR FRAME PROFILE

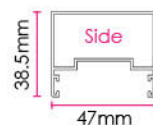
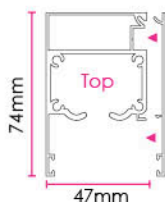
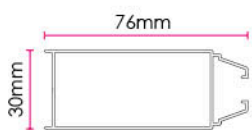

ADD ON ACCESSORIES

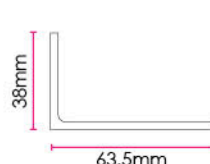

TM 4709
Top Angle Bar *5
(Thickness 3mm)



H301
H-bar

FEATURED ACCESSORIES *3,*4 & *5 please refer to page 14



Enhanced Heavy Duty Roller

- Smooth & silent sliding
- Door withstand up to 48kg
- Roller Height Adjustment



Bottom Guide



A6
Lock Set



PC5-01
Profile Cover *3



Stopper



ECV-01
Top End Cover *4

LOUVER DESIGN

Special Louver designs provide great ventilation allowing air to flow through.



SDV03
Panel: VACP 20D



SDV02
Panel: VACP 18D



SDV01
Panel: VACP 15D



SDV00

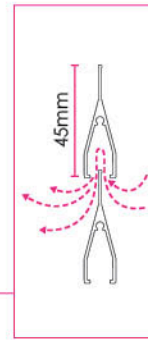

- Good Ventilation
- Practical
- Elegance Look

MULTI-SLIDING DESIGN

Our Multi-slide Door system provides optimal aesthetics and performance.

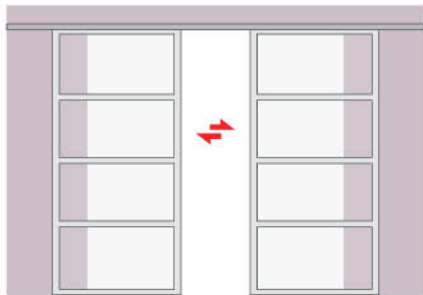

312A
(1 Track 2 Doors)

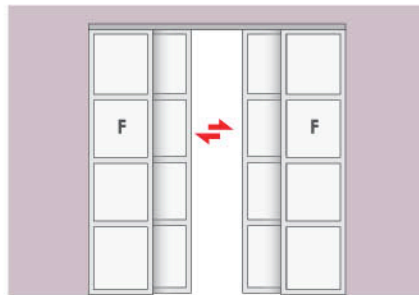

313A
(1 Track 2 Doors + 2 Fixes)

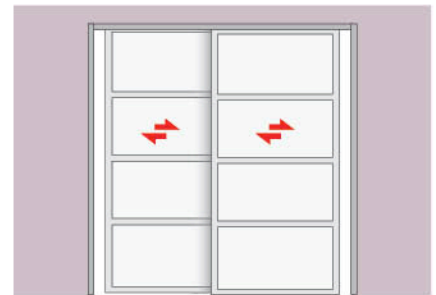

314A
(2 Tracks 2 Doors)

370A

NA
colour



ANTI-JUMP SLIDING DOOR

Smooth • Steady • Quiet

PROFILE DESIGN

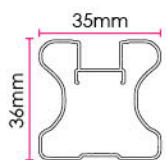

Vertical Frame
(Left & Right)

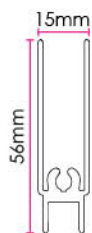

Horizontal Frame
(Top & Bottom)

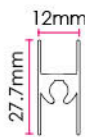

H-Bar

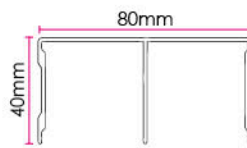

Top Track



Bottom Track

FEATURED ACCESSORIES



Top Roller



Stopper



Bottom Roller

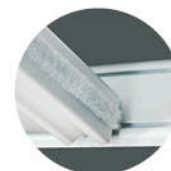

Door Brush

LATTICE DESIGN

Lattice design is an alternative to straddles the line between functional and decorative.

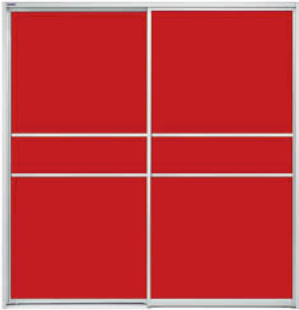

AJC01
Panel: VACP 20D

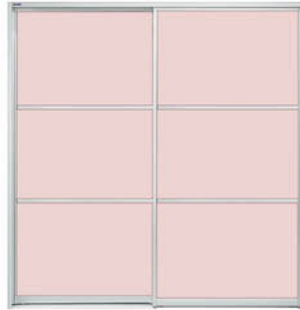

AJC02
Panel: VACP 19D

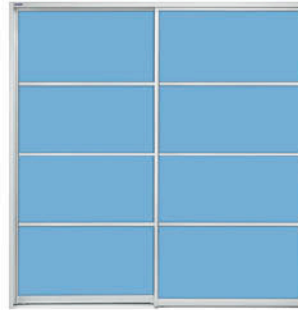

AJC03
Panel: VACP 17D

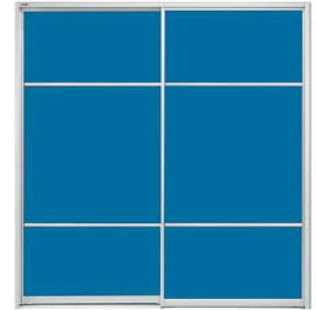

AJC04
Panel: VACP 18D

ANTI-JUMP SLIDING DESIGN

Anti-jump sliding door provides you a hassle free sliding mechanism ensuring perfectly secured panels.

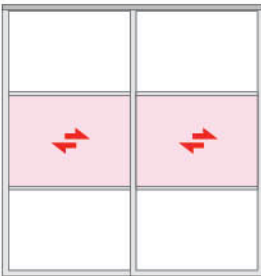

372A
(2 Doors)

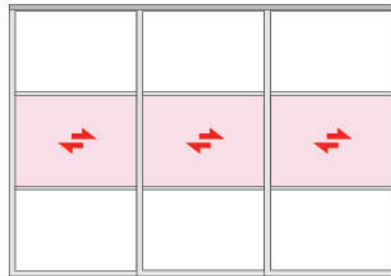

373A
(3 Doors)

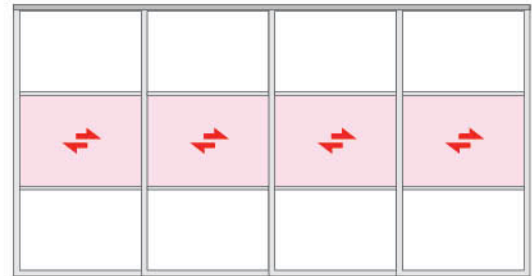

374A
(4 Doors)

400 SERIES SWING DOOR

Why settle with normal? Vitally swing door series is designed to display traditional elegance with unique taste and style in this modern day of living.



420A



GRAPHIC: M1902/14

SWING DOOR Elegant frame design incorporated with arc outline

FRAME PROFILE DESIGN



Single Door

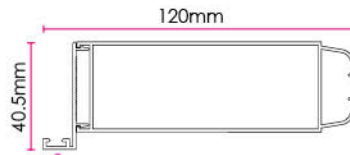

Double Door

FEATURED ACCESSORIES *1,*2 & *3 please refer to page 14



S858
Privacy Handle Lock



DH42-01
Stainless Steel Hinges^{*1}



Metal Rods
& Bolts^{*2}



PCR-02
Profile Cover^{*3}

ADD ON ACCESSORIES



S858KEY
KEY Handle Lock

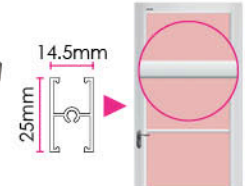

H301
H-bar

430A



GRAPHIC: W1902261

SWING DOOR Clean-cut frame outline

FRAME PROFILE DESIGN



Single Door

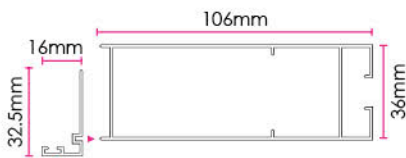

Double Door

FEATURED ACCESSORIES *2 & *3 please refer to page 14



S858
Privacy Handle Lock



DH45-01
Aluminium Hinges



Metal Rods
& Bolts *2



PCR-02
Profile Cover *3

ADD ON ACCESSORIES



S858KEY
KEY Handle Lock

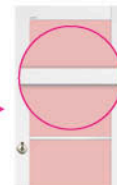
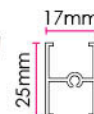

H501
H-bar

440A

PCW
colour



GRAPHIC: VACP 10D

SWING DOOR Clean lined frame design

FRAME PROFILE DESIGN



Single Door

FEATURED ACCESSORIES



B318 Small Latch
(449A only)



B328 Big Latch
(441A only)



DH45-01
Aluminium Hinges

ADD ON ACCESSORIES

Only available on 441A single door product



S418
Cylindrical Lock



S848
Privacy Handle Lock



S848KEY
KEY Handle Lock

450A



GRAPHIC: M1902093

SWING DOOR Contemporary-chic frame design

FRAME PROFILE DESIGN

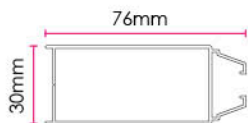

Single Door

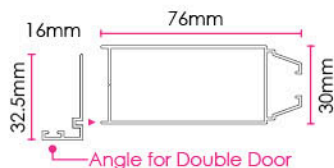

Double Door

FEATURED ACCESSORIES *2 & *3 please refer to page 14



S848
Privacy Handle Lock



DH45-01
Aluminium Hinges



Metal Rods
& Bolts *2



PC5-01
Profile Cover *3

ADD ON ACCESSORIES



S848KEY
KEY Handle Lock

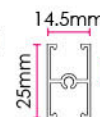

H301
H-bar

LATTICE DESIGN

Lattice design is an alternative to straddles the line between functional and decorative.
(Not applicable for Swing door 440A)

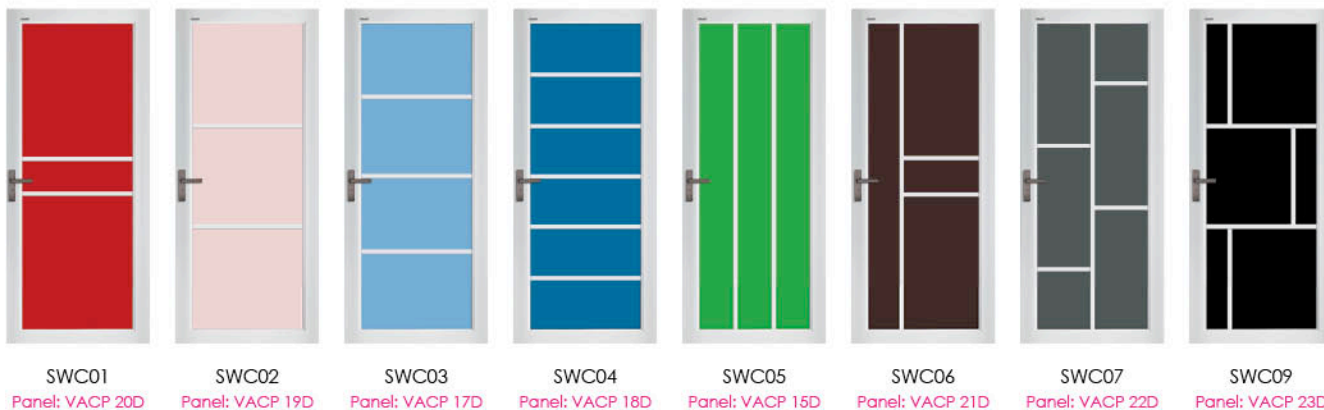

LOUVER DESIGN

Special Louver designs provide great ventilation allowing air to flow through.
(Not applicable for Swing door 440A)





GRAPHIC: W1902064

FIXED DESIGN

Fixed partition system designed for large opening can easily change the perception of physical borders.

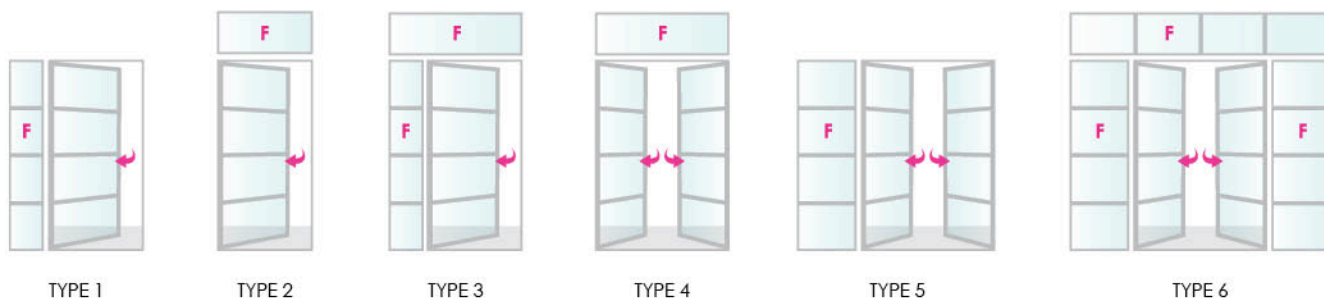

ADD ON ACCESSORIES

Applicable for Double Swing Door (Only available on Fixed Design type 4, 5 & 6)



Flush Bolt

- Used to secure the inactive door leaf. (on pairs of doors)
- Extension rod type.



Dust Proof Socket

- Reduce the risk of obstructions such as small stones or accumulations of dust and debris.

INDEX

Stainless Steel Hinges

- *1 • Hassle-free installation. Do not require to bevel or trim the door frame edges.

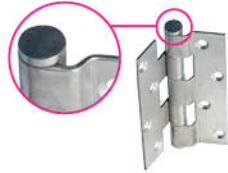

Metal Rods & Bolts

- *2 • Minimise the gaps for a neat and tidy appearance.

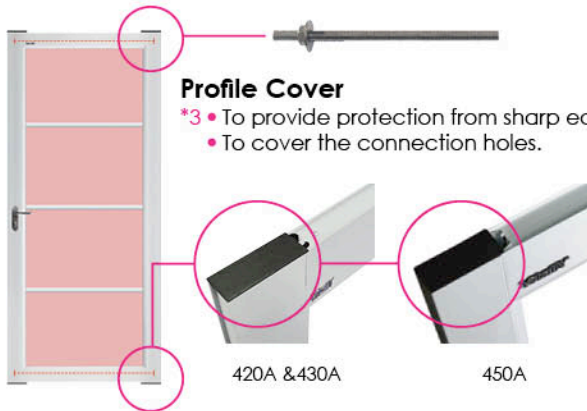

Profile Cover

- *3 • To provide protection from sharp edge.
- To cover the connection holes.

Sliding Door Top Bar

- *4 • New Top Bar Introduction

Step 1

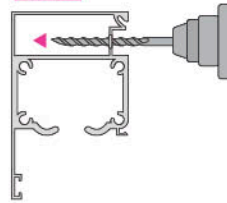

- Drill a hole for installation.

Step 2

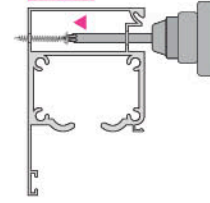

- Install screw in wall.
- New profile design to prevent dust from falling ensure that smooth sliding.

Step 3

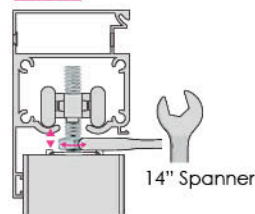

- Using 14" spanner to adjust Upper Roller for levelling purpose.

Step 4

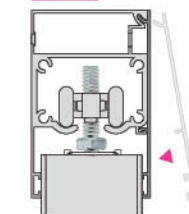

- Place the Outer Top Cover and Top End Cover.

Top Angle Bar

- *5 • To make the installation easier, you can install the Top Angle Bar to avoid the wall skirting.

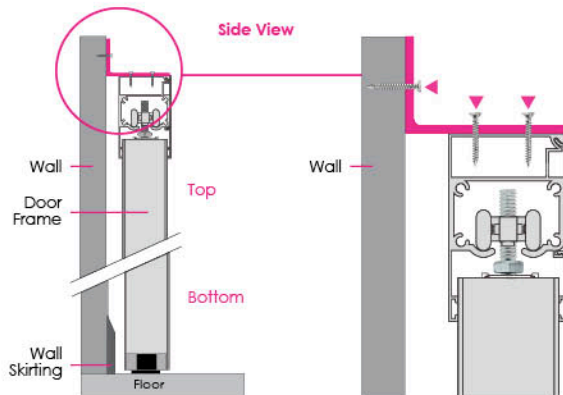

GRAPHIC: M1902169



700 SERIES DOOR FRAME

THE ADVANTAGES OF DOOR FRAMES

- Hassle free installation.
- Extensive product life and easy maintenance.
- Weather resistant – not subject to splitting, warping or shrinking.
- More cost efficient and affordable compared to metal and wooden frames.
- Provides endless design flexibility according to custom specification.
- Contribute an excellent thermal and sound insulation.
- Available in wide range of finishing.
- Does not require repainting as coated with high quality anodising treatment.
- Aesthetically pleasing – clean, smooth and shining surface.

710A

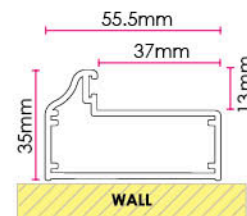

DOOR FRAME

730A

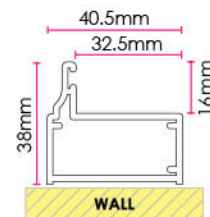

DOOR FRAME

INFILL PANEL

ECO ART PANEL There are thousands of different designs for selection.



SCAN ME
FOR MORE DESIGNS.

Look for more eco art panel design at
www.vitaly.com.my/e-catalog-category/eco-art-panel/

ecopoly®
TRANSPARENT

ecoscreen®
TRANSLUCENT

ecobonz®
OPAQUE

AEROLITE PANEL 20 solid colours and 30 Woodgrain with different visual effect for selection.

SOLID COLOURS



SPRING SPLASH
ASD 103



SALISBURY STONE
ASD 107



VIOLET VERONA
ASD 105



GREY SPLENDOR
ASD 102



GOLDEN BARK
ASD 109



TOMATO RED
ASD 120



DARK COFFEE
ASD 121

WOODGRAIN



FINELINE
AWG 201



WATERFALL LINE
AWG 203



WHEAT STRAND
AWG 206



BURMESE TEAK
AWG 212



HAZELNUT CHERRY
AWG 216



MYRIAD
RIBBONWOOD
AWG 226



EBONY
RIBBONWOOD
AWG 227





ALUMINIUM COMPOSITE PANEL 24 colours with different visual effect for selection.



LAMINA GLASS 77 colours with different visual effect for selection.



SPECIFICATIONS







	300 SERIES SLIDING DOOR		
Model	310A	310C	370A
Sub Model	<ul style="list-style-type: none"> •311A •312A <ul style="list-style-type: none"> •313A •314A 	<ul style="list-style-type: none"> •311C •312C <ul style="list-style-type: none"> •313C •314C 	<ul style="list-style-type: none"> •371A •372A •373A <ul style="list-style-type: none"> •374A •375A •376A
Maximum Size	48"(W) x 96"(H)		-
Fixed Size	-	-	-
Infill Panel	<ul style="list-style-type: none"> • Eco Art Panel • Aluminium Composite Panel • Aerolite Panel • Lamina Glass 		
Featured Accessories	<ul style="list-style-type: none"> • F2009 Lock Set • F2011 Upper Roller Set • ECV-01 Top End Cover • 108 L Bracket 	<ul style="list-style-type: none"> • A6 Lock Set • F2011 Upper Roller Set • PC5-01 Profile Cover • ECV-01 Top End Cover 	<ul style="list-style-type: none"> • Top Rollers • Stoppers • Bottom Rollers • Door Brushes
Add on Accessories	<ul style="list-style-type: none"> • H301 H-bar • Top Angle Bar 		-
Frame Colour	<ul style="list-style-type: none">  Powder Coating White  Natural Anodised  Powder Coating Matt Black 	<ul style="list-style-type: none">  Powder Coating White 	<ul style="list-style-type: none">  Natural Anodised

Specifications are subject to change without prior notice.

400 SERIES SWING DOOR

420A	430A	440A		450A
<ul style="list-style-type: none"> • 421A (Single) • 422A (Double) 	<ul style="list-style-type: none"> • 431A (Single) • 432A (Double) 	<ul style="list-style-type: none"> • 441A (Single) 	<ul style="list-style-type: none"> • 449A (Standard size) 	<ul style="list-style-type: none"> • 451A (Single) • 452A (Double)
36" (W) x 96" (H)		36" (W) x 84" (H)	-	36" (W) x 96" (H)
-	-	-	30" (W) x 72" (H)	-
<ul style="list-style-type: none"> • Eco Art Panel • Aluminium Composite Panel • Aerolite Panel • Lamina Glass 		<ul style="list-style-type: none"> • Aluminium Composite Panel <small>(Not applicable for VACP 811S/812S/813D/814D/815D/816D)</small> 	<ul style="list-style-type: none"> • Aluminium Composite Panel <small>(Flash Silver double only)</small> 	<ul style="list-style-type: none"> • Eco Art Panel • Aluminium Composite Panel • Aerolite Panel • Lamina Glass
<ul style="list-style-type: none"> • S858 Privacy Handle Lock • DH42-01 Stainless Steel Hinges • Metal Rods & Bolts • PCR-02 Profile Cover 	<ul style="list-style-type: none"> • S858 Privacy Handle Lock • DH45-01 Aluminium Hinges • Metal Rods & Bolts • PCR-02 Profile Cover 	<ul style="list-style-type: none"> • B328 Big Latch • DH45-01 Aluminium Hinges • MWB-01 Multi Way Bracket 	<ul style="list-style-type: none"> • B318 Small Latch • DH45-01 Aluminium Hinges • HK-01 Ring Hook • MWB-01 Multi Way Bracket 	<ul style="list-style-type: none"> • S848 Privacy Handle Lock • DH45-01 Aluminium Hinges • Metal Rods & Bolts • PC5-01 Profile Cover
<ul style="list-style-type: none"> • S858KEY Key Handle Lock • Flush Bolt • Dust Proof Socket • H301 H-bar 	<ul style="list-style-type: none"> • S858KEY Key Handle Lock • Flush Bolt • Dust Proof Socket • H501 H-bar 	<ul style="list-style-type: none"> • S848 Privacy Handle Lock • S848KEY Key Handle Lock • S418 Cylindrical Lock <small>(Include CLB-01 Lock Bracket)</small> 	-	<ul style="list-style-type: none"> • S848KEY Key Handle Lock • Flush Bolt • Dust Proof Socket • H301 H-bar
<ul style="list-style-type: none"> PCW Powder Coating White NA Natural Anodised SBG Powder Coating Sandblast Grey PCMB Powder Coating Matt Black 	<ul style="list-style-type: none"> PCW Powder Coating White NA Natural Anodised SBG Powder Coating Sandblast Grey PCMB Powder Coating Matt Black 	<ul style="list-style-type: none"> PCW Powder Coating White 		<ul style="list-style-type: none"> PCW Powder Coating White SBG Powder Coating Sandblast Grey PCMB Powder Coating Matt Black

700 SERIES DOOR FRAME

	700 SERIES DOOR FRAME	
Model	710A	730A
Maximum Size	72"(W) x 96"(H)	
Applicable for	<ul style="list-style-type: none"> • Swing Door 420A • Swing Door 430A 	<ul style="list-style-type: none"> • Swing Door 440A • Swing Door 450A
Frame Colour	<ul style="list-style-type: none">  Powder Coating White  Natural Anodised  Powder Coating Sandblast Grey  Powder Coating Matt Black 	<ul style="list-style-type: none">  Powder Coating White  Powder Coating Sandblast Grey  Powder Coating Matt Black

INTELLECTUAL PROPERTY NOTICE

All trade marks in this catalogue, unless otherwise indicated, are subject to the trade mark rights of Vitally Sdn. Bhd. or its related parties and are registered trade marks in Malaysia and other countries. Vitally Sdn. Bhd. or its related parties protect their marks, brands, model names and logos in all countries in which it uses them.

Certain features and/or functionality of the products and/or systems of Vitally Sdn. Bhd. or its related parties as described in this catalogue are the subject matter of patent applications pending before the Intellectual Property Corporation of Malaysia.

The shape, configuration, pattern and/or ornament of the designs applied onto the products found in this catalogue have, where permissible, been protected by way of registered industrial designs in Malaysia by Vitally Sdn. Bhd. or its related parties.

All materials, including texts, images, logos, designs, graphics, photographs, and other materials that appear as part of this catalogue are properties owned or licensed by Vitally Sdn. Bhd. or its related parties, and are protected by copyright or other intellectual property laws all around the world, and all such rights are reserved. The contents of this catalogue, and the catalogue as a whole, may not be scanned, reproduced, adapted, modified, published, or distributed, in whole or in part, without the prior written consent of Vitally Sdn. Bhd. or its related parties.

Vitally Sdn. Bhd. or its related parties views matters relating to its intellectual property rights and interests seriously and will take the necessary actions to protect and enforce its rights against third parties found to be infringing its rights.

知识产权通告

本产品目录册中的所有商标,皆受制于Vitally Sdn. Bhd.或其相关方的商标权,并于马来西亚与其他国家受承认为注册商标,除非另有说明。所有Vitally Sdn. Bhd.或其相关方正在使用的商标,品牌,型号名称与标志,皆已于相关国家受保护。

本产品目录册中所描述并属于Vitally Sdn. Bhd.或其相关方的产品和/或系统的特定特征和/或特定功能,乃Vitally Sdn. Bhd.或其相关方已呈交于马来西亚知识产权局专利申请中的发明元素。

所有应用于本产品目录册中所描述的产品之形状、配置、图案和/或设计,在被允许的情况下,已在马来西亚获得Vitally Sdn. Bhd.或其相关方名下的工业设计注册之保护。

所有素材,包括文字、图像、标志、设计、图形设计、照片,以及其它在本产品目录册中所使用的素材皆由Vitally Sdn. Bhd.或其相关方所拥有或授权,并在世界各地受到版权或其它知识产权法律的保护。我们一律保留所有相关权益。本产品目录册的内容以及整体目录册,无论是整体或部分,在未获得Vitally Sdn. Bhd.或其相关方的预先书面同意下,一律不得被扫描、复制、改编、修改、发布或分发。

Vitally Sdn. Bhd.或其相关方严谨看待其知识产权与权益。为了保护并执行有关产权与权益,我们将采取必要的行动以杜绝第三方的任何侵权行为。

NOTIS HARTA INTELEK

Kesemua cap dagangan yang terkandung dalam katalog ini, melainkan yang dinyatakan sebaliknya, adalah tertakluk kepada hak cap dagangan Vitally Sdn. Bhd. atau pihak-pihak yang berkaitan dengannya dan merupakan cap-cap dagangan berdaftar di Malaysia dan negara-negara lain. Vitally Sdn. Bhd. atau pihak-pihak yang berkaitan dengannya telah melindungi cap, jenama, nama model dan logo kepunyaan mereka di negara-negara di mana mereka menggunakan cap, jenama, nama model dan logo tersebut.

Ciri-ciri dan/atau fungsi tertentu produk dan/atau sistem Vitally Sdn. Bhd. atau pihak-pihak yang berkaitan dengannya sepertimana yang diuraikan dalam katalog ini merupakan hal perkara dalam permohonan-permohonan paten yang telah difailkan dengan Perbadanan Harta Intelek Malaysia.

Ciri bentuk, tatarajah, corak dan/atau hiasan yang digunakan pada produk-produk yang dinyatakan dalam katalog ini telah, di mana ia dibenarkan, dilindungi oleh reka bentuk perindustrian berdaftar di Malaysia oleh Vitally Sdn. Bhd. atau pihak-pihak yang berkaitan dengannya.

Kesemua bahan, termasuk teks, imej, logo, reka bentuk, grafik, gambar dan bahan-bahan lain yang terkandung di mana-mana bahagian katalog ini merupakan harta yang dimiliki oleh atau dilisenkan oleh Vitally Sdn. Bhd. atau pihak-pihak yang berkaitan dengannya dan telah dilindungi oleh hakcipta atau undang-undang harta intelek yang lain di seluruh dunia dan kesemua hak tersebut adalah terpelihara. Kandungan katalog ini, dan katalog ini secara keseluruhannya, tidak boleh diimbas, dikeluarkan semula, diubahsuai, disadur, disesuaikan, diterbitkan, atau diedarkan, sama ada secara keseluruhannya atau sebahagiannya, tanpa keizinan terdahulu secara bertulis dari Vitally Sdn. Bhd. atau pihak-pihak yang berkaitan dengannya.

Vitally Sdn. Bhd. atau pihak-pihak yang berkaitan dengannya memandang serius terhadap perkara-perkara berhubung dengan hak-hak harta intelektualnya dan akan mengambil tindakan yang bersesuaian bagi melindungi dan menguatkuasa hak-hak tersebut ke atas pihak ketiga yang didapati melanggar hak-hak tersebut.



Our Quality Assurance:



Our Awards & Achievements:



www.vitality.com.my



© 2020 Vitality Sdn. Bhd. ("Vitality"). All Rights Reserved.

No part of this publication may be reproduced in any form, stored in a retrieval system or transmitted in any form by any means without the prior written permission of Vitality Sdn. Bhd. except as permitted by copyright law.

All product images shown are for illustration purposes. Actual product may vary due to product enhancement. We reserve the right, at any time in our sole discretion, to alter or discontinue any product without prior notice. Terms and conditions apply.

Proudly designed and published by Vitality Sdn. Bhd. (840870-K)

Authorised Dealer:

SSD-BRO03-2005