

# Bronze & Brass Valves

JIS 5K/10K, ASME Class 125/150/300, KITZ Type 100/125/150/300/400/600







As a world leader in the manufacture of general service valves, KITZ Corporation is glad to offer a broad range of KITZ bronze/brass valves for commercial and industrial applications.

KITZ bronze/brass valves are exclusively produced in modern factories used for valve manufacturing. Each phase of the manufacturing process, from the selection of raw materials to casting, forging, machining, assembly and testing, has been improved with automated production facilities and unparalleled production technology. Standardization and automation yield KITZ bronze/brass valves of superior quality and higher uniformity at competitive prices supported by incomparably prompt delivery.

KITZ bronze/brass valves are designed by state-of-the-art computers, built by automation, and inspected by people who care about quality.

## Design Features of KITZ Bronze/Brass Valves

### Human Engineering in Hand wheel Design

The computer designed hand wheels of all KITZ bronze/brass valves, the product of KITZ human engineering, feature the ideal combination of operational efficiency and high mechanical strength for reliability.

### Asbestos-free Gland Packing

All KITZ bronze/brass gate and globe valves employ Aramid Fiber PTFE as the material in the asbestos-free gland packing, which meets the latest industrial requirement to minimize concerns about pollution. With the leak-free sealing performance and reduced valve operating torque, Aramid Fiber PTFE is considered a reliable substitute for conventional asbestos sheets for the service of water, oil, gas, and saturated steam pressure at a maximum 300psi at temperatures up to 300°C.

### Pressure Rating

The pressure rating designation of KITZ valves follows the accepted practice of today's valve and pipe fitting industry. Each product is rated for W.O.G. (Non-shock cold water, oil, and gas\*) and Saturated steam pressure service.

### Inspection and Testing

KITZ valves are manufactured under strict quality control requirements throughout all stages of production, beginning with the inspection of the chemical composition and the mechanical properties of the materials. Extra care is given to inspection and testing at all machine shops and assembly plants by using up-to-date precision equipment. All KITZ valves meet strict pressure testing specifications for the body and seat seals to assure a long service life and quality performance.

\*The valves presented in this catalog are not designed to handle toxic gases. Use specially designed or certified valves for flammable gas service.

KITZ Corporation, Chino Plant, Japan (ISO 9001)



KITZ (Thailand) Ltd, Bangplee Plant, Thailand (ISO 9001)



This catalog uses MPa, an SI unit, to indicate pressure. For reader convenience, however, psi is also used for ASME and JIS related products, respectively. The products in this catalog are all covered by ISO 9001 certification.

## CONTENTS

Title	Fig	Class	Type	Body Material	End Connection	Page		
KITZ Standard Gate, Globe, Check, Angle, & Butterfly valves, Y-pattern strainers	A	AKA	100	Globe	Bronze	Threaded	6	
	Q	QA	100	Globe	Bronze	Threaded	6	
	C	AKC	150	Globe	Bronze	Threaded	6	
	CA	AKCA	150	Angle	Bronze	Threaded	7	
	B	BH	150	Globe	Bronze	Flanged	7	
	G	AKG	125	Globe	Bronze	Threaded	7	
	D		150	Globe	Bronze	Threaded	8	
	DB	DBH	150	Globe	Bronze	Flanged	8	
	FR	AKFS	CFS	125	Gate	Brass	Threaded/Soldered	8
	FH	AKFH	CFH	125	Gate	Brass	Threaded/Soldered	9
	H	AKH	CH	125	Gate	Bronze	Threaded/Soldered	9
	S		125	Gate	Bronze	Threaded	9	
	E	AKE	150	Gate	Bronze	Threaded	10	
	EB	EBH	150	Gate	Bronze	Flanged	10	
	F	AKF	150	Lift Check	Bronze	Threaded	10	
	R	AKR	125	Swing Check	Bronze	Threaded	11	
	YR		125	Swing Check	Bronze	Threaded	11	
	RF	AKAF	150	Lift Check	Bronze	Threaded	11	
	VF		(5K)	Lift Check	Bronze	Threaded	12	
	FT&FTS		(5K)	Foot	Bronze	Threaded	12	
Y	AKY	CY	150	Strainer	Bronze	Threaded/Soldered	12	
FV		175	Butterfly	Brass	Threaded	13		
JIS Standard Gate, Globe, & Check valves	J		10K	Globe	Bronze	Threaded	14	
	JB		10K	Globe	Bronze	Flanged	14	
	M		5K	Gate	Bronze	Threaded	14	
	L		10K	Gate	Bronze	Threaded	15	
	LB		10K	Gate	Bronze	Flanged	15	
	O		10K	Swing Check	Bronze	Threaded	15	
	OB		10K	Swing Check	Bronze	Flanged	16	
	10BWZ		10K	Wafer Check	Bronze	Wafer	16	
Industrial Gate, Globe, & Check valves	AK125M		125	Gate	Bronze	Threaded	18	
	AK125E		125	Gate	Bronze	Threaded	18	
	AK150E		150	Gate	Bronze	Threaded	18	
	AK150L	C150L	150	Gate	Bronze	Threaded/Soldered	19	
	AK150LU		150	Gate	Bronze	Threaded	19	
	AK300LU		300	Gate	Bronze	Threaded	19	
	AK125C		125	Globe	Bronze	Threaded	20	
	AK150D	C150D	150	Globe	Bronze	Threaded/Soldered	20	
	AK300J		300	Globe	Bronze	Threaded	20	
	AK300D		300	Globe	Bronze	Threaded	21	
	AKYR	CYR	125	Swing Check	Bronze	Threaded/Soldered	21	
	AK150YR		150	Swing Check	Bronze	Threaded	21	
	AK300YR		300	Swing Check	Bronze	Threaded	22	
	AS-FH		PN16	Gate	Brass	Threaded	22	
Ball valves	AKTAF		600	Full bore Ball	Brass	Threaded	23	
	CTAF		600	Full bore Ball	Brass	Soldered	23	
	AKTFL	CTFL	600	Full bore Ball	Brass	Threaded/Soldered	23	
	AKTAFM	CTAFM	600	Full bore Ball	Brass	Threaded/Soldered	24	
	AKTAFP		600	Full bore Ball	Brass	Threaded	24	
	AKTAFPM		600	Full bore Ball	Brass	Threaded	24	
	AKT AFC	CT AFC	600	Full bore Ball	Brass	Threaded/Soldered	25	
	AKT AFO		600	Full bore Ball	Brass	Threaded(F&M)	25	
	AKT AFU		600	Full bore Ball	Brass	Threaded/Union	25	
	AKT AFS		200	Full bore Ball	Brass	Threaded	26	
	T	AKT	TT	400	Ball	Brass	Threaded	27
	TO		400	Ball	Brass	Threaded(F&M)	27	

Title	Fig	Class	Type	Body Material	End Connection	Page		
Ball valves	TM	400	Ball	Brass	Threaded	27		
	TK	AKTK	TKT	600	Ball	Brass	Threaded	28
	TKW			600	Ball	Brass	Threaded	28
	TFJ			150	Full bore Ball	Brass	Threaded	28
	TL	TLT		400	Ball	Bronze	Threaded	29
	TB			10K	Full bore Ball	Bronze	Flanged	29
	AK3TM			600	Full bore Ball	Brass	Threaded	29
	ZO			600	Full bore Ball	Brass	Threaded(F&M)	30
	ZS			400	Ball	Brass	Threaded	30
	ZET			600	Full bore Ball	Brass	Threaded	30
	AKSZA	CSZA		600	Full bore Ball	Brass	Threaded/Soldered	31
	SZA			600	Full bore Ball	Brass	Threaded	31
	AKSZAW	CSZAW		600	Full bore Ball	Brass	Threaded/Soldered	31
	TN	AKTN		400	3-Way Ball	Brass	Threaded	32
	T4T	T4L		400	3-Way Ball	Bronze	Threaded	32
AKTNP			400	3-Way Ball	Brass	Threaded	32	
Gas service valves	TG		Ball	Brass	Threaded	34		
Fancoil valves	NSH			200	Globe	Bronze	Threaded(F&M)	35
	INAH			200	Angle	Bronze	Threaded(F&M)	35
	INSH			200	Globe	Bronze	Threaded(F&M)	35
	RTRM			10K	Ball	Bronze	Threaded	37
	RTRO			10K	Ball	Bronze	Threaded(F&M)	37
	RTRR			10K	Ball	Bronze	Threaded(F&M)	37
	RTRU			10K	Ball	Bronze	Threaded/Union	38
Balancing valves	BS			10K	Balancer	Bronze	Threaded/Union	38
	BSS			10K	Balancer	Bronze	Threaded/Union	38
	RTUC			10K	Constant flow Valve	Bronze	Threaded/Union	39
Utility Ball valves	S1 -			10K	Straight	Brass	Threaded	40
	S2 -			10K	Straight	Brass	Threaded	40
	S5 -			10K	Angle	Brass	Threaded	40
	S6 -			10K	Straight	Brass	Threaded(F&M)	41
	S23N -			10K	Ball (Built in Check)	Brass	Threaded	42
	S24N			10K	Ball (Built in Check)	Brass	Threaded	43
	S25N			10K	Ball (Built in Check)	Brass	Threaded	43
	S28N			10K	Ball (Built in Check)	Brass	Threaded(F&M)	43
	S24N - 3/4 x			10K	Ball (Built in Check)	Brass	Threaded	44
	S28N - 3/4 x			10K	Ball (Built in Check)	Brass	Threaded(F&M)	44

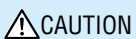

The valves introduced in this catalog are not designed to handle toxic gases. Use specially designed or certified valves for flammable gas service.

## KITZ "K-Metal": Unique Dezincification-Resistant Brass (UNS No. C35350)

Water pollution and employment of new piping material have amplified valve dezincification problems.

### What is dezincification?

The copper alloy used in bronze valves contains zinc, tin, and lead, with copper as the base. When bronze valves are subjected to unfavorable service conditions, the zinc component of the copper alloy separates from the copper base, and the metal corrodes. This is called dezincification.

In the case of a bronze valve, the body, bonnet, and other cast bronze parts rarely corrode, because of the small percentage of zinc contained in the alloy. However, brass valve parts such as stems, which contain 40% zinc, often corrode because of extreme dezincification.

### What causes dezincification?

The following factors cause dezincification. These factors are generally believed to occur together, rather than independently.

- ➊ Excessive acidity in aqueous solution.
- ➋ Warm water containing excessive free carbonic acid with high electric conductivity.
- ➌ High electric conductivity with presence of excessive chlorides and sulfides.
- ➍ Copper or vinyl chloride pipes.
- ➎ Excessive dissolved oxygen.

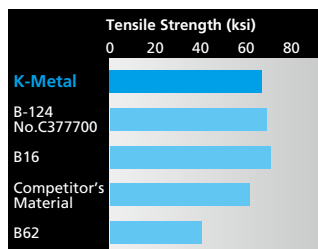

Fig. 1 Comparison of tensile strength

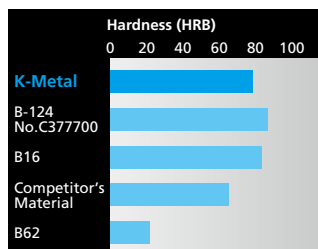

Fig. 2 Comparison of hardness

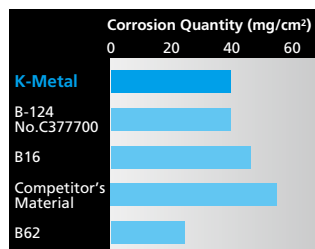

Fig. 3 Comparison of corrosion (1 mg/cm²=0.014 mlb/in²)

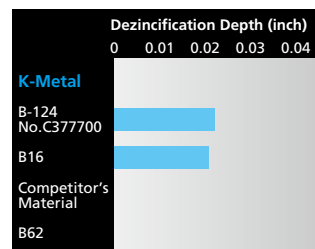



Fig. 4 Comparison of dezincification (to AS C316)

### Bronze/Brass Valve Solder Joints

Copper tubing is widely used with bronze/brass valves in steam and water-line applications in schools, hospitals, hotels, and private houses because of its excellent physical characteristics. It resists corrosion, meets sanitation requirements, and is easy to install.

**Copper Tubes:** Three types of copper tubing have been developed for complying with ASTM B88, as listed below. Each type is provided with a different wall thickness to meet application requirements.

<b>Type K</b>	For use in steam, oil, and gas lines for underground installation and/or severe conditions.
<b>Type L</b>	For general cooling and heating systems and related water piping and ventilation systems.
<b>Type M</b>	For home air-conditioning and heating applications.

 <b>CAUTION</b>	Solder-jointed end valves should not be used in service where the temperature of the line fluid is higher than the softening point of the solder.
----------------------------------------------------------------------------------------------------	---------------------------------------------------------------------------------------------------------------------------------------------------

### Soldering of Leak Free Joints

Use solder of 95-5 tin-antimony or 96-4 tin-silver, and an open-flame torch. Keep the torch temperature relatively low to ensure a firmly soldered joint. Because the melting point of the solder is at around 500°F (260°C), solder-jointed valves cannot be used for high-temperature service.

### Solder P-T Rating

Solder	Max. temp. (°C)	Max. working pressure					
		size 1/4 <sup>B</sup> -1 <sup>B</sup>		size 1 1/4 <sup>B</sup> -2 <sup>B</sup>		size 2 1/4 <sup>B</sup> -4 <sup>B</sup>	
		MPa	psi	MPa	psi	MPa	psi
95-5 tin-antimony [H95 Sb-5A]	38	3.45	500	2.76	400	2.07	300
	66	2.76	400	2.41	350	1.90	275
96-4 tin-silver [H96 Ag-3.5A]	93	2.07	300	1.72	250	1.38	200
	121	1.38	200	1.21	175	1.03	150

## KITZ Bronze and Brass Materials to JIS Standards

### JIS H5120 (Copper & Copper Alloy Castings)

Cast Bronze Class 6	Designation	Chemical composition (%)										Mechanical properties	
		Cu	Sn	Zn	Pb	Ni	Fe	P	Sb	Al	Si	Tensile strength 195 Min. (N/mm <sup>2</sup> )	Elongation (%) 15 Min.
	CAC406 (BC6)	83.0-87.0	4.0-6.0	4.0-6.0	4.0-6.0	1.0 Max.	0.3 Max.	0.05 Max.	0.2 Max.	0.01 Max.	0.01 Max.		

### JIS H3250 (Copper & Copper Alloy Rods and Bars)

Forged Brass Alloy No. 3771	Designation		Chemical composition (%)				Mechanical properties	
	Extruded	Drawn	Cu	Pb	Fe + Sn	Zn	Tensile strength 315 Min. (N/mm <sup>2</sup> )	Elongation (%) 15 Min.
	C3771BE	C3771BD	57.0-61.0	1.0-2.5	1.0 Max.	Remainder		

### JIS H3250 (Copper & Copper Alloy Rods and Bars)

Free-cutting Brass Alloy No. 3604	Designation		Chemical composition (%)					Mechanical properties	
	Extruded	Drawn	Cu	Pb	Fe	Fe + Sn	Zn	Tensile strength 335 Min. (N/mm <sup>2</sup> )	Elongation (%) —
	C3604BE	C3604BD	57.0-61.0	1.8-3.7	0.5 Max.	1.0 Max.	Remainder		

## KITZ Bronze and Brass Materials to ASTM Standards

### ASTM B62

Chemical composition (%)											Mechanical properties		
Copper	Tin	Lead	Zinc	Nickel & cobalt	Iron	Sulfur	Phosphorus	Antimony	Aluminum	Silicon	Minimum		
84.0-86.0	4.0-6.0	4.0-6.0	4.0-6.0	1.0 Max.	0.30 Max.	0.08 Max.	0.05 Max.	0.25 Max.	0.005 Max.	0.005 Max.	Tensile strength 30 ksi	Yield strength 14 ksi	Elongation in 2 in. 20%

### ASTM B283 C37700

Chemical composition (%)				Mechanical properties		
Copper	Lead	Iron	Zinc	Minimum		
58.0-61.0	1.5-2.5	0.30 Max.	Remainder	Tensile strength 50 ksi	Yield strength 18 ksi	Elongation in 4x thickness 25%

## Compliance with RoHS Restricted Hazardous Substances

With the aim of reducing any adverse impact on environmental health, KITZ CORPORATION can offer products that satisfy the restriction of using six hazardous substances—mercury, lead, cadmium, hexavalent chromium, PBB, and PBDE—imposed by the RoHS\* directive of EU, to the market. The products satisfying this requirement bear the symbol shown below. Please consult KITZ for more details on these products.



\*The Restriction of the use of certain Hazardous Substances in electrical and electronic equipment

# CLASS 100 BRONZE GLOBE VALVE

Screwed bonnet, Rising stem,  
Threaded ends to BS21 (JIS B0203) or NPT

W.O.G. non-shock 1.03 MPa (150 psi), Saturated steam pressure 0.7 MPa (100 psi)



Fig. A\*

- Threaded end to BS21 (JIS B0203)
- Threaded end to ASME B1.20.1

\*Taper pipe threads for connection shall refer to JIS B0203 standards, while the length of useful threads and the positions of gauge planes are built on KITZ standard.

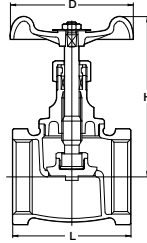

Dimensions

Nominal Size	inch		mm										
	1/4	3/8	8	10	15	20	25	32	40	50	65	80	100
L			40	42	48	53	63	73	81	94	115	131	171
H valve open			66	67	69	80	94	104	127	147	179	200	250
D			50	50	55	60	70	80	90	100	115	135	180

Materials

Parts	Material
Body	Cast Bronze
Bonnet	Forged Brass / Cast Bronze*
Stem	Dezincification Resistant Brass
Disc	Cast Bronze
Gland packing	Non-Asbestos Packing

\*Size 4 only

⚠ Do not use for flammable gas or toxic gas.

# CLASS 100 BRONZE GLOBE VALVE

Screwed bonnet, Rising stem, Soft seated disc,  
Threaded ends to BS21 (JIS B0203)

W.O.G. non-shock 0.78 MPa (125 psi)

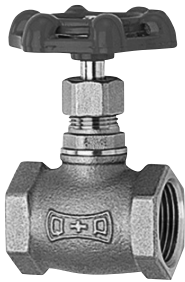

Fig. Q\*

- Rubber disc



Fig. QA\*

- PTFE disc (for oil service)

\*Taper pipe threads for connection shall refer to JIS B0203 standards, while the length of useful threads and the positions of gauge planes are built on KITZ standard.

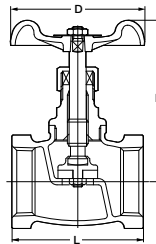

Dimensions

Nominal Size	inch		mm					
	1/2	3/4	15	20	25	32	40	50
L			44	50	63	73	81	94
H valve open			70	73	86	108	132	150
D			50	55	60	80	90	100

\*Size 1 1/4 & larger = QA only

Materials

Parts	Material
Body	Cast Bronze
Bonnet	Forged Brass
Stem	Dezincification Resistant Brass
Disc	Urethane rubber/PTFE
Gland packing	Non-Asbestos Packing

⚠ Do not use for flammable gas or toxic gas.

# CLASS 150 BRONZE GLOBE VALVE

Screwed bonnet, Rising stem,  
Threaded ends to BS21 (JIS B0203) or NPT

W.O.G. non-shock 2.07 MPa (300 psi), Saturated steam pressure 1.03 MPa (150 psi)

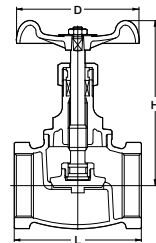

Fig. C

- Threaded end to BS21 (JIS B0203)

Fig. AKC

- Threaded end to ASME B1.20.1



Dimensions

Nominal Size	inch		mm									
	1/4	3/8	8	10	15	20	25	32	40	50	65	80
L			44	44	53	65	77	85	100	119	139	158
H valve open			66	68	79	93	104	127	145	174	199	215
D			50	50	60	70	80	90	100	115	135	155

Materials

Parts	Material
Body	Cast Bronze
Bonnet	Forged Brass / Cast Bronze*
Stem	Dezincification Resistant Brass
Disc	Cast Bronze
Gland packing	Non-Asbestos Packing

\*Size 3 only

⚠ Do not use for flammable gas or toxic gas.



## CLASS 150 BRONZE GLOBE VALVE

Screwed bonnet, Angle type body, Rising stem,  
Threaded ends to BS21 (JIS B0203) or NPT

W.O.G. non-shock 2.07 MPa (300 psi), Saturated steam pressure 1.03 MPa (150 psi)

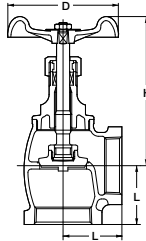

Fig. CA

- Threaded end to BS21 (JIS B0203)

Fig. AKCA

- Threaded end to ASME B1.20.1



### Materials

Parts	Material
Body	Cast Bronze
Bonnet	Forged Brass / Cast Bronze*
Stem	Dezincification Resistant Brass
Disc	Cast Bronze
Gland packing	Non-Asbestos Packing

\*Size 3 only

⚠ Do not use for flammable gas or toxic gas.

### Dimensions

Nominal Size	inch		mm									
	1/4	3/8	1/2	3/4	1	1 1/4	1 1/2	2	2 1/2	3	4	
L	21	24	28	34	40	47	52	61	74	85		
H valve open	66	68	79	93	104	127	145	174	199	215		
D	50	50	60	70	80	90	100	115	135	155		

## CLASS 150 BRONZE GLOBE VALVE

Screwed bonnet, Rising stem,  
Flanged ends drilled or undrilled optionally

W.O.G. non-shock 1.55 MPa (225 psi), Saturated steam pressure 1.03 MPa (150 psi)

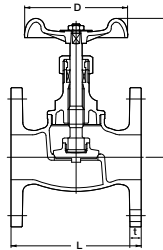

Fig. B

- Undrilled unless drilling is specified as an option

Fig. BH

- Drilled according to JIS 10K



### Materials

Parts	Material
Body	Cast Bronze
Bonnet	Forged Brass / Cast Bronze*
Stem	Dezincification Resistant Brass
Disc	Cast Bronze
Gland packing	Non-Asbestos Packing

\*Size 3 and 4

⚠ Do not use for flammable gas or toxic gas.

### Dimensions

Nominal Size	inch		mm									
	1/2	3/4	1	1 1/4	1 1/2	2	2 1/2	3	4			
L	83	88	100	113	120	145	165	177	220			
H valve open	79	94	105	127	145	174	198	215	250			
D	60	70	80	90	100	115	135	155	180			

\*"t" shall not be in accordance with JIS B 2240

## CLASS 125 BRONZE GLOBE VALVE

Union bonnet\*, Rising stem, Soft seated disc,  
Threaded ends to BS21 (JIS B0203) or NPT

W.O.G. non-shock 1.38 MPa (200 psi), Saturated steam pressure 0.86 MPa (125 psi)

\*Size 1/4: Screwed bonnet

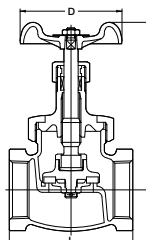

Fig. G

- Threaded end to BS21 (JIS B0203)

Fig. AGK

- Threaded end to ASME B1.20.1



### Materials

Parts	Material
Body	Cast Bronze
Bonnet	Forged Brass / Cast Bronze*
Stem	Dezincification Resistant Brass
Disc	G/F PTFE
Gland packing	Non-Asbestos Packing

\*Size 2 1/2 and 3

⚠ Do not use for flammable gas or toxic gas.

### Dimensions

Nominal Size	inch		mm									
	1/4	3/8	1/2	3/4	1	1 1/4	1 1/2	2	2 1/2	3	4	
L	47	53	57	66	76	88	100	120	147	162		
H valve open	68	88	100	110	120	140	156	185	210	229		
D	50	55	60	70	80	90	100	115	135	155		

# CLASS 150 BRONZE GLOBE VALVE

Union bonnet, Rising stem, Soft seated disc, Threaded ends to BS21 (JIS B0203)

W.O.G. non-shock 2.07 MPa (300 psi), Saturated steam pressure 1.03 MPa (150 psi)



Fig. D

• Threaded end to BS21 (JIS B0203)

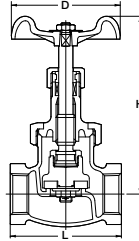

### Materials

Parts	Material
Body	Cast Bronze
Bonnet	Forged Brass / Cast Bronze*
Stem	Dezincification Resistant Brass
Disc	G/F PTFE
Gland packing	Non-Asbestos Packing

\*Size 1½ & 2

⚠ Do not use for flammable gas or toxic gas.

### Dimensions

Nominal Size	mm						
	inch	1/2	3/4	1	1¼	1½	2
	mm	15	20	25	32	40	50
L		64	78	90	105	120	145
H valve open		113	138	156	184	187	212
D		60	90	100	115	115	135

# CLASS 150 BRONZE GLOBE VALVE

Union bonnet\*, Rising stem, Soft seated disc, Flanged ends drilled or undrilled optionally

W.O.G. non-shock 1.55 MPa (225 psi), Saturated steam pressure 1.03 MPa (150 psi)

\*Size 2½ and larger: Bolted bonnet

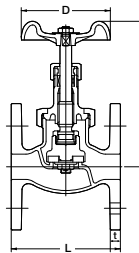

Fig. DB

• Undrilled unless drilling is specified as an option

Fig. DBH

• Drilled according to JIS 10K



### Materials

Parts	Material
Body	Cast Bronze
Bonnet	Forged Brass / Cast Bronze*
Stem	Dezincification Resistant Brass
Disc	G/F PTFE
Gland packing	Non-Asbestos Packing/PTFE Fiber Braid**

\*Size 1½ & larger

\*\*Size 4 only

⚠ Do not use for flammable gas or toxic gas.

### Dimensions

Nominal Size	mm									
	inch	1/2	3/4	1	1¼	1½	2	2½	3	4
	mm	15	20	25	32	40	50	65	80	100
L		82	95	108	120	140	165	190	220	270
H valve open		113	138	156	184	187	212	244	281	321
D		60	90	100	115	115	135	155	180	225

\*\*t\* shall not be in accordance with JIS B 2240

# CLASS 125 BRASS GATE VALVE

Screwed bonnet, Non-rising stem, Threaded ends to BS21 (JIS B0203) or NPT, or solder joint ends

W.O.G. non-shock 1.38 MPa (200 psi), Saturated steam pressure 0.86 MPa (125 psi)



Fig. FR\*

• Threaded end to BS21 (JIS B0203)

Fig. AKFS

• Threaded end to ASME B1.20.1



Fig. CFS

• Solder joint ends to ASME B16.18

\*Taper pipe threads for connection shall refer to JIS B0203 standards, while the length of useful threads and the positions of gauge planes are built on KITZ standard.

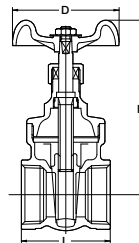

### Materials

Parts	Material
Body	Forged Brass
Bonnet	Forged Brass
Stem	Dezincification Resistant Brass
Disc	Forged Brass
Gland packing	Non-Asbestos Packing

⚠ Solder joint end valves should not be used in service where the temperature of the line fluid is higher than the softening point of the solder.

⚠ Do not use for flammable gas or toxic gas.

### Dimensions

Nominal Size	mm									
	inch	3/8	1/2	3/4	1	1¼	1½	2	2½	3
	mm	10	15	20	25	32	40	50	65	80
L		38	42	47	50	60	63	72	80	90
L1 Solder			45	60	70	77	86	104		
H		73	73	87	97	117/118**	126	154	167	200
H Solder			75	86	97	117	126	154		
D		50	50	55	60	70	80	90	100	115

\*2½ and 3 = AKFS only \*\*AKFS

# CLASS 125 BRASS GATE VALVE

Screwed bonnet, Non-rising stem, Threaded ends to BS21 (JIS B0203) or NPT, or solder joint ends

W.O.G. non-shock 1.38 MPa (200 psi), Saturated steam pressure 0.86 MPa (125 psi)



Fig. FH\*

- Threaded end to BS21 (JIS B0203)



Fig. CFH

- Solder joint ends to ASME B16.18

Fig. AKFH

- Threaded end to ASME B1.20.1

\*Taper pipe threads for connection shall refer to JIS B0203 standards, while the length of useful threads and the positions of gauge planes are built on KITZ standard.

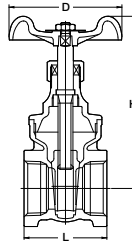

### Materials

Parts	Material
Body	Forged Brass
Bonnet	Forged Brass
Stem	Dezincification Resistant Brass
Disc	Forged Brass
Gland packing	Non-Asbestos Packing

⚠ Solder joint end valves should not be used in service where the temperature of the line fluid is higher than the softening point of the solder.

⚠ Do not use for flammable gas or toxic gas.

### Dimensions

Nominal Size	mm										
	inch	1/4	3/8	1/2	3/4	1	1 1/4	1 1/2	2	2 1/2	3
L	35	38	42	47	50	60	63	72	82	92	
L1 Solder		37	45	60	70	77	86	104	115	127	
H	70	73	73	87	97	118	126	154	187	205	
H Solder		77	77	87	97	118	126	154	187	205	
D	50	50	50	55	60	70	80	90	100	115	

# CLASS 125 BRONZE GATE VALVE

Screwed bonnet\*, Non-rising stem, Threaded ends to BS21 (JIS B0203) or NPT, or solder joint ends

W.O.G. non-shock 1.38 MPa (200 psi), Saturated steam pressure 0.86 MPa (125 psi)

\*Size 3/8 to 2: Screwed-over-bonnet



Fig. H\*

- Threaded end to BS21 (JIS B0203)

Fig. AKH

- Threaded end to ASME B1.20.1



Fig. CH

- Solder joint ends to ASME B16.18

\*Taper pipe threads for connection shall refer to JIS B0203 standards, while the length of useful threads and the positions of gauge planes are built on KITZ standard. (size up to 2 and 4)

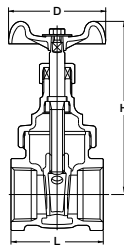

### Materials

Parts	Material
Body	Cast Bronze
Bonnet	Cast Bronze
Stem	Dezincification Resistant Brass
Disc	Dezincification Resistant Brass/Cast Bronze*
Gland packing	Non-Asbestos Packing

\*Size 3/4 & larger

⚠ Solder joint end valves should not be used in service where the temperature of the line fluid is higher than the softening point of the solder.

⚠ Do not use for flammable gas or toxic gas.

### Dimensions

Nominal Size	mm										
	inch	3/8	1/2	3/4	1	1 1/4	1 1/2	2	2 1/2	3	4
L	42	45	50	57	61	67	74	90	100	121	
L1 Solder		39	46	61	72	78	87	102	115	130	173
H	74	80	90	105	118	135	159	202	223	280	
D	50	50	55	60	70	80	90	115	135	155	

# CLASS 125 BRONZE GATE VALVE

Screwed bonnet, Non-rising stem, Threaded ends to BS21 (JIS B0203)

W.O.G. non-shock 1.38 MPa (200 psi), Saturated steam pressure 0.86 MPa (125 psi)



Fig. S\*

- Threaded end to BS21 (JIS B0203)

\*Taper pipe threads for connection shall refer to JIS B0203 standards, while the length of useful threads and the positions of gauge planes are built on KITZ standard.

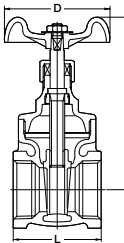

### Materials

Parts	Material
Body	Cast Bronze
Bonnet	Forged Brass
Stem	Dezincification Resistant Brass
Disc	Forged Brass
Gland packing	Non-Asbestos Packing

⚠ Do not use for flammable gas or toxic gas.

### Dimensions

Nominal Size	mm									
	inch	3/8	1/2	3/4	1	1 1/4	1 1/2	2	2 1/2	3
L	38	42	47	50	60	63	72	80	90	
H	75	75	86	97	117	126	154	167	200	
D	50	50	55	60	70	80	90	100	115	

# CLASS 150 BRONZE GATE VALVE

Screwed bonnet, Non-rising stem,  
Threaded ends to BS21 (JIS B0203) or NPT

W.O.G. non-shock 2.07 MPa (300 psi), Saturated steam pressure 1.03 MPa (150 psi)

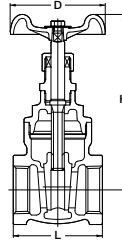

Fig. E

- Threaded end to BS21 (JIS B0203)

Fig. AKE

- Threaded end to ASME B1.20.1



### Materials

Parts	Material
Body	Cast Bronze
Bonnet	Forged Brass / Cast Bronze*
Stem	Dezincification Resistant Brass
Disc	Cast Bronze
Gland packing	Non-Asbestos Packing

\*Size 2½ & 3

⚠ Do not use for flammable gas or toxic gas.

### Dimensions

Nominal Size	inch	3/8	1/2	3/4	1	1 1/4	1 1/2	2	2 1/2	3	mm
	mm	10	15	20	25	32	40	50	65	80	
L		43	48	53	62	69	75	86	105	116	
H		86	96	111	122	141	164	197	225	261	
D		50	55	60	70	80	90	100	115	135	

# CLASS 150 BRONZE GATE VALVE

Screwed bonnet, Non-rising stem,  
Flanged ends drilled or undrilled optionally

W.O.G. non-shock 2.07 MPa (300 psi), Saturated steam pressure 1.03 MPa (150 psi)

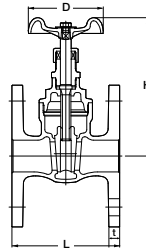

Fig. EB

- Undrilled unless drilling is specified as an option

Fig. EBH

- Drilled according to JIS 10K



### Materials

Parts	Material
Body	Cast Bronze
Bonnet	Forged Brass / Cast Bronze*
Stem	Dezincification Resistant Brass/Forged Brass**
Disc	Cast Bronze
Gland packing	Non-Asbestos Packing/PTFE Braided**

\*Size 2½ & larger  
\*\*Size 5.6

⚠ Do not use for flammable gas or toxic gas.

### Dimensions

Nominal Size	inch	1/2	3/4	1	1 1/4	1 1/2	2	2 1/2	3	4	5	6	mm
	mm	15	20	25	32	40	50	65	80	100	125	150	
L		75	80	95	110	120	140	165	190	230	190	210	
H		96	111	122	142	165	197	225	264	309	381	427	
D		55	60	70	80	90	100	115	155	225	225	250	
t*		8	9	9.5	10.5	11.5	13	14.5	16	19.5	20	22	

\*\*\*t\* shall not be in accordance with JIS B 2240

# CLASS 150 BRONZE LIFT CHECK VALVE

Screwed cap, Lift type disc  
Threaded ends to BS21 (JIS B0203) or NPT

W.O.G. non-shock 2.07 MPa (300 psi), Saturated steam pressure 1.03 MPa (150 psi)

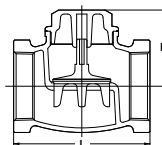

Fig. F

- Threaded end to BS21 (JIS B0203)

Fig. AKF

- Threaded end to ASME B1.20.1



### Materials

Parts	Material
Body	Cast Bronze
Cap	Forged Brass / Cast Bronze*
Disc	Cast Bronze

\*Size 2½ & 3

⚠ Do not use for flammable gas or toxic gas.

### Dimensions

Nominal Size	inch	3/8	1/2	3/4	1	1 1/4	1 1/2	2	2 1/2	3	mm
	mm	10	15	20	25	32	40	50	65	80	
L		44	53	65	77	85	100	119	139	158	
H		26	28	34	42	50	56	67	79	91	

## CLASS 125 BRONZE SWING CHECK VALVE

Screwed cap, Swing type disc,  
Threaded ends to BS21 (JIS B0203) or NPT

W.O.G. non-shock 1.38 MPa (200 psi), Saturated steam pressure 0.86 MPa (125 psi)

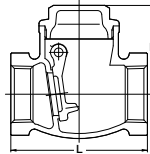

Fig. R

- Threaded end to BS21 (JIS B0203)

Fig. AKR

- Threaded end to ASME B1.20.1



### Materials

Parts	Material
Body	Cast Bronze
Cap	Forged Brass / Cast Bronze*
Hinge pin	Brass Rod
Disc	Forged Brass / Cast Bronze*

\*Size 4 only

⚠ Do not use for flammable gas or toxic gas.

### Dimensions

Nominal Size	inch	3/8	1/2	3/4	1	1 1/4	1 1/2	2	2 1/2	3	4
	mm	10	15	20	25	32	40	50	65	80	100
L		53	60	70	80	92	102	122	150	165	195
H		39	39	45	52	62	67	79	91	102	

## CLASS 125 BRONZE Y-PATTERN SWING CHECK VALVE

Screwed cap, Swing type disc,  
Threaded ends to BS21 (JIS B0203)

W.O.G. non-shock 1.38 MPa (200 psi), Saturated steam pressure 0.86 MPa (125 psi)



Fig. YR\*

- Threaded end to BS21 (JIS B0203)

\*Taper pipe threads for connection shall refer to JIS B0203 standards, while the length of useful threads and the positions of gauge planes are built on KITZ standard. (size 1/2 & larger)

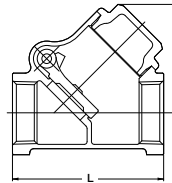

### Materials

Parts	Material
Body	Cast Bronze
Cap	Forged Brass
Hinge pin	Tough Pitch Copper
Disc	Cast Bronze

⚠ Do not use for flammable gas or toxic gas.

### Dimensions

Nominal Size	inch	3/8	1/2	3/4	1	1 1/4	1 1/2	2
	mm	10	15	20	25	32	40	50
L		54	56	70	80	95	110	128
H		40	40	49	58	71	80	95

## CLASS 150 BRONZE LIFT CHECK VALVE

Screwed cap, Lift type disc,  
Threaded ends to BS21 (JIS B0203) or NPT

W.O.G. non-shock 1.72 MPa (250 psi)

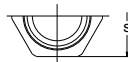
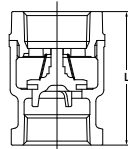

Fig. RF

- Threaded end to BS21 (JIS B0203)
- NBR Disc

Fig. AKAF

- Threaded end to ASME B1.20.1
- FKM Disc



### Materials

Parts	Material
Body	Cast Bronze
Cap	Cast Bronze
Disc	NBR/FKM*

\*AKAF & CAF

⚠ Do not use for flammable gas or toxic gas.

### Dimensions

Nominal Size	inch	1/2	3/4	1	1 1/4	1 1/2	2
	mm	15	20	25	32	40	50
L		53	59	67	78	84	98
S (AKAF)		26	32	39	48	54	67
S (RF)		28	34	41	50	57	70

5K

BRONZE LIFT CHECK VALVE

Screwed cap, Lift type disc,  
Threaded ends to BS21 (JIS B0203)

W.O.G. non-shock 120°C (0.5 MPa)

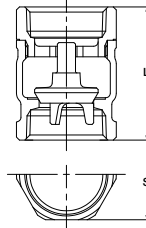

Materials

Parts	Material
Body	Cast Bronze
Cap	Forged Brass / Cast Bronze*
Disc	Dezincification Resistant Brass / Cast Bronze*

\*Size 1 to 2

⚠ Do not use for flammable gas or toxic gas.

Fig. VF

• Threaded end to BS21 (JIS B0203)

Dimensions

Nominal Size	inch	1/2	3/4	1	1 1/4	1 1/2	2	mm
	mm	15	20	25	32	40	50	
L		37	44	51	62	69	82	
S		24	30	36	45	52	63	

5K

BRONZE LIFT CHECK VALVE

Screwed cap, Lift type disc,  
Threaded ends to BS21 (JIS B0203) and parallel

Water 80°C (0.5 MPa)

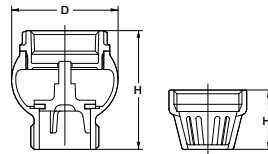

Materials

Parts	Material
Body	Cast Bronze
Cap	Cast Bronze
Disc	NBR

⚠ Do not use for flammable gas or toxic gas.

Fig. FT

• Threaded end to BS21 (JIS B0203) and parallel

Fig. FTS

(Screen)  
Threaded end to parallel

Dimensions

Nominal Size	inch	3/4	1	1 1/4	1 1/2	2	2 1/2	3	mm
	mm	20	25	32	40	50	65	80	
H		48	58	62	70	80	90	100	
D		41	52	62	70	83	102	116	
H1		25	29	32	35	43	50	51	

CLASS 150

Y-PATTERN STRAINER

Y-pattern body, Screwed cap, 304 stainless steel screen,  
Threaded ends to BS21 (JIS B0203) or NPT,  
or solder joint ends

W.O.G. non-shock 2.07 MPa (300 psi), Saturated steam pressure 1.03 MPa (150 psi) up to size 2\*

\*Contact KITZ for larger sizes

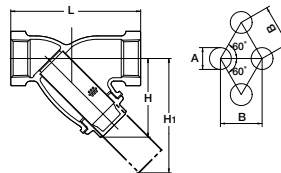

Materials

Parts	Material
Body	Cast Bronze
Body cap	Forged Brass
Screen	Stainless Steel

	A	B
3/8 to 2	1.4	2.4
2 1/2 to 3	1.5	2.5

⚠ Solder joint end valves should not be used in service where the temperature of the line fluid is higher than the softening point of the solder.

⚠ Do not use for flammable gas or toxic gas.

Fig. Y

• Threaded end to BS21 (JIS B0203)

Fig. AKY

• Threaded end to ASME B1.20.1

Fig. CY

• Solder joint ends to JIS B2011 / ASME B16.18 (2 1/2 & 3)

Dimensions

Nominal Size	inch	3/8	1/2	3/4	1	1 1/4	1 1/2	2	2 1/2	3	mm
	mm	10	15	20	25	32	40	50	65	80	
L		70	80	100	115	135	160	195	230	240	
L1 Solder			80	105	125	145	170	210	250	280	
H		43	48	57	70	82	98	121	149	182	
H1		61	68	83	105	124	149	188	216	267	

**CLASS 175 BRASS BUTTERFLY VALVE**

NBR lined disc, Balancing stop hand lever,  
Threaded ends to BS21 (JIS B0203)

W.O.G. non-shock 1.21 MPa (175 psi)

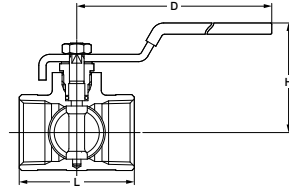

**Materials**

Parts	Material
Body	Forged Brass
Stem	Stainless Steel
Disc	Stainless Steel + White-NBR
O-ring	NBR

⚠ Do not use for flammable gas or toxic gas.

**Dimensions**

Nominal Size	inch	1/2	3/4	1	1 1/4	1 1/2	2	mm
	mm	15	20	25	32	40	50	
L		47	51	58	67	73	82	
H		44	47	50	60	63	70	
D		85	85	85	110	110	110	

**Fig. FV**

• Threaded end to BS21 (JIS B0203)



10K

JIS 10K BRONZE GLOBE VALVE

Screwed bonnet\* Rising stem,  
Designed to JIS B2011,  
Threaded end to JIS B0203 (also to BS21)

W.O.G -29°C to +120°C (not freezing) 1.4 MPa, Saturated steam pressure 1.0 MPa (See P.17)

\*Size 3 : Bolted bonnet



Fig. J

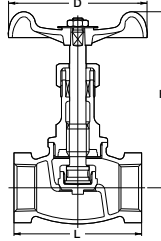

Materials

Parts	Material
Body	Cast Bronze
Bonnet	Forged Brass / Cast Bronze*
Stem	Dezincification Resistant Brass
Disc	Cast Bronze
Gland packing	Non-asbestos Packing

\*Size 1 & larger

⚠ Do not use for flammable gas or toxic gas.

Dimensions

Nominal Size	inch	1/4	3/8	1/2	3/4	1	1 1/4	1 1/2	2	2 1/2	3	mm
	mm	8	10	15	20	25	32	40	50	65	80	
L		50	55	65	80	90	105	120	140	180	200	
H valve open		86	87	93	122	135	157	171	196	232	268	
D		50	55	60	80	90	100	115	135	155	180	

10K

10K BRONZE GLOBE VALVE

Screwed bonnet\* Rising stem,  
Designed to JIS B2011,  
Flanged end to JIS B2011

Water, non-shock 120°C (1.4 MPa), Oil & water 120°C (1.0 MPa), Saturated steam pressure 1.0 MPa

\*Size 3 & larger : Bolted bonnet



Fig. JB

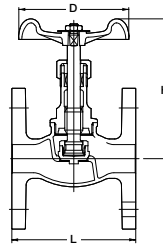

Materials

Parts	Material
Body	Cast Bronze
Bonnet	Forged Brass / Cast Bronze*
Stem	Dezincification Resistant Brass
Disc	Cast Bronze
Gland packing	Non-asbestos Packing

\*Size 1 & larger

⚠ Do not use for flammable gas or toxic gas.

Dimensions

Nominal Size	inch	1/2	3/4	1	1 1/4	1 1/2	2	2 1/2	3	4	mm
	mm	15	20	25	32	40	50	65	80	100	
L		85	95	110	130	150	180	210	240	280	
H valve open		93	122	135	157	171	196	232	268	323	
D		60	80	90	100	115	135	155	180	225	
t*		10	10	12	12	14	14	16	16	18	

\*Shall not be in accordance with JIS B2011

5K

JIS 5K BRONZE GATE VALVE

Screwed bonnet, Rising stem,  
Designed to JIS B2011,  
Threaded end to JIS B0203 (also to BS21)

W.O.G -29°C to +120°C (not freezing) 0.7 MPa, Saturated steam pressure 0.5 MPa (See P.17)



Fig. M

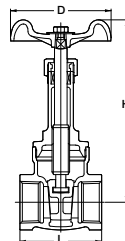

Materials

Parts	Material
Body	Cast Bronze
Bonnet	Cast Bronze
Stem	Dezincification Resistant Brass
Disc	Cast Bronze
Gland packing	Non-asbestos Packing

⚠ Do not use for flammable gas or toxic gas.

Dimensions

Nominal Size	inch	1/2	3/4	1	1 1/4	1 1/2	2	2 1/2	3	mm
	mm	15	20	25	32	40	50	65	80	
L		50	60	65	75	85	95	115	130	
H valve open		126	145	169	209	239	285	366	428	
D		60	60	70	90	100	115	135	155	



10K

JIS 10K BRONZE GATE VALVE

Screwed bonnet, Rising stem,  
Designed to JIS B2011,  
Threaded ends to JIS B0203 (also to BS21)

W.O.G -29°C to +120°C (not freezing) 1.4 MPa, Saturated steam pressure 1.0 MPa (See P.17)



Fig. L

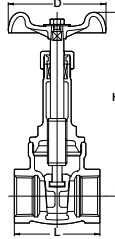

Materials

Parts	Material
Body	Cast Bronze
Bonnet	Cast Bronze
Stem	Dezincification Resistant Brass
Disc	Cast Bronze
Gland packing	Non-asbestos Packing

⚠ Do not use for flammable gas or toxic gas.

Dimensions

Nominal Size	inch	1/2	3/4	1	1 1/4	1 1/2	2	2 1/2	3	mm
	mm	15	20	25	32	40	50	65	80	
L		55	65	70	80	90	100	120	140	
H valve open		124	149	173	217	248	292	377	436	
D		60	70	80	90	100	115	155	180	

10K

10K BRONZE GATE VALVE

Screwed bonnet\*, Rising stem,  
Designed to JIS B2011,  
Flanged ends to JIS B2011

Water, non-shock 120°C (1.4 MPa), Oil & water 120°C (1.0 MPa), Saturated steam pressure 0.7 MPa

\*Size 4 : Bolted bonnet



Fig. LB

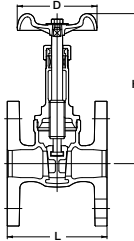

Materials

Parts	Material
Body	Cast Bronze
Bonnet	Cast Bronze
Stem	Dezincification Resistant Brass
Disc	Cast Bronze
Gland packing	Non-asbestos Packing

⚠ Do not use for flammable gas or toxic gas.

Dimensions

Nominal Size	inch	3/4**	1	1 1/4	1 1/2	2	2 1/2	3	4**	mm
	mm	20**	25	32	40	50	65	80	100**	
L		90	100	110	125	140	170	190	220	
H valve open		153	178	223	254	302	376	436	327	
D		70	80	90	100	115	155	180	225	
t*		10	12	12	14	14	16	16	18	

\*t\* Shall not be in accordance with JIS B2011 \*\*3/4 & 4 shall not be in accordance with JIS B2011

10K

JIS 10K BRONZE SWING CHECK VALVE

Screwed bonnet, Swing type disc,  
Designed to JIS B2011, Threaded  
ends to JIS B0203 (also to BS21)

W.O.G -29°C to +120°C (not freezing) 1.4 MPa, Saturated steam pressure 1.0 MPa (See P.17)



Fig. O

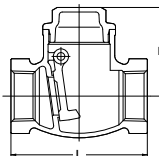

Materials

Parts	Material
Body	Cast Bronze
Cap	Forged Brass
Hinge pin	Brass Rod
Disc	Cast Bronze

⚠ Do not use for flammable gas or toxic gas.

Dimensions

Nominal Size	inch	3/8	1/2	3/4	1	1 1/4	1 1/2	2	2 1/2*	3*	mm
	mm	10	15	20	25	32	40	50	65	80	
L		55	65	80	90	105	120	140	180	200	
H		38.5	43	51.5	58.5	67	73.5	86	97	108	

\*Size 2 1/2 & 3 shall not be in accordance with JIS B2011

10K

10K BRONZE SWING CHECK VALVE

Screwed bonnet,  
Swing type disc,  
Flanged end to JIS B2240

Water, non-shock 120°C (1.4 MPa), Oil & water 120°C (1.0 MPa), Saturated steam pressure 0.7 MPa

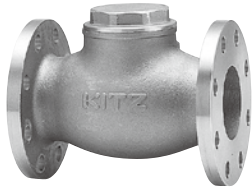
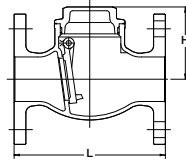

Fig. OB



Materials

Parts	Material
Body	Cast Bronze
Bonnet	Forged Brass / Cast Bronze*
Hinge pin	Brass Rod
Disc	Cast Bronze

\*Size 4 only

⚠ Do not use for flammable gas or toxic gas.

Dimensions

Nominal Size	inch	1/2	3/4	1	1 1/4	1 1/2	2	2 1/2	3	4	mm
	mm	15	20	25	32	40	50	65	80	100	
L		85	95	110	130	150	180	210	240	280	
H		43	52	59	67	74	86	97	108	127	
t*		10	10	12	12	14	14	16	16	18	

\*t shall not be in accordance with JIS B2240

10K

BRONZE WAFER TYPE CHECK VALVE

Double plate,  
Wafer connection JIS 10K

Water, Oil, Gas 80°C (1.4 MPa)

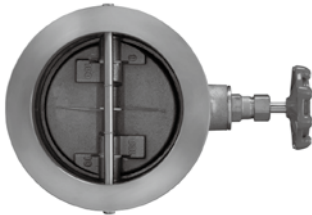
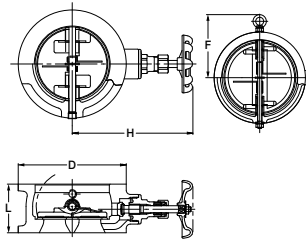

Fig. 10BWZ

• With by-pass



Materials

Parts	Material
Body	Cast Bronze + NBR
Bonnet	Forged Brass / Cast Bronze*
Stem	Dezincification Resistant Brass
Disc A	Cast Bronze
Disc B	Dezincification Resistant Brass

\*Size 6 and larger

Dimensions

Nominal Size	inch	1 1/2	2	2 1/2	3	4	5	6	8	10	12	mm
	mm	40	50	65	80	100	125	150	200	250	300	
L		54	56	56	59	66	72	78	96	109	145	
H		132	139	146	152	165	183	208	237	289	316	
D		86	101	121	131	156	187	217	267	330	375	
F									187	231	256	

## Technical data of pressure and temperature ratings of JIS-standard bronze valves

- Fluid  
Water, oil, gas, air and steam.  
However, Flammable gas and toxic gas are excluded.
- Relationship between the temperature of the fluid and the maximum permissible pressure (hereinafter referred to as the "pressure-temperature criteria") shall be in accordance with Table 1.  
However, the fluid shall not be frozen.
- In the case where the use of valves is prohibited or restricted by the High Pressure Gas Safety Act and other regulations, the user shall use them within the framework of laws and ordinances.

**Table 1 Pressure-temperature criteria**

Nominal pressure	Temperature of fluid °C	Maximum permissible working pressure <sup>c)</sup> MPa
5K	-29 to 120	0.7
	159 <sup>a)</sup>	0.5
10K	-29 to 120	1.4
	185 <sup>b)</sup>	1.0

### Notes

- It shall be the maximum service temperature, and in the case of a gate valve, it shall be 134°C.
- It shall be the maximum service temperature, and in the case of a gate valve, it shall be 171°C.
- The maximum permissible pressure at an intermediate temperature between a temperature above 120°C and the maximum service temperature shall be obtained by proportional interpolation.

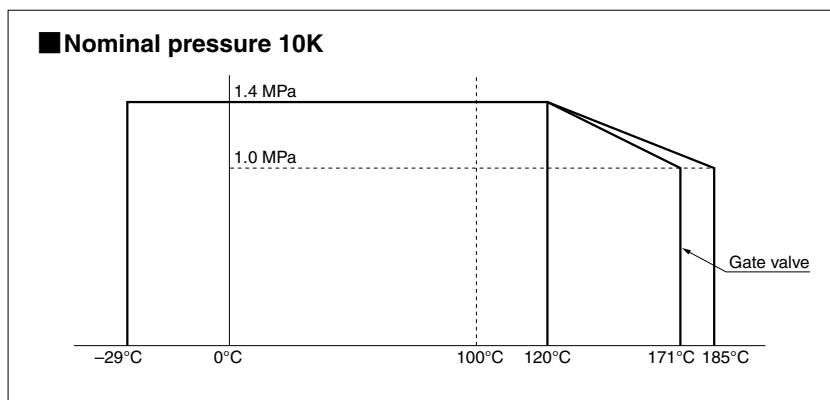
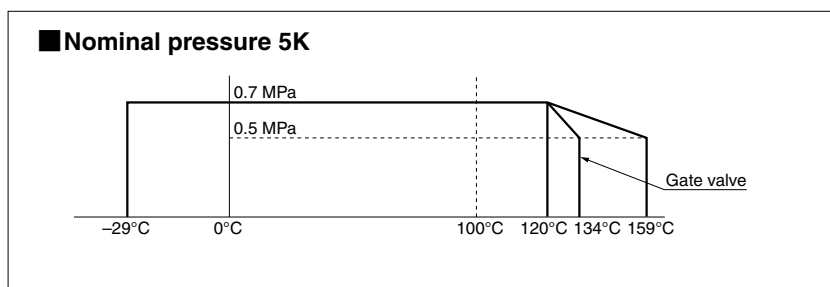

## CLASS 125 BRONZE GATE VALVE

Screwed bonnet, Rising stem, Designed to MSS SP-80 type 2, Threaded ends to NPT

W.O.G. non-shock 1.38 MPa (200 psi), Saturated steam pressure 0.86 MPa (125 psi)



Fig. AK125M

- Threaded end to ASME B1.20.1

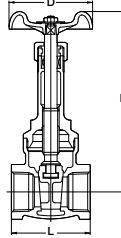

### Materials

Parts	Material
Body	Cast Bronze
Bonnet	Cast Bronze
Stem	Cast Bronze
Disc	Cast Bronze
Gland packing	Non-Asbestos Packing

⚠ Do not use for flammable gas or toxic gas.

### Dimensions

Nominal Size	inch		mm							
	1/2	3/4	1	1 1/4	1 1/2	2	2 1/2	3		
	15	20	25	32	40	50	65	80		
L	51	56	66	68	74	84	115	130		
H valve open	129	155	180	216	257	296	371	432		
D	55	60	70	80	90	100	135	155		

## CLASS 125 BRONZE GATE VALVE

Screwed bonnet, Non-rising stem, Designed to MSS SP-80 type 1A, Threaded ends to NPT

W.O.G. non-shock 1.38 MPa (200 psi), Saturated steam pressure 0.86 MPa (125 psi)



Fig. AK125E

- Threaded end to ASME B1.20.1

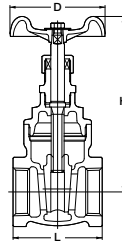

### Materials

Parts	Material
Body	Cast Bronze
Bonnet	Cast Bronze
Stem	Cast Bronze
Disc	Cast Bronze
Gland packing	Non-Asbestos Packing

⚠ Do not use for flammable gas or toxic gas.

### Dimensions

Nominal Size	inch		mm					
	3/8	1/2	3/4	1	1 1/4	1 1/2	2	
	10	15	20	25	32	40	50	
L	43	49	53	61	64	68	74	
H	86	93	110	126	145	170/176*	189/201*	
D	50	55	60/70*	70	80	90	100	

## CLASS 150 BRONZE GATE VALVE

Screwed bonnet, Non-rising stem, Designed to MSS SP-80 type 1A, Threaded ends to NPT

W.O.G. non-shock 2.07 MPa (300 psi), Saturated steam pressure 1.03 MPa (150 psi)



Fig. AK150E

- Threaded end to ASME B1.20.1

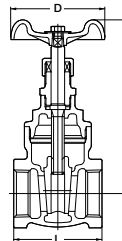

### Materials

Parts	Material
Body	Cast Bronze
Bonnet	Cast Bronze
Stem	Cast Bronze
Disc	Cast Bronze
Gland packing	Non-Asbestos Packing

⚠ Do not use for flammable gas or toxic gas.

### Dimensions

Nominal Size	inch		mm					
	3/8	1/2	3/4	1	1 1/4	1 1/2	2	
	10	15	20	25	32	40	50	
L	43	49	53	61	68	74	84	
H	86	98	114	126	145	176	201	
D	50	55	70	70	80	90	100	

## CLASS 150 BRONZE GATE VALVE

Screwed bonnet, Rising stem, Designed to MSS SP-80 type 2, Threaded ends to NPT or solder joint ends

W.O.G. non-shock 2.07 MPa (300 psi), Saturated steam pressure 1.03 MPa (150 psi)



Fig. AK150L

• Threaded end to ASME B1.20.1



Fig. C150L

• Solder joint end to ASME B16.18

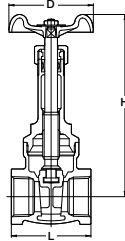

### Materials

Parts	Material
Body	Cast Bronze
Bonnet	Cast Bronze
Stem	Cast Bronze
Disc	Cast Bronze
Gland packing	Non-Asbestos Packing

⚠ Solder joint end valves should not be used in service where the temperature of the line fluid is higher than the softening point of the solder.

⚠ Do not use for flammable gas or toxic gas.

### Dimensions

Nominal Size	inch	1/2	3/4	1	1 1/4	1 1/2	2	2 1/2	3
	mm	15	20	25	32	40	50	65	80
L		51	56	66	68	74	84	120	140
L1 Solder		49	64	76	82	86	109		
H valve open		137	157	180	216	257	296	385	432
D		55	70	70	80	90	100	155	155

## CLASS 150 BRONZE GATE VALVE

Union bonnet, Rising stem, Designed to MSS SP-80 type 2, Threaded ends to NPT

W.O.G. non-shock 2.07 MPa (300 psi), Saturated steam pressure 1.03 MPa (150 psi)



Fig. AK150LU

• Threaded end to ASME B1.20.1

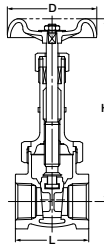

### Materials

Parts	Material
Body	Cast Bronze
Bonnet	Cast Bronze
Stem	Cast Bronze
Disc	Cast Bronze
Gland packing	Flexible Graphite & Aluminum

⚠ Do not use for flammable gas or toxic gas.

### Dimensions

Nominal Size	inch	1/4	3/8	1/2	3/4	1	1 1/4	1 1/2	2
	mm	15	15	15	20	25	32	40	50
L		45	46	51	56	66	68	74	84
H valve open		122	122	144	164	185	219	258	303
D		50	50	55	70	70	80	90	100

## CLASS 300 BRONZE GATE VALVE

Union bonnet, Rising stem, Designed to MSS SP-80 type 2, Threaded ends to NPT

W.O.G. non-shock 6.89 MPa (1000 psi), Saturated steam pressure 2.07 MPa (300 psi)



Fig. AK300LU

• Threaded end to ASME B1.20.1

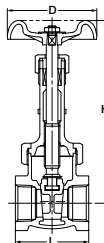

### Materials

Parts	Material
Body	Cast Bronze
Bonnet	Cast Bronze
Stem	Cast Bronze
Disc	Cast Bronze
Gland packing	Flexible Graphite & Aluminum

⚠ Do not use for flammable gas or toxic gas.

### Dimensions

Nominal Size	inch	3/8	1/2	3/4	1	1 1/4	1 1/2	2
	mm	10	15	20	25	32	40	50
L		46	51	56	66	74	84	98
H valve open		125	149	173	194	228	274	313
D		60	70	80	80	100	115	135

**CLASS 125**

**BRONZE GLOBE VALVE**

Screwed bonnet, Rising stem, Designed to MSS SP-80 type 1, Threaded ends to NPT

W.O.G. non-shock 1.38 MPa (200 psi), Saturated steam pressure 0.86 MPa (125 psi)



**Fig. AK125C**

• Threaded end to ASME B1.20.1

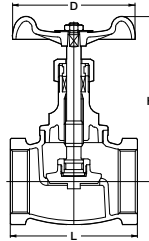

**Materials**

Parts	Material
Body	Cast Bronze
Bonnet	Forged Brass / Cast Bronze*
Stem	Cast Bronze
Disc	Cast Bronze
Gland packing	Non-Asbestos Packing

\*Size 2 1/2 & 3

⚠ Do not use for flammable gas or toxic gas.

**Dimensions**

Nominal Size	inch	1/2	3/4	1	1 1/4	1 1/2	2	2 1/2	3	mm
	mm	15	20	25	32	40	50	65	80	
L		53	65	77	85	100	119	150	178	
H valve open		76	98	108	137	160	180	202	246	
D		60	70	80	90	100	115	135	155	

**CLASS 150**

**BRONZE GLOBE VALVE**

Union bonnet\*, Rising stem, Designed to MSS SP-80 type 2, Threaded end to NPT or solder joint ends

W.O.G. non-shock 2.07 MPa (300 psi), Saturated steam pressure 1.03 MPa (150 psi)

\*Size 2 1/2 and larger: Bolted bonnet



**Fig. AK150D**

• Threaded end to ASME B1.20.1



**Fig. C150D**

• Solder joint end to ASME B16.18

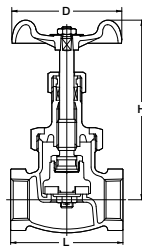

**Materials**

Parts	Material
Body	Cast Bronze
Bonnet	Cast Bronze
Stem	Cast Bronze
Disc	G/F PTFE
Gland packing	Non-Asbestos Packing PTFE Braided Packing**

\*\*Size 3 & 4

⚠ Solder joint end valves should not be used in service where the temperature of the line fluid is higher than the softening point of the solder.

⚠ Do not use for flammable gas or toxic gas.

**Dimensions**

Nominal Size	inch	1/4	3/8	1/2	3/4	1	1 1/4	1 1/2	2	2 1/2	3	4	mm
	mm	8	10	15	20	25	32	40	50	65	80	100	
L		53	55	64	78	90	105	120	145	170	200	245	
L1 Solder		58	61	72	95	112	126	145	180	205	244	312	
H valve open		109	109	116	136	149	173	182	209	247	275	298	
D		60	60	70	90	100	115	115	135	155	180	225	

**CLASS 300**

**BRONZE GLOBE VALVE**

Union bonnet, Rising stem, Designed to MSS SP-80 type 1, Threaded ends to NPT

W.O.G. non-shock 4.14 MPa (600 psi), Saturated steam pressure 2.07 MPa (300 psi)



**Fig. AK300J**

• Threaded end to ASME B1.20.1

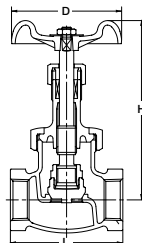

**Materials**

Parts	Material
Body	Cast Bronze
Bonnet	Cast Bronze
Stem	Cast Bronze
Disc	Cast Bronze
Gland packing	Flexible Graphite & Aluminum

⚠ Do not use for flammable gas or toxic gas.

**Dimensions**

Nominal Size	inch	1/4	3/8	1/2	3/4	1	1 1/4	1 1/2	2	mm
	mm	8	10	15	20	25	32	40	50	
L		53	55	64	78	90	105	120	145	
H valve open		111	111	124	138	158	186	192	223	
D		60	60	80	90	100	115	135	155	

**CLASS 300**

**BRONZE GLOBE VALVE**

Union bonnet, Rising stem, Designed to MSS SP-80 type 2, Threaded end to NPT

W.O.G. non-shock 4.14 MPa (600 psi), Saturated steam pressure 2.07 MPa (300 psi)



**Fig. AK300D**

• Threaded end to ASME B1.20.1

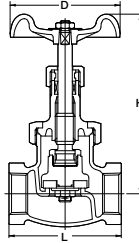

**Materials**

Parts	Material
Body	Cast Bronze
Bonnet	Cast Bronze
Stem	Cast Bronze
Disc	G/F PTFE
Gland packing	Flexible Graphite & Aluminum

⚠ Do not use for flammable gas or toxic gas.

**Dimensions**

Nominal Size	inch	1/4	3/8	1/2	3/4	1	1 1/4	1 1/2	2	mm
	mm	8	10	15	20	25	32	40	50	
L		53	55	64	78	90	105	120	145	
H valve open		113	113	126	139	157	187	192	221	
D		60	60	80	90	100	115	135	155	

**CLASS 125**

**BRONZE Y-PATTERN SWING CHECK VALVE**

Screwed cap, Swing type disc, Designed to MSS SP-80 type 3, Threaded ends to NPT or solder joint ends

W.O.G. non-shock 1.38 MPa (200 psi), Saturated steam pressure 0.86 MPa (125 psi)



**Fig. AKYR**

• Threaded end to ASME B1.20.1



**Fig. CYR**

• Solder joint end to ASME B16.18

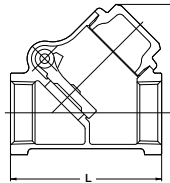

**Materials**

Parts	Material
Body	Cast Bronze
Cap	Forged Brass
Hinge pin	Copper
Disc	Cast Bronze

⚠ Solder joint end valves should not be used in service where the temperature of the line fluid is higher than the softening point of the solder.

⚠ Do not use for flammable gas or toxic gas.

**Dimensions**

Nominal Size	inch	1/2	3/4	1	1 1/4	1 1/2	2	2 1/2	3	mm
	mm	15	20	25	32	40	50	65	80	
L		56	70	80	95	110	128	156	184	
L1 Solder		67	86	105	121	137	170	194	222	
H		40	49	58	71	80	95	114	131	
H1 Solder		38	47	56	69	77	92	111	127	

**CLASS 150**

**BRONZE Y-PATTERN SWING CHECK VALVE**

Screwed cap, Swing type disc, Designed to MSS SP-80 type 3, Threaded ends to NPT

W.O.G. non-shock 2.07 MPa (300 psi), Saturated steam pressure 1.03 MPa (150 psi)



**Fig. AK150YR**

• Threaded end to ASME B1.20.1

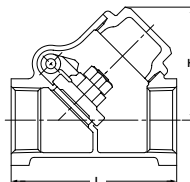

**Materials**

Parts	Material
Body	Cast Bronze
Cap	Forged Brass
Hinge pin	Copper
Disc	Cast Bronze

⚠ Do not use for flammable gas or toxic gas.

**Dimensions**

Nominal Size	inch	3/8	1/2	3/4	1	1 1/4	1 1/2	2	2 1/2	3	mm
	mm	10	15	20	25	32	40	50	65	80	
L		54	60	72	84	99	113	131	162	186	
H		39	39	49	58	70	79	95	114	132	

**CLASS 300**

**BRONZE Y-PATTERN SWING CHECK VALVE**

Screwed cap, Swing type disc,  
Designed to MSS SP-80 type 3,  
Threaded ends to NPT

W.O.G. non-shock 4.14 MPa (600 psi), Saturated steam pressure 2.07 MPa (300 psi)



**Fig. AK300YR**

• Solder joint end to ASME B1.20.1

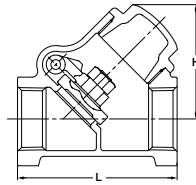

**Materials**

Parts	Material
Body	Cast Bronze
Cap	Cast Bronze
Hinge pin	Copper
Disc	Cast Bronze

⚠ Do not use for flammable gas or toxic gas.

**Dimensions**

Nominal Size	inch	1/2	3/4	1	1 1/4	1 1/2	2	mm
	mm	15	20	25	32	40	50	
L		60	72	84	99	113	131	
H		42	51	61	74	83	98	

**PN16**

**BRASS GATE VALVE AS 1628**

Screwed bonnet, Non-rising stem,  
Designed to AS 1628-2001,  
Threaded ends to AS 1722.1

Working temperature and pressure, non-shock 99°C /1.6 MPa



**Fig. AS-FH**

• Australian Standard AS 1628 Lic. No. WMKA02054

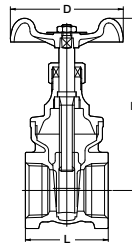

**Materials**

Parts	Material	AS Designation
Body	Dezincification Resistance Brass	AS 2345
Bonnet	Dezincification Resistance Brass	AS 2345
Stem	Dezincification Resistance Brass	AS 2345
Disc	Dezincification Resistance Brass	AS 2345
Gland packing	Aramid Fibers Graphite	Asbestos Free Packing

**Dimensions**

Nominal Size	inch	1/2	3/4	1	1 1/4	1 1/2	2	mm
	mm	15	20	25	32	40	50	
L		55	60	68	78	81	94	
H		74	86	94	116	128	158	
D		55	55	60	70	80	90	



**TYPE 600**

**BRASS BALL VALVE, FULL PORT**

Screwed body cap, Blowout-proof stem, Threaded ends to ASME B1.20.1

W.O.G. non-shock 4.14 MPa (600 psi), Saturated steam pressure 1.03 MPa (150 psi)

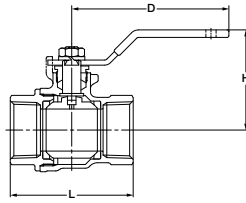

**Materials**

Parts	Material
Body	Forged Brass
Body cap	Forged Brass
Stem	Dezincification Resistant Brass
Ball	Forged Brass (SiNi plated)
Ball seat	PTFE
Gland packing	PTFE

Fig. AKTAF

• Threaded end to ASME B1.20.1



**Dimensions**

Nominal Size	inch	1/4	3/8	1/2	3/4	1	1 1/4	1 1/2	mm
	mm	8	10	15	20	25	32	40	50
L		41	42	53	60	72	82	92	105
H		39	39	42	51	59	64	73	80
D		82	82	82	100	130	130	150	150

**TYPE 600**

**BRASS BALL VALVE, FULL PORT**

Screwed body cap, Blowout-proof stem, Solder joint ends to ASME B16.18

W.O.G. non-shock 4.14 MPa (600 psi), Saturated steam pressure 1.03 MPa (150 psi)

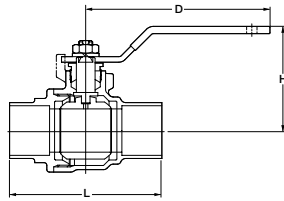

**Materials**

Parts	Material
Body	Forged Brass / Cast Bronze*
Body cap	Forged Brass / Cast Bronze*
Stem	Dezincification Resistant Brass
Ball	Forged Brass (SiNi plated) / Stainless Steel*
Ball seat	PTFE
Gland packing	PTFE

\*Size 2 1/2 & 3

⚠ Solder joint end valves should not be used in service where the temperature of the line fluid is higher than the softening point of the solder.

Fig. CTAF

• Solder joint end to ASME B16.18



**Dimensions**

Nominal Size	inch	3/8	1/2	3/4	1	1 1/4	1 1/2	2	2 1/2	3	mm
	mm	10	15	20	25	32	40	50	65	80	
L		46	54	73	88	100	115	140	163	187	
H		39	42	51	59	64	73	80	108	122	
D		82	82	100	130	130	150	150	200	300	

**TYPE 600**

**BRASS BALL VALVE, FULL PORT**

Screwed body cap, Blowout-proof stem, Double O-ring stem seals, Threaded ends to NPT or solder joint ends

W.O.G. non-shock 4.14 MPa (600 psi), Saturated steam pressure 1.03 MPa (150 psi)  
Maximum pressure temperature limitation: 150 psi at 300°F

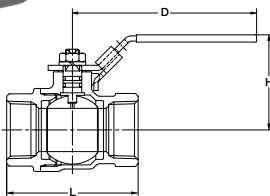

**Materials**

Parts	Material
Body	Forged Brass
Body cap	Forged Brass
Stem	Dezincification Resistant Brass
Ball	Forged Brass: Cr plated
Ball seat	PTFE
O-ring	NBR, FKM: CTFLL only

⚠ Solder joint end valves should not be used in service where the temperature of the line fluid is higher than the softening point of the solder.

Fig. AKTFLL

• Threaded end to ASME B1.20.1

Fig. CTFLL

• Solder joint end to ASME B16.18



\*AKTFLL only \*\*CTFLL only

**Dimensions**

Nominal Size	inch	1/4	3/8	1/2	3/4	1	1 1/4	1 1/2	mm
	mm	8	10	15	20	25	32	40	50
L		41	42	53	60	72	82	92	105
L1 Solder				54	73	88	100	115	140
H		35	35	39	47	55	59	67	75
D		82	82	82	100	130	130	150	150

**TYPE 600**

**BRASS BALL VALVE, FULL PORT**

Stainless steel trim, Screwed body cap, Blowout-proof stem, Threaded ends to NPT or solder joint ends

W.O.G. non-shock 4.14 MPa (600 psi), Saturated steam pressure 1.03 MPa (150 psi)

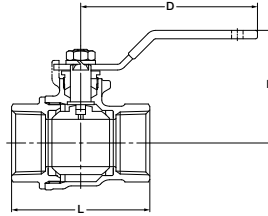

Fig. AKTAFM

- Threaded end to ASME B1.20.1

Fig. CTAFM

- Solder joint end to ASME B16.18

Approvals (up to 2)



Materials

Parts	Material
Body	Forged Brass
Body cap	Forged Brass
Stem	Stainless Steel (Type 316)
Ball	Stainless Steel (Type 316 or Gr. CF8M)
Ball seat	PTFE
Gland packing	PTFE

Dimensions

Nominal Size	mm									
	inch	1/4	3/8	1/2	3/4	1	1 1/4	1 1/2	2	2
L	41	42	53	60	72	82	92	105	115	140
L1 Solder			46	54	73	88	100	115	140	
H	39	39	42	51	59	64	73	80		
D	82	82	82	100	130	130	150	150		

**TYPE 600**

**BRASS BALL VALVE, FULL PORT**

Mounting pad, Screwed body cap, Blowout-proof stem, Threaded ends to ASME B1.20.1

W.O.G. non-shock 4.14 MPa (600 psi), Saturated steam pressure 1.03 MPa (150 psi)

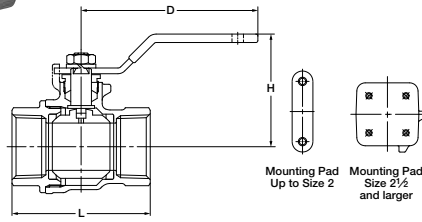

Fig. AKTAFP

- Threaded end to ASME B1.20.1

Approvals (up to 2)



Materials

Parts	Material
Body	Forged Brass / Cast Bronze*
Body cap	Forged Brass / Cast Bronze*
Stem	Dezincification Resistant Brass
Ball	Forged Brass: Cr plated
Ball seat	PTFE
Gland packing	PTFE

\*Size 2 1/2 and larger

Dimensions

Nominal Size	mm											
	inch	1/4	3/8	1/2	3/4	1	1 1/4	1 1/2	2	2 1/2	3	4
L	41	42	53	60	72	82	92	105	135	156	192	
H	39	39	42	51	59	64	73	80	108	122	140	
D	82	82	82	100	130	130	150	150	200	300	300	

**TYPE 600**

**BRASS BALL VALVE, FULL PORT**

250 WSP steam trim, Mounting pad, Screwed body cap, Blowout-proof stem, Threaded ends to ASME B1.20.1

W.O.G. non-shock 4.14 MPa (600 psi), Saturated steam pressure 1.72 MPa (250 psi)

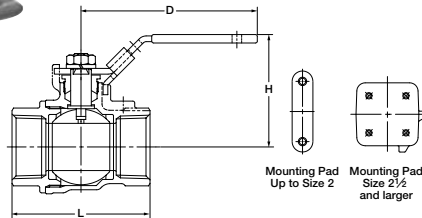

Fig. AKTAFPM

- Threaded end to ASME B1.20.1

Approvals (up to 2)



Materials

Parts	Material
Body	Forged Brass / Cast Bronze*
Body cap	Forged Brass / Cast Bronze*
Stem	Stainless Steel (Type 316)
Ball	Stainless Steel (Type 316 or Gr. CF8M)
Ball seat	Reinforced PTFE
Gland packing	Reinforced PTFE

\*Size 2 1/2 and larger

Dimensions

Nominal Size	mm											
	inch	1/4	3/8	1/2	3/4	1	1 1/4	1 1/2	2	2 1/2	3	4
L	41	42	53	60	72	82	92	105	135	156	192	
H	39	39	42	51	59	64	73	80	108	122	140	
D	82	82	82	100	130	130	150	150	200	300	300	

**TYPE 600**

**BRASS BALL VALVE, FULL PORT**

Threaded end 3/4 hose connection with cap & chain, Blowout-proof stem, Threaded/Hose connection (ASME B1.20.1/ASME B1.20.7 3/4 11.5NHR)

W.O.G. non-shock 4.14 MPa (600 psi), Saturated steam pressure 1.03 MPa (150 psi)

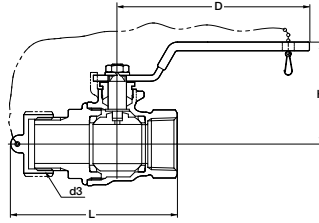

**Fig. AKTAFc**

• Threaded end to ASME B1.20.1

**Fig. CTAFc**

• Solder joint end to ASME B16.18



**Materials**

Parts	Material
Body	Forged Brass
Body cap	Brass Rod* / Forged Brass
Stem	Dezincification Resistant Brass
Ball	Forged Brass: Cr plated
Ball seat	PTFE
Gland packing	PTFE

\*Size 1/2 only



Solder joint end valves should not be used in service where the temperature of the line fluid is higher than the softening point of the solder.

**Dimensions**

Nominal Size	inch		mm	
	1/2	3/4	15	20
L	74	84	74	84
L1 Solder	75	90	75	90
H	42	51	42	51
D	82	100	82	100
d3	3/4-11.5 NHR		3/4-11.5 NHR	

**TYPE 600**

**BRASS BALL VALVE, FULL PORT**

Screwed body cap, Blowout-proof stem, Male & female threaded ends to ASME B1.20.1

W.O.G. non-shock 4.14 MPa (600 psi), Saturated steam pressure 1.03 MPa (150 psi)



**Fig. AKTAFO**

• Threaded end to ASME B1.20.1

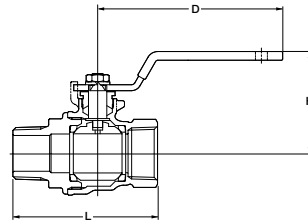

**Materials**

Parts	Material
Body	Forged Brass
Body cap	Brass Rod* / Forged Brass
Stem	Dezincification Resistant Brass
Ball	Forged Brass: Cr plated
Ball seat	PTFE
Gland packing	PTFE

\*Size 1/4 and 3/8

**Dimensions**

Nominal Size	inch		mm			
	1/4	3/8	1/2	3/4	1	
L	52	53	66	73	88	
H	39	39	42	51	59	
D	82	82	82	100	130	

**TYPE 600**

**BRASS BALL VALVE, FULL PORT**

Single union, Screwed body cap, Blowout-proof stem, Threaded ends to ASME B1.20.1

W.O.G. non-shock 4.14 MPa (600 psi), Saturated steam pressure 1.03 MPa (150 psi)



**Fig. AKTAFU**

• Threaded end to ASME B1.20.1

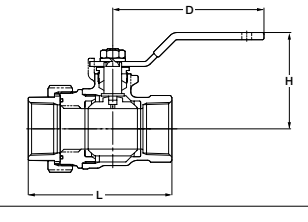

**Materials**

Parts	Material
Body	Forged Brass
Body cap	Forged Brass
Stem	Dezincification Resistant Brass
Ball	Forged Brass: Cr plated
Ball seat	PTFE
Gland packing	PTFE

**Dimensions**

Nominal Size	inch		mm						
	1/4	3/8	1/2	3/4	1	1 1/4	1 1/2	2	
L	52	52	63	75	88	98	113	126	
H	39	39	42	51	59	64	73	80	
D	82	82	82	100	130	130	150	150	

**TYPE 200**

**BRASS BALL VALVE, FULL PORT**

Safety exhaust, Screwed body cap, Blowout-proof stem, Latch lock handle, Threaded ends to ASME B1.20.1

W.O.G. non-shock 1.38 MPa (200 psi), -18°C to + 93°C (not freezing)



※ This photo shows 3/4 inch.

**Fig. AKTAFS**

• Threaded end to ASME B1.20.1

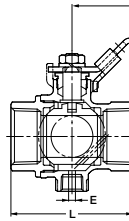

**Materials**

Parts	Material
Body	Forged Brass
Body cap	Forged Brass
Stem	Dezincification Resistant Brass
Ball	Forged Brass: Cr plated
Ball seat	PTFE
Gland packing	PTFE

**Dimensions**

Nominal Size	mm								
	inch	1/4	3/8	1/2	3/4	1	1 1/4	1 1/2	2
L	41	42	53	60	72	82	92	105	105
H	39	39	42	51	59	64	73	80	80
E	4	4	4	4	4	4	4	4	4
D	82	82	82	100	130	130	150	150	150

• Exhaust hole diameter: 4 mm (all nominal size)



## TYPE 400 BRASS BALL VALVE

Screwed body cap, Blowout-proof stem, Double O-ring stem seals, Threaded ends to BS21 or NPT

W.O.G. non-shock 2.76 MPa (400 psi), W.O.G. 150°C 0.69 MPa (100 psi)



Fig. T\*

- Threaded end to BS21

Fig. AKT

- Threaded end to ASME B1.20.1

Fig. TT\*

- Threaded end to BS21

\*Taper pipe threads for connection shall refer to JIS B0203 standards, while the length of useful threads and the positions of gauge planes are built on KITZ standard. (size 1/4 & larger)

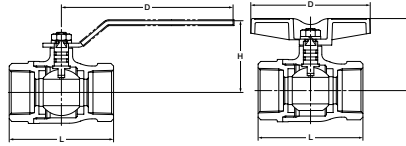

### Materials

Parts	Material
Body	Forged Brass / Cast Bronze*
Body cap	Forged Brass / Cast Bronze*
Stem	Dezincification Resistant Brass
Ball	Forged Brass** / Stainless Steel***
Ball seat	PTFE
O-ring	FKM

\*Size 4 only  
\*\*Nickel-chrome plated  
\*\*\*Size 1 1/2, 2, 3, 4

### Dimensions

Nominal Size	mm											
	inch	1/4	3/8	1/2	3/4	1	1 1/4	1 1/2	2	2 1/2	3	4
L		50	50	65	68	79	86	96	109	127	153	179
H		39	39	39	42	46	51	56	65	85	105	126
H1		34	34	37	40	46	52	57	71			
D		60	60	80	80	110	110	110	140	200	300	400
D1		65	65	80	80	90	105	105	120			

\*TT: 1/4 to 2

## TYPE 400 BRASS BALL VALVE

Screwed body cap, Blowout-proof stem, Double O-ring stem seals, Male & female threaded ends to BS21

W.O.G. non-shock 2.76 MPa (400 psi), W.O.G. 150°C 0.69 MPa (100 psi)



Fig. TO

- Threaded end to BS21

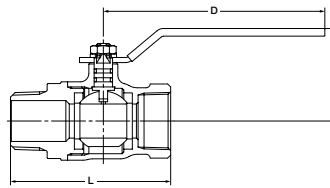

### Materials

Parts	Material
Body	Forged Brass
Body cap	Forged Brass
Stem	Dezincification Resistant Brass
Ball	Forged Brass*
Ball seat	PTFE
O-ring	FKM

\*Nickel-chrome plated

### Dimensions

Nominal Size	mm					
	inch	1/4	3/8	1/2	3/4	1
L		59	60	74	80	94
H		39	39	39	42	46
D		60	60	80	80	110

## TYPE 400 BRASS BALL VALVE

Bolted body and cap, Blowout-proof stem, Double O-ring stem seals, Threaded ends to BS21

W.O.G. non-shock 2.76 MPa (400 psi), W.O.G. 150°C 0.69 MPa (100 psi)



Fig. TM\*

- Threaded end to BS21

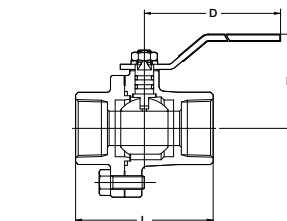

### Materials

Parts	Material
Body	Forged Brass
Body cap	Forged Brass
Stem	Dezincification Resistant Brass
Ball	Forged Brass* / Cast Brass**
Ball seat	PTFE
O-ring	FKM

\*Cr plated  
\*\*Size 2 1/2 and 3

### Dimensions

Nominal Size	mm									
	inch	3/8	1/2	3/4	1	1 1/4	1 1/2	2	2 1/2	3
L		56	60	68	80	86	101	117	136	160
H		45	45	49	55	60	65	75	91	105
D		60	80	80	110	110	110	140	200	300

\*Taper pipe threads for connection shall refer to JIS B0203 standards, while the length of useful threads and the positions of gauge planes are built on KITZ standard. (size 1/4, 2 & larger)

## TYPE 600 BRASS BALL VALVE

One-piece body, Blowout-proof stem, Threaded ends to BS21 or NPT

W.O.G. non-shock 4.14 MPa (600 psi), W.O.G. 150°C 1.03 MPa (150 psi)



**Fig. TK**

• Threaded end to BS21

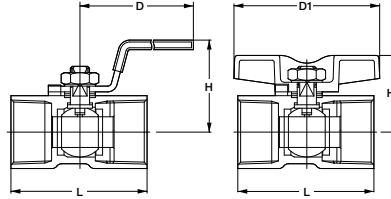

**Fig. TKT**

• Threaded end to BS21

**Fig. AKTK**

• Threaded end to ASME B1.20.1  
• AKTK 1/4 to 2



**Materials**

Parts	Material
Body	Forged Brass
Body cap	Brass
Stem	Dezincification Resistant Brass
Ball	Forged Brass*
Ball seat	G/F PTFE
Grand packing	G/F PTFE

\*Cr plated

**Dimensions**

Nominal Size	inch	1/8	1/4	3/8	1/2	3/4	1	1 1/4	1 1/2	2	mm
L		32	39	44	56.5	59	71	78	83	100	
H		31	31	36	41	44	48	54	65	72	
H1		23	23	27	31	34	42	48	53	60	
D		60	60	70	85	85	100	100	125	125	
D1		35	35	40	60	60	76	76	100	100	

## TYPE 600 BRASS BALL VALVE

One-piece body, Blowout-proof stem, with wing handle, Threaded ends to BS21

W.O.G. non-shock 4.14 MPa (600 psi), W.O.G. 150°C 1.03 MPa (150 psi)



**Fig. TKW**

• Threaded end to BS21

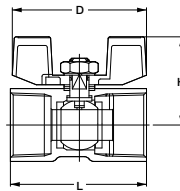

**Materials**

Parts	Material
Body	Forged Brass
Body cap	Brass
Stem	Dezincification Resistant Brass
Ball	Forged Brass*
Ball seat	G/F PTFE
Grand packing	G/F PTFE

\*Cr plated

**Dimensions**

Nominal Size	inch	1/8	1/4	3/8	1/2	3/4	1	mm
L		32	39	44	56.5	59	71	
H		25	25	29	35	39	41	
D		35	35	40	55	55	69	

## TYPE 150 BRASS BALL VALVE, FULL PORT

Locking device, Screwed body cap, Blowout-proof Stem, Double O-ring stem seals, Threaded ends to BS21

W.O.G. non-shock 1.03 MPa (150 psi), W.O.G. 150°C 0.69 MPa (100 psi)



**Fig. TFJ**

• Threaded end to BS21

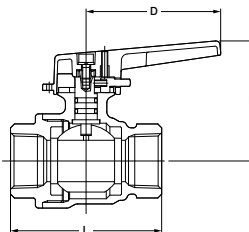

**Materials**

Parts	Material
Body	Forged Brass / Cast Bronze*
Body cap	Forged Brass / Cast Bronze*
Stem	Dezincification Resistant Brass
Ball	Forged Brass** / Cast Bronze***
Ball seat	PTFE
O-ring	FKM

\*Size 2 only

\*\*Nickel-chrome plated

\*\*\*Size 2

**Dimensions**

Nominal Size	inch	1/2	3/4	1	1 1/4	1 1/2	2	mm
L		62	73	85	98	108	124	
H		53	58	67	72	90	98.5	
D		65	65	90	90	110	110	

**TYPE 400**

**BRONZE BALL VALVE**

Screwed body cap, Blowout-proof stem, Double O-ring stem seals

TL W.O.G. non-shock 2.76 MPa (400 psi), W.O.G. 150°C 0.69 MPa (100 psi),  
TLT W.O.G. non-shock 2.76 MPa (400 psi), W.O.G. 80°C 1.96 MPa (286 psi)

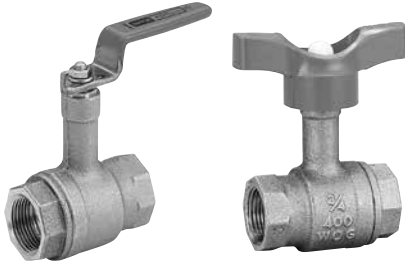
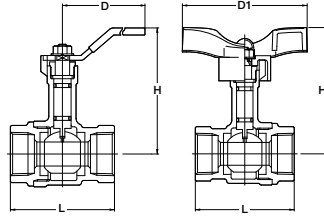

**Fig. TL**

• Threaded end to BS21

**Fig. TLT**

• Threaded end to BS21



**Materials**

Parts	Material
Body	Cast Bronze
Body cap	Cast Bronze
Stem	Dezincification Resistant Brass
Ball	Stainless Steel (Type 304)
Ball seat	PTFE
O-ring	FKM

**Dimensions**

Nominal Size	inch	1/2	3/4	1	1 1/4	1 1/2	2	mm
	mm	15	20	25	32	40	50	
L		56	65	78	86	96	109	
L1 Solder		58	73	88	99	114	135	
H		75	79	83	98	102	109	
H1		79	83	90	105	109	124	
D		80	80	110	110	110	140	
D1		82	82	94	94	94	120	

**10K**

**BRONZE BALL VALVE**

Bolted body cap, Full bore, Fringed ends to JIS B2240 10K

W.O.G. non-shock 1.4 MPa (14 kgf/cm<sup>2</sup>), W.O.G. 150°C 0.69 MPa (7 kgf/cm<sup>2</sup>)



**Fig. TB**

• Flanged ends to JIS 10K

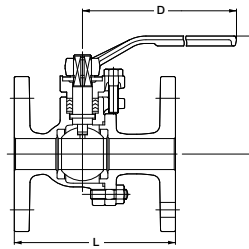

**Materials**

Parts	Material
Body	Cast Bronze
Body cap	Cast Bronze
Stem	Dezincification Resistant Brass
Ball	Forged Brass**/ Stainless Steel*
Ball seat	PTFE
Grand packing	PTFE

\*Size 2 and larger  
\*\*Cr plated

**Dimensions**

Nominal Size	inch	1/2	3/4	1	1 1/4	1 1/2	2	2 1/2	3	4	mm
	mm	15	20	25	32	40	50	65	80	100	
L		110	120	130	140	165	180	190	200	230	
H		85	88	95	98	115	121	152	161	190	
D		130	130	160	160	230	230	400	400	460	

**TYPE 600**

**BRASS BALL VALVE, FULL PORT**

Three piece body with mounting pad, Threaded end to ASME B1.20.1

W.O.G. non-shock 2.76 MPa (600 psi), W.O.G. 150°C 1.03 MPa (150 psi)



**Fig. AK3TM**

• Threaded end to ASME B1.20.1

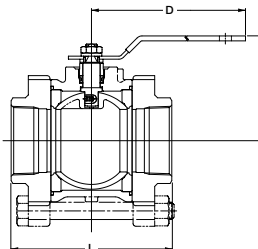

**Materials**

Parts	Material
Body	Forged Brass
Body cap	Forged Brass
Stem	Dezincification Resistant Brass
Ball	Forged Brass (SiNi plated)
Ball seat	PTFE
Grand packing	PTFE

**Dimensions**

Nominal Size	inch	1/4	3/8	1/2	3/4	1	1 1/4	1 1/2	2	mm
	mm	8	10	15	20	25	32	40	50	
L		49	49	61	70	83	99	117	139	
H		39	39	48	55	63	69	78	85	
D		82	82	82	100	130	130	150	150	

**TYPE 600**

**BRASS BALL VALVE, FULL PORT**

Screwed body cap, Blowout-proof stem, Double O-ring stem seals, Male & female threaded ends to BS21

W.O.G. non-shock 4.14 MPa (600 psi), W.O.G. 150°C 1.03 MPa (150 psi)

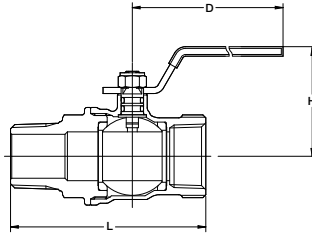

**Materials**

Parts	Material
Body	Forged Brass
Body cap	Forged Brass
Stem	Brass: Nickel plated
Ball	Forged Brass*
Ball seat	PTFE
O-ring	FKM

\*Chrome plated or Nickel-chrome plated

**Fig. ZO**  
• Threaded end to BS21

**Dimensions**

Nominal Size	inch	1/4	3/8	1/2	3/4	1	mm
	mm	8	10	15	20	25	
L		59	60	74	80	94	
H		37	37	40	44	50	
D		70	70	80	80	110	

**TYPE 400**

**BRASS BALL VALVE**

Screwed body cap, Blowout-proof stem, Threaded ends to BS21

W.O.G. non-shock 2.76 MPa (400 psi), W.O.G. 150°C 0.69 MPa (100 psi), Saturated steam pressure 0.98 MPa (142 psi)

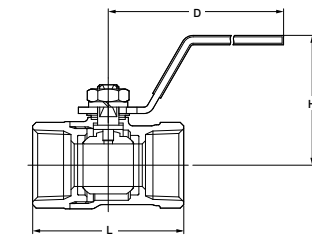

**Materials**

Parts	Material
Body	Forged Brass
Body cap	Forged Brass
Stem	Dezincification Resistant Brass
Ball	Forged Brass* / Stainless Steel**
Ball seat	PTFE
Grand packing	G/F PTFE

\*Cr plated  
\*\*Size 1 1/2

**Fig. ZS\***  
• Threaded end to BS21

\*Taper pipe threads for connection shall refer to JIS B0203 standards, while the length of useful threads and the positions of gauge planes are built on KITZ standard. (size 1 1/4 & larger)

**Dimensions**

Nominal Size	inch	1/4	3/8	1/2	3/4	1	1 1/4	1 1/2	2	mm
	mm	8	10	15	20	25	32	40	50	
L		42	43	51	59	71	78	88	99	
H		42	42	44	48	61	65	71	76	
D		72	72	87	87	116	116	117	117	

**TYPE 600**

**BRASS BALL VALVE, FULL PORT**

Screwed body cap, Blowout-proof stem, Double O-ring stem seals, Threaded ends to BS21

W.O.G. non-shock 4.14 MPa (600 psi), W.O.G. 150°C 1.03 MPa (150 psi)

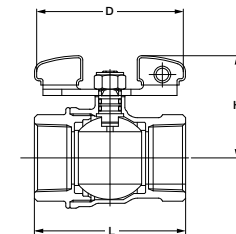

**Materials**

Parts	Material
Body	Forged Brass
Body cap	Forged Brass
Stem	Brass: Nickel plated
Ball	Forged Brass* / Stainless Steel**
Ball seat	PTFE
O-ring	FKM

\*Nickel-chrome plated  
\*\*Size 1 1/4 and larger

**Fig. ZET**  
• Threaded end to BS21

**Dimensions**

Nominal Size	inch	1/4	3/8	1/2	3/4	1	1 1/4	1 1/2	2	mm
	mm	8	10	15	20	25	32	40	50	
L		42	42	53	60	72	84	92	110	
H		34	34	40	44	54	59	75	82	
D		55	55	70	70	100	100	130	130	



**TYPE 600**

**BRASS BALL VALVE, FULL PORT**

Bolted body and cap, Blowout-proof stem, Double O-ring stem seals, Threaded ends to ASME B1.20.1 or solder joint ends

W.O.G. non-shock 4.14 MPa (600 psi)\*, W.O.G. 150°C 1.03 MPa (150 psi)

\*Size 4: W.O.G. non-shock 2.76 MPa (400 psi), W.O.G. 150°C 0.69 MPa (100 psi)



Fig. AKSZA

Fig. CSZA

• Threaded end to ASME B1.20.1 • Solder joint to ASMB 16.18



\*AKSZA only

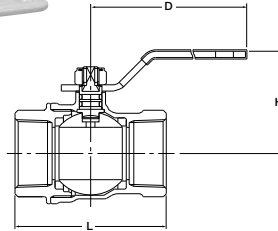

**Materials**

Parts	Material
Body	Forged Brass / Cast Bronze*
Body cap	Forged Brass / Cast Bronze*
Stem	Brass: Nickel plated
Ball	Forged Brass: SiNi plated (Size 1/4 to 4) Stainless Steel**
Ball seat	PTFE
O-ring	FKM

\*Size 4 only \*\*Size 3 only

⚠ Solder joint end valves should not be used in service where the temperature of the line fluid is higher than the softening point of the solder.

**Dimensions**

Nominal Size	mm													
	inch	1/4	3/8	1/2	3/4	1	1 1/4	1 1/2	2	2 1/2	3	4		
L	8	10	15	20	25	32	40	50	65	80	100	138	167	193
L1 Solder		46	54	73	88	100	115	140	164	187				
H	37	37	40	43	50	55	65	72	100	112	131			
D	70	70	80	80	110	110	150	150	200	300	300			

**TYPE 600**

**BRASS BALL VALVE, FULL PORT**

Bolted body and cap, Blowout-proof stem, Double O-ring stem seals, Threaded ends to BS21

W.O.G. non-shock 4.14 MPa (600 psi), W.O.G. 150°C 1.03 MPa (150 psi)

\*Size 4: W.O.G. non-shock 2.76 MPa (400 psi), W.O.G. 150°C 0.69 MPa (100 psi)



Fig. SZA

• Threaded end to BS21

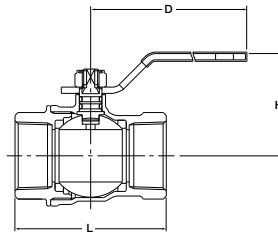

**Materials**

Parts	Material
Body	Forged Brass / Cast Bronze*
Body cap	Forged Brass / Cast Bronze*
Stem	Brass: Nickel plated
Ball	Forged Brass: NiCr plated (Size 1/4 to 4) Stainless Steel**
Ball seat	PTFE
O-ring	FKM

\*Size 4 only \*\*Size 3 only

**Dimensions**

Nominal Size	mm													
	inch	1/4	3/8	1/2	3/4	1	1 1/4	1 1/2	2	2 1/2	3	4		
L	8	10	15	20	25	32	40	50	65	80	100	138	167	193
H	37	37	40	43	50	55	65	72	101	113	131			
D	70	70	80	80	110	110	150	150	200	300	300			

**TYPE 600**

**BRASS BALL VALVE, FULL PORT**

Bolted body and cap, Blowout-proof stem, Double O-ring stem seals, Threaded ends to ASME B1.20.1 or solder joint ends

W.O.G. non-shock 4.14 MPa (600 psi), W.O.G. 150°C 1.03 MPa (150 psi)



Fig. AKSZAW

Fig. CSZAW

• Threaded end to ASME B1.20.1 • Solder joint to ASME B16.18



\*AKSZAW only

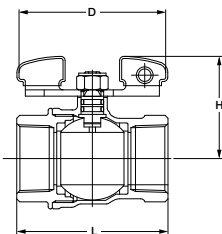

**Materials**

Parts	Material
Body	Forged Brass
Body cap	Forged Brass
Stem	Brass: Nickel plated
Ball	Forged Brass: SiNi plated
Ball seat	PTFE
O-ring	FKM

⚠ Solder joint end valves should not be used in service where the temperature of the line fluid is higher than the softening point of the solder.

**Dimensions**

Nominal Size	mm							
	inch	1/4	3/8	1/2	3/4	1	1 1/4	1 1/2
L	8	10	15	20	25	32	40	50
L1 Solder		46	54	73	88	100	115	140
H	35	35	41	45	54	59	75	82
D	55	55	70	70	100	100	130	130

# TYPE 400 3-WAY BRASS BALL VALVE

Screwed body cap, 2-seat, L-port design, Blowout-proof stem, Double O-ring stem seals\*, Threaded ends to BS21 or NPT

W.O.G. non-shock 2.76 MPa (400 psi), W.O.G. 150°C 0.69 MPa (100 psi)

\*Size 1/2 and larger



Fig. TN\*

• Threaded end to BS21

Fig. AKTN

• Threaded end to ASME B1.20.1

\*Taper pipe threads for connection shall refer to JIS B0203 standards, while the length of useful threads and the positions of gauge planes are built on KITZ standard. (size 1/4 & larger)

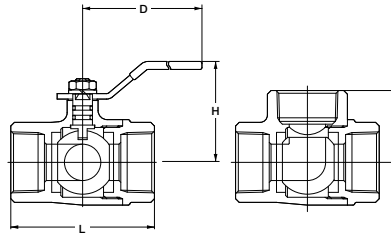

### Materials

Parts	Material
Body	Forged Brass / Cast Bronze**
Body cap	Forged Brass
Stem	Dezincification Resistant Brass
Ball	Forged Brass***
Ball seat	PTFE
O-ring	FKM

\*\*Size 2 1/2 and 3 \*\*\*Cr plated

### Dimensions

Nominal Size	inch	1/4	3/8	1/2	3/4	1	1 1/4	1 1/2	2	2 1/2	3
	mm	8	10	15	20	25	32	40	50	65	80
L	40	46	67	68	79	89	100	115	138	166	
L1	20	23	33.5	34	39.5	44.5	50	57.5	69	83	
H	30	35	44	49	55	59	64	74	91	104	
D	60	70	80	80	110	110	110	140	200	300	

Port position fig: Position 1 & 2

# TYPE 400 3-WAY BRONZE BALL VALVE

Screwed body cap, 4-seat, L or T-port design, Blowout-proof stem, Double O-ring stem seals, Threaded ends to BS21 or NPT

W.O.G. non-shock 2.76 MPa (400 psi), W.O.G. 150°C 0.69 MPa (100 psi)

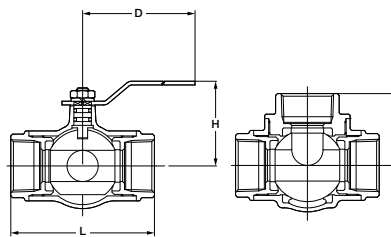

Fig. T4T

• Threaded end to BS21

Fig. T4L

• Threaded end to BS21



### Materials

Parts	Material
Body	Cast Bronze
Body cap	Forged Brass
Stem	Dezincification Resistant Brass
Ball	Forged Brass*
Ball seat	PTFE
O-ring	FKM

\*Cr plated

### Dimensions

Nominal Size	inch	1/2	3/4	1	1 1/4	1 1/2	2
	mm	15	20	25	32	40	50
L	70	85	100	115	130	150	
L1	35	42.5	50	57.5	65	75	
H	52	56	63	68	94.5	102	
D	130	130	150	150	230	230	

T4T/AKT4T: Port position fig: Position 1, 2, 3 & 4 T4L: Port position fig: Position 1 & 2

# TYPE 400 3-WAY BRASS BALL VALVE with MOUNTING PAD

Screwed body cap, 2-seat, L-port design, Blowout-proof stem, Double O-ring stem seals, Threaded ends to BS21 or NPT

W.O.G. non-shock 2.76 MPa (400 psi), W.O.G. 150°C 0.69 MPa (100 psi)



Fig. AKTNP

• Threaded end to ASME B1.20.1

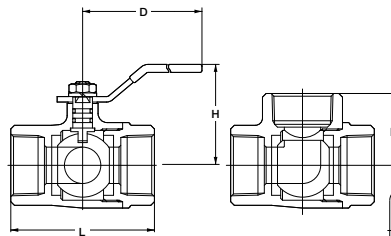

### Materials

Parts	Material
Body	Forged Brass
Body cap	Forged Brass
Stem	Dezincification Resistant Brass
Ball	Forged Brass*
Ball seat	PTFE
O-ring	FKM

\*Cr plated

⚠ Solder joint end valves should not be used in service where the temperature of the line fluid is higher than the softening point of the solder.

Mounting Pad

### Dimensions (AKTNP)

Nominal Size	inch	1/2	3/4	1	1 1/4	1 1/2	2
	mm	15	20	25	32	40	50
L	67	68	79	89	100	115	
L1	33.5	34	40	44.5	50	57.5	
H	45	48	55	60	65	75	
D	80	80	110	110	130	140	

Port position fig: Position 1 & 2

# ALLOWABLE PORT ORIENTATION

Valve Design	Form	Fluid Passage	
3-Way 2-Seat L-port ball valve	<p>Top View</p> <p>Form 1      Form 2</p>	<p>1 Flow in Form 1 is between Ports "A" and "C". Flow in Form 2 is between Ports "B" and "C". The flow paths in Form 1 and Form 2 can be exchanged.</p> <p>2 When the fluid pressure <math>P_2</math> in the closed path is higher than <math>P_1</math> in the open path, slight fluid leakage may occur to <math>P_1</math> through the ball seat of the closed path.</p>	
	3-Way 4-Seat L-port ball valve	<p>Top View</p> <p>Form 1      Form 2</p>	<p>1 Flow in Form 1 is between Ports "A" and "C". Flow in Form 2 is between Ports "B" and "C". The flow paths in Form 1 and Form 2 can be exchanged.</p> <p>2 When the fluid pressure <math>P_2</math> in the closed path is higher than <math>P_1</math> in the open path, slight fluid leakage may occur to <math>P_1</math> through the ball seat of the closed path.</p>
3-Way 2-Seat T-port ball valve		<p>Top View</p> <p>Form 1      Form 2</p>	<p>1 In Form 1, all ports are open. Flow in Form 2 is between Ports "B" and "C". Flow in Form 4 is between Ports "A" and "C". Flow can be switched from Form 1 to Form 2, (standard operation pattern) or from Form 1 to Form 4 in either direction. The stopper is assembled for the standard operation pattern.</p> <p>2 When the fluid pressure <math>P_2</math> in the closed path is higher than <math>P_1</math> in the open path, slight fluid leakage may occur to <math>P_1</math> through the ball seat of the closed path.</p> <p>■ Available operation patterns</p> <ul style="list-style-type: none"> <li>• Pattern 1: From Form 1 to Form 4</li> <li>• Pattern 2: From Form 1 to Form 2 (Standard)</li> </ul> <p>Please select one of the above operation patterns at the time of order.</p>
	<p>Top View</p> <p>Form 3 Not Available      Form 4</p>		
	3-Way 4-Seat T-port ball valve	<p>Top View</p> <p>Form 1      Form 2</p>	
		<p>Top View</p> <p>Form 3      Form 4</p>	

10K

**BRASS BALL VALVE,  
DESIGNED FOR GAS SERVICE**

Screwed body cap,  
Blowout-proof stem, Double O-ring stem seals,  
Threaded ends to BS21

Gas service 40°C 0.98 MPa (142 psi)

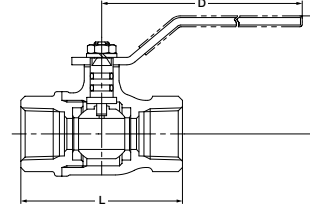

**Materials**

Parts	Material
Body	Forged Brass
Body cap	Forged Brass
Stem	Dezincification Resistant Brass
Ball	Forged Brass* / Stainless Steel**
Ball seat	PTFE
O-ring	NBR

\*Nickel-chrome plated  
\*\*Size 1½, 2

**Dimensions**

Nominal Size	inch	1/4	3/8	1/2	3/4	1	1¼	1½	2	2½	3	mm
	mm	8	10	15	20	25	32	40	50	65	80	
L		50	50	65	68	79	86	96	109	127	153	
H		39	39	39	42	46	51	56	65	85	105	
D		60	60	80	80	110	110	110	140	200	300	

Fig. TG



**CLASS 200**

**FANCOIL VALVES, BRONZE, FLOW CONTROL, GLOBE TYPE**

Female & male threaded ends to BS21

W.O.G. 60°C 1.57 MPa, W.O.G. 120°C 1.37 MPa



**Fig. NSH**

• Flow Control Valves

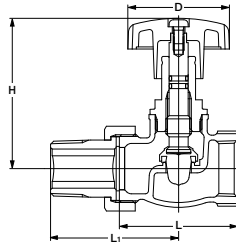

**Materials**

Parts	Material
Body	Cast Bronze
Bonnet	Forged Brass
Stem	Dezincification Resistant Brass
Disc	PTFE
O-ring	FKM

**Dimensions**

Nominal Size	mm			
	inch	1/2	3/4	1
L	15	50.5	54.5	61.5
L1		54.5	59	65.5
H Valve open		77	79	90
D		47.5	47.5	47.5

**CLASS 200**

**FANCOIL VALVES, BRONZE, FLOW CONTROL, ANGLE TYPE**

Indicator Female & male threaded ends to BS21

W.O.G. 60°C 1.57 MPa, W.O.G. 120°C 1.37 MPa



**Fig. INAH**

• Flow Control Valves with Indicators

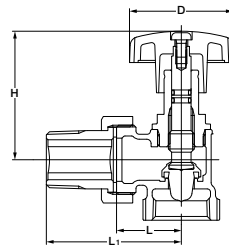

**Materials**

Parts	Material
Body	Cast Bronze
Bonnet	Forged Brass
Stem	Dezincification Resistant Brass
Disc	PTFE
O-ring	FKM

**Dimensions**

Nominal Size	mm				
	inch	1/2	3/4	1	1 1/4
L	15	25.5	28.5	33.5	39.5
L1		55.5	61	69	80
H Valve open		68	68	77	88
D		47.5	47.5	47.5	47.5

**CLASS 200**

**FANCOIL VALVES, BRONZE, FLOW CONTROL, GLOBE TYPE**

Indicator Female & male threaded ends to BS21

W.O.G. 60°C 1.57 MPa, W.O.G. 120°C 1.37 MPa



**Fig. INSH**

• Flow Control Valves with Indicators

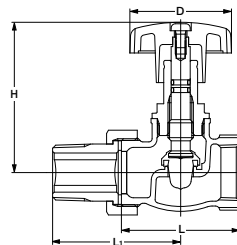

**Materials**

Parts	Material
Body	Cast Bronze
Bonnet	Forged Brass
Stem	Dezincification Resistant Brass
Disc	PTFE
O-ring	FKM

**Dimensions**

Nominal Size	mm				
	inch	1/2	3/4	1	1 1/4
L	15	50.5	54.5	61.5	68.5
L1		54.5	59	65.5	74
H Valve open		77	79	90	96
D		47.5	47.5	47.5	47.5

# FLOW CHARACTERISTICS

※ Indicator readings refer to the flow rates when the pressure loss is 60 kPa.

■ Nominal size: 1/2 Cv=1.8

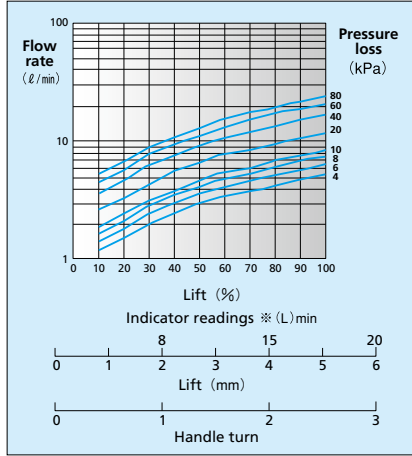

■ Nominal size: 3/4 Cv=2.6

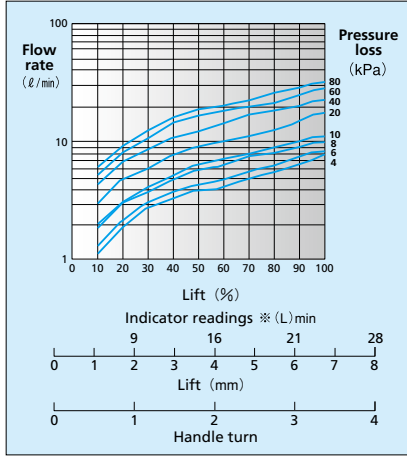

■ Nominal size: 1, 1 1/4 Cv=3.3

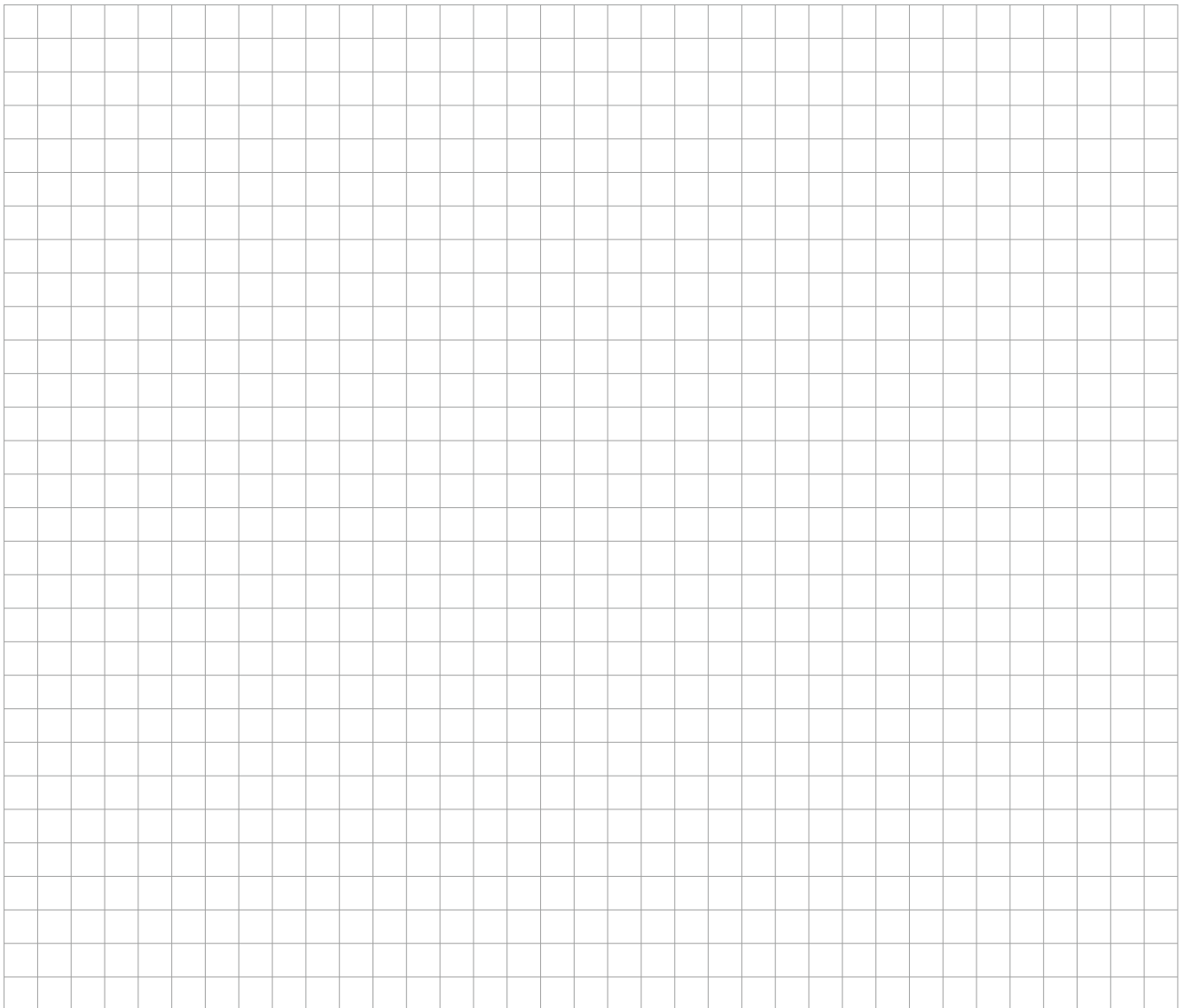
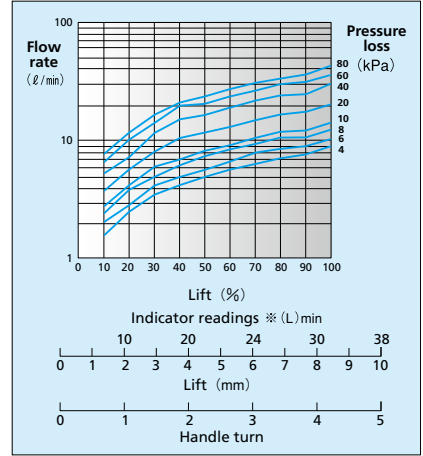

10K

**BRONZE BALL VALVES with DETACHABLE HANDLE FOR FANCOIL UNIT**

Screwed body cap, Blowout-proof stem, Double O-ring stem seals, Threaded ends to BS21

Water 0°C to 90°C 1.0 MPa (not freezing)



Fig. RTRM

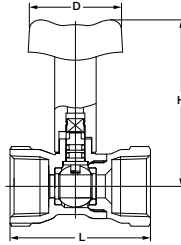

**Materials**

Parts	Material
Body	Cast Bronze
Body cap	Cast Bronze
Stem	Dezincification Resistant Brass
Ball	Forged Brass: Nickel-chrome plated
Ball seat	PTFE
O-ring	EPDM

**Dimensions**

Nominal Size	inch		mm	
	1/2	3/4	1	
	15	20	25	
L	56	61	70.5	
H	72	72	75.5	
D	40	40	40	

10K

**BRONZE BALL VALVES with DETACHABLE HANDLE FOR FANCOIL UNIT**

Screwed body cap, Blowout-proof stem, Double O-ring stem seals, Male (parallel) & female threaded ends to BS21

Water 0°C to 90°C 1.0 MPa (not freezing)



Fig. RTRQ

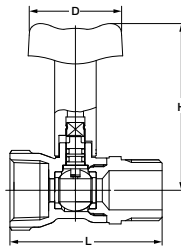

**Materials**

Parts	Material
Body	Cast Bronze
Body cap	Cast Bronze
Stem	Dezincification Resistant Brass
Ball	Forged Brass: Nickel-chrome plated
Ball seat	PTFE
O-ring	EPDM

**Dimensions**

Nominal Size	inch		mm	
	1/2	3/4	1	
	15	20	25	
L	62	66	75.5	
H	72	72	75.5	
D	40	40	40	

10K

**BRONZE BALL VALVES with DETACHABLE HANDLE FOR FANCOIL UNIT**

Screwed body cap, Blowout-proof stem, Double O-ring stem seals, Male & female threaded ends to BS21

Water 0°C to 90°C 1.0 MPa (not freezing)



Fig. RTRR

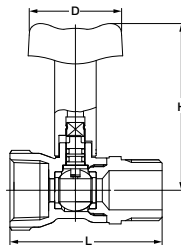

**Materials**

Parts	Material
Body	Cast Bronze
Body cap	Cast Bronze
Stem	Dezincification Resistant Brass
Ball	Forged Brass: Nickel-chrome plated
Ball seat	PTFE
O-ring	EPDM

**Dimensions**

Nominal Size	inch		mm	
	1/2	3/4	1	
	15	20	25	
L	62	66	75.5	
H	72	72	75.5	
D	40	40	40	

10K

**BRONZE BALL VALVES with DETACHABLE HANDLE FOR FANCOIL UNIT**

Screwed body cap, Blowout-proof stem, Double O-ring stem seals, Female & male (union) threaded ends to BS21

Water 0°C to 90°C 1.0 MPa (not freezing)



Fig. RTRU

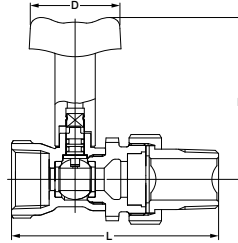

**Materials**

Parts	Material
Body	Cast Bronze
Body cap	Cast Bronze
Stem	Dezincification Resistant Brass
Ball	Forged Brass: Nickel-chrome plated
Ball seat	PTFE
O-ring	EPDM

**Dimensions**

Nominal Size	inch	1/2	3/4	1
	mm	15	20	25
L		88	92.5	104
H		72	72	75.5
D		40	40	40

10K

**BRONZE BALANCING VALVES with BUILT-IN SCREEN**

Constant flow control valve, Female & male (union nipple) threaded ends to BS21

Max working pressure 1.0 MPa, Working temperature water 0°C to 80°C, Control range 0.05 MPa to 0.49 MPa, Flow rate 3 to 30 L/min



Fig. BS

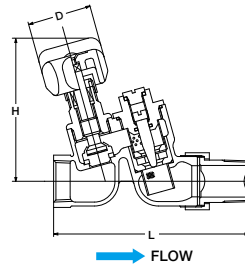

**Materials**

Parts	Material
Body	Cast Bronze
Bonnet	Forged Brass
Cap	Brass
Stem	Dezincification Resistant Brass
Disc	Reinforced PTFE

**Dimensions**

Nominal Size	inch	1/2	3/4
	mm	15	20
L		118.5	121.5
H Valve open		89	89
D		40	40

10K

**BRONZE BALANCING VALVES LOW-NOISE TYPE**

Constant flow control valve, Ball valve type, Female & male (union nipple) threaded ends to BS21

Max working pressure 1.0 MPa, Working temperature water 0°C to 80°C, Control range 0.05 MPa to 0.49 MPa, Flow rate 3 to 40 L/min



Fig. BSS

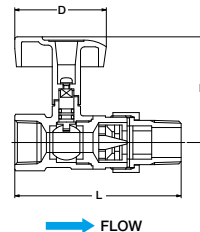

**Materials**

Parts	Material
Body	Cast Bronze
Cap	Cast Bronze
Stem	Dezincification Resistant Brass
Ball	Brass: Chrome plated
Ball seats	PTFE
O-ring	FKM

**Dimensions**

Nominal Size	inch	1/2	3/4	1
	mm	15	20	25
L		94.5	100.5	115.5
H		63.5	63.5	66.5
D		55	55	55



10K

**"SADAMARU"  
CONSTANT FLOW CONTROL**

Ball valve  
Female & male (union nipple) threaded ends to BS21

Max working pressure 1.0 MPa, Working temperature water 0°C to 60°C,  
Control range 0.15 MPa to 0.49 MPa, Flow rate 5 to 30 L/min



Fig. RTUC

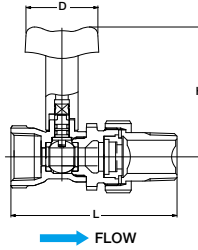

**Materials**

Parts	Material
Body	Cast Bronze
Cap	Cast Bronze
Stem	Dezincification Resistant Brass
Ball	Forged Brass: Nickel-chrome plated
Ball seats	PTFE
O-ring	EPDM

**Dimensions**

Nominal Size	inch	1/2	3/4	1	mm
	mm	15	20	25	
L		88	92.5	104	
H		72	72	75.5	
D		40	40	40	

**Predetermined Flow Rates and Product Coding for  
Balancing Valves and Balancers "SADAMARU"**

● **Predetermined Flow Rate**

Product Code: BS [Controllable flow rate ±10%]

Nominal Size (mm)	3	4	5	6	7.5	8	10	12	12.5	15	16	17.5	20	25	30	(L/min)
15	●	●	●	●	●	●	●	●	●	●	●	●	●	●	●	
20	●	●	●	●	●	●	●	●	●	●	●	●	●	●	●	

Product Code: BSS [Controllable flow rate ±10%]

Nominal Size (mm)	3	4	5	6	7.5	8	10	12	12.5	15	16	17.5	20	25	30	35	40	(L/min)
15	●	●	●	●	●	●	●	●	●	●	●	●	●	●	●			
20	●	●	●	●	●	●	●	●	●	●	●	●	●	●	●			
25	●	●	●	●	●	●	●	●	●	●	●	●	●	●	●	●	●	

Product Code: RTUC [Controllable flow rate ±15%, ±20% (5 L/min only)]

Nominal Size (mm)	5	6	7.5	8	10	12.5	15	17.5	20	25	30	(L/min)
15	●	●	●	●	●	●	●	●				
20	●	●	●	●	●	●	●	●	●	●	●	
25										●	●	

Note: Flow rates marked with ● are available.

**Product Coding**

**BS**  
**BSS**  
**RTUC**



— Predetermined Flow Rate  
— Nominal Size  
— Product Code of Constant Flow Control Valve

Example : RTUC, Nominal size 20, Predetermined flow rate: 10 L/min

**RTUC20-10**

## UTILITY BALL VALVES, STRAIGHT TYPE

Male (parallel) & male threaded ends to BS21

1.0 MPa water, -20°C to +100°C (not freezing)



Fig. S1 -

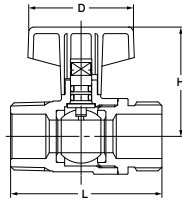

### Materials

Parts	Material
Body	Forged Brass
Stem	Dezincification Resistant Brass
Ball	Forged Brass*
Ball seats	G/F PTFE
O-ring	EPDM

\*SiNi Plated

### Dimensions

Nominal Size	inch	1/2	3/4	mm
	mm	15	20	
L		52.5	58	
H		39	42	
H Add Attachment		52	55	
D		40	40	

## UTILITY BALL VALVES, STRAIGHT TYPE

Nickel-chrome plated body,  
Male (parallel) & male threaded ends to BS21

1.0 MPa water, -20°C to +100°C (not freezing)



Fig. S2 -

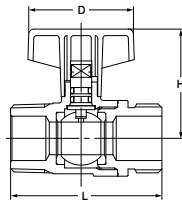

### Materials

Parts	Material
Body	Forged Brass (Nickel-chrome plated)
Stem	Dezincification Resistant Brass
Ball	Forged Brass*
Ball seats	G/F PTFE
O-ring	EPDM

\*SiNi Plated

### Dimensions

Nominal Size	inch	1/2	3/4	mm
	mm	15	20	
L		52.5	58	
H		39	42	
H Add Attachment		52	55	
D		40	40	

## UTILITY BALL VALVES, ANGLE TYPE

Nickel-chrome plated body,  
Male (parallel) & male threaded ends to BS21

1.0 MPa water, -20°C to +100°C (not freezing)



Fig. S5 -

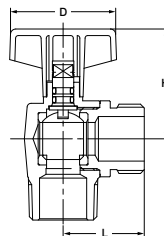

### Materials

Parts	Material
Body	Forged Brass (Nickel-chrome plated)
Stem	Dezincification Resistant Brass
Ball	Forged Brass*
Ball seats	G/F PTFE
O-ring	EPDM

\*SiNi Plated

### Dimensions

Nominal Size	inch	1/2	3/4	mm
	mm	15	20	
L		28.5	31	
H		39	42	
D		40	40	

# UTILITY BALL VALVES, STRAIGHT TYPE

Male & female threaded ends to BS21

1.0 MPa water, -20°C to +100°C (not freezing)

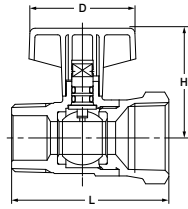

**Materials**

Parts	Material
Body	Forged Brass
Stem	Dezincification Resistant Brass
Ball	Forged Brass*
Ball seats	G/F PTFE
O-ring	EPDM

\*SINi Plated

**Dimensions**

Nominal Size	inch	1/2	3/4	mm
	mm	15	20	
L		52.5	58	
H		39	42	
H Add Attachment		52	55	
D		40	40	

Fig. S6 -



## Design feature of KITZ S Ball Valve: ball valve with a check valve built in its body.

Compact design with a check valve built in the body of the ball valve. Prevention of reverse flow by automatic closing of the spring-loaded built-in check valve (water hammer proof). Quarter-turn operation with detachable handle for easy mounting or maintenance of the valve, and piping insulation. Direct installation of the valves to flexible pipes on the downstream side.

### Cross-sectional illustration of ball valves with built-in check valves

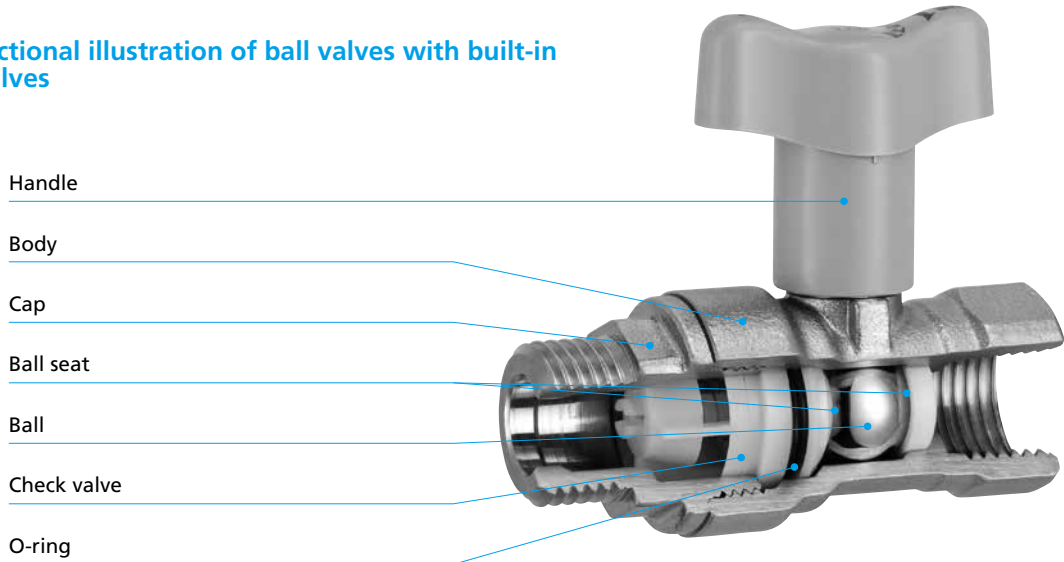

### 2-Way Handle

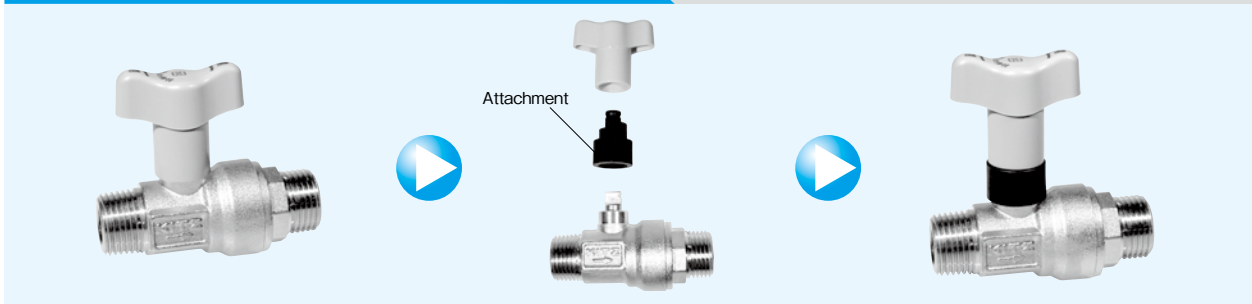

## UTILITY BALL VALVES, STRAIGHT TYPE

Ball valve with built-in check valve, Male (parallel) & male threaded ends to BS21

1.0 MPa water, 0°C to +40°C (not freezing)

Direct flow 40°C max, Reverse flow 80°C max.



Fig. S23N -

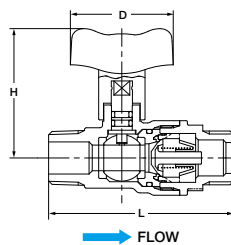

#### Materials

Parts	Material
Body	Forged Brass
Stem	Dezincification Resistant Brass
Ball	Forged Brass*
Ball seats	PTFE
Check valve	Polyacetal + NBR
O-ring	EPDM

\*SiNi Plated

#### Dimensions

Nominal Size	inch	1/2	3/4	mm
	mm	15	20	
L		72	74	
H		51	51	
H Add Attachment		63	63	
D		40	40	

## UTILITY BALL VALVES, STRAIGHT TYPE

Ball valve with built-in check valve,  
Male (parallel) & male threaded ends to BS21

1.0 MPa clean water, 0°C to +40°C (not freezing)

Direct flow 40°C max, Reverse flow 80°C max.



Fig. S24N-

• Nickel-chrome plated body

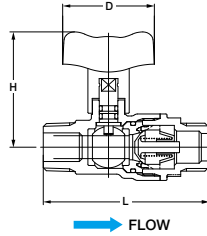

### Materials

Parts	Material
Body	Forged Brass: Nickel-chrome plated
Stem	Dezincification Resistant Brass
Ball	Forged Brass*
Ball seats	PTFE
Check valve	Polyacetal + NBR
O-ring	EPDM

\*SINi Plated

### Dimensions

Nominal Size	mm	
	inch	mm
	1/2	3/4
L	15	20
H	72	74
H Add Attachment	51	51
D	63	63
	40	40

## UTILITY BALL VALVES, STRAIGHT TYPE

Ball valve with built-in check valve,  
Female & female threaded ends to BS21

1.0 MPa clean water, 0°C to +40°C (not freezing)

Direct flow 40°C max, Reverse flow 80°C max.



Fig. S25N-

• Nickel-chrome plated body

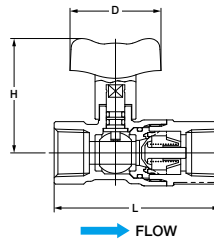

### Materials

Parts	Material
Body	Forged Brass: Nickel-chrome plated
Stem	Dezincification Resistant Brass
Ball	Forged Brass*
Ball seats	PTFE
Check valve	Polyacetal + NBR
O-ring	EPDM

\*SINi Plated

### Dimensions

Nominal Size	mm	
	inch	mm
	1/2	3/4
L	15	20
H	73	75
H Add Attachment	51	51
D	63	63
	40	40

## UTILITY BALL VALVES, STRAIGHT TYPE

Ball valve with built-in check valve,  
Male (parallel) & female threaded ends to BS21

1.0 MPa clean water, 0°C to +40°C (not freezing)

Direct flow 40°C max, Reverse flow 80°C max.



Fig. S28N-

• Nickel-chrome plated body

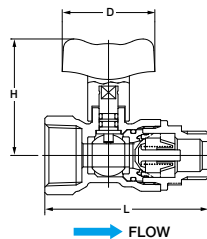

### Materials

Parts	Material
Body	Forged Brass: Nickel-chrome plated
Stem	Dezincification Resistant Brass
Ball	Forged Brass*
Ball seats	PTFE
Check valve	Polyacetal + NBR
O-ring	EPDM

\*SINi Plated

### Dimensions

Nominal Size	mm	
	inch	mm
	1/2	3/4
L	15	20
H	70.5	72.5
H Add Attachment	51	51
D	63	63
	40	40

## UTILITY BALL VALVES, STRAIGHT TYPE

Ball valve with built-in check valve,  
Male (parallel) & male threaded ends to BS21

1.0 MPa clean water, 0°C to +40°C (not freezing)

Direct flow 40°C max, Reverse flow 80°C max.



**Fig. S24N-3/4X**

• Nickel-chrome plated body

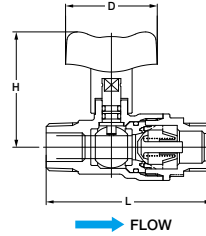

**Dimensions**

Nominal Size	inch	mm	mm
			3/4 x 1/2
			20 x 15
L			73
H			51
H Add Attachment			63
D			40

**Materials**

Parts	Material
Body	Forged Brass: Nickel-chrome plated
Stem	Dezincification Resistant Brass
Ball	Forged Brass*
Ball seats	PTFE
Check valve	Polyacetal + NBR
O-ring	EPDM

\*SiNi Plated

## UTILITY BALL VALVES, STRAIGHT TYPE

Ball valve with built-in check valve,  
Male (parallel) & female threaded ends to BS21

1.0 MPa clean water, 0°C to +40°C (not freezing)

Direct flow 40°C max, Reverse flow 80°C max.



**Fig. S28N-3/4X**

• Nickel-chrome plated body

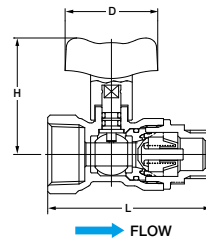

**Dimensions**

Nominal Size	inch	mm	mm
			3/4 x 1/2
			20 x 15
L			71.5
H			51
H Add Attachment			63
D			40

**Materials**

Parts	Material
Body	Forged Brass: Nickel-chrome plated
Stem	Dezincification Resistant Brass
Ball	Forged Brass*
Ball seats	PTFE
Check valve	Polyacetal + NBR
O-ring	EPDM

\*SiNi Plated



## DISCLAIMER

- KITZ does not take any responsibilities for damages arising from a result of natural disasters, accidents or fire which KITZ is not liable for, conduct of a third party, intentional act, misuse or use under abnormal conditions by a customer.
- KITZ does not take any responsibilities for damages arising from negligence of the prohibitions and cautions given in the catalogs and operation manuals, or installation and usage beyond the specification range.
- KITZ does not take any responsibilities for damages arising from product modification not entrusted to KITZ or usage under the load applied from other devices.



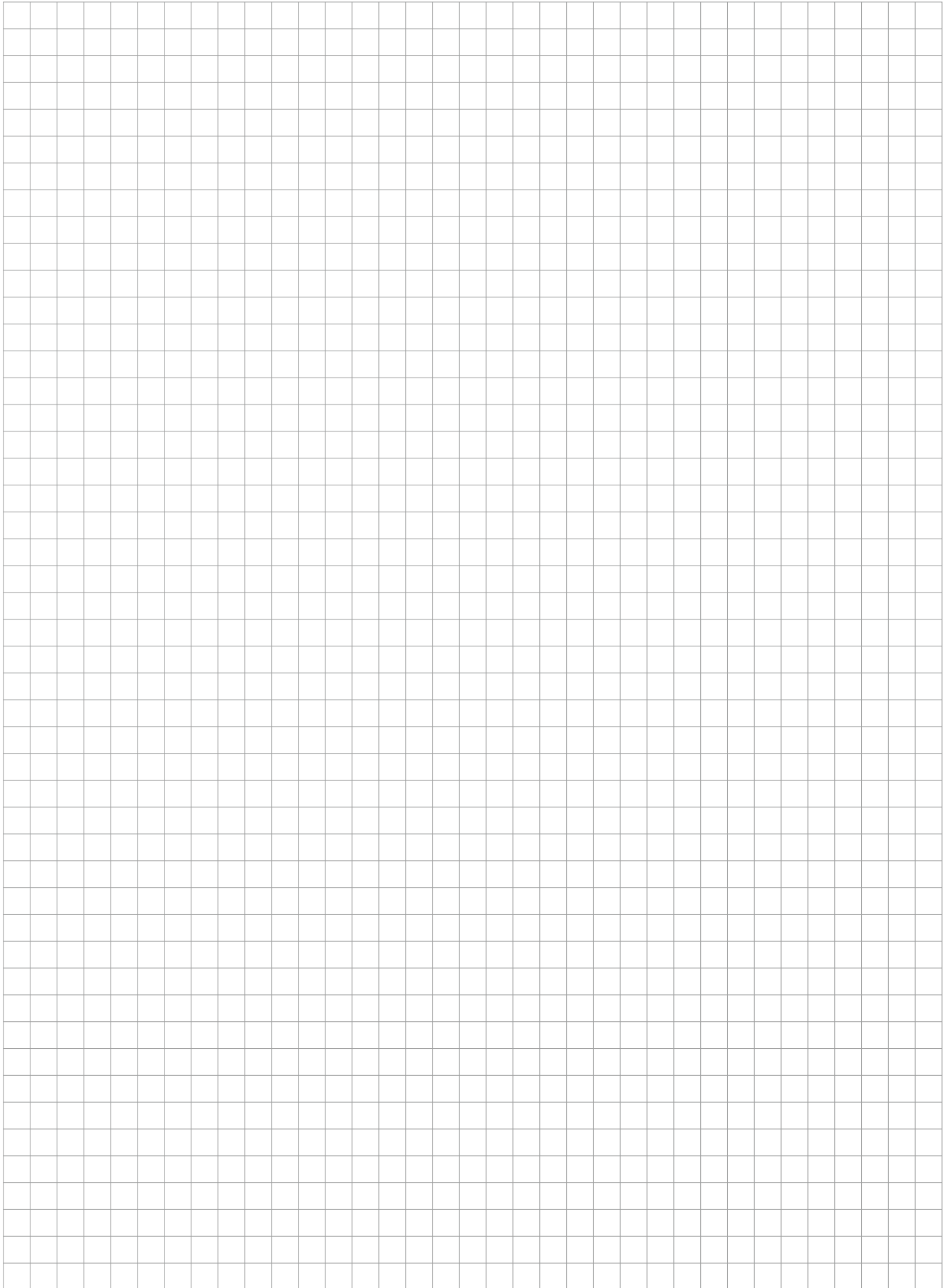



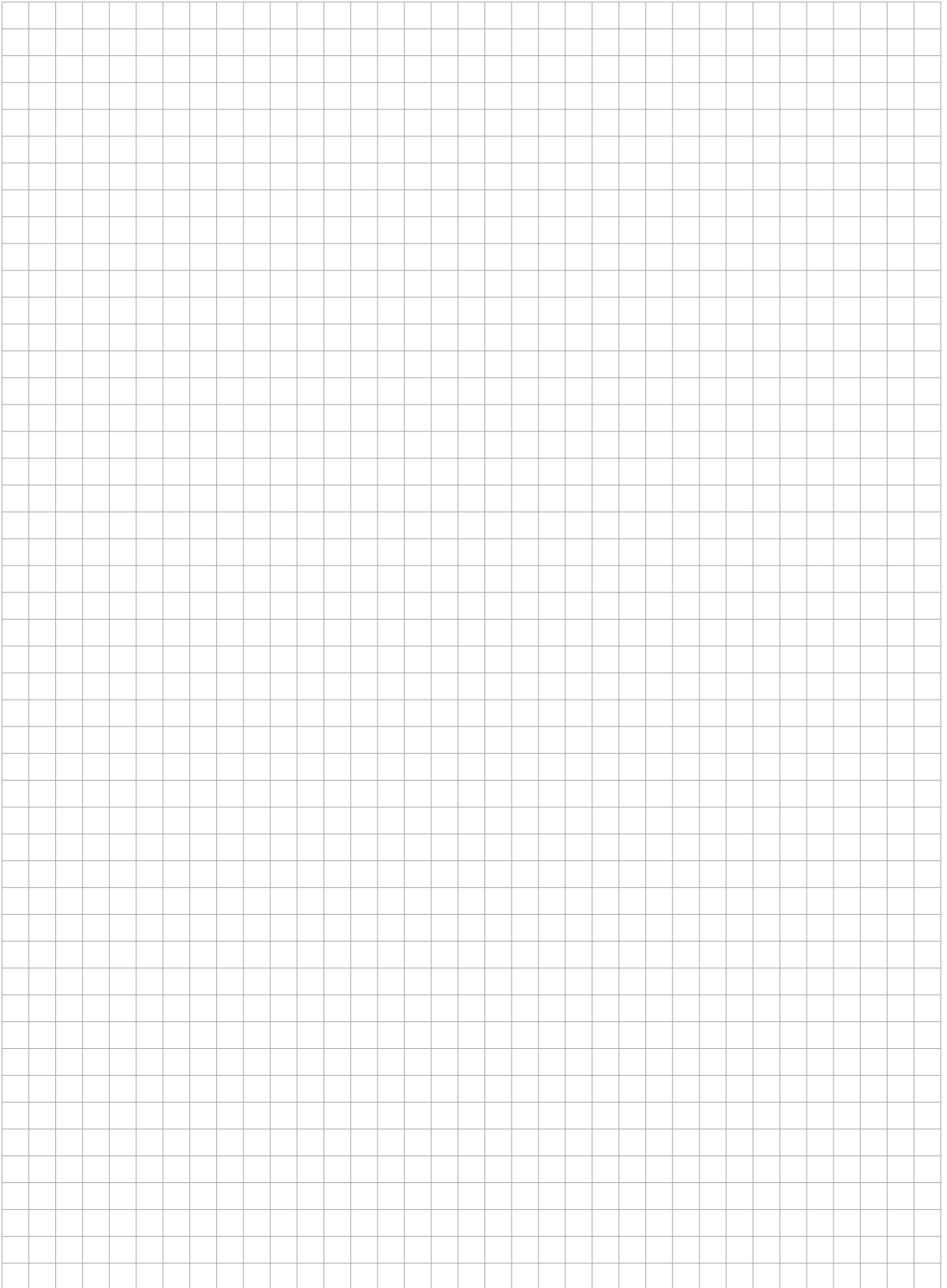

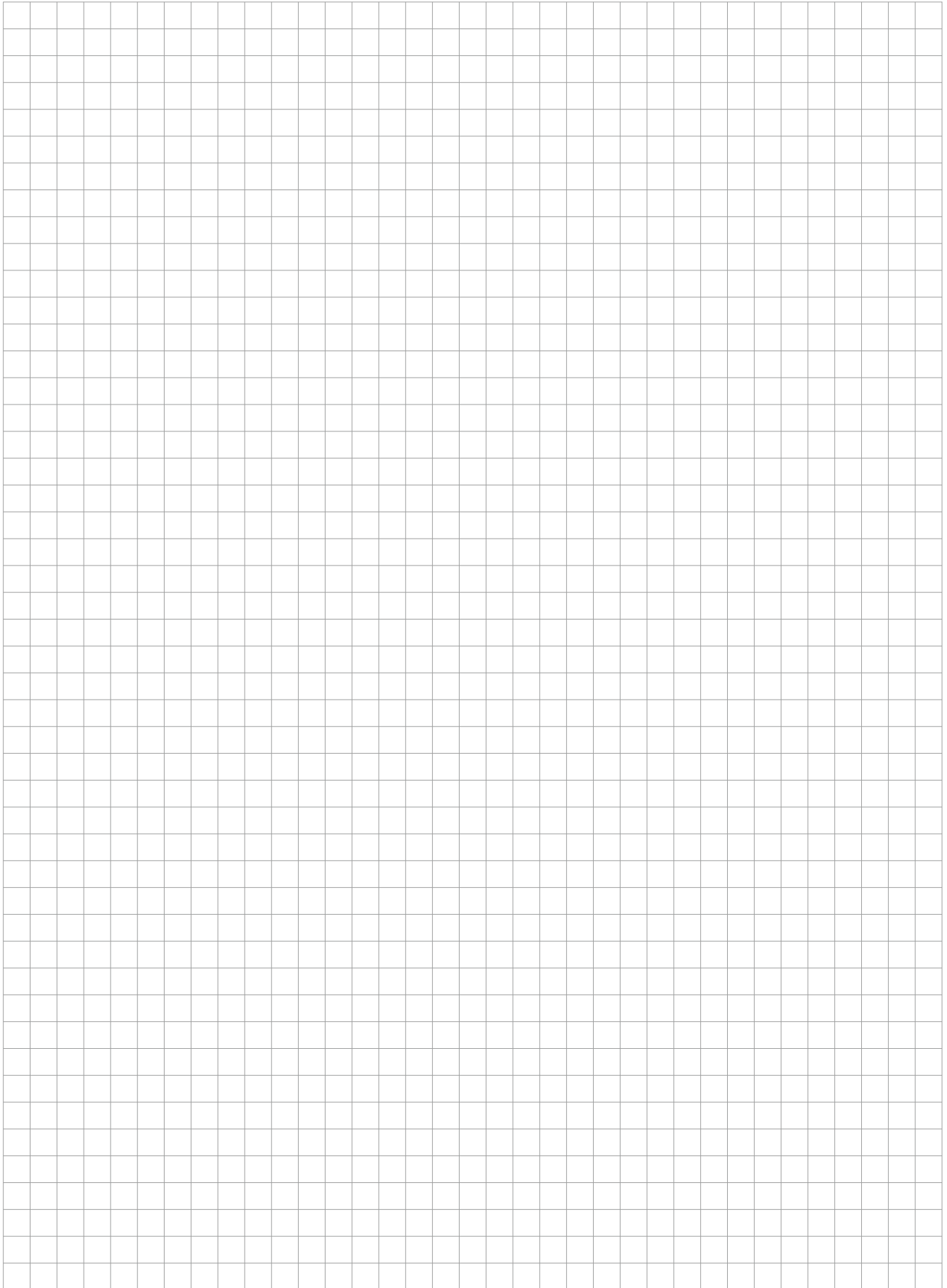

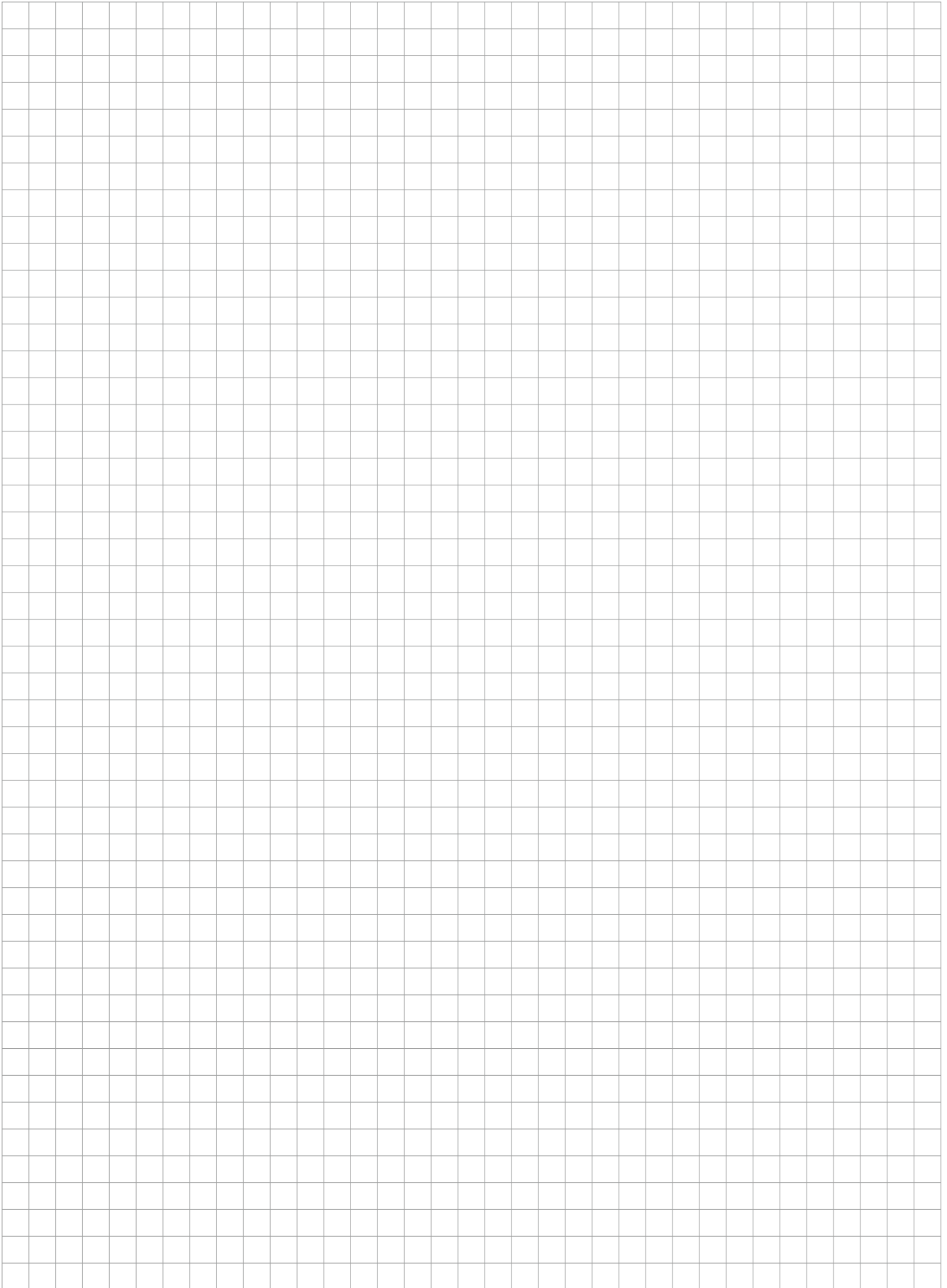

## CAUTION

Pressure-temperature ratings and other performance data published in this catalog have been developed from our design calculation, in-house testing, field reports provided by our customers and / or published official standards or specifications. They are good only to cover typical applications as a general guideline to users of KITZ products introduced in this catalog.

For any specific application, users are kindly requested to contact KITZ Corporation for technical advice, or to carry out their own study and evaluation for proving the suitability of these products to such an application. Failure to follow this request could result in property damage and/or personal injury, for which we shall not be liable.

While this catalog has been compiled with the utmost care, we assume no responsibility for errors, impropriety, or inadequacy. Any information provided in this catalog is subject to from-time-to-time change without notice for error rectification, product discontinuation, design modification, new product introduction or any other cause that KITZ Corporation considers necessary. This edition cancels all previous issues.

Read the instruction manual carefully before use.

## NOTICE

If any products designated as strategic material in the Foreign Exchange and Foreign Trade Law, Cabinet Order Concerning Control of Export Trade, Cabinet Order Concerning Control of Foreign Exchange and other related laws and ordinances ("Foreign Exchange Laws") are exported to any foreign country or countries, an export license issued by the Japanese Government will be required under the Foreign Exchange Laws.

Further, there may be cases where an export license issued by the government of the United States or other country will be required under the applicable export-related laws and ordinances in such relevant countries.

The contract shall become effective subject to the fact that a relevant export license is obtained from the Japanese Government.

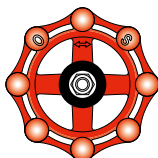

*A chrysanthemum-handle is a symbol of KITZ,  
the brand of valve reliability*

ISO 9001 certified since 1989

**KITZ**  
KITZ CORPORATION

1-10-1 Nakase, Mihama-ku, Chiba 261-8577, Japan  
International Business Development Dept.

Phone : 81-43-299-1730

Fax : 81-43-299-0121

URL : <https://www.kitz.com>

— Distributed by —