

# 公司簡介 The History of Tung Lee

ISO 9001 : 2008 認證通過



CCC 認證通過



CE (EMC)測試通過

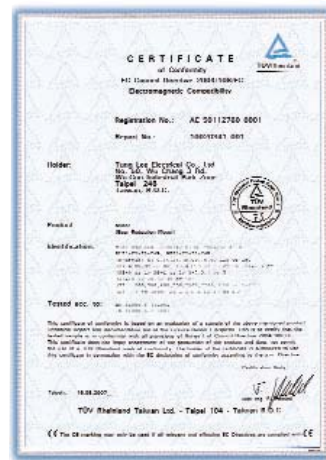

## 公司概要

公司商號：東力電機股份有限公司

所在地址：台北縣五股工業區五權三路50號

電話：(02) 2299-2655-9 (02) 2299-2149-50

傳真：(02) 2299-0146

資本額：玖仟萬圓整（授權資本一億八仟萬元整）

董事長：高勝雄

從業人員：120名

年營業額：肆億伍仟萬元 出口比例：65%內銷

年生產量：貳拾伍萬台 35%外銷

主要營業項目：齒輪減速馬達，小型AC . DC .馬達，AC . DC .馬達電子控速器，變頻器，線性馬達，渦輪減速馬達，伺服減速馬達，傳動軸用扭力限制器等專業生產。

主要銷售對象：停車機械設備，CNC 工具機械設備，電子機械設備，輸送機械設備，油壓機械設備，自動化機械設備。

內銷客戶：友嘉實業、台塑企業、中國鋼鐵、南亞塑膠、楊鐵機械、台灣松下、台灣麗偉、正隆紙業、振榮油機…等。

外銷地區：日本、泰國、新加坡、馬來西亞、澳洲、美國、德國、香港、中國大陸…等。

## 沿革

東力電機有限公司創業於民國65年（西元1976年），由早期的服務業逐步邁向生產製造與銷售到進出口貿易，（西元1990年）代理日本小型馬達與齒輪減速機販賣，

（西元1992年）並引進國外技術開始生產小型齒輪馬達減速機，開拓了台灣最早期的小型齒輪減速馬達專業製造廠。

## 成長史

- （西元1976年）- 創立東力公司，資本額20萬元，廠地佔地30坪，專營買賣與修理服務。
- （西元1982年）- 建廠於三重市光復路一段12巷26號，廠房約300坪，員工30人，同年開始製造馬達。
- （西元1983年）- 因實際業務之需要公司改組為東力電機股份有限公司，並增加營業項目有齒輪減速機，小型AC . DC .馬達及馬達電子控速器、變頻器、傳動軸用扭力限制器等專業生產。
- （西元1984年）- 建立全省經銷網與成立貿易體制，使生產品順利外銷，其當時員工約40人。
- （西元1990年）- 因當時業績及實際生產量逐年突增，為應付其實際需求，再度於台北縣五股工業區五權三路50號，投資建設新廠房1200坪，員工有80餘人之多。
- （西元1995年）- 國際事業一致好評及擴大，遂於中國上海市成立分公司。
- （西元2000年）- 因考慮台灣廠商轉移大陸投資生產頗多，公司為求台商大陸交貨方便及降低成本，始於大陸廈門及蘇州設廠製造，以供大陸廠商之需。

## THE HISTORY OF TUNG LEE

Established in 1976, the Company has evolved from its service oriented core business at the beginning through manufacturing and sales to export/import trade business. In 1990, it acquired distributorship of Japanese small motors and gear reducer. In 1992, it introduced foreign technology and know-how of small gear motor reducer manufacturing plant in Taiwan.

- 1976 Tung Lee Company was founded with capitalization of NT \$200,000 on a plant site with 100 m<sup>2</sup>, specializing in resale and repairing.
- 1982 New plant constructed at No. 26, Lane 12, Guang-fu Road, Sec. 1, San-chung City. Capitalization increased to NT \$2 million with 30 employees. In the same year, motor manufacturing began.
- 1983 Under demand of business expansion, the Company was reorganized as Tung Lee Electrical Co., Ltd. and new products, such as gear reducers, small AC/DC motor speed controllers, inverters, torque limiter, were added to product lines.
- 1984 Established nationwide distribution networks and opened up overseas markets. 40 employees.
- 1990 Because gradual increase in sales and production volumes, increased capitalization to NT \$20 million, invested and built a new plant with 4000 m<sup>2</sup> at the Industrial Park in Wu-gu, Taipei Country. 80 employees were working with Company.
- 1995 Winning international recognition. Established branch office in Shanghai, China.
- 2000 In order to providing the better service to the big demand in China. Tung Lee established manufactories in Xia-men and Su-Zhou to offer the efficient serve and lower the cost for many clients which expend their business from Taiwan to China market.

## COMPANY PROFILE

- Registered Name : Tung Lee Electrical Co., Ltd.
- Business Address : 50, Wu Chuan 3rd Road, Wu Gu, Taipei county, Taiwan
- Telephone : +886-2-2299-2655~59 886-2-2299-2149~50
- Facsimile : +886-2-2299-0146
- Capitalization : NT \$90 million
- CEO : Sheng-Hsiung Kao
- Employee No. : 120
- Annual Sales Revenue : NT \$450 million
- Annual Production : 250,000 set
- Export/Local Ratio : 35 : 65

- Major Products : Gear Reducers, Small AC/DC Motors, AC/DC Motor Electronic Speed Controllers, Inverters, Linear Motors, Turbine Reducers, Transmission Axis Torque Limiter.
- Major Clients : CNC Equipment, Electronic Machinery Equipment, Conveying Belt Equipment, Oil Pressure Machinery Equipment, Automatic Machinery Equipment.
- Domestic Clients : Nan Ya Plastics Corp., China Steel, Matsushita Electric (TAIWAN) Co., Ltd., Lead Well CNC Machines Mfg. Co., Chang Hua Chen Ying Oil Machinery Co., Ltd., Cheng Loong Co.
- Overseas Markets : Japan, Thailand, Singapore, Malaysia, Australia, The US, Germany, Hong Kong, Mainland China.

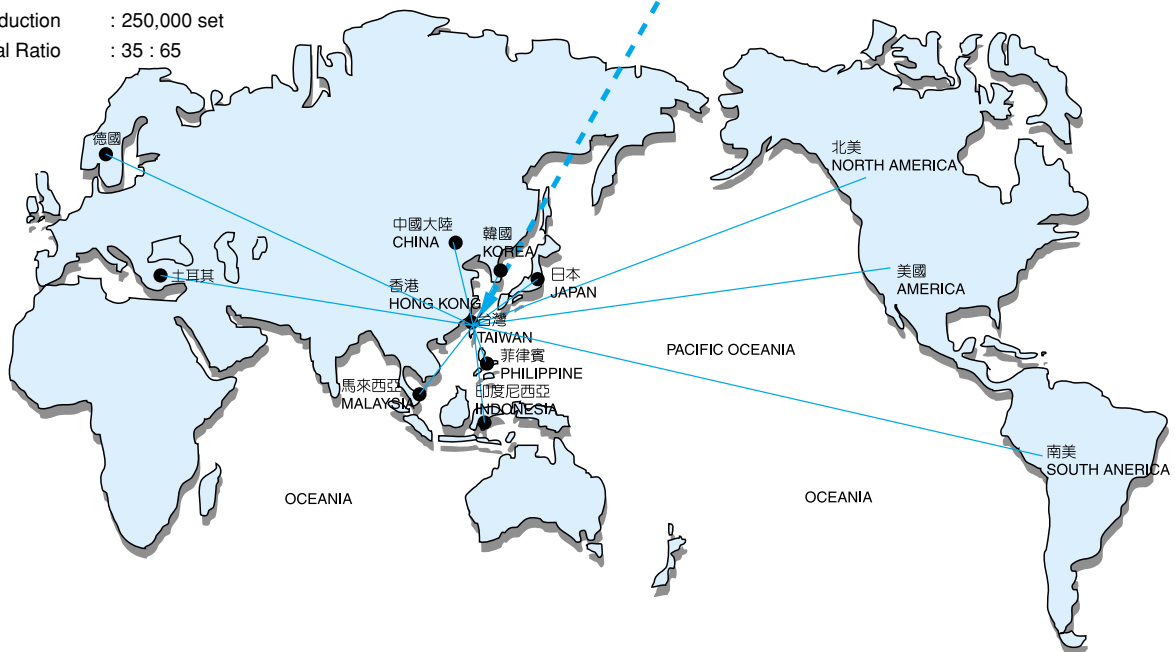
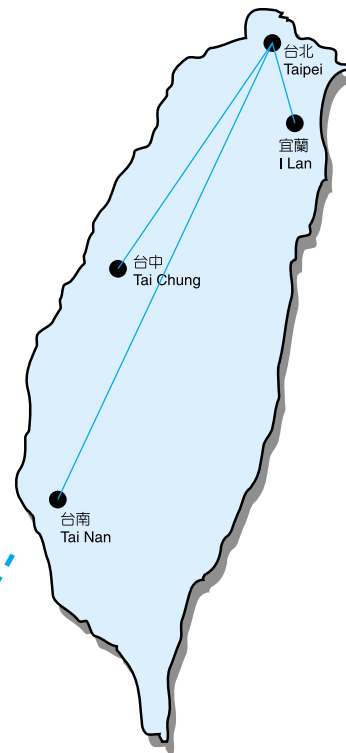

3



IK型  
Page 11~14

單相感應式馬達  
Single phase induction motor  
馬力 HP : 6W~150W  
電壓 V : 100V~110V  
200V~220V  
三相感應式馬達  
3- phase induction motor  
馬力 HP : 25W~150W  
電壓 V : 200V · 220V  
380V · 440V

- 額定運轉為連續運轉
- 採用 E 級絕緣
- 單相馬達使用電容器式感應馬達，故高功率、低噪音。
- 三相馬達使用三相電源200V....的感應馬達。
- \* Rated continuous operation
- \* E class insulation
- \* Capacitive induction motor shall be used for high power output and low noise single phase motor.
- \* Using the 220V, 3 phase AC Induction motor.



RK型  
Page 16~16

單相頻繁啟動(定格)馬達  
Single phase reversible motor  
馬力 HP : 6W~150W  
電壓 V : 100V~110V  
200V~220V  
三相頻繁啟動(定格)馬達  
3- phase reversible motor  
馬力 HP : 25W~150W  
電壓 V : 200V · 220V  
380V · 440V

- 具有瞬時轉換正轉、逆轉功能。因採用平衡繞線方式，並內裝簡易制動機構能夠瞬時地轉換正轉、反轉，其正反旋轉特性同樣均勻且穩定。
- 連續額定式30分鐘額定。感應馬達和可逆式馬達的不同點：可逆式是能瞬時轉換正、反轉，但感應馬達將接線轉換到反轉，會發生旋轉磁場和逆方向的轉矩，故不能旋轉負載時轉換逆方向。
- \* Instantaneous alternate between normal and reversible for motors equipped with balanced windings and built-in simple brake mechanism.
- \* Thirty minutes of rated operation. Difference between the induction motor and reversible motor: the later one can instantaneously be reversible, however rotating magnetic field & reversible momentum for induction motor occurs in reversible direction. In case no reversible shall be made in loading condition.



IK+B型  
Page 17~20

單相附電磁剎車馬達  
Single phase motor with electromagnetic brake  
馬力 HP : 6W~150W  
電壓 V : 100V~110V  
200V~220V  
三相附電磁剎車馬達  
3-phase motor with electromagnetic brake  
馬力 HP : 25W~150W  
電壓 V : 200V · 220V  
380V · 440V

- 確實地保持負載：既為無激磁動作式電磁制動器，剛關掉電源時，立即產生制動力而確實地保持負載。
- 短時間內制動：電動機單機時，超程是2~4旋轉。
- 可控制較複雜的瞬時正、反轉：每分鐘可以停止6次（停止時間必須保持3秒以上）。如須1分鐘停止7~100次時，應採用C&B馬達。
- \* Always maintain the load properly: For a non-exciting type electrical magnetic brake, loading can be kept normally by the brake whenever the power source is "Off".
- \* Instantaneous brake: Over-travel in 2 - 4 cycles only for a single motor.
- \* More complex, controllable, instantaneous Normal / Reversible time: Allowable "Stop" for 6 times per minute. (3 second or more have to be kept for each "Stop"), C&B type of motor is applicable on 100 times of "stop" per minute if necessary.



US型  
Page 21~22

無段變速馬達  
Stepless variable speed control motor  
馬力 HP : 6W~120W  
電壓 V : 單相 Single phase  
100V~110V  
200V~220V

- 因配用速度控制器，可以調整廣範圍的變速（50Hz.....90~1400轉/分；60Hz.....90~1700轉/分）。
- 可按需選擇變速、制動、轉換正·反轉、慢速起動、慢速減速等多種複雜的運轉程序。
- 內部備有轉速傳感器，實行回授控制，因此電源頻率有變化，其規定轉數絕無變化。
- \* Wide range of variable speed is adjustable by using the speed controller. (50Hz. ....90 - 1400 rpm; 60Hz. ....90 - 1700 rpm).
- \* More operational procedure shall be available, such as: variable speed selection, normal / reversible, slower starting, slower speed reduction, etc.
- \* Built - in rpm sensors, feed - back control, a constant rpm can be obtained even if there is any frequency variation.

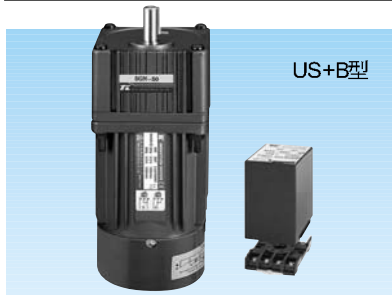

US+B型  
Page 23~24

無段變速附電磁剎車馬達  
Variable speed control motor with electromagnetic Brake  
馬力 HP : 6W~120W  
電壓 V : 單相 Single phase  
100V~110V  
200V~220V

- 因配用速度控制器，可以調整廣範圍的變速（50Hz.....90~1400轉/分；60Hz.....90~1700轉/分）。
- 可按需選擇變速、制動、轉換正·反轉、慢速起動、慢速減速等多種複雜的運轉程序。
- 內部備有轉速傳感器，實行回授控制，因此電源頻率有變化，其規定轉數絕無變化。
- \* Wide range of variable speed is adjustable by using the speed controller. (50Hz. ....90 - 1400 rpm; 60Hz. ....90 - 1700 rpm).
- \* More operational procedures are available, such as: variable speed selection, normal / reversible, slower starting, slower speed reduction etc.
- \* Built - in rpm sensors, feed - back type of control, a constant rpm can be obtained even if there is any frequency variation .

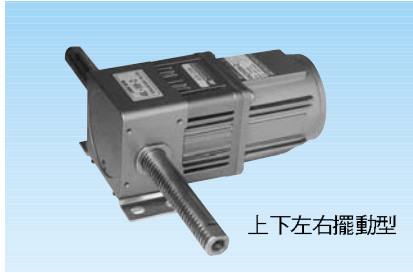

Page 25~26

直線型減變速馬達  
Linear type gear head and variable speed motor  
馬力 HP : 6W~150W  
電壓 V : 單相 Single phase  
100V~110V  
三相 3-phase  
200V~220V  
380V~440V

- 自動化機械推動物料簡易法。
- 可任意選擇帶動馬達型號。(IK、RK、US、DM等.....)
- 動作齊全可左右擺動。  
上下擺動。
- \* Simple method for the automatic mechanical materials lifting operation.
- \* Selectable in any type of driving motor. (IK, RK, US, DM.....etc.)
- \* Offering all kind of operation such as: Swing left and right  
Swing up and down

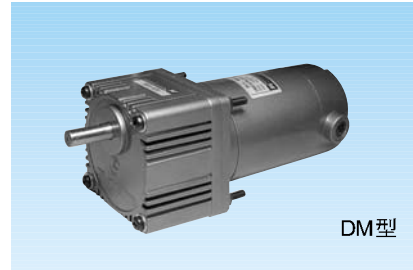

Page 27

永磁性直流馬達  
Permanent magnet DC motor  
馬力 HP : 30W~120W  
電壓 V : 12V · 24V · 90V  
回轉數 rpm : 1800RPM  
3000RPM

- 在無交流電地點用電池即可使用。
- 簡易控制箱，調整電壓：可做變速用。
- 變速範圍大，扭力強。
- 回轉數如需要可定做。
- \* Battery can be used as a power source if AC power is not available.
- \* Simple control box, adjustable voltage, for speed alternating purpose
- \* Wider range for variable speed, larger torque operation.



Page 28

渦輪減速馬達  
Worm gear reduction motor  
馬力 HP : 40W~200W  
電壓 V : 單相 Single Phase  
100V~110V  
200V~220V  
三相 3-Phase  
200V~220V  
380V~440V

- 90度出力軸方向可減省空間。
- 具有相當停止保持力。
- 可任選調配任何馬達。
- (IK · RK · US · DM)等.....
- \* To reduce the space requirements for installation the 90 degree output power shaft can be used.
- \* Certain durability in stoppage.
- \* Any kind of motor can be used.
- \* (IK, RK, US, DM)etc.

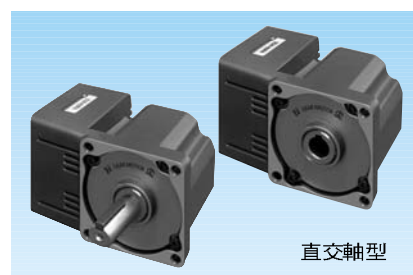

Page 29~30

直交軸系列(RH/RA)  
小型直交軸系列減速機  
Right-Angle Gear Reducer  
馬力 HP : 25W~150W  
電壓 V : 單相Single Phase  
100~120V  
200~240V  
三相 3-Phase  
200~220V  
380~440V

- 90度出力軸方向 節省安裝空間
- 可搭配現有各種型式小型馬達IK/RK/US/DM系列
- 使用螺旋傘齒輪，擁有高強度，低噪音的特性
- 相較傳統蝸輪式減速機，直交軸系列擁有較高齒輪 強度及使用壽命可減省空間。
- \* 90 Degree Right-Angle hollow bore gear box.
- \* Compatible with wide range selection of motors such as IK/RK/US/DM.
- \* From the benefit of spiral bevel gear, RH/RA series provide high strength, low noise, and space saving characteristics.
- \* Compare to the worm gear reducer, the right-angle hollow bore gear reducer has higher strength in operation and better durability.

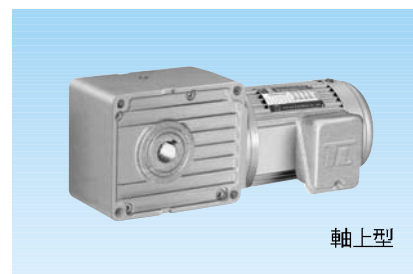

Page 41~42

軸上型減速機  
TL4060/4070/5080  
馬力 HP : 100W~1500W  
電壓 V : 單相Single Phase  
100~120V  
200~240V  
三相 3-Phase  
200~220V  
380~440V  
減速比: 1/30~1/300

- 各型號僅單一安裝尺寸，不因減速比而改變安裝尺寸
- 馬達直接輸入減速齒輪箱，有效降低安裝尺寸
- 在輸出段搭配高效率齒輪，降低因意外的撞擊而直接對銅齒輪造成損傷
- 選用高性能潤滑油品，免除定期保養的不便
- \* Unique frame size design helps to cut down the possibility of installation surface change due to changing the gear ratio.
- \* With built-in motor direct input to the gear box, minimize the installation space.
- \* Effectively avoid the damage to the copper worm gear by better structure design.
- \* Pre-lubricated design offers customers the maintenance-free service life.



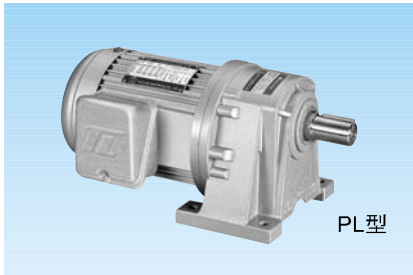

Page 31~33, 35

臥式減速馬達  
馬力: 100W~3700W  
電壓: 單相 100V~110V  
200V~220V  
三相 200V~220V  
380V~440V  
可搭配電磁剎車器  
減速比齊全

Horizontal Type Gear Motor (Foot-Mounted)  
Output: 100W~3700W  
Voltage: Single Phase 100V~110V · 200V~220V  
3 Phase 200V~220V · 380V~440V  
Optional: Electric Magnetic Brake Unit  
(90V Safe Brake)  
Full Range of Reduction Ratio

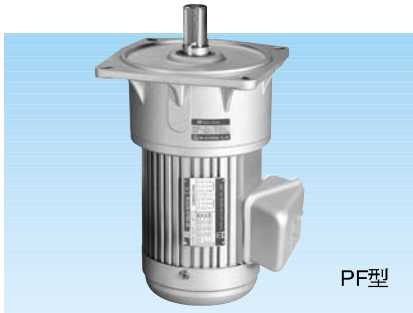

Page 31~32, 34, 36

立式減速馬達  
馬力: 100W~3700W  
電壓: 單相 100V~110V  
200V~220V  
三相 200V~220V  
380V~440V  
可搭配電磁剎車器  
減速比齊全

Vertical Type Gear Motor (Flange-Mounted)  
Output: 100W~3700W  
Voltage: Single Phase 100V~110V · 200V~220V  
3 Phase 200V~220V · 380V~440V  
Optional: Electric Magnetic Brake Unit  
(90V Safe Brake)  
Full Range of Reduction Ratio

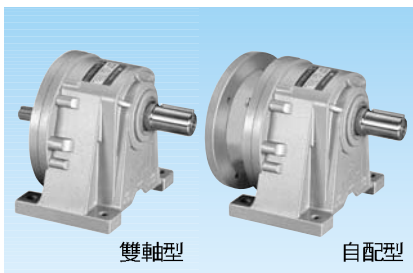

Page 37, 38, 39, 40

PLK/PFK 自配馬達型減速機  
適用IEC規格馬達  
馬力: 100W~3700W  
減速比齊全  
PLD/PFD 雙軸型減速機  
馬力: 100W~3700W  
減速比齊全

PLK/PFK Self-Contained  
Suitable for all IEC motors  
Output: 100W~3700W  
Full Range of Reduction Ratio  
PLD/PFD Dual Shaft Gear Reducer  
Output: 100W~3700W  
Full Range of Reduction Ratio



Page 45~48

TRS歐系型

TRS/TRK 伺服專用減速機  
減速比: 1/3~1/100  
精密度: 最高3弧分/一般12弧分  
低噪音高扭力  
TRS: 安裝尺寸符合歐系產品規格  
TRK: 安裝尺寸符合日系產品規格

- 一體式的出力軸設計，增加強度同時避免因減速齒箱在承受負載時造成變形破壞
- 提供最高兩段式的齒輪箱設計，可達最高 1:100 的多種減速比
- 接受客製化訂單，協助客戶選用或設計專用的減速機型

NRM/NR 鋁合金中空蝸輪減速機  
Aluminum Hollow-Shaft Worm Gear Reducer

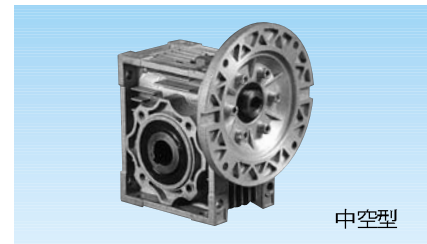

Page 43~44

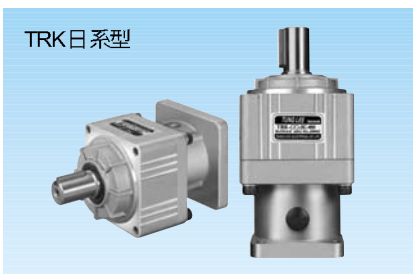

Page 45~48

TRK日系型

- \* Integrated output shaft, maximize the thrust as well as the efficiency.
- \* Two-stage design provide more gear ratio selections.
- \* Accept ODM case, helping customers to design and to manufacture dedicated products.

無段變速機  
Variable Speed Control Motor

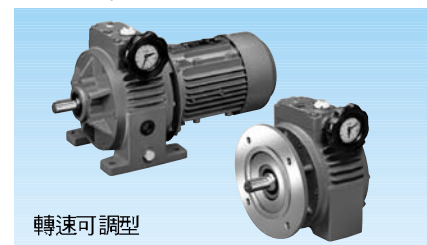

Page 49~50

# 馬達用詞概要

## 1. 定格

馬達在使用上從溫度上升分為連續定格及短時間定格兩種，通常被決定為定格有電壓，周波數，定格回轉數等；這些分別被稱為定格出力，定格電壓，定格周波數，定格回轉數等。

## 2. 連續定格、短時間定格

已定格出力在無異常情況下連續運轉稱為連續定格按規定時間內定格出力運轉稱為短時間定格。

## 3. 出力

馬達在單位時間內所能做的扭力之表示由馬達的回轉數及轉矩決定，在馬達已定格出力之表示，在日本瓦特 (W) 表示，而歐美以 HP 表示出力

$$(W) = 1.027 \times 10^{-5} \times T \times N$$

1.027 x 10<sup>-5</sup> : 常數 T (gcm): 轉矩 N(rpm): 回轉數

## 4. 定格出力

指馬達在定格電壓周波數條件下能發揮其最佳特性出力為定格出力，回轉數轉矩，通常簡稱為定格出力。

## 5. 起動轉矩

馬達在起動瞬間所發出轉矩稱為起動轉矩，比這轉矩大的負荷一加之在馬達上，馬達就無法回轉。

## 6. 停動轉矩

馬達在一定電壓，一定周波數產生最大轉矩，在此轉矩標準內負荷再加上去，馬達便會停止。

## 7. 定格轉矩

馬達在定格電壓，定格周波數，定格出歷時所連續發出的轉矩稱為定格轉矩，定格回轉數的轉矩。

## 8. 定格回轉數

馬達在定格出力時之回轉為使用上最理想之回轉數。

## 9. 同步回轉數

因馬達的極數及電源周波數之決定已被固定，所以可由以下公式來表示，通常以每分鐘回轉表示。

$N_s = \text{同步回轉數 (rpm)}$   $N_s = 120f/p$  (rpm)  $f = \text{周波數(Hz)}$   $P = \text{極數}$   $120 = \text{常數}$   
 例如: 4極的馬達電源周波數60Hz  $N_s = 120 \times 60 / 4 = 1800(\text{rpm})$

## 10. 轉差率

回轉表現方法之一種，可由以下公式表示：

$S = N_s - N / N_s$  又  $N = N_s(1 - S)$   $N_s$ : 同步回轉數(rpm)

$N$ : 任意負荷時之回轉數值(rpm) 在此，4極60Hz的感應馬達轉差率

$S = 0.1$ 時之回轉

$N = 120 - 60 / 4$   $(1 - 0.1) = 1800(1 - 0.1) = 1620(\text{rpm})$

# Terminology for the motors

## 1. Ratings

There are two kinds of rating for motors: continuous duty rating and short time rating classified by the temperature rise of motors. Usually they are defined by power output, voltage, cycles in frequency, and rpm etc. ; so-called rated power output, rated voltage, rated cycles in frequency, and rated rpm.

## 2. continuous duty rating and short time rating

continuous operation at the rated output power under normal condition is called a continuous duty rating, while operation at the rated output power in a specific time is so called short time rating.

## 3. Output power

The twist force produced by motors in an unit time shall be expressed by rpm and the torque of motors. The rated output power of a motor is expressed by Watt in Japan and H.P. in Europe.

$(W) = 1.027 \times 0.00001 \times T \times N$ , where

1.027 x 0.00001: a constant T (gcm): Torque N (rpm): number of revolutions per minute

## 4. Rated output power

Rated output power means to develop a best characteristic output power under the rated voltage and rated frequency of motors. The rpm torque is simply called rated output power.

## 5. starting torque

Torque produced at any instant of a starting motor is called starting torque. Motor is not rotating in case of a larger load than the torque.

## 6. Stop torque

The maximum torque is produced by any motor under a specific voltage and specific frequency. Any loading is applied on a Motor within this range of torque, motor is stopped.

## 7. Rated torque

The speed reduction gearing under rated voltage, rated frequency, rated power output is defined as continuous torque, as well as the rated torque, torque for rated rpm.

## 8. Rated rpm

The most favorable rpm of the motor shall be a rpm under a rated output power.

## 9. Rpm in synchronism

Suppose the number of poles of a motor and the frequency of power source are given, It can be shown in the following equation which is usually expressed by revolution per minute.

$N_s = 120f / p(\text{rpm})$

Where  $N_s = \text{Number of rpm in synchronism}$

$f = \text{number of frequency in Hertz.}$   $P = \text{number of poles of the motor}$   $120 = \text{constant}$

For example:

A four-pole motor and frequency of the power source is 60Hz.

$N_s = 120 \times 60 / 4 = 1800(\text{rpm})$

## 10. Slide slip rate

Another kind of indication for rpm can be shown in the following formula:

$S = N_s - N / N_s$  or  $N = N_s(1 - S)$   $N_s$ :

Where  $N_s$ : rpm in synchronous (rpm)

Where  $N$ : rpm under any loading (rpm), The slide slip rate for a 4 pole 60Hz induction motor is,

Revolution per  $S = 0.1$   $N = 120 - 60 / 4$   $(1 - 0.1) = 1800(1 - 0.1) = 1620(\text{rpm})$

## 驅動慣性力矩時 Driving Moment of Inertia

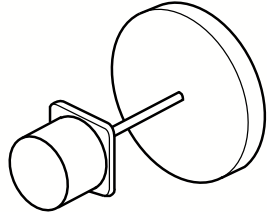

馬達  
CD<sup>2</sup> (包括轉子的飛輪效率)

$$P_g = 1.027 NT(W)$$

$$T = \frac{GD^2}{375} \cdot \frac{N}{t} (kg \cdot m)$$

$N$ : 轉數 (rpm)  
 $T$ : 轉矩 (kg·m)  
 $GD^2$ : 飛輪效率 (kg·m<sup>2</sup>)  
 $t$ : 時間  
 $P_g$ : 所需動力 (W)

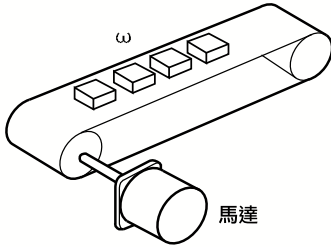

馬達

$$P_g = (P_1 + P_2 + P_3) \frac{100}{\eta} (W)$$

空轉動力  $P_1 = 9.8 \mu \omega \ell (W)$

$$\text{水平動力 } P_2 = \frac{\mu Q \ell}{367} (W)$$

$$\text{垂直動力 } P_3 = \frac{QH}{367} (W)$$

$\ell$ : 運輸機長 (m)  
 $W$ : 皮帶單位長重量 (kg/m)  
 $\mu$ : 摩擦係數  
 $\omega$ : 皮帶速度 (m/sec)

$Q$ : 運輸量 (kg/h)  
 $\eta$ : 效率 (%)  
 $H$ : 傾斜運輸機兩端高低差 (m)  
 $P_g$ : 所需動力 (W)

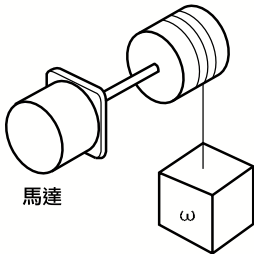

馬達

$$P_g = \frac{\omega V}{6 \cdot 12} \cdot \frac{100}{\eta} (W)$$

$\omega$ : 負載 (kg)  
 $V$ : 速度 (m/min)  
 $\eta$ : 效率 (%)  
 $P_g$ : 所需動力 (W)

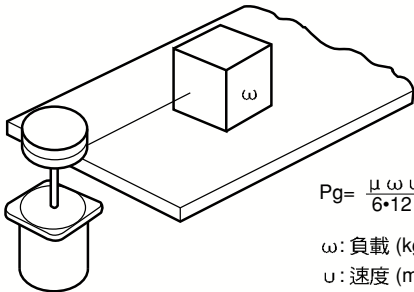

馬達

$$P_g = \frac{\mu \omega u}{6 \cdot 12} (W)$$

$\omega$ : 負載 (kg)  
 $u$ : 速度 (m/min)  
 $\mu$ : 摩擦係數  
 $P_g$ : 所需動力 (W)

# 減速機用詞概要

## 1. 減速機選擇方法

減速機為配合馬達機型及瓦特數依負荷狀況做下列之分類：  
 GN型→配合6, 15, 25, 40, 60, 90, 120, 150W使用→(輕負荷請選含油軸承；重負荷請選滾珠軸承)。  
 GU型→配合60, 90, 120, 150W使用 (GU型全部使用滾珠軸承)。

### 1. Selections of the speed reduction gearing (mechanism)

To coordinate between the type of motor and wattage of power used, the following classification is made according to the loading conditions:  
 Model GN - for 6, 15, 25, 40, 60, 90, 120, 150W - (Oil bearing for applications in light loading, ball bearing shall be used for those heavier loading)  
 Model GU - for 60, 90, 120, 150W - ( using ball bearing for all GU type motor).

## 3. 最大容許轉矩 (右圖)

減速機之出力轉矩因減速機比大而增大，但因受了齒輪之材質及其他條件之影響，限制實際所能承受之負荷轉矩，而減速機之最大容許轉矩之大小是視減速機種類與減速機之出力轉矩。

$$TG = TM \times i \times n = 1.9 \times 100 \times 0.66 = 125.4 \text{ kg}\cdot\text{cm}$$

如右圖所示4GN-100K最大容許轉矩80Kg·cm，但計算所得之減速機出力轉矩為125kg·cm，但是實際上減速機所能承受之負荷不可超過80kg·cm。

### 3. Maximum allowable torque (Figure to the right)

The torque for a motor output power can be increased in accordance with the bigger reduction ratio of the speed reduction gearing. however, the practical limitation of the loading torque shall be effected by the material of the gear and some other conditions. The Maximum allowable torque for a speed reduction gearing is also depending on the kind of speed reduction gearing and the output power torque of the speed reduction gearing.

$$TG = TM \times i \times n = 1.9 \times 100 \times 0.66 = 125.4 \text{ Kg}\cdot\text{cm}$$

The maximum allowable torque 80 Kg·cm for the 4GN-100K is shown in the figure to the right, in comparing to the output power torque of the speed reduction gearing, 125 Kg·cm, by calculation, In practical, however, under no way the loading of a speed reduction gearing exceed 80 Kg·cm.

## 4. 容許懸吊荷重及容許推力荷重 (右圖)

減速機之出力軸使用在鏈條，齒輪或皮帶等傳動機構上，在一定出力軸處，增加懸吊荷重 (同軸呈直角重) 軸承的壽命會受到懸吊荷重與出力軸間作用關係，產生直接影響。

### 4. Permissible Radial Force and Axial Force (see figure below):

Transmission mechanism such as chain, gears, or belt can be used as an output shaft for the speed reduction gearing. Suppose the radial force is increased (vertically to the shaft) at the output shaft which should be effected directly against the applicable life regarding to relations between Radial force and Axial force.

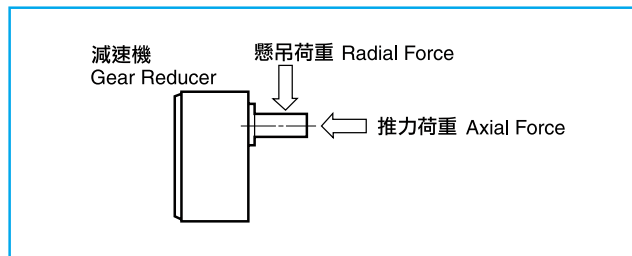

# Terminology for the gear reducers

## 2. 減速機配合馬達之出力轉矩計算方式：

$$\text{轉矩} \dots\dots TG = TM \times i \times n$$

TG: 減速機之轉矩(kg·cm)      TM: 馬達之轉矩(kg·cm)

i: 減速機之減速比      n: 減速機之傳動效率

## 2. Calculations of a speed reduction gear in relating to the torque of the motor output power.

$$\text{Torque: } TG = TM \times i \times n$$

TG = torque of the speed reduction gearing (Kg·cm)

TM: Torque of a motor (Kg·cm)

i = Reduction ratio of the speed reduction gearing

n = transmission efficiency of the speed reduction gearing

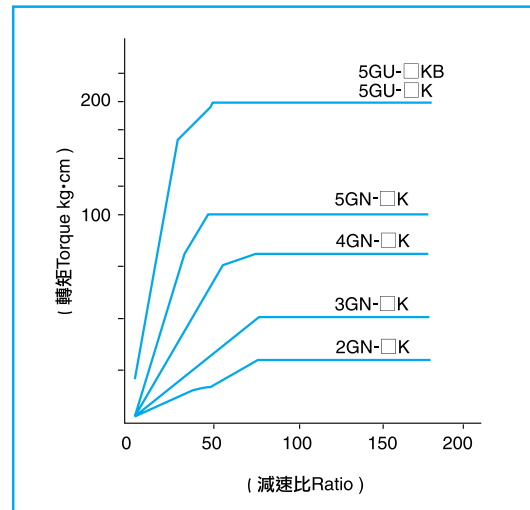

品名 Gear Model No.	減速比 Ratio	最大容許 轉矩 (kg·cm)	容許懸吊荷重(kg)		容許推力 荷重 (kg)
			在軸前端 10mm處	在軸前端 20mm處	
2GN-□	3~18	25	5	8	3
2GN-□K	20~180		12	18	
3GN-□	3~18	50	8	12	4
3GN-□K	20~180		15	25	
4GN-□	3~18	80	10	15	5
4GN-□K	20~180		20	30	
5GN-□	3~18	100	25	35	10
5GN-□K	20~180		30	45	
5GU-□KB	3~10	200	40	50	15
5GU-□K	12.5~18		45	60	
5GU-□K	20~180		50	70	

## 5. 減速機傳動效率 Transmission efficiency of the gear reducers

品名 Gear Model No.	減數比 Ratio																						
	3	3.6	5	6	7.5	9	10	12.5	15	18	20	25	30	36	40	45	50	60	75	90	100	120	150
2GN-□K	81%																						
3GN-□K	73%																						
4GN-□K	66%																						
5GN-□K	66%																						
5GU-□K	81%			73%			66%			66%			59%										

## 馬達型號解說 (IK, RK 規格) General information of motors, for IK·RK type



裝置尺寸  
Dimension of device

2:  60mm  
3:  70mm  
4:  80mm  
5:  90mm

**4 IK 25 GN - C -**

IK: 連續運轉  
Continuous operation  
RK: 頻繁啟動(定格)  
Reversible Rated Operation

馬力: 6W (HP)  
15W  
25W  
40W  
60W  
90W  
120W  
150W

A: 圓形軸 Cylindrical Shaft  
GA: 渦輪軸 for Worm Gear  
GK: 直齒軸 (40, 60W) Spur  
GS: 直齒軸 (60, 90W) Spur  
GN: 斜齒軸 Pinion cut shaft (6, 15, 25, 40, 60, 90, 120, 150W)  
GU: 斜齒軸 Pinion cut shaft (60, 90, 120, 150W)  
NA: 中空軸 for Hollow Shaft Gear

A: 單相 Single Phase 110V  
C: 單相 Single Phase 220V  
S<sub>2</sub>: 三相 3-Phase 220V  
S<sub>3</sub>: 三相 3-Phase 220/380V  
S<sub>4</sub>: 三相 3-Phase 220/440V

T: 附端子箱  
W/ Terminal-Box  
B: 附電磁剎車  
W/Electromagnetic Brake  
P: 溫控 Thermal Switch  
F: 強制風扇  
Ventilator Fan

## 減速機型號解說 (GN, GU規格) General information of reducers, for GN·GU type

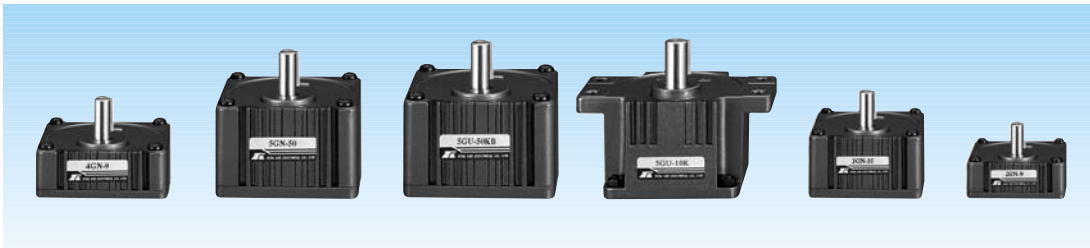

**4 GN - 100**

裝置尺寸  
Dimension of device

2:  60mm  
3:  70mm  
4:  80mm  
5:  90mm

GN: 斜齒軸 Pinion cut shaft (6, 15, 25, 40, 60, 90, 120, 150W)  
GU: 斜齒軸 Pinion cut shaft (60, 90, 120, 150W)

減速比 Ratio: 1:100

GN B型: 合銅、培林混合型  
GU K型: 有耳型  
KB型: 方筒型



# 馬達型號解說 (US 規格) General information of motors, for US type



M: 無段變速馬達  
Stepless variable speed  
Motor

**M 4 25 - 4 0 2** □

B: 附電磁剎車  
With  
Electromagnetic  
Brake

裝置尺寸  
Dimension of  
device  
2: □ 60mm  
3: □ 70mm  
4: □ 80mm  
5: □ 90mm

馬力: 6W  
(HP) 15W  
25W  
40W  
60W  
90W  
120W

0: 圓形軸 Cylindrical Shaft  
1: 渦輪軸 for Worm Gear  
2: 直齒軸 Spur(40, 60W)  
3: 直齒軸 Spur(60, 90W)  
4: 斜齒軸 Pinion cut shaft  
(6, 15, 25, 40, 60, 90, 120W)  
5: 斜齒軸 Pinion cut shaft  
(60, 90, 120W)  
6: 中空軸 for Hollow Shaft Gear

1: 單相 Single Phase  
100~110V  
2: 單相 Single Phase  
200~220V

0: 連續運轉  
Continuous operation  
1: 頻繁起動(定格)  
Reversible Rated Operation

# 馬達型號解說 (4GN/5GN-□ RH/RA) General information of motors



**5 GN - □ RH**

4: 4GN  
5: 5GN

GN系列 Series

減速比 Ratio  
10, 15, 20, 25, 30, 40, 45, 50, 60,  
75, 90, 100, 120, 150, 160, 180,  
200, 250, 300, 350, 400, 500, 600

RH: 中空軸型 Hollow Shaft Type  
RA: 出力軸型 Output Shaft Type

速度控制器型號解說(US/UX規格) General information of speed controller, for US/UX type



UX: 無段變速數字型控制箱  
Stepless variable speed controller with digital speed indicator

US: 無段變速控制箱  
Stepless variable speed controller

**US 4 25 - 02** □

**DMS - 08**

裝置尺寸  
Dimension of device

2: □ 60mm  
3: □ 70mm  
4: □ 80mm  
5: □ 90mm

馬力: 6W (HP)  
15W  
25W  
40W  
60W  
90W  
120W

01: 單相 Single Phase 100~110V  
02: 單相 Single Phase 200~220V

B: 附電磁剎車  
With Electromagnetic Brake

08: 30W  
09: 60W  
12: 120W

DC馬達速度控制器  
DC Motor Speed Controller  
Input: AC 100~240V  
Output: DC 90V

速度控制器型號解說(SS規格) General information of speed controller, for SS type

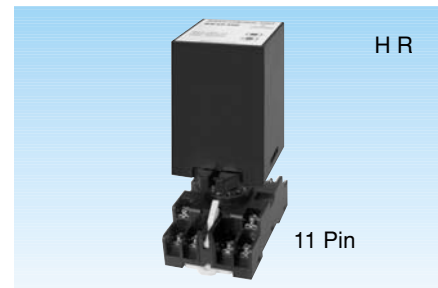

**SS 31** □

**SS 31 HR**

31: 單相 100~110V (Single Phase)  
32: 單相 200~220V (Single Phase)

31: 單相 100~110V (Single Phase)  
32: 單相 200~220V (Single Phase)

SS: 無段變速分離控制箱  
Stepless variable speed separate controller

R: 附電子剎車  
With electronic brake

SS: 無段變速分離控制箱  
Stepless variable speed separate controller

HR: 抗干擾型  
Anti-interference



# 單相IK型感應馬達

## Induction Motor (Single Phase)

### IK型連續運轉馬達特性表 Specifications of continuous operating motor

馬達型號 Motor Model No.		出力 Output (W)	周波數 Frequency (Hz)	電壓 Voltage (V)	電流 Current (A)	起動轉矩 Start Torque (gcm)	定格 Rating		起動電容 Start Condenser		齒輪型號 Gear Model No.		
圓柱形出力軸 Cylindrical Output Shaft	小齒切出力軸 Pinion Cut Output Shaft						轉矩 Torque (gcm)	回轉數 Revolving (rpm)	容量 Capacity (μF)	耐電壓 Resistance Voltage (WV)	培林軸承 Ball Bearing	含油軸承與培林共用型 Oil Bearing and Ball Bearing Combined	中間齒輪 Middle Gear
2IK6A - A	2IK6GN - A	6	50/60	100/110	0.21	420	420	1200/1450	2.5	250	2GN-□K	2GN-□	2GN-10X 2GN-10XK
2IK6A - C	2IK6GN - C	6	50/60	200/220	0.10	420	420	1200/1450	0.8	400			
3IK15A - A	3IK15GN - A	15	50/60	100/110	0.33	800	1100	1250/1550	4	250	3GN-□K	3GN-□	3GN-10X 3GN-10XK
3IK15A - C	3IK15GN - C	15	50/60	200/220	0.16	800	1100	1250/1550	1	400			
4IK25A - A	4IK25GN - A	25	50/60	100/110	0.60	1300	1800	1250/1550	6	250	4GN-□K	4GN-□	4GN-10X 4GN-10XK
4IK25A - C	4IK25GN - C	25	50/60	200/220	0.25	1300	1800	1250/1550	1.5	400			
5IK40A - A	5IK40GN - A	40	50/60	100/110	0.68	2300	3200	1300/1550	10	250	5GN-□K	5GN-□	5GN-10X 5GN-10XK
5IK40A - C	5IK40GN - C	40	50/60	200/220	0.31	2300	3200	1300/1550	2.5	400			
5IK60A - A	5IK60 <sup>GN</sup> <sub>GU</sub> - A	60	50/60	100/110	1.68	3300	4500	1300/1550	14	250	5GN-□K 5GU-□K 5GU-□KB	5GN-□	5GN-10X 5GN-10XK 5GU-10XK
5IK60A - C	5IK60 <sup>GN</sup> <sub>GU</sub> - C	60	50/60	200/220	0.55	3300	4500	1300/1550	3.5	400			
5IK90A - A	5IK90 <sup>GN</sup> <sub>GU</sub> - A	90	50/60	100/110	1.46	5200	6500	1300/1550	20	250			
5IK90A - C	5IK90 <sup>GN</sup> <sub>GU</sub> - C	90	50/60	200/220	0.63	5200	6500	1300/1550	5	400	5GN-□K 5GU-□K 5GU-□KB		5GN-10XK 5GU-10XK
5IK120A - A	5IK120 <sup>GN</sup> <sub>GU</sub> - A	120	50/60	100/110	2.10	6500	8990	1300/1550	25	250			
5IK120A - C	5IK120 <sup>GN</sup> <sub>GU</sub> - C	120	50/60	200/220	0.93	6500	8990	1300/1550	6	400			
5IK150A - A	5IK150 <sup>GN</sup> <sub>GU</sub> - A	150	50/60	100/110	2.78	7800	11240	1300/1550	28	250	5GN-□K 5GU-□K 5GU-□KB		5GN-10XK 5GU-10XK
5IK150A - C	5IK150 <sup>GN</sup> <sub>GU</sub> - C	150	50/60	200/220	1.35	7800	11240	1300/1600	8	400			

### 扭矩表 Gear Head-Torque Table (Kg·cm)

(Kg·cm) x 9.8 ÷ 100 = N·m

輸出回轉數 rpm	500	300	200	120	100	60	50	30	20	15	10	6	5	3	2	1.5	1
50Hz 減速比	3	5	7.5	12.5	15	25	30	50	75	100	150	250	300	500	750	1000	1500
60Hz Reduction Ratio	3	6	9	15	18	30	36	60	90	120	180	300	360	600	900	1200	1800
6W	1.0	1.6	2.5	4.1	5	8.1	9.7	16	23	25	25	25	25	25	25	25	25
15W	2.4	4.0	6.0	10	12	19	23	39	50	50	50	50	50	50	50	50	50
25W	4	6.7	10	16	20	32	39	65	80	80	80	80	80	80	80	80	80
40W	6.7	11	16	28	33	54	65	100	100	100	100	100	100	100	100	100	100
60W	10	16	24	40	48	77	93	155	200	200	200	200	200	200	200	200	200
90W	14	23	35	58	69	110	133	200	200	200	200	200	200	200	200	200	200
120W	19	30	47	77	92	147	177	200	200	200	200	200	200	200	200	200	200
150W	22	45	68	113	136	200	200	200	200	200	200	200	200	200	200	200	200

### 鍵尺寸 Key Dimensions

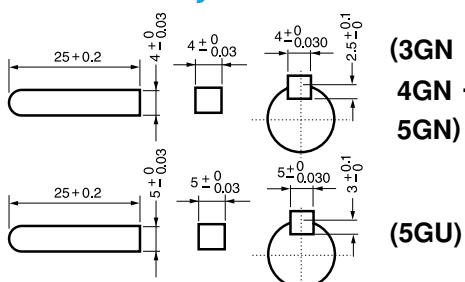

### 接線圖 Line Knotting Chart

(出線四條)

(出線三條)

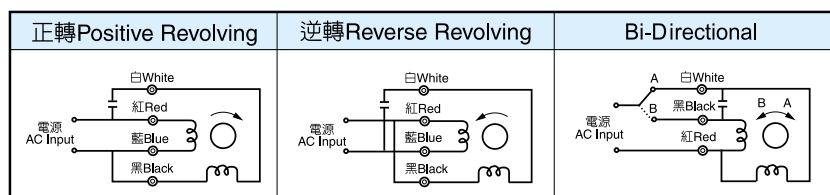

\*以上數值若有變動，恕不另行通知\* We reserve the right to change without further notice.

① 2IK6A(GN)-口 重量 0.7kg

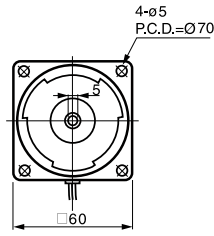
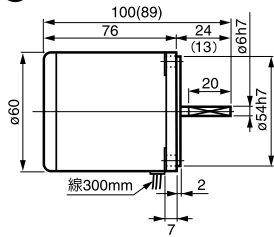

② 2GN-3~18 L=32 重量 0.35kg  
2GN-20~180 L=42 重量 0.45kg

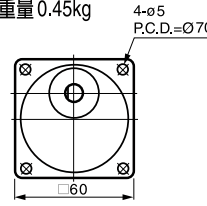
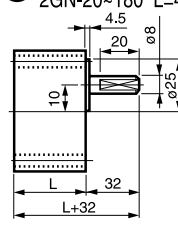

③ 2GN-10X 重量 0.3kg

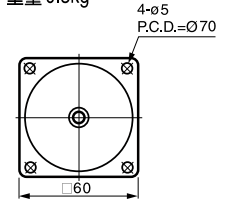
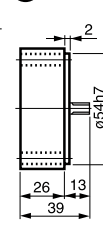

( ) 内數字係小齒輪軸馬達的數值 ( ) Numbers shown the dimension of the pinion shaft.

④ 3IK15A(GN)-口 重量 1.1kg

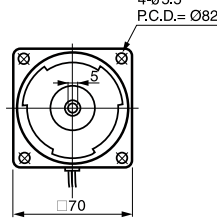
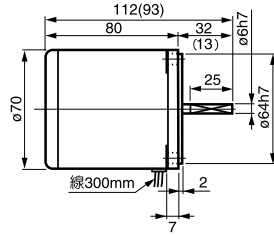

⑤ 3GN-3~18 L=32 重量 0.45kg  
3GN-20~180 L=42 重量 0.55kg

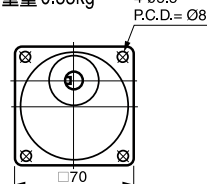
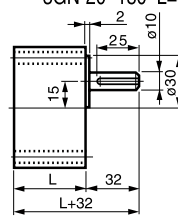

⑥ 3GN-10X 重量 0.35kg

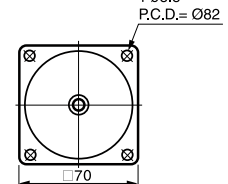
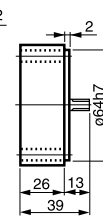

( ) 内數字係小齒輪軸馬達的數值 ( ) Numbers shown the dimension of the pinion shaft.

⑦ 4IK25A(GN)-口 重量 1.6kg

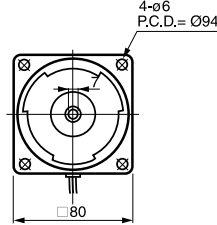
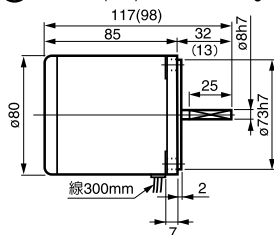

⑧ 4GN-3~18 L=35.5 重量 0.5kg  
4GN-20~180 L=49 重量 0.7kg

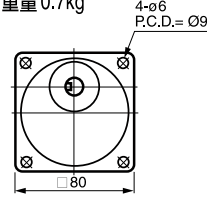
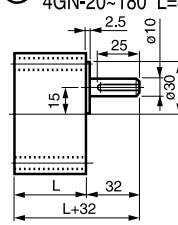

⑨ 4GN-10X 重量 0.45kg

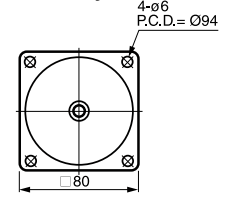
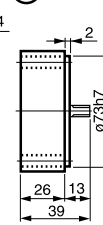

( ) 内數字係小齒輪軸馬達的數值 ( ) Numbers shown the dimension of the pinion shaft.

⑩ 5IK40A(GN)-口 重量 2.5kg

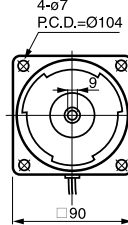
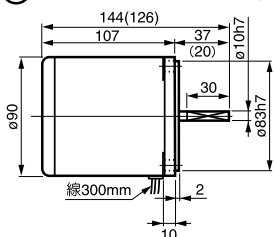

⑪ 5GN-3~18 L=42 重量 0.7kg (40~150W 共用)  
5GN-20~180 L=58 重量 1.05kg

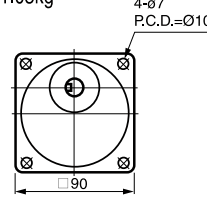
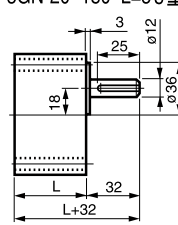

⑫ 5GN-10X 重量 0.6kg

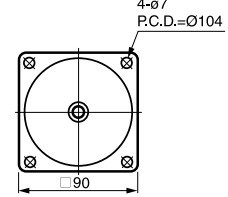
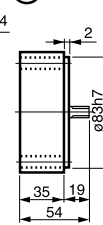

( ) 内數字係小齒輪軸馬達的數值 ( ) Numbers shown the dimension of the pinion shaft.

⑬ 5IK60 GN-口 重量 2.6kg  
GU

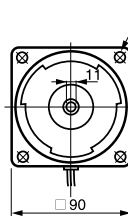
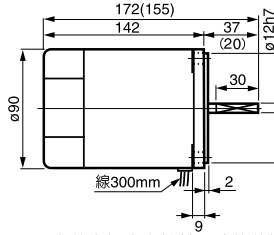

⑭ 5GU-3~180KB 重量 1.3kg (60, 90, 120, 150W 共用)

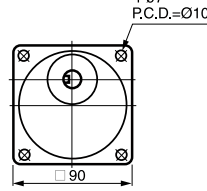
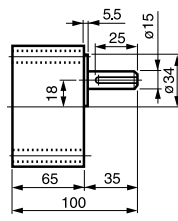

⑮ 5GU-10XK 重量 0.65kg  
適用螺絲: M6 x 140L

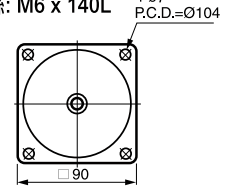
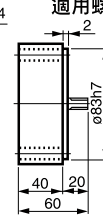

( ) 内數字係小齒輪軸馬達的數值 ( ) Numbers shown the dimension of the pinion shaft.

⑯ 5IK 120 GN-口 重量 3.4kg  
150 GU

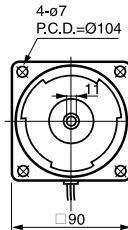
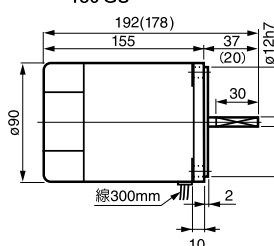

⑰ 5GU-3~180K 重量 1.3kg (60, 90, 120, 150W 共用)

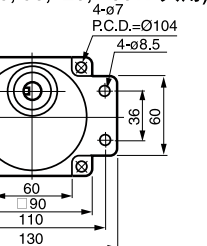
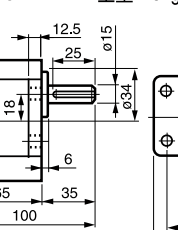

⑱ 5GU-10XKS 重量 0.65kg  
適用螺絲: M6 x 70L

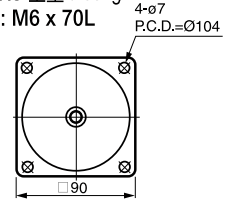
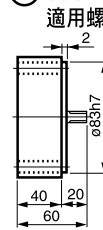

( ) 内數字係小齒輪軸馬達的數值 ( ) Numbers shown the dimension of the pinion shaft.

\*以上數值若有變動, 恕不另行通知\* We reserve the right to change without further notice.



13

## 三相IK型感應馬達 Induction Motor (3-Phase)

### IK型連續運轉馬達特性表 Specifications of continuous operating motor

馬達型號 Motor Model No.		出力 Output (W)	周波數 Frequency (Hz)	電壓 Voltage (V)	電流 Current (A)	起動轉矩 Start Torque (gcm)	定格 Rating		齒輪型號 Gear Model No.		
圓柱形出力軸 Cylindrical Output Shaft	小齒切出力軸 Pinion Cut Output Shaft						轉矩 Torque (gcm)	回轉數 Revolving (rpm)	培林軸承 Ball Bearing	含油軸承與培林共用型 Oil Bearing and Ball Bearing Combined	中間齒輪 Middle Gear
4IK25A - S <sub>2</sub>	4IK25GN - S <sub>2</sub>	25	50/60	200 220	0.18	4600 3600	1900 1800	1300 1550	4GN-□K	4GN-□	4GN-10X 4GN-10XK
4IK25A - S <sub>3</sub> S <sub>4</sub>	4IK25GN - S <sub>3</sub> S <sub>4</sub>	25	50/60	380 440	0.13	4600 3600	1900 1600	1300 1500			4GN-10X 4GN-10XK
5IK40A - S <sub>2</sub>	5IK40GN - S <sub>2</sub>	40	50/60	200 220	0.27	10000 8000	3000 2600	1300 1550	5GN-□K	5GN-□	5GN-10X 5GN-10XK
5IK40A - S <sub>3</sub> S <sub>4</sub>	5IK40GN - S <sub>3</sub> S <sub>4</sub>	40	50/60	380 440	0.18	10000 8000	3000 2600	1300 1550			5GN-10X 5GN-10XK
5IK60A - S <sub>2</sub>	5IK60 <sup>GN</sup> <sub>GU</sub> - S <sub>2</sub>	60	50/60	200 220	0.47	13000 9000	4500 3800	1300 1550	5GN-□K	5GN-□	5GN-10X 5GN-10XK
5IK60A - S <sub>3</sub> S <sub>4</sub>	5IK60 <sup>GN</sup> <sub>GU</sub> - S <sub>3</sub> S <sub>4</sub>	60	50/60	380 440	0.33	13000 9000	4500 3800	1300 1550	5GU-□K 5GU-□KB		5GN-10X 5GU-10XK
5IK90A - S <sub>2</sub>	5IK90 <sup>GN</sup> <sub>GU</sub> - S <sub>2</sub>	90	50/60	200 220	0.70	18000 13000	6800 5700	1300 1550	5GN-□K	5GN-□	5GN-10X 5GU-10XK
5IK90A - S <sub>3</sub> S <sub>4</sub>	5IK90 <sup>GN</sup> <sub>GU</sub> - S <sub>3</sub> S <sub>4</sub>	90	50/60	380 440	0.56	18000 13000	6800 5700	1300 1550	5GU-□K 5GU-□KB		5GN-10X 5GU-10XK
5IK120A - S <sub>2</sub>	5IK120 <sup>GN</sup> <sub>GU</sub> - S <sub>2</sub>	120	50/60	200 220	1.28	41000 32000	8650 7100	1350 1650	5GN-□K	5GN-□	5GN-10X 5GU-10XK
5IK120A - S <sub>3</sub> S <sub>4</sub>	5IK120 <sup>GN</sup> <sub>GU</sub> - S <sub>3</sub> S <sub>4</sub>	120	50/60	380 440	0.70	41000 32000	8650 7100	1350 1650	5GU-□K 5GU-□KB		5GN-10X 5GU-10XK
5IK150A - S <sub>2</sub>	5IK150 <sup>GN</sup> <sub>GU</sub> - S <sub>2</sub>	150	50/60	200 220	1.60	41000 32000	11300 9450	1350 1650	5GN-□K	5GN-□	5GN-10X 5GU-10XK
5IK150A - S <sub>3</sub> S <sub>4</sub>	5IK150 <sup>GN</sup> <sub>GU</sub> - S <sub>3</sub> S <sub>4</sub>	150	50/60	380 440	0.88	41000 32000	11300 9450	1350 1650	5GU-□K 5GU-□KB		5GN-10X 5GU-10XK

### 扭矩表 Gear Head-Torque Table (Kg·cm)

(Kg·cm) x 9.8 ÷ 100 = N·m

輸出回轉數 rpm	500	300	200	120	100	60	50	30	20	15	10	6	5	3	2	1.5	1
50Hz 減速比	3	5	7.5	12.5	15	25	30	50	75	100	150	250	300	500	750	1000	1500
60Hz Reduction Ratio	3	6	9	15	18	30	36	60	90	120	180	300	360	600	900	1200	1800
25W	4	6.7	10	16	20	32	39	65	80	80	80	80	80	80	80	80	80
40W	6.7	11	16	28	33	54	65	100	100	100	100	100	100	100	100	100	100
60W	10	16	24	40	48	77	93	155	200	200	200	200	200	200	200	200	200
90W	14	23	35	58	69	110	133	200	200	200	200	200	200	200	200	200	200
120W	19	30	47	77	92	147	177	200	200	200	200	200	200	200	200	200	200
150W	22	45	68	113	136	200	200	200	200	200	200	200	200	200	200	200	200

### 鍵尺寸 Key Dimensions

(3GN · 4GN · 5GN)

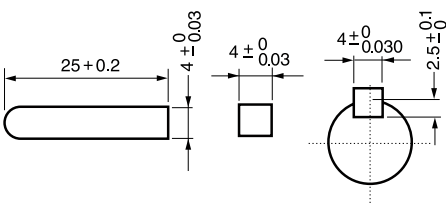

(5GU)

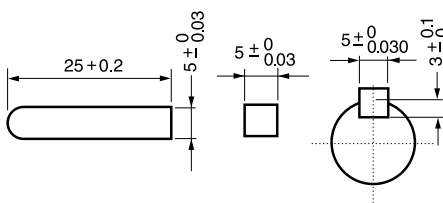

### 接線圖

Line Knotting Chart

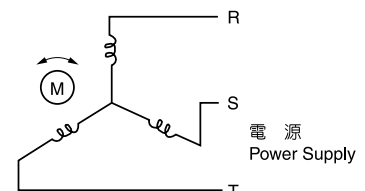

\*以上數值若有變動，恕不另行通知\* We reserve the right to change without further notice.







# 單相RK型頻繁啟動(定格)馬達 Reversible Motor (Single Phase) (for Bi-Directional Operation or Instantaneous Reversal of Direction)

## RK型30分定格馬達特性表 Specifications of RK Type 30-minutes rated motor

馬達型號 Motor Model No.		出力 Output (W)	周波數 Frequency (Hz)	電壓 Voltage (V)	電流 Current (A)	起動轉矩 Start Torque (gcm)	定格 Rating			起動電容 Start Condenser		齒輪型號 Gear Model No.		
圓柱形出力軸 Cylindrical Output Shaft	小齒切出力軸 Pinion Cut Output Shaft						轉矩 Torque (gcm)	回轉數 Revolving (rpm)	容量 Capacity ( $\mu$ F)	耐電壓 Resistance Voltage (WV)	培林軸承 Ball Bearing	含油軸承與 培林共用型 Oil Bearing and Ball Bearing Combined	中間齒輪 Middle Gear	
2RK6A - A	2RK6GN - A	6	50/60	100 110	0.23	500 450	500 400	1200 1550	3	250	2GN-□ K	2GN-□	2GN-10X 2GN-10XK	
2RK6A - C	2RK6GN - C	6	50/60	200 220	0.12	500 450	500 400	1200 1500	1	400				
3RK15A - A	3RK15GN - A	15	50/60	100 110	0.36	900 800	1250 1000	1200 1500	6	250	3GN-□ K	3GN-□	3GN-10X 3GN-10XK	
3RK15A - C	3RK15GN - C	15	50/60	200 220	0.18	900 800	1200 1000	1200 1500	1.5	400				
4RK25A - A	4RK25GN - A	25	50/60	100 110	0.65	1600 1400	2000 1700	1250 1500	8	250	4GN-□ K	4GN-□	4GN-10X 4GN-10XK	
4RK25A - C	4RK25GN - C	25	50/60	200 220	0.27	1600 1400	2000 1600	1250 1550	2	400				
5RK40A - A	5RK40GN - A	40	50/60	100 110	0.73	3000 2600	3000 2600	1300 1550	12	250	5GN-□ K	5GN-□	5GN-10X 5GN-10XK	
5RK40A - C	5RK40GN - C	40	50/60	200 220	0.34	3000 2600	3000 2600	1300 1550	3	400				
5RK60A - A	5RK60 <sup>GN</sup> <sub>GU</sub> - A	60	50/60	100 110	1.75	4700 3800	4700 3800	1250 1550	16	250	5GN-□ K 5GU-□ K 5GU-□ KB	5GN-□	5GN-10X 5GN-10XK 5GU-10XK	
5RK60A - C	5RK60 <sup>GN</sup> <sub>GU</sub> - C	60	50/60	200 220	0.60	4700 3800	4700 3800	1250 1550	4	400				
5RK90A - A	5RK90 <sup>GN</sup> <sub>GU</sub> - A	90	50/60	100 110	1.60	6300 5900	7300 5900	1200 1550	25	250	5GN-□ K 5GU-□ K 5GU-□ KB		5GN-10XK 5GU-10XK	
5RK90A - C	5RK90 <sup>GN</sup> <sub>GU</sub> - C	90	50/60	200 220	0.69	6300 5900	7300 5900	1200 1500	6	400				
5RK120A - A	5RK120 <sup>GN</sup> <sub>GU</sub> - A	120	50/60	100 110	2.25	6500 5800	8990 7300	1200 1550	28	250	5GN-□ K 5GU-□ K 5GU-□ KB		5GN-10XK 5GU-10XK	
5RK120A - C	5RK120 <sup>GN</sup> <sub>GU</sub> - C	120	50/60	200 220	1.03	6500 5800	8990 7300	1200 1550	8	400				
5RK150A - A	5RK150 <sup>GN</sup> <sub>GU</sub> - A	150	50/60	100 110	2.91	7800	11240	1300 1600	28	250	5GN-□ K 5GU-□ K 5GU-□ KB		5GN-10XK 5GU-10XK	
5RK150A - C	5RK150 <sup>GN</sup> <sub>GU</sub> - C	150	50/60	200 220	1.55	7800	11240	1300 1600	8	400				

## 扭矩表 Gear Head-Torque Table (Kg-cm)

(Kg-cm) x 9.8 ÷ 100 = N·m

輸出回轉數 rpm	500	300	200	120	100	60	50	30	20	15	10	6	5	3	2	1.5	1
50Hz 減速比		5	7.5	12.5	15	25	30	50	75	100	150	250	300	500	750	1000	1500
60Hz Reduction Ratio	3	6	9	15	18	30	36	60	90	120	180	300	360	600	900	1200	1800
6W	1.0	1.6	2.5	4.1	5	8.1	9.7	16	23	25	25	25	25	25	25	25	25
15W	2.4	4.0	6.0	10	12	19	23	39	50	50	50	50	50	50	50	50	50
25W	4	6.7	10	16	20	32	39	65	80	80	80	80	80	80	80	80	80
40W	6.7	11	16	28	33	54	65	100	100	100	100	100	100	100	100	100	100
60W	10	16	24	40	48	77	93	155	200	200	200	200	200	200	200	200	200
90W	14	23	35	58	69	110	133	200	200	200	200	200	200	200	200	200	200
120W	19	30	47	77	92	147	177	200	200	200	200	200	200	200	200	200	200
150W	22	45	68	113	136	200	200	200	200	200	200	200	200	200	200	200	200

## 鍵尺寸 Key Dimensions

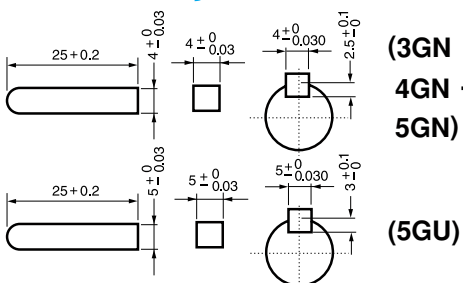

## 接線圖 Line Knotting Chart

(出線四條)

(出線三條)

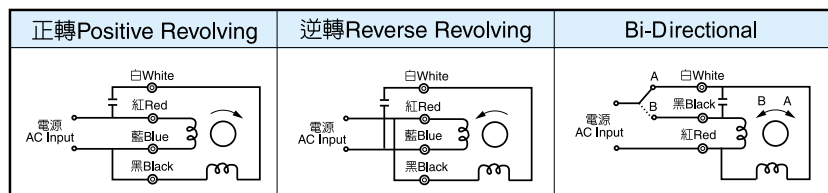

\*以上數值若有變動，恕不另行通知\* We reserve the right to change without further notice.

① 2RK6A(GN)-□ 重量 0.8kg

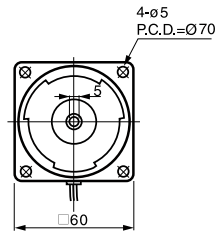
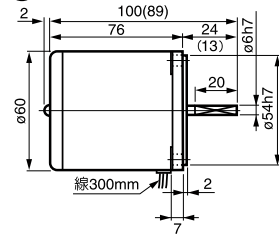

② 2GN-3-18 L=32 重量 0.35kg  
2GN-20-180 L=42 重量 0.45kg

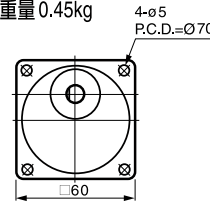
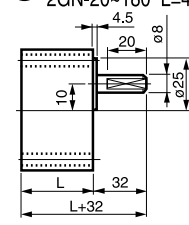

③ 2GN-10X 重量 0.3kg

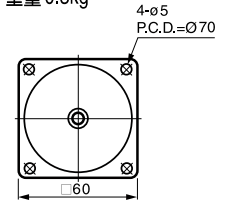
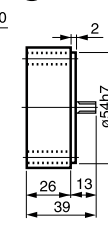

( )内數字係小齒輪軸馬達的數值 ( ) Numbers shown the dimension of the pinion shaft.

④ 3RK15A(GN)-□ 重量 1.2kg

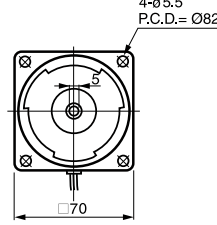
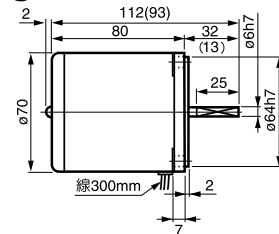

⑤ 3GN-3-18 L=32 重量 0.45kg  
3GN-20-180 L=42 重量 0.55kg

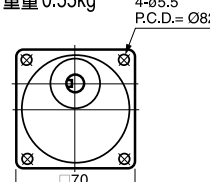
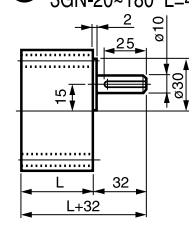

⑥ 3GN-10X 重量 0.35kg

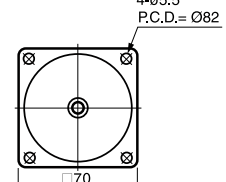
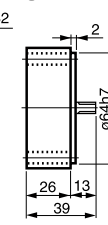

( )内數字係小齒輪軸馬達的數值 ( ) Numbers shown the dimension of the pinion shaft.

⑦ 4RK25A(GN)-□ 重量 1.65kg

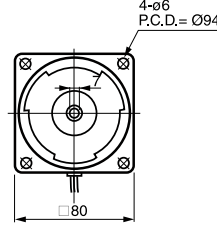
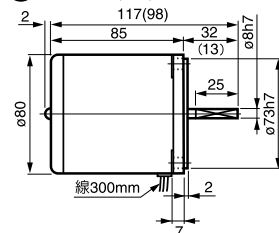

⑧ 4GN-3-18 L=35.5 重量 0.5kg  
4GN-20-180 L=49 重量 0.7kg

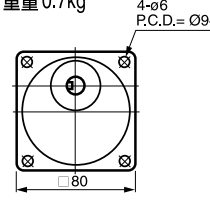
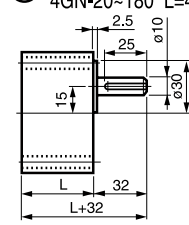

⑨ 4GN-10X 重量 0.45kg

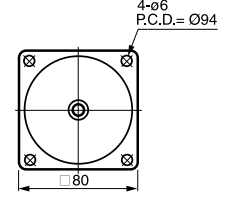
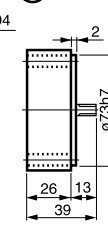

( )内數字係小齒輪軸馬達的數值 ( ) Numbers shown the dimension of the pinion shaft.

⑩ 5RK40A(GN)-□ 重量 2.5kg

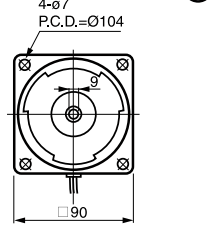
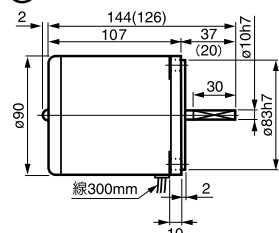

⑪ 5GN-3-18 L=42 重量 0.7kg (40~150W 共用)  
5GN-20-180 L=58 重量 1.05kg

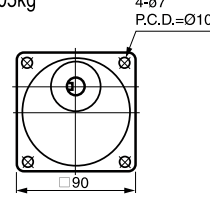
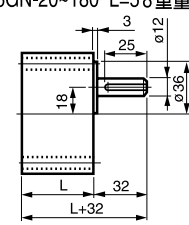

⑫ 5GN-10X 重量 0.6kg

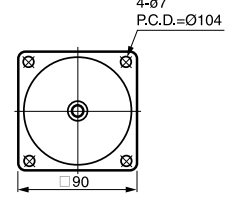
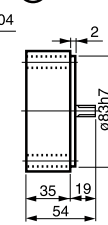

( )内數字係小齒輪軸馬達的數值 ( ) Numbers shown the dimension of the pinion shaft.

⑬ 5RK60 GN-□ 重量 2.6kg

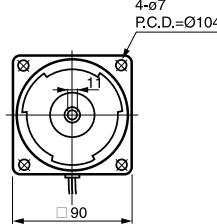
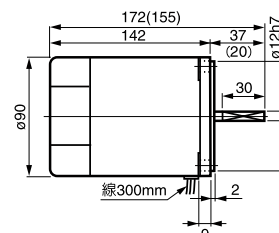

⑭ 5GU-3-180 KB 重量 1.3kg (60, 90, 120, 150W 共用)

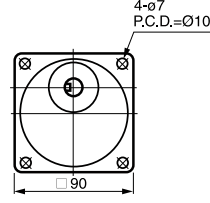
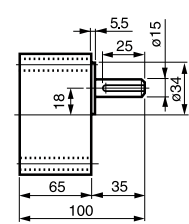

⑮ 5GU-10XK 重量 0.65kg  
適用螺絲: M6 x 140L

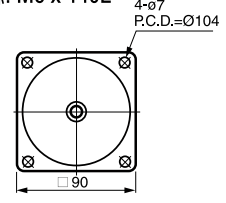
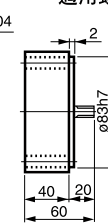

( )内數字係小齒輪軸馬達的數值 ( ) Numbers shown the dimension of the pinion shaft.

⑯ 5RK 120 GN-□ 重量 3.4kg

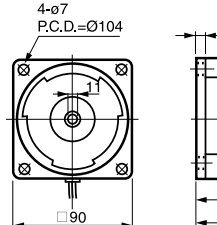
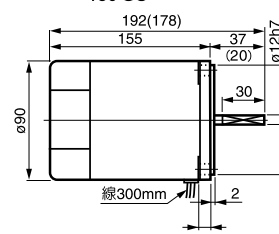

⑰ 5GU-3-180 K 重量 1.3kg (60, 90, 120, 150W 共用)

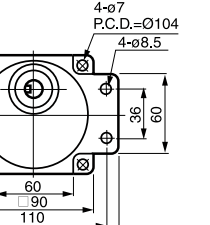
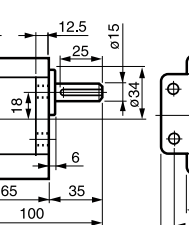

⑱ 5GU-10XKS 重量 0.65kg  
適用螺絲: M6 x 70L

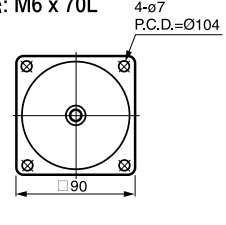
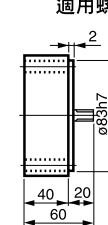

( )内數字係小齒輪軸馬達的數值 ( ) Numbers shown the dimension of the pinion shaft.



# 單相附電磁剎車馬達

## Electromagnetic Brake Motor (Single Phase)

### IK-B型電磁剎車馬達特性表 Specifications of IKB Type Motor

馬達型號 Motor Model No.		出力 Output (W)	周波數 Frequency (Hz)	電壓 Voltage (V)	電流 Current (A)	起動轉矩 Start Torque (gcm)	定格 Rating		起動電容 Start Condenser		齒輪型號 Gear Model No.		
圓柱形出力軸 Cylindrical Output Shaft	小齒切出力軸 Pinion Cut Output Shaft						轉矩 Torque (gcm)	回轉數 Revolving (rpm)	容量 Capacity (μF)	耐電壓 Resistance Voltage (WV)	培林軸承 Ball Bearing	含油軸承與培林共用型 Oil Bearing and Ball Bearing Combined	中間齒輪 Middle Gear
2 IK6A - AB	2 IK6GN - AB	6	50/60	100/110	0.21	500/400	420	1200/1450	2.5	250	2GN-□ K	2GN-□	2GN-10X 2GN-10XK
2 IK6A - CB	2 IK6GN - CB	6	50/60	200/220	0.10	500/400	420	1200/1450	0.8	400			
3 IK15A - AB	3 IK15GN - AB	15	50/60	100/110	0.33	900/850	800	1250/1550	4	250	3GN-□ K	3GN-□	3GN-10X 3GN-10XK
3 IK15A - CB	3 IK15GN - CB	15	50/60	200/220	0.16	900/850	800	1250/1550	1	400			
4 IK25A - AB	4 IK25GN - AB	25	50/60	100/110	0.60	1600/1500	1300	1250/1550	6	250	4GN-□ K	4GN-□	4GN-10X 4GN-10XK
4 IK25A - CB	4 IK25GN - CB	25	50/60	200/220	0.25	1600/1500	1300	1250/1550	1.5	400			
5 IK40A - AB	5 IK40GN - AB	40	50/60	100/110	0.68	3000/2600	2300	1300/1550	10	250	5GN-□ K	5GN-□	5GN-10X 5GN-10XK
5 IK40A - CB	5 IK40GN - CB	40	50/60	200/220	0.31	2700/2600	2300	1300/1550	2.5	400			
5 IK60A - AB	5IK60 <sup>GN</sup> <sub>GU</sub> - AB	60	50/60	100/110	1.68	3200/3000	3300	1300/1550	14	250	5GN-□ K 5GU-□ K 5GU-□ KB	5GN-□	5GN-10X 5GN-10XK 5GU-10XK
5 IK60A - CB	5IK60 <sup>GN</sup> <sub>GU</sub> - CB	60	50/60	200/220	0.55	3200/3000	3300	1300/1550	3.5	400			
5 IK90A - AB	5IK90 <sup>GN</sup> <sub>GU</sub> - AB	90	50/60	100/110	1.46	4500	5200	1300/1550	20	250	5GN-□ K 5GU-□ K 5GU-□ KB		5GN-10XK 5GU-10XK
5 IK90A - CB	5IK90 <sup>GN</sup> <sub>GU</sub> - CB	90	50/60	200/220	0.63	4500	5200	1300/1550	5	400			
5 IK120A - AB	5IK120 <sup>GN</sup> <sub>GU</sub> - AB	120	50/60	100/110	2.10	6500/5800	8990	1300/1600	25	250	5GN-□ K 5GU-□ K 5GU-□ KB		5GN-10XK 5GU-10XK
5 IK120A - CB	5IK120 <sup>GN</sup> <sub>GU</sub> - CB	120	50/60	200/220	0.93	6500/5800	8990	1300/1600	6	400			
5 IK150A - AB	5IK150 <sup>GN</sup> <sub>GU</sub> - AB	150	50/60	100/110	2.78	7800	11240	1300/1600	28	250	5GN-□ K 5GU-□ K 5GU-□ KB		5GN-10XK 5GU-10XK
5 IK150A - CB	5IK150 <sup>GN</sup> <sub>GU</sub> - CB	150	50/60	200/220	1.35	7800	11240	1300/1600	8	400			

### 扭矩表 Gear Head-Torque Table (Kg·cm)

(Kg·cm) x 9.8 ÷ 100 = N·m

輸出回轉數 rpm	500	300	200	120	100	60	50	30	20	15	10	6	5	3	2	1.5	1
50Hz 減速比	3	5	7.5	12.5	15	25	30	50	75	100	150	250	300	500	750	1000	1500
60Hz Reduction Ratio		6	9	15	18	30	36	60	90	120	180	300	360	600	900	1200	1800
6W	1.0	1.6	2.5	4.1	5	8.1	9.7	16	23	25	25	25	25	25	25	25	25
15W	2.4	4.0	6.0	10	12	19	23	39	50	50	50	50	50	50	50	50	50
25W	4	6.7	10	16	20	32	39	65	80	80	80	80	80	80	80	80	80
40W	6.7	11	16	28	33	54	65	100	100	100	100	100	100	100	100	100	100
60W	10	16	24	40	48	77	93	155	200	200	200	200	200	200	200	200	200
90W	14	23	35	58	69	110	133	200	200	200	200	200	200	200	200	200	200
120W	19	30	47	77	92	147	177	200	200	200	200	200	200	200	200	200	200
150W	22	45	68	113	136	200	200	200	200	200	200	200	200	200	200	200	200

### 鍵尺寸 Key Dimensions

(3GN · 4GN · 5GN)

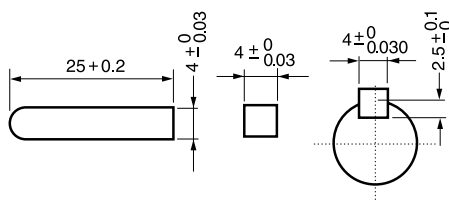

(5GU)

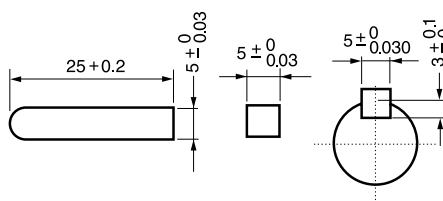

### 接線圖

#### Line Knotting Chart

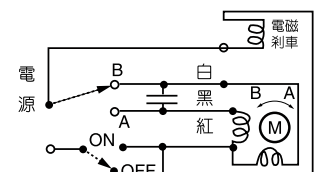

\*以上數值若有變動，恕不另行通知\* We reserve the right to change without further notice.

① 2IK6A(GN)-□B 重量 1.2kg

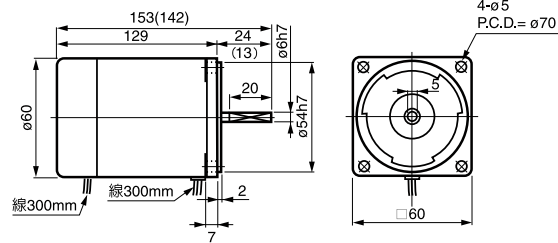

② 2GN-3~18 L=32 重量 0.35kg  
2GN-20~180 L=42 重量 0.45kg

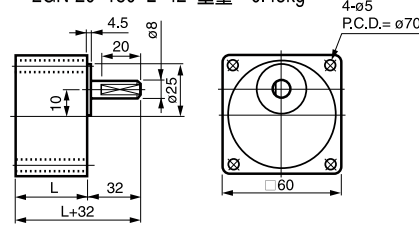

③ 2GN-10X 重量 0.3kg

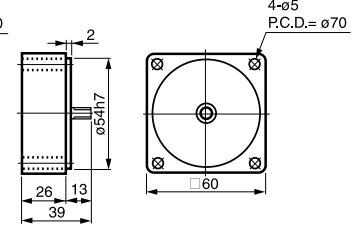

( )内數字係小齒輪軸馬達的數值 ( ) Numbers shown the dimension of the pinion shaft.

④ 3IK15A(GN)-□B 重量 1.6kg

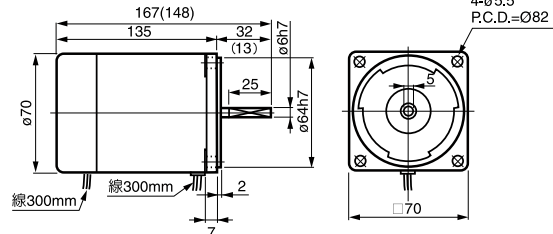

⑤ 3GN-3~18 L=32 重量 0.45kg  
3GN-20~180 L=42 重量 0.55kg

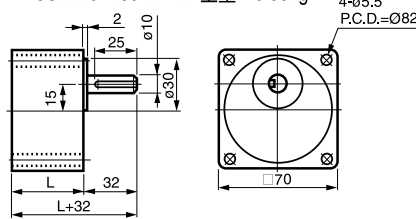

⑥ 3GN-10X 重量 0.35kg

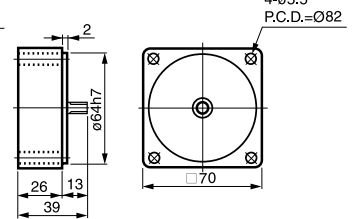

( )内數字係小齒輪軸馬達的數值 ( ) Numbers shown the dimension of the pinion shaft.

⑦ 4IK25A(GN)-□B 重量 2kg

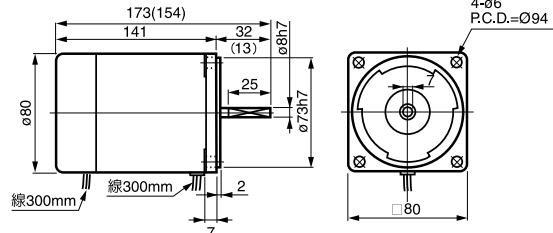

⑧ 4GN-3~18 L=35.5 重量 0.5kg  
4GN-20~180 L=49 重量 0.7kg

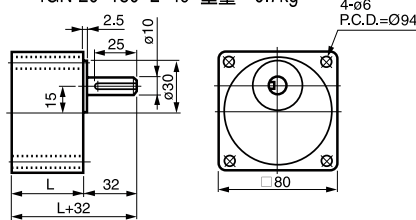

⑨ 4GN-10X 重量 0.45kg

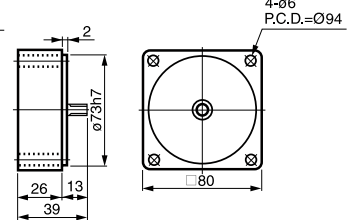

( )内數字係小齒輪軸馬達的數值 ( ) Numbers shown the dimension of the pinion shaft.

⑩ 5IK40A(GN)-□B 重量 3kg

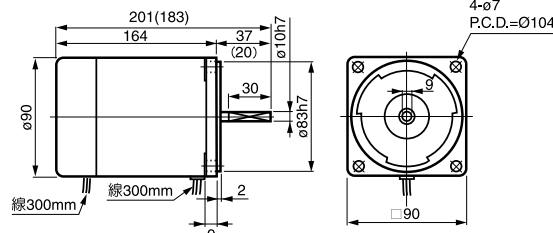

⑪ 5GN-3~18 L=42 重量 0.7kg (40~150W 共用)  
5GN-20~180 L=58 重量 1.05kg

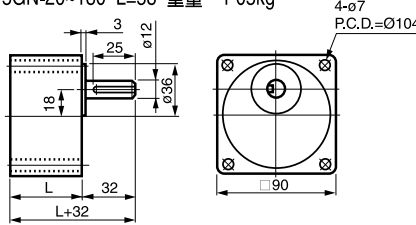

⑫ 5GN-10X 重量 0.6kg

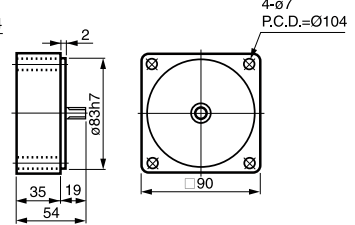

( )内數字係小齒輪軸馬達的數值 ( ) Numbers shown the dimension of the pinion shaft.

⑬ 5IK60 GN - □ GU 重量 3.1kg

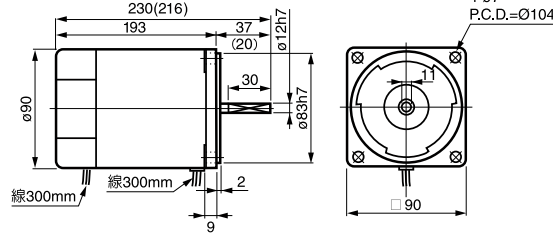

⑭ 5GU-3~180KB 重量 1.3kg (60, 90, 120, 150W 共用)

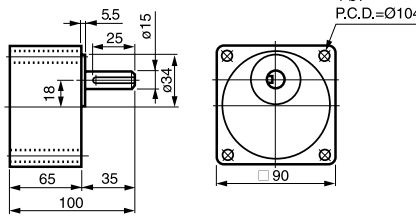

⑮ 5GU-10XK 重量 0.65kg  
適用螺絲: M6 x 140L

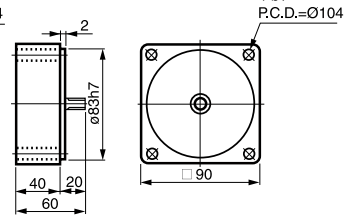

( )内數字係小齒輪軸馬達的數值 ( ) Numbers shown the dimension of the pinion shaft.

⑯ 5IK 120 GN - □ 150 GU 重量 4kg

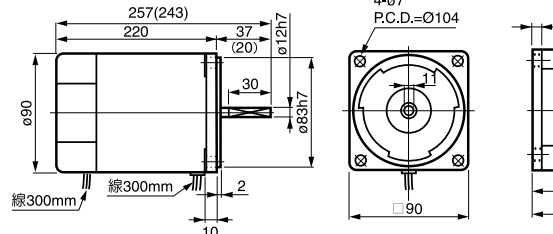

⑰ 5GU-3~180K 重量 1.3kg (60, 90, 120, 150W 共用)

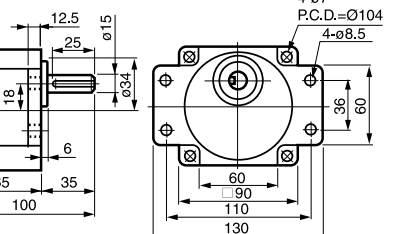

⑱ 5GU-10XKS 重量 0.65kg  
適用螺絲: M6 x 70L

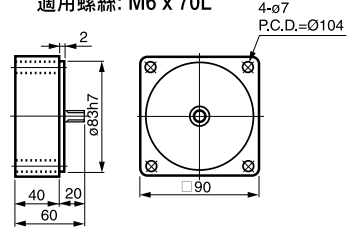

( )内數字係小齒輪軸馬達的數值 ( ) Numbers shown the dimension of the pinion shaft.

\*以上數值若有變動, 恕不另行通知\* We reserve the right to change without further notice.







# 三相附電磁剎車馬達 Electromagnetic Brake Motor (3-Phase)

## ■ 三相 IK-B附電磁剎車馬達特性表 Specifications of IKB Type Motor(3-Phase)

馬達型號 Motor Model No.		出力 Output (W)	周波數 Frequency (Hz)	電壓 Voltage (V)	電流 Current (A)	起動轉矩 Start Torque (gcm)	定格 Rating			齒輪型號 Gear Model No.		
圓柱形出力軸 Cylindrical Output Shaft	小齒切出力軸 Pinion Cut Output Shaft						轉矩 Torque (gcm)	回轉數 Revolving (rpm)	培林軸承 Ball Bearing	含油軸承與培林共用型 Oil Bearing and Ball Bearing Combined	中間齒輪 Middle Gear	
4IK25A - S.B	4IK25GN - S.B	25	50/60	200	0.18	4600	1900	1300	4GN-□ K	4GN-□	4GN-10X 4GN-10XK	
				220		3600	1600	1550				
4IK25A - S.B	4IK25GN - S.B	25	50/60	380	0.13	4600	1900	1300	4GN-□ K	4GN-□	4GN-10X 4GN-10XK	
				440		3600	1600	1550				
5IK40A - S.B	5IK40GN - S.B	40	50/60	200	0.27	10000	3000	1300	5GN-□ K	5GN-□	5GN-10X 5GN-10XK	
				220		8000	2600	1550				
5IK40A - S.B	5IK40GN - S.B	40	50/60	380	0.18	10000	3000	1300	5GN-□ K	5GN-□	5GN-10X 5GN-10XK	
				440		8000	2600	1550				
5IK60A - S.B	5IK60 <sup>GN</sup> <sub>GU</sub> - S.B	60	50/60	200	0.47	13000	4500	1300	5GN-□ K	5GN-□	5GN-10X 5GN-10XK	
				220		9000	3800	1550				
5IK60A - S.B	5IK60 <sup>GN</sup> <sub>GU</sub> - S.B	60	50/60	380	0.33	13000	4500	1300	5GU-□ K	5GN-□	5GN-10X 5GN-10XK	
				440		9000	3800	1550				
5IK90A - S.B	5IK90 <sup>GN</sup> <sub>GU</sub> - S.B	90	50/60	200	0.70	18000	6800	1300	5GN-□ K	5GN-□	5GN-10X 5GN-10XK	
				220		13000	5700	1550				
5IK90A - S.B	5IK90 <sup>GN</sup> <sub>GU</sub> - S.B	90	50/60	380	0.56	18000	6800	1300	5GU-□ K	5GN-□	5GN-10X 5GN-10XK	
				440		13000	5700	1550				
5IK120A - S.B	5IK120 <sup>GN</sup> <sub>GU</sub> - S.B	120	50/60	200	1.28	41000	8650	1350	5GN-□ K	5GN-□	5GN-10X 5GN-10XK	
				220		32000	7100	1650				
5IK120A - S.B	5IK120 <sup>GN</sup> <sub>GU</sub> - S.B	120	50/60	380	0.70	41000	8650	1350	5GU-□ K	5GN-□	5GN-10X 5GN-10XK	
				440		32000	7100	1650				
5IK150A - S.B	5IK150 <sup>GN</sup> <sub>GU</sub> - S.B	150	50/60	200	0.60	41000	11300	1350	5GN-□ K	5GN-□	5GN-10X 5GN-10XK	
				220		32000	9450	1650				
5IK150A - S.B	5IK150 <sup>GN</sup> <sub>GU</sub> - S.B	150	50/60	380	0.88	41000	11300	1350	5GU-□ K	5GN-□	5GN-10X 5GN-10XK	
				440		32000	9450	1650				

## ■ 扭矩表 Gear Head-Torque Table (Kg·cm)

(Kg·cm) x 9.8 ÷ 100 = N·m

輸出回轉數 rpm	500	300	200	120	100	60	50	30	20	15	10	6	5	3	2	1.5	1
50Hz 減速比	3	5	7.5	12.5	15	25	30	50	75	100	150	250	300	500	750	1000	1500
60Hz Reduction Ratio		6	9	15	18	30	36	60	90	120	180	300	360	600	900	1200	1800
25W	4	6.7	10	16	20	32	39	65	80	80	80	80	80	80	80	80	80
40W	6.7	11	16	28	33	54	65	100	100	100	100	100	100	100	100	100	100
60W	10	16	24	40	48	77	93	155	200	200	200	200	200	200	200	200	200
90W	14	23	35	58	69	110	133	200	200	200	200	200	200	200	200	200	200
120W	19	30	47	77	92	147	177	200	200	200	200	200	200	200	200	200	200
150W	22	45	68	113	136	200	200	200	200	200	200	200	200	200	200	200	200

## ■ 鍵尺寸 Key Dimensions

(3GN · 4GN · 5GN)

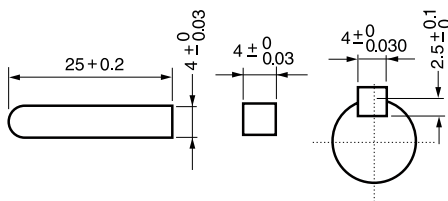

(5GU)

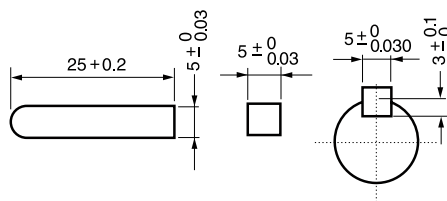

## ■ 接線圖 Line Knotting Chart

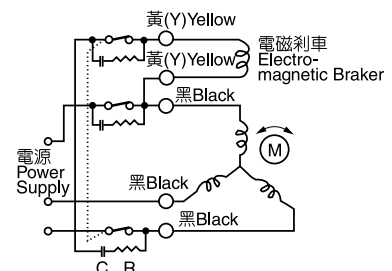

\*以上數值若有變動，恕不另行通知\* We reserve the right to change without further notice.





# 單相交流無段變速馬達

## Stepless Variable Speed Control Motor (Single Phase)

### US型馬達特性表 Specifications of US Type Motor(Single-Phase)

馬達 型號 Motor Model No.		最大 出力 Output (W)	電壓 Voltage (V)	周波數 Frequency (Hz)	極數 Pole (P)	可變速度範圍 Variable Speed Range		容許轉矩 Torque (gcm)		起動轉矩 Starting Torque (gcm)	電流 Current (A)	消耗電力 Consumed Power (W)	起動電容器 Condenser	
圓出力軸 Cylindrical Output Shaft	斜齒出力軸 Pinion Cut Output Shaft					回轉數 Revolving (rpm)	比 (Ratio)	設定回轉數 Set Revolving No.					容量 Capacity ( $\mu$ F)	耐電壓 Resistance Voltage (WV)
		1200rpm	90rpm											
M206-001	M206-401	6	100 110	50 60	4	90~1400 90~1700	1:15	460 250	330	0.21	23	2.5	250	
M206-002	M206-402	6	200 220	50 60	4	90~1400 90~1700	1:15	460 250	330	0.10	23	0.8	400	
M315-001	M315-401	15	100 110	50 60	4	90~1400 90~1700	1:15	880 660	550	0.33	40	4	250	
M315-002	M315-402	15	200 220	50 60	4	90~1400 90~1700	1:15	880 660	550	0.16	40	1	400	
M425-001	M425-401	25	100 110	50 60	4	90~1400 90~1700	1:15	1760 1400	1200	0.60	60	6	250	
M425-002	M425-402	25	200 220	50 60	4	90~1400 90~1700	1:15	1760 1400	1200	0.25	60	1.5	400	
M540-001	M540-401	40	100 110	50 60	4	90~1400 90~1700	1:15	2800 1800	1900	0.68	90	10	250	
M540-002	M540-402	40	200 220	50 60	4	90~1400 90~1700	1:15	2800 1800	1900	0.31	90	2.5	400	
M560-001	M560-401 M560-501	60	100 110	50 60	4	90~1400 90~1700	1:15	5000 3500	3000	1.68	150	14	250	
M560-002	M560-402 M560-502	60	200 220	50 60	4	90~1400 90~1700	1:15	5000 3500	3000	0.55	150	3.5	400	
M590-001	M590-401 M590-501	90	100 110	50 60	4	90~1400 90~1700	1:15	6600 5300	4500	1.46	200	20	250	
M590-002	M590-402 M590-502	90	200 220	50 60	4	90~1400 90~1700	1:15	6600 5300	4500	0.63	200	5	400	
M5120-001	M5120-401 M5120-501	120	100 110	50 60	4	90~1400 90~1700	1:15	8500 7000	6500	2.10	230	25	250	
M5120-002	M5120-402 M5120-502	120	200 220	50 60	4	90~1400 90~1700	1:15	8500 7000	6500	0.93	230	6	400	

### 扭矩表 Gear Head-Torque Table (Kg-cm)

$$(\text{Kg}\cdot\text{cm}) \times 9.8 \div 100 = \text{N}\cdot\text{m}$$

變化轉速範圍 (轉分) Variable Speed Range (rpm)	M206-001, -201-401 M206-002, -202-402		M315-001, -201-401 M315-002, -202-402		M425-001, -201-401 M425-002, -202-402		M540-001, -201-401 M540-002, -202-402		M560-001, -401-501 M560-002, -402-502		M590-001, -401-501 M590-002, -402-502	
	扭矩 Torque	減速比 Gear Ratio	扭矩 Torque	減速比 Gear Ratio	扭矩 Torque	減速比 Gear Ratio	扭矩 Torque	減速比 Gear Ratio	扭矩 Torque	減速比 Gear Ratio	扭矩 Torque	減速比 Gear Ratio
90~1700	0.3~0.5		0.45~1.2		0.6~1.8		0.8~2.5		1.0~3		1.6~5	
15~283	1.5~2.4	2GN-6	2.4~7	3GN-6	2.9~8.8	4GN-6	3.9~12	5GN-6	4.6~15	5GU-6K	8~24	5GU-6K
5~94.4	4.4~7.3	2GN-18	6.5~18	3GN-18	8.8~26	4GN-18	12~37	5GN-18	16~50	5GU-18K	45~75	5GU-18K
1.5~28.3	12~20	2GN-60	16~	3GN-60	24~71	4GN-60	32~100	5GN-60	45~120	5GU-60K	64~150	5GU-60K
1~18.8	18~25	2GN-90	25~70	3GN-90	36~80	4GN-90	48~100	5GN-90	60~125	5GU-90K	95~180	5GU-90K
0.5~9.4	25	2GN-180	70	3GN-180	80	4GN-180	90~100	5GN-180	100~125	5GU-180K	150~180	5GU-180K

### US控制箱尺寸與配線圖 US Panel-Mount Control Unit Dimension and Knotting Chart

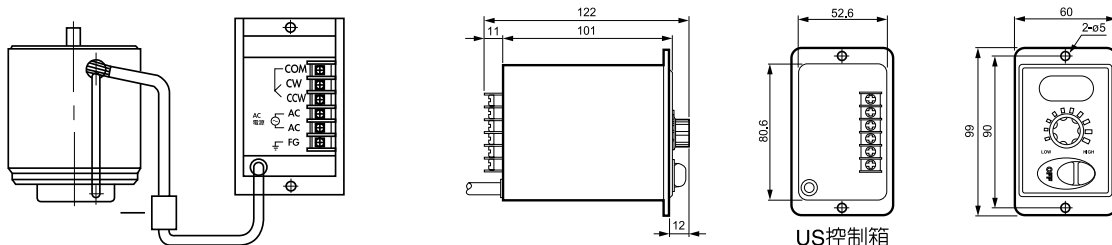

\*以上數值若有變動，恕不另行通知\* We reserve the right to change without further notice.

① M206-口 重量 0.9kg

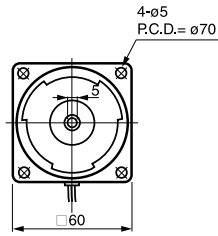
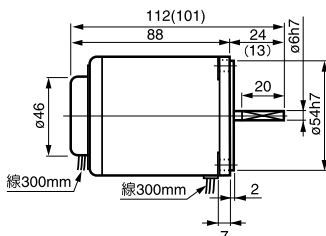

② 2GN-3~18 L=32 重量 0.35kg  
2GN-20~180 L=42 重量 0.45kg

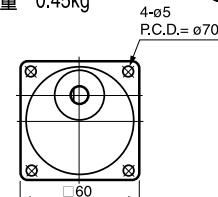
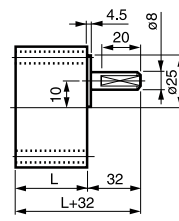

③ 2GN-10X 重量 0.3kg

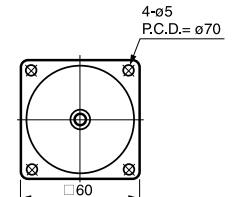
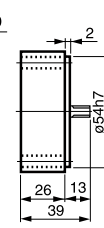

( )内數字係小齒輪軸馬達的數值 ( ) Numbers shown the dimension of the pinion shaft.

④ M315-口 重量 1.3kg

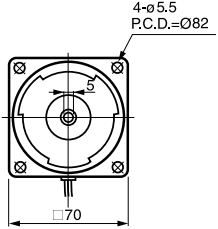
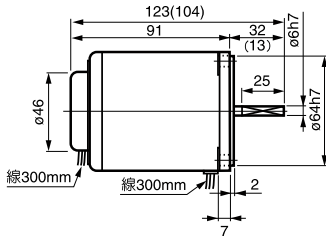

⑤ 3GN-3~18 L=32 重量 0.45kg  
3GN-20~180 L=42 重量 0.55kg

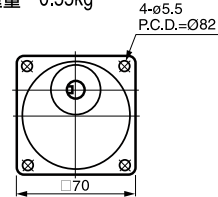
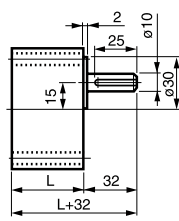

⑥ 3GN-10X 重量 0.35kg

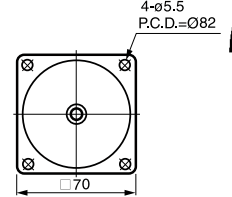
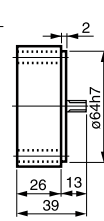

( )内數字係小齒輪軸馬達的數值 ( ) Numbers shown the dimension of the pinion shaft.

⑦ M425-口 重量 1.8kg

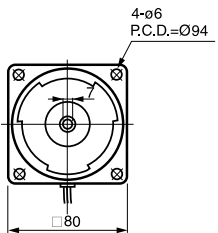
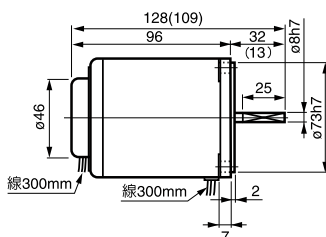

⑧ 4GN-3~18 L=35.5 重量 0.5kg  
4GN-20~180 L=49 重量 0.7kg

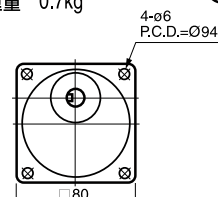
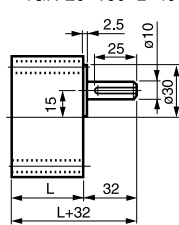

⑨ 4GN-10X 重量 0.45kg

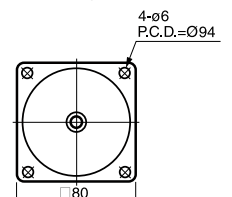
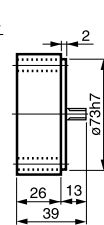

( )内數字係小齒輪軸馬達的數值 ( ) Numbers shown the dimension of the pinion shaft.

⑩ M540-口 重量 2.6kg

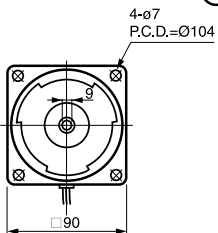
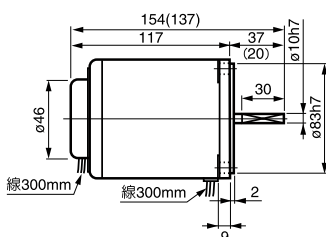

⑪ 5GN-3~18 L=42 重量 0.7kg (40~120W 共用)  
5GN-20~180 L=58 重量 1.05kg

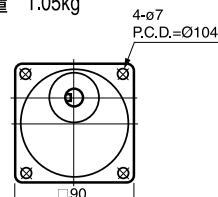
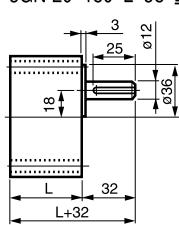

⑫ 5GN-10X 重量 0.6kg

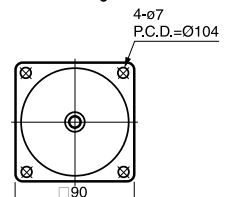
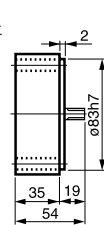

( )内數字係小齒輪軸馬達的數值 ( ) Numbers shown the dimension of the pinion shaft.

⑬ M560-口 重量 2.7kg

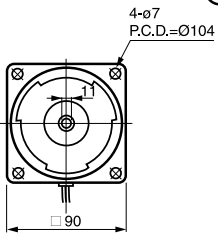
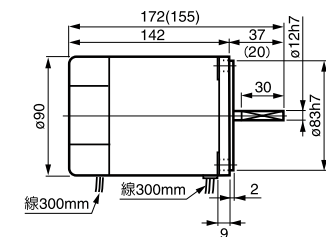

⑭ 5GU-3~180 KB 重量 1.3kg (60, 90, 120W 共用)

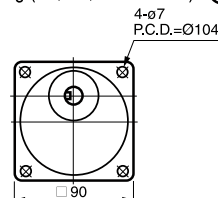
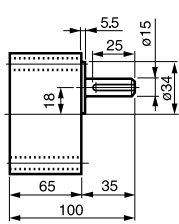

⑮ 5GU-10XK 重量 0.65kg  
適用螺絲: M6 x 140L

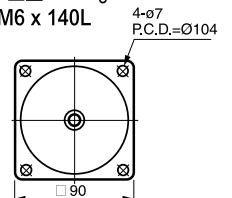
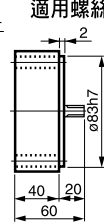

( )内數字係小齒輪軸馬達的數值 ( ) Numbers shown the dimension of the pinion shaft.

⑯ M590-口 重量 3.4kg  
M5120-口

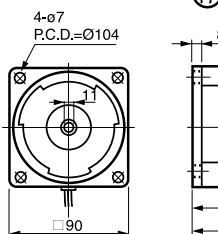
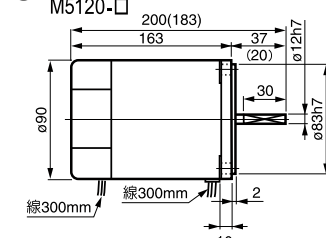

⑰ 5GU-3~180 K 重量 1.3kg (60, 90, 120W 共用)

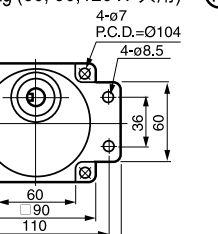
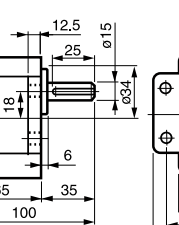

⑱ 5GU-10XKS 重量 0.65kg  
適用螺絲: M6 x 70L

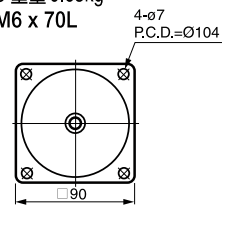
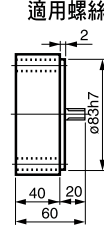

( )内數字係小齒輪軸馬達的數值 ( ) Numbers shown the dimension of the pinion shaft.





23

# 單相交流無段變速附電磁剎車馬達 Stepless Variable Speed Control Motor with Electromagnetic Brake (Single-Phase)

## US-B型剎車馬達特性表 Specifications of USB Type Motor (Single-Phase)

馬達型號 Motor Model No.		最大出力 Output (W)	電壓 Voltage (V)	周波數 Frequency (Hz)	極數 Pole (P)	可變速度範圍 Variable Speed Range		容許轉矩 Torque (gcm)		起動轉矩 Starting Torque (gcm)	電流 Current (A)	消耗電力 Consumed Power (W)	起動電容器 Condenser	
圓出力軸 Cylindrical Output Shaft	斜齒出力軸 Pinion Cut Output Shaft					回轉數 Revolving (rpm)	比 (Ratio)	設定回轉數 Set Revolving No.	1200rpm				90rpm	容量 Capacity (μF)
M206-001B	M206-401B	6	100 110	50 60	4	90~1400 90~1700	1:15	460 250	330	0.21	23	2.5	250	
M206-002B	M206-402B	6	200 220	50 60	4	90~1400 90~1700	1:15	460 250	330	0.10	23	0.8	400	
M315-001B	M315-401B	15	100 110	50 60	4	90~1400 90~1700	1:15	880 660	550	0.33	40	4	250	
M315-002B	M315-402B	15	200 220	50 60	4	90~1400 90~1700	1:15	880 660	550	0.16	40	1	400	
M425-001B	M425-401B	25	100 110	50 60	4	90~1400 90~1700	1:15	1760 1400	1200	0.60	60	6	250	
M425-002B	M425-402B	25	200 220	50 60	4	90~1400 90~1700	1:15	1760 1400	1200	0.25	60	1.5	400	
M540-001B	M540-401B	40	100 110	50 60	4	90~1400 90~1700	1:15	2800 1800	1900	0.68	90	10	250	
M540-002B	M540-402B	40	200 220	50 60	4	90~1400 90~1700	1:15	2800 1800	1900	0.31	90	2.5	400	
M560-001B	M560-401B M560-501B	60	100 110	50 60	4	90~1400 90~1700	1:15	5000 3500	3000	1.68	150	14	250	
M560-002B	M560-402B M560-502B	60	200 220	50 60	4	90~1400 90~1700	1:15	5000 3500	3000	0.55	150	3.5	400	
M590-001B	M590-401B M590-501B	90	100 110	50 60	4	90~1400 90~1700	1:15	6600 5300	4500	1.46	200	20	250	
M590-002B	M590-402B M590-502B	90	200 220	50 60	4	90~1400 90~1700	1:15	6600 5300	4500	0.63	200	5	400	
M5120-001	M5120-401B M5120-501B	120	100 110	50 60	4	90~1400 90~1700	1:15	8500 7000	6500	2.10	230	25	250	
M5120-002	M5120-402B M5120-502B	120	200 220	50 60	4	90~1400 90~1700	1:15	8500 7000	6500	0.93	230	6	400	

### SS31/32 分離控制箱尺寸與配線圖

#### SS31/32 Speed Control Unit Dimension and Knotting Chart

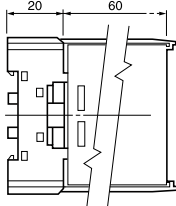
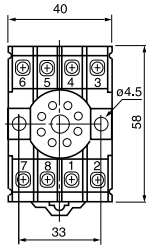

SS31/SS32 速度控制正逆轉接線圖  
SS speed control  
(Bi Directional Operation)

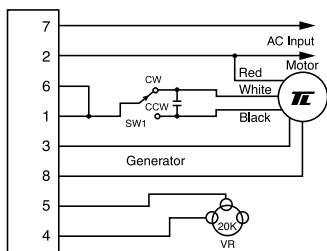

SS31/SS32 (R) 速度控制正逆轉加電子剎車接線圖  
SS speed control with electronic brake  
(Bi Directional Operation)

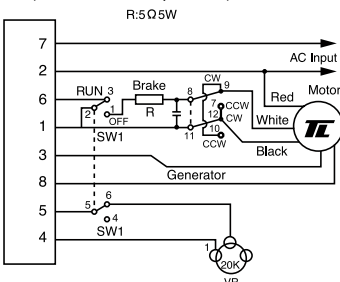

SS31/SS32 (B) 速度控制正逆轉加電磁剎車接線圖  
SS speed control with electromagnetic brake  
(Bi Directional Operation)

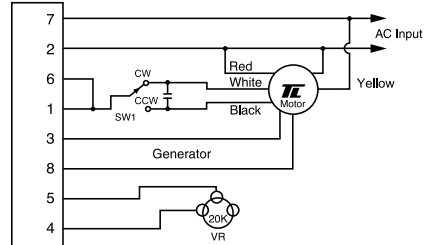

SS31/SS32 (R) 速度控制加電子剎車接線圖  
SS speed control with electronic brake  
R:5Ω5W

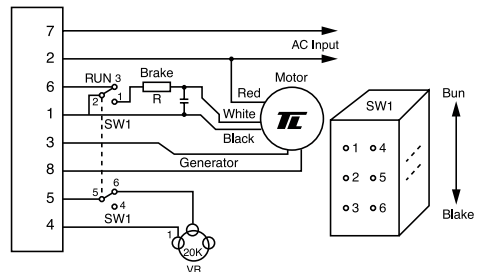



① M206-□B 重量 1.2kg

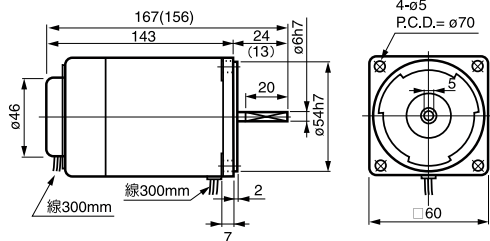

② 2GN-3-18 L=32 重量 0.35kg  
2GN-20-180 L=42 重量 0.45kg

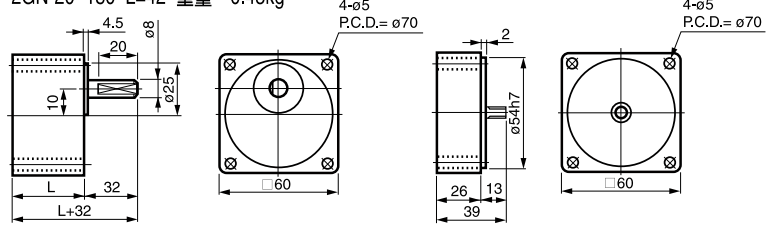

( )内數字係小齒輪軸馬達的數值 ( ) Numbers shown the dimension of the pinion shaft.

④ M315-□B 重量 1.1kg

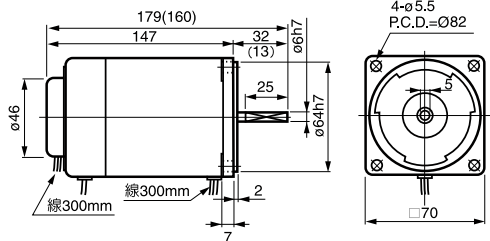

⑤ 3GN-3-18 L=32 重量 0.45kg  
3GN-20-180 L=42 重量 0.55kg

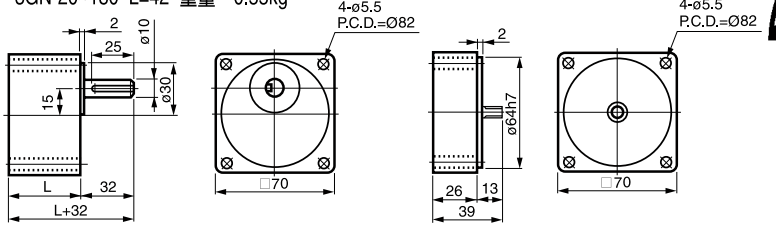

( )内數字係小齒輪軸馬達的數值 ( ) Numbers shown the dimension of the pinion shaft.

⑦ M425-□B 重量 1.6kg

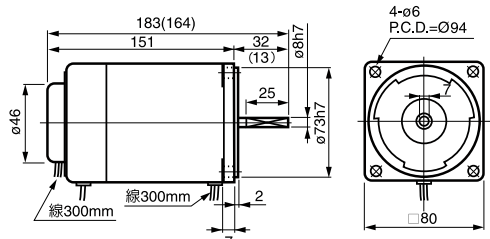

⑧ 4GN-3-18 L=35.5 重量 0.5kg  
4GN-20-180 L=49 重量 0.7kg

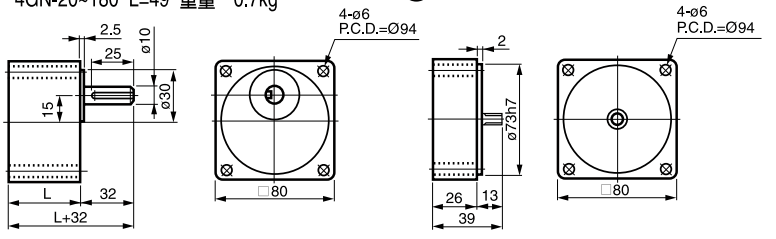

( )内數字係小齒輪軸馬達的數值 ( ) Numbers shown the dimension of the pinion shaft.

⑩ M540-□B 重量 3kg

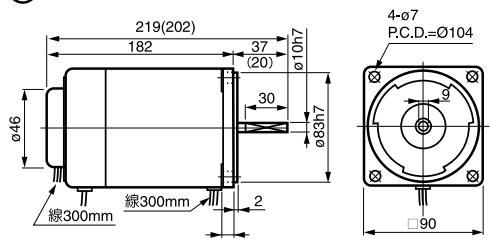

⑪ 5GN-3-18 L=42 重量 0.7kg (40~120W 共用)  
5GN-20-180 L=58 重量 1.05kg

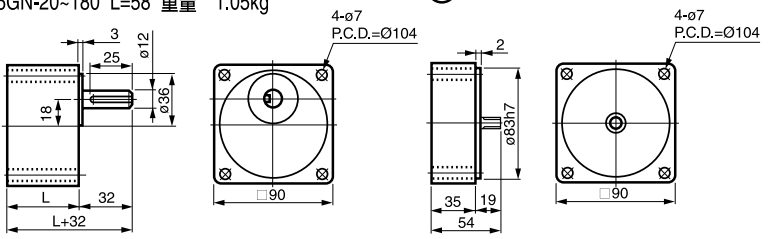

( )内數字係小齒輪軸馬達的數值 ( ) Numbers shown the dimension of the pinion shaft.

⑬ M560-□B 重量 3.1kg

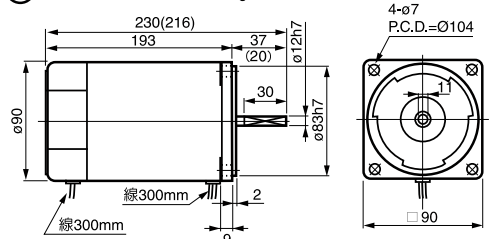

⑭ 5GU-3~180KB 重量 1.3kg (60, 90, 120W 共用)  
⑮ 5GU-10XK 重量 0.65kg  
適用螺絲: M6 x 140L

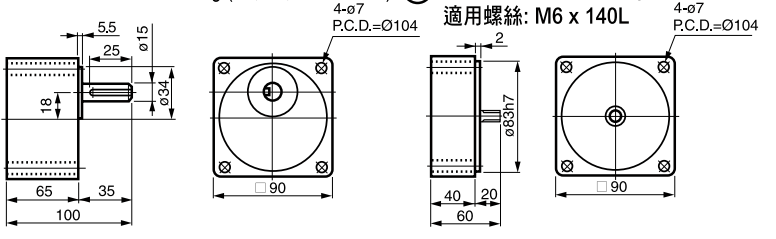

( )内數字係小齒輪軸馬達的數值 ( ) Numbers shown the dimension of the pinion shaft.

⑯ M590-□B 重量 4kg  
M5120-□B

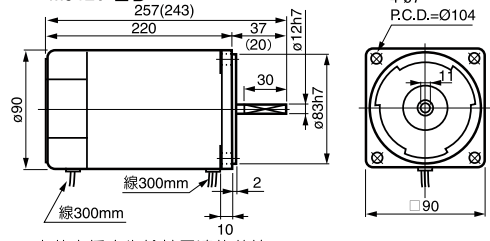

⑰ 5GU-3~180K 重量 1.3kg (60, 90, 120W 共用)

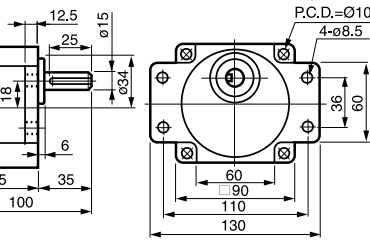

⑱ 5GU-10XKS 重量 0.65kg  
適用螺絲: M6 x 70L

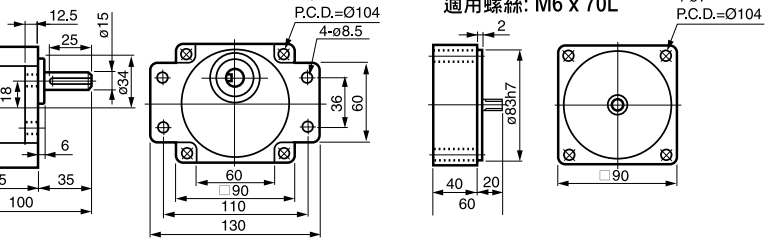

( )内數字係小齒輪軸馬達的數值 ( ) Numbers shown the dimension of the pinion shaft.

\*以上數值若有變動, 恕不另行通知\* We reserve the right to change without further notice.



GEAR REDUCER  
GEAR MOTOR

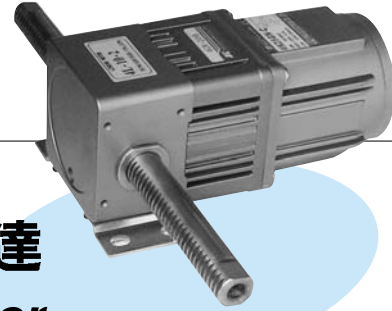

25

## GNT · GUT 直線型減變速馬達 Linear Type Gear Head with Motor

4 L 45 - 3

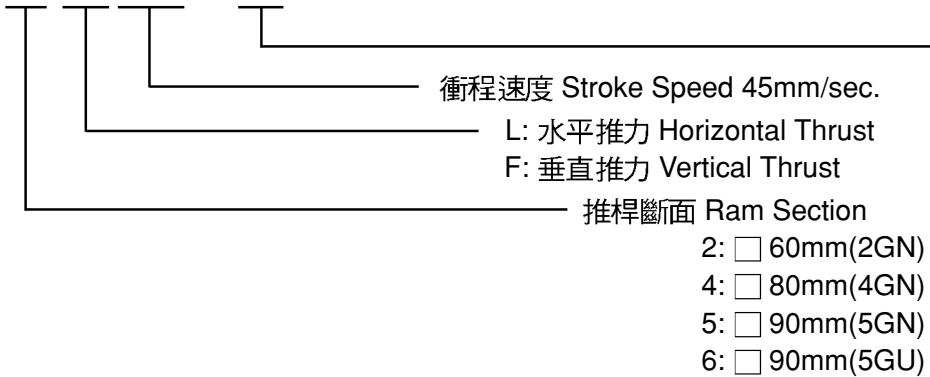

桿長代碼	適用型號
1: 100mm	2,4,5,6
2: 200mm	
3: 300mm	
4: 400mm	
5: 500mm	4,5,6
6: 600mm	
7: 700mm	
8: 800mm	

### 直線型齒輪箱特性表 Specifications of GNT (GUT) Type Gear Head with Motor

型號 Model No.	排桿座重量 Weight (kg)	排桿座寬度 (mm)	配合馬達機種 Applicable Motor	最大推力 Max. Thrust (kg)	基本速度 Speed (mm/sec)	直吊荷重 Permissible O.H.L. (kg)	衝程 Stroke (mm)	排桿重量 Weight (kg)	衝程 Stroke (mm)	排桿重量 Weight (kg)
2 $\frac{L}{F}$ - □ - □	0.35	61	2IK6GN-□ 2IK6GN-□ B M206-□	20	10	3	100	0.19	400	0.53
					20		200	0.30	500	0.64
					30		300	0.41	600	0.75
					40					
					50					
4 $\frac{L}{F}$ - □ - □	0.65	82	4IK25GN-□ 4IK25GN-□ B M425-□	70	10	5	100	0.37	500	1.34
					20		200	0.65	600	1.59
					30		300	0.88	700	1.83
					40		400	1.12	800	2.04
					50					
5 $\frac{L}{F}$ - □ - □	0.87	82	5IK40GN-□ 5IK40GN-□ B M540-□	100	10	8	100	0.73	500	2.15
					20		200	1.07	600	2.52
					30		300	1.43	700	2.87
					40		400	1.79	800	3.24
					50					
6 $\frac{L}{F}$ - □ - □	2	92	5IK60GU-□ 5IK60GU-□ B M560-□ 5IK90GU-□ 5IK90GU-□ B M590-□	140	10	8	100	0.73	500	2.15
					20		200	1.07	600	2.52
					30		300	1.43	700	2.87
					40		400	1.79	800	3.24
					50					

\* 最大推力以10mm/sec.及水平出力為基準；速度加快，推力降低。

### 用途例 Application

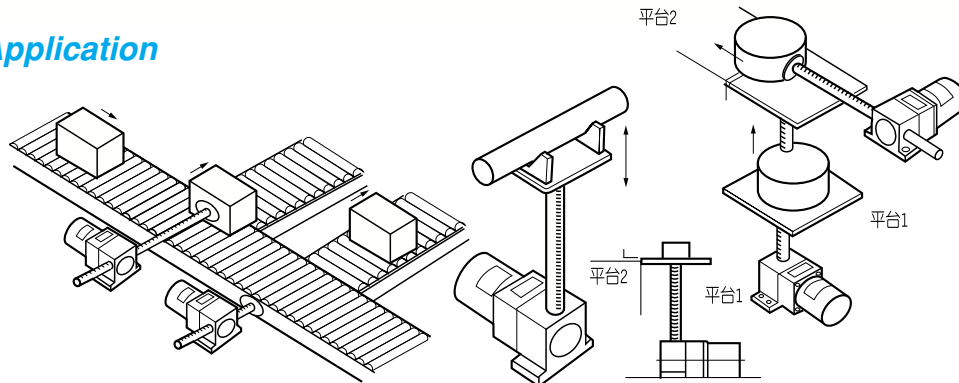

\*以上數值若有變動，恕不另行通知\* We reserve the right to change without further notice.

**6W # 2**

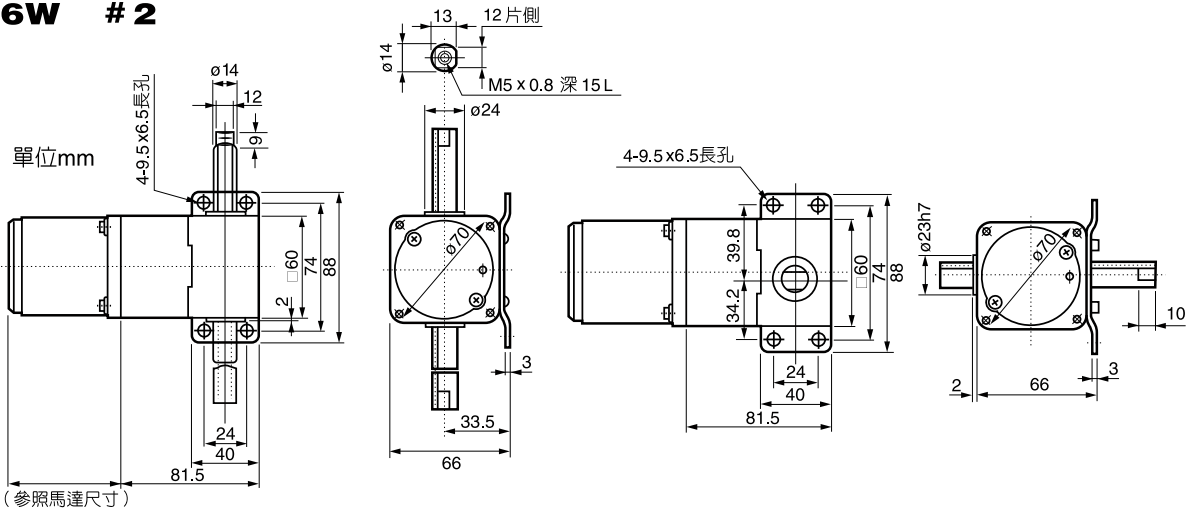

**25W # 4**

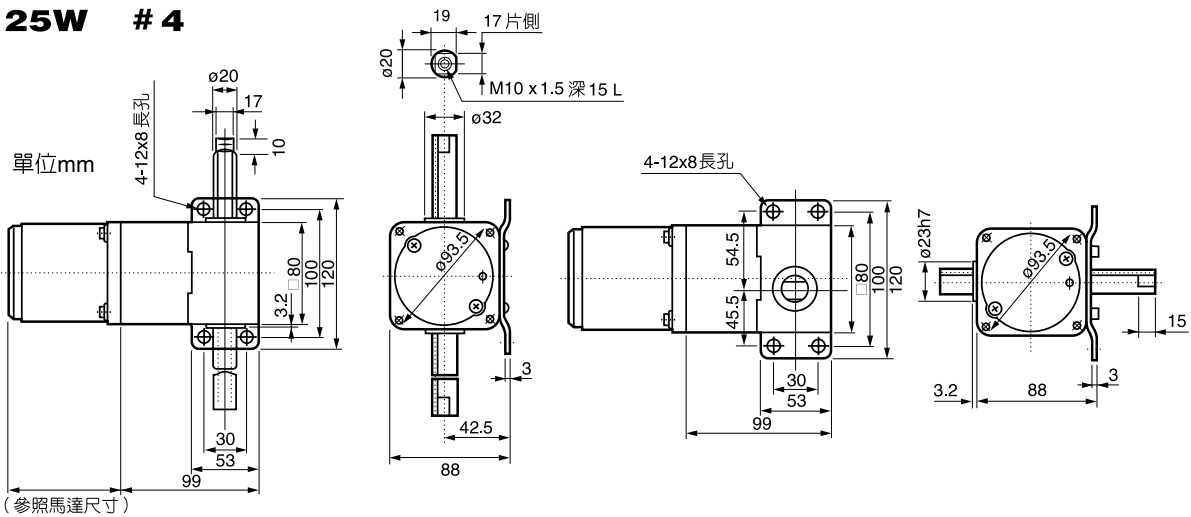

**40W # 5 (GN)  
60W # 6 (GU)  
90W  
120W  
150W**

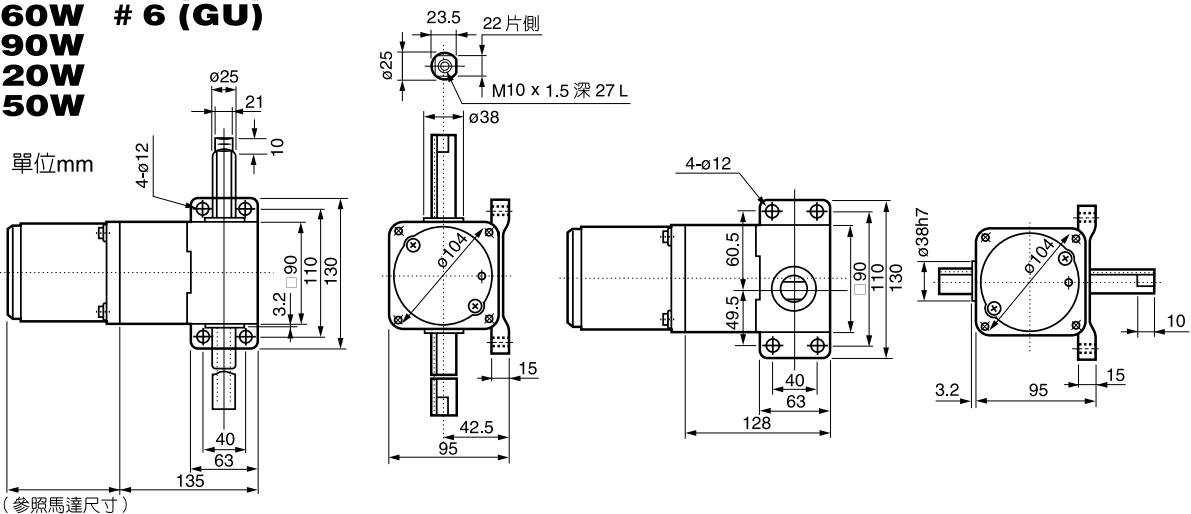

\*以上數值若有變動，恕不另行通知\* We reserve the right to change without further notice.







GEAR REDUCER  
GEAR MOTOR

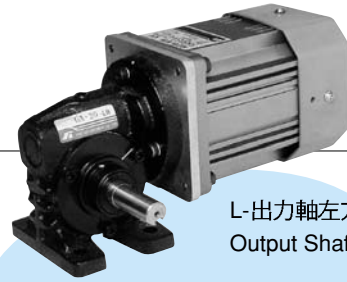

L-出力軸左方圖  
Output Shaft in the Left

# GA型渦輪減速馬達

## Worm Gear Reducer with Motor

**GA U 40 - 60 A B**

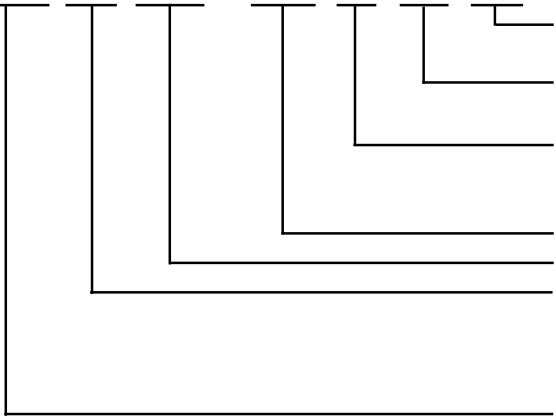

L-左出力軸 Output Shaft in the Left  
R-右出力軸 Output Shaft in the Right  
B-附電磁剎車 With Electromagnetic Brake  
T-附端子箱 With Terminal Box  
A-單相 Single Phase 100V~110V  
C-單相 Single Phase 200V~220V  
S<sub>2</sub>: 三相 220V, S<sub>3</sub>: 三相 220/380V, S<sub>4</sub>: 三相 220/440V  
減速比 Gear Ratio 5, 10, 15, 20, 30, 40, 50, 60  
馬力 HP 40W, 60W, 90W, 100W, 200W  
U: 無段變速馬達 Variable Speed Control Motor  
I: 連續運轉馬達 Induction Motor  
R: 定格30分馬達 Reversible Motor  
D: 直流馬達 DC Motor  
渦輪代號 Worm Gear Type

### 出力軸 Output Shaft

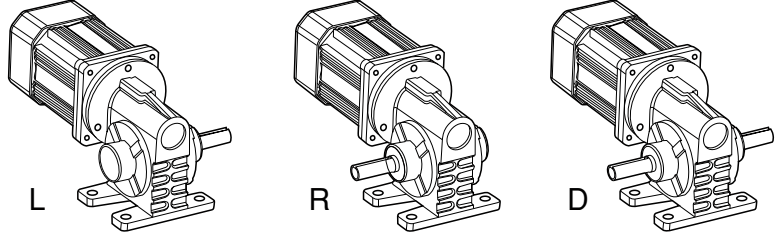

### 尺寸圖 Dimension Chart

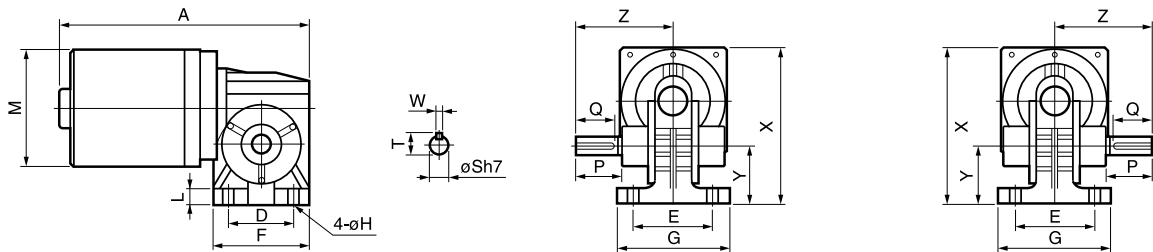

R-出力軸右方圖  
Output Shaft in the Right

L-出力軸左方圖  
Output Shaft in the Left

### GA尺寸表 Dimensions

型號 Model No.	減速比 Gear Ratio	入力孔	A	D	E	F	G	H	L	M	X	Y	出力軸端 Output Shaft						渦座重量 (Kg)		
													Z		P						
													L	R	L	R	Q	S		T	W
GAI-40-□-□	1/5-1/60	ø10	198 (248)	50	60	75	87	9	10	90	118	43.5	78	77	41	40	30	14	16.5	5	配小渦座 1.8
GAI-60-□-□	1/5-1/60		230 (288)	50	60	75	87	9	10	90	118	43.5	78	77	41	40	30	14	16.5	5	
GAI-90-□-□	1/51/60	ø12	270 (330)	65	90	92.8	112	10	10	90	146	56.5	96	94	53	51	40	16	18.5	5	配大渦座 3.5
GAI-100-□-□	1/5-1/60		255 (300)	65	90	92.8	112	10	10	126	161	56.5	96	94	53	51	40	16	18.5	5	
GAI-200-□-□	1/5-1/60		285 (330)	65	90	92.8	112	10	10	126	161	56.5	96	94	53	51	40	16	18.5	5	

( ) 為附剎車尺寸

( ) Numbers shown the dimension of the brake

\*以上數值若有變動，恕不另行通知\* We reserve the right to change without further notice.





GEAR REDUCER  
GEAR MOTOR



29

## 直交軸系列 齒輪減速機 Right-Angle Gear Reducer

### 5 GN - 150 RH



#### 應用範例 Examples

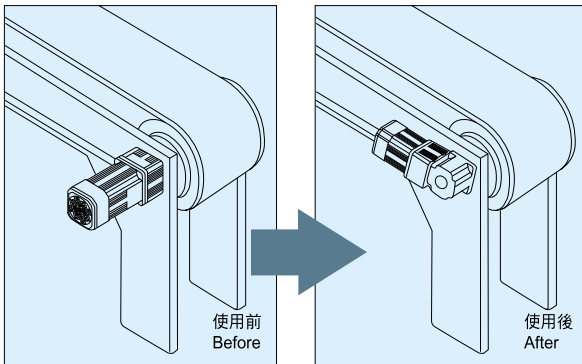

使用差異 Difference in usage

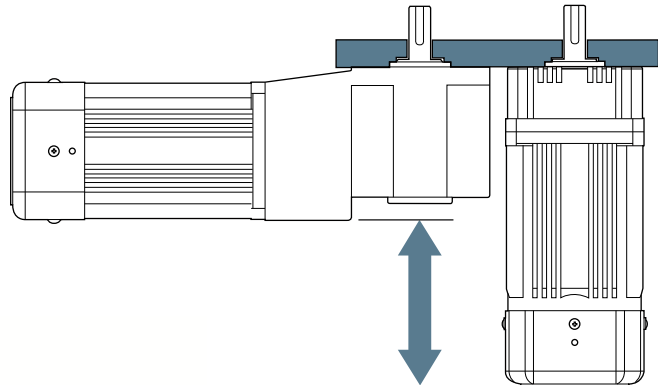

#### 轉矩表 Torque Table (Kg·cm)

(Kg · cm) x 9.8/100=N·m

減速比	10	15	20	25	30	40	45	50	60	75	90	100	120	150	180	200	250	300	350	400	500	600	
25W	9.3	14	19	23	28	37	42	47	58	72	87	96	120	120	120	120	120	120	120	120	120	120	120
40W	13.4	20	27	34	40	54	61	67	83	104	125	140	140	140	140	140	140	140	140	140	140	140	140
60W	19.6	29	39	49	59	79	88	98	122	152	183	203	244	260	260	260	260	260	260	260	260	260	260
90W	29.5	44	59	74	88	118	133	147	183	229	260	260	260	260	260	260	260	260	260	260	260	260	260
120W	36.7	55	73	92	110	147	165	184	228	260	260	260	260	260	260	260	260	260	260	260	260	260	260
150W	48.9	73	98	122	147	196	220	245	260	260	260	260	260	260	260	260	260	260	260	260	260	260	260
效率	51.75%						53.50%						61.38%										

\*以上數值若有變動，恕不另行通知\* We reserve the right to change without further notice.

■ 尺寸圖 Dimension Chart

4GN

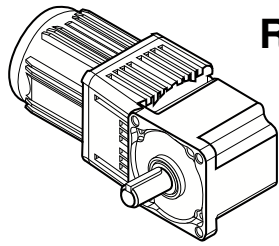

RA

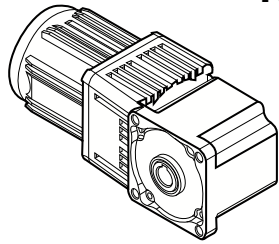
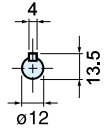
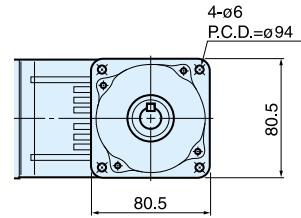
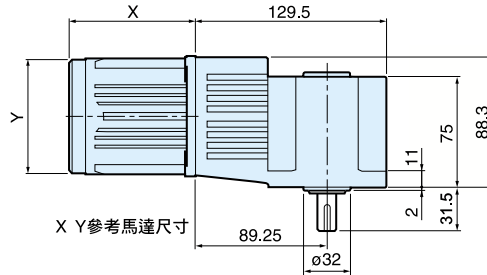

RH

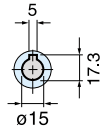
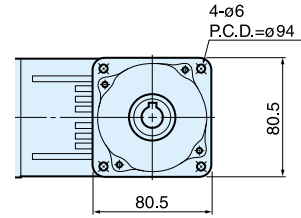
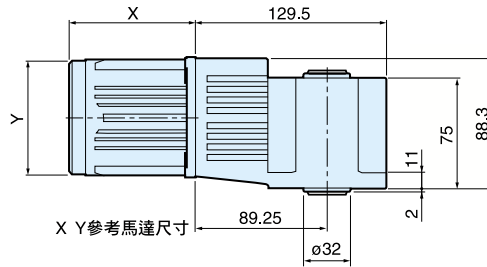

5GN

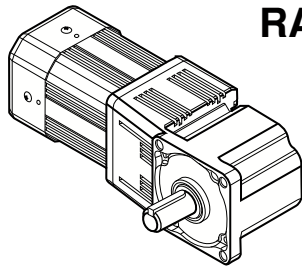

RA

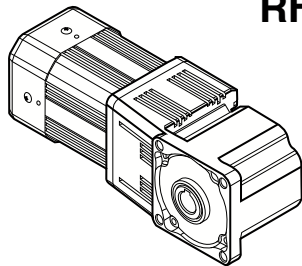
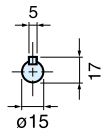
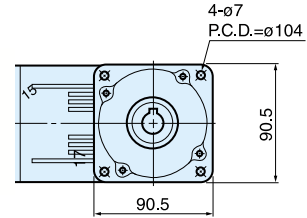
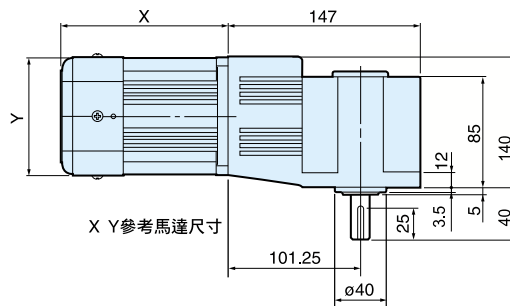

RH

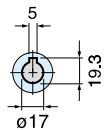
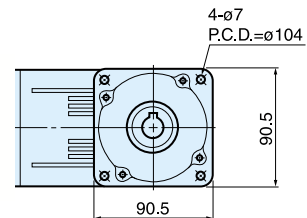
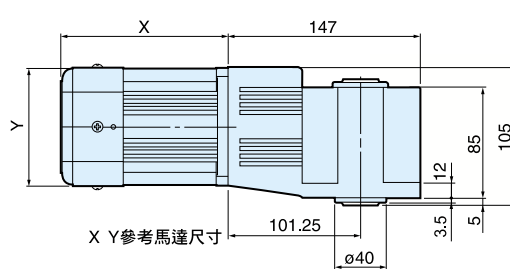

■ 配用馬達尺寸表  
Motor Spec.

		X(mm)					Y(mm)	X(mm)					Y(mm)
馬力	IK	IK-B	RK	US	US-B	□外徑	馬力	IK	IK-B	RK	US	US-B	□外徑
25W	85	141	85	96	151	□80	90W	155	220	155	163	220	□90
40W	107	164	107	117	182	□90	120W	155	220	155	163	220	□90
60W	142	193	142	142	193	□90	150W	155	220	155	-	-	□90

\*以上數值若有變動，恕不另行通知\* We reserve the right to change without further notice.

# 馬達減速機型號解說 (GL,GF,PL,PF規格)



- PL-臥式馬達外殼鋁合金型  
Horizontal Aluminum alloy motor shell
- PF-立式馬達外殼鋁合金型  
Vertical Aluminum alloy motor shell
- GL-臥式馬達外殼鋼板型 (已停產)  
Horizontal Steel motor shell
- GF-立式馬達外殼鋼板型 (已停產)  
Vertical Steel motor shell
- PLD-臥式雙軸型  
Horizontal dual-shaft type
- PFD-立式雙軸型  
Vertical dual-shaft type
- PLK-臥式入力自配型  
Horizontal self-contained motor type
- PFK-立式入力自配型  
Vertical self-contained motor type

**PL 22 - 0200 - 30 S - □**

出力軸  
Output Shaft :  
ø18, ø22, ø28, ø32,  
ø40, ø50

馬力 HP:  
100W, 200W, 400W, 750W,  
1500W, 2200W, 3700W

減速比 Ratio: 1/30

B-附電磁剎車  
W/Electromagnetic  
Brake

A: 單相 Single Phase 110V  
C: 單相 Single Phase 220V  
S2: 三相 3-Phase 220V  
S3: 三相 3-Phase 220/380V  
S4: 三相 3-Phase 220/440V

## 馬達及安全剎車器特性表 Specifications of PL, PF Type Motor & Brake

相 (Phase)	馬力 (KW)	極數 (P)	電壓 (V)	頻率 (Hz)	定格 RATING			絕緣 Class	扭矩 (Kg-m)	釋放時間 Release Time			調整間隙 Adjust Gap		附安全剎車器 With Brake		
					轉速 (R.P.M)	電流 (A)	轉矩 (Kg-m)			交流一切斷 AC Switch	直流別切 DC Switch	規定值 Specified Value	限界值 Boundary Value	剎車電壓 Brake Volt	整流電壓 Input Volt	使用次數 Operation Times	
三相 3ø	0.1	4P	220/380	60/50	1680/1380	0.8/0.46	0.058/0.071	E/F	0.1	0.1	0.06	0.3	0.7	DC90V	AC200~240V	6次/分 (6 times/min)	
	0.2		220/380	60/50	1680/1380	1.2/0.7	0.116/0.142	E/F	0.2	0.07	0.03	0.3	0.7				
	0.4		220/380	60/50	1680/1400	2.1/1.2	0.232/0.278	E/F	0.4	0.10	0.03	0.3	0.7				
	0.75		220/380	60/50	1680/1400	3.6/2.1	0.43/0.52	E/F	0.8	0.12	0.05	0.4	1.0				
	1.5		220/380	60/50	1680/1420	6.1/3.5	0.87/1.03	E/F	1.6	0.14	0.05	0.4	1.0				
	2.2		220/380	60/50	1680/1420	9.5/5.5	1.27/1.51	E/F	2.5	0.15	0.03	0.4	1.0				
單相 1ø	3.7	4P	220/380	60/50	1680/1420	15/8.7	2.14/2.54	E/F	5.0	0.17	0.05	0.5	1.2	DC90V	AC-100~110V AC-200~240V	6次/分 6 times/min	
	0.1		110/220	60/50	1680/1380	2/1	0.058/0.071	E	0.1	0.1	0.06	0.3	0.7				
	0.2		110/220	60/50	1680/1380	4/2	0.116/0.142	E	0.2	0.07	0.03	0.3	0.7				
	0.4		110/220	60/50	1680/1400	8/4	0.232/0.278	E	0.4	0.10	0.03	0.3	0.7				
	0.75		110/220	60/50	1680/1400	12/6	0.43/0.52	E	0.8	0.12	0.15	0.4	1.0				

## 減速機輸出特性表 Specifications of Gear Reducer

(Kg · m) x 9.8 = N · m

減速比 Gear Ratio	出力轉速 Out. rpm		0.1KW			0.2KW			0.4KW			0.75KW			1.5KW			2.2KW			
	50Hz	60Hz	出力軸容許扭力荷重			出力軸容許扭力荷重			出力軸容許扭力荷重			出力軸容許扭力荷重			出力軸容許扭力荷重			出力軸容許扭力荷重			
	型號 Type	50Hz	60Hz	O.H.L.	型號 Type	50Hz	60Hz	O.H.L.	型號 Type	50Hz	60Hz	O.H.L.	型號 Type	50Hz	60Hz	O.H.L.	型號 Type	50Hz	60Hz	O.H.L.	
5	300	360	0.31	0.26	60	0.62	0.51	60	1.2	1	90	2.3	1.9	130	4.8	3.5	180	32	6.6	5.5	220
10	150	180	0.62	0.51	90	1.2	1	90	1.5	1.24	100	4.6	3.9	180	8.8	7.1	250	32	13.2	10.7	320
12.5	120	144	0.77	0.66	100	1.54	1.24	100	3.1	2.5	130	5.7	4.9	190	11	8.9	290	40	16.5	13.3	340
15	100	120	0.93	0.77	100	1.85	1.5	100	3.7	2.9	140	6.9	5.8	220	13.2	10.7	290	40	19.8	16	360
20	75	90	1.2	1	120	2.47	1.99	120	4.94	4	150	9.3	7.7	240	17.6	14.2	330	40	26.5	21.4	410
25	60	72	1.5	1.3	130	3	2.49	130	6.17	4.9	170	11.6	9.6	250	22.1	17.8	390	40	33.1	26.7	480
30	50	60	1.9	1.5	140	3.7	2.99	180	7.41	5.9	260	13.9	11.6	410	26.5	21.4	520	40	39.7	32.1	710
40	37.5	45	2.4	2	150	4.94	3.99	190	9.88	7.98	290	17.9	14.9	430	35.3	28.5	600	50	53	42.8	740
50	30	36	3	2.5	160	6.17	4.98	200	12.3	9.97	320	22.4	18.7	470	44.2	35.7	720	50	66.3	53.3	880
60	25	30	3.6	3	220	7.4	5.98	220	14.8	11.9	350	26.9	22.4	560	53	42.8	720	50	79.5	64.2	1000
75	20	24	4.6	3.7	220	9.2	7.5	220	18.5	14.9	350	35.1	28.3	560	66.3	53.5	720	50	99.4	80.3	1000
90	16.6	20	5.5	4.5	250	11.1	9	250	22.2	17.9	350	42.1	34	600	79.5	64.2	720	50	119.3	96.3	1000
100	15	18	6	5	250	12.3	9.9	250	24.7	19.9	350	46.8	37.8	600	88.4	71.4	720	50	132.6	107.1	1000
120	12.5	15	7.2	6	250	14.8	11.9	340	29.6	23.9	600	58.4	47.3	720	106	85.6	1000				
150	10	12	9.2	7.5	250	18.5	14.9	350	37	29.9	600	70.2	56.7	720	132.6	107.1	1000				
180	8.3	10	11	9	250	22.2	17.9	350	44.4	35.9	600	84.2	68	720	132.6	107.1	1000				
200	7.5	9	11.9	10	250	24.7	19.9	350	49.4	39.9	600	93.6	75.6	720	132.6	107.1	1000				
300	5	6	17.5	14.9	350	35.1	28.3	600	70.2	56.7	720	132.6	107.1	1000							
1200	1.25	1.5	58.5	47.6	350	70.2	56.7	600	70.2	56.7	720	132.6	107.1	1000							
1800	0.83	1	58.5	47.6	350	70.2	56.7	600	70.2	56.7	720	132.6	107.1	1000							

\*以上數值若有變動，恕不另行通知\* We reserve the right to change without further notice.



## 減速機外殼材質表 Shell Material

型號 Type	材質 Material
18	ADC 12 (鋁合金 Aluminum)
22	ADC 12 (鋁合金 Aluminum)
28	ADC 12 (鋁合金 Aluminum)
32	ADC 12 (鋁合金 Aluminum)
40	FC200 (20)- (鑄鐵 Cast Iron)
50	FC200 (20)- (鑄鐵 Cast Iron)

## 油量表 Oil Capacities

型號 Type	注油量 g	潤滑 Lubrication	替代油品
18	180	GR-250-OR 高溫齒輪油	美孚 Mobil SHC系列 Mobiltemp 0
22	250		
28	500		
32	650		
40	900		
50	1200		

## 齒輪馬達減速機結構圖 Gear Reducer Structure

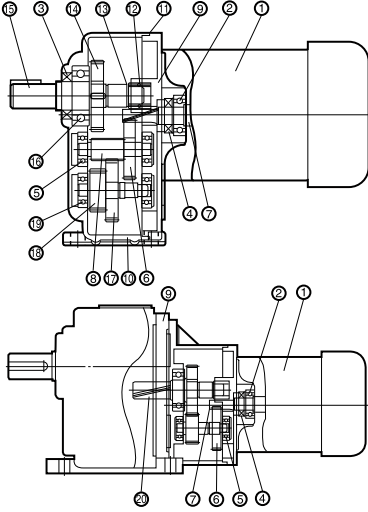

編號 No.	零件名稱 Name of Parts
1	馬達 Motor
2	馬達軸承 Motor Bearing
3	油軸封(出) Oil Seal (Out)
4	油軸封(入) Oil Seal (In)
5	二段側軸承 2nd Stage Bearing
6	一段側齒輪 1st Stage Gear
7	馬達小齒輪軸 Motor Pinion Shaft
8	二段側小齒輪軸 2nd Stage Pinion Shaft
9	本體蓋 Body Cover
10	本體 Body
11	油封膠圈 "O" Ring
12	出力軸尖軸承 Needle Bearing (Sleeve)
13	推力墊圈 Thrust Washer
14	出力齒輪 Output Gear
15	出力軸 Output Shaft
16	出力軸軸承 Output Shaft Bearing
17	二段側齒輪 2nd Stage Gear
18	三段側小齒輪軸 3rd Stage Pinion
19	三段側軸承 3rd Stage Bearing
20	中間段齒輪 Middle Stage Gear

## 安全剎車器結構圖 Brake Structure

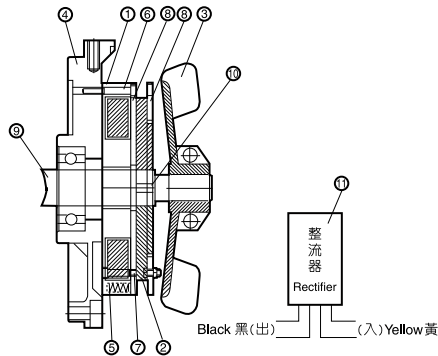

編號 No.	零件名稱 Name of Parts
1	托架 Bracket(Brake Coil Included)
2	剎車來令 Brake Shoe
3	外扇風葉 Output Fan
4	軸承蓋 Bearing Cover
5	壓縮彈簧 Spring Compression
6	內六角螺絲 Hex Screw
7	內六角螺絲 Hex Screw
8	剎車基板 Brake Plate
9	馬達軸心 Motor Spindle
10	來令片固定環 Brake Shoe Fixing Ring
11	剎車電源裝置(整流器) Power Device for Brake(Rectifier)

## 接線圖 Line Knotting Chart 三相(Three Phase)

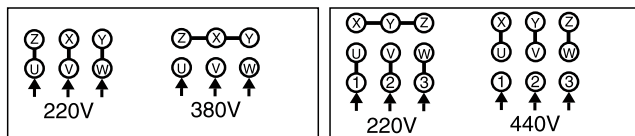

## 單相(Single Phase)

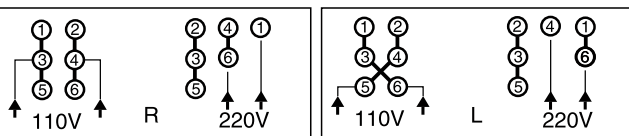

下方圖係附剎車之接線圖 Line knotting chart of the brake are shown as below..

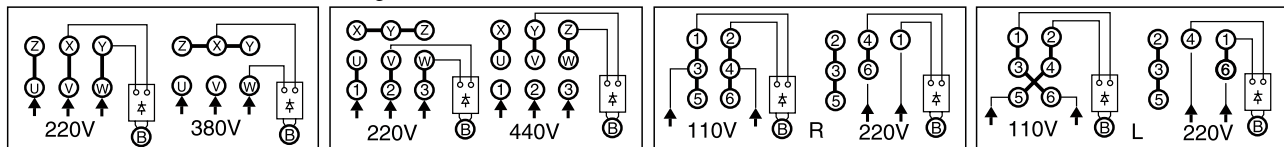

## 安裝方式 Installation

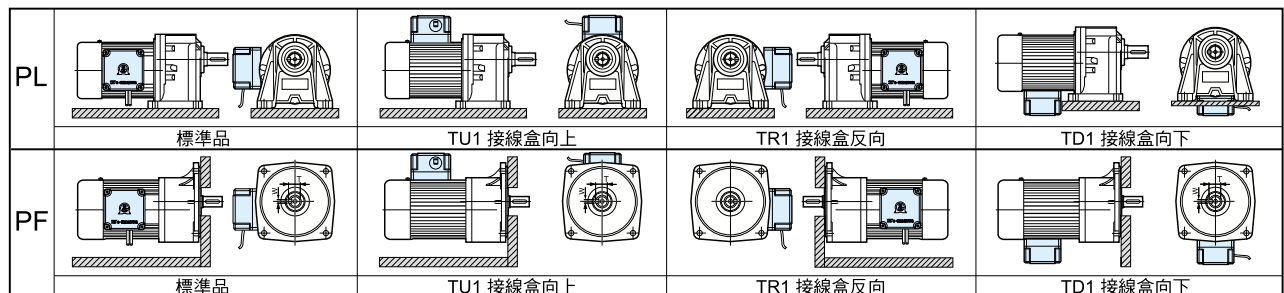



# PL型(臥式)三相齒輪減速馬達 PL Type 3-Phase Horizontal Gear Reduction Motor (Foot Mounted)

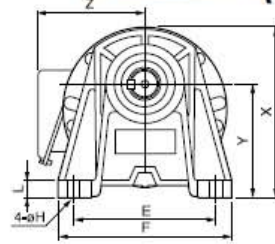
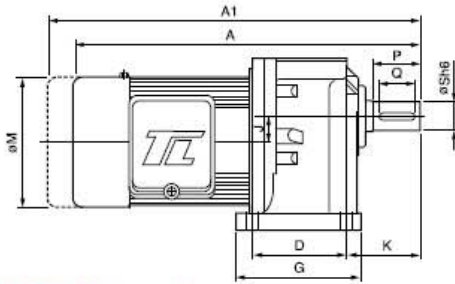

軸徑40mm之鍵寬(W):  
台灣尺寸: 10mm  
大陸尺寸: 12mm

## 馬達尺寸表 Dimensions

馬力 HP	減速比 Gear Ratio	框號 Type	A	A1	D	E	F	G	H	L	J	K	M	X	Y	Z	出力軸端 Output Shaft					重量 App.Wt. Kg
																	P	Q	S	T	W	
0.1KW   1/8HPx4P	5~50	18	255	282	40	110	135	65	9	10	15.98	50	127	127	85	116	30	22	18	20	5	6.1
	60~200	22	287	314	65	130	155	90	11	12	17.66	60	127	145	90	116	40	30	22	25	7	7.0
	250~1800	22	356	383	65	130	155	90	11	12	17.66	60	127	145	90	116	40	30	22	25	7	8.9
	250~1800	28	393	420	90	140	170	120	11	15	23.11	70	127	170	110	100	45	35	28	31	7	11.6
0.2KW   1/4HPx4P	5~10	18	273	301	40	110	135	65	9	10	15.98	50	127	127	85	116	30	22	18	20	5	7.04
	12.5~25	18	273	301	40	110	135	65	9	10	15.98	50	127	127	85	116	30	22	18	20	5	7.1
	12.5~100	22	305	330	65	130	155	90	11	12	17.66	60	127	145	90	116	40	30	22	25	7	8.8
	120~200	28	334	361	90	140	170	120	11	15	23.11	70	127	170	110	100	45	35	28	31	7	12
	250~1800	28	411	437	90	140	170	120	11	15	23.11	70	127	170	110	100	45	35	28	31	7	12.4
250~1800	32	443	471	130	170	210	167	13	18	30.22	75	127	204	130	116	55	45	32	36.5	10	24.6	
0.4KW   1/2HPx4P	5~10	22	323	350	65	130	155	90	11	12	17.66	60	127	145	90	116	40	30	22	25	7	9.3
	12.5~25	22	323	350	65	130	155	90	11	12	17.66	60	127	145	90	116	40	30	22	25	7	10.6
	12.5~100	28	352	379	90	140	170	120	11	15	23.11	70	127	170	110	100	45	35	28	31	7	12.1
	120~200	32	382	409	130	170	210	167	13	18	30.22	75	127	204	130	116	55	45	32	36.5	10	25.2
	250~1800	32	464	491	130	170	210	167	13	18	30.22	75	127	204	130	116	55	45	32	36.5	10	27.6
250~1800	40	542	569	150	210	260	200	18	23	37.96	96	127	252	160	116	65	55	40	44	<sup>10</sup> <sub>(12)</sub>	45.2	
0.75KW   1HPx4P	5~25	28	379	405	90	140	170	120	11	15	23.11	70	160	170	110	131	45	35	28	31	7	15.1
	30~100	32	409	470	130	170	210	167	13	18	30.22	75	160	204	130	131	55	45	32	36.5	10	22
	120~200	40	465	491	150	210	260	200	18	23	37.96	96	160	252	160	131	65	55	40	44	<sup>10</sup> <sub>(12)</sub>	45.2
	250~1800	40	569	595	150	210	260	200	18	23	37.96	96	160	252	160	131	65	55	40	44	<sup>10</sup> <sub>(12)</sub>	47.7
250~1800	50	580	606	160	230	285	210	18	25	39.2	104	160	293	176	-	75	65	50	53.5	14	60.5	
1.5KW   2HPx4P	5~25	32	442	477	130	170	210	167	13	18	30.22	75	192	204	130	138	55	45	32	36.5	10	25
	30~100	40	498	533	150	210	260	200	18	23	37.96	96	192	252	160	138	65	55	40	44	<sup>10</sup> <sub>(12)</sub>	47.7
	120~200	50	509	543	160	230	285	210	18	25	39.2	104	192	293	176	-	75	65	50	53.5	14	55.0
2.2KW   3HPx4P	5~10	32	467	502	130	170	210	167	13	18	30.22	75	192	204	130	138	55	45	32	36.5	10	35.2
	15~60	40	523	558	150	210	260	200	18	23	37.96	96	192	252	160	138	65	55	40	44	<sup>10</sup> <sub>(12)</sub>	49.1
	75~120	50	534	569	160	230	285	210	18	25	39.2	104	192	293	176	-	75	65	50	53.5	14	58.0
3.7KW   5HPx4P	5~20	40	552	586	150	210	260	200	18	23	37.96	96	233	252	160	190	65	55	40	44	<sup>10</sup> <sub>(12)</sub>	67
	25~100	50	562	597	160	230	285	210	18	25	39.2	104	233	293	176	190	75	65	50	53.5	14	72

- A1之長度為馬達附剎車之總長。
- 淺藍色為輕扭力之機型。
- 1/8~1 HP之附剎車重量，約無剎車重量加 2 KG。
- 2~3 HP之附剎車重量，約無剎車重量加 3.5 KG。
- 40~50 筒齒箱上附加 O 型吊環 (高度約 50 mm)。
- 軸徑40mm之鍵寬(w)標準為10mm，12mm為選用規格。
- Length of A1 is the total length of motor and the brake.
- Colour in Light blue indicates motor of smaller torque.
- Weight of 1/8 ~ 1HP motor w / brake shall be weight of motor w / 0 brake + 2Kg.
- Weight of a 2~3HP motor w / brake is equal to motor w/0 brake + 3.5kg.
- "O" type rings shall be attached to the 40 ~ 50mm gear box. (add. Height: 50mm).
- Keyway (w) for type 40 is 10mm, 12mm is optional.

\*以上數值若有變動，恕不另行通知\* We reserve the right to change without further notice.





# PF型(立式)三相齒輪減速馬達

## PF Type 3-Phase Vertical Gear Reduction Motor (with Flange)

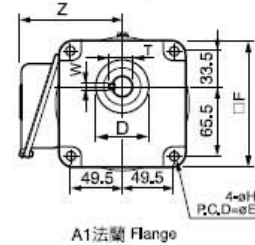
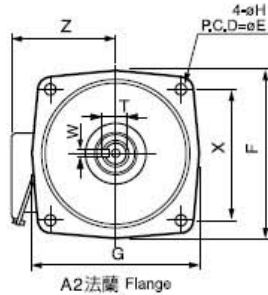
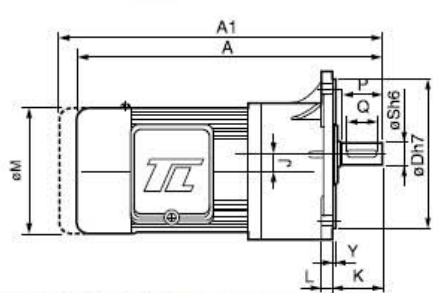

軸徑40mm 之鍵寬(W):  
台灣尺寸: 10mm  
大陸尺寸: 12mm

### 馬達尺寸表 Dimensions

馬力 HP	減速比 Gear Ratio	框號 Type	A	A1	D	E	X	F	G	H	L	J	K	M	Y	Z	出力軸端 Output Shaft					重量 App. Wt. Kg	備註 Remark
																	P	Q	S	T	W		
0.1KW   1/8HPx4P	5~50	18	255	282	50	140	99	122	-	9	12	15.98	40	125	5	116	30	22	18	20	5	6.08	A1法蘭
	60~200	22	287	314	148	185	131	168	165	11	12	17.66	50	125	3.5	116	40	30	22	25	7	7.3	A2法蘭
	250~1800	22	356	383	148	185	131	168	165	11	12	17.66	50	125	3.5	116	40	30	22	25	7	9.8	A2法蘭
	250~1800	28	393	420	170	220	156	205	195	$0_{-0.14}^{0.11}$	13	23.11	60	125	4	116	45	35	28	31	7	11.9	A2法蘭
0.2KW   1/4HPx4P	5~10	18	273	302	50	140	99	122	-	9	12	15.98	40	125	5	116	30	22	18	20	5	7.1	A1法蘭
	12.5~25	18	273	302	50	140	99	122	-	9	12	15.98	40	125	5	116	30	22	18	20	5	7.13	A1法蘭
	12.5~100	22	305	330	148	185	131	168	165	11	12	17.66	50	125	3.5	116	40	30	22	25	7	8.81	A2法蘭
	120~200	28	334	361	170	220	156	205	195	$0_{-0.14}^{0.11}$	13	23.11	60	125	4	116	45	35	28	31	7	11.7	A2法蘭
	250~1800	28	411	437	170	220	156	205	195	$0_{-0.14}^{0.11}$	13	23.11	60	125	4	116	45	35	28	31	7	12.8	A2法蘭
250~1800	32	443	471	185	255	180	241	225	15	15	30.22	70	125	4	116	55	40	32	36.5	10	25.2	A2法蘭	
0.4KW   1/2HPx4P	5~10	22	325	350	148	185	131	168	165	11	12	17.66	50	125	3.5	116	40	30	22	25	7	9.62	A2法蘭
	12.5~25	22	325	350	148	185	131	168	165	11	12	17.66	50	125	3.5	116	40	30	22	25	7	11	A2法蘭
	12.5~100	28	352	380	170	220	156	205	195	$0_{-0.14}^{0.11}$	13	23.11	60	125	4	-	45	35	28	31	7	13.4	A2法蘭
	120~200	32	385	410	185	255	180	241	225	15	15	30.22	70	125	4	116	55	45	32	36.5	10	24.4	A2法蘭
	250~1800	32	465	492	185	255	180	241	225	15	15	30.22	70	125	4	116	55	45	32	36.5	10	26.8	A2法蘭
250~1800	40	545	570	230	310	219	297	268	15	20	37.96	76	125	5	-	65	55	40	44		45.6	A2法蘭	
0.75KW   1HPx4P	5~25	28	380	405	170	220	156	205	195	$0_{-0.14}^{0.11}$	13	23.11	60	158	4	131	45	35	28	31	7	15.1	A2法蘭
	30~100	32	410	435	185	255	180	241	225	15	15	30.22	70	158	4	131	55	45	32	36.5	10	26.9	A2法蘭
	120~200	40	465	492	230	310	219	297	268	15	20	37.96	76	158	5	-	65	55	40	44		45.6	A2法蘭
	250~1800	40	570	595	230	310	219	297	268	15	20	37.96	76	158	5	-	65	55	40	44		48.1	A2法蘭
250~1800	50	580	606	250	352	249	320	290	18	22	39.2	86	158	5	-	75	65	50	53.5	14	57.3	A2法蘭	
1.5KW   2HPx4P	5~25	32	442	478	185	255	180	241	225	15	15	30.22	70	190	4	138	55	45	32	36.5	10	26.5	A2法蘭
	30~100	40	500	535	230	310	219	297	268	15	20	37.96	76	190	5	138	65	55	40	44		49.3	A2法蘭
	120~200	50	510	543	250	352	249	320	290	18	22	39.2	86	190	5	-	75	65	50	53.5	14	60.2	A2法蘭
2.2KW   3HPx4P	5~10	32	467	502	185	255	180	241	225	15	15	30.22	70	190	4	138	55	45	32	36.5	10	34.2	A2法蘭
	15~60	40	525	560	230	310	219	297	268	15	20	37.96	76	190	5	138	65	55	40	44		50.8	A2法蘭
3.7KW   5HPx4P	75~120	50	535	570	250	352	249	320	290	18	22	39.2	86	190	5	-	75	65	50	53.5	14	55.6	A2法蘭
	5~20	40	552	586	230	310	219	297	268	15	20	37.96	82	230	5	190	65	55	40	44		56.5	A2法蘭
25~100	50	565	600	250	352	249	320	290	18	22	39.2	86	230	5	190	75	65	50	53.5	14	60.0	A2法蘭	

- A1之長度為馬達附剎車之總長。
  - 淺藍色為輕扭力之機型。
  - 1/8~1 HP 之附剎車重量，約無剎車重量加2KG。
  - 2~3 HP 之附剎車重量約無剎車重量加 3.5 KG。
  - 軸徑40mm之鍵寬(w)標準為10mm，12mm為選用規格。
  - Length of A1 is the total length of motor and the brake.
  - Colour in Light blue indicates motor of smaller torque.
  - Weight of 1/8 ~ 1HP motor w / brake shall be weight of motor w / 0 brake + 2Kg.
  - Weight of a 2~3HP motor w / brake is equal to motor w/0 brake + 3.5kg.
  - Keyway (w) for type 40 is 10mm, 12mm is optional.
- \*以上數值若有變動，恕不另行通知\* We reserve the right to change without further notice.

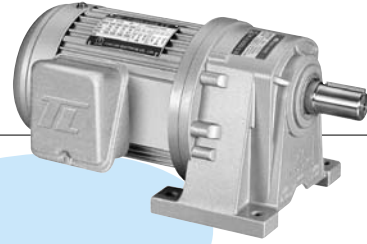

# 35 PL 型(臥式)單相齒輪減速馬達

## PL Type Single-Phase Horizontal Gear Reduction Motor (Foot Mounted)

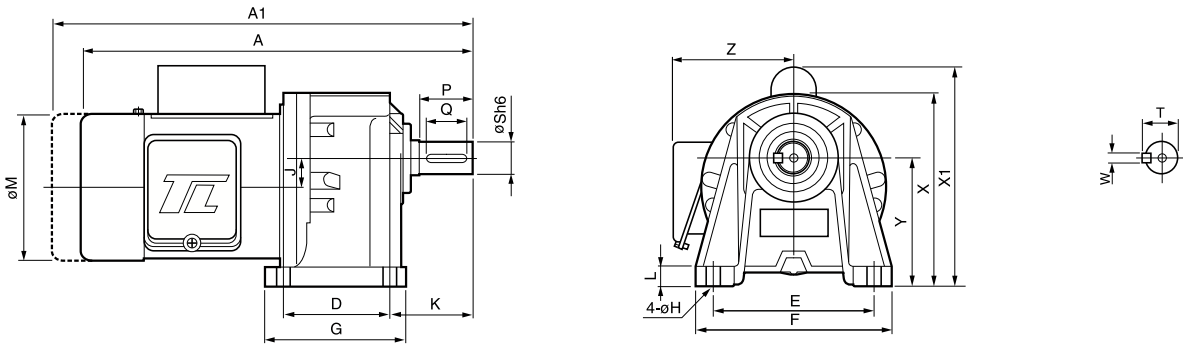

軸徑40mm 之鍵寬(W): 台灣尺寸: 10mm  
大陸尺寸: 12mm

### 馬達尺寸表 Dimensions

馬力 HP	減速比 Gear Ratio	框號 Type	A	A1	D	E	F	G	H	L	J	K	M	X1	X	Y	Z	出力軸端 Output Shaft					重量 App.Wt. Kg
																		P	Q	S	T	W	
0.1KW   1/8HPx4P	5~50	18	255	281	40	110	135	65	9	10	15.98	50	127	-	127	85	116	30	22	18	20	5	5.6
	60~200	22	286	313	65	130	155	90	11	12	17.66	60	127	-	145	90	116	40	30	22	25	7	7.0
	250~1800	22	356	382	65	130	155	90	11	12	17.66	60	127	-	145	90	116	40	30	22	25	7	8.9
	250~1800	28	393	419	90	140	170	120	11	15	23.11	70	127	-	170	110	116	45	35	28	31	7	11.6
0.2KW   1/4HPx4P	5~10	18	290	315	40	110	135	65	9	10	15.98	50	127	-	127	85	116	30	22	18	20	5	6.4
	12.5~25	18	290	315	40	110	135	65	9	10	15.98	50	127	-	127	85	116	30	22	18	20	5	6.4
	12.5~100	22	322	347	65	130	155	90	11	12	17.66	60	127	-	145	90	116	40	30	22	25	7	7.9
	120~200	28	351	376	90	140	170	120	11	15	23.11	70	127	-	170	110	116	45	35	28	31	7	10.3
	250~1800	28	428	453	90	140	170	120	11	15	23.11	70	127	-	170	110	116	45	35	28	31	7	12.4
250~1800	32	462	487	130	170	210	167	13	18	30.22	75	127	-	204	130	116	55	45	32	36.5	10	24.6	
0.4KW   1/2HPx4P	5~10	22	380	440	65	130	155	90	11	12	17.66	60	160	195	145	90	131	40	30	22	25	7	12.6
	12.5~25	22	380	440	65	130	155	90	11	12	17.66	60	160	195	145	90	131	40	30	22	25	7	12.6
	12.5~100	28	410	470	90	140	170	120	11	15	23.11	70	160	210	170	110	131	45	35	28	31	7	15.0
	120~200	32	450	510	130	170	210	167	13	18	30.22	75	160	222	204	130	131	55	45	32	36.5	10	27.2
	250~1800	32	530	590	130	170	210	167	13	18	30.22	75	160	-	204	130	131	55	45	32	36.5	10	29.6
250~1800	40	600	660	150	210	260	200	18	23	37.96	96	160	-	252	160	131	65	55	40	44	$\frac{10}{(12)}$	47.2	
0.75KW   1HPx4P	5~25	28	420	480	90	140	170	120	11	15	23.11	70	192	214	170	110	138	45	35	28	31	7	16.7
	30~100	32	450	510	130	170	210	167	13	18	30.22	75	192	227	204	130	138	55	45	32	36.5	10	29.8
	120~200	40	510	570	150	210	260	200	18	23	37.96	96	192	-	252	160	138	65	55	40	44	$\frac{10}{(12)}$	47.2
	250~1800	40	610	670	150	210	260	200	18	23	37.96	96	192	-	252	160	138	65	55	40	44	$\frac{10}{(12)}$	49.7

- A1之長度為馬達附剎車之總長
- 淺藍色為輕扭力之機型
- 1/8~1 HP之附剎車重量，約無剎車重量加 2 KG.
- 2~3 HP之附剎車重量，約無剎車重量加 3.5 KG.
- 40~50 筒齒箱上附加 O 型吊環 (高度約 50 mm).
- 軸徑40mm之鍵寬(w)標準為10mm, 12mm為選用規格.
- Length of A1 is the total length of motor and the brake.
- Colour in Light blue indicates motor of smaller torque.
- Weight of 1/8 ~ 1HP motor w/brake shall be weight of motor w/o brake + 2Kg.
- Weight of a 2~3HP motor w/brake is equal to motor w/o brake + 3.5kg.
- "O" type rings shall be attached to the 40 ~ 50mm gear box. (add. Height: 50mm)
- Keyway (w) for type 40 is 10mm, 12mm is optional.

\*以上數值若有變動，恕不另行通知\* We reserve the right to change without further notice.





GEAR REDUCER  
GEAR MOTOR



# PF型 (立式)單相齒輪減速馬達

## PF Type Single-Phase Vertical Gear Reduction Motor (with Flange)

36

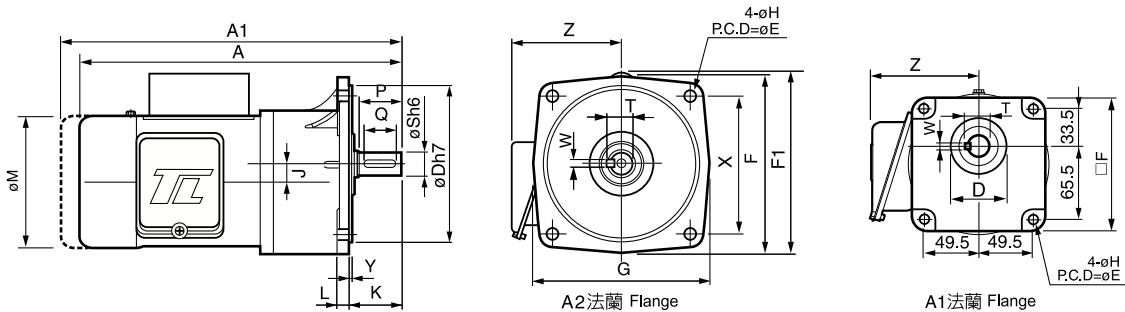

### 馬達尺寸表 Dimensions

軸徑40mm 之鍵寬(W): 台灣尺寸: 10mm  
大陸尺寸: 12mm

馬力 HP	減速比 Gear Ratio	框號 Type	A	A1	D	E	X	F	F1	G	H	L	J	K	M	Y	Z	出力軸端 Output Shaft					重量 App.Wt. Kg	備註 Remark
																		P	Q	S	T	W		
0.1KW   1/8HPx4P	5~50	18	255	281	50	140	99	122	-	-	9	12	15.98	40	125	5	116	30	22	18	20	5	5.5	A1法蘭
	60~200	22	286	313	148	185	131	168	-	165	11	12	17.66	50	125	3.5	116	40	30	22	25	7	7.3	A2法蘭
	250~1800	22	356	385	148	185	131	168	-	165	11	12	17.66	50	125	3.5	116	40	30	22	25	7	9.2	A2法蘭
	250~1800	28	395	420	170	220	156	205	-	195	$\frac{\phi 11}{14L}$	13	23.11	60	125	4	116	45	35	28	31	7	11.9	A2法蘭
0.2KW   1/4HPx4P	5~10	18	290	315	50	140	99	122	-	-	9	12	15.98	40	125	5	116	30	22	18	20	5	6.5	A1法蘭
	12.5~25	18	290	315	50	140	99	122	-	-	9	12	15.98	40	125	5	116	30	22	18	20	5	6.5	A1法蘭
	12.5~100	22	322	347	148	185	131	168	-	165	11	12	17.66	50	125	3.5	116	40	30	22	25	7	8.3	A2法蘭
	120~200	28	351	376	170	220	156	205	-	195	$\frac{\phi 11}{14L}$	13	23.11	60	125	4	116	45	35	28	31	7	11.7	A2法蘭
	250~1800	28	428	453	170	220	156	205	-	195	$\frac{\phi 11}{14L}$	13	23.11	60	125	4	116	45	35	28	31	7	12.8	A2法蘭
0.4KW   1/2HPx4P	250~1800	32	462	487	185	255	180	241	-	225	15	15	30.22	70	125	4	116	55	45	32	36.5	10	25.2	A2法蘭
	5~10	22	380	440	148	185	131	168	195	165	11	12	17.66	50	125	3.5	131	40	30	22	25	7	11	A2法蘭
	12.5~25	22	380	440	148	185	131	168	195	165	11	12	17.66	50	125	3.5	131	40	30	22	25	7	11	A2法蘭
	12.5~100	28	410	470	170	220	156	205	-	195	$\frac{\phi 11}{14L}$	13	23.11	60	125	4	131	45	35	28	31	7	13.4	A2法蘭
	120~200	32	450	510	185	255	180	241	-	225	15	15	30.22	70	125	4	131	55	45	32	36.5	10	24.4	A2法蘭
0.75KW   1HPx4P	250~1800	32	530	590	185	255	180	241	-	225	15	15	30.22	70	125	4	131	55	45	32	36.5	10	26.8	A2法蘭
	250~1800	40	600	660	230	310	219	297	-	268	15	20	37.96	76	125	5	-	65	55	40	44	$\frac{10}{12}$	47.4	A2法蘭
	5~25	28	420	480	170	220	156	205	209.5	195	$\frac{\phi 11}{14L}$	13	23.11	60	158	4	138	45	35	28	31	7	15.1	A2法蘭
	30~100	32	450	510	185	255	180	241	-	225	15	15	30.22	70	158	4	138	55	45	32	36.5	10	26.9	A2法蘭
1HPx4P	120~200	40	510	570	230	310	219	297	-	268	15	20	37.96	76	158	5	138	65	55	40	44	$\frac{10}{12}$	47.4	A2法蘭
	250~1800	40	610	670	230	310	219	297	-	268	15	20	37.96	76	158	5	138	65	55	40	44	$\frac{10}{12}$	49.7	A2法蘭

- A1之長度為馬達附剎車之總長。
  - 淺藍色為輕扭力之機型。
  - 1/8~1 HP 之附剎車重量, 約無剎車重量加2KG.
  - 2~3 HP 之附剎車重量, 約無剎車重量加3.5 KG.
  - 軸徑40mm之鍵寬(w)標準為10mm, 12mm為選用規格。
- Length of A1 is the total length of motor and the brake.
  - Colour in Light blue indicates motor of smaller torque.
  - Weight of 1/8 ~ 1HP motor w/brake shall be weight of motor w/o brake + 2Kg.
  - Weight of a 2~3HP motor w/brake is equal to motor w/o brake + 3.5kg.
  - Keyway (w) for type 40 is 10mm, 12mm is optional.

\*以上數值若有變動, 恕不另行通知\* We reserve the right to change without further notice.

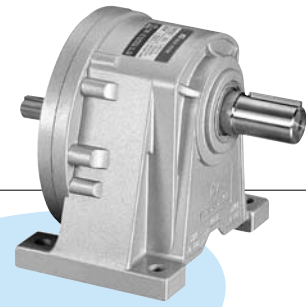

# PLD (臥式)雙軸型齒輪減速機

## PLD Dual-Shaft Type Gear Reducer

### PLD 18 - 0200 - 10

減速比 Ratio: 1/10  
馬力 HP: 200W  
出力軸尺寸 Output Shaft Dimension:  $\phi 18$   
PLD臥式雙軸型 Horizontal Type (Dual-Shaft)

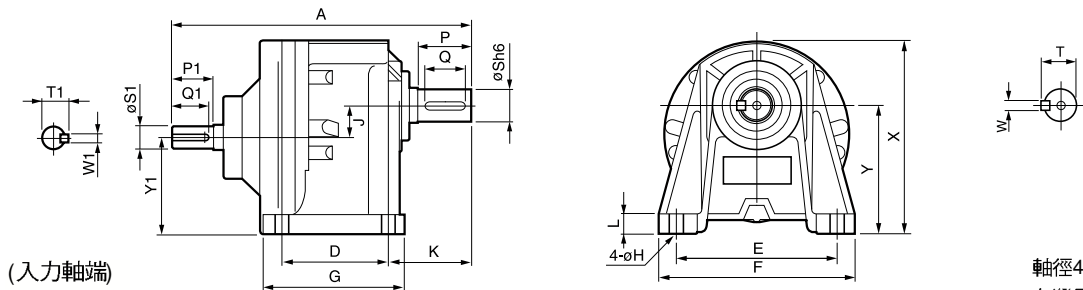

軸徑40mm 之鍵寬(W):  
台灣尺寸: 10mm  
大陸尺寸: 12mm

### 馬達尺寸表 Dimensions

馬力 HP	減速比 Gear Ratio	A	D	E	F	G	H	J	K	L	X	Y	Y1	出力軸端 Output Shaft					入力軸端 Input Shaft					重量 App.Wt. Kg	
														P	Q	S	T	W	P1	Q1	S1	T1	W1		
0.1KW	5~50	18	172	40	110	135	65	9	15.98	50	10	127	85	69	30	22	18	20	5	25	22	14	15.5	4	3
	60~200	22	204	65	130	155	90	11	17.66	60	12	145	90	72.3	40	30	22	25	7	25	22	14	15.5	4	4.2
0.2KW	5~10	18	172	40	110	135	65	9	15.98	50	10	127	85	69	30	22	18	20	5	25	22	14	15.5	4	3
	12.5~25	18	172	40	110	135	65	9	15.98	50	10	127	85	69	30	22	18	20	5	25	22	14	15.5	4	3
	12.5~100	22	204	65	130	155	90	11	17.66	60	12	145	90	72.3	40	30	22	25	7	25	22	14	15.5	4	4.2
0.4KW	120~200	28	266	90	140	170	120	11	23.11	70	15	170	110	87	45	35	28	31	7	30	27	16	18	5	5.5
	5~10	22	204	65	130	155	90	11	17.66	60	12	145	90	72.3	40	30	22	25	7	25	22	14	15.5	4	4.2
	12.5~25	22	204	65	130	155	90	11	17.66	60	12	145	90	72.3	40	30	22	25	7	25	22	14	15.5	4	4.2
	12.5~100	28	266	90	140	170	120	11	23.11	70	15	170	110	87	45	35	28	31	7	30	27	16	18	5	5.5
0.75KW	120~200	32	296	130	170	210	167	13	30.22	75	18	204	130	99.8	55	45	32	36.5	10	30	27	19	21	5	16
	5~25	28	266	90	140	170	120	11	23.11	70	15	170	110	87	45	35	28	31	7	30	27	16	18	5	6.5
	30~100	32	296	130	170	210	167	13	30.22	75	18	204	130	99.8	55	45	32	36.5	10	30	27	19	21	5	19.5
1.5KW	120~200	40	357	150	210	260	200	18	37.96	96	23	252	160	122	65	55	40	44	$\frac{10}{12}$	35	32	24	27	7	38
	5~30	32	296	130	170	210	167	13	30.22	75	18	204	130	99.8	55	45	32	36.5	10	30	27	19	21	5	19.5
	40~100	40	357	150	210	260	200	18	37.96	96	23	252	160	122	65	55	40	44	$\frac{10}{12}$	35	32	24	27	7	38
2.2KW	120~200	50	367	160	230	285	210	18	39.2	104	25	305	176	137.8	75	65	50	53.5	14	45	42	28	31	8	51.2
	5~10	32	296	130	170	210	167	13	30.22	75	18	204	130	99.8	55	45	32	36.5	10	30	27	19	21	5	20.5
	15~60	40	357	150	210	260	200	18	37.96	96	23	252	160	122	65	55	40	44	$\frac{10}{12}$	35	32	24	27	7	39
3.7KW	75~120	50	367	160	230	285	210	18	39.2	104	25	305	176	137.8	75	65	50	53.5	14	45	42	28	31	8	53
	5~20	40	357	150	210	260	200	18	37.96	96	23	252	160	122	65	55	40	44	$\frac{10}{12}$	35	32	24	27	7	39
25~100	50	367	160	230	285	210	18	39.2	104	25	305	176	137.8	75	65	50	53.5	14	45	42	28	31	8	53	

- 淺藍色為輕扭力之機型
- 40~50 筒齒箱上附加O型吊環(高度約50mm).
- 軸徑40mm之鍵寬(w)標準為10mm, 12mm為選用規格.
- Colour in Light blue indicates motor of smaller torque.
- "O" type rings shall be attached to the 40 ~ 50mm gear box. (add. Height: 50mm).
- Keyway (w) for type 40 is 10mm, 12mm is optional.

\*以上數值若有變動, 恕不另行通知\* We reserve the right to change without further notice.

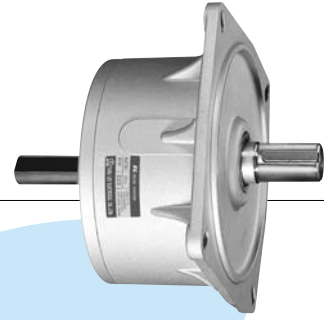

# PFD (立式)雙軸型齒輪減速機

## PFD Dual-Shaft Gear Reducer

### PFD 18 - 0200 - 10

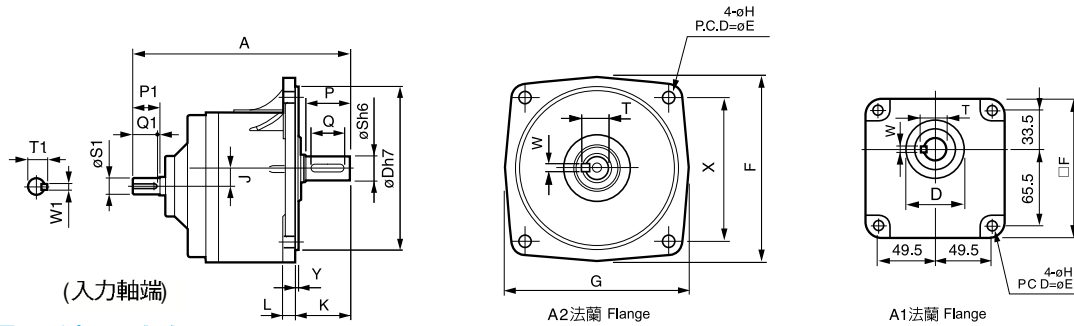
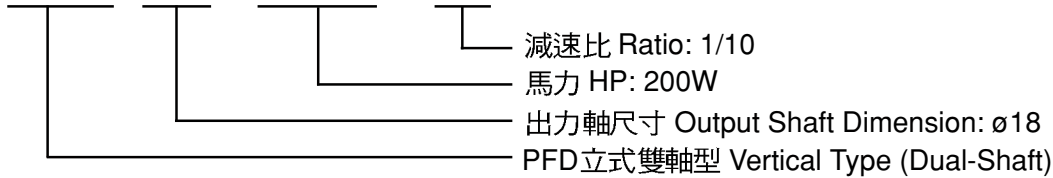

軸徑40mm 之鍵寬(W):  
台灣尺寸: 10mm  
大陸尺寸: 12mm

### 馬達尺寸表 Dimensions

馬力 HP	減速比 Gear Ratio	框號 Type	A	D	E	X	F	G	H	J	K	L	Y	出力軸端 Output Shaft				入力軸端 Output Shaft				重量 App.Wt. Kg	備註 Rrmark		
														P	Q	S	T	W	P1	Q1	S1			T1	W1
0.1KW	5~50	18	172	50	140	99	122	-	9	15.98	40	12	5	30	22	18	20	5	25	22	14	15.5	4	3	A1法蘭
	60~200	22	204	148	185	131	168	165	11	17.66	50	12	3.5	40	30	22	25	7	25	22	14	15.5	4	4.2	A2法蘭
0.2KW	5~10	18	172	50	140	99	122	-	9	15.98	40	12	5	30	22	18	20	5	25	22	14	15.5	4	3	A1法蘭
	12.5~25	18	172	50	140	99	122	-	9	15.98	40	12	5	30	22	18	20	5	25	22	14	15.5	4	3	A1法蘭
	12.5~100	22	204	148	185	131	168	165	11	17.66	50	12	3.5	40	30	22	25	7	25	22	14	15.5	4	4.2	A2法蘭
0.4KW	120~200	28	266	170	220	156	205	195	$\begin{smallmatrix} 0.11 \\ *14L \end{smallmatrix}$	23.11	60	13	4	45	35	28	31	7	30	26	16	18	5	5.5	A2法蘭
	5~10	22	204	148	185	131	168	165	11	17.66	50	12	3.5	40	30	22	25	7	25	22	14	15.5	4	4.2	A2法蘭
	12.5~100	28	266	170	220	156	205	195	$\begin{smallmatrix} 0.11 \\ *14L \end{smallmatrix}$	23.11	60	13	4	45	35	28	31	7	30	26	16	18	5	5.5	A2法蘭
0.75KW	120~200	32	296	185	255	180	241	225	15	30.22	70	15	4	55	45	32	36.5	10	30	26	19	21	5	17	A2法蘭
	5~25	28	266	170	220	156	205	195	$\begin{smallmatrix} 0.11 \\ *14L \end{smallmatrix}$	23.11	60	13	4	45	35	28	31	7	30	26	16	18	5	6.5	A2法蘭
	30~100	32	296	185	255	180	241	225	15	30.22	70	15	4	55	45	32	36.5	10	30	26	19	21	5	19.5	A2法蘭
1.5KW	120~200	40	357	230	310	219	297	268	15	37.96	76	20	5	65	55	40	44	$\begin{smallmatrix} 10 \\ (12) \end{smallmatrix}$	35	32	24	27	7	38	A2法蘭
	5~30	32	296	185	255	180	241	225	15	30.22	70	15	4	55	45	32	36.5	10	30	26	19	21	5	19.5	A2法蘭
	40~100	40	357	230	310	219	297	268	15	37.96	76	20	5	65	55	40	44	$\begin{smallmatrix} 10 \\ (12) \end{smallmatrix}$	35	32	24	27	7	38	A2法蘭
2.2KW	120~200	50	367	250	352	249	320	290	18	39.2	86	22	5	75	65	50	53.5	14	45	42	28	31	8	51.2	A2法蘭
	5~10	32	296	185	255	180	241	225	15	30.22	70	15	4	55	45	32	36.5	10	30	26	19	21	5	20.5	A2法蘭
3.7KW	15~60	40	357	230	310	219	297	268	15	37.96	76	20	5	65	55	40	44	$\begin{smallmatrix} 10 \\ (12) \end{smallmatrix}$	35	32	24	27	7	39	A2法蘭
	75~120	50	367	250	352	249	320	290	18	39.2	86	22	5	75	65	50	53.5	14	45	42	28	31	8	53	A2法蘭
3.7KW	5~20	40	357	230	310	219	297	268	15	37.96	76	20	5	65	55	40	44	$\begin{smallmatrix} 10 \\ (12) \end{smallmatrix}$	35	32	24	27	7	39	A2法蘭
	25~100	50	367	250	352	249	320	290	18	39.2	86	22	5	75	65	50	53.5	14	45	42	28	31	8	53	A2法蘭

1. 淺藍色為輕扭力之機型。

1. Colour in Light blue indicates motor of smaller torque.

3. 軸徑40mm之鍵寬(w)標準為10mm, 12mm為選用規格。

2. Keyway (w) for type 40 is 10mm, 12mm is optional.

\*以上數值若有變動, 恕不另行通知\* We reserve the right to change without further notice.



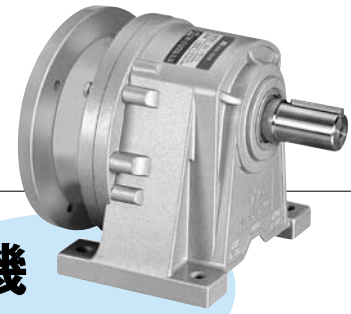

# PLK (臥式)單軸型自配馬達減速機

## PLK Self-Contained Motor Type Gear Reducer

### PLK 18 - 0200 - 10

減速比 Ratio: 1/10  
馬力 HP: 200W  
出力軸尺寸 Output Shaft Dimension:  $\phi 18$   
PLK臥式單軸型 Horizontal Type (Single-Shaft)

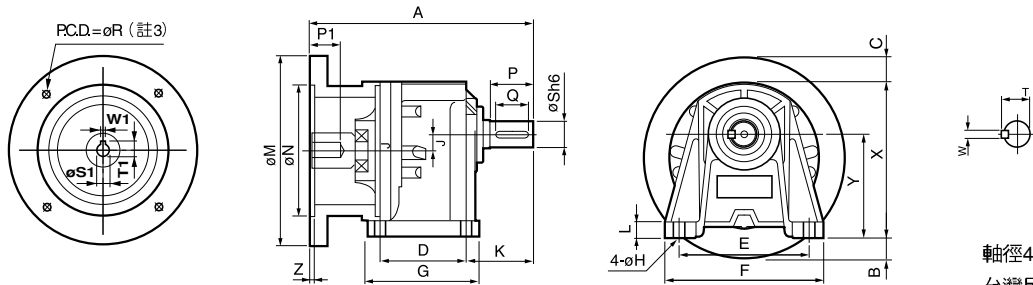

軸徑40mm 之鍵寬(W):  
台灣尺寸: 10mm  
大陸尺寸: 12mm

### 馬達尺寸表 Dimensions

馬力 HP	減速比 Gear Ratio	框號 Type	A	B	C	D	E	F	G	H	J	K	L	M	N	R	X	Y	Z	入力軸端 Input Shaft				出力軸端 Output Shaft				重量 App.Wt. Kg	
																				P1	S1	T1	W1	P	Q	S	T		W
0.1KW	5~50	18	159	11	22	40	110	135	65	9	15.98	50	10	160	110	130	127	85	4	26	11	12.7	4	30	22	18	20	5	5
	60~200	22	191	8	8	65	130	155	90	11	17.66	60	12	160	110	130	145	90	4	26	11	12.7	4	40	30	22	25	7	6.2
0.2KW	5~10	18	159	11	22	40	110	135	65	9	15.98	50	10	160	110	130	127	85	4	26	11	12.7	4	30	22	18	20	5	5
	12.5~25	18	159	11	22	40	110	135	65	9	15.98	50	10	160	110	130	127	85	4	26	11	12.7	4	30	22	18	20	5	5
	12.5~100	22	191	8	8	65	130	155	90	11	17.66	60	12	160	110	130	145	90	4	26	11	12.7	4	40	30	22	25	7	6.2
	120~200	28	220	-	-	90	140	170	120	11	23.11	70	15	160	110	130	170	110	4	26	11	12.7	4	45	35	28	31	7	7.5
0.4KW	5~10	22	191	8	8	65	130	155	90	11	17.66	60	12	160	110	130	145	90	4	33	14	16.2	5	40	30	22	25	7	6.2
	12.5~25	22	191	8	8	65	130	155	90	11	17.66	60	12	160	110	130	145	90	4	33	14	16.2	5	40	30	22	25	7	6.2
	12.5~100	28	220	-	-	90	140	170	120	11	23.11	70	15	160	110	130	170	110	4	33	14	16.2	5	45	35	28	31	7	7.5
	120~200	32	261	-	-	130	170	210	167	13	30.22	75	18	160	110	130	204	130	4	33	14	16.2	5	55	45	32	36.5	10	19
0.75KW	5~25	28	254	135	-	90	140	170	120	11	23.11	70	15	200	130	165	170	110	4.5	43	19	21.7	6	45	35	28	31	7	7.5
	30~100	32	284	-	-	130	170	210	167	13	30.22	75	18	200	130	165	204	130	4.5	43	19	21.7	6	55	45	32	36.5	10	20.5
	120~200	40	340	-	-	150	210	260	200	18	37.96	96	23	200	130	165	252	160	4.5	43	19	21.7	6	65	55	40	44	$\frac{10}{12}$	39
1.5KW	5~30	32	303	-	-	130	170	210	167	13	30.22	75	18	200	130	165	204	130	4.5	53	24	27.2	8	55	45	32	36.5	10	20.5
	40~100	40	341	-	-	150	210	260	200	18	37.96	96	23	200	130	165	252	160	4.5	53	24	27.2	8	65	55	40	44	$\frac{10}{12}$	39
	120~200	50	351	-	-	160	230	285	210	18	39.2	104	30	200	130	165	305	176	4.5	53	24	27.2	8	75	65	50	53.5	14	52.2
2.2KW	5~10	32	317	-	-	130	170	210	167	13	30.22	75	18	250	180	215	204	130	4.5	63	28	31.2	8	55	45	32	36.5	10	21.5
	15~60	40	373	3	-	150	210	260	200	18	37.96	96	23	250	180	215	252	160	4.5	63	28	31.7	8	65	55	40	44	$\frac{10}{12}$	40
	75~120	50	383	-	-	160	230	285	210	18	39.2	104	30	250	180	215	305	176	4.5	63	28	31.2	8	75	65	50	53.5	14	54
3.7KW	5~20	40	373	3	-	150	210	260	200	18	37.96	96	23	250	180	215	252	160	4.5	63	28	31.2	8	65	55	40	44	$\frac{10}{12}$	40
	25~100	50	383	-	-	160	230	285	210	18	39.2	104	30	250	180	215	305	176	4.5	63	28	31.2	8	75	65	50	53.5	14	54

1. 淺藍色為輕扭力之機型。
2. 40~50 筒齒箱上附加 O 型吊環 (高度約 50 mm)。
3. 中間垂直螺絲孔 1/8~1/4 HP 為 M8\*P1.25.  
1/2~2 HP 為 M10\*P1.5. 3 HP 為 M14\*P2.  
Central screw hole for the 1/2 ~ 2HP motor shall be M10\*P1.5.  
Central screw hole for the 3HP motor shall be M14\*P2.
4. 軸徑40mm之鍵寬(w)標準為10mm, 12mm為選用規格。 Keyway (w) for type 40 is 10mm, 12mm is optional.

\*以上數值若有變動, 恕不另行通知\* We reserve the right to change without further notice.





# TL系列—軸上型蝸輪減速機

## TL 4070 - 0400 - 30 S3 B

附剎車  
 電壓: A: 110V                      C: 220V  
              S<sub>1</sub>: 三相220/380V      S<sub>2</sub>: 三相220/440V  
 減速比: 30, 40, 50, 60, 75, 100, 120, 132,  
              150, 180, 200, 250, 300  
 馬力: 100W, 200W, 400W, 750W, 1500W  
 框號代號: 4060, 4070, 5080  
 軸上型代號

### 應用範例 Examples

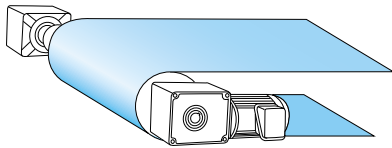

輸送機 CONVEYER

### 零件組合圖 System Drawn

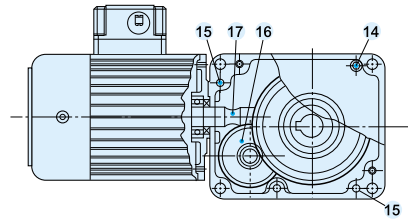
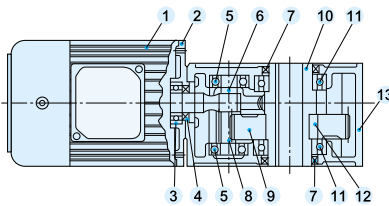

No.	零件名稱	Name of Parts
1	馬達	Motor
2	馬達盤	Motor Cover
3	滾珠軸承	Ball Bearing
4	油封	Oil Seal
5	滾珠軸承	Ball Bearing
6	雙圓鍵	Key

No.	零件名稱	Name of Parts
7	油封	Oil Seal
8	A齒輪軸	A Gear Shaft
9	B齒輪	B Gear
10	出力套軸	Output Shaft Bushing
11	滾珠軸承	Ball Bearing
12	雙圓鍵	Key

No.	零件名稱	Name of Parts
13	齒輪箱	Gear Shell
14	內六角螺絲	Hex. Screw
15	定位梢	Location Pin
16	蝸輪	Worm Wheel
17	蝸桿	Worm Shaft

### 安裝方式 Installation

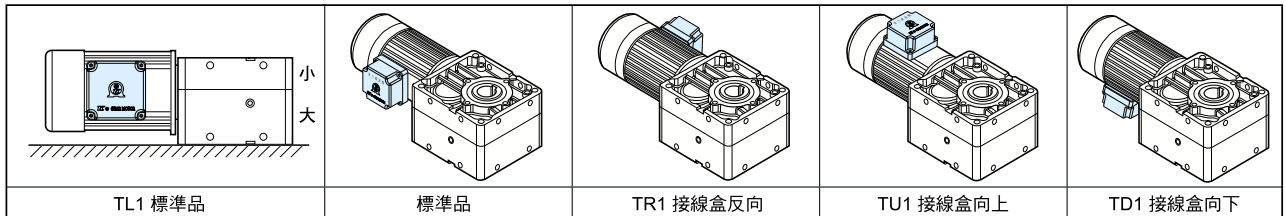

### 轉矩表 Torque Table (Kg·m)

減速比	4060						4070						5080					
	0.1kW		0.2kW		0.4kW		0.1kW		0.2kW		0.4kW		0.4kW		0.75kW		1.5kW	
	50Hz	60Hz	50Hz	60Hz	50Hz	60Hz	50Hz	60Hz	50Hz	60Hz	50Hz	60Hz	50Hz	60Hz	50Hz	60Hz	50Hz	60Hz
30	1.76	1.44	3.51	2.87	6.88	5.74	1.76	1.44	3.51	2.87	6.88	5.74	6.88	5.74	12.87	10.64	25.49	21.53
40	2.34	1.91	4.69	3.83	9.17	7.66	2.34	1.91	4.69	3.83	9.17	7.66	9.17	7.66	17.16	14.19	33.99	28.71
45	2.64	2.15	5.27	4.31	10.32	8.61	2.64	2.15	5.27	4.31	10.32	8.61	10.32	8.61	19.31	15.96	38.24	32.30
50	2.93	2.39	5.86	4.79	11.47	9.57	2.93	2.39	5.86	4.79	11.47	9.57	11.47	9.57	21.45	17.74	42.49	35.89
60	3.41	2.78	7.03	5.74	13.76	11.48	3.41	2.78	6.82	5.57	13.34	11.14	13.34	11.14	24.96	20.64	49.44	41.76
75(80)	4.69	3.83	9.37	7.66	18.35	15.31	4.39	3.59	8.79	7.18	17.20	14.36	17.20	14.36	32.18	26.61	63.73	53.83
100	5.68	4.64	11.36	9.28	22.24	18.56	5.68	4.64	11.36	9.28	22.24	18.56	22.24	18.56	41.60	34.40	82.40	69.60
120	6.82	5.57	13.63	11.14	26.69	22.27	6.82	5.57	13.63	11.14	26.69	22.27	26.69	22.27	49.92	41.28	82.40	83.52
132	7.50	6.12	15.00	12.25	29.36	24.5	7.50	6.12	15.00	12.25	29.36	24.50	29.36	24.50	54.91	45.41	82.40	83.52
150	8.52	6.96	17.04	13.92	33.36	27.84	8.52	6.96	17.04	13.92	33.36	27.84	33.36	27.84	62.40	51.60	82.40	83.52
180	10.22	8.35	20.45	16.70	40.03	33.41	10.22	8.35	20.45	16.70	40.03	33.41	40.03	33.41	70.20	61.92	82.40	83.52
200	11.01	8.99	22.01	17.98	43.09	35.96	11.01	8.99	22.01	17.98	43.09	35.96	43.09	35.96	70.20	66.65	82.40	83.52
250	11.01	8.99	22.01	17.98	43.09	35.96	11.01	8.99	22.01	17.98	43.09	35.96	43.09	35.96	70.20	66.65	82.40	83.52
300	11.01	8.99	22.01	17.98	43.09	35.96	11.01	8.99	22.01	17.98	43.09	35.96	43.09	35.96	70.20	66.65	82.40	83.52

\*以上數值若有變動，恕不另行通知\* We reserve the right to change without further notice.

# TL Series Shaft-Mounted Reducer

## Model: TL4060

減速比 (Ratio):  
1/30~1/300

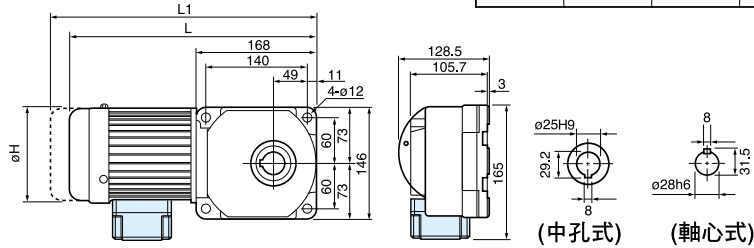

尺寸表 Dimension 單位: mm

馬力 (4P)	L 標準	L1 含剎車	$\phi$ H	重量 (Kg)
0.1kW	328	351	127	12.0
0.2kW	345	370	127	13.0
0.4kW	363	388	127	15.0

## Model: TL4070

減速比 (Ratio):  
1/30~1/300

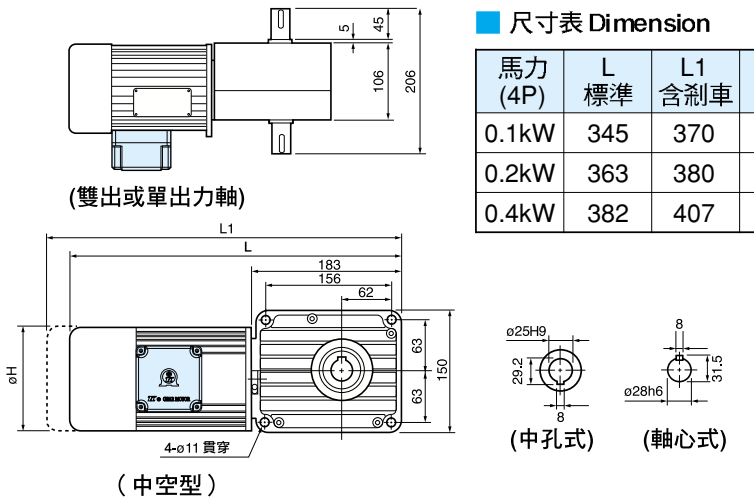

尺寸表 Dimension 單位: mm

馬力 (4P)	L 標準	L1 含剎車	$\phi$ H	重量 (Kg)
0.1kW	345	370	127	12.5
0.2kW	363	380	127	13.5
0.4kW	382	407	127	15.5

## Model: TL5080

減速比 (Ratio):  
1/30~1/300

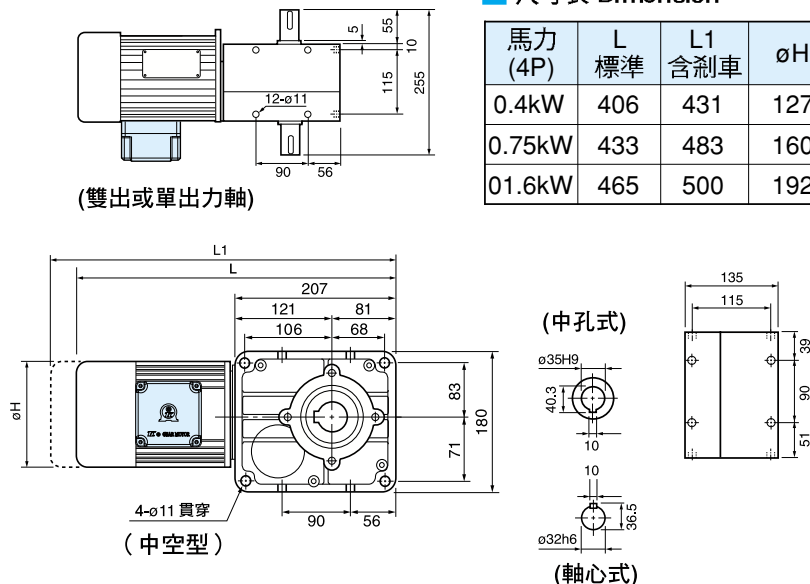

尺寸表 Dimension 單位: mm

馬力 (4P)	L 標準	L1 含剎車	$\phi$ H	重量 (Kg)
0.4kW	406	431	127	20
0.75kW	433	483	160	25.2
01.6kW	465	500	192	30.5

\* L1之長度為馬達附剎車之總長。(L1 is the total length of motor with brake.)

\* 出線盒可指定向上, 向下, 左邊, 右邊。(Terminal Box position can be changed.)

\* 以上數值若有變動, 恕不另行通知\* We reserve the right to change without further notice.



# 鋁合金中空型渦輪減速機

機種代號說明：

**NRM - 030 - 010 - 0.4**

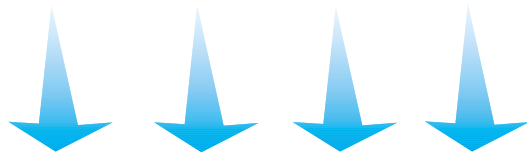

NR: 單入力軸型  
Input Shaft  
NRM: 法蘭型  
Flange

型號  
(Model)

減速比  
(Ratio)

馬力  
(KW)

使用差異 *Difference in usage*

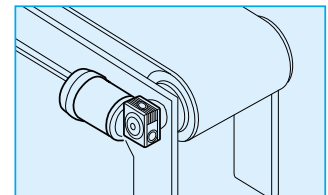
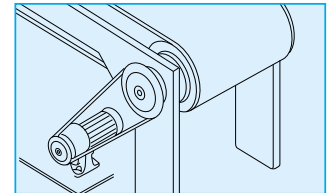
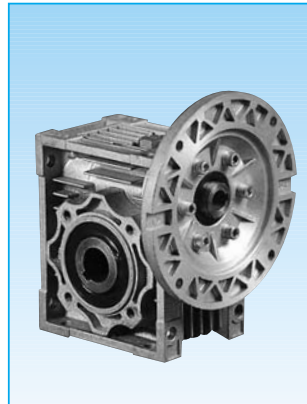

43

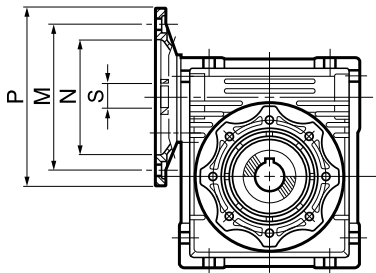

不佔空間及降低成本的代名詞

- 1. 自鎖功能:**  
對於一般需要微保持力的使用場合，可節省裝置制動器的費用，如（爬坡型輸送機）。
- 2. 安全性高:**  
使用不同於傳統的傳動方式，免鏈輪、皮帶輪，傳動結構不外露，減少作業人員的傷害。
- 3. 可多面安裝，無角度限制:**  
全系列產品，每個平面，皆有固定孔，您可選擇安裝時所需的方向、角度安裝。

## 標準馬達直結型選擇表（一段型）

框號	PAM IEC	馬力 (4P) kW	N	M	P	S (Input Shaft Dia. 入力軸徑 / Gear Ratio 減速比)												
						5	7.5	10	15	20	25	30	40	50	60	80	100	
NRM030 鋁合金	63B14	0.2	60	75	90	11	11	11	11	11	11	11	11	11	-	-	-	
	TL, 方型	0.06/0.09	83	104	90	12	12	12	12	12	12	12	12	12	12	12	-	-
NRM040 鋁合金	71B5	0.4	110	130	160	14	14	14	14	14	14	14	-	-	-	-	-	
	71B5	0.2	110	130	160	11	11	11	11	11	11	11	11	11	11	-	-	
	TL, 方型	0.09	83	104	90	11	11	11	11	11	11	11	11	11	11	-	-	
NRM050 鋁合金	80B5	0.75	130	165	200	19	19	19	19	19	19	19	-	-	-	-	-	
	71B5	0.4	110	130	160	14	14	14	14	14	14	14	14	14	14	-	-	
	71B5	0.2	110	130	160	11	11	11	11	11	11	11	11	11	11	11	11	
NRM063 鋁合金	90B5	1.5	130	165	200	24	24	24	24	24	24	24	-	-	-	-	-	
	80B5	0.75	130	165	200	19	19	19	19	19	19	19	19	19	-	-	-	
	71B5	0.4	110	130	160	-	-	14	14	14	14	14	14	14	14	14	14	
NRM075 鋁合金	100/112B5	2.2/3.7	180	215	250	-	28	28	28	-	-	-	-	-	-	-	-	
	90B5	1.5	130	165	200	-	24	24	24	24	24	24	24	-	-	-	-	
	80B5	0.75	130	165	200	-	-	-	-	19	19	19	19	19	19	19	19	
NRM090 鑄鐵	100/112B5	2.2/3.7	180	215	250	-	28	28	28	28	28	28	-	-	-	-	-	
	90B5	1.5	130	165	200	-	24	24	24	24	24	24	24	24	24	-	-	
	80B5	0.75	130	165	200	-	-	-	-	-	-	-	19	19	19	19	19	
NRM110 鑄鐵	132B5	5.5/7.5	230	265	300	-	38	38	38	38	-	-	-	-	-	-	-	
	100/112B5	2.2/3.7	180	215	250	-	28	28	28	28	28	28	28	28	28	-	-	
	90B5	1.5	130	165	200	-	-	-	-	-	24	24	24	24	24	24	24	
NRM130 鑄鐵	80B5	0.75	130	165	200	-	-	-	-	-	-	-	-	-	-	-	19	19
	132B5	5.5/7.5	230	265	300	-	38	38	38	38	38	38	38	-	-	-	-	
	100/112B5	2.2/3.7	180	215	250	-	-	-	-	-	28	28	28	28	28	28	28	
	90B5	1.5	130	165	200	-	-	-	-	-	-	-	-	-	-	-	24	24

\*另有扭力臂、單出力軸、雙出力軸、輸出法蘭可選配。(Torque arm, single shaft, dual shaft, output flange are optional.)

\*以上數值若有變動，恕不另行通知\* We reserve the right to change without further notice.



# Hollow Shaft Worm Gear Reducer

## NR/NRM 尺寸圖 (一段型) *Dimensions (One stage type)*

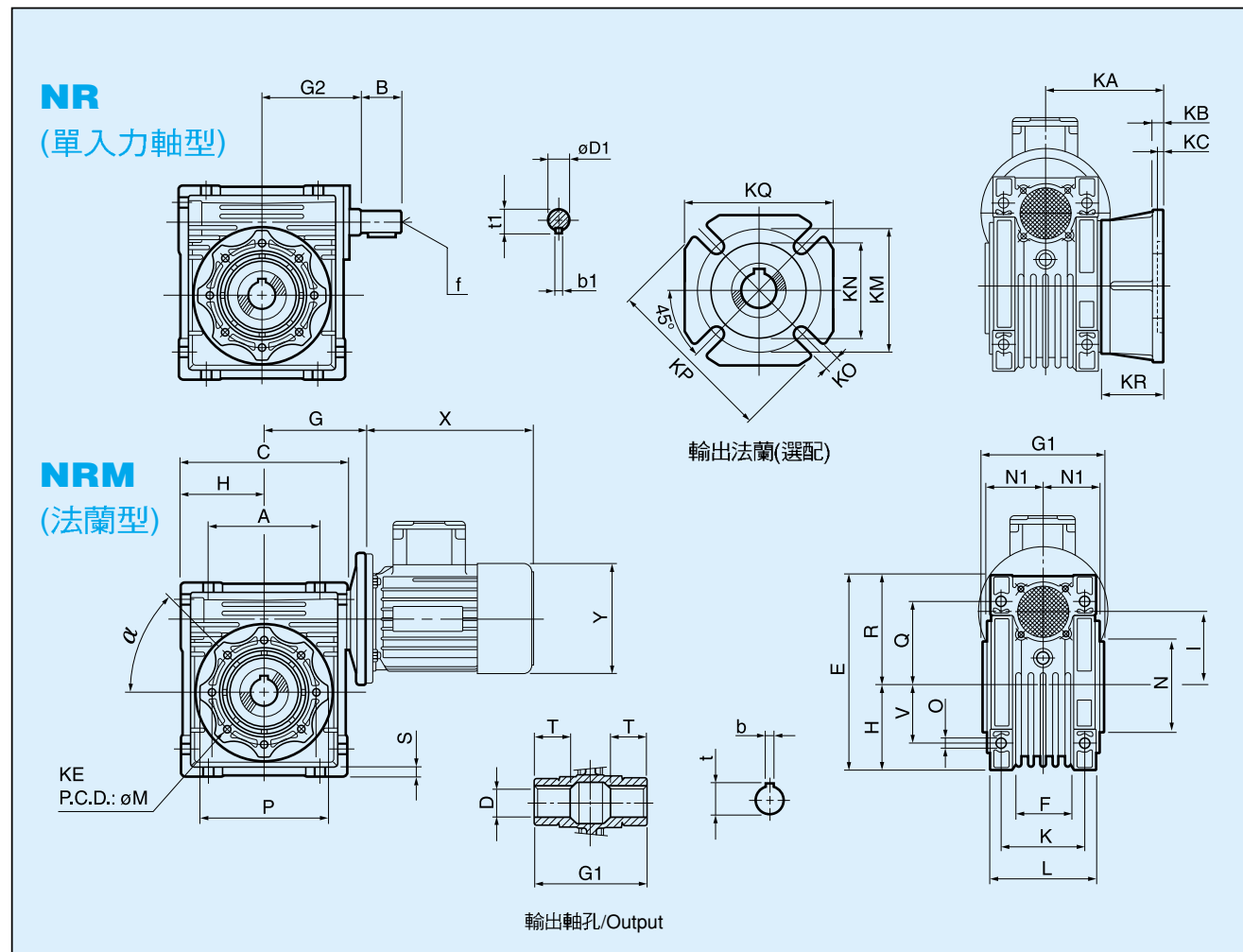

尺寸 型式	A	B	C	D (H7)	D1 (j6)	E	F	G	G1	G2	H	I	L	M	N	N1	O	P	Q	R	S	T
030	54	20	80	14	9	98.5	32	57	65	51	40	30	56.5	65	55	30	6	75	44	57	6.5	21
040	70	23	101.5	18 (19)	11	123	43	72	80.4	60	50.5	40	71	75	60	36.5	6.5	90	55	73	7	26
050	80	30	120.5	25 (24)	14	145	49	80	93.5	74	60	50	85	85	70	44.35	8	100	64	85	7.5	30
063	100	40	148	25 (28)	19	174	72	102	112.2	90	72	63	103	95	80	53	8	110	80	102	7.5	36
075	120	50	175	28 (35)	24	205	74	113.5	119.2	105	86	75	112	115	95	59	11	140	93	119	8	40

尺寸 型式	V	K	KA	KB	KC	KE	KM	KN	KO	KP	KQ	KR	b	b1	f	t	t1	Kg
030	27	44	55	6	3.7	M6x11 n. 4	68	50	6 n. 4	80	70	25	5	3	-	16.3	10.2	1.2
040	35	60	68	7.5	5.7	M6x10 n. 4	74	60	9 n. 4	110	95	30	6 (6)	4	-	20.8 (21.8)	12.5	2.3
050	40	70	91.5	9	5.7	M8x10 n. 4	85	70	11 n. 4	124	110	47	8 (8)	5	M6	28.3 (27.3)	16.0	3.5
063	50	85	82.5 (113)	10 (11)	6 (7)	M8x14 n. 8	150	115	11 n. 4	180	145	29.5 (60)	8 (8)	6	M6	28.3 (31.3)	21.5	6.2
075	60	90	111.5	13	6	M8x14 n. 8	162	130	14 n. 4	198	168	54	8 (10)	8	M8	31.3 (38.3)	27.0	9

圖中X與Y軸的尺寸請參考所使用的馬達。

Please refer to the motor used for the size of X and Y in the figure.

\*以上數值若有變動，恕不另行通知\* We reserve the right to change without further notice.





# 伺服專用減速機-TRS型 (歐規) / TRK型 (日規)

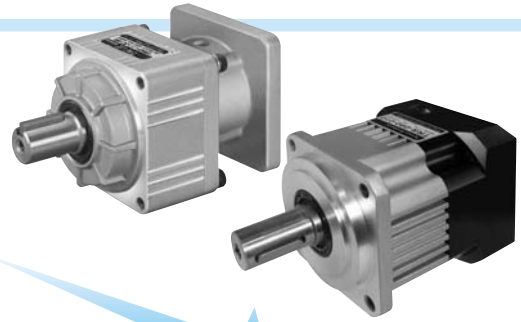

**TRS - 060 - 010 - P1 / □**

TRS: 歐規機種  
European spec.  
TRK: 日規機種  
Japan spec.

減速比 Ratio

Stage	Type	TRS	TRK
一段式		3~10	3~5
二段式		12~100	6~25

配合馬達廠牌及型號  
Motor brand & Model

歐規尺寸 Dimension of device  
042, 060, 090, 115, 142, 180  
日規尺寸 Dimension of device  
B, C, D, E, F

P0 超精密背隙:	P1 精密背隙:	P2 標準背隙:
一段式: 0.05° (3弧分以下)	一段式: 0.1° (6弧分以下)	一段式: 0.13° (8弧分以下)
二段式: 0.08° (5弧分以下)	二段式: 0.13° (8弧分以下)	二段式: 0.20° (12弧分以下)
P0 Grade Backlash	P1 Grade Backlash	P2 Grade Backlash
One stage Less than 0.05° (3 Arc-min)	One stage Less than 0.1° (6 Arc-min)	One stage Less than 0.13° (8 Arc-min)
Two stage Less than 0.08° (5 Arc-min)	Two stage Less than 0.13° (8 Arc-min)	Two stage Less than 0.20° (12 Arc-min)

## 減速機出力軸容許徑向力 *Permissible Radial Force and Axial Force*

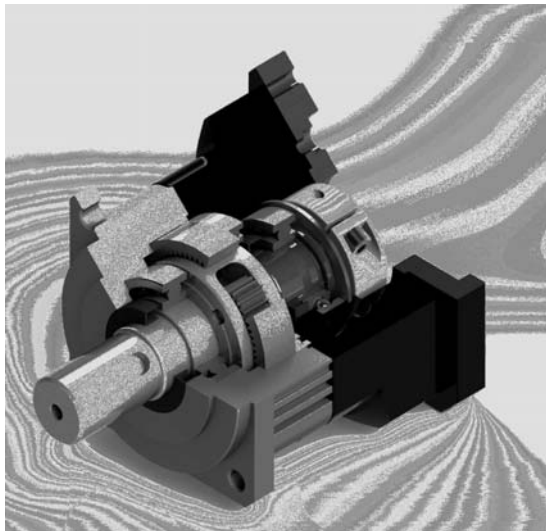

從減速機出力軸連接鏈條齒輪等傳動機構時，會承受徑向力，徑向力  
 $OHL=(T \times s \times f \times p)/R$

T=機構端扭力

s=負荷係數

F=驅動方式的載重係數

P=位置係數: 負載點小於等於d時, P=1

R=皮帶輪或鏈輪半徑

負載點大於d時, P=1.5

The gearbox will bear radial force while its output shaft connected with transmission machinery, such as chain wheel.

The O.H.L. formula of radial force is as below:

•  $OHL=(T \times s \times f \times p)/R$

• T= Torque of transmission machinery

• s= Service factor

• f= Driven Coefficient

• R= Radial of pulley or chain wheel

• p= Position, Position less than d, p=1

position larger than d, p=1.5

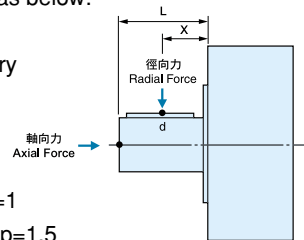

## 負荷係數表 (s) *Service factor table*

傳動機負荷等級 Loading classification	每日使用時數Running per day			
	0.5hr	2hr	8-10hr	10-24hr
均負荷 Uniform	0.80	0.90	1.00	1.25
中衝擊Medium shock	0.9	1.00	1.25	1.50
動衝擊Heavy shock	1.00	1.25	1.50	1.75

## 驅動方式載重係數係數 *Driven Coefficient(f)*

傳動方式 Driving mode	(f)
鏈條/齒型皮帶 Chain pulley	1.00
齒輪 Gear	1.25
V型皮帶 V-belt	1.5
平皮帶 Flat-belt	2.5

• 正轉、逆轉或起動、停止，1小時內達10次者，請將右上表的值乘以1.2。

• CW/CCW Operation or start-up/stop reaches 10 times or more within 1 hour, please multiply by 1.2.

# Servo Reducer-TRS

## 性能表 Specification

規 格	段數(Section)	減速比(Ratio)	TRS-042	TRS-060	TRS-090	TRS-115	TRS-142	TRS-180
額定輸出力矩 (N·m)	一段式	3	18	47	135	295	570	1140
		4	17	43	126	276	523	1045
		5	20	51	144	314	523	1140
		6	18	47	135	295	570	1045
		7	17	43	126	285	523	1045
		8	15	38	108	247	475	950
		9	13	34	90	219	428	855
		10	13	34	90	219	428	855
	二段式	15	18	47	135	295	570	1140
		20	17	43	126	276	523	1045
		25	20	51	144	314	618	1140
		30	18	47	135	295	570	1045
		35	17	43	126	285	523	1045
		40	15	38	108	247	475	950
		45	13	34	90	219	428	855
		50	20	51	144	314	618	1140
		60	18	47	135	295	570	1045
		70	17	43	126	285	523	1045
		80	15	38	108	247	475	950
90	13	34	90	219	428	855		
100	13	41	90	219	428	855		
最大輸出力矩 T2B N·m	一段式、二段式	3-100	3倍額定輸出力矩					
額定輸入轉速 NIN RPM	一段式、二段式	3-100	5,000	5,000	4,000	4,000	3,000	3,000
最大輸入轉速 NIB RPM	一段式、二段式	3-100	10,000	10,000	8,000	8,000	6,000	6,000
超精密背隙 P0 Arc-Min	一段式	3-10	≤3	≤3	≤3	≤3	≤3	≤3
	二段式	15-100	≤5	≤5	≤5	≤5	≤5	≤5
精密背隙 P1 Arc-Min	一段式	3-10	≤6	≤6	≤6	≤6	≤6	≤6
	二段式	15-100	≤8	≤8	≤8	≤8	≤8	≤8
標準背隙 P2 Arc-Min	一段式	3-10	≤8	≤8	≤8	≤8	≤8	≤8
	二段式	15-100	≤12	≤12	≤12	≤12	≤12	≤12
扭轉剛性 N·m/Arc-Min	一段式、二段式	3-100	3	7	14	25	50	145
容許徑向力 F <sub>2RBN</sub>	一段式、二段式	3-100	780	1530	3250	6700	9400	14500
容許軸向力 F <sub>2ABN</sub>	一段式、二段式	3-100	390	765	1625	3350	4700	7250
使用壽命 HR	一段式、二段式	3-100	20000					
效率 η %	一段式	3-10	≥96%					
	二段式	15-100	≥93%					
使用溫度 °C	一段式、二段式	3-100	-10 °C~+90 °C					
潤滑油品	一段式、二段式	3-100	CPC高黏性滑脂					
防護等級	一段式、二段式	3-100	IP65					
安裝方向	一段式、二段式	3-100	任意方向					
噪音值 (N1=3000RPM) db	一段式、二段式	3-100	<58	<60	<60	<63	<65	<67

## 減速機轉動慣量 Moment of Inertia

規 格	段數(Section)	減速比(Ratio)	TRS-042	TRS-060	TRS-090	TRS-115	TRS-142	TRS-180
轉動慣量 J1 (Kg · m <sup>2</sup> )	一段式	3	0.05	0.24	1.04	5.05	14.61	46.76
		4	0.04	0.18	0.71	3.67	10.57	33.53
		5	0.04	0.17	0.64	3.34	9.66	30.31
		6	0.03	0.15	0.56	3.01	8.66	27.07
		7	0.03	0.15	0.52	2.85	8.24	25.57
		8	0.03	0.14	0.49	2.73	7.88	24.37
		9	0.03	0.14	0.48	2.66	7.65	23.63
		10	0.03	0.14	0.47	2.62	7.54	23.23
	二段式	15	0.04	0.04	0.22	0.70	3.5	10.19
		20	0.04	0.04	0.21	0.66	3.39	9.84
		25	0.04	0.04	0.21	0.66	3.37	9.76
		30	0.04	0.04	0.21	0.65	3.34	9.66
		35	0.04	0.04	0.21	0.64	3.32	9.62
		40	0.04	0.04	0.21	0.64	3.31	9.58
		45	0.04	0.04	0.20	0.64	3.30	9.56
		50	0.03	0.03	0.15	0.52	2.63	7.56
		60	0.03	0.03	0.15	0.52	2.61	7.54
		70	0.03	0.03	0.15	0.52	2.61	7.53
		80	0.03	0.03	0.15	0.52	2.61	7.52
90	0.03	0.03	0.15	0.52	2.61	7.51		
100	0.03	0.03	0.15	0.52	2.61	7.51		

\*以上數值若有變動，恕不另行通知\* We reserve the right to change without further notice.





# 伺服專用減速機-TRS型 (歐規) / TRK型 (日規)

## ■ TRS 尺寸圖 (歐規)

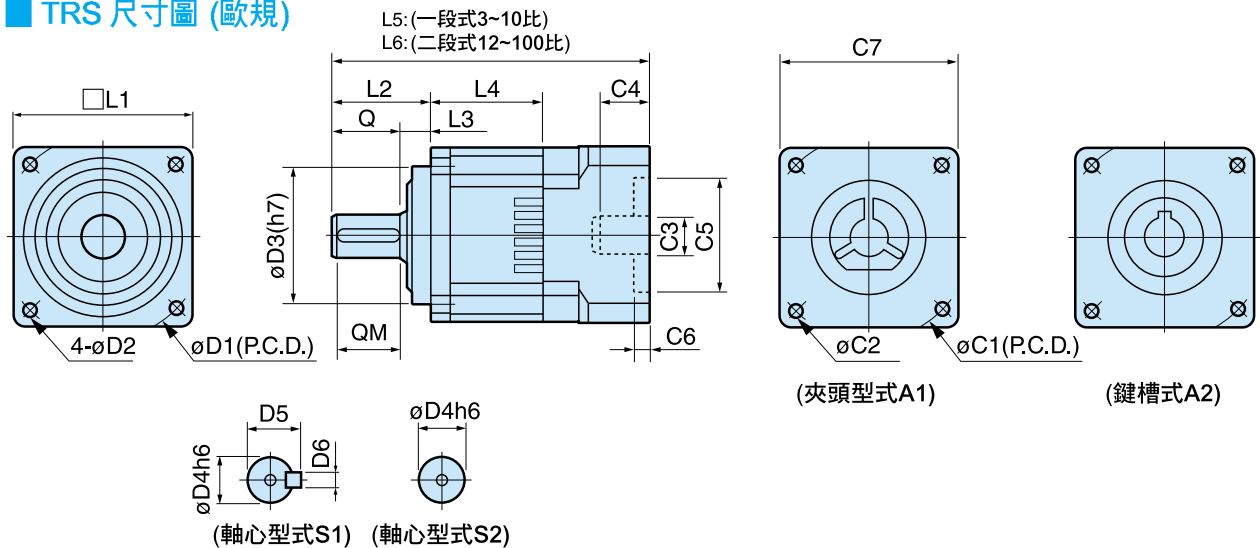

## ■ 尺寸表 (mm)

型號	L1	L2	L3	L4	L5	L6	Q	QM	D1	D2	D3	D4	D5	D6	C代號=>配合馬達可變更尺寸						
															C1	C2	C3	C4	C5	C6	C7
TRS-042	44	30	5	25	82		20	15	50	4	35	13	15	4	45	M3	8	15	30	4	44
TRS-060	63	38	10	40	130	160	28	22	70	5.5	50	16	18.5	5	70	M5	14	30	50	4	63
TRS-090	90	50	15	45	152	190	35	29	100	6.5	80	22	25	6	100	M6	19	40	80	5	91
TRS-115	115	65	15	48	200	240	50	42	130	9	110	32	37	10	130	M8	24	60	110	7	130
TRS-142	142	96	18	67	270	320	78	68	165	11	130	40	46	12	165	M10	35	70	130	7	143
TRS-180	180	105	30	85	330	415	80	73	215	13.5	160	55	63	16	215	M10	48	80	180	7	192

## ■ TRK 尺寸圖 (日規)

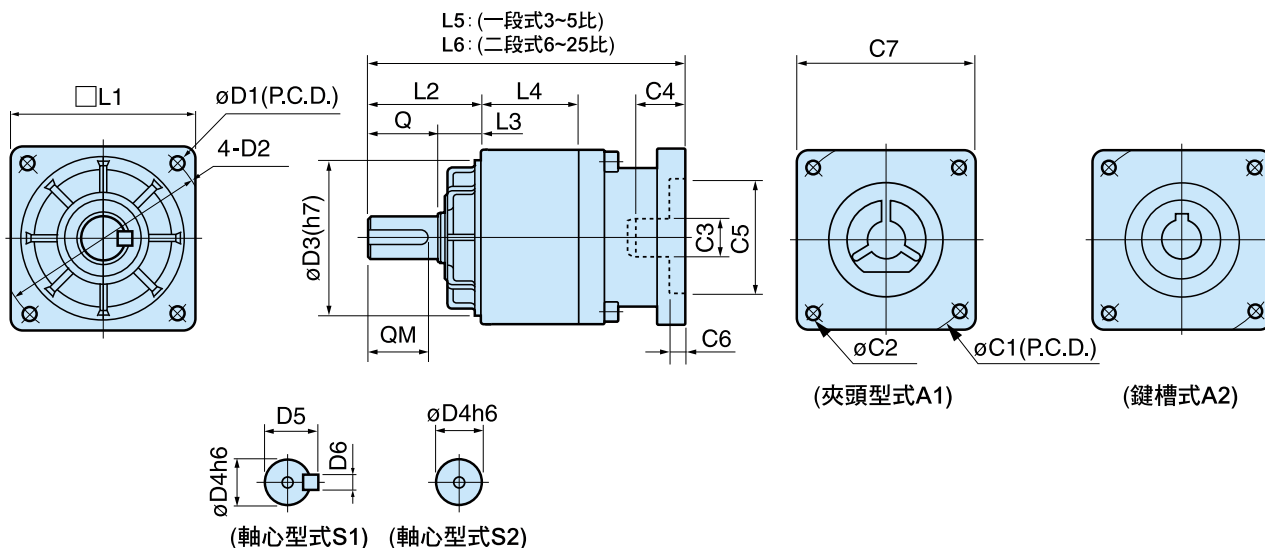

## ■ 尺寸表 (mm)

型號	L1	L2	L3	L4	L5	L6	Q	QM	D1	D2	D3	D4	D5	D6	C代號=>配合馬達可變更尺寸						
															C1	C2	C3	C4	C5	C6	C7
TRK-B	65	38	10	38	126	156	28	25	70	M5	50	16	18.5	5	70	M5	14	25	50	4	65
TRK-C	77	52	22	45	146	172	30	27	90	M6	70	19	22	6	90	M6	19	30	70	4	80
TRK-D	98	62	22	50	180	210	40	35	114	M8	90	24	28	8	115	M8	28	40	80	5	100
TRK-E	125	73	23	57	230	280	50	47	135	M10	110	32	37	10	135	M10	32	60	110	7	125
TRK-F	154	90	34	75	196	340	65	60	170	M10	130	40	46	12	145	M10	48	66	110	7	154

\*以上數值若有變動，恕不另行通知\* We reserve the right to change without further notice.

# Servo Reducer-TRK/TRS

## 適用馬力 (W) 3000RPM

型號	A1 減速比	馬力(W)
TRS-042	3~100	50~200
TRS-060/TRK-B	3~100	200~400
TRS-090/TRK-C	3~100	400~750
TRS-115/TRK-D	3~100	750~1500
TRS-142/TRK-E	3~100	1500~3500
TRS-180/TRK-F	3~100	3500~4500

## 伺服馬達標準裝配系列

- \* 松下電器產業 (株) / MIMAS 系列
- \* 安川電機 / SGM, SGMH 系列
- \* 三菱電機 (株) / HA-ME/HC-MF 系列
- \* 日機電裝 (株) / NA50 / NA70 系列
- \* 神鋼電機 (株) / BM / ZM 系列
- \* 東榮電機 (株) / T.Z 系列
- \* 山洋電氣 (株) / P3 系列
- \* 富士電機 (株) / FALDIC 系列
- \* 東元精電伺服馬達
- \* 台達伺服馬達

48

## 伺服減速機與馬達安裝順序 Servo Reducer and Servo Motor Mounting Instruction

1. 伺服減速機組裝前，請先確認入力軸固定束環的螺絲對準開口。  
Make sure the screw on the set collar is line up with the open on adapter plate.
2. 請小心將馬達與減速機組裝。請勿轉動入力軸固定束環。  
Install the motor and the reducer. Do not rotate the set collar.
3. 依對角順序將法蘭螺絲鎖緊。  
Tighten the mounting bolts on flange in diagonal order.
4. 再次確認所有螺絲都確實鎖緊。  
Make sure all the bolts are tighten.

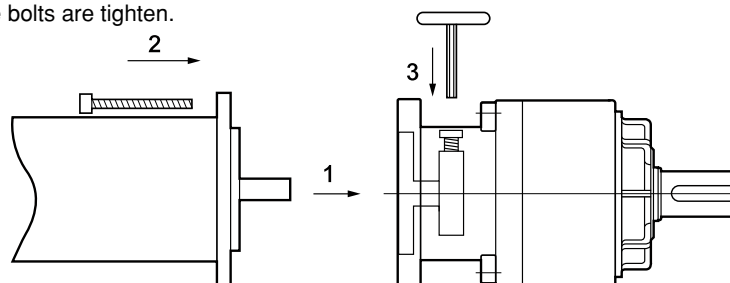

★ 訂貨時，請把貴公司所使用的馬達廠牌、型號及尺寸依此表格填寫並告知本公司。  
Please fill in the blank in the table below.

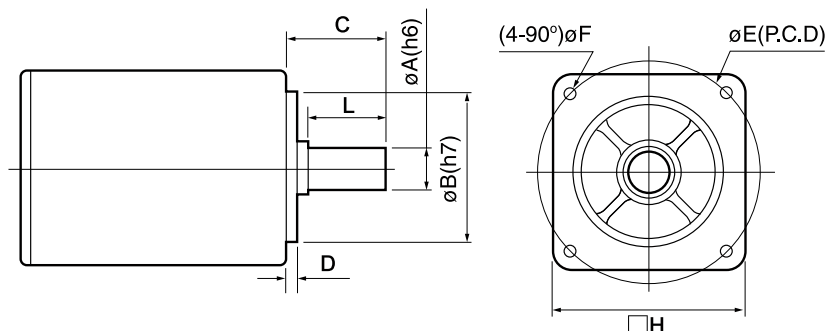

廠牌： \_\_\_\_\_ 型號： \_\_\_\_\_

序 號	軸心 外徑 $\phi A(h6)$	凸緣 外徑 $\phi B(h7)$	軸心 長度 C	凸緣 高度 D	螺絲孔 中心距 $\phi E$	螺絲孔 直徑 $\phi F$	馬達面 尺寸 $\square H$	軸心 有效長 L	備 註

\*以上數值若有變動，恕不另行通知\* We reserve the right to change without further notice.





# DISCO 無段變速機 (Variable Speed Control Motor)

## A系列標準型附加法蘭

### A series standard model with flange

■ 馬力(KW) : 0.2~3.7KW

■ 變速範圍 Range of speed variation:

50Hz 165~1000rpm

60Hz 200~1200rpm

■ 附R型減速比 With R type reduction ratio:

AR2.5 50Hz 66~400rpm

60Hz 80~480rpm

AR5 50Hz 33~200rpm

60Hz 40~240rpm

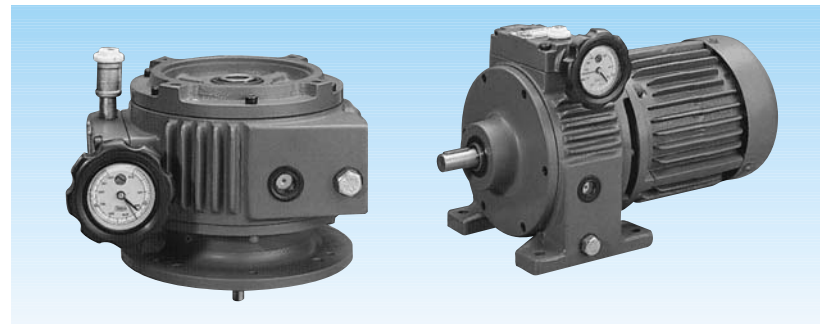

## 特點：

### 1. 低速時扭力變大效率高

DISCO 無段變速機，輸入容量自0.18W~3.7KW，其扭力的傳導是由多組斜面游星片面的傳導，所以能夠承受過負載、衝擊負荷和反動作負荷的特殊環境，在低速時因游星片軌道擴大而力臂增大，故扭力變大效力特高。

### 2. 全封閉機械式變速

DISCO 無段變速機，經由機械方式變速，且全封閉在框架內，故在特殊場所，如爆炸性、易燃性、粉塵性、酸鹼性、潮濕性場所，只要馬達選用得當，均能適應，沒有危險且壽命特長。

### 3. 穩定：速度變動率在0.01%以內

機械式變速的另一特色，就是速度穩定變動率低，游星片的組合均附調壓裝置，故速度非常穩，不會因環境溫升改變或使用過久而失去準確性。

### 4. 體積小、重量輕、介面特性佳

DISCO 本體 1HP 僅 125mm 長，體積小重量輕，且立式、臥式，雙軸型均可配合在整體的聯動系統中，可適用單一馬達驅動，降低成本、減少故障，提高系統聯動的特性，因此雙軸型的應用不可或缺。

### 5. 變速操作容易

由於採用操作輪，變速容易，運轉中不管是否在負載狀態下，均可快速而卻實地變速，並且可以裝用各種遙控裝置，與 P.L.D. 自動控制。

### 6. 應用範圍廣泛

任何速度均可指定，任何角度均可安裝，不受入力軸變速的限制，且能配合各種馬達及減速機使用。

## Features:

### 1. High torque at low speed enhance the efficiency

Disco stage less reducer, with input capacity from 0.18W~22KW, the transmission of torque is done by multiple tapered planetary plate which capable to withstand special conditions of overload, impact load and reverse acting load. The torque arm is enlarged due to expansion of planetary plate while low speed, so the torque is enlarged with higher efficiency.

### 2. Fully enclosed mechanical speed variation

Disco stage less reducer, speed change via mechanical method and enclosed in fully concealed frame, so is adaptable to special places such as explosive, flammable, dusty, acid and alkaline, damp place is right selection of motor, hazard free and long life.

### 3. Stable: speed variation rate within 0.01%

Another feature of mechanical speed change is stable speed with low variation, the combination of planetary plate is complete with pressure regulation device, so the speed is very stable, no concern of accuracy loss due to temperature change or extended usage.

### 4. Compact, light weight, good interface characteristic.

The body of 1HP Disco is merely 125mm long, compact and light weight, match the interlinked system by using vertical, flat or dual shafts type, suitable for single motor drive, reduce cost, less trouble, elevate the characteristic of system interlocked, thus the application of dual shafts is indispensable.

### 5. Easy operation for speed change

Easy speed change due to adoption of operation wheel, speed change exactly and fast during operating regardless loaded or not, and allow remote control device, and PLD automatic control.

### 6. Wide application scope

Any speed can be specified and mount to any angle, no restriction from the speed change of input shaft, and match with various motor and reducer.

## 各系列機種例 Full kinds of series model:

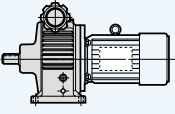
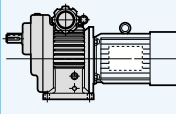
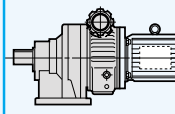
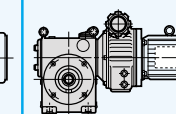
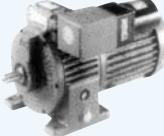
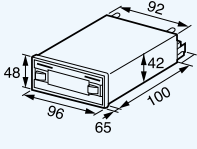
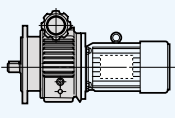
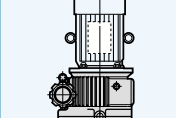
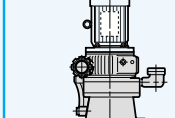
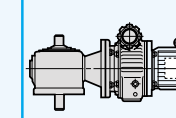
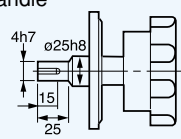
A—基本型 A-Basic	R—附偏心減速機 R-with eccentric reducer	G—附齒輪減速機 G-with gear reducer	W—附渦輪減速機 W-with worm gear reducer	S—電氣式遙控數字顯示器 S- electrical remote number display
 AM	 ARM	 AGM	 AWM	 
 AVM	 AVRM	 AVGM	 AVWM	S—並附把手 S-with handle 
200-1200RPM	輸出轉速任意指定方式 Free designating of output revolution.			

註：出力軸按裝方向均可指定，並可作雙軸使用。

NOTE: The installation direction of the output shaft can be designated and may be served as dual shafts.

\*以上數值若有變動，恕不另行通知\* We reserve the right to change without further notice.



## 常用出力軸回轉數選擇表 Selection list for revolution of common output shaft

出力軸回轉數選擇表 (RPM)		減速比 Ratio	變速範圍 Range of speed variation	減速機型式 Model of reducer	代號 Code
4P 60Hz	4P 50Hz				
1200~200	1000~165	2.5	1/1.4~1/8.4	A 系列 Series	AM AVM
480~80	400~66			R 型：附偏心齒輪減速機 R type: with eccentric reducer	ARM AVRМ
240~40	200~33	5	1/7~1/42	C 型：附擺線形減速機 G 型：附齒輪減速機 W 型：附渦輪減速機 C type: with swing linear reducer G type: with gear reducer W type: with worm gear reducer	AGM
120~20	100~16.5	10	1/14~1/84		AVGM
80~13.3	66.6~11	15	1/21~1/126		AWM
60~10	50~8.3	20	1/28~1/168		AVWM
40~6.7	33.3~5.5	30	1/42~1/251		
20~3.3	16.7~2.8	60	1/84~1/509		

### 臥式基本型 (腳座安裝型) Horizontal type (Foot mounting)

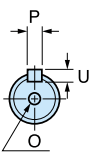
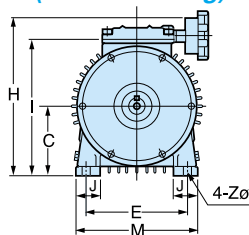

### A (M) 型

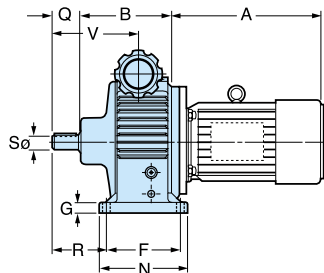

型式 Model	B	C	E	F	G	H	I	J	M	N	R	V	Z	出力軸尺寸 Output shaft size					A (Kg)
														S (h6)	Q	P	U	O	
02A(M)	110	71	110	105	12	203	158	25	140	125	48	99	9	14	30	5	5	M5	8
05A(M)	138	90	120	105	15	223	177	32	160	135	60	110	10	14	30	5	5	M5	14
1A(M)	152	106	160	125	15	254	208	40	190	150	75	129	12	19	40	6	6	M6	20
2A(M)	190	125	180	140	18	300	246	50	230	165	100	157	12	24	50	8	7	M8	34
3/5A(M)	220	150	245	230	20	360	298	55	300	270	85	187	14	28	60	8	7	M8	63
																			67

### 立式基本型 (法蘭直結型) Vertical type (Flange direct coupling)

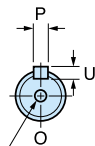
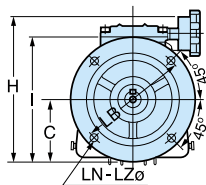

### AV (M) 型

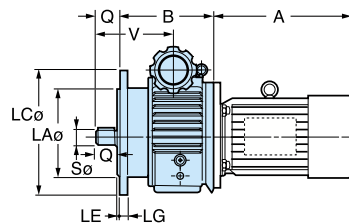

型式 Model	B	C	H	I	V	LA	LB	LC	LE	LG	LN	LZ	出力軸尺寸 Output shaft size					AV (Kg)
													S (h6)	Q	P	U	O	
02AV(M)	113	66	198	153	99	110	130	160	3.5	10	4	10	11	23	5	5	M5	8.5
05AV(M)	138	87	220	174	110	110	130	160	3.5	12	4	12	14	30	5	5	M5	15
1AV(M)	152	103	251	188	129	130	165	200	3	10	4	12	19	40	6	6	M6	22
2AV(M)	190	120	295	241	188	130	165	200	4	16	4	15	24	50	8	7	M8	37
3/5AV(M)	220	147	357	295	187	180	215	250	4	16	4	15	28	60	8	7	M8	68
																		72

### 雙軸型 Dual shafts Type

#### AK 型

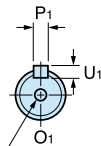
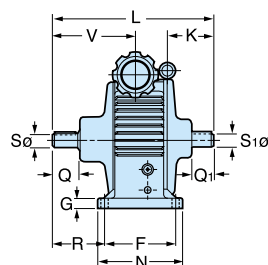

#### AVK 型

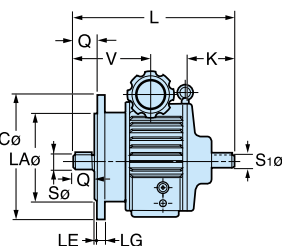

型式 Model	L	K	出力軸尺寸 Output shaft size				
			S <sub>1</sub> (h6)	Q <sub>1</sub>	P <sub>1</sub>	U <sub>1</sub>	O <sub>1</sub>
02 <sup>A</sup> <sub>AVK</sub>	205	77	14	30	5	5	M5
	200		11	25			
05 <sup>A</sup> <sub>AVK</sub>	210	69	14	30	5	5	M5
1 <sup>A</sup> <sub>AVK</sub>	261	89	19	40	6	6	M6
2 <sup>A</sup> <sub>AVK</sub>	331	112	24	50	8	7	M8
3 <sup>A</sup> <sub>AVK</sub>	391	134	28	60	8	7	M8
5 <sup>A</sup> <sub>AVK</sub>							

\*以上數值若有變動，恕不另行通知\* We reserve the right to change without further notice.



# 東力小型 齒輪、渦輪減速變速馬達

先進尖端的品質，精確控制機器自動化的命脈

ISO-9001 國際品質保證 CE(EMC)認證通過

## 臥式、立式齒輪減速馬達

### Horizontal/Vertical type gear motor

CE/EMC approved

馬力(Horsepower):

0.1kw-3.7kw

減速比(Ratio):

1/3-1/1800



## 無段變速齒輪馬達

### Speed control gear motor

### 齒輪減速馬達 Gear motor

馬力(Horsepower):

6w-150w

減速比(Ratio):

1/3-1/1800



## 直線型馬達

### Linear gear motor

推力(Thrust): 1kg-140kg

基本速度(Stroke Speed): 1-50 mm/sec

推桿長度(Length): 100~600mm



## 電磁制動馬達

### Electromagnetic brake motor

馬力(Horsepower): 6-150w

減速比(Ratio): 1/3-1/1800



## 直交軸系列 齒輪減速機

### Right-Angle gear motor

馬力(Horsepower): 25w-150w

減速比(Ratio): 1/10-1/600



## 軸上型減速機 (直交軸型)

### Shaft-Mounted Reducer

Model: TL-4060, 4070, 5080

減速比(Ratio): 1/30~1/300

馬力(Horsepower): 100w-1500w



## TRS低間隙伺服馬達專用減速機 (歐系規格)

### Low backlash planetary gear reducer for servo motor

機種(Model):

042, 060, 090, 115, 142, 180

馬力(Horsepower): 50w-5000w

減速比(Ratio): 3-100



## TRK低間隙伺服馬達專用減速機 (日系規格)

### Low backlash planetary gear reducer for servo motor

機種(Type): TRK-B.C.D.E.F

馬力(Horsepower): 50w-5000w

減速比(Ratio): 3-25



## 無段變速機

### Variable Speed control motor

馬力(Horsepower):

0.2kw-3.7kw

變速範圍(Speed range):

200rpm-1200rpm



## 遊星式減速機

### Planetary Reducer

馬力(Horsepower): 1/2HP-150HP

減速比齊全



東力

## 東力電機股份有限公司

台灣廠：台北縣五股工業區五權三路50號

Tel: +886-2-22992655~59 Fax: +886-2-22990146

E-mail: TLmotor@tungle.com.tw

http://www.tungle.com.tw

廈門東力：Tel: +86-592-7899356~9 Fax: +86-592-7559311

蘇州東力：Tel: +86-512-5360-4758(68) Fax: +86-512-53601027

東莞東力：Tel: +86-769-85083030~1 Fax: +86-769-85085955





(TUV) 認證通過

# 東力小型 伺服減速 齒輪減速 渦輪減速 馬達

## T.L. GEAR REDUCTION MOTOR

