

DIN W48×H48mm 8 Pin Plug Timer

Upgrade

■ Features

- Wide range of the time selection (0.01sec to 9999.9 hour)
- Selectable voltage input (PNP) method or no-voltage input (NPN) method
- Dot for Decimal Point / Hour. Min. Second by RESET key
- Wide range of power supply : 100-240VAC 50/60Hz, 24VAC 50/60Hz, 24-48VDC universal
- Memory protection for 10years (using non-volatile semiconductor)
- Built-in Microprocessor

Shaded parts(■) are changed and added functions from previous FSE Series.



⚠ Please read "Safety considerations" in operation manual before using.



■ Ordering Information

FS	4	E	1P	4	
					Power supply
					Output
					Timer
					Display digit
					Item
					2 24VAC 50/60Hz, 24-48VDC
					4 100-240VAC 50/60Hz
					1P 1-stage setting
					I Indicator
					E Timer
					4 9999 (4-digit)
					5 99999 (5-digit)
					FS 8-pin plug timer

※8-pin socket (PG-08, PS-08(N)) is sold separately.

■ Specifications

Model	1-stage setting	FS4E-1P2	FS4E-1P4	FS5E-I4
	Indicator	—	—	FS5E-I4
Display digit		4-digit		5-digit
Character size (W×H)		3.8×7.6mm		4×8mm
Power supply		24VAC~ 50/60Hz, 24-48VDC	100-240VAC~ 50/60Hz	
Permissible voltage range		90 to 110% of rated voltage		
Power consumption		Max. 3.5VA (24VAC~ 50/60Hz), Max. 2.3W (24-48VDC)	Max. 4.6VA (100-240VAC~ 50/60Hz)	Max. 3.8VA (100-240VAC~ 50/60Hz)
Return time		Max. 500ms		
Time operation		Power ON Start		
Min. signal width		RESET, INHIBIT: approx. 20ms		
Input method		Selectable voltage input (PNP) method or no-voltage input (NPN) method [Voltage input (PNP) method] input impedance: max. 10.8kΩ, [H]: 5-30VDC, [L]: 0-2VDC [No-voltage input (NPN) method] short-circuit impedance: max. 470Ω, short-circuit residual voltage: max. 1VDC, open-circuit impedance: min. 100kΩ		
One-shot output time		0.05 to 5 sec		
Control output	Contact	Type Time-limit SPDT (1c)		—
	Capacity	250VAC~ 3A, 30VDC= 3A resistive load		
Relay life cycle	Mechanical	Min. 5,000,000 operations		
	Electrical	Min. 100,000 operations (250VAC 3A resistive load)		
Memory retention		Approx. 10 years (non-volatile memory)		
Repeat error				
Set error				
Voltage error		Max. ±0.01% ±0.05 sec		
Temp. error				
Insulation resistance		Over 100MΩ (at 500VDC megger)		
Dielectric strength		2,000VAC 50/60Hz for 1 min (between all terminals and case)		
Noise immunity	AC voltage	±2kV the square wave noise (pulse width 1μs) by noise simulator		
	AC/DC voltage	±500V the square wave noise (pulse width 1μs) by noise simulator		
Vibration	Mechanical	0.75mm amplitude at frequency 10 to 55Hz (for 1 min) in each X, Y, Z direction for 1 hour		
	Malfunction	0.5mm amplitude at frequency 10 to 55Hz (for 1 min) in each X, Y, Z direction for 10 minutes		
Shock	Mechanical	300m/s ² (approx. 30G) in each X, Y, Z direction for 3 times		
	Malfunction	100m/s ² (approx. 10G) in each X, Y, Z direction for 3 times		
Environment	Ambient temp.	-10 to 55°C, storage: -25 to 65°C		
	Ambient humi.	35 to 85%RH, storage: 35 to 85%RH		
Protection structure		IP20 (front part, IEC standard)		
Approval		CE c UL US		
Weight ^{*1}		Approx. 130g (approx. 90g)		Approx. 120g (approx. 80g)

※1: The weight includes packaging. The weight in parenthesis is for unit only.

※Environment resistance is rated at no freezing or condensation.

- (A) Photoelectric Sensors
- (B) Fiber Optic Sensors
- (C) Door/Area Sensors
- (D) Proximity Sensors
- (E) Pressure Sensors
- (F) Rotary Encoders
- (G) Connectors/ Connector Cables/ Sensor Distribution Boxes/Sockets
- (H) Temperature Controllers
- (I) SSRs / Power Controllers
- (J) Counters
- (K) Timers
- (L) Panel Meters
- (M) Tacho / Speed / Pulse Meters
- (N) Display Units
- (O) Sensor Controllers
- (P) Switching Mode Power Supplies
- (Q) Stepper Motors & Drivers & Controllers
- (R) Graphic/ Logic Panels
- (S) Field Network Devices
- (T) Software

FSE Series

■ Connections

● FS4E-1P4

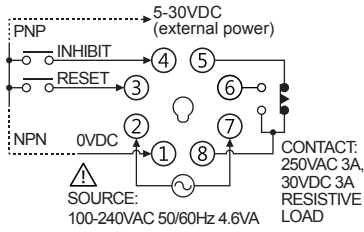

● FS4E-1P2

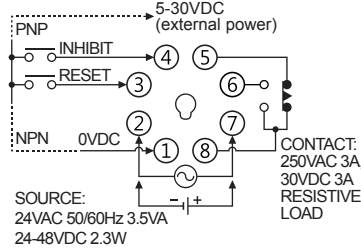

● FS5E-I4

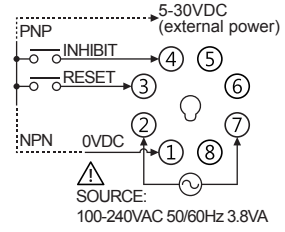

■ Input Connections

◎ Voltage input (PNP)

● Solid-state input (standard sensor: PNP output type sensor)

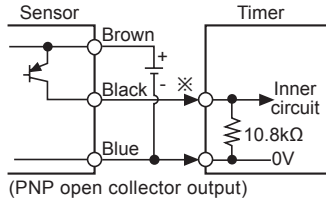
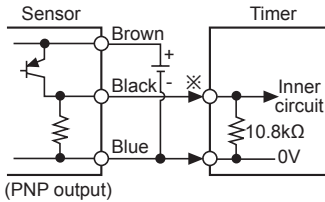

● Contact input

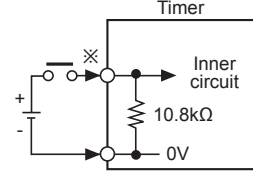

※INHIBIT, RESET input part

◎ No-voltage input (NPN)

● Solid-state input (standard sensor: NPN output type sensor)

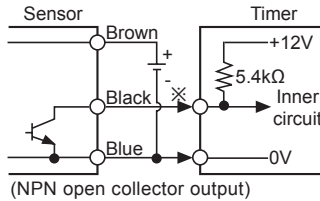
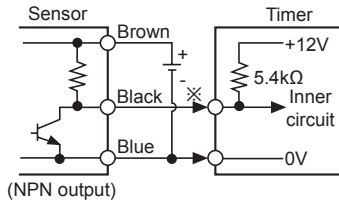

● Contact input

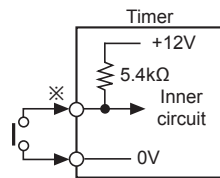

※INHIBIT, RESET input part

■ Dimensions

※Nameplate design is changed and rear length is shorter than previous.

(unit: mm)

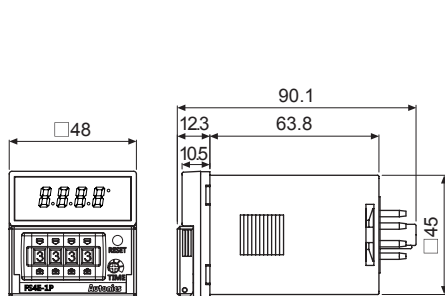

● Bracket

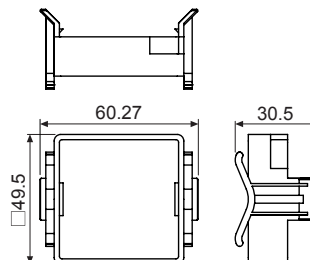

● Panel cut-out

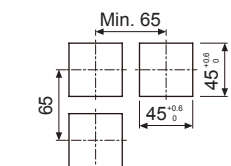

※8-pin socket (PG-08, PS-08(N)) is sold separately.

Refer to the '(G)Connectors/Connector Cables/Sensor Distribution Boxes/Sockets'.

8 Pin Plug Timer

■ DIP Switch Setting

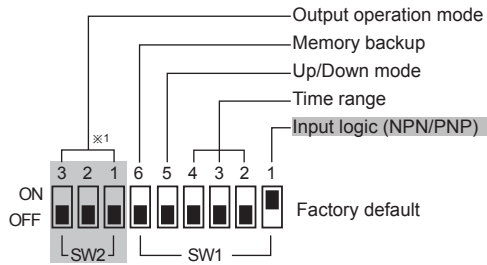
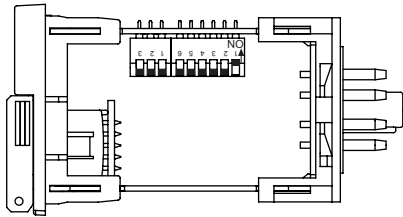

● Input logic (INHIBIT, RESET input)

SW1	Function
1	ON <input type="checkbox"/> OFF <input type="checkbox"/> NPN (no-voltage input)
	ON <input type="checkbox"/> OFF <input type="checkbox"/> PNP (voltage input)

● Up/Down mode

SW1	Function
5	ON <input type="checkbox"/> OFF <input type="checkbox"/> Down mode
	ON <input type="checkbox"/> OFF <input type="checkbox"/> Up mode

※1: Indicator model (FS5E-I4) does not have no. 1, 2, 3 of SW2 for output operation mode setting.

● Memory backup

SW1	Function
6	ON <input type="checkbox"/> OFF <input type="checkbox"/> No memory backup
	ON <input type="checkbox"/> OFF <input type="checkbox"/> Memory backup

■ Time Range

SW1	4-digit	5-digit
ON <input type="checkbox"/> OFF <input type="checkbox"/> 4 3 2	99.99sec	9999.9sec
ON <input type="checkbox"/> OFF <input type="checkbox"/> 4 3 2	999.9sec	99999sec
ON <input type="checkbox"/> OFF <input type="checkbox"/> 4 3 2	9999sec	9min 59.99sec
ON <input type="checkbox"/> OFF <input type="checkbox"/> 4 3 2	99min 59sec	99min 59.9sec

SW1	4-digit	5-digit
ON <input type="checkbox"/> OFF <input type="checkbox"/> 4 3 2	999.9min	9999.9min
ON <input type="checkbox"/> OFF <input type="checkbox"/> 4 3 2	99hour 59min	9hour 59min 59sec
ON <input type="checkbox"/> OFF <input type="checkbox"/> 4 3 2	999.9hour	999hour 59min
ON <input type="checkbox"/> OFF <input type="checkbox"/> 4 3 2	9999hour	9999.9hour

■ Dot for Hour. Min. Second

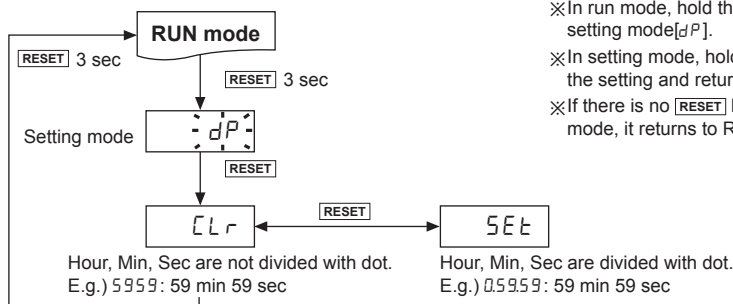

※In run mode, hold the **RESET** key for over 3 sec, and it enters setting mode[dP].

※In setting mode, hold the **RESET** key for over 3 sec, and it saves the setting and returns to RUN mode.

※If there is no **RESET** key input for 60 sec when entering setting mode, it returns to RUN mode.

(A) Photoelectric Sensors

(B) Fiber Optic Sensors

(C) Door/Area Sensors

(D) Proximity Sensors

(E) Pressure Sensors

(F) Rotary Encoders

(G) Connectors/ Connector Cables/ Sensor Distribution Boxes/Sockets

(H) Temperature Controllers

(I) SSRs / Power Controllers

(J) Counters

(K) Timers

(L) Panel Meters

(M) Tacho / Speed / Pulse Meters

(N) Display Units

(O) Sensor Controllers

(P) Switching Mode Power Supplies

(Q) Stepper Motors & Drivers & Controllers

(R) Graphic/ Logic Panels

(S) Field Network Devices

(T) Software

FSE Series

Time Operation for Indicator (FS5E-I4)

Up mode

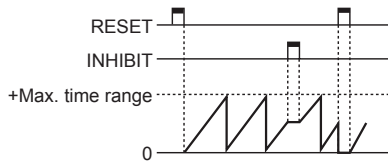

Down mode

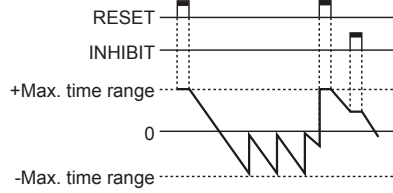

※- display is only for F, K, Q, S output operation mode and it cannot be set.

Output Operation Mode

	← One-shot output (0.05 to 5 sec)	← Self-holding output	
Output mode (SW2)	ON ⁵ OFF <input type="checkbox"/> Up mode	ON ⁵ OFF <input type="checkbox"/> Down mode	Operation
F ON OFF <input type="checkbox"/> <input type="checkbox"/> <input type="checkbox"/> <input type="checkbox"/>			After time-up, the display value increases or decreases until reset signal input is applied and self-holding output is maintained.
N ON OFF <input type="checkbox"/> <input type="checkbox"/> <input type="checkbox"/> <input type="checkbox"/>			After time-up, the display value and self-holding output are maintained until reset signal input is applied.
C ON OFF <input type="checkbox"/> <input type="checkbox"/> <input type="checkbox"/> <input type="checkbox"/>			When time-up, the display value is reset and it operates simultaneously.
R ON OFF <input type="checkbox"/> <input type="checkbox"/> <input type="checkbox"/> <input type="checkbox"/>			After time-up, the display value is reset after one-shot output time and it operates simultaneously.
K ON OFF <input type="checkbox"/> <input type="checkbox"/> <input type="checkbox"/> <input type="checkbox"/>			After time-up, the display value increases or decreases until reset signal input is applied.
P ON OFF <input type="checkbox"/> <input type="checkbox"/> <input type="checkbox"/> <input type="checkbox"/>			After time-up, the display value is maintained while output is ON. The value is internally reset and it operates simultaneously.
Q ON OFF <input type="checkbox"/> <input type="checkbox"/> <input type="checkbox"/> <input type="checkbox"/>			After time-up, the display value increases or decreases during one-shot output time.
S ON OFF <input type="checkbox"/> <input type="checkbox"/> <input type="checkbox"/> <input type="checkbox"/>			Output turns OFF→ON→OFF operates repeatedly (flicker).

※Set one-shot output time by front TIME volume switch.

■ Proper Usage

◎ Preset value

Able to change setting value while it is running but setting value should be higher than previous setting value.

◎ Power

- In case of 24VAC, 24-48VDC model, power supply should be insulated and limited voltage/current or Class 2, SELV power supply device.
- The inner circuit voltage rises within 100ms after supplying the power to the unit.
The input may be unavailable at this period.
Be sure that the inner circuit voltage drops within 500ms after turning OFF the power.

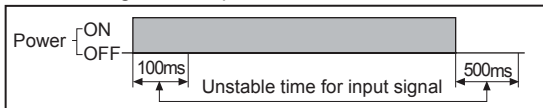

- Use the unit within the rated power supply.
When supplying or cutting the power, use a switch not to occur chattering.

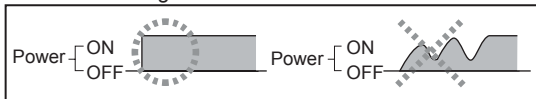

◎ Input signal line

- Shorten the cable from the sensor to the unit.
- Use shield cable when input cable is longer.
- Wire the input signal line separately from power line.

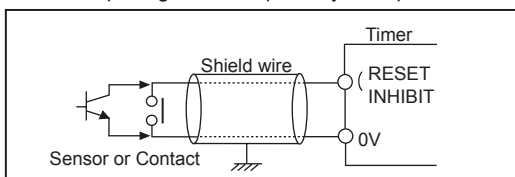

◎ The reset signal width

It is reset perfectly when the reset signal is applied for max. 20ms regardless of the contact input & solid-state input.

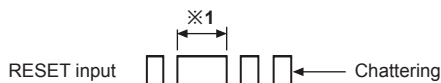

※ In case of a contact reset, it is reset perfectly if the ON time of reset signal is applied for max. 20ms even though a chattering occurs.

◎ Error

Display	Error	Troubleshooting
Er-0	Setting value is 0.	Change the setting value anything but 0.

※ If error occurs, the output turns OFF.

※ Indicator model does not have error display function.

◎ RESET

RESET has two function, which are memorizing DATA function and resetting output function.
When changing an inner selection switch, manual RESET or external RESET must be held after applying the power by all means. Otherwise, it will operate as previous mode.
Selecting a RESET input/output mode again after applying power, please reset or reset manually, otherwise the previous mode will be operating.

◎ INHIBIT

- When you need to check the real operating time, please use INHIBIT function.
- If you need to stop the time progressing, please use INHIBIT function.

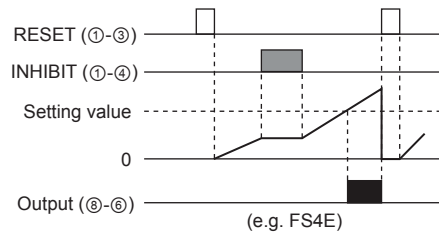

◎ Detaching Case

Push the grooves at both side of the unit with a flat head driver to the outside and push the plug part to the front. The plug is detached.

△ Be sure not to be wounded when using a tool.

※ Turn OFF the power before detaching the case.

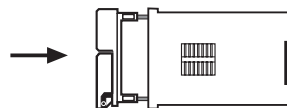
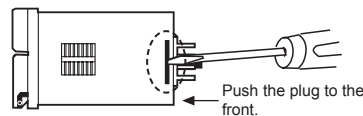

◎ Environment

Do not use the unit in the following environments.

- Environments with high vibration or shock.
- Environments with strong alkali or strong acid materials
- Environments with exposure to direct sunlight
- Near machinery which produces strong magnetic force or electric noise

◎ Noise

- We test 2kV, Pulse width 1μs against Impulse voltage between power terminals and 1kV, pulse width 1μs at noise simulator against external noise voltage. Please install MP condenser (0.1 to 1μF) or oil condenser between power terminals when over Impulse noise voltage occurs.
- Testing dielectric voltage or insulation resistance when the unit is installed at control panel
 - ① Isolate the unit from the circuit of control panel.
 - ② Short all terminals of the unit
- Sudden function stop while it is running (when displaying wrong numbers or nothing)
In this case, please power off and turn on again.
This is due to strong noise flows into this product therefore please try to separate inductive load from input signal line of this product or install surge absorber between inductive loads.

(A) Photoelectric Sensors

(B) Fiber Optic Sensors

(C) Door/Area Sensors

(D) Proximity Sensors

(E) Pressure Sensors

(F) Rotary Encoders

(G) Connectors/ Connector Cables/ Sensor Distribution Boxes/Sockets

(H) Temperature Controllers

(I) SSRs / Power Controllers

(J) Counters

(K) Timers

(L) Panel Meters

(M) Tacho / Speed / Pulse Meters

(N) Display Units

(O) Sensor Controllers

(P) Switching Mode Power Supplies

(Q) Stepper Motors & Drivers & Controllers

(R) Graphic/ Logic Panels

(S) Field Network Devices

(T) Software