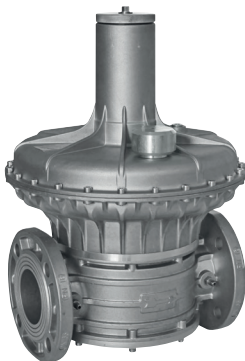
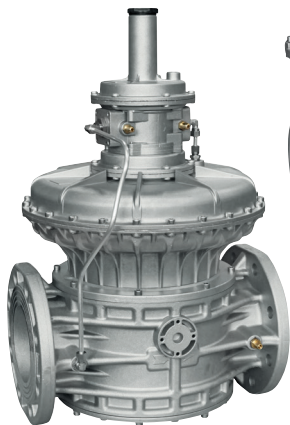

REGOLATORE DI PRESSIONE PER GAS
 GAS PRESSURE REGULATOR
 REGULATEUR DE PRESSION POUR GAZ
 REGULADOR DE PRESIÓN PARA GAS

RG/2MCS

RG/2MBZ

II 2G - II 2D

0497

MADE IN ITALY

| | IT | EN | FR | ES |
|--|-------------------------------|-----------------------------|-----------------------------|-----------------------------|
| Range pressione di esercizio Operating pressure range Plage de pression de fonctionnement Rango de la presión de funcionamiento | Pe: 0,5÷5 bar | | | |
| Attacchi flangiati/ Flanged connections Raccords à brides / Conexiones embreadas | DN 65 - DN 80 - DN 100 | | | |
| Norma di riferimento / Reference standard Norme de référence / Patrón de referencia | EN 88-2 | | | |
| In conformità a * In conformity with * Conforme a * Conforme * | Direttiva PED 2014/68/UE | PED Directive 2014/68/EU | Directive PED 2014/68/UE | Direttiva PED 2014/68/UE |

2.0 - TECHNICAL DATA

| | |
|--|--|
| • Use | : non-aggressive gases of the three families (dry gases) |
| • Ambient temperature (TS) | : -20 ÷ +60°C |
| • Minimum operating pressure | : 0.5 bar |
| • Max operating pressure | : 5 bar |
| • Allowable pressure PS | : 5 bar |
| • Safety shut offs closing time | : < 1 s |
| • Accuracy class | : AC=10 - (Pa ± 10%) |
| • Overpressure shut off accuracy unit | : AG=10 |
| • Closing pressure class | : SG=30 |
| • Relief valve | : tested according to the indications in EN 334 |
| • Connecting the vent | : G 3/4 |
| • Mechanical strength | : Group 2 (according to EN 13611) |
| • Flanged connections that can couple with PN 16 flanges | : (DN 65 - DN 80 - DN 100) ISO 7005 / EN 1092-1 |
| • ANSI 150 flanged connections | : on request |
| • In compliance with | : PED Directive 2014/68/EU - ATEX Directive 2014/34/EU |

2.1 - MODEL IDENTIFICATION (for configurations see page 54 ÷ 58)

RG/2MCS: Pressure regulator - without safety shut-offs

RG/2MBZ: Pressure regulator - with safety shut-offs

3.0 - COMMISSIONING THE DEVICE



3.1 - OPERATIONS PRIOR TO INSTALLATION

- It is necessary to close the gas upstream of the device prior to installation;
- Make sure that the line pressure **DOES NOT EXCEED** the maximum pressure declared on the product label;
- Protective caps (if any) must be removed prior to installation;
- The pipes and inside of the device must be clear of any foreign bodies;

• IMPORTANT:

- to avoid possible pumping and/or disturbances in the gas flow, a straight pipe section equal to at least 5 DN must be installed (downstream of the regulator);
 - install manual gas closing devices (e.g. ball valves) upstream and downstream of the regulator to protect it from any pipe leak test;
 - do consider that if the regulator is equipped with a relief valve, the latter is suitable for small quantities of gas to be discharged and CANNOT replace the relief valve installed separately as a specific device;
- make sure the inlet and outlet counter-flanges are perfectly coaxial and parallel in order to prevent unnecessary mechanical stress to the body. Also calculate the space to insert the seal gasket;
- With regard to tightening operations, equip yourself with one or two calibrated torque wrenches or other controlled locking tools;
 - With outdoor installation, it is advisable to install a protective roof to prevent rain from oxidising or damaging parts of the device.



- According to the plant geometry, check the risk of an explosive mixture arising inside the piping;
- If the regulator is installed near other devices or as part of an assembly, compatibility between the regulator and these devices must be evaluated beforehand;
- Provide a protection against impacts or accidental contacts if the device is accessible to unqualified personnel.



3.2 - INSTALLATION (see examples in 3.4)

- Assemble the device by flanging it, with the due seals, onto the plant with pipes whose flanges are consistent with the connection being attached. The gaskets must be free from defects and must be centred between the flanges;
- If, after installing the gaskets, there is still too much space in between, do not try to reduce said gap by excessively tightening the bolts of the device;
- The arrow, shown on the body (**5**) of the device, needs to be pointing towards the application;
- Insert the relative washers inside the bolts in order to prevent damage to the flanges during the tightening stage;
- When tightening, be careful not to “pinch” or damage the gasket;
- Tighten the nuts or bolts gradually, in a “cross” pattern (see the example alongside);
- Tighten them, first by 30%, then by 60% and finally 100% of the maximum torque (see the example alongside, according to EN 13611);
- Tighten each nut and bolt again clockwise at least once, until the maximum torque has been achieved uniformly;
- The regulator is normally positioned before the application. It can be installed in any position even if the installation shown in 3.4 (installation examples) is preferred. A pressure test nipple (**12**) can be found outside the regulator, downstream from it, to control the regulation pressure (Pa);
- **IMPORTANT:** it is necessary, using the appropriate fitting (**4**), to connect the downstream pulse outlet of the regulator (see installation examples) using a special pipe. For 2MBZ versions (equipped with safety shut-offs), the shut-off downstream of the regulator must also be connected by means of suitable fittings and pipes using the tap connection (**21**) (see installation example 2);
- Drain the relief valve (if any) outwards (as shown in 3.4). To do so, in the piloted 2MCS version (see fig.2), it is necessary to remove the dust cap (**32**);
- It is always recommended to install a compensation joint;
- During installation, avoid debris or metal residues from getting into the device;
- To guarantee mechanical tension-free assembly, we recommend using compensating joints, which also adjust to the pipe's thermal expansion;
- If the device is to be installed in a ramp, it is the installer's responsibility to provide suitable supports or correctly sized supports, to properly hold and secure the assembly. Never, for any reason whatsoever, leave the weight of the ramp only on the connections (threaded or flanged) of the individual devices;
- In any case, after installation check the tightness of the system, without subjecting the diaphragm of the regulator (therefore, the downstream pipe section) to a pressure higher than 300 mbar (valid only for versions with standard working diaphragm). For versions with reinforced diaphragm, check the tightness with a pressure equal to 1.5 times the regulator setting pressure.

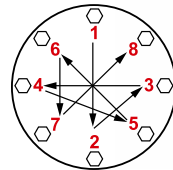

| Diameter | DN 65 | DN 80 | DN 100 |
|-------------------|-------|-------|--------|
| Max. torque (N.m) | 50 | 50 | 80 |

3.3 - INSTALLATION IN PLACES WHERE THERE IS THE RISK OF EXPLOSION (DIRECTIVE 2014/34/EU)

The regulator complies with Directive 2014/34/EU (formerly 94/9/EC) as group II equipment, category 2G and as group II equipment, category 2D; consequently, it is suited for installation in zones 1 and 21 (in addition to zones 2 and 22) as classified in Annex I of Directive 99/92/EC. The regulator is not suited for use in zones 0 and 20 as defined in the aforementioned Directive 99/92/EC. To determine the qualification and size of the danger zones, please refer to standard IEC EN 60079-10-1.

If installed and subject to maintenance in full compliance with all conditions and technical instructions provided in this manual, the device does not pose a source of specific hazards: in particular, under conditions of normal operation, the regulator is expected to emit a flammable substance into the atmosphere only occasionally, and specifically:

The regulator can be dangerous with respect to the presence of other devices nearby if the integrated relief valve is triggered or if the working diaphragm (**16**) or the blocking diaphragm (**30**) fails. If the diaphragm fails, the regulator becomes a source of explosive atmosphere emission of continuous degree and, as such, it can generate hazardous areas 0 as defined in Directive 99/92/EC.

In particularly critical installation conditions (unattended areas, poor maintenance or poor ventilation) and especially if there are potential sources of ignition and/or hazardous equipment near the regulator in regular operation, as they may generate electric arcs or sparks, a preliminary assessment of the compatibility between the regulator and such equipment must be carried out. In any case, every useful precaution must be adopted so as to prevent the regulator from generating zones 0: for example, annually verify regular operation, possibility of changing the degree of emission of the source or intervening on the explosive substance discharge by directing it outwards. To do so, where present, remove the dust caps (**31**) and (**32**) by connecting the specific pipe (respectively, G 3/4 and G 1/8) conveying it to the outside (see installation examples in 3.4).

3.4 - GENERAL EXAMPLES OF INSTALLATION

EXAMPLE 1 (RG/2MCS)

1. Expansion joint/anti-vibration mount
2. Upstream ball valve
- 3. RG/2MCS pressure regulator**
4. Ball valve downstream of the regulator
5. Vent valve
6. MVS/1 relief valve
7. Low pressure gauge and relative button
8. High pressure gauge and relative button

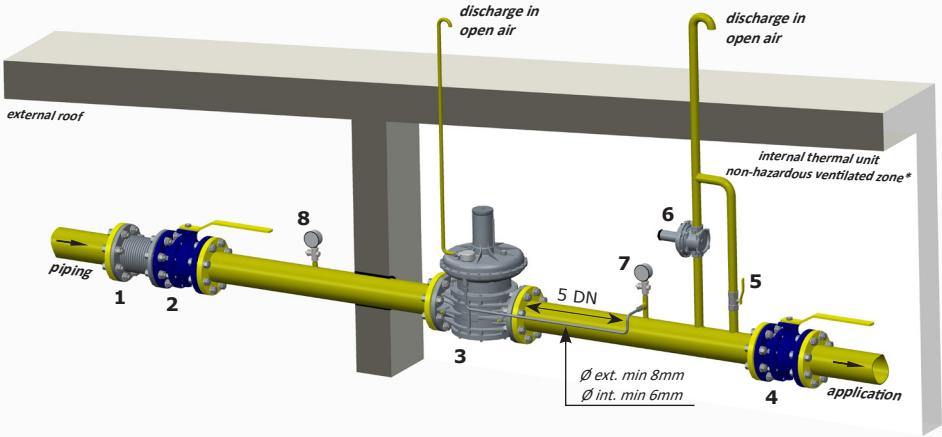

* if the zone is ATEX classified follow the indications of 3.3

EXAMPLE 2 (RG/2MBZ)

1. Expansion joint/anti-vibration mount
2. Upstream ball valve
- 3. RG/2MBZ pressure regulator**
4. Ball valve downstream of the regulator
5. Vent valve
6. MVS/1 relief valve
7. Low pressure gauge and relative button
8. High pressure gauge and relative button

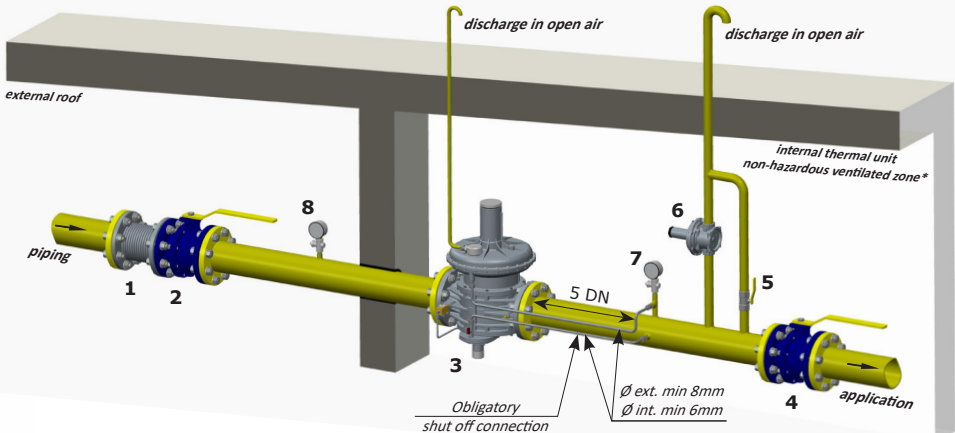

* if the zone is ATEX classified follow the indications of 3.3



4.0 - MANUAL RESET (only RG/2MBZ)

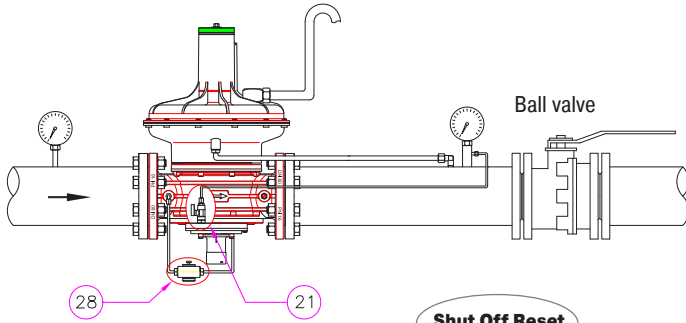
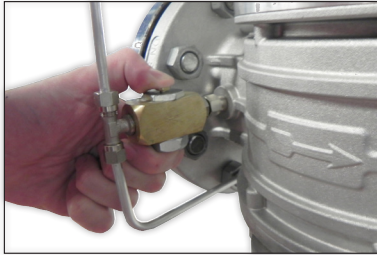
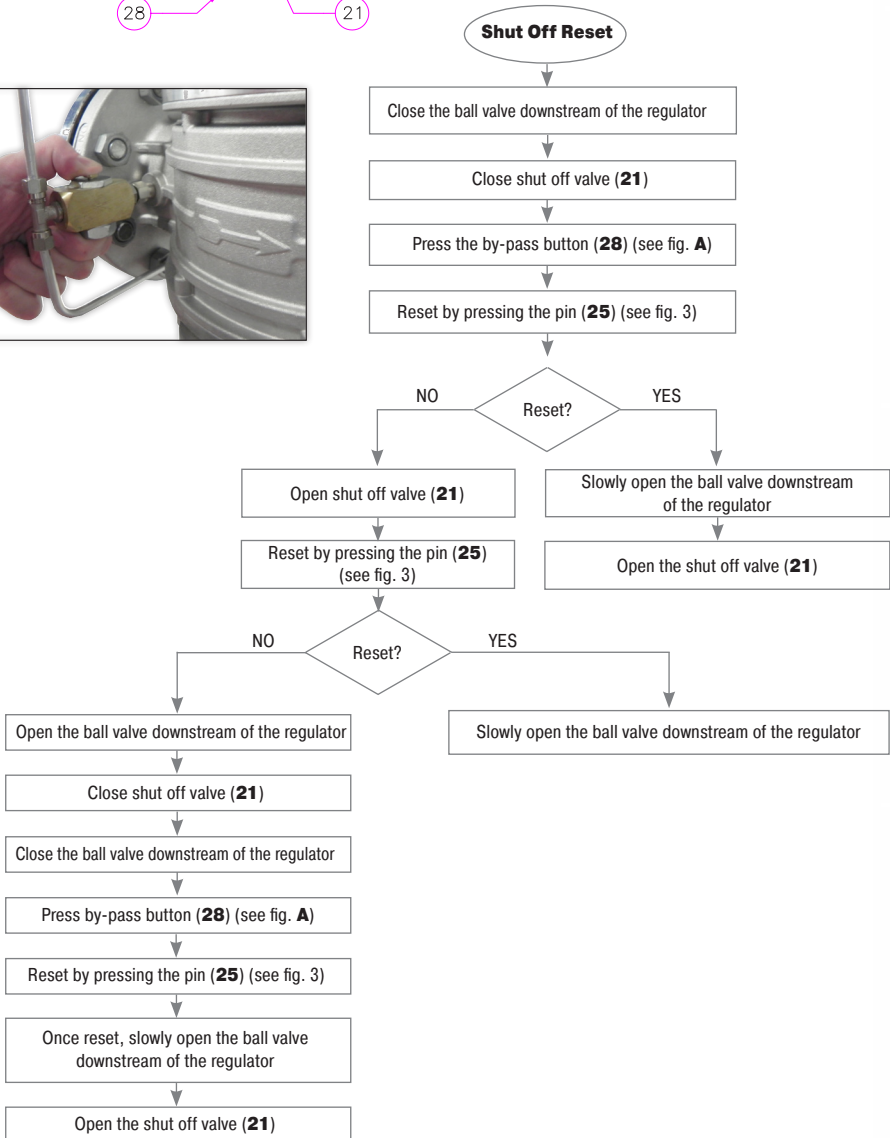

fig. A



Shut Off Reset





5.0 - FIRST START-UP

Before commissioning, verify that:

- all of the instructions on the rating plate, including the direction of flow, are observed;
- the holes of the dust caps **(31)** and **(32)** and of the discharge **(18)** are not clogged (regulator and shut off);
- **IMPORTANT:** The leak test of the piping must be performed without subjecting the diaphragm of the regulator (therefore, the downstream pipe section) to a pressure higher than 300 mbar (for reinforced diaphragm 1.5 times the regulator setting pressure). Use special manual gas closing devices to avoid damaging the regulator;
- The pressurisation manoeuvre of the equipment must be carried out very slowly so as to avoid possible damage.

NOTE: under no circumstances should a blind cap be installed in place of dust caps **(31)** and **(32)** and of discharge caps **(18)** as the regulator and/or the safety shut offs may not work;

- Close the ball valve downstream of the regulator and partially open the downstream relief valve;
- Slowly open the upstream shut-off devices;
- Close the vent valve;
- Proceed by manually resetting the regulator (see 4.0);
- Close the downstream valve so as to close the regulator (the Pa value increases the SG value to fully close the obturator);
- Check the tightness of the system gaskets and check the internal/external tightness of the regulator, of the relief valve and of the external sensor tube, if applicable;
- Slowly open the downstream valve and the shut-off valve;
- Check the operation of the regulator.



6.0 - SETTING

The RG/2MCS models are **NOT** equipped with safety shut offs (OPSO - UPSO).

Before carrying out the operations, make sure that the supplied spring/s is/are suitable for the desired Pa - OPSO - UPSO and differential relief valve fields.

- Equip yourself with an adequate pressure gauge to control the pressure downstream of the regulator.
- For versions with relief **(2MCS and 2MBZ, fig. 1 and 3)** use a 10 mm hex socket wrench (commercial wrench) with max ext. Ø of not more than 15 mm.
- For versions with pilot operated relief **(2MCS fig. 2)** use an 8 mm hex socket wrench (commercial wrench) with max ext. Ø of not more than 12 mm.

If calibration is needed: the following must be calibrated in the **RG/2MCS** versions: P2 - Relief

the following must be calibrated in the **RG/2MBZ** versions: UPSO - OPSO - P2 - Relief

Calibration of the P2 must be carried out with the system in flow.

Before starting the system (in versions with relief), loosen and remove the cap **(1)** and fully tighten the relief adjustment nut **(19)**.

Before starting the system (only in versions with safety shut offs **RG/2MBZ**):

- Loosen the shut off cap **(23)**.
- Loosen and remove the end part of the reset pin **(25)**.
- Using the appropriate wrench **(29)** fully tighten the OPSO adjustment screw **(24)** and position the UPSO adjustment screw **(26)** at a minimum.

6.1 - Adjusting the outlet pressure (Pa)

The outlet pressure Pa (unless specifically requested) is factory-set with the regulator installed as indicated in 3.4 and with the adjustment screw **(2)** set approximately at the minimum setting value. The safety shut offs/relief valve are set accordingly; If the regulator is installed in different positions, check and reset the outlet pressure Pa, and consequently the devices incorporated in the regulator;

Adjust the outlet pressure as follows:

- in versions with relief (fig.1 and 3), act directly on the adjustment screw **(2)**; in versions without relief (fig.1 and 3) it is necessary, before proceeding, to loosen the cap **(1)**. In the piloted versions (fig.3) it is still necessary to loosen the cap **(1)**.
- Unscrew the adjustment screw **(2)** and set it to the minimum setting allowed;
- Start the system or make sure there is a minimum flow downstream of the regulator;
- To increase the pressure calibration downstream of the regulator, tighten the adjustment screw **(2)** to the desired value. Perform the reading with a calibrated pressure gauge, installed downstream of the regulator to at least 5 DN (see examples in 3.4);
- If it has been removed, screw the cap **(1)** back on and if necessary, seal it in that position using the appropriate seal holes (if any);
- Use pressure outlets **(12)** on the device only for zero flow or very low flow measurements.

6.2 - Adjusting the minimum pressure shut off (UPSO)

NOTE: to act on the UPSO adjustment screw **(26)**, it is necessary to remove (by loosening it) the reset pin **(25)** and then tighten it again to reset the device.

- Unscrew the cap **(23)**;
- Use the supplied key **(29)** to loosen the adjustment ring nut of the minimum shut off **(26)** to the minimum;
- Start the system and reset the shut off device as described in 4.0;
- Reduce the downstream pressure to the desired trigger value;
- Use the supplied key **(29)** to tighten the adjustment ring nut **(26)** until the minimum pressure shut off is triggered.
- Reset the system by following the correct procedure and verify that the trigger value is that desired by repeating the release step 2-3 times;
- If necessary, adjust the trigger value by turning the ring nut **(26)** with the specific key **(29)**;

6.3 - Adjusting the maximum pressure shut off (OPSO)

- Unscrew the cap **(23)**;
- Use the supplied key **(29)** to fully tighten the adjustment ring nut of the maximum shut off **(24)**. To do this, if necessary, remove (by loosening it) the reset pin **(25)***;
- Start the system, reset the shut off device as indicated in 4.0 and make sure that there is no gas consumption (close the applications downstream of the regulator);
- Use an auxiliary gas pressure to slowly increase the downstream pressure to the desired value and simultaneously, use the key supplied **(29)** to loosen the ring nut **(24)** until the device is triggered (so as to avoid having to set the Pa again);
- In both cases, reset the system by following the correct procedure and verify that the trigger value is that desired by repeating the release step 2-3 times;
- If necessary, adjust the trigger value by turning the ring nut **(24)** with the specific key **(29)**.

* It must be tightened again in the original position to reset the device.

6.4 - Adjusting the relief valve (differential DfRv)

NOTE: The relief valve (if any) in these regulators is differential, therefore the range value (DfRv) indicated must be added to the range value of the outlet pressure (Pa).

Example: Pa=32-60 mbar - DfRv=15-40 mbar.

Means that the relief valve can be calibrated from: (Pa min + DfRv min) = 32+15=47 mbar to: (Pa max + DfRv max) = 60+40=100 mbar

Therefore the effective range of the relief valve (in this case) is 47-100 mbar.

- Start the system and set the shut off as described in point 4.0;
- Slowly close the valve downstream of the regulator;
- Loosen and remove the cap (**1**);
- Use the appropriate socket spanner (see fig. 1, 2 and 3) tighten the nut to stroke end (**19**);
- Use the 10 mm socket spanner to press the adjustment nut (**19**) and increase the pressure Pa, reading it on the pressure gauge, up to the desired setting value;
- Without pressing further, slowly loosen the adjustment nut (**19**) until the pressure Pa begins to decrease, shown on the pressure gauge;
- In this case, the relief valve is set to the desired value;
- Remove the socket spanner and close the cap (**1**).



7.0 - RECOMMENDED PERIODIC CHECKS

- Use a suitable calibrated tool to ensure that the bolts are tightened as indicated in 3.2;
 - Check the tightness of the flanged/threaded connections on the system;
 - Check the tightness and operation of the regulator/shut off/relief valve;
- The final user or installer is responsible for defining the frequency of these checks based on the severity of the service conditions.

7.1 - CHECK THAT THE MAXIMUM PRESSURE SHUT OFF VALVE IS WORKING (OPSO)

Reset the shut off device and close the valve downstream of the regulator;

Method 1:

1. Loosen and remove caps (**1**) and (**23**);
2. Use the same tool (shown in fig. 3) to press the nut (**19**) and slowly increase the downstream pressure until the device is triggered;
3. Tighten the caps back to their original position and repeat the Pa setting steps (6.4);

Method 2:

1. Alternatively, use an auxiliary gas pressure to slowly increase the downstream pressure until the device is triggered (so as to avoid having to set the Pa again).

7.2 - CHECK THAT THE MINIMUM PRESSURE SHUT OFF VALVE IS WORKING (UPSO)

- Reset the shut off device and close the ball valve upstream of the regulator;
- Open the relief valve, downstream of the device, partially and slowly. As the outlet pressure decreases slowly it will cause the minimum shut off to trigger at its setting value;
- Repeat the trigger step 2-3 times to make sure that the system functions correctly. Between one trigger and another, set the downstream pressure back to the setting value.

7.3 - CHECK THE TIGHTNESS OF THE DEVICES (OPSO AND UPSO)

- Fully empty the downstream pipe section (wait a few seconds to allow it to empty completely). The downstream pressure must remain at zero when the relief valve is closed.

7.4 - CHECK THAT THE RELIEF VALVE IS WORKING PROPERLY

- Start the system and set the shut off as described in point 4.0;
- Slowly close the valve downstream of the regulator;
- Loosen and remove the cap (1);
- Using an appropriate socket spanner (see fig.1, 2 and 3) to press the adjustment nut (19), increase the pressure Pa above the preset value, while preventing the OPSO shut off from being triggered. Use a calibrated pressure gauge for the reading;
- Remove the socket spanner. The generated overpressure will be discharged outwards and the Pa will begin to decrease to the relief valve setting value. Relief valve operation is verified;
- Close the cap (1);
- Open the relief valve to discharge the created overpressure;
- Close the relief valve (the regulator goes to the closing pressure) and open the ball valve downstream of the regulator.



8.0 - MAINTENANCE



- No maintenance operations need to be carried out inside the device. If operations must be carried out inside the device (changing the spring, replacing the filter, etc.), it is advisable to contact the Technical Department. In any case, before carrying out any dismantling operation on the device, make sure that there is no pressurised gas inside.

9.0 - TRANSPORT, STORAGE AND DISPOSAL

- During transport the material needs to be handled with care, avoiding any impact or vibrations to the device;
- If the product has any surface treatments (ex. painting, cathaphoresis, etc) it must not be damaged during transport;
- The transport and storage temperatures must observe the values provided on the rating plate;
- If the device is not installed immediately after delivery it must be correctly placed in storage in a dry and clean place;
- In humid facilities, it is necessary to use driers or heating to avoid condensation;
- At the end of its service life, the product must be disposed of in compliance with the legislation in force in the country where this operation is performed.

10.0 - WARRANTY

The warranty conditions agreed with the manufacturer at the time of the supply apply.

Damage caused by:

- Improper use of the device;
- Failure to observe the requirements described in this document;
- Failure to observe the regulations pertaining to installation;
- Tampering, modification and use of non-original spare parts;

are not covered by the rights of the warranty or compensation for damage.

The warranty also excludes maintenance work, the assembly of parts or non-original spare parts, making changes to the device and natural wear.