



SYNTEC
TECHNOLOGY CO.,LTD.

LA2100-60 Product Manual

匯出日期: 2023-08-21
修改日期: 2023-07-31



TRUSTED INTELLIGENT MANUFACTURING SERVICE

Product manual
Installation and maintenance

C Series
· LA2100-60



About this user manual

Thank you for buying our robot products.

This manual contains instructions for the proper installation and use of robots.

Please read this manual and other relevant manuals carefully before installing and using the robot system. After reading this manual, please keep it within easy access for future reference.

Unauthorized copying or reprinting of part or all of this manual is prohibited.

The contents of this manual may change from time to time without prior notice.

If you find the contents of this manual incorrect or needed to be improved or be supplemented, please feel free to contact us.

Except as expressly stated in this manual, nothing in this manual shall be construed as any warranty or warranty by the Company with respect to personal loss, property damage or specific fitness for purpose.

The Company is not responsible for any accident or indirect injury caused by the use of this manual and the products described in it.

Manual content

This manual contains the following instructions:

- Installation of robots
- The use of robots
- Maintenance of robots

Reading object

This manual is oriented toward:

- Installers
- Maintenance personnel

Warranty

The robot and its optional components are delivered after the company's strict quality control, testing and inspection, and the performance is confirmed to meet the company's standards.

Within the warranty period of the delivered products, the company will only repair the faults that occurred during normal use for free. (Please consult a salesperson in your area for the warranty period.)

However, the customer will be charged for repairs (even within the warranty period) if:

1. Damage or failure caused by improper use and improper use of the manual.
2. Failure caused by the customer's unauthorized disassembly.
3. Damage caused by improper adjustment or unauthorized repair.
4. Damage caused by natural disasters such as earthquakes and floods.

Warning

1. If the use of robots or related equipment exceeds the conditions of use and product specifications described in this manual, the warranty will be invalid.
2. The Company shall not be liable for any fault or accident, or even personal injury or death caused by the use of the products.

3. The Company cannot foresee all possible risks and consequences. Therefore, this manual cannot warn the user of all possible risks.

Inquiry

For the repair/inspection/adjustment of the robot, please contact our after-sales department.

If no after-sales department is recorded, please contact your local distributor.

To save your time, please prepare the following items before contacting:

- Controller name/serial number
- Robot name/serial number
- Software name/version
- Problems with the system



SYNTEC

1 Contents

- Contents
- Safety
 - About this Chapter
 - Safety Terms
 - Safety Identity
 - Risk
 - Safety characteristics
 - What is Emergency Stop
 - Enabling Device
 - Work Safety Guide
 - Description
 - Self Safety
 - Operate the teach pendant
 - Recovery From Emergency Stop
 - Safety Considerations For Manual Mode
 - Safety Considerations For Automatic Mode
 - Handling When Emergency
- Product Overview
 - Overview of Robot System
 - Load capacity
 - Function and purpose
 - Basic principles and main technologies applied
 - Overview of Robot Structure
- Technical parameters
 - Technical parameters
 - The workspace
 - Output flange
 - Load capacity
 - Electronic Control Box Specification
- The installation
 - Environmental Condition
 - On-site installation
 - 4.2.1 Handling
 - Relevant Tools:
 - 4.2.2 Operation Procedure
 - Base
 - (3D Model)I-shaped Riser
 - schematic diagram
 - Installation
 - Mechanical Interface
 - Electrical connections
 - Wiring connection
 - Grounding Instructions
 - User Wiring
 - IO Wiring Definition
 - Function Test
 - Check before Power-on
 - Power-on abnormality check
 - Check the Mastering position, each axis direction, and soft limit of the robot
 - Test procedure of Automatic Mode

- Maintenance
 - 5.1 About safety during maintenance
 - 5.2 Troubleshooting
 - 5.3 Maintenance plan
 - 5.3.1 Check interval
 - Replace Battery
 - Replace Lubricant Oil
- Zero Point
 - About mechanical home
 - Zero point calibration
 - Calibration steps



SYNTEC

2 Safety

2.1 About this Chapter

Instruction

This chapter explains the content that must be observed in the safe use of the robot. Please read this chapter and carefully before using the robot system.

This chapter introduces the safety principles and procedures to be considered when using LEANTEC robots.

User Introduction

Users can be divided into 3 types :

Operators :

- Turn on or off the system power
- Start or stop the program
- Restore system alarm state

Programmers :

- In addition to the operator's work
- Teach new robot programs

Technicians :

- In addition to the programmer's work
- Repair and maintain the robot system

 Both programmers and technicians are required to take professional training from the original factory.

2.2 Safety Terms







2.2.1 Safety Identity

About safety identity

When operating the robot in accordance with the contents of this manual, different degrees of danger may be encountered. Therefore, near the operation instructions that may cause danger, there will be a special safety mark prompt box to remind users to pay attention to precautions. The contents of the prompt box include:

- An icon representing the safety level and corresponding name, such as warning, danger, prompt, etc.
- A simple description of what could happen if the operator did not eliminate the hazard
- Instructions on how to eliminate hazards

Safety level

Icon	Name	Description
	Danger	If the content with this logo is not operated in accordance with the regulations, it will cause serious or even fatal to the personnel Life damage, and will/may cause serious damage to the robot. Operations associated with such hazards include contact with high voltage components in the control cabinet and movement during robot operation into its work area, etc.
	Warning	It is suggested that the current operation may have the risk of accidents, causing serious or even fatal injuries.
	Electric Shock	It is suggested that the current operation may have the risk of electrocution, causing serious or even fatal injuries.
	Caution	Content bearing this logo, if not operated in accordance with the regulations, may result in personal injury and damage to the machine itself.
	Anti-static (ESD)	It is suggested that the parts involved in the current operation are sensitive to static electricity and may be damaged during the operation if they are not operated according to the specification.
	Reminder	Used to suggest important information or prerequisites.







2.2.2

Risk

Introduction



Icon	Name	Description
	Pinch	When operators and maintenance personnel enter the robot's movement range during commissioning, maintenance, overhaul and tool clamping, they may cause damage.

Icon	Name	Description
	Clamp hand	There is a risk of a pinch when the maintenance personnel approaches the belt drive during a maintenance operation.
	Collision	When operators and maintenance personnel enter the movement range of the robot during commissioning, maintenance, overhaul and tool clamping, collision or serious injury may occur.
	Friction	When the operator and maintenance personnel enter the movement range of the robot during commissioning, maintenance, overhaul and tool clamping, there may be abrasions
	Parts fly out	Operators and maintenance personnel enter the movement range of the robot during commissioning, maintenance, overhaul and tool clamping, and the tool or workpiece may fly out due to lax clamping, which may cause serious damage.
	Fire	Fire may occur in the event of a short circuit or wirings and devices catching on fire which may cause serious injury.
	High temperature	When maintenance personnel contacts the high-temperature surface of the robot during equipment overhaul and maintenance, it may cause burns.



Warning, any robot in motion can be fatal!



When a robot is running, it may perform undesirable or even unreasonable movements. In addition, the robot will carry a huge amount of energy when moving, and when a collision occurs, it will cause serious injury/damage to the personnel and equipment in its working range

Elimination of danger

	Operate	Reference information
1	Make sure all emergency stop equipment is properly configured and installed before starting the robot.	Emergency stop equipment includes a safety gate, safety grating, safety light blanket, etc.
2	In the process of robot programming, it is necessary to ensure that the teach pendant is held by the person entering the working area of the robot.	Avoid the danger of operating the robot with the teach pendant when the personnel outside the work area do not observe the personnel inside the work area.
3	Before starting to run the robot program, make sure that there are no other personnel in the robot's work area.	

Robot icon description

Icon	Name	Description
	Collision hazard sign	Keep a safe distance when the robotic arm is in operation to avoid a collision.
	Specification label	Label the specifications of the robotic arm and manufacture dates.

Icon	Name	Description
	Grounding sign	The robotic arm must be connected to the ground to prevent electrical shock.
	Electrical Shock Hazard Sign	The robotic arm might have potential electrical shock risks.
	Operate Carefully Sign	Be careful when operating the robotic arm, and predict the movement of the robotic arm.

2.2.3 Safety characteristics

Instruction

PLC is built into the Syntec system to process safety-related signals, and external safety signal interfaces such as safety gate and safety grating are provided.

Signals processed by PLC include :

- Reset signal
- Safety gate signals
- Emergency stop reset signal
- Enable switching signals
- Mode selection signals
- Servo on signal

2.2.4 What is Emergency Stop

Definition of safe stop

The emergency stop is the highest priority function in the robot system. Pressing the emergency stop button will trigger the emergency stop. At this time, all other robot control functions will stop, the robot will stop moving and the motor power of each joint will be cut off. The control system will switch to the emergency stop state, which will be maintained until it is manually reset.

The emergency stop means that all power to the robot will be cut off except for the manual brake release circuit. To restore the system to its normal state, a manual reset operation must be performed, that is, first release the emergency stop button and then manually press the power on the control cabinet.

After triggering the emergency stop, the system may take either of two different stopping modes according to different working conditions:

- STOP 0, immediately cut off the power supply of the motor and make each joint brake, which is the safest way to STOP. However, the robot is in an uncontrolled state during the stopping process, and may deviate from the path after stopping. The emergency STOP in manual mode belongs to STOP 0.
- STOP 1. After the emergency STOP is triggered, the control system will immediately decelerate along the path. Then the safety module will cut off the power supply of the motor and make all the joints lock, no matter whether the robot stops completely or not. In the vast majority of cases, due to a controlled stop, the robot will end up on the programming path, providing the best protection against peripherals. By default, the emergency STOP in automatic mode belongs to STOP 1.



Reminder

An emergency stop is only used to stop the robot immediately in a dangerous situation.



Reminder

The emergency stop should not be stopped as a normal procedure. Otherwise, it will cause extra and unnecessary wear to the brake system and transmission system of the robot, and reduce the service life of the robot.

Emergency stop button

By default, the robot system is equipped with two emergency stop buttons that trigger an emergency stop when pressed. One is mounted on the control cabinet and the other is mounted on the teach pendant.



In addition, your system integrator may install additional emergency stop buttons during the robot deployment process. Please contact your system integrator or consult the robot workstation documentation for more information.

2.2.5 Enabling Device

It is a special switch with two presses and three positions, which only works if the enable switch been pressed and kept in the middle position. If the switch is released or fully pressed, the robot movement will be stopped.

It needs to be pressed together with other keys to prevent mistouch.

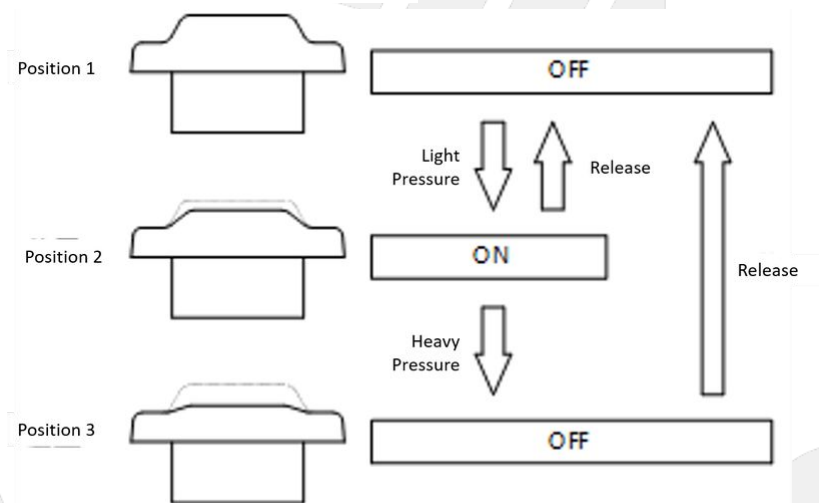

Reminder

The enabling device is mounted on the back of the teach pendant, and Jog or run programs can only be performed when pressed it to the middle position. The operation is invalid when the switch is released or fully pressed.

For safe use, the following requirements must be observed:

- Enable switches must work properly under all circumstances.
- During programming and commissioning, release the switch when robot movement is not required.

Anyone entering the robot's workspace must carry a teach pendant with them to prevent others from starting the robot without the knowledge of insiders.



Warning
External devices that jam the enabling device in the middle position are strictly prohibited!

2.3 Work Safety Guide

2.3.1 Description

About Robots

No matter how fast they move, industrial robots are potentially dangerous. A pause or wait in a program may be followed by a very fast and dangerous motion command. Even if you are already familiar with the current robot's trajectory and mode, the robot's trajectory in automatic mode can still be changed by external signals without warning.

Therefore, safety regulations must be followed when entering the working area of the robot.

About working area, safe area and danger area

The working area is the range in which the robot can move and should be limited to the minimum necessary size. Appropriate protective measures must be used to protect the work area. The protective devices (such as a safety gate) must be located in a safe area. When it stopped, the robot will be braked and stopped in the danger area. Danger area includes the range of working area and the stopping distance of the robot, it must be protected by physical protective measures to prevent danger to humans or property damage.

About this section

This section will introduce some basic safety regulations for end users. However, due to space limitations, it cannot cover every specific situation.

2.3.2 Self Safety

Basic Principle

There are a few simple principles that must be followed in order to operate a robot safely:

- All of the operating procedures must be professionally evaluated and based on relevant industrial safety regulations.

- Operators who work with robots must wear safety equipment suitable for the working environment before performing operations, such as safety vests, safety shoes and safety helmets.
- When personnel encounter danger or other emergency and abnormal situations due to the robot, please press the emergency stop button for the first time, and use the manual mode to move the robot away from the dangerous situation at low speed.
- A safety area must be set outside the working area of the robot, and appropriate safety devices must be used to prevent unauthorized personnel from entering.
 - The operator must be outside the safe area to operate the robot.
 - When a worker is in the safe area of the robot, the robot can only be operated in manual mode.
 - When you enter the secure area of the robot, you must hold the teach pendant in your hand to ensure that the robot is under your control.
- Keep an eye out for moving tools, such as drills, saws, etc. installed on the robot. Make sure the tools stop working before approaching the robot.
- Pay attention to the problem of the workpiece surface or robot body. After long working hours, the temperature of robot motor and outer shell may be very high.
- Pay attention to the robot's gripper and the objects it is holding. If the gripper is opened, the workpiece may fall and cause injury to personnel or damage to equipment. In addition, the grippers used by the robot can be very powerful and can cause damage if not used properly.
- Watch for electrical components in the robot and control cabinet. Even when power is lost, the energy stored in the device can be very dangerous.
- Any move of a climbing robot is forbidden.



Warning

- Relevant education training and permission is a must for the person installing the robot.
- In order to protect personal safety, the installation procedures in this manual and related industrial safety regulations must be followed.
- Avoid placing the control box near high voltage or other components that generate electromagnetic fields, to prevent the electromagnetic interference which may cause deviation or malfunction of the robot.
- It may cause damage or malfunction of the robot if it uses aftermarket repair parts.
- Be careful of the heat source generated by the controller and servo motor.
- Do not excessively bend the power signal cable. Otherwise, it may cause unexpected danger.
- The teach pendant removed from the control cabinet should be properly stored away from the robot workstation or control cabinet. It is needed to prevent that the operator might be misled to think that the teach pendant is still connected to the control cabinet and try to use the unconnected teach pendant to stop the robot when danger happened.

Precautions for using hydraulic and pneumatic



Danger

- When using hydraulic and pneumatic in operation, the clamped workpiece may fall due to insufficient pressure or gravity.
- The hydraulic and pneumatic systems need to be equipped with safety valves for emergency use.

2.3.3 Operate the teach pendant

Instruction

The teach pendant equipped with Syntec system is manufactured with advanced electronic components. In order to avoid failure or damage during use, please follow the following requirements.

Teach pendant controller lecturers are developed, manufactured and tested in accordance with relevant industry standards and are intended for use only as described in this manual. If you follow the requirements in this manual, the teach pendant controller will not cause personal injury or damage in normal use.

Operation and cleaning



Danger

The programming must be performed outside the safety fence. If you need to enter the safety fence for operation, you must press the emergency stop button.

- Handle it lightly to avoid falling, throwing or a strong impact on teach pendant. Otherwise, it may cause obstacles.
- If the teach pendant experiences a strong shock, verify that the enable switch and emergency stop button are still in normal working conditions before using again.
- When you do not use the teaching device, please store it properly to avoid accidental dropping.
- Avoid tripping over your own cable when using the teach pendant.
- Do not operate the touch screen with sharp objects, such as a screwdriver, pen tip, etc.. Otherwise, the touch screen may be damaged. Operate with a finger or a stylus on top of the pointer.
- Clean the touch screen often, dust and small particles of impurities may cause the touch screen to malfunction.
- Do not use chemical solvents, detergents or washing surfaces to clean the teach pendant. Use a soft cloth and a small amount of water to scrub.
- When not using the USB interface, the protective adhesive cap must be properly fastened. Otherwise, exposure to dust may cause interface failure.

Pendant cable

- Ensure that the staff does not trip over the teach pendant cable and causes the teach pendant to fall.
- Do not squeeze the teach pendant cable. Otherwise, it may damage the inner core.
- Do not place the teach pendant cable at sharp edges, as this may damage the cable sheath.

2.3.4 Recovery From Emergency Stop

Instruction

The reset operation must be performed when the system is in an emergency stop state in order to return to the normal state. The reset process is very simple but very important to ensure that the robot system is not put into production operation in a dangerous state.

Reset emergency stop button

All button-type emergency stop devices have a safety lock mechanism that must be manually released after being pressed to reverse the emergency stop state of the device. Most emergency stop buttons are released by rotation, with the direction of rotation marked on the surface of the button. There are also some buttons that support a direct uppull release method.

Reset the external stop device

All external emergency stop devices such as safety gates, safety gratings, etc., have some type of safety lock mechanism. If you use external emergency stop devices in your robot workstation, please consult your system integrator for more device reset information.

Recovery from E-Stop

Operate	
1	Confirm that the hazardous condition causing the emergency stop has been addressed and that the hazard source is no longer present.
2	Reset a safety device that causes an emergency stop.
3	Press the RESET button on the teach pendant controller to restore the system from the emergency stop.

2.3.5 Safety Considerations For Manual Mode

About manual mode

In manual mode, the movement of the robot is under manual control. Jog or run the robot only if the enable switch is in the middle position.

Manual mode is used to write and commission robot programs and participate in the commissioning of the workstation.

Speed limitation under manual mode

In manual mode, the movement speed of the robot end is limited to under 250mm/s, that is, whether it is a Jog robot or running a program and regardless of the speed set in the program, the maximum movement speed of the robot will not exceed 250mm/s.

Bypass external safety signals

In manual mode, signals of external safety devices will be by bypassed, such as safety doors and safety light barriers. This means, to facilitate debugging, the system will not be in an emergency stop state even if the safety door is opened in manual mode.

2.3.6 Safety Considerations For Automatic Mode

About automatic mode

The automatic mode is used to run the robot program during the formal production process.

In the automatic mode, the enable switch will be bypassed, so the robot can run automatically without human involvement.

Enable external safety signals

External safety signals such as safety gate and safety grating will be enabled in automatic mode, and an emergency stop will be triggered when the safety gate is opened.

Safe fault recovery in processing production

Most of the time, robots are part of a production line, so robot failures do not only affect the workstation itself but when problems occur in other parts of the production line, the robot workstation may also be affected. Therefore, it is up to those familiar with the entire production line to design fault recovery solutions to improve safety.

For example, on a production line, the robot needs to grab the workpiece from a conveyor belt. In case of a robot failure, in order to ensure that the production process is not interrupted, the conveyor belt should be kept in operation while the robot is being repaired. At this time, the robot maintenance personnel should consider additional safety measures for working beside the conveyor belt in operation.

Another example, when a welding robot is removed from a production line for routine maintenance, other robots associated with the same process must also be stopped to prevent human injury.

2.3.7 Handling When Emergency

Handling of light fire

In the event of imminent fire danger or fire that has already started but not yet spread, do not panic, remain calm and extinguish the flames with the fire extinguishing equipment provided at the scene. Do not use water to extinguish the fire caused by a short circuit.

**Warning**

The user shall provide the fire extinguishing device for the robot in the working site. The user shall select the appropriate fire extinguishing device according to the actual situation on the site.

Measures to deal with severe fire

When the fire has spread and is out of control, site staff should not try to put out the fire, but should immediately notify other staff, give up personal belongings, and evacuate from the emergency exit as soon as possible. Elevators are not allowed during an evacuation, and the fire brigade should be called during evacuation.

If a person or clothing is on fire, do not let him/her run away. Instead, let him/her quickly lie down on the ground and put out the fire with clothes or other suitable objects and means.

Handling of electric shock accident

When someone gets an electric shock, don't panic. First, cut off the power as soon as possible.

**Warning**

Do not contact the electrocuted person directly. Otherwise, the rescue personnel may also be electrocuted!

Appropriate methods and measures should be taken decisively according to the specific conditions on the spot. Generally speaking, there are several methods and measures shown below:

- If the power switch or button is close to the shock point, pull the switch quickly and cut off the power.
- If the power switch or button is far away from the electric shock location, insulated pliers or axes, knives and shovels with dry wooden handle can be used to cut off the power side (i.e., where the electricity is coming from). The cut wire should not touch the human body.

When the wire is attached to or under the body of the electrocuted person, dry wooden sticks, wooden boards, bamboo poles or other tools with an insulating handle (holding the insulated handle) can be used to quickly remove the wire. Do not use any metal bar or wet things to pick up the wire, so as to avoid the electrocuted person.

Treatment of electrocuted wounded person

- If the electrocuted victim is conscious, lay him/her on his/her back and watch him/her closely. Do not stand or walk for a while.
- If the contact person is unconscious, lay him/her on his/her back to make sure the airway is clear, and call or pat him/her on the shoulder at a 5-second interval to determine if he/she is unconscious. Do not swing the victim's head to call the victim. Contact the ambulance as soon as possible while rescuing on the spot.

- If the electrocuted victim loses consciousness, the patient's breathing and heartbeat should be judged within 10 seconds. If there is no breathing and no pulsation of the artery, it can be determined that the respiratory heart has stopped, and it should be rescued by cardiopulmonary resuscitation immediately.



SYNTEC

3 Product Overview

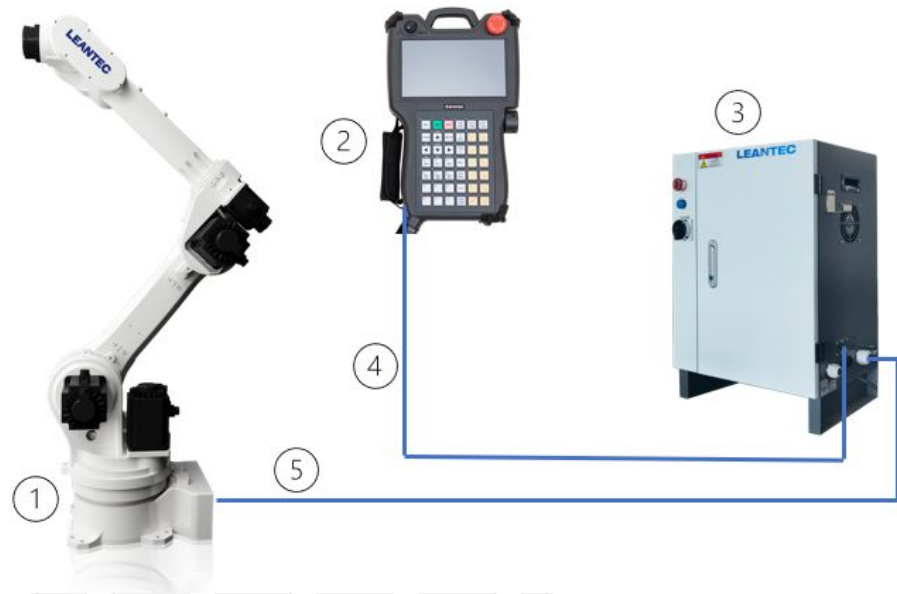

3.1 Overview of Robot System

System overview

A complete robot system includes the robot body, controller, instructor, connecting cables, software, terminal actuators and other accessories, as shown in the figure below.

The figures are illustrated below:

- 1 = robot
- 2 = teach pendant
- 3 = control cabinet
- 4 = teach pendant cable
- 5 = cabinet cable

3.2 Load capacity

Load capacity of the joint robot

SYNTEC

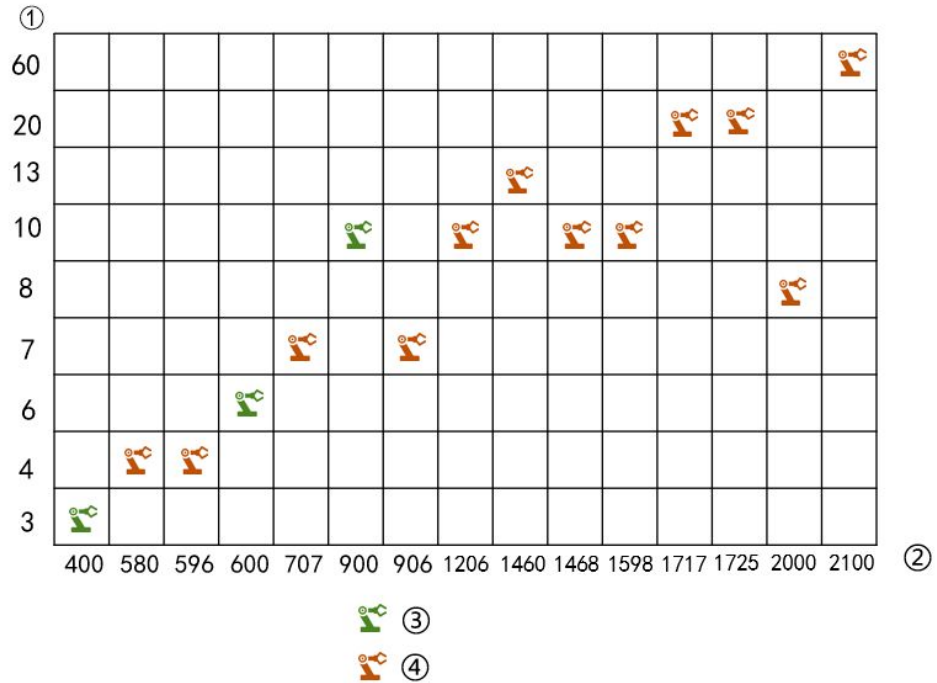

Label	Name
①	Load capacity (KG)
②	Work space (mm)
③	Four joints robot
④	Six joints robot

3.3 Function and purpose

Function and purpose

An industrial robot is a mechanical and electronic device that anthropomorphizes arms, wrists and hand functions; it can move any object or tool according to the time-variant requirements of spatial position-pose (position and orientation) to complete the operation requirements of a certain industrial production. The use of Leantec industrial robot is as follows: To carry out spot welding or arc welding on the body of cars or motorcycles using welding guns or welding torches to carry parts or components formed by die casting or stamping, laser cutting, spray and to assemble mechanical parts and etc.

3.4 Basic principles and main technologies applied

Principles and technologies

Principles: Leantec robot is composed of a four-joint robot, control cabinet and 81R teach pendant controller. The teach pendant controller gives the command to two SYNTEC three-in-one drivers, and the drivers drive the six motors on the robot to rotate regularly to control the motion path of the center of rotation at the end of the sixth axis.

Technologies:

1. High speed and precision advanced:

After the user has programmed through the human-machine interface of the teach pendant, the corresponding robot program will be generated. After the program is planned for high speed and high precision offset time, the position command will be transmitted to the Servo Motor Driver through serial communication at each offset time, so that the lower machine does the command planning of the servo motor.

2. Servo motor control:

After receiving the position command from the Controller, the drive will make further motor command planning and send the motor command of each offset time to the servo motor, so that the servo motor could drive the reducer to run.

3. After completing the two points above, the reducer will drive the operation of the robot and completes the action edited by the user to meet application scenarios such as welding, picking, and placing, etc.

3.5 Overview of Robot Structure

Structure

The main structural parts of the robot body are made of cast aluminum alloy, with a total of 6 degrees of freedom. Each joint motor is equipped with a brake. A mechanism consists of the following parts:

- i. Wrist -- The wrist has three degrees of freedom and is located at the output end of the robot, including axis 4th, axis 5th, and axis 6th.
- ii. Forearm -- The forearm is located between the upper arm and the wrist and is driven by the 3rd motor.
- iii. Upper arm -- The upper arm is located between the lower arm and the lumbar joint and is drive by the 2nd motor.
- iv. Waist -- The waist is located between the upper arm and the base and is driven by the 1st motor.

SYNTEC

- v. Base -- The base is the foundation of the robot, with electrical connections for the robot at its rear.

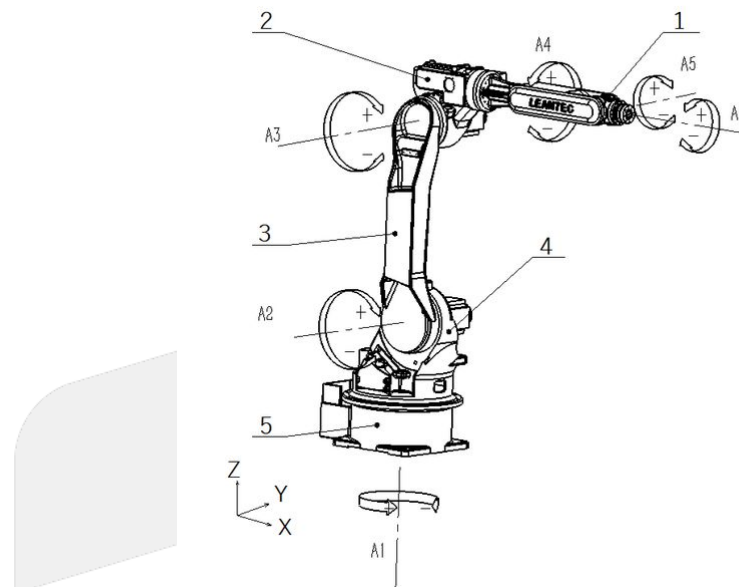

Each axis motion:

- A1 axis: whole mechanical arm rotation
- A2 axis: upper arm pitch
- A3 axis: small arm pitch
- A4 axis: small arm rotation
- A5 axis: wrist swing
- A6 axis: wrist rotation

SYNTEC

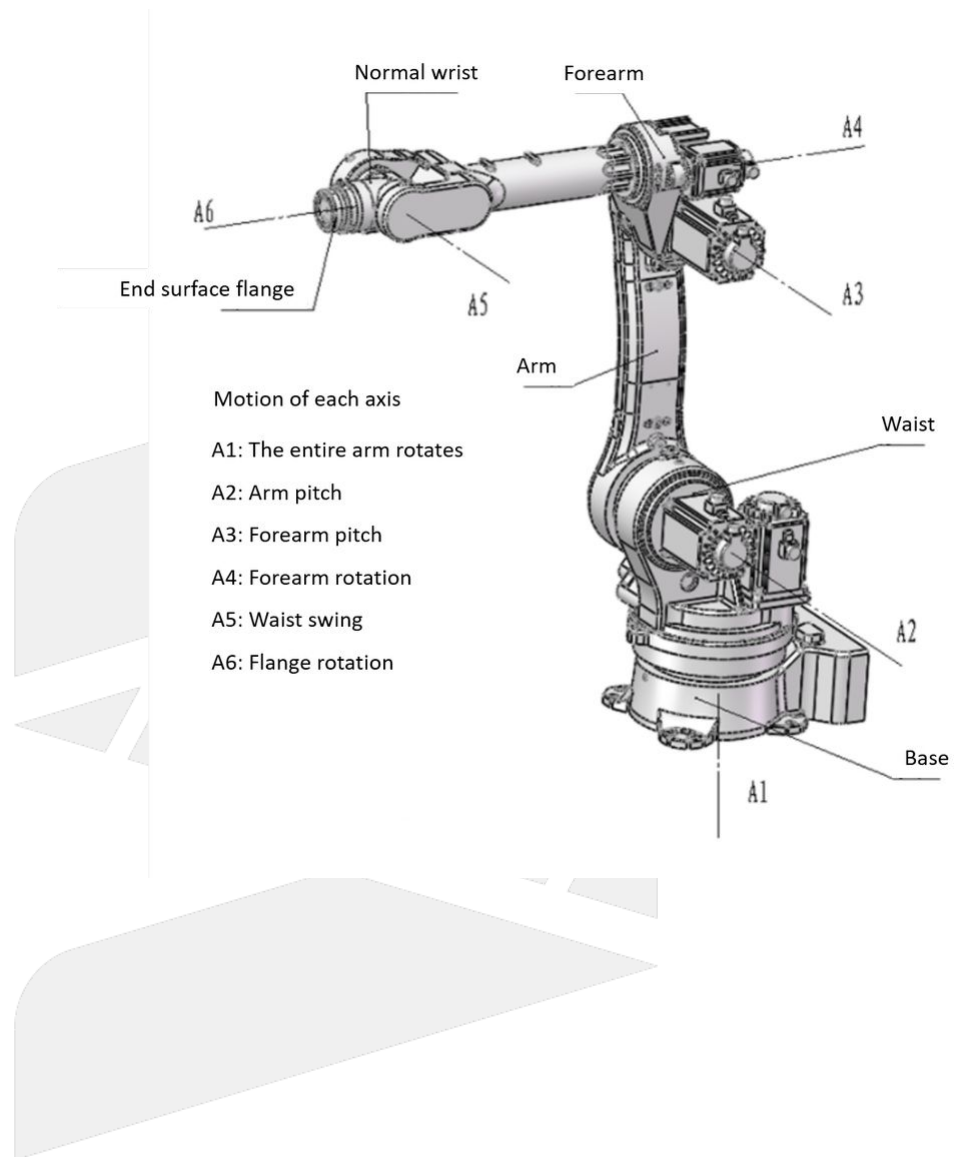

SYNTEC

4 Technical parameters

4.1 Technical parameters

Performance parameter table

The performance parameters of the robot are shown in the table

Model		LA2100-60
DOF		6
Maximum arm reach		2100mm
Positioning repeatability		±0.2mm
Wrist rate load		60kg
Range of motion	Axis 1	+160°~-160°
	Axis 2	+135°~-90°
	Axis 3	+82°~-135°
	Axis 4	+180°~-180°
	Axis 5	+125°~-105°
	Axis 6	+360°~-360°
Maximum speed	Axis 1	133°/s
	Axis 2	105°/s
	Axis 3	105°/s
	Axis 4	348°/s
	Axis 5	198°/s
	Axis 6	298°/s

SY

Model	LA2100-60
Operating temperature	0°~+45°
Storage temperature	-10°~+55°
Protection Grade	Standard IP54
Method of Installation	Floor, upside, tilt
Base Dimension	375mm×375mm (8个)
Base Mounting Hole	See section 4.2.2
Noise Level	≤80dB(A)
Weight	approx 780kg

4.2 The workspace

Robot workspace

LA2100-60 The working space of the robot is shown in the following figure:

SYNTEC

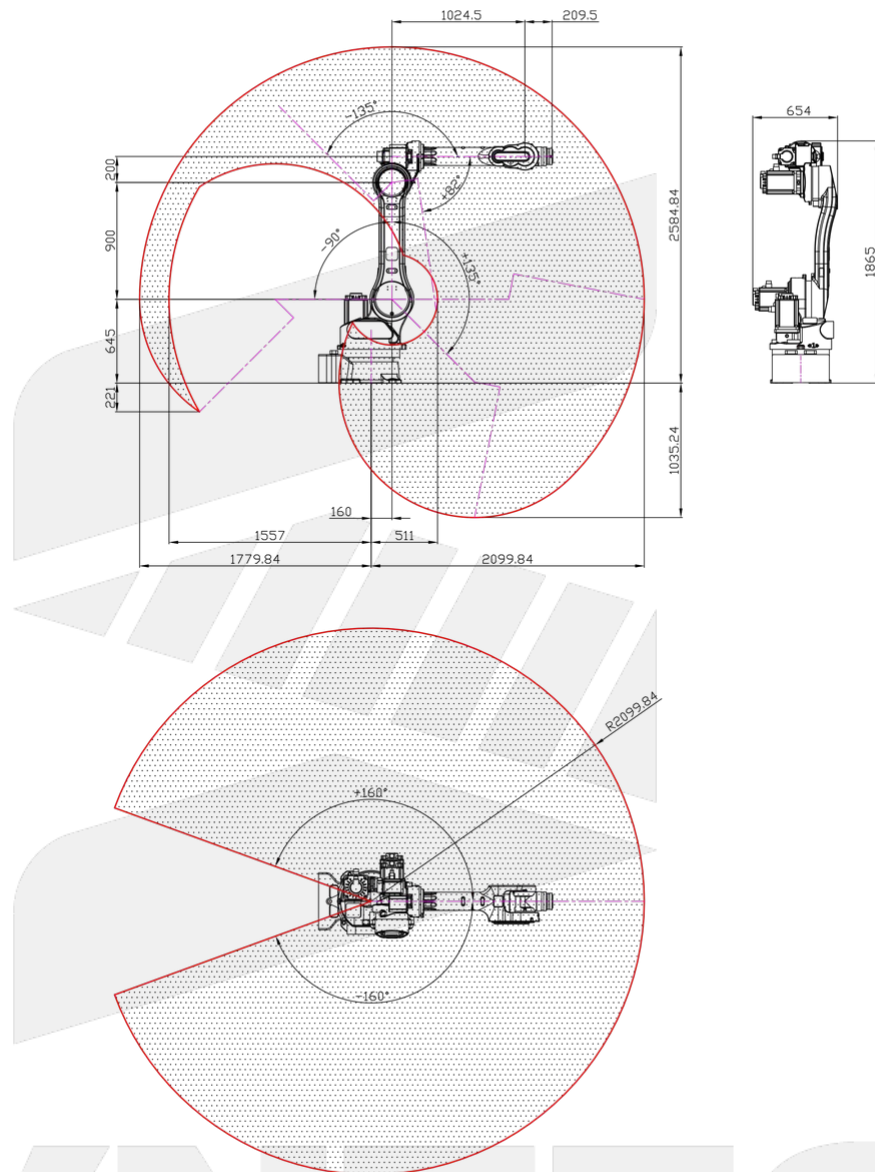

SYNTEC



Reminder
In practice, consider the impact of installation on the workspace.

Hard Limit

The hard limit of the robot is shown in the figure:



Reminder

When the battery voltage is too low, the position limit is set too large, the home position is set incorrectly, or the direction of rotation is set incorrectly, body interference is likely to occur during robot motion, which damages the appearance of the robot, the motor, reducer, and the internal wires. By installing the hard limit on the 1st, 2nd, and 3rd axes of the robot, it can prevent the above improper operation from causing damages.

4.3 Output flange

Instructions

Please make the robot end fixture by yourself according to actual needs and connect it to the output flange of the wrist. The size of the output flange is shown below. The

strength of the fixed hexagonal set screw is grade 12.9. The shape and size of the fixture installed on the output flange may affect the rotation range of the robot axes. Please pay attention to the interference area at the end of the fixture in the design.

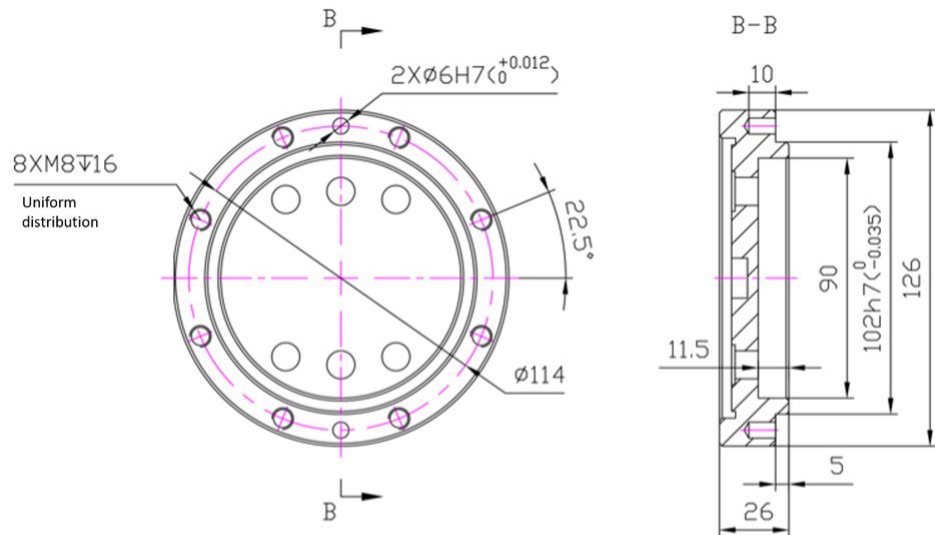

4.4 Load capacity



Warning

Using incorrect load data may cause the robot to overload!

If a load other than the load diagram is used, the motor, reducer, and other parts of the robot may be damaged due to overload!

SYNTEC

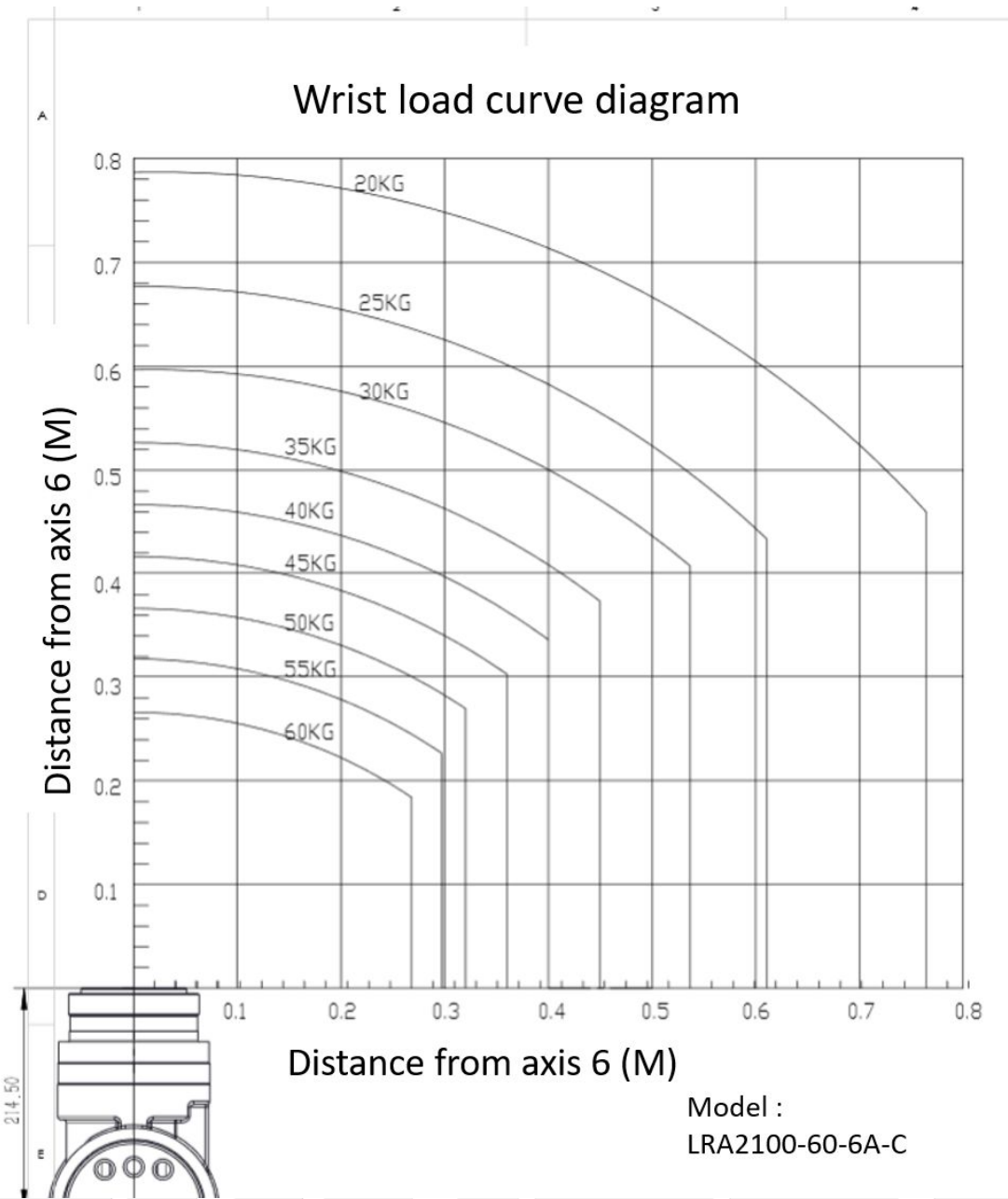

4.5 Electronic Control Box Specification

The standard specifications of the electric control box are listed below.

Electronic Box C3	
Entity diagram of electronic control box	
Corresponding Model	LRA2100
Power Supply	Three-phase electric power 380VAC, 50Hz/60Hz • LRA2100: 14.5KW/380V, 53.8A
Input/Output Signals	16I/ 80+16O
Analog Input/Output*	1AD/ 2DA
Size	600mm x 570mm x 970mm
Weight (kg)	90
Remarks	

The dimensions of the electric control box are shown in the following figures.

SYNTEC

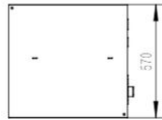
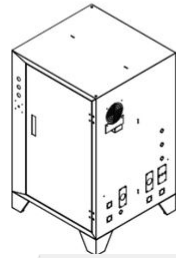
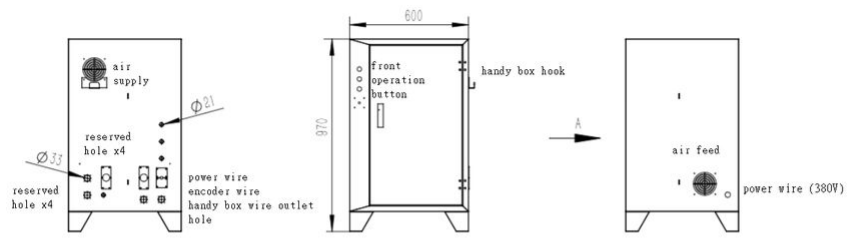

SYNTEC

5 The installation

5.1 Environmental Condition

Description

The working environment of the robot shall meet the following conditions:

Item	Conditions
Temperature	Work: 0°C~+45°C Store/transportation: -10°C~+55°C
Relative humidity	Usually under 75%RH (No frost) short term under 90%RH (in one month)
Allowable height	Altitude below 1000m
Allowable vibration	4.9m/s ² Under 0.5G
Circumstance	<ul style="list-style-type: none"> • Indoor installation • Avoid sunlight • Keep away from dust, fume, salt, iron filings, etc • Stay away from flammable, corrosive liquids and gases • Do not contact with water • Do not transmit shocks and vibrations • Stay away from electrical interference sources



Reminder

- At low temperatures (<10°C), the grease (or lubricating oil) in the reducer (or gearbox) is of high viscosity, which may cause shutdown or inefficient operation of the robot.
 - It is recommended that the robot preheat together with other equipment, and also suggested to preheat at a low speed.

It is not allowable to use under the following circumstances



Danger

- A Potentially explosive environment.
- A corrosive environment.
- A flammable environment.

- A radioactive environment.
- An environment without risk assessment.
- Used for the transportation of humans and animals.
- Operation uses non-allowed parameters.

5.2 On-site installation

5.3 4.2.1 Handling

Use crane/large load forklift to move the robot body



Warning

In principle, please use a crane for unpacking, moving and carrying the LRA2100-60-6A-C robot body. The body of the LRA2100-60-6A-C robot weighs about 780kg that lifting requires two M10 rings and a KT-1 sling. Before lifting, make sure that the robot is in the factory attitude as shown in the figure below, and the sling is fixed and stable before lifting. Lifting a robot in any position other than the recommended position may cause the robot to tip over and cause serious damage or injury!



Warning

Under any circumstances, no person is allowed to be under the lifted robot.



Danger

Make sure to turn off all power, hydraulic, and air sources of the robot during transportation. When the arm is unboxed, its orientation is the unboxing posture. **It cannot be lifted directly because the weight of the arm body is about 750KG.** The unboxing orientation is not at the equilibrium point, if it is lifted at this time, it will turn over and might directly cause accidents.

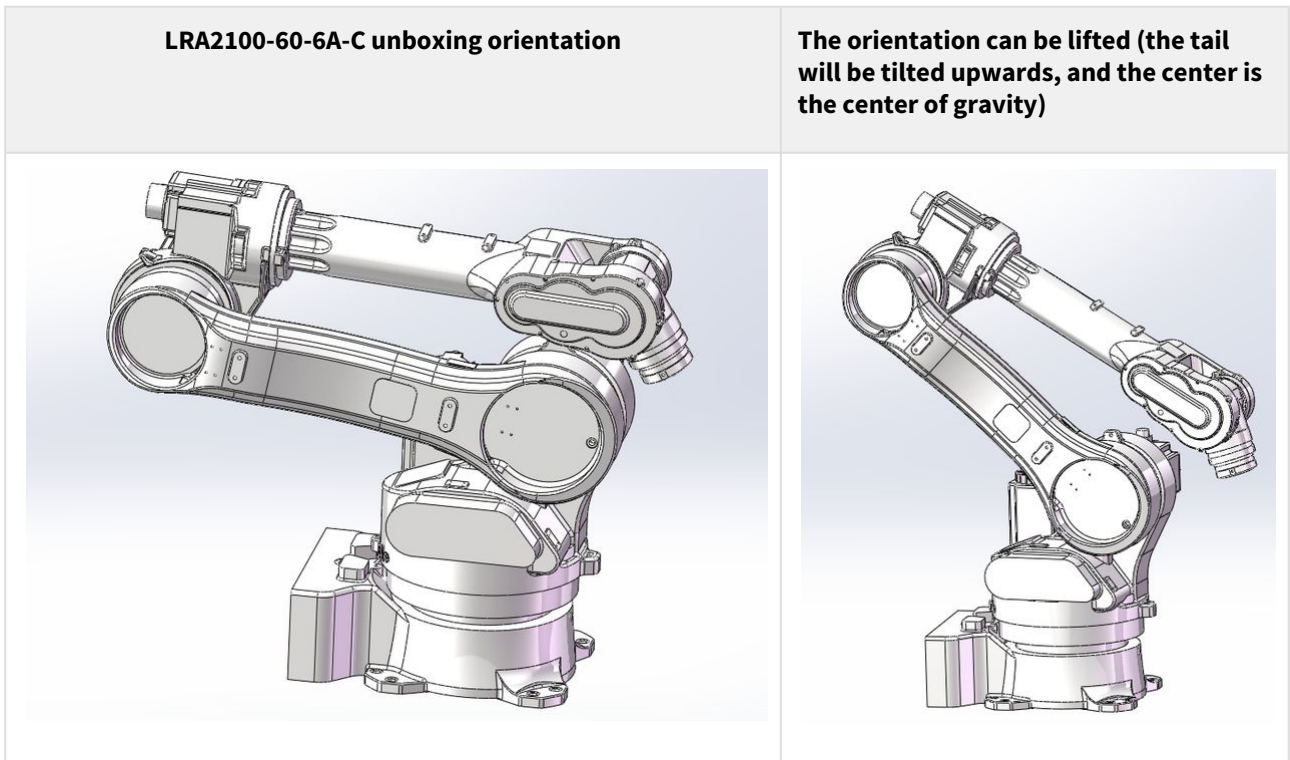

The angles of unpacking are as follows:

C1	C2	C3	C4	C5	C6
0°	-76°	76°	0°	45°	0°



Danger

(1) At this time, the orientation needs to be modified to a balanced one that can be lifted. After unboxing, the operator needs to power on the arm first and adjust the joint coordinates of axis 2 and 3 manually or by returning to the reference point according to the joint position of each axis in the figure below. The final orientation ensures that the current coordinates are consistent with the reference point coordinates. Once the adjustment is completed, power off the robot and unplug the aviation plugs before proceeding to lift the arm.



关节座标 ●就绪 示教 用户:0 工具:0 倍率: 100 警报

11

目前座标 >> 外部轴

C1	C2	C3	C4	C5	C6
0.000	-25.000	70.000	0.000	0.000	0.000
X	Y	Z	A	B	C
156.057	0.000	430.471	180.000	45.000	-180.000

参考点位置

C1	C2	C3	C4	C5	C6
0.000	-25.000	70.000	0.000	0.000	0.000
X	Y	Z	A	B	C
156.057	0.000	430.471	180.000	45.000	-180.000

用户坐标: 0 工具坐标: 0 回参考点

参考点 增加 删除 全删

1 吊装姿态



2

<< 参考点 档案管理 >>

LRA2100-60-6A-C Coordinate value of each axis of joint arm lifting

5.3.1 Relevant Tools:

Hardware: One forklift or truss, 6 lifting bolts(included with the robot), 2 slings;

Sling: 3 tons, 2 meters	Lifting bolts (included with the robot)
 <p>3 Tons Sling Wide is 7.5cm</p>	

5.3.2 4.2.2 Operation Procedure

- 1) Check whether the 6 lifting bolts are firm. If not, tighten the bolts clockwise;
- 2) Hang 2 slings on 6 lifting bolts and avoid touching the power line and encoder line of the motor to connect and fix them on both ends of the arm (3 bolts on each side, left and right).

Note: The lifting speed should not be too fast to avoid excessive lifting and scratching the arm.

- 3) One person carries the sling with both hands, waiting for the forklift to insert; Wait for the forklift to be inserted into the sling for more than 400mm, then slowly lift the robot arm up. When the sling is tightened, stop the forklift from rising. The person who originally carried the sling should hold the arm to prevent the arm from spinning when it was separated from the base, slowly raised the height of the forklift to more than 200mm from the mounting surface. Retreat the forklift to an open area, set the center of gravity of the lower arm to the height of 200~300mm from the ground, and move the arm above the installation position. (The arm needs the support of a person to prevent the arm from falling off due to swinging).

As shown in the picture:







Note: Operators who assist on the side must wear protective shoes and helmets. During the entire lifting process, the assisting personnel must not place their limbs under the robot arm to avoid injury.

- 4) Move the arm to the top of the mounting base and slowly drop it with the weight of the main body, which is about 60KG. The same person assists in mounting the hole position then drop the arm completely. Use a hexagon wrench to adjust the position of mounting holes. Use an M14 screw (add spring washer, washer, length 40mm) and pre-tighten it.

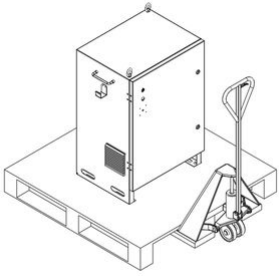
5) Insert the aviation plug and lock it; connect 380V to the electrical box and grounding.

Forklift/Human Handling Control Cabinet

Schematic diagram of forklift handling	Control Cabinet Schematic		
			
	C1 type electric cabinet	C2 type electric cabinet	C3 type electric cabinet



Warning

Confirm that there is a safe working environment so that the LEANTEC robot can be safely transported to the installation site.

Notify the personnel working in the forklift route area and ask them to pay attention to the robot or control cabinet that is during the process of transportation.

Avoid displacement or tipping of the robot or control cabinet during transportation.

Lower the height position as much as possible during the transportation of the robot or control cabinet.

Avoid obvious vibration of the robot or control cabinet, and strictly prohibit falling or impact during transportation.

The electric cabinet weighs about 20KG and can be lifted manually by the two handles on the top.

5.3.3 Base

Configuration

Two kinds of fixing method

1. The arm is directly fixed on the station plate, and the station plate is connected with anchor bolts and ground.

(3D Model)I-shaped Riser

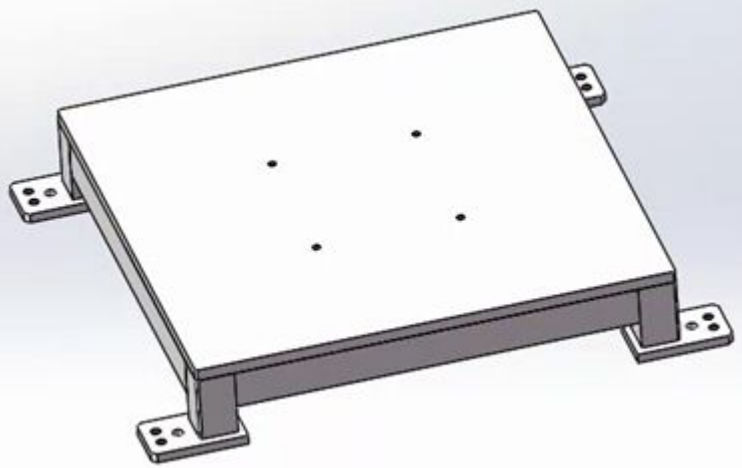

2. The arm is fixed on the I-shaped riser as shown in the figure, and the I-shaped base is connected to the anchor bolts and ground.

schematic diagram



Installation steps of station plate/I-shaped riser and ground

1. **Hardware Preparation**

Category	Name	Quantity
Electrical tools	Electric Drill	1 set
	18 Drilling Bits	1 set
	16 Drilling Bits	1 set
General Tools	16 Drilling Bits	1 set
	Measurement Tape	1 set
	Spirit Level	1 set
Solution 1: Consumables	M16 Chemical bolt	8 pieces
	M16 Supporting chemical reagents	16 bottles
	M16 Nuts	8 pieces
Solution 2: Consumables	M14 Supporting expansion screws	8 pieces

2. **Ground Drilling**

a. According to the design requirements and the drawing, located the position of spacing and margins, then drill the holes on the riser. The hole diameter and hole depth must meet the design requirements. The mounting hole is generally 2mm larger than the bolt diameter.

b. **Specification of Drill Hole**

Anchor specifications (mm)	M10	M12	M16	M20	M24
Drilling diameter (mm)	12	14	18	25	28
Drilling Depth (mm)	90	110	125	170	210
Bolt length (mm)	130	160	190	260	300
Maximum anchor thickness (mm)	20	25	35	65	65

c. **Anchor bolt margin and minimum thickness requirements of concrete members**

Anchor specifications	M10	M12	M16	M20	M24
Minimum margin (mm)	45	55	65	85	105
Minimum anchor distance (mm)	45	55	65	85	105
Substrate minimum thickness (mm)	110	130	145	190	230

d. **The average failure load and design load of a single anchor**

Anchor specifications	M10	M12	M16	M20	M24
Breaking Tension (KN) (C30 Concrete)	31.87	45.57	71.58	137.69	186.69
Breaking shear (KN) (C30 concrete)	17.25	29.05	53.43	84.42	114.15
Design tension (KN) (C30 concrete)	10.32	14.76	23.26	44.56	60.90
Design shear force (KN) (C30 concrete)	5.79	9.95	14.40	28.65	45.77

e. **Setting time**

Temperature in concrete	-5°C~0°C	0°C~10°C	10°C~20°C	Over 20°C
Gel time	60min	30min	20min	8min
Hardening time	300min	60min	30min	20min

3. **Clear Hole**

- a. Use a tool such as an air pressure blower to remove the dust in the hole and keep the hole clean.

4. **Place The Medicine Tube or Fix It with Expansion Screw Skip to Step 8**

- a. Insert the medicament tube into the clean hole (recommended to insert two medicinal tubes into one hole). The resin can flow like honey under the condition of hand temperature after insert, then the hose can be used.

5. **Drilling Bolts**

- a. Screw in the screw with an electric drill until the medicine flows out. Electric drills generally use impact drills or hand drills with a drilling speed of 750 rpm. The bolt is screwed in and the medicine tube will be broken at this time. The resin, curing agent, and quartz particles are mixed, and the gap between the anchor bolt and the hole wall is filled.

6. **Gel Process**

- a. Keep the installation tool still, and refer to the chemical reaction time in the setting time table.

7. **Hardening Process**

- a. Remove the installation tool and wait for the agent to harden. The chemical reaction time refers to the setting time table and wait for the agent to harden completely.

8. Fixed objects

- a. Add washer and hex nut to fix the object.



Warning

- The screw must be drilled with an electric drill and cannot be knocked in (in order to make the liquid evenly fill the gap);
- Before installing the bolts, you must ensure that the holes are clean and there is no water accumulation;
- The mounting hole is generally 2mm larger than the bolt diameter.

5.3.4 Installation



Warning

Do not install or operate robots that are damaged or lack parts. Otherwise, accidents such as personal injury and equipment damage may occur.

After the setting is completed, be sure to remove the handling fixture before power on, or the drive part may be damaged.



Danger

It is necessary to set up a safety bar, or accidents such as personal injury and equipment damage may occur. Ensure that the safety bar is not inside the working area of the end of the robot and the fixture. Otherwise, accidents such as personal injury and equipment damage may occur.

When the robot is not fixed, it is prohibited to power on and operate, or accidents such as tipping, personal injury, and equipment damage may occur.



Reminder

The control cabinet should be installed outside the operating area of the robot (outside the safety bar).

The control cabinet should be installed in a position where the robot motion can be clearly seen.

The control cabinet should be installed in a position that is convenient to open the door for inspection.

The control cabinet must be at least 500mm away from the wall to keep the maintenance channel open.

Safety Device

According to the safety protection device regulations: "When the industrial robot is running automatically, the operator is in danger of contacting the robot, so safety measures such as a protective bar to prevent the operator from approaching must be provided."

In order to avoid equipment damage and personal injury of operators and surrounding personnel during the operation of the robot, the necessary safety devices must be

installed. Safety devices mainly include safety bars, safety doors, safety pins and slots, and other protective equipment.

Instructions

The installation of the robot is very important to its function. It is especially worth noting that the base and the foundation can withstand the dynamic load of the robot during acceleration and deceleration and the static weight of the robot and fixtures. In addition, if the mounting surface of the robot is not flat, the robot may deform and its performance may be affected.

When the robot accelerates or decelerates, a large reaction force will be generated in all directions of the base. Therefore, in the installation of the robot, the foundation must be able to bear the static load and the reaction force during acceleration and deceleration to ensure that the base of the robot is firm and does not move. Robot base by 2 - Φ 6 pin positioning (recommended with the convenient disassembly threaded cylindrical pin, GB/T 120.1 2000), And fasten it with 8-M14 screws (in order to prevent screw loosening, it must be used with flat pad and spring pad). See the table below for screw requirements

Screw	M14×55
Quantity	8
Strength Level	12.9
Tightening torque	226±5Nm

Base hole size

SYNTEC

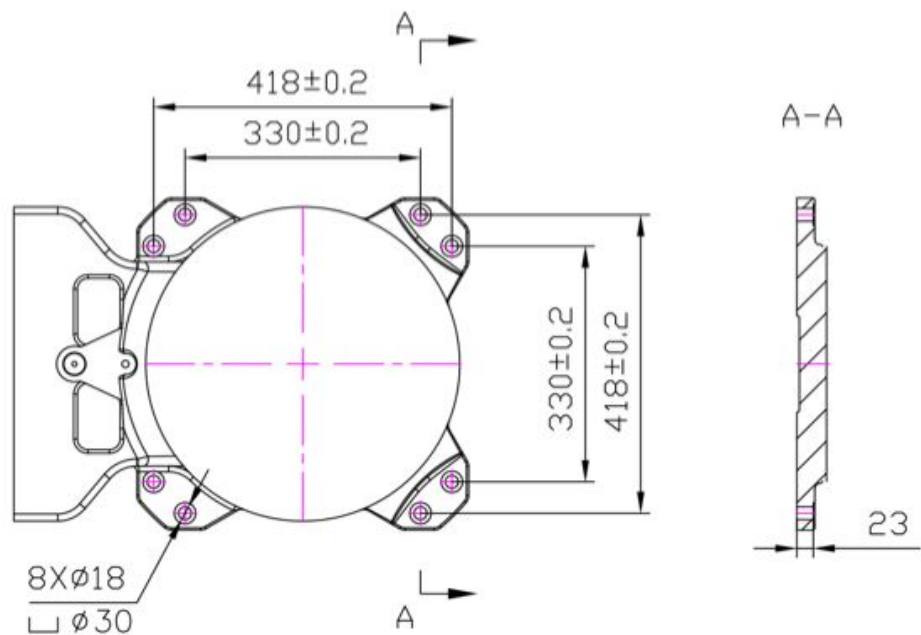

Reminder

To avoid the deformation of the robot base during installation, please control the flatness of the installation panel within 0.2mm. In addition, the screw hole for the ground wire of the base is M4, and the ground wire connection method is shown in 4.3.3.

5.3.5 Mechanical Interface

Mechanical Interface

The robot's wrist, upper arm, lower arm, and waist joints can add extra load. The installation interface is shown in the figure below. To ensure the service life of the thread, do not remove the interface mounting screw frequently. The total load of the wrist and forearm should not exceed 60kg. For example, if the wrist load is 50kg, the extra load on the forearm should be controlled within 10kg.

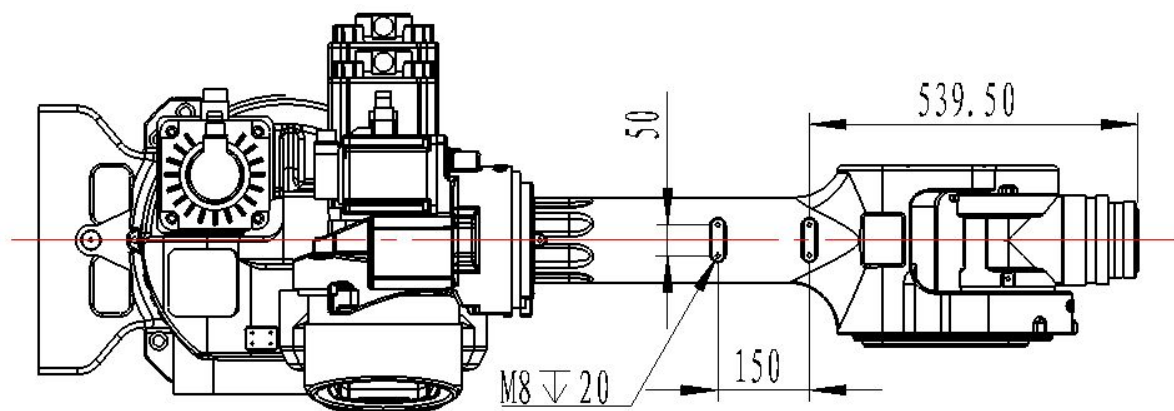

5.4 Electrical connections

 **Chinese Version 中文版:** [CH4_電器連接\(Y系列\)_Source](#)

5.4.1 Wiring connection



Warning

- Do not make mistakes on the connection when connecting the robot to the controller. If the wrong connection is made, not only will the robot system not be able to operate normally, but it may also cause security problems. Please refer to the controller manual for details.
- Only certified technicians or personnel should perform a wiring job. If the wiring job is performed by a person who does not have the relevant knowledge, it may result in injury or malfunction.



Beware of electric shocks

- Be sure to perform replacement work after turning off the controller and related equipment and unplugging the power plug. If you work with the power on, it may cause electrical shock or malfunction.
- Be sure to connect the AC power cable to the power plug. Do not connect directly to the plant power supply. Turn off the power to the robot system by unplugging it. AC power cables are extremely dangerous to operate when connected to factory power and may cause electrical shock and/or robot system failure.
- Be careful not to forcibly bend the cable, etc. to avoid applying the load to the cable. In addition, do not place heavy objects on the cable, forcibly bend or pull the cable. Otherwise, it may cause cable damage, disconnection, or poor contact, resulting in electrical shock or abnormal system operation.
- Before wiring, turn off the power supply of the controller and related devices and put on a warning sign (e.g. never switch on the power). Wiring while energized is extremely dangerous and may cause electrical shock and/or robotic system failure.

5.4.2 Grounding Instructions

The robot needs to be grounded by the user, and the user needs to use the terminal to properly ground the robot according to the actual situation on the site, the spatial location, and other factors.

SYNTEC

Electrical cabinet wiring 220V

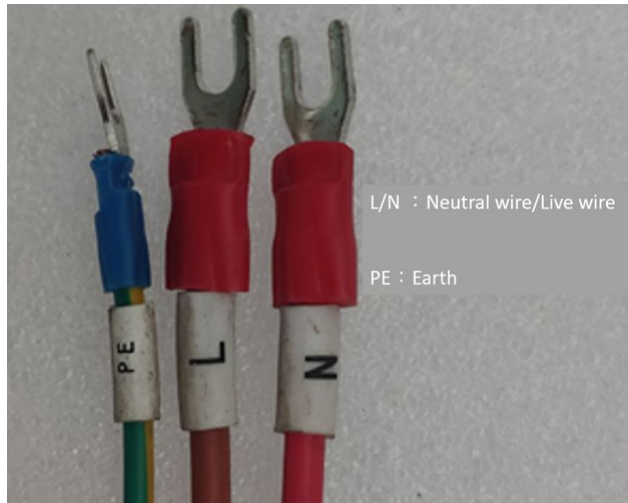

L/N : Neutral wire/Live wire (single-phase 220V) , PE: Earth

5.4.3 User Wiring

Wiring



Warning

Only certified technicians or personnel should perform a wiring job. If the wiring job is performed by a person who does not have the relevant knowledge, it may result in injury or malfunction.



Danger

- The ground terminal must be connected to the ground pole (5.5mm diameter or above is recommended), otherwise, fire and electric shock may occur.
- Before wiring, turn off the power supply of the controller and related devices and pull up the warning sign (e.g., never switch on the power). Wiring while the power is on is extremely dangerous and may cause electric shock and/or malfunction of the robotic system failure.

The IO cable of the robot body corresponds to the position in the control cabinet as shown in the figure:

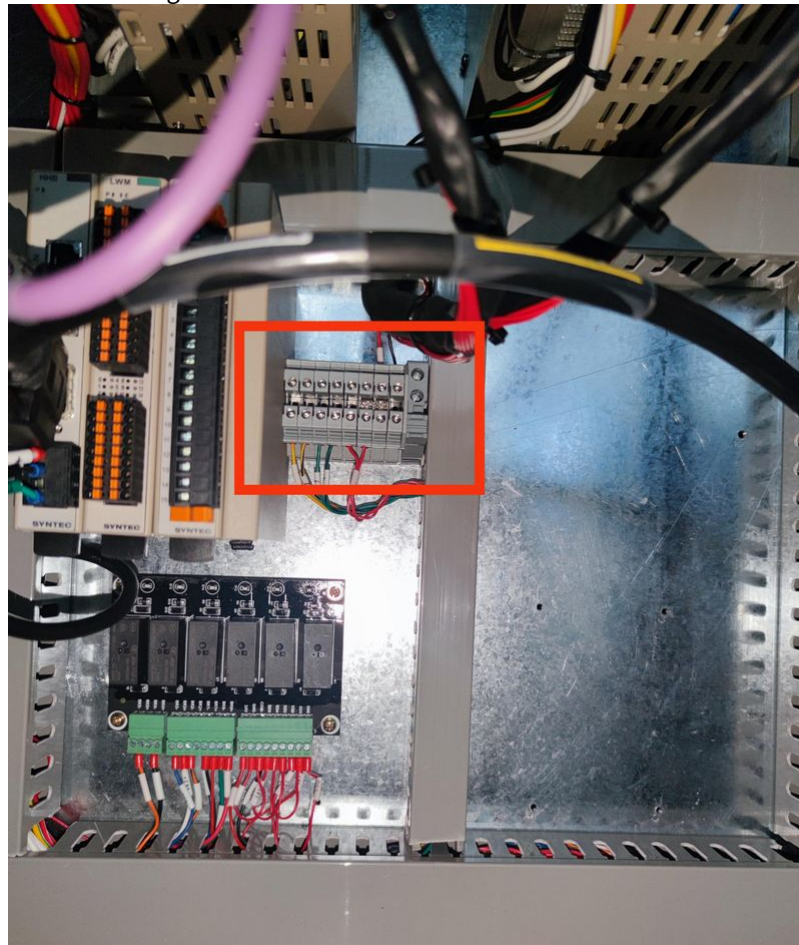

The specifications of the IO cable plug are shown in the table below. Please consult Leantec for further information.

Name	Specification	Diagram
IO cable	6 core	

Notice:

1. The inner wire of the electric box which marked AF+/AF- corresponding to the 5th and 6th wires;
2. The terminal blocks in the electric box have 6 IO lines and one 24v line and one 0v line.

5.4.4 IO Wiring Definition

Unable to render include or excerpt-include. Could not retrieve page.

5.5 Function Test

5.5.1 Check before Power-on

Before powering on, check if the installation environment meets the environmental conditions in chapter 4.1. The items include: Check whether the robot body is firmly fixed, whether the aviation plug of the power cable and the encoder cable is firmly inserted, whether the wiring terminals in the electric cabinet are inserted firmly, and whether the single-phase voltage of the main power cable in the electric cabinet is 220V and the ground wire is connected firmly.

5.5.2 Power-on abnormality check

Power on the electric cabinet after the power-on check. Observe whether there is an abnormal alarm in the teach pendant controller. When the emergency stop is pressed, the teach pendant controller will display the alarm R44.0. If there are other abnormal alarms, please contact Leantec engineers for analysis and solution.

5.5.3 Check the Mastering position, each axis direction, and soft limit of the robot

JOG each joint according to the direction shown in the figure and check whether the direction of each axis is correct. If the graphic direction is opposite to the actual direction, you can adjust the direction of each axis by modifying parameters 0 or 1 of parameters Pr41~Pr46. Check if the zero point position of each axis is consistent with the zero point label. If not, reset the zero point of axes base on the zero point label and check the positive and negative software position limit of each axis.

5.5.4 Test procedure of Automatic Mode

Automatically run a random test program, and listen to the robot to see if there is any abnormal noise. If there is abnormal noise, stop the robot and test each joint motion separately. The normal joint motion is smooth, no stutter, and the sound fluctuation is small. After confirming the abnormal joint, please contact Leantec engineers for assistance. At this point, the robot is checked before use.

6 Maintenance

6.1 5.1 About safety during maintenance

Instruction



Warning

- Please strictly follow the maintenance steps and do not disassemble robot parts.
- Maintenance operations should be performed by designated professionals.
- If not trained, stay away from the robot when the power is switched on. Also, do not enter the working area. Even if the robot appears to have stopped moving, a robot in an energized state may still act accidentally and pose a serious safety problem.
- Be sure to confirm the robot action after the replacement of the component outside the safety fence. Otherwise, the robot before action confirmation may perform unexpected actions and may cause serious safety problems.
- Before entering normal operation, please confirm that the emergency stop switch and safety guard switch operate normally. If the switch cannot be operated normally, it will be unable to perform the safety function in case of an emergency, which may lead to serious injury or significant damage, which is very dangerous.



Beware of electric shock

Maintenance, replacement, and wiring must be carried out after the power supply of the controller and related devices are turned off and the power plug is unplugged. Otherwise, power contactor failure may occur.

Notice during maintenance



Danger

- If you need to perform maintenance procedures other than those specified by LEANTEC, please contact our company.
- If you need to replace parts not specified by LEANTEC, please contact our company.
- Be sure to perform regular maintenance, otherwise, it will affect the life of the robot or cause other unexpected dangers.
- Before performing overhaul and maintenance, please turn off all power supplies.
- Maintenance or overhaul must be carried out by qualified personnel and with a clear understanding of the installation procedures of the entire system and other possible risks.
- When replacing parts, please avoid other foreign material from entering the robot.

6.2 5.2 Troubleshooting

Instruction

When the robot breaks down, please do not continue to operate. You should immediately contact the technician who has received the required training to carry out the failure analysis and determine which part is abnormal.

If you need to replace parts, please contact our company's service department, do not disassemble the robot at will.

6.3 5.3 Maintenance plan

Instruction

In order for the robot to maintain high performance for a long time, it must be maintained regularly. Maintenance personnel shall compile maintenance plans and strictly implement them.

In addition, the overhaul must be carried out every 20,000 hours or within a shorter period of 4 years. If you have any questions, please contact our after-sales service department.

6.3.1 5.3.1 Check interval

Inspection instructions

An accurate overhaul program that is essential to prevent malfunctions . In order to maintain efficient performance over time, regular maintenance must be performed. The inspector must prepare an overhaul plan and execute it strictly.

Maintenance can be divided into the stages and necessary maintenance items for each stage as shown in the table below.

The time between maintenance is calculated based on the time when the servo power is turned on.

The maintenance time in the following table is based on arc welding work, but in case of other applications or special conditions of use, it is necessary to make a separate analysis before making a conclusion. In particular, the maintenance interval should be shortened for high-frequency operations such as handling operations.

The maintenance interval of the robot can be divided into monthly inspection, quarterly inspection, annual inspection, 7680 hours, and 11520 hours. The details are as follows.

The Maintenance Checklist of C-Series LEANTEC Robot(60kg)

No.	Terms	320H(1 month)	960H(3 months)	3840H(1 year)	7680(2 years)	11520H(3 years)

The Maintenance Checklist of C-Series LEANTEC Robot(60kg)						
1	Safety System	<input type="checkbox"/>	<input type="checkbox"/>	<input type="checkbox"/>	<input type="checkbox"/>	<input type="checkbox"/>
2	Teach Pendant Controller	<input type="checkbox"/>	<input type="checkbox"/>	<input type="checkbox"/>	<input type="checkbox"/>	<input type="checkbox"/>
3	Electric Brake	<input type="checkbox"/>	<input type="checkbox"/>	<input type="checkbox"/>	<input type="checkbox"/>	<input type="checkbox"/>
4	Abnormal Noise and Vibration	<input type="checkbox"/>	<input type="checkbox"/>	<input type="checkbox"/>	<input type="checkbox"/>	<input type="checkbox"/>
5	The End-Effector of Robot	<input type="checkbox"/>	<input type="checkbox"/>	<input type="checkbox"/>	<input type="checkbox"/>	<input type="checkbox"/>
6	Oil Leakage Check	<input type="checkbox"/>	<input type="checkbox"/>	<input type="checkbox"/>	<input type="checkbox"/>	<input type="checkbox"/>
7	The Air filter of Electronic Box	<input type="checkbox"/>	<input type="checkbox"/>	<input type="checkbox"/>	<input type="checkbox"/>	<input type="checkbox"/>
8	The Bolts of Base	<input type="checkbox"/>	<input type="checkbox"/>	<input type="checkbox"/>	<input type="checkbox"/>	<input type="checkbox"/>
9	External Electric Cable		<input type="checkbox"/>	<input type="checkbox"/>	<input type="checkbox"/>	<input type="checkbox"/>
10	Whether the Bonding State of Connectors is Fine		<input type="checkbox"/>	<input type="checkbox"/>	<input type="checkbox"/>	<input type="checkbox"/>
11	Surface Cleaning of the Robot Body		<input type="checkbox"/>	<input type="checkbox"/>	<input type="checkbox"/>	<input type="checkbox"/>
12	Cooling Fan		<input type="checkbox"/>	<input type="checkbox"/>	<input type="checkbox"/>	<input type="checkbox"/>
13	Check the Cable inside the Mechanism(movable part)			<input type="checkbox"/>	<input type="checkbox"/>	<input type="checkbox"/>
14	The Bolts of Connecting the Axes of Motor and Other Exposed Bolts			<input type="checkbox"/>	<input type="checkbox"/>	<input type="checkbox"/>
15	Replace the Battery in the Machine			<input type="checkbox"/>	<input type="checkbox"/>	<input type="checkbox"/>

The Maintenance Checklist of C-Series LEANTEC Robot(60kg)

16	Replace the Oil of reducer					o	o
17	Check the Conducting Wire in the Machine						o

Maintenace Cycle	Inspection and Maintenance Content	Inspection Content	Safety Measure
320H(1 mouth)	1. Safety System	Check that the emergency stop on the teach pendant and robot controller work properly.	Please don't use it and contact technical personnel right away if something is acting strangely.
	2. Teach Pendant Controller	Check the cable connected to the teach pendant for excessive twisting or damaging and check the external surface of teach pendant controller for dirt .	Please keep the teach pendant controller clean and periodically clean it up. Do not twist the cable excessively. If the cable connected to the teach pendant is damaged, please contact our company.
	3. The Function of Motor Brake	Listen to the sound of each motor when releasing the brake.	Contact technical personnel right away if the brake release without listening "Click"











Maintenance Cycle	Inspection and Maintenance Content	Inspection Content	Safety Measure
	4. Abnormal Noise and Vibration	Observe the status when operating.	Please stop the robot and contact technical staff immediately when abnormal noise and vibration occur.
	5. End-Effector	Confirm the end effector operate normally and check the screw terminals for proper connection.	If the screw terminals are not proper connection, please tighten the screws. Please fix the end effector immediately after damaging.
	6.Oil Leakage Check	Check the installation surface of each motor.	When oil starts to leak a little, please wipe it off. When there is significant oil leakage, please stop the robot and call our business.
	7. Air Filter of Electronic box	Check the air filter of electronic box for dust.	Please keep the air filter of electronic box clean. Please replace the electronic box air filter if it become dirty or be damaged.
960H(3 months)	1. Bolt of the Robot Base	Check the bolt for proper connection.	If the bolt are not proper connection, please tighten the screws.

Maintenance Cycle	Inspection and Maintenance Content	Inspection Content	Safety Measure
	2. External Cable	Check the electric cable and heavy duty connectors.	If an electric cable is damaged, please replace it right away.
	3. Connection Plug	Aviation plug behind the robot base, aviation plug for the motor, and IO connector.	If a plug is not proper connection, please tighten the plug.
	4. Cleaning of Robot Arm	Check the robot arm for dirt, debris, and oil paint adhering to its surface.	Please clean up the surface of the robot arm immediately to prevent the accumulation of debris. Wipe the dirt and oils adhering to the surface of the robot.
	5. Cooling Fan	Check that the fan is rotating normally and make sure it is clean.	If the fan is rotating abnormally, please replace it immediately. Keep the fan clean.
	6. Please refer to monthly maintenance		
3840H(1 year)	1. Check the Electric Cables in the Mechanism(movable part)	Check whether the exposed cable on the joints of the robot body have folded cracks, distortions, or scratches	Please replace it in time if it damages.

Maintenace Cycle	Inspection and Maintenance Content	Inspection Content	Safety Measure
	2. The Bolts of Connecting the Axes of Motor and Other Exposed Bolts	Check the bolts on the on the joints ' motor or reducer loosens or not.	Please fasten it immediately if it loosens.
	3. Replace the Battery in the Machine	Please changing the battery annually.	Please contact Leantec engineers for the technical support.
	4. Please refer to the Quarterly Maintenance		
7680H(2 years)	1. Replace Reducer Oil	Can extend the lifetime of the robot.	Please contact Leantec engineers for the technical support.
	2. Please refer to the Annual Maintenance		
11520(3 years)	1. Check the Electric Cables in the Machine	Check the conduction performance and wear condition of the wires and the terminals	Please replace it if the conduction performance or wear wondition is poor.
	2. Please refer to the Two-Year Maintenance		

Repair and Maintenance Tools Instructions

Instructions:

工具名称	用途	图片
Grease Gun	Tools for filling lubricating oil	
Grease Fitting (AxisC1-C3轴: M10 Screw pitch is 1mm, Length 10mm) (AxisC4-C6轴: M8 Screw pitch is 1mm, Length 10mm)	Tools for filling lubricating oil	
Special Reducer Grease	Brands of Reducer Grease.	
Screw Thread Sealant	Some screws need to be re-tightened after disassembly by adding thread sealant.	
6 Encoder Batteries or one Battery Plate	To replace the encoder battery. Note: The old battery pack and the new battery plate cannot be mixed, please make sure it before replacement.	
Hexagonal Set	Tool for Screw removal.	
U-shaped Hydraulic Clamp	To replace the encoder battery.	
Wire Stripper	To replace the encoder battery.	
Voltmeter	For voltage detection	
Wrench	For disassembling and assembling the grease fitting	



5.3.2 Tightening of hexagon socket screws

Tighten instructions

Use hexagon socket head screws (hereinafter referred to as screws, class 12.9) where connection strength is required. When assembling, tighten the screws according to the fastening torque shown in the following table. Unless specified, when refastening these screws in the operations described in this manual, use a torque wrench to tighten the screws by the tightening torque values shown in the table below.

S/N	Hex cylinder head screw	Torque (N·m)
1	M2	0.5
2	M3	2
3	M4	4
4	M5	9
5	M6	15
6	M8	35
7	M10	70
8	M12	125

Please refer to the following table for the torque of the set screw used in belt pulley installation:

S/N	Hex cylinder head screw	Torque (N·m)
1	M4	2
2	M5	3.9

It is recommended to fasten the screws on the circumference in diagonal order as shown in the figure below. Use a hexagon wrench to loosely tighten it 2~3 times and then use a torque wrench to tighten it according to the tightening torque value as shown in the table above.

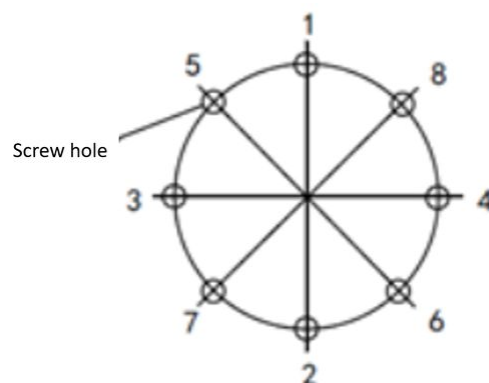





6.3.2 Replace Battery

The batteries of the robot are used to record the encoder data of each axis, hence the batteries are required to replace every 1000 hours. Users should replace the batteries when the battery low voltage alarm appears. The mastering position of the robot will be lost if the user does not replace the battery in time.

Procedures for battery replacement:

- Adjust the robot to mastering position, then press the emergency stop button and power off.
- Open battery installation cover and take out the old battery module. (Recommend to use the OEM battery module).
- Replace it with the new battery module and ensure the batteries are plugged in.
- Tighten the screw of the battery installation cover.
- Power on the robot, perform mastering, and release the emergency stop state.

Steps	Old Battery Module	New Battery Module
1		
2		
Part No.	R01-LJ-BATT-01	K01-BAT-C-V1.3

 The part number is the temporary part number of Suzhou

6.3.3 Replace Lubricant Oil



The robot is required to replace the lubricant oil of the RV reducer and gearbox every 6000 hours. It is recommended to use the international standard lubricant oil model: MOLYWHITE RE No.00;

The joints of the robotic arm that used RV reducer are required to replace lubricant oil regularly. Generally, 20kg maximum payload has RV reducers

Designated standard lubricant picture	Lubricant Syringe picture
	

Procedure for Replacing Lubricant Oil:

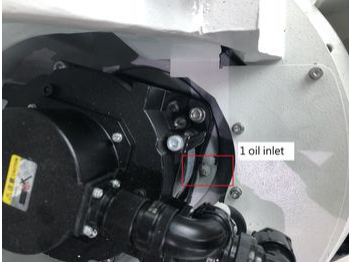
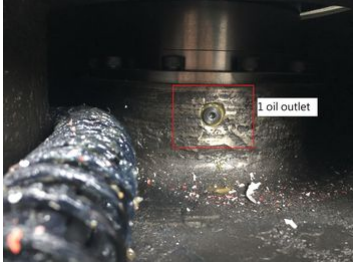
- Power off the robot.
- Take off the stopper of the oil inlet and outlet of the corresponding joint.
- Inject the lubricant oil from the oil inlet by using an oil injector until the new lubricant oil flows out of the oil outlet. Then insert the stoppers for the oil inlet and outlet.
- Move the axis that got lubricant oil replacement for a while until the redundant oil flows out.

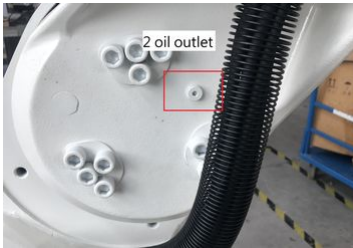
<p>Location of oil outlet and inlet of 1st-axis:</p>		
<p>Location of oil outlet and inlet of 2nd-axis:</p>		

Location of oil outlet and inlet of 3rd-axis:

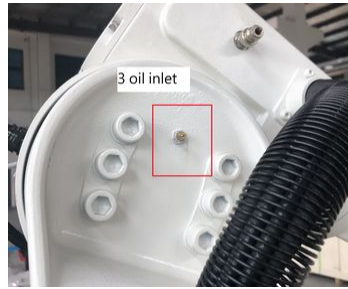

SYNTEC

7 Zero Point

7.1 About mechanical home

What is a mechanical home

The robot is designed with an initial orientation defined in advance, under which the angle of each joint is 0. From a mechanical point of view, the zero position refers to the orientation when a particular angle is formed between adjacent links. From the perspective of software angular, since the robot uses an encoder to record joint angles, the zero position refers to the robot's orientation when the servo motor rotates to a specific encoder value.

So mechanical home can actually be interpreted in two ways. From the perspective of the observer, the mechanical home is the robot orientation corresponding to the movement of each joint of the robot to a specific position. From the point of view of the control system, the mechanical zero is the value of several encoders. Zero is the reference point of the robot coordinate system. Without zero, the robot cannot judge its own position. Therefore, in order to obtain the highest absolute positioning accuracy, the robot must be mastered to make the mechanical home and theoretical home as close as possible.

Under what circumstances should the mechanical home be calibrated

In general, it is necessary to remaster under the following circumstances:

- After the replacement of the motor, synchronous belt, reducer, and other mechanical system parts.
- After a violent collision with a workpiece or environment.
- Manually move robot joints without control of the controller.
- Reinstall the entire system.
- Encoder battery after discharge.

7.2 Zero point calibration

Instruction

The purpose of mastering is to make the theoretical zero of the control algorithm coincide with the actual mechanical home so that the mechanical connecting rod system can correctly respond to the position and speed instructions of the control system.

More generally speaking, mastering is a process in which each joint of the robot is rotated to a specific angle by using some pre-designed positioning devices on the mechanical body, and the control system is informed to record the numerical values of the motor encoder of each joint at this time.

All joints of the LA2100-60-60-C series robots are calibrated with the home label, one axis at a time, or six axes at the same time. When calibrating, slowly rotate the corresponding joint to align with the home label arrow, and the position at this time is the zero position of the axis.

For the six-axis, the zero point is calibrated as shown in the figure below when leaving the factory:

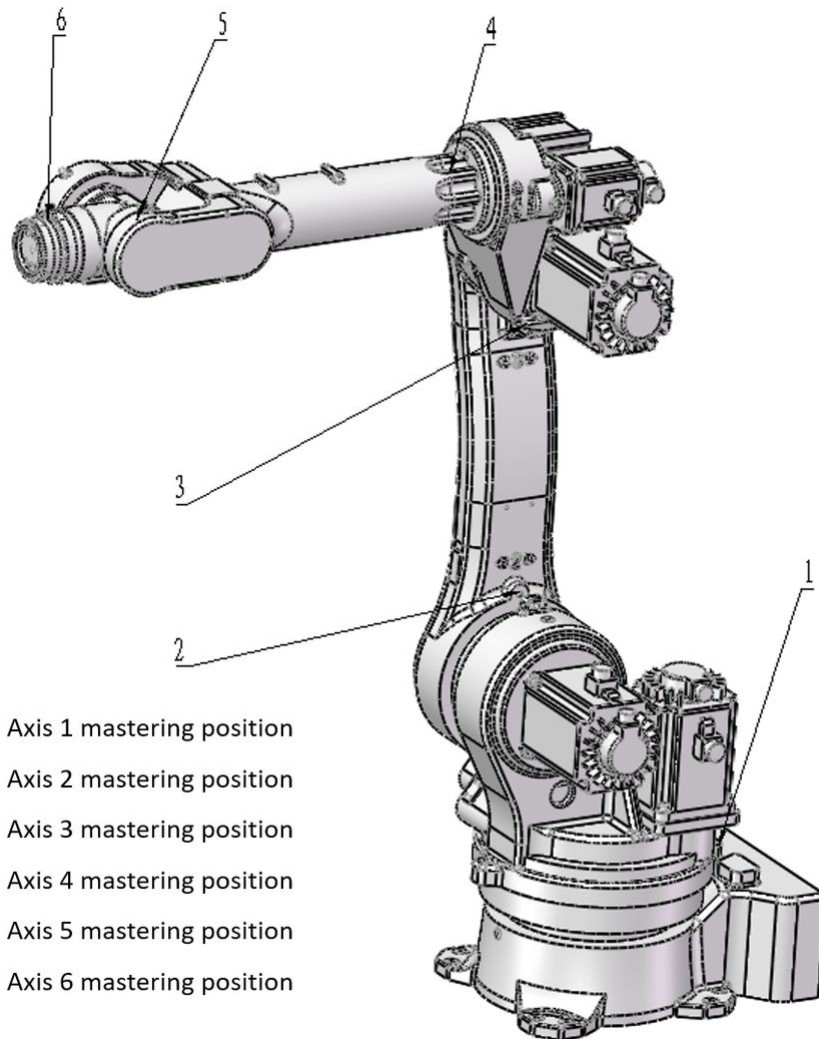

1. Axis 1 mastering position
2. Axis 2 mastering position
3. Axis 3 mastering position
4. Axis 4 mastering position
5. Axis 5 mastering position
6. Axis 6 mastering position

7.3 Calibration steps

Calibration steps

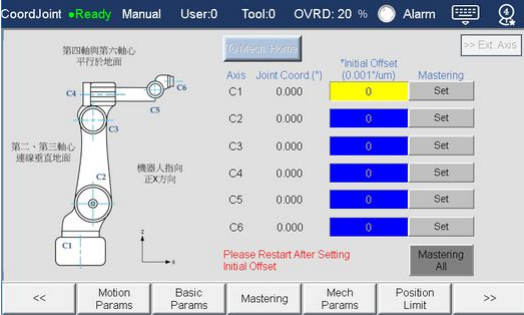

	Operate	Description
1	Log in to the system with users above the Expert level and enter the zero-point calibration interface.	<p>Zero calibration can only be done in manual mode with no program running.</p> <p>The zero calibration interface is located in the "calibration" classification.</p> 
2	In joint coordinate jog mode, please calibrate the robot starting from axis 1.	Different robots have different mastering calibration tool. Please refer to the manual for the corresponding robot.
3	When the corresponding axis moves to the zero position, click the "calibration" button of the corresponding joint on the HMI to complete the calibration of the joint, and then move on to the next joint.	It is recommended to wait for the calibration of the previous joint to be completed before calibrating the "calibration" button of the next joint.
4	Repeat step 3 until all joints of the robot have been calibrated.	

Read more

For more information about the use, programming, and parameter setting of robots, teaching aids and control cabinets, please refer to the Operation Manual of Syntec Robot Control System.

Address: Leantec Intelligence, Xindai Science park, No. 9, Chunhui Road, Suzhou Industrial Park

Leantec Intelligence: <https://www.leantec.com.cn>

