

TOSHIBA

Industrial Inverter (For 3-phase induction motors)

Instruction Manual

TOSVERT VF-nC3

<Detailed manual>

1-phase 120V class	0.1 to 0.75kW
1-phase 240V class	0.1 to 2.2kW
3-phase 240V class	0.1 to 4kW

TOSHIBA INDUSTRIAL PRODUCTS AND SYSTEMS CORPORATION

NOTICE

1. Make sure that this instruction manual is delivered to the end user of the inverter unit.
2. Read this manual before installing or operating the inverter unit, and store it in a safe place for reference.



E6581595④

Safety precautions	I
Introduction	II
Contents	
Read first	1
Connection	2
Operations	3
Setting parameters	4
Main parameters	5
Other parameters	6
Operation with external signal	7
Monitoring inverter status in operation / before tripping	8
Measures to satisfy the standards	9
Peripheral devices	10
Table of parameters and data	11
Specifications	12
Before Contacting your Toshiba distributor	13
Inspection and maintenance	14
Warranty	15
Disposal of the inverter	16
Appendix	17

I. Safety precautions

The items described in these instructions and on the inverter itself are very important so that you can use the inverter safely, prevent injury to yourself and other people around you as well as to prevent damage to property in the area. Thoroughly familiarize yourself with the symbols and indications shown below and then continue to read the manual. Make sure that you observe all warnings given.



Explanation of markings

Marking	Meaning of marking
 Warning	Indicates that errors in operation will lead to death or serious injury.
 Caution	Indicates that errors in operation will lead to injury (*1) to people or that these errors will cause damage to physical property. (*2)

(*1) Such things as injury, burns or shock that will not require hospitalization or long periods of outpatient treatment.

(*2) Physical property damage refers to wide-ranging damage to assets and materials.

Meanings of symbols

Marking	Meaning of marking
	Indicates prohibition (Don't do it). What is prohibited will be described in or near the symbol in either text or picture form.
	Indicates an instruction that must be followed. Detailed instructions are described in illustrations and text in or near the symbol.
	-Indicates warning. What is warned will be described in or near the symbol in either text or picture form. -Indicates caution. What the caution should be applied to will be described in or near the symbol in either text or picture form.





■ Safety precautions (Limits in purpose)



Our inverters are designed to control the speeds of three-phase induction motors for general industry.
Single-phase power input is output by the inverter as three-phase output and cannot drive a single-phase motor.

Safety precautions



- ▼ This product is an electronic component for general industrial uses in industrial application.
It cannot be used for applications where may cause a significant public impact, such as power stations and railways, and for uses that will require special quality control or warranty.
Neither is it applicable to equipment (for nuclear power, airplanes, aerospace, public transport, life support, surgeries and various safety and entertainment devices) to which the failure or malfunction of this product could pose a direct risk or threat to human life.
If you wish to use the product for limited purposes and the product is understood to require no special quality control or warranty, please contact us before purchase to evaluate if the usage is applicable.
- ▼ Please ensure in advance that the product is appropriately placed and installed in your own device or system, fulfilling the intended purpose. The equipment designer or the customers who assembles the final product shall be held liable for the selection and application of the product. We are not responsible for how the product is incorporated into the final system design.
When using the product, please systematically back up your data or safety devices so that any failure or malfunction of the product will not cause any significant accidents.
- ▼ Even if the product is found to be inapplicable for conditions above after purchasing or using the product, the product will remain inapplicable for such conditions.
- ▼ Do not use the product for any load other than with general industry three-phase induction motors.
Single-phase power input is output by the inverter as three-phase output and cannot drive a single-phase motor.
- ▼ Please read the instruction manual carefully before installing or operating the product and use it properly.



■ Handling



 Warning		Reference section
 Disassembly prohibited	<ul style="list-style-type: none"> • Never disassemble, modify or repair. This can result in electric shock, fire and injury. Contact your Toshiba distributor for repairs. 	2.
 Prohibited	<ul style="list-style-type: none"> • Never remove the terminal block cover when power is on. The unit contains many high voltage parts and contact with them will result in electric shock. • Do not stick your fingers into openings such as cable wiring holes and cooling fan covers. This can result in electric shock or other injury. • Do not place or insert any kind of object (electrical wire cuttings, rods, wires etc.) into the inverter. This can result in electric shock or fire. • Do not allow water or any other fluid to come in contact with the inverter. This can result in electric shock or fire. 	2.1 2. 2. 2.
 Mandatory action	<ul style="list-style-type: none"> • Turn the power on only after attaching the terminal block cover. If the power is turned on without the terminal block cover attached, this can result in electric shock or other injury. • If the inverter begins to emit smoke or an unusual odor, or unusual sounds, immediately turn the power off. Continuous use of the inverter in such a state will cause fire. Contact your Toshiba distributor for repairs. • Always turn the power off if the inverter is not used for long periods of time since there is a possibility of malfunction caused by leaks, dust and other material. If power is left on with the inverter in that state, it can result in fire. 	2.1 3. 3.

 Caution		Reference section
 Contact prohibited	<ul style="list-style-type: none"> Do not touch heat radiating fins or discharge resistors. These devices are hot, and you'll get burned if you touch them. 	3.
 Mandatory action	<ul style="list-style-type: none"> Use an inverter that conforms to the specifications of power supply and three-phase induction motor being used. If the inverter being used does not conform to those specifications, not only will the three-phase induction motor not rotate correctly, but it can also cause serious accidents through overheating and fire. 	1.1 1.4.1



■ Transportation & installation



 Warning		Reference section
 Prohibited	<ul style="list-style-type: none"> Do not install or operate the inverter if it is damaged or any component is missing. This can result in electric shock or fire. Contact your Toshiba distributor for repairs. Do not place any inflammable objects near the inverter. If an accident occurs in which flame is emitted, this could lead to fire. Do not install in any location where the inverter could come into contact with water or other fluids. <i>This can result in electric shock or fire.</i> 	1.4.4 1.4.4 1.4.4
 Mandatory action	<ul style="list-style-type: none"> Operate under the environmental conditions prescribed in the instruction manual. Operations under any other conditions can result in malfunction. Mount the inverter on a metal plate. The rear panel gets very hot. Do not install in an inflammable object, this can result in fire. Do not operate with the terminal block cover removed. This can result in electric shock. Failure to do so can lead to risk of electric shock and can result in death or serious injury. An emergency stop device must be installed that fits with system specifications (e.g. shut off input power then engage mechanical brake). Operation cannot be stopped immediately by the inverter alone, thus resulting in an accident or injury. All options used must be those specified by Toshiba. The use of any other option will result in an accident. When using switchgear for the inverter, it must be installed in a cabinet. Failure to do so can lead to risk of electric shock. 	1.4.4 1.4.4 1.4.4 1.4.4 1.4.4 10



 Caution		Reference section
 Prohibited	<ul style="list-style-type: none"> When transporting or carrying, do not hold by the front panel covers. The covers will come off and the unit will drop, resulting in injury. Do not install in any area where the unit would be subject to large amounts of vibration. This could cause the unit to fall, resulting in bodily injury. 	2. 1.4.4

 Caution		Reference section
 Mandatory action	<ul style="list-style-type: none"> When removing and installing the terminal cover with a screwdriver, be sure not to scratch your hand as these results in injury. Pressing too hard on the screwdriver can scratch the inverter. Always turn the power off when removing the wiring cover. After wiring is complete, be sure to replace the terminal cover. The main unit must be installed on a base that can bear the unit's weight. If the unit is installed on a base that cannot withstand that weight, the unit can fall, resulting in injury. If braking is necessary (to hold motor shaft), install a mechanical brake. The brake on the inverter will not function as a mechanical hold, and if used for that purpose, injury will result. 	1.3.2 1.3.2 1.3.2 1.4.4 1.4.4



■ Wiring



 Warning		Reference section
 Prohibited	<ul style="list-style-type: none"> Do not connect input power to the output (motor side) terminals (U/T1, V/T2, W/T3). Connecting input power to the output could destroy the inverter or cause a fire. Do not insert a braking resistor between DC terminals (between PA/+ and PC/- or PO and PC/-). It could cause a fire. First shut off input power and wait at least 15 minutes before touching terminals and wires on equipment (MCCB) that is connected to inverter power side. Touching the terminals and wires before that time could result in electric shock. Do not shut down the external power supply on ahead when VIA terminal is used as logic input terminal by external power supply ($F i 2 ? = 2 0 0$). It could cause unexpected result as VIA terminal is ON status. When supplying power from a wall socket, do not exceed the rated capacity of the socket. Otherwise, this may generate excessive heat which can start a fire. 	2.2 2.2 2.2 2.2 6.3.1 10.
 Mandatory action	<ul style="list-style-type: none"> Electrical construction work must be done by a qualified expert. Connection of input power by someone who does not have that expert knowledge can result in fire or electric shock. Connect output terminals (motor side) correctly. If the phase sequence is incorrect, the motor will operate in reverse and that can result in injury. Wiring must be done after installation. If wiring is done prior to installation, that can result in injury or electric shock. The following steps must be performed before wiring. <ol style="list-style-type: none"> Turn off all input power. Wait at least 15 minutes and check to make sure that the charge lamp is no longer lit. Use a tester that can measure DC voltage (400VDC or more), and check to make sure that the voltage to the DC main circuits (across PA/+ - PC/-) is 45V or less. If these steps are not properly performed, the wiring will cause electric shock. Tighten the screws on the terminal block to specified torque. If the screws are not tightened to the specified torque, it can lead to fire. Check to make sure that the input power voltage is +10%, -15% of the rated power voltage ($\pm 10\%$ when the load is 100% in continuous operation) written on the name plate. If the input power voltage is not +10%, -15% of the rated power voltage ($\pm 10\%$ when the load is 100% in continuous operation), this can result in fire. Set a parameter $F i 0 0$ when VI terminals are used as logic input terminal. If it is not set, it could result in malfunction. 	2.1 2.1 2.1 2.1 2.1 1.4.4 2.2



 Warning		Reference section
 Be Grounded	<ul style="list-style-type: none"> • Ground must be connected securely. If the ground is not securely connected, it could lead to electric shock or fire. 	2.1 2.2 10.

 Caution		Reference section
 Prohibited	<ul style="list-style-type: none"> • Do not attach devices with built-in capacitors (such as noise filters or surge absorbers) to the output (motor side) terminals. This could cause a fire. 	2.1



■ Operations

 Warning		Reference section
 Prohibited	<ul style="list-style-type: none"> • Never touch the internal terminals in the upper right while the front cover is open. There is a risk of electrical shock because it carries a high voltage. • Do not touch inverter terminals when electrical power is going to the inverter even if the motor is stopped. Touching the inverter terminals while power is connected to it will result in electric shock. • Do not touch switches when the hands are wet and do not try to clean the inverter with a damp cloth. Such practices will result in electric shock. • Do not go near the motor in alarm-stop status when the retry function is selected. The motor will suddenly restart and that could result in injury. Take measures for safety, e.g. attaching a cover to the motor, against accidents when the motor unexpectedly restarts. 	1.3.1 3. 3. 6.12.3
 Mandatory action	<ul style="list-style-type: none"> • Turn the input power on only after attaching the terminal block cover. When enclosed inside a cabinet and used with the terminal block cover removed, always close the cabinet doors first and then turn the power on. If the power is turned on with the terminal block cover or cabinet doors open can result in electric shock. • Make sure that operation signals are off before resetting the inverter after malfunction. If the inverter is reset before turning off the operating signal, the motor can restart suddenly, resulting in injury. • If incorrect setting, the drive will have some damage or unexpected movement. Be sure to set the setup menu correctly. 	3. 3. 3.1



 Caution		Reference section
 Prohibited	<ul style="list-style-type: none"> • Observe all permissible operating ranges of motors and mechanical equipment. (Refer to the motor's instruction manual.) Not observing these ranges will result in injury. • Do not set the stall prevention level ($F_{\text{SD}} \%$) extremely low. If the stall prevention level parameter ($F_{\text{SD}} \%$) is set at or below the no-load current of the motor, the stall preventive function will be always active and increase the frequency when it judges that regenerative braking is taking place. Do not set the stall prevention level parameter ($F_{\text{SD}} \%$) below 30% under normal use conditions. 	3. 6.16.2

 Caution		Reference section
 Mandatory action	<ul style="list-style-type: none"> Use an inverter that conforms to the specifications of power supply and three-phase induction motor being operated. If the inverter being used does not conform to those specifications, not only will the three-phase induction motor not rotate correctly, but it will cause serious accidents through overheating and fire. 	1.4.1
	<ul style="list-style-type: none"> The leakage current through the input/output power cables of inverter and capacitance of motor can affect to peripheral devices. The value of leakage current is increased under the condition of the PWM carrier frequency and the length of the input/output power cables. In case the total cable length (total of length between an inverter and motors) is more than 100m, overcurrent trip can occur even the motor no-load current. Make enough space among each phase cable as countermeasure. 	1.4.3



■ When operation by using remote keypad is selected

 Warning		Reference section
 Mandatory action	<ul style="list-style-type: none"> Set the parameter Communication time-out time (<i>F B Q 3</i>) and Communication time-out action (<i>F B Q 4</i>). If these are not properly set, the inverter can not be stopped immediately in breaking communication and this could result in injury and accidents. 	6.19
	<ul style="list-style-type: none"> An emergency stop device and the interlock that fit with system specifications must be installed. If these are not properly installed, the inverter can not be stopped immediately and this could result in injury and accidents. 	



■ When sequence for restart after a momentary failure is selected (inverter)

 Caution		Reference section
 Mandatory action	<ul style="list-style-type: none"> Stand clear of motors and mechanical equipment. If the motor stops due to a momentary power failure, the equipment will start suddenly after power is restored. This could result in unexpected injury. 	6.12.1
	<ul style="list-style-type: none"> Attach caution label about sudden restart after a momentary power failure on inverters, motors and equipment for prevention of accidents in advance. 	6.12.1



■ When retry function is selected (inverter)

 Caution		Reference section
 Mandatory action	<ul style="list-style-type: none"> Stand clear of motors and equipment. If the motor and equipment stop when the alarm is given, selection of the retry function will restart them suddenly after the specified time has elapsed. This could result in unexpected injury. 	6.12.3
	<ul style="list-style-type: none"> Attach caution label about sudden restart in retry function on inverters, motors and equipment for prevention of accidents in advance. 	6.12.3

■ Maintenance and inspection

 Warning		Reference section
 Prohibited	<ul style="list-style-type: none"> Do not replace parts. This could be a cause of electric shock, fire and bodily injury. To replace parts, contact your Toshiba distributor. 	14.2
 Mandatory action	<ul style="list-style-type: none"> The equipment must be inspected daily. If the equipment is not inspected and maintained, errors and malfunctions can not be discovered and that could result in accidents. Before inspection, perform the following steps. <ol style="list-style-type: none"> Turn off all input power to the inverter. Wait at least 15 minutes and check to make sure that the charge lamp is no longer lit. Use a tester that can measure DC voltages (400V or more), and check that the voltage to the DC main circuits (across PA/+ - PC/-) is 45V or less. Performing an inspection without carrying out these steps first could lead to electric shock. 	14. 14. 14.2

■ Disposal

 Caution		Reference section
 Mandatory action	<ul style="list-style-type: none"> If you dispose of the inverter, have it done by a specialist in industry waste disposal (*). If you dispose of the inverter by yourself, this can result in explosion of capacitor or produce noxious gases, resulting in injury. (*) Persons who specialize in the processing of waste and known as "industrial waste product collectors and transporters" or "industrial waste disposal persons". Please observe any applicable law, regulation, rule or ordinance for industrial waste disposal. 	16.

■ Attach caution labels

Shown here are examples of caution labels to prevent, in advance, accidents in relation to inverters, motors and other equipment. Be sure to affix the caution label where it is easily visible when selecting the auto-restart function (Refer to section 6.12.1) or the retry function (Refer to section 6.12.3).

If the inverter has been programmed for restart sequence of momentary power failure, place warning labels in a place where they can be easily seen and read.
(Example of caution label)

	Caution (Functions programmed for restart)
Do not go near motors and equipment. Motors and equipment that have stopped temporarily after momentary power failure will restart suddenly after recovery.	

If the retry function has been selected, place warning labels in a location where they can be easily seen and read.
(Example of caution label)

	Caution (Functions programmed for retry)
Do not go near motors and equipment. Motors and equipment that have stopped temporarily after an alarm will restart suddenly after the specified time has elapsed.	

II. Introduction

Thank you for your purchase of the Toshiba "TOSVERT VF-nC3" industrial inverter.

This instruction manual is for the Ver. 122 or later CPU of the inverter.
Please be informed that CPU version will be frequently upgraded.

— Contents —

I	Safety precautions	1
II	Introduction	8
1.	Read first	A-1
1.1	Check product purchase	A-1
1.2	Contents of the product	A-2
1.3	Names and functions	A-3
1.4	Notes on the application	A-12
2.	Connection	B-1
2.1	Cautions on wiring	B-1
2.2	Standard connections	B-3
2.3	Description of terminals	B-6
3.	Operations	C-1
3.1	How to Set the Setup Menu	C-2
3.2	Simplified Operation of the VF-nC3	C-4
3.3	How to operate the VF-nC3	C-9
3.4	Meter setting and adjustment	C-13
3.5	Setting the electronic thermal	C-16
3.6	Preset-speed operation (speeds in 15 steps)	C-21
4.	Setting parameters	D-1
4.1	Setting and Display Modes	D-1
4.2	How to set parameters	D-3
4.3	Functions useful in searching for a parameter or changing a parameter setting	D-7
4.4	Checking the region settings selection	D-12
4.5	EASY key function	D-13
5.	Main parameters	E-1
5.1	Searching for changes using the history function	E-1
5.2	Setting a parameter using the guidance function	E-2
5.3	Setting acceleration/deceleration time	E-5
5.4	Increasing starting torque	E-7
5.5	Selection of operation mode	E-10
5.6	Meter setting and adjustment	E-13
5.7	Forward/reverse run selection (Panel keypad)	E-13
5.8	Maximum frequency	E-14
5.9	Upper limit and lower limit frequencies	E-15
5.10	Base frequency	E-16

5.11	Selecting control mode.....	E-17
5.12	Manual torque boost - increasing torque boost at low speeds	E-21
5.13	Setting the electronic thermal	E-22
5.14	Preset-speed operation (speeds in 15 steps).....	E-22
5.15	Standard default setting	E-22
5.16	Checking the region setting selection	E-22
5.17	EASY key mode selection	E-22
6.	Other parameters	F-1
6.1	Input/output parameters	F-1
6.2	Input signal selection.....	F-4
6.3	Terminal function selection.....	F-7
6.4	Basic parameters 2	F-9
6.5	Setting frequency command	F-11
6.6	Operation frequency.....	F-18
6.7	DC braking.....	F-19
6.8	Time limit for lower-limit frequency operation	F-20
6.9	Jump frequency - Avoiding frequency resonance.....	F-21
6.10	Preset-speed frequencies	F-21
6.11	PWM carrier frequency	F-22
6.12	Trip-less intensification.....	F-24
6.13	PID control	F-32
6.14	Setting motor constants.....	F-37
6.15	2nd acceleration/deceleration	F-40
6.16	Protection functions.....	F-43
6.17	Adjustment parameters	F-53
6.18	Operation panel parameter	F-55
6.19	Communication function (RS485)	F-62
6.20	Free notes	F-68
7.	Operations with external signal	G-1
7.1	Operating external signals	G-1
7.2	Applied operations by an I/O signal (operation from the terminal block)	G-2
7.3	Speed instruction (analog signal) settings from external devices	G-10
8.	Monitoring the inverter status in operation / before tripping	H-1
8.1	Flow of status monitor mode	H-1
8.2	Status monitor mode	H-2
8.3	Display of trip information.....	H-6
9.	Measures to satisfy the standards.....	I-1
9.1	How to cope with the CE directive.....	I-1
9.2	Compliance with UL Standard and CSA Standard.....	I-5

10. Peripheral devices	J-1
10.1 Selection of wiring materials and devices	J-1
10.2 Installation of a magnetic contactor	J-3
10.3 Installation of an overload relay	J-4
10.4 Optional external devices	J-5
11. Table of parameters and data	K-1
11.1 User parameters	K-1
11.2 Basic parameters	K-1
11.3 Extended parameters	K-4
11.4 Default settings by inverter rating	K-15
11.5 Default settings by setup menu	K-15
11.6 Input Terminal Function	K-16
11.7 Output Terminal Function	K-19
11.8 Unchangeable parameters in running	K-21
12. Specifications	L-1
12.1 Models and their standard specifications	L-1
12.2 Outside dimensions and mass	L-4
13. Before Contacting your Toshiba distributor - Trip information and remedies	M-1
13.1 Trip causes/warnings and remedies	M-1
13.2 Restoring the inverter from a trip	M-6
13.3 If the motor does not run while no trip message is displayed	M-7
13.4 How to determine the causes of other problems	M-8
14. Inspection and maintenance	N-1
14.1 Regular inspection	N-1
14.2 Periodical inspection	N-2
14.3 Contacting with your Toshiba distributor	N-4
14.4 Keeping the inverter in storage	N-4
15. Warranty	O-1
16. Disposal of the inverter	P-1
17. Appendix	Q-1
한국 KC 마크	Q-1
VF-nC3 motor control parameter default setting update information	R-1

1. Read first

1.1 Check product purchase

Before using the product you have purchased, check to make sure that it is exactly what you ordered.

Caution

Mandatory
action

Use an inverter that conforms to the specifications of power supply and three-phase induction motor being used. If the inverter being used does not conform to those specifications, not only will the three-phase induction motor not rotate correctly, it may also cause serious accidents through overheating and fire.

1

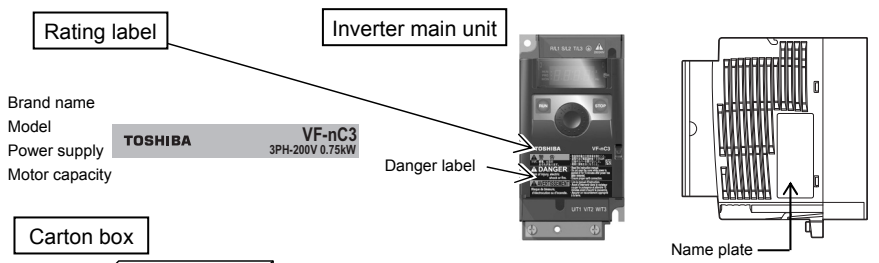

Brand name
Model
Power supply
Motor capacity

TOSHIBA VF-nC3
3PH-200V 0.75kW

Carton box

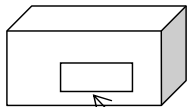

Type indication label

Setup sheet



Danger label



Name plate

TOSHIBA	
TRANSISTOR INVERTER	
Inverter Type	VFNC3S-2022PL
Inverter rated output capacity	2.2kW-3.9kVA-3HP (1)
Power supply	INPUT OUTPUT
	U(V) 1PH 200 240 3PH 200 240
	F(Hz) 50/60 0.1..400
	I(A) 24.0 10.0
Short Circuit Withstand 1000A, 240V max, when protected by fuse, UL Class J 45A max	
Serial No. 8328 14001209 0001 (1)	
Made in Indonesia	
Motor Overload Protection Class 10	
	
231252	KCC-REM01-14
	
LISTED 170M IND. CONTEQ. E204788	
TOSHIBA INDUSTRIAL PRODUCTS AND SYSTEMS CORPORATION TSIJ	

Quick start manual

Danger label kit

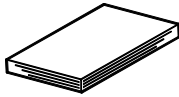

CD-ROM

Contains the instruction manual in digital form



Danger labels for sticking in 6 languages.



- English / French
- German / English / French
- Italian / English / French
- Spanish / English / French
- Chinese / English / French

1.2 Contents of the product

Explanation of the name plate label.

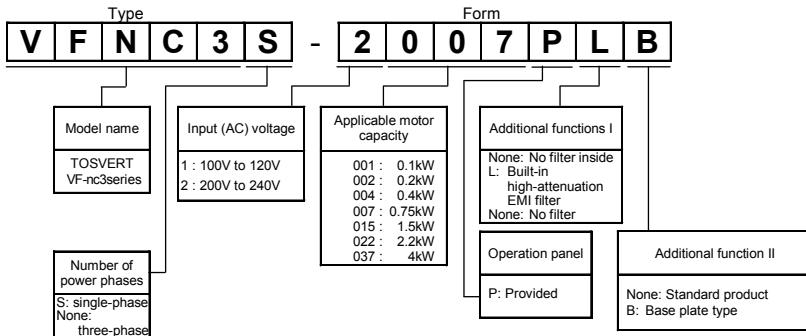

Note 1) Always shut power off first then check the ratings label of inverter held in a cabinet.

Note 2) ID label is stuck for special specification product.

1.3 Names and functions

1.3.1 Outside view

With cover closed

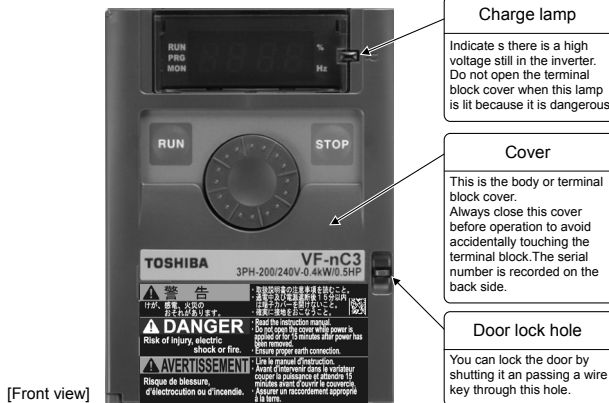

Hole for control wire

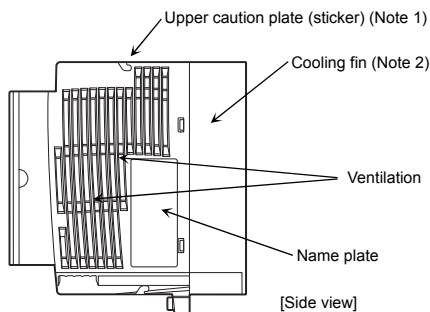
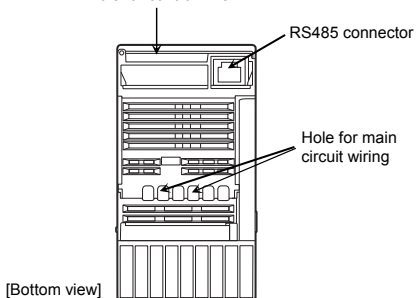

Note 1) Remove the seal as shown on the next page when installing the inverter side by side with other inverters where the ambient temperature will rise above 40°C.

Note 2) Some models are wrapped in plastic.

Example of the label

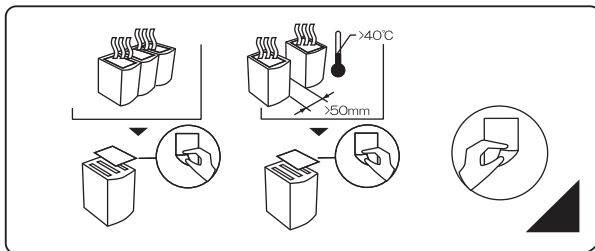

[Opening the cover]

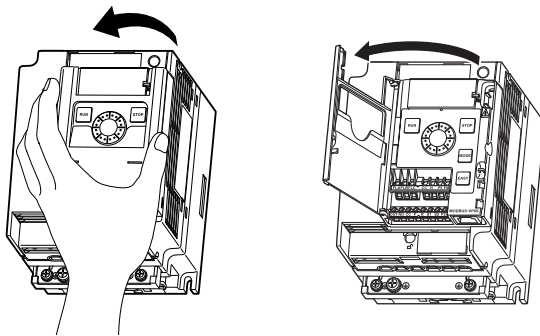

★About the monitor display

The LED on the operation panel uses the following symbols to indicate parameters and operations.

LED display (numbers)

0	1	2	3	4	5	6	7	8	9	-
0̄	1̄	2̄	3̄	4̄	5̄	6̄	7̄	8̄	9̄	-̄

LED display (letters)

Aa	Bb	C	c	Dd	Ee	Ff	Gg	H	h	I	i	Jj	Kk	Ll
R	b	Ċ	c	d	E	F	G	H	h	i	ı	j	/	l
Mm	Nn	O	o	Pp	Qq	Rr	Ss	Tt	Uu	Vv	Ww	Xx	Yy	Zz
m̄	n̄	0̄	ā	p̄	q̄	r̄	s̄	t̄	ū	v̄	w̄	x̄	ȳ	z̄

Warning	
 Prohibited	<ul style="list-style-type: none"> Never touch the internal terminals in the upper right while the front cover is open. There is a risk of shock because it carries a high voltage.

[With cover open]

1

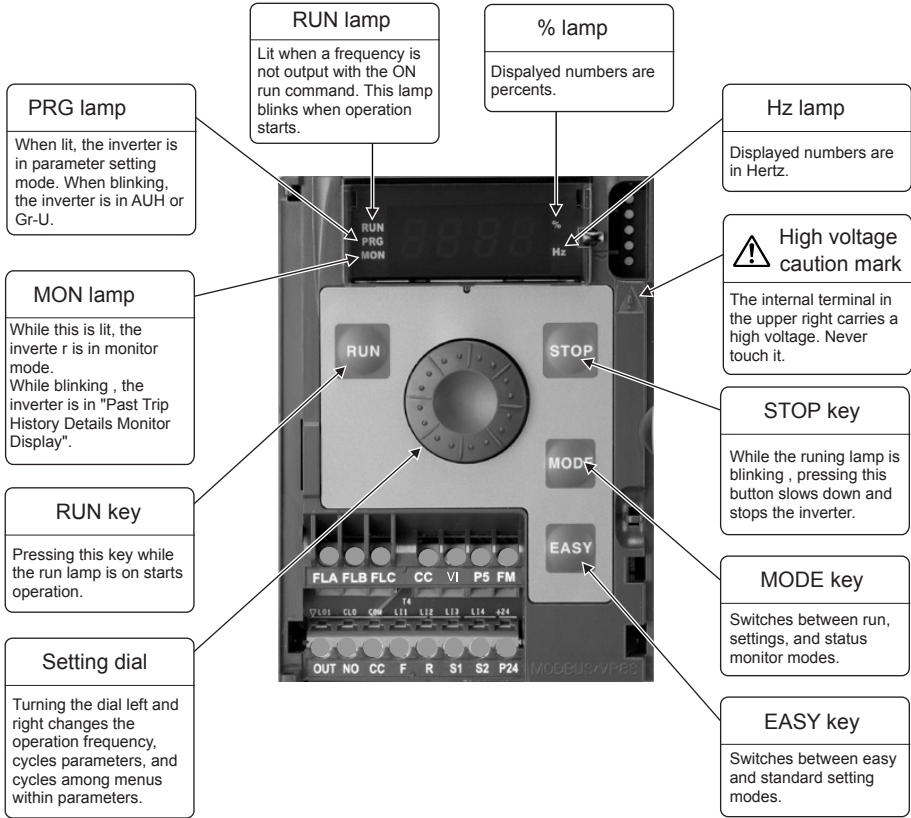

1.3.2 Opening the terminal cover

⚠ Caution



Mandatory
action

- When removing and installing the terminal cover with a screwdriver, be sure not to scratch your hand as this results in injury.
- Pressing too hard on the screwdriver may scratch the inverter.
- Always cut the power supply when removing the wiring cover.
- After wiring is complete, be sure to replace the terminal cover.

Use the following procedure to remove both the upper and lower terminal block covers.

(1) Removing the lower (output and dc terminals) terminal block cover

1)

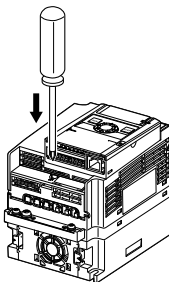

Insert a screwdriver or other thin object into the hole indicated with the ◁ mark.

2)

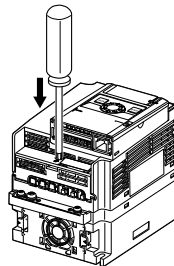

Press in on the screwdriver.

3)

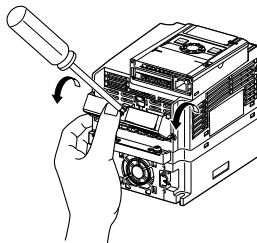

While pressing on the screwdriver, rotate the terminal cover downward to remove it.

4)

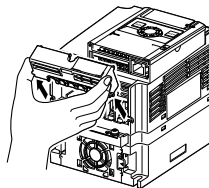

Pull the terminal cover up at an angle.

(2) Removing the upper terminal (input terminal) block cover

1)

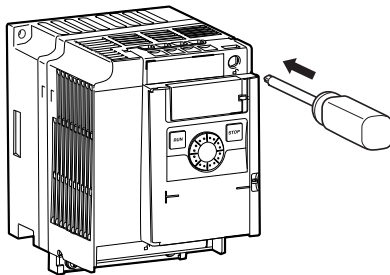

Insert a screwdriver or other thin object into the hole indicated with the  mark.

2)

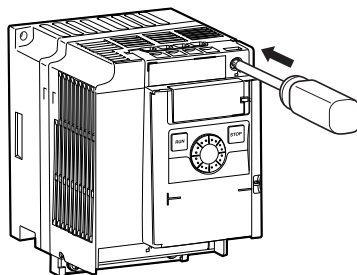

Press in on the screwdriver.

3)

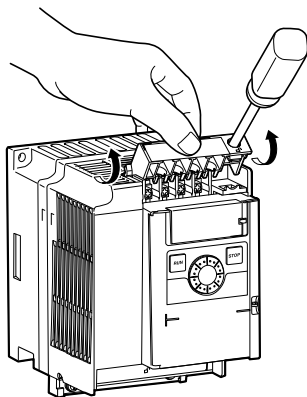

While pressing on the screwdriver, rotate the terminal cover upward to remove it.

4)

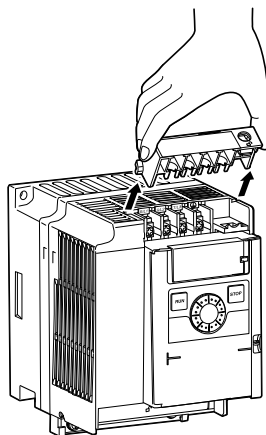

Pull the terminal cover up at an angle.

★ After wiring is complete, be sure to restore the terminal cover to its original position.

1

1.3.3 Power circuit and control circuit terminal boards

1) Power circuit terminal board

In case of the crimp-style terminal, cover the crimp-style terminal with insulated tube, or use the crimp-style terminal with insulation sleeve.

Refer to section 2.3.1 for details about terminal functions.

Screw size	Crimp-style terminal (NOTE)	Tightening torque	
M3.5	xxx – 3.5	1.0Nm	8.9lb • in
M4	xxx – 4	1.4Nm	12.4lb • in
M5	xxx – 5	3.0Nm	26.6lb • in

NOTE) xxx means wire sizes. For the wire sizes, refer to the table in section 10.1.

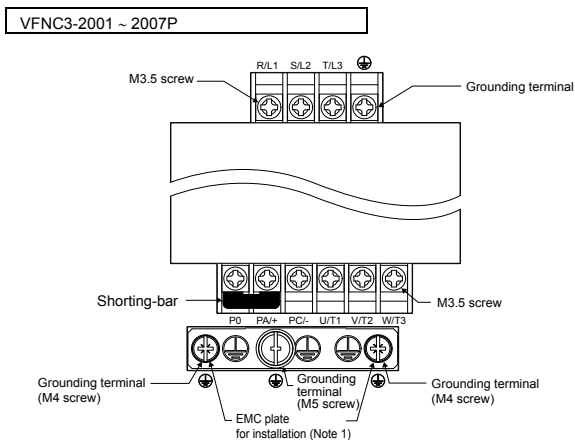

* Bend the clips on the wiring port of the terminal cover to connect the PO, PA+, and PC- terminals.

VFNC3-2015 ~ 2037P

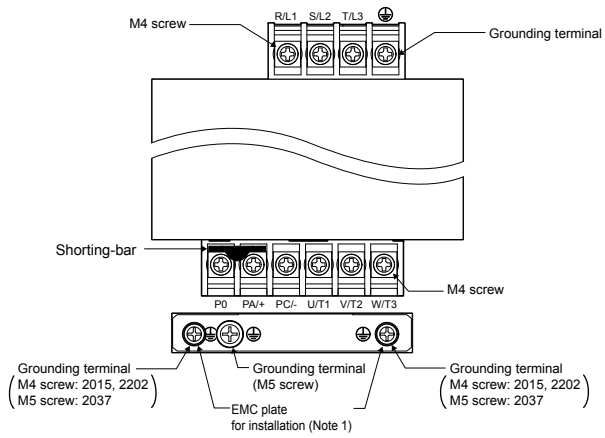

* Bend the clips on the wiring port of the terminal cover to connect the PO, PA/+, and PC/- terminals.

VFNC3S-1001 ~ 1004P, 2001 ~ 2007PL

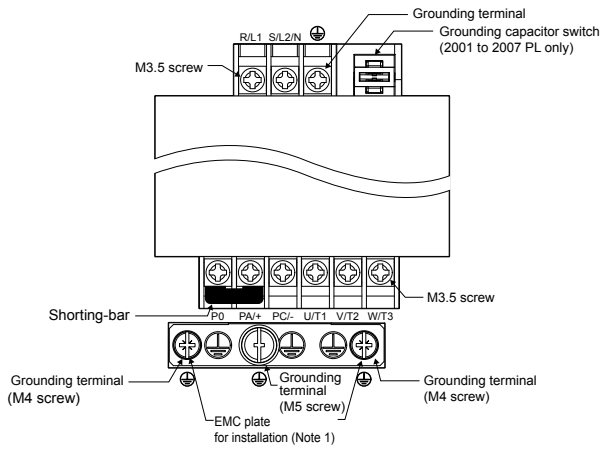

* Bend the clips on the wiring port of the terminal cover to connect the PO, PA/+, and PC/- terminals.

1

VFNC3S-1007P, 2015PL, 2022PL

1

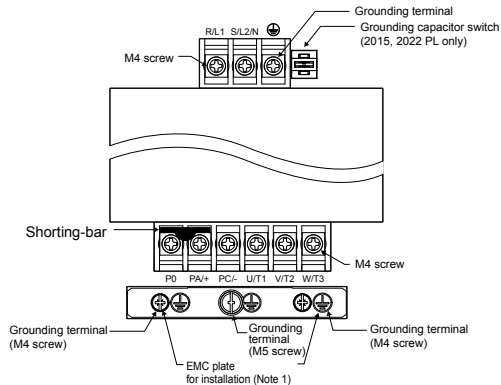

* Bend the clips on the wiring port of the terminal cover to connect the PO, PA/+, and PC/- terminals.

Note 1) The EMC plate is optional.

2) Grounding capacitor switch

Single-phase 240 V models have a built-in high-attenuation noise filter and are grounded via a capacitor. A switch makes for easy switching to reduce leakage current from the inverter and the load on the capacitor. However, be careful, as reducing the load means non-conformity with the EMC standard on the inverter itself. Always do switching with the power off.

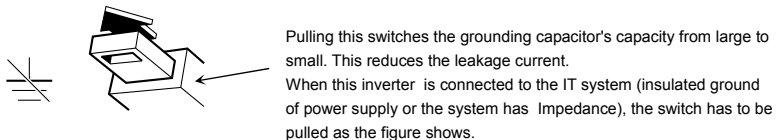
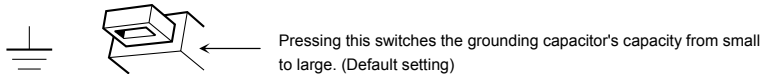

3) Control circuit terminal board

The control circuit terminal board is common to all equipment.

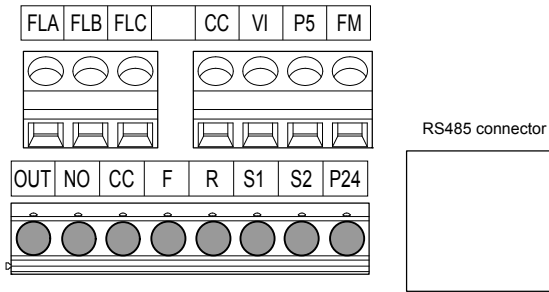

Screw size	Recommended tightening torque
M2.5 screw	0.4 to 0.5 N·m
	3.5 to 4.4 lb·in

Stripping length: 6 (mm)
 Screwdriver: Small-sized flat-blade screwdriver
 (Blade thickness: 0.5 mm, blade width: 3.5 mm)

Refer to section 2.3.2 for details about all terminal functions.

Wire size

Conductor	1 wire	2 wires of same size
Solid	0.3-1.5mm ² (AWG 22-16)	0.3-0.75mm ² (AWG 22-18)
Stranded		

Recommended ferrule

Using ferrule to be improved efficiency and reliability of wiring is recommended.

Wire size mm ² (AWG)	Type	
	PHOENIX CONTACT	Dinkle International.,Ltd
0.34 (22)	AI 0.34-6TQ	DN00306
0.5 (20)	AI 0.5-6WH	DN00506
0.75 (18)	AI 0.75-6GY	DN00706
1 (18)	AI 1-6RD	DN01006
1.5 (16)	AI 1.5-8BK	DN01508
*2 2 X 0.5 (-)	AI TWIN2 X 0.5-8WH	DTE00508
*2 2 X0.75 (-)	AI TWIN2 X 0.75-8GY	DTE00708



*1: Crimping pliers CRIMPFOX ZA3 (PHOENIX CONTACT)
 CT1(Dinkle International.,Ltd)

*2: These ferrules enable practical crimping of two wires in a ferrule.

1.4 Notes on the application

1.4.1 Motors

When the VF-nC3 and the motor are used in conjunction, pay attention to the following items.

 Caution	
 Mandatory action	Use an inverter that conforms to the specifications of power supply and three-phase induction motor being operated. If the inverter being used does not conform to those specifications, not only will the three-phase induction motor not rotate correctly, but it may cause serious accidents through overheating and fire.

Comparisons with commercial power operation

The VF-nC3 Inverter employs the sinusoidal PWM system. However, the output voltage and output current are not perfect sine waves, they have a distorted wave that is close to sinusoidal waveform. This is why compared to operation with a commercial power there will be a slight increase in motor temperature, noise and vibration.

Operation in the low-speed area

When running continuously at low speed in conjunction with a general purpose motor, there may be a decline in that motor's cooling effect. If this happens, operate with the output decreased from rated load. To carry out low-speed operation continuously at the rated torque, we recommend to use a inverter rated motor or a forced cooled motor designed for use with an inverter. When operating in conjunction with a inverter rated motor, you must change the inverter's motor overload protection level \overline{U}_L to VF motor use.

Adjusting the overload protection level

The VF-nC3 Inverter protects against overloads with its overload detection circuits (electronic thermal). The electronic thermal's reference current is set to the inverter's rated current, so it must be adjusted in line with the rated current of the motor being used in combination.

High speed operation over 60Hz

Operating at frequencies over 60Hz will increase noise and vibration. There is also a possibility this will exceed the motor's mechanical strength limits and the bearing limits so you should inquire to the motor's manufacturer about such operation.

Method of lubricating load mechanisms

Operating an oil-lubricated reduction gear and gear motor in the low-speed areas will worsen the lubricating effect. Check with the manufacturer of the reduction gear to find out about operable gearing area.

Low loads and low inertia loads

The motor may demonstrate instability such as abnormal vibrations or overcurrent trips at light loads of 5% or under of the load percentage, or when the load's inertia moment is extremely small. If that happens reduce the carrier frequency.

Occurrence of instability

Unstable phenomena may occur with the load and motor combinations shown below.

- Combined with a motor that exceeds applicable motor ratings for the inverter
- Combine with a much smaller motor according to the applicable motor rating of the inverter.
- Combined with special motors

To deal with the above lower the settings of inverter carrier frequency.

- Combined with couplings between load devices and motors with high backlash

When using the inverter in the above combination, use the S-pattern acceleration/deceleration function, or when vector control is selected, adjust the speed control response or switch to V/f control mode.

- Combined with loads that have sharp fluctuations in rotation such as piston movements

In this case, adjust the response time (inertial moment setting) during vector control or switch to V/f control.

Braking a motor when cutting off power supply

A motor with its power cut off goes into free-run, and does not stop immediately. To stop the motor quickly as soon as the power is cut off install an auxiliary brake. There are different kinds of brake devices, both electrical and mechanical. Select the brake that is best for the system.

Load that produces regenerative torque

When combined with a load that produces regenerative torque, the overvoltage or overcurrent protection function may be activated to trip the inverter.

Motors with a brake

When motors with a brake are directly connected to the inverter's output, the brake cannot be released at startup because of low voltage. Wire the brake circuit separately from the main circuit.

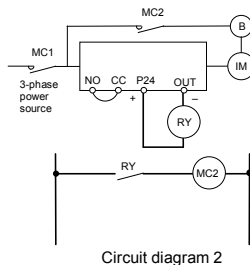
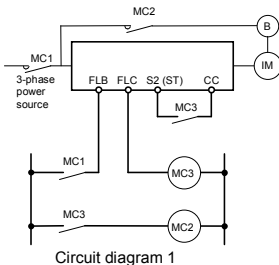

In circuit diagram 1, the brake is turned on and off through MC2 and MC3. If you do not wire it as shown in diagram 1, an over-current trip may occur because of a bound current during brake operation.

(Example of running preparation ST assigned to terminal S2.)

In circuit diagram 2, the brake is turned on and off by using low-speed signal OUT. (Refer to section 6.1.1)

In some situations, such as with elevators, turning the brake on and off with a low-speed signal may be appropriate. Be sure to contact us before designing your system.

1.4.2 Inverters

Protecting inverters from overcurrent

The inverter has an overcurrent protection function. The programmed current level is set to the inverter's maximum applicable motor. If the motor used has a small capacity, the overcurrent level and the electronic thermal protection must be readjusted. If adjustment is necessary, refer to section 3.5, and make adjustments as directed.

Inverter capacity

Do not use a small-capacity (kVA) inverter to control the operation of a large-capacity motor (two-class or more larger motor), no matter how light the load is. Current ripple will raise the output peak current making it easier to set off the overcurrent trip.

Power factor correction capacitor

Power factor correction capacitors cannot be installed on the output side of the inverter. When a motor is run that has a power factor correction capacitor attached to it, remove the capacitors. This can cause inverter malfunction and capacitor destruction.

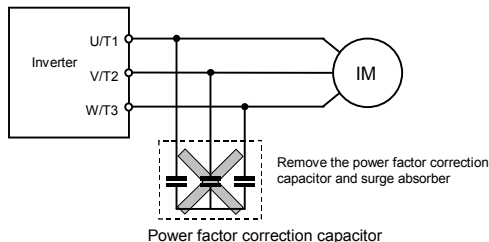

Operating at other than rated voltage

Connections to voltages other than the rated voltage described in the rating label cannot be made. If a connection must be made to a power supply other than one with rated voltage, use a transformer to raise or lower the voltage to the rated voltage.

Circuit breaking when two or more inverters are used on the same power line

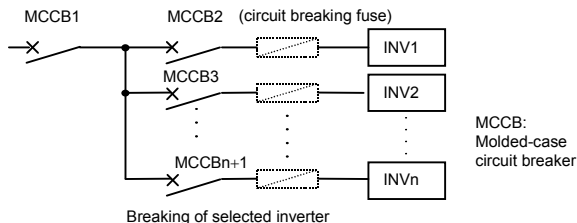

There is no fuse in the inverter's main circuit. Thus, as the diagram above shows, when more than one inverter is used on the same power line, you must select interrupting characteristics so that only MCCB2 to MCCBn+1 will trip and the MCCB1 will not trip when a short occurs in the inverter (INV1). When you cannot select the proper characteristics install a circuit interrupting fuse behind MCCB2 to MCCBn+1.

If power supply distortion is not negligible

If the power supply distortion is not negligible because the inverter shares a power distribution line with other systems causing distorted waves, such as systems with thyristors or large-capacity inverters, install an input reactor to improve the input power factor, to reduce higher harmonics, or to suppress external surges.

■ Disposal

Refer to chapter 16.

1.4.3 What to do about the leakage current



Caution



Mandatory
action

Current may leak through the inverter's input/output wires because of insufficient electrostatic capacity on the motor with bad effects on peripheral equipment.
The leakage current's value is affected by the carrier frequency and the length of the input/output wires.
Test and adopt the following remedies against leak current.

(1) Leakage current from the inverter main unit

Some of these inverters are equipped with a ground capacitor compliant with the EMC directive which gives them a comparatively higher value than a normal inverter. Take this into consideration when selecting a leakage breaker.

Refer to "Leakage current" (E6581181) in the separate user manual for details.

(2) Influence of leakage current across ground

Leakage current may flow not just through the inverter system but also through ground wires to other systems. Leakage current will cause earth leakage breakers, leakage current relays, ground relays, fire alarms and sensors to operate improperly, and it will cause superimposed noise on the TV screen or display of incorrect current detection with the CT.

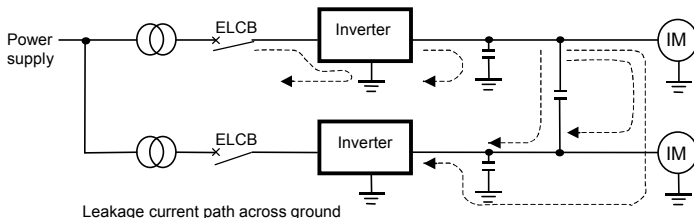

Remedies:

1. If there is no radio-frequency interference or similar problem, detach the built-in noise filter capacitor, using the grounding capacitor disconnecting switch. (Refer to section 1.3.3-2))
2. Reduce F_{3Q} : PWM carrier frequency. However the motor magnetic noise is increased. (Refer to section 6.11)
3. Use high frequency remedial products for earth leakage breakers

(3) Influence of leakage current across lines

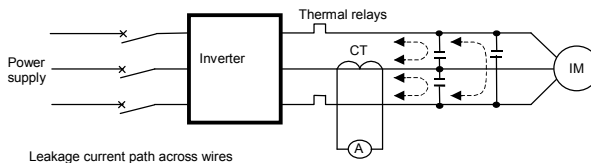

(1) Thermal relays

The high frequency component of current leaking into electrostatic capacity between inverter output wires will increase the effective current values and make externally connected thermal relays operate improperly. If the wires are more than 50 meters long, it will be easy for the external thermal relay to operate improperly with models having motors of low rated current (several A (ampere) or less), because the leakage current will increase in proportion to the motor rating.

Remedies:

1. Use the electronic thermal built into the inverter. (Refer to section 3.5)
The setting of the electronic thermal is done using parameter $\sigma L R, t H r$.
2. Reduce F_{3Q} : PWM carrier frequency. However the motor magnetic noise is increased. (Refer to section 6.11)
3. This can be improved by installing 0.1 μ ~0.5 μ F - 1000V film capacitor to the input/output terminals of each phase in the thermal relay.

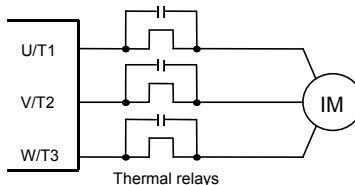



(2) CT and ammeter

If a CT and ammeter are connected externally to detect inverter output current, the leak current's high frequency component may destroy the ammeter. If the wires are long (50 meters or more), or in case of models with motors of low rated current (several A (ampere) or less), the high frequency component of leakage current may pass through the externally connected CT and it may burn the ammeter connected CT, because the ratio of leakage current against the motor's rated current will increase.

Remedies:

1. Use a meter output terminal in the inverter control circuit.
The load current can be output on the meter output terminal (FM). If the meter is connected, use an ammeter of 1mAdc full scale or a voltmeter of 10Vdc full scale.
0-20mAdc (4-20mAdc) can be also output. (Refer to section 3.4)
2. Set $F\overline{3}\overline{0}\overline{0}$: PWM carrier frequency=4 kHz or less. However the motor magnetic noise is increased. (Refer to section 6.11)
3. Use the monitor functions built into the inverter.
Use the monitor functions on the panel built into the inverter to check current values. (Refer to section 8.2.1)

(4) Influence and remedy of the leakage current by long-distance wiring

 Caution	
 Mandatory action	As a remedy, when using an AC reactor (PFL series) for the output side of an inverter, Set $F\overline{3}\overline{0}\overline{0}$: PWM carrier frequency=2 kHz or less. This can also cause serious accidents through overheating and fire.

Make the wiring length between an inverter and a motor 100 m or less, and shorten as much as possible.

When connecting two or more sets of motors, the wiring length is the total wiring length.



Over-current trip may be occurred according to the charging current which will flow into the electrostatic capacity between cables if wiring length becomes long.



In that case, please cope with installing an AC reactor (PFL series) in the output side of an inverter, or reduces the electrostatic capacity of a cable etc. by wiring by loose wires, etc.

1.4.4 Installation

■ Installation environment

The VF-nC3 Inverter is an electronic control instrument. Take full consideration to installing it in the proper operating environment.

 Warning	
 Prohibited	<ul style="list-style-type: none"> Do not place any inflammable substances near the VF-nC3 Inverter. If an accident occurs in which flame is emitted, this could lead to fire. Do not install in any location where the inverter could come into contact with water or other fluids. This can result in electric shock or fire.
 Mandatory action	<ul style="list-style-type: none"> Operate under the environmental conditions prescribed in the instruction manual. Operations under any other conditions may result in malfunction.

 Caution	
 Prohibited	<ul style="list-style-type: none"> Do not install the VF-nC3 Inverter in any location subject to large amounts of vibration. This could cause the unit to fall, resulting in bodily injury.
 Mandatory action	<ul style="list-style-type: none"> Check to make sure that the input power voltage is +10%, -15% of the rated power voltage written on the rating label ($\pm 10\%$ when the load is 100% in continuous operation) If the input power voltage is not +10%, -15% of the rated power voltage ($\pm 10\%$ when the load is 100% in continuous operation) this may result in fire.



- Do not install in any location of high temperature, high humidity, moisture condensation and freezing and avoid locations where there is exposure to water and/or where there may be large amounts of dust, metallic fragments and oil mist.
- Do not install in any location where corrosive gases or grinding fluids are present.

1

- Operate in areas where ambient temperature ranges from -10°C to 60°C . Operation above 40°C is allowed when the top label is peeled off. When installing the inverter where the ambient temperature will rise above 50°C , remove the label (seal) from the top and operate it at a current lower than the rated one. (Refer to section 6.11)



[Position for measuring ambient temperature]

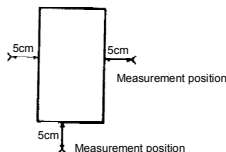

Note: The inverter is a heat-emitting body. Make sure proper space and ventilation is provided when installing in the cabinet. When installing inside a cabinet, we recommend the top seal peeled off although 40°C or less.

- Do not install in any location that is subject to large amounts of vibration.





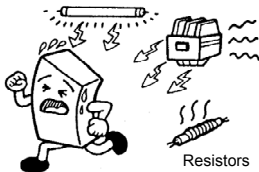

Note: If the VF-nC3 Inverter is installed in a location that is subject to vibration, anti-vibration measures are required. Please consult with Toshiba about these measures.

- If the VF-nC3 Inverter is installed near any of the equipment listed below, provide measures to insure against errors in operation.



- | | |
|----------------------|--------------------------------------|
| Solenoids: | Attach surge suppressor on coil. |
| Brakes: | Attach surge suppressor on coil. |
| Magnetic contactors: | Attach surge suppressor on coil. |
| Fluorescent lights: | Attach surge suppressor on coil. |
| Resistors: | Place far away from VF-nC3 Inverter. |

■ How to install

 Warning	
 Prohibited	<ul style="list-style-type: none"> Do not install or operate the inverter if it is damaged or any component is missing. This can result in electric shock or fire. Contact your Toshiba distributor for repairs.
 Mandatory action	<ul style="list-style-type: none"> Mount the inverter on a metal plate. The rear panel gets very hot. Do not install in an inflammable object, this can result in fire. Do not operate with the front panel cover removed. This can result in electric shock. An emergency stop device must be installed that fits with system specifications (e.g. shut off input power then engage mechanical brake). Operation cannot be stopped immediately by the inverter alone, thus risking an accident or injury. All options used must be those specified by Toshiba. The use of any other option may result in an accident.
 Caution	
 Mandatory action	<ul style="list-style-type: none"> The main unit must be installed on a base that can bear the unit's weight. If the unit is installed on a base that cannot withstand that weight, the unit may fall resulting in injury. If braking is necessary (to hold motor shaft), install a mechanical brake. The brake on the inverter will not function as a mechanical hold, and if used for that purpose, injury may result.

(1) Normal installation

Select an indoor location with good ventilation, and then install it upright on a flat metal plate.

When installing multiple inverters, leave at least 3 cm of space between each inverter and install them aligned horizontally.

When using the inverter in locations with temperatures above 40°C, remove the caution plate (sticker) on top of the inverter before use. Current reduction is necessary in locations with temperatures above 50°C.

(2) Side-by-side installation

To align the inverters side-by-side horizontally, remove the caution plate (sticker) on top of the inverter before use. Current reduction is necessary in locations with temperatures above 40 °C.

If the door is opened 90° or more, please open the door with the left side inverter's door open when the same capacity inverters are installed with side-by-side.

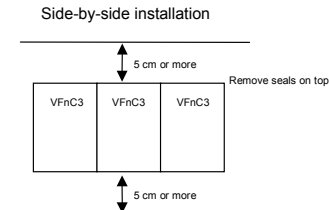
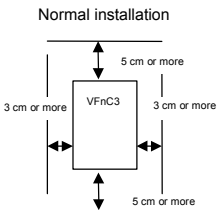

The space shown in the diagram is the minimum allowable space. Because air cooled equipment has cooling fans built in on the top or bottom surfaces, make the space on top and bottom as large as possible to allow for air passage.

Note: Do not install in any location where there is high humidity or high temperatures and where there are large amounts of dust, metallic fragments and oil mist.

■ Calorific values of the inverter and the required ventilation

About 5% of the rated power of the inverter will be lost as a result of conversion from AC to DC or from DC to AC. In order to suppress the rise in temperature inside the cabinet when this loss becomes heat loss, the interior of the cabinet must be ventilated and cooled.

The calorific values, the amount of forcible air-cooling ventilation required and the necessary heat discharge surface quantity when operating in a sealed cabinet according to motor capacity are as follows. (PWM carrier frequency is 4kHz or 12kHz.)

Voltage class	Inverter type	Calorific values Note 1)		Amount of forcible air cooling ventilation required (m ³ /min)		Heat discharge surface area required for sealed storage cabinet (m ²)		Standby power requirement (W) Note 2)	
		PWM carrier frequency 4kHz	12kHz	PWM carrier frequency 4kHz	4kHz	PWM carrier frequency 12kHz	4kHz		
Three-phase 240V class	VFNC3-	2001P	13	14	0.07	0.08	0.26	0.28	8
		2002P	16	18	0.09	0.10	0.32	0.36	8
		2004P	24	28	0.14	0.16	0.48	0.56	8
		2007P	41	45	0.23	0.26	0.82	0.90	8
		2015P	73	85	0.41	0.48	1.46	1.70	12
		2022P	85	90	0.48	0.51	1.70	1.80	12
	2037P	128	133	0.73	0.75	2.56	2.66	12	
Single-phase 240V class	VFNC3S	2001PL	13	14	0.07	0.08	0.26	0.28	8
		2002PL	18	20	0.10	0.11	0.36	0.40	8
		2004PL	27	31	0.15	0.18	0.54	0.62	8
		2007PL	44	43	0.25	0.24	0.88	0.86	8
		2015PL	72	83	0.41	0.47	1.44	1.66	11
		2022PL	93	102	0.53	0.53	1.86	2.04	11
Single-phase 120V class	VFNC3S-	1001P	13	14	0.07	0.08	0.26	0.28	8
		1002P	18	20	0.10	0.11	0.36	0.40	8
		1004P	29	33	0.16	0.19	0.58	0.66	8
		1007P	48	54	0.27	0.31	0.96	1.08	11

Note 1) Case of 100% Load Continuation operation. The heat loss for the optional external devices (input AC reactor, DC reactor, radio noise reduction filters, etc.) is not included in the calorific values.

Note 2) It is power consumption when power is on but output frequency is 0Hz, and cooling fan is activated.

■ Panel designing taking into consideration the effects of noise

The inverter generates high frequency noise. When designing the control panel setup, consideration must be given to that noise. Examples of measures are given below.

- Wire so that the main circuit wires and the control circuit wires are separated. Do not place them in the same conduit, do not run them parallel, and do not bundle them.
- Provide shielding and twisted wire for control circuit wiring.
- Separate the input (power) and output (motor) wires of the main circuit. Do not place them in the same conduit, do not run them parallel, and do not bundle them.
- Ground the inverter grounding terminals (⏏).
- Install surge suppressor on any magnetic contactor and relay coils used around the inverter.
- Install noise filters if necessary.
- To comply with the EMC directives, install the optional EMC plate and fix the shield to it.
- Install EMC plate and use shielded wires.

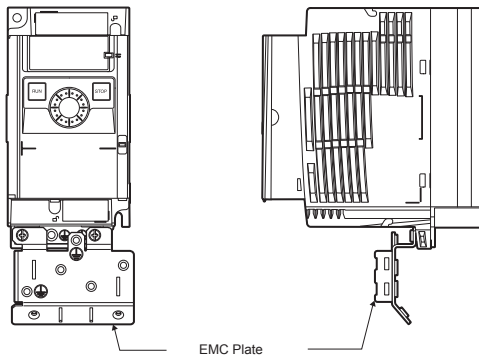



■ Installing more than one unit in a cabinet

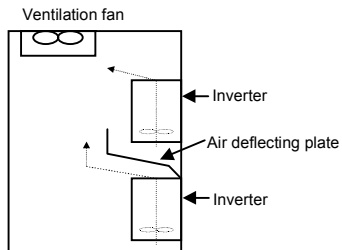

If you are installing two or more inverters in one cabinet, pay attention to the following.

- Inverters may be installed side by side with each other with no space left between them.
- When installing inverters side by side, detach the caution label on the top surface of each inverter and use them where the ambient temperature will not rise above 40°C.
- When using inverters where the ambient temperature will rise above 40°C, leave a space of 3 cm or more between them and remove the caution label from the top of each inverter, or operate each inverter at a current lower than the rated one.
- Ensure a space of at least 20 centimeters on the top and bottom of the inverters.
- Install an air deflecting plate so that the heat rising up from the inverter on the bottom does not affect the inverter on the top.





2. Connection

 Warning	
 Disassembly prohibited	<ul style="list-style-type: none"> Never disassemble, modify or repair. This can result in electric shock, fire and injury. Call your Toshiba distributor for repairs.
 Prohibited	<ul style="list-style-type: none"> Don't stick your fingers into openings such as cable wiring hole and cooling fan covers. This can result in electric shock or other injury. Don't place or insert any kind of object into the inverter (electrical wire cuttings, rods, wires). This can result in electric shock or fire. Do not allow water or any other fluid to come in contact with the inverter. That may result in electric shock or fire.

 Caution	
 Prohibited	<ul style="list-style-type: none"> When transporting or carrying, do not hold by the front panel covers. The covers may come off and the unit will drop out resulting in injury.

2.1 Cautions on wiring

 Warning	
 Prohibited	<ul style="list-style-type: none"> Never remove the terminal cover when power is on or open door if enclosed in a cabinet. The unit contains many high voltage parts and contact with them will result in electric shock.
 Mandatory action	<ul style="list-style-type: none"> Turn power on only after attaching the front cover or closing door if enclosed in a cabinet. If power is turned on without the terminal cover attached or closing door if enclosed in a cabinet. This can result in electric shock or other injury. Electrical construction work must be done by a qualified expert. Connection of input power by someone who does not have that expert knowledge may result in fire or electric shock. Connect output terminals (motor side) correctly. If the phase sequence is incorrect, the motor will operate in reverse and that may result in injury. Wiring must be done after installation. If wiring is done prior to installation that may result in injury or electric shock. The following steps must be performed before wiring. <ol style="list-style-type: none"> (1) Shut off all input power. (2) Wait at least 15 minutes and check to make sure that the charge lamp is no longer lit. (3) Use a tester that can measure DC voltage (400VDC or more), and check to make sure that the voltage to the DC main circuits (across PA-PC) is 45V or less. If these steps are not properly performed, the wiring will cause electric shock. Tighten the screws on the terminal board to specified torque. If the screws are not tightened to the specified torque, it may lead to fire.

**Warning**

Be Grounded

- Ground must be connected securely.
If the ground is not securely connected, it could lead to electric shock or fire when a malfunction or current leak occurs.

**Caution**

Prohibited

- Do not attach devices with built-in capacitors (such as noise filters or surge absorber) to the output (motor side) terminal.
This could cause a fire.

2

■ Preventing radio noise

To prevent electrical interference such as radio noise, separately bundle wires to the main circuit's power terminals (3-phase models: R/L1, S/L2, T/L3, single-phase models: R/L1, S/L2/N) and wires to the motor terminals (U/T1, V/T2, W/T3).





■ Control and main power supply

The control power supply and the main circuit power supply for the VFnc3 are the same. If a malfunction or trip causes the main circuit to be shut off, control power will also be shut off. When checking the cause of the malfunction or the trip, use the trip holding retention selection parameter.

■ Wiring

- Cover the crimp-style terminal with insulated tube, or use the crimp-style terminal with insulation sleeve when crimp-style terminals are used for the main circuit terminals.
Connect the terminals so that adjacent terminals do not touch each other.
- For ground terminal  use wires of the size that is equivalent to or larger than those given in table 10.1 and always ground the inverter (240V voltage class: D type ground).
Use as large and short a ground wire as possible and wire it as close as possible to the inverter.
- For the sizes of electric wires used in the main circuit, refer to the table in section 10.1.
- The length of the main circuit wire in table 10.1 should be no longer than 30 meters. If the wire is longer than 30 meters, the wire size (diameter) must be increased.

2.2 Standard connections

 Warning	
 Prohibited	<ul style="list-style-type: none"> Do not connect input power to the output (motor side) terminals (U/T1, V/T2, W/T3). Connecting input power to the output could destroy the inverter or cause a fire. Do not insert a resistor between DC terminals (between PA/+ and PC/-, or between PO and PC/-). It could cause a fire. See 6.13.4 for the connection of a resistor. First shut off input power and wait at least 15 minutes before touching wires on equipment (MCCB) that is connected to inverter power side. Touching the wires before that time could result in electric shock. Do not shut down the external power supply on ahead when VIA terminal is used as logic input terminal by external power supply (F I 2 7=2 0 0). It could cause unexpected result as VIA terminal is ON status.
 Mandatory action	<ul style="list-style-type: none"> Set a parameter F I 0 0 when VI terminal is used as logic input terminal. If it is not set, it could result in malfunction.
 Be Grounded	<ul style="list-style-type: none"> Ground must be connected securely. If the ground is not securely connected, it could lead to electric shock or fire when a malfunction or current leak occurs.

2.2.1 Standard connection diagram 1

This diagram shows a standard wiring of the main circuit.

Standard connection diagram – SINK (Negative) (common:CC)

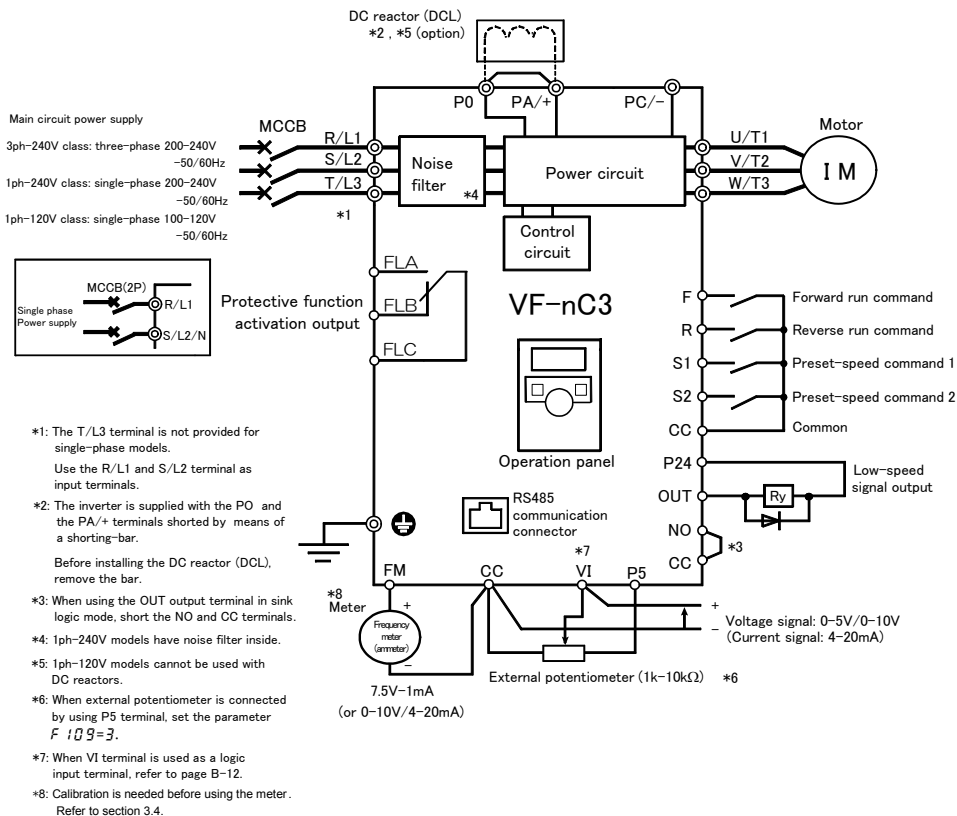

2.2.2 Standard connection diagram 2

Standard connection diagram – SOURCE (Positive) (common:P24)

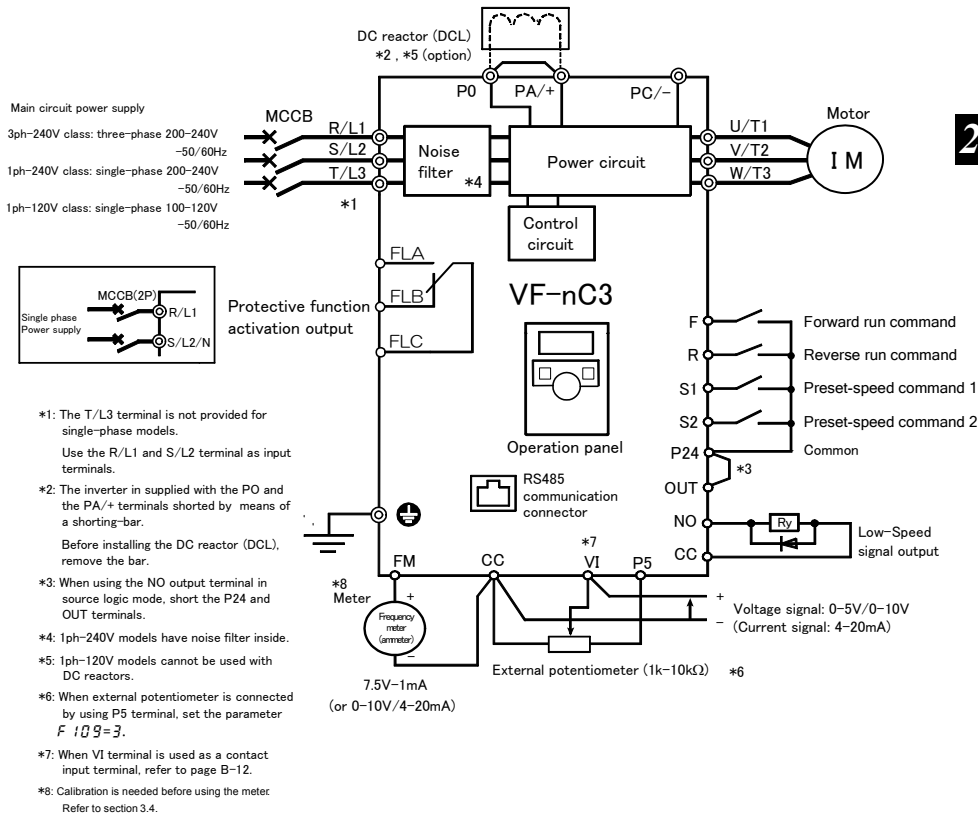

2.3 Description of terminals

2.3.1 Power circuit terminals

This diagram shows an example of wiring of the main circuit. Use options if necessary.

■ Power supply and motor connections

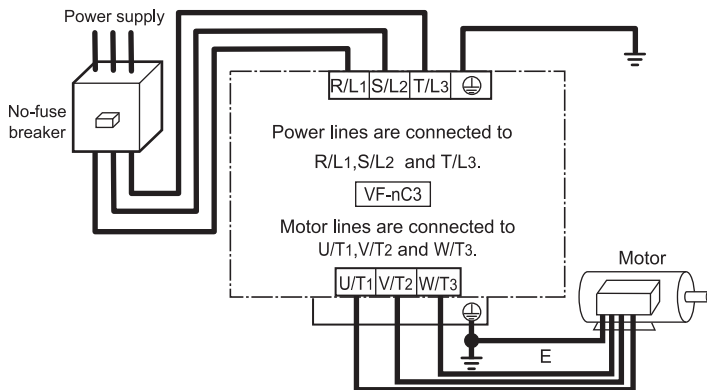

■ Connections with peripheral equipment

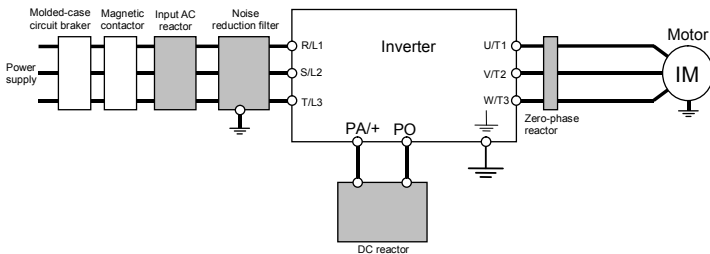

Note 1: The T/L3 terminal is not provided for any single-phase models. So if you are using single-phase models, use the R/L1 and S/L2/N terminals to connect power cables.

■ Power circuit

Terminal symbol	Terminal function
	Grounding terminal for connecting inverter. There are 4 terminals in total. (1 terminal on upper side, 3 terminals on down side)
R/L1,S/L2,T/L3	240V class: three-phase 200 to 240V-50/60Hz single-phase 200 to 240V-50/60Hz 120V class: single-phase 100 to 120V-50/60Hz * Single-phase input: R/L1 and S/L2/N terminals
U/T1,V/T2,W/T3	Connect to a (three-phase induction) motor.
PC/-	This is a negative potential terminal in the internal DC main circuit. DC common power can be input across the PA terminals (positive potential). DC common power can not connect to 1-phase 120V models.
PO, PA/+	Terminals for connecting a DC reactor (DCL: optional external device). Shorted by a short bar when shipped from the factory. Before installing DCL, remove the shorting-bar. 1-phase 120V models cannot be used with DC reactors.

The arrangements of power circuit terminals are different from each range.

Refer to section 1.3.3.1) for details.

2.3.2 Control circuit terminals

The control circuit terminal board is common to all equipment.

Regarding to the function and specification of each terminal, please refer to the following table.

Refer to section 1.3.3.3) about the arrangement of control circuit terminals.

■ Control circuit terminals

Terminal symbol	Input / output	Function	Electrical specifications	Inverter internal circuits
F	Input	Multifunction programmable logic input	Shorting across F-CC causes forward rotation; open causes slow-down and stop. (When Standby ST is always ON) 3 different functions can be assigned.	
R	Input		Shorting across R-CC causes reverse rotation; open causes slow-down and stop. (When Standby ST is always ON) 3 different functions can be assigned.	
S1	Input		Shorting across S1-CC causes preset speed operation. 2 different functions can be assigned.	
S2	Input		Shorting across S2-CC causes preset speed operation. 2 different functions can be assigned.	
P24	Output	24Vdc power output (When $F_{i27} = 0$ or $i00$)	24Vdc-100mA	
	Input	This terminal can be used as an external 24Vdc input for logic input terminal by changing parameter $F_{i27} = 200$.	-	
CC	Common to Input / output	Control circuit's equipotential terminal (2 terminals)	-	

Terminal symbol	Input / output	Function	Electrical specifications	Inverter internal circuits	
P5	Output	Analog power supply output	5Vdc (permissible load current: 10mA)		
2	VI	Input	Multifunction programmable analog input. Factory default setting: 0-10Vdc (1/1000 resolution) and 0-60Hz (0-50Hz) frequency input. The function can be changed to 0-20mAdc (4-20mA) current input by parameter $F\ 1\ 0\ 9 = 1$ setting. 0-5Vdc (1/1000 resolution) voltage input by parameter $F\ 1\ 0\ 9 = 3$ setting. Switch to this setting when external potentiometer is connected by using P5 terminal. By changing parameter $F\ 1\ 0\ 9 = 2$ setting, this terminal can also be used as a multifunction programmable logic input terminal. When using the sink logic, be sure to insert a resistor between P24-VI (4.7 kΩ-1/2 W).	5V/10Vdc (internal impedance: 40kΩ) 4-20mA (internal impedance: 250Ω) Note 1)	
FM	Output	Multifunction programmable analog output. Standard default setting: output frequency. The function can be changed to 0-10Vdc voltage or 0-20mAdc (4-20mA) current output by parameter $F\ 6\ 8\ 1$ setting.	1mAdc full-scale ammeter or QS6T(option) 0-20mA (4-20mA) DC ammeter Permissible load resistance: 750Ω or less 0-10V DC volt meter Permissible load resistance: 1kΩ or more		

Note 1) Be careful, if 4-20mA is selected, when the inverter's power is ON, the internal impedance is 250Ω, but when the power is OFF, the internal impedance increases very much to approximately 40kΩ.

Terminal symbol	Input / output	Function	Electrical specifications	Inverter internal circuits
OUT NO	Output	<p>Multifunction programmable open collector output. Standard default setting detect and output low speed signal. Multifunction output terminals to which two different functions can be assigned. The NO terminal is an isoelectric output terminal. It is insulated from the CC terminal.</p> <p>By changing parameter settings, these terminals can also be used as multifunction programmable pulse train output terminals.</p>	<p>Open collector output 24Vdc-100mA</p> <p>To output pulse trains, a current of 10mA or more needs to be passed.</p> <p>Pulse frequency range: 38~1600pps</p>	
FLA FLB FLC Note 2)	Output	<p>Multifunction programmable relay contact output. Detects the operation of the inverter's protection function. Contact across FLA-FLC is closed and FLB-FLC is opened during protection function operation.</p>	<p>Max. switching capacity 250Vac-2A 30Vdc-2A ($\cos\phi=1$) : at resistive load</p> <p>250Vac-1A ($\cos\phi=0.4$) 30Vdc-1A (L/R=7ms)</p> <p>Min. permissible load 5Vdc-100mA 24Vdc-5mA</p>	

2

Note 2) A chattering (momentary ON/OFF of contact) is generated by external factors of the vibration and the impact, etc. In particular, please set the filter of 10ms or more, or timer for measures when connecting it directly with input unit terminal of programmable controller. Please use the OUT terminal as much as possible when the programmable controller is connected.

■ Connection of SINK (Negative) logic/SOURCE (Positive) logic

Current flowing out turns control input terminals on. These are called sink logic terminals.

The general used method in Europe is source logic in which current flowing into the input terminal turns it on.

Sink logic is sometimes referred to as negative logic, and source logic is referred to as positive logic.

Each logic is supplied with electricity from either the inverter's internal power supply or an external power supply, and its connections vary depending on the power supply used.

Setting of sink/source logic varies depending on the setup menu setting. (Refer to section 11.5)

Sink/source logic can be switched by parameter $F 127$.

<Examples of connections when the inverter's internal power supply is used>

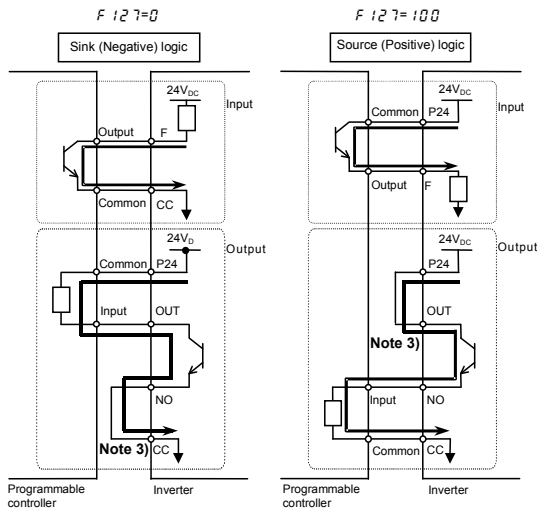

**Note 3) Be sure to connect NO and CC terminals for Sink logic.
Be sure to connect P24 and OUT terminals for Source logic.**

◀Examples of connections when an external power supply is used▶

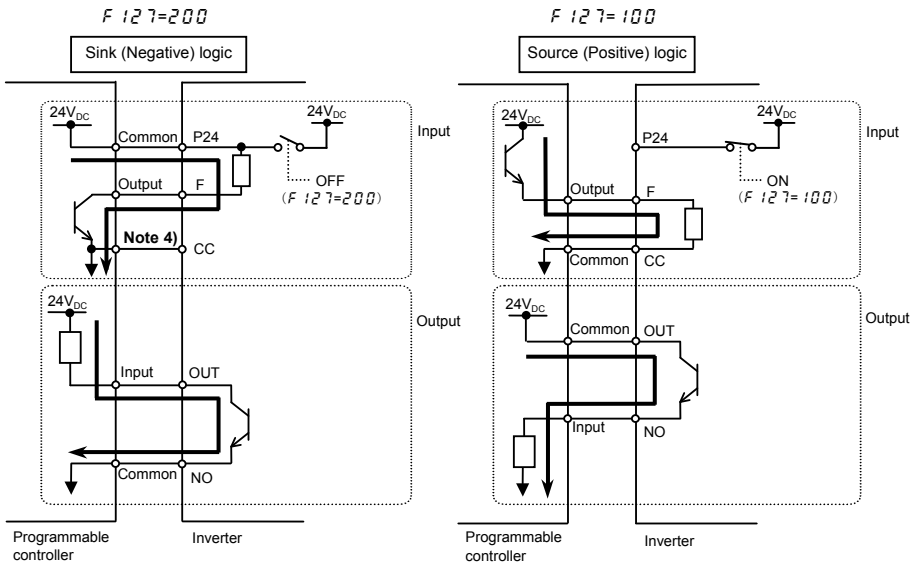

Note 4) Be sure to connect 0V of external power supply and CC terminal of the inverter.

2

■ Selecting the functions of the VI terminal between analog input and logic input

The functions of the VI terminal can be selected between analog input and logic input by changing parameter settings ($F \text{ I} \text{ 9}$). (Factory default setting: Analog input 0-10V)

Be sure to connect a resistor between P24 and VI terminals in case of sink logic, between VI and CC terminals in case of source logic. (Recommended resistance: $4.7\text{k}\Omega$ -1/2W)

When using VI terminal as a logic input terminal, set the parameter $F \text{ I} \text{ 9}=2$ and connect as following schematics.

If no resistor is inserted, logic input will be left always ON, which is very dangerous.

Switch between analog input and logic input before connecting the terminals to the control circuit terminals.

Otherwise the inverter or devices connected to it may be damaged.

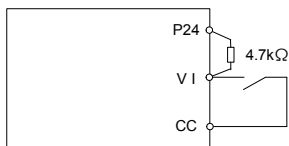

<Sink logic>



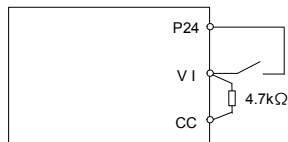

<Source logic>



3. Operations

 Caution	
 Prohibited	<ul style="list-style-type: none"> Do not touch inverter terminals when electrical power is going to the inverter even if the motor is stopped. Touching the inverter terminals while power is connected to it may result in electric shock. Do not touch switches when the hands are wet and do not try to clean the inverter with a damp cloth. Such practices may result in electric shock. Do not go near the motor in alarm-stop status when the retry function is selected. The motor may suddenly restart and that could result in injury. Take measures for safety, e.g. attaching a cover to the motor, against accidents when the motor unexpectedly restarts.
 Mandatory action	<ul style="list-style-type: none"> If the inverter begins to emit smoke or an unusual odor, or unusual sounds, immediately turn power off. If the equipment is continued in operation in such a state, the result may be fire. Contact your Toshiba distributor for repairs. Always turn power off if the inverter is not used for long periods of time. Turn the input power on only after attaching the terminal block cover. When enclosed inside a cabinet and used with the terminal block cover removed, always close the cabinet doors first and then turn the power on. If the power is turned on with the terminal block cover or the cabinet doors open, this may result in electric shock. Make sure that operation signals are off before resetting the inverter after malfunction. If the inverter is reset before turning off the operating signal, the motor may restart suddenly causing injury.

 Caution	
 Contact prohibited	<ul style="list-style-type: none"> Do not touch heat radiating fins or discharge resistors. These devices are hot, and you'll get burned if you touch them.
 Prohibited	<ul style="list-style-type: none"> Observe all permissible operating ranges of motors and mechanical equipment. (Refer to the motor's instruction manual.) Not observing these ranges may result in injury.

3.1 How to Set the Setup Menu

Warning



Mandatory
action

- Set a region correctly with the setting menu.
If the setting is incorrect, the drive may have no work, some damages or unexpected movements.

Caution





Mandatory
action

- When copying parameters by the Parameter writer (option) etc., execute after setting the setup menu.,
If executed before setting up the setup menu (SEt blinking state in case of the power on etc.), the drive does not work since the sink / source switching parameter F127 = 255 (invalid).
Reset or turn the power off and then back on again. The setting value of F127 will be reflected.

Set the setup menu according to the logic for control input signals used and the base frequency of the motor connected. (If you are not sure which setup menu should be selected region codes and what values should be specified, consult your distributor.)

Each setup menu automatically sets all parameters relating to the logic for control input signals used and the base frequency of the motor connected. (See the table on the following page.)

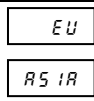
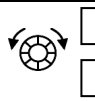
Follow these steps to change the setup menu [Example: Selecting a region code to EU]

Panel operated	LED display	Operation
	SEt	Power on. (SEt is blinking)
	 	Turn the setting dial, and select region code "EU" (Europe).
	EU ⇄ In It	Press the center of the setting dial to determine the region.
	0.0	The output frequency is displayed (Standby).

- When changing the region selected in the setup menu, the setup menu can be called again by the following method. However, please note that all parameters will return to the default setting and the trip history data will clear.
 - Set parameter LYP to "13".
 - Set parameter SEt to "0".
- The parameter settings in the table on the following page can be changed individually even after they are selected in the setup menu.

■ Values set by each setup parameter

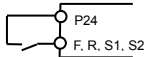
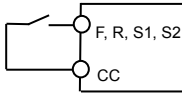
Title	Function	<i>EU</i> (Mainly in Europe)	<i>USA</i> (Mainly in North America)	<i>RSIA</i> (Mainly in Asia, Oceania)	<i>JP</i> (Mainly in Japan)
<i>FH</i>	Maximum frequency	50.0(Hz)	60.0(Hz)	50.0(Hz)	80.0(Hz)
<i>UL / UL / F170</i>	Frequency settings	50.0(Hz)	60.0(Hz)	50.0(Hz)	60.0(Hz)
<i>F204</i>	VI input point 2 frequency	50.0(Hz)	60.0(Hz)	50.0(Hz)	60.0(Hz)
<i>ULU / F171</i>	Base frequency voltage 1, 2	230(V)	230(V)	230(V)	200(V)
<i>F127</i>	Sink/source switching	100 [Source logic] (Positive common) (Common : P24) 	0 [Sink logic] (Negative common) (Common : CC) 		
<i>F307</i>	Supply voltage correction (output voltage limitation)	2	2	2	3
<i>F417</i>	Motor rated speed	Refer to section 11.4			

3

3.2 Simplified Operation of the VF-nC3

Operation command and Operation frequency command are necessary to operate the inverter.

Operation method and operation frequency setting can be selected from the following.

At default setting, the inverter runs and stops with RUN/STOP key on the panel keypad, and frequency can be set with the setting dial.

Run / Stop

- : (1) Run and stop using the panel keypad
(2) Run and stop using external signals to terminal board

Setting the frequency

- : (1) Setting using setting dial
(2) Setting using external signals to terminal board (0-5V/0-10Vdc, 4-20mAdc)

Use the basic parameters $CnQd$ (command mode selection) $FnQd$ and (frequency setting mode selection) for selection.





[Parameter setting]

Title	Function	Adjustment range	Default setting
$CnQd$	Command mode selection	0: Terminal board 1: Panel keypad (including extension panel) 2: RS485 communication	1
$FnQd$	Frequency setting mode selection	0: Terminal board VI 1: Setting dial 1 (press in center to save) 2: Setting dial 2 (save even if power is off) 3: RS485 communication 4: - 5: UP/DOWN form external logic input	2

- When frequency setting by an extension panel option, $FnQd$ is set to 1 or 2.
- $FnQd=2$ (setting dial 2) is the mode where after the frequency is set by the setting dial, the frequency is saved even if the power is turned off.
- Refer to section 5.5 for details about $FnQd=3$ and 5.

3.2.1 How to run and stop

[Example of a $\text{C} \text{R} \text{O} \text{d}$ setting procedure]

Panel operation	LED display	Operation
	0.0	Displays the output frequency (operation stopped). (When standard monitor display selection $F \text{ ? } i \text{ ?} = 0$ [Output frequency])
	RUH	Displays the first basic parameter [History (RUH)].
	$\text{C} \text{R} \text{O} \text{d}$	Turn the setting dial, and select " $\text{C} \text{R} \text{O} \text{d}$ ".
	i	Press the center of the setting dial to read the parameter value. (Standard default: i).
	0	Turn the setting dial to change the parameter value to 0 (terminal block).
	$0 \leftrightarrow \text{C} \text{R} \text{O} \text{d}$	Press the center of the setting dial to save the changed parameter. $\text{C} \text{R} \text{O} \text{d}$ and the parameter set value are displayed alternately.

3

(1) Run and stop using the panel keypad ($\text{C} \text{R} \text{O} \text{d} = i$)

Use the **RUN** and **STOP** keys on the panel keypad to start and stop the motor.

RUN : Motor runs. **STOP** : Motor stops.

- ★ The direction of rotation is determined by the setting of parameter $F \text{ r}$ (forward run, reverse run selection). (0: forward run, 1: reverse run)
- ★ Forward run and reverse run are switchable with the extension panel (option). Set the parameter $F \text{ r}$ (forward run, reverse run selection) to 2 or 3. (Refer to section 5.7)

(2) RUN and STOP using external signals ($\text{C} \text{R} \text{O} \text{d} = 0$): Sink (Negative) logic

Use external signals to the inverter terminal board to start and stop the motor.

Short **F** and **CC** terminals: run forward

Open **F** and **CC** terminals: slow down and stop

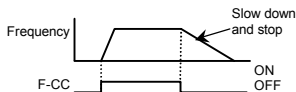

(3) Coast stop

Assign parameters as described below in case of Coast stop. Inverter will display $0.F.F$ at Coast stop.

- 1) Assign "5 (ST)" to an input terminal. Set parameter $F 1 ! 0 = 0$. Open the ST-CC for coast stop (see the status described on the right).
- 2) Assign "55 (FRR)" to an input terminal. Coast stop is done by shorting FRR and CC.

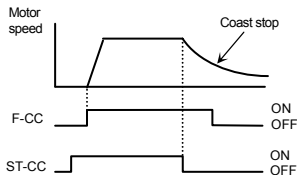

3.2.2 How to set the frequency

[Example of $F n Q d$ setting procedure] $F n Q d = 0$: Setting the frequency by the terminal VI

Panel operation	LED display	Operation
	0.0	Displays the output frequency (operation stopped). (When standard monitor display selection $F 7 ! 0 = 0$ [Output frequency])
	$R U H$	Displays the first basic parameter [History ($R U H$)].
	$F n Q d$	Turn the setting dial, and select " $F n Q d$ ".
	2	Press the center of the setting dial to read the parameter value. (Standard default: 2).
	0	Turn the setting dial to change the parameter value to 0 (terminal VI).
	$0 \Rightarrow F n Q d$	The parameter value is written. $F n Q d$ and the parameter value are displayed alternately several times.

- * Pressing the MODE key twice returns the display to standard monitor mode (displaying output frequency).

(1) Setting using the keypad or extension panel option ($F n Q d = 1$ or 2)



: Moves the frequency up



: Moves the frequency down

For an extension panel option, key moves the frequency up, key moves the frequency down.

■ Example of operating from the panel ($F n Q d = 1$: press in center to save)

Panel operation	LED display	Operation
	0.0	Displays the output frequency. (When standard monitor display selection $F 7 ! 0 = 0$ [Output frequency])
	$5 0 . 0$	Set the frequency command value. (The frequency will not be saved if the power is turned off in this state.)
	$5 0 . 0 \Rightarrow F \zeta$	Save the frequency command value. $F \zeta$ and the frequency are displayed alternately.

■ Example of operating from the panel ($F \uparrow \downarrow = 2$: save even if power is off)

Panel operation	LED display	Operation
	0.0	Displays the output frequency. (When standard monitor display selection $F \uparrow \downarrow = 0$ [Output frequency])
	60.0	Set the frequency command value.
-	60.0	The frequency will be saved even if the power is turned off in this state.

(2) Setting of frequency using external signals to terminal block ($FND=0$)

■ Frequency setting

1) Setting the frequency using external potentiometer

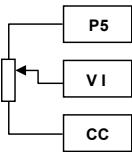

Setting frequency using potentiometer

Note) Set parameter $F109=3$.

★Potentiometer
Setting frequency using the potentiometer (1-10k Ω , 1/4W)
Refer to section 6.5.2 for detailed adjustment.

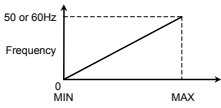

2) Setting the frequency using voltage input (0-10V)

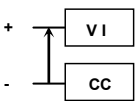

Voltage signal 0-10Vdc

Note) Set parameter $F109=0$.

★Voltage signal
Setting frequency using voltage signals (0-10V).
Refer to section 6.5.2 for detailed adjustment.

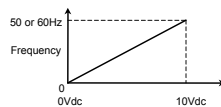

3) Setting the frequency using current input (4-20mA)

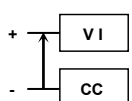

Current signal 4-20mAdc

* Setting of parameters also allow 0-20mAdc.
Note) Set parameter $F109=1$ and $F201=20$.

★Current Signal
Setting frequency using current signals (4-20mA).
Refer to section 6.5.2 for detailed adjustment.

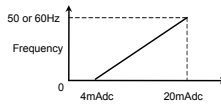

4) Setting the frequency using voltage input (0-5V)

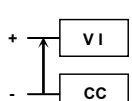

Voltage signal 0-5Vdc

Note) Set parameter $F109=3$.

★Voltage signal
Set the frequency using voltage signals (0-5V).
Refer to section 6.5.2 for detailed adjustment.

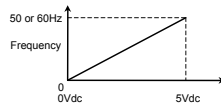

3.3 How to operate the VF-nC3

Overview of how to operate the inverter with simple examples.

Ex.1 Operation Command: Panel Operation Frequency Command: Setting Dial 1

(1) Wiring

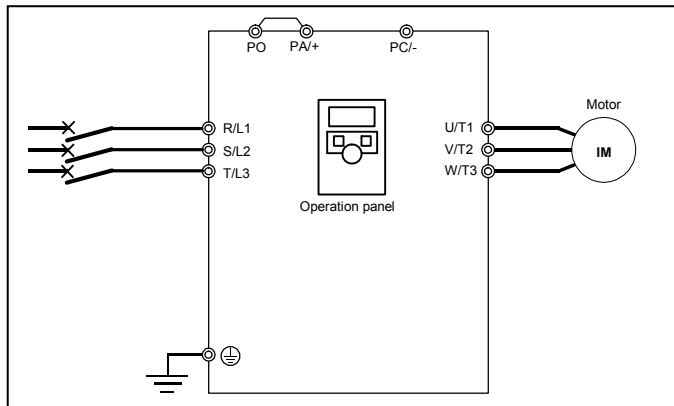

(2) Parameter setting (default setting)

Title	Function	Programmed value
<i>F n d</i>	Command mode selection	1
<i>F n d</i>	Frequency setting mode selection	2

(3) Operation

Run/stop: Press the and keys on the panel.

Frequency setting: Turn the setting dial to set the frequency. The frequency setting is saved just by turning the setting dial.

Ex.2 Operation Command: Panel Operation Frequency Command: Setting Dial 2

(1) Wiring

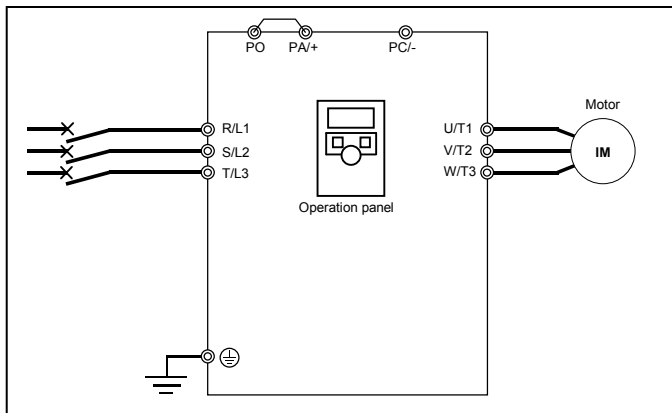

(2) Parameter setting

Title	Function	Programmed value
$\overline{F} \overline{0} \overline{0} \overline{d}$	Command mode selection	1
$\overline{F} \overline{1} \overline{0} \overline{d}$	Frequency setting mode selection	1

(3) Operation

Run/stop: Press the **RUN** and **STOP** keys on the panel.

Frequency setting: Turn the setting dial to set the frequency.

To save the frequency setting, press the center of the setting dial.

$\overline{F} \overline{1}$ and the set frequency will flash on and off alternately.

Ex.3 Operation Command: External Signal
Frequency Command: Setting Dial

(1) Wiring

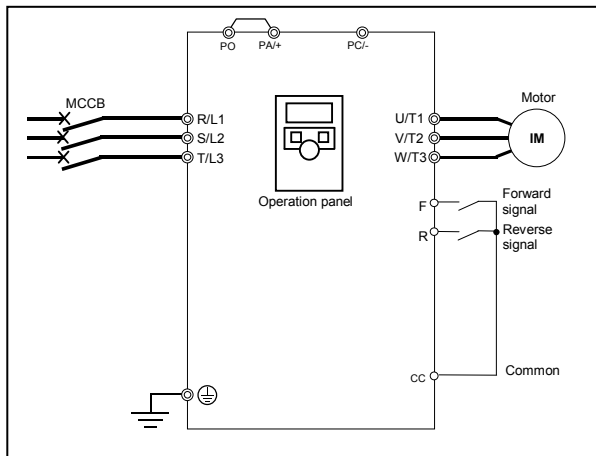

(2) Parameter setting

Title	Function	Programmed value
<i>Cmd</i>	Command mode selection	0
<i>Frd</i>	Frequency setting mode selection	1 or 2

(3) Operation

Run/stop: ON/OFF input to F-CC, R-CC. (with sink logic)
Frequency setting: Turn the setting dial to set the frequency.

Ex.4 Operation Command: External Signal Frequency Command: External Analog Signal

(1) Wiring

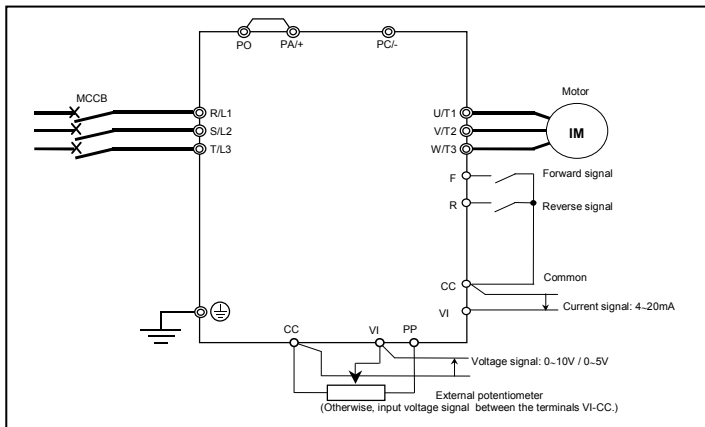

(2) Parameter setting

Title	Function	Programmed value
<i>F 0 0 d</i>	Command mode selection	0
<i>F 0 0 d</i>	Frequency setting mode selection	0

(3) Operation

Run/stop: ON/OFF input to F-CC, R-CC. (with sink logic)

Frequency setting: VI: Input 0-10Vdc (external potentiometer) or 4-20mAadc to set the frequency.

* Set the voltage/current input of VI in parameter *F 1 0 9*.

0: Voltage signal input (0-10V)

1: Current signal input (4-20mA)

3: Voltage signal input (0-5V), when the P5 terminal is connected and the external potentiometer is used

3.4 Meter setting and adjustment

FNSL: Meter selection

FN: Meter adjustment gain

- Function
Output of 0 - 1mAdc, 0 (4) - 20mAdc, 0 - 10vdc can be selected for the output signal from the FM terminal, depending on the *FGB* setting. Adjust the scale at *FN*.
Use an ammeter with a full-scale 0 - 1mAdc meter.
The *FGB* (analog output bias) needs to be adjusted if output is 4 - 20mAdc.

[Parameter setting]

Title	Function	Adjustment range	Supposition output at <i>FNSL = 17</i>	Default setting
<i>FNSL</i>	Meter selection	0: Output frequency 1: Output current 2: Frequency command value 3: Input voltage (DC detection) 4: Output voltage (command value) 5 to 11: - 12: Stator frequency 13: VI input value 14: - 15: Fixed output 1 (output current 100% equivalent) 16: Fixed output 2 (output current 50% equivalent) 17: Fixed output 3 (other than the output current) 18: RS485 communication data 19: For adjustments (<i>FN</i> set value is displayed.) 20 to 22: -	Maximum frequency (<i>FH</i>) - Maximum frequency (<i>FH</i>) 1.5x rated voltage 1.5x rated voltage - Maximum frequency (<i>FH</i>) - Maximum input value - - - - Maximum value (100.0%) - -	0
<i>FN</i>	Meter adjustment gain	-	-	-

- Resolution
All FM terminals have a maximum of 1/255.
- Example of 4-20mA output adjustment (Refer to section 6.17.2 for details)

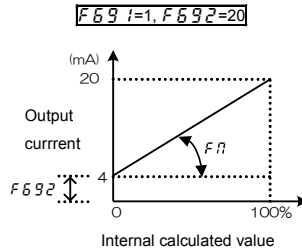
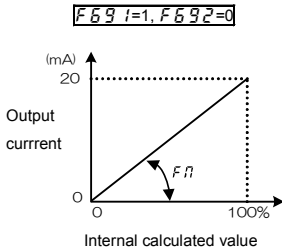

- Note 1) When using the FM terminal for current output, be sure that the external load resistance is less than 750Ω. Use at over 1kΩ external load resistance, if used for voltage output.
- Note 2) $F695L = I2$ is the motor drive frequency.

- Adjustment scale with parameter $F69$ (Meter adjustment)
Connect meters as shown below.

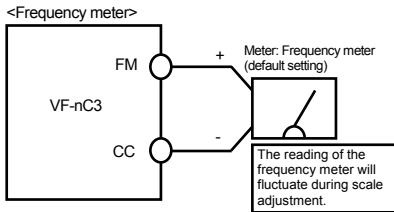



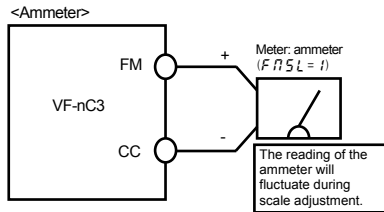



* Optional QS6T frequency meter is available.



* Ammeter with a maximum scale of 1.5x the inverter's rated output is recommended.

[Example of how to adjustment the FM terminal frequency meter]

* Use the meter's adjustment screw to pre-adjust zero-point.

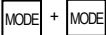
Operation panel action	LED display	Operation
-	60.0	Displays the output frequency. (When standard monitor display selection $F71Q=0$ [Output frequency])
	RUH	The first basic parameter "RUH" (history function) is displayed.
	FN	Turn the setting dial to select FN.
	60.0	Output frequency can be read by pressing the center of the setting dial.
	60.0	Turn the setting dial to adjust the meter. Note that the meter's indicator changes at this time, but the inverter's display (monitor) does not change. 
	60.0 ⇄ FN	Press the center of the setting dial to save the meter's calibrations. FN and the frequency are displayed alternately.
	60.0	The display returns to its original indications. (When standard monitor display selection $F71Q=0$ [Output frequency])

■ Adjusting the meter in inverter stop state

- Adjustment of output current ($FN5L = I$)

If, when adjusting the meter for output current, there are large fluctuations in data during adjustment, making adjustment difficult, the meter can be adjusted in inverter stop state.

When setting $FN5L$ to 15 for fixed output 1 (output current 100% equivalent), a signal of absolute values will be output (inverter's rated current = 100%). In this state, adjust the meter with the FN (Meter adjustment) parameter.

Similarly, if you set $FN5L$ to 16 for fixed output 2 (output current 50% equivalent), a signal that is sent out when half the inverter's rated current is flowing will be output through the FM terminal.

After meter adjustment is ended, set $FN5L$ to I (output current).

- Other adjustments ($FN5L = 0, 2 - 4, 12, 13, 18$)

$FN5L = 17$: When fixed output 3 (other than the output current) is set, a signal of the the value for other monitors is fixed at the following values and output through the FM terminal.

100% standard value for each item is the following:

$FN5L = 0, 2, 12$: Maximum frequency (FH)

$FN5L = 3, 4$: 1.5 times of rated voltage

$FN5L = 13$: Maximum input value (5V, 10V, or 20mA)

$FN5L = 18$: Maximum value (1000)

3.5 Setting the electronic thermal

EHr : Motor electronic-thermal protection level 1

OLn : Electronic-thermal protection characteristic selection

F173 : Motor electronic-thermal protection level 2

F607 : Motor 150% overload detection time

F632 : Electronic-thermal memory

- Function

This parameter allows selection of the appropriate electronic thermal protection characteristics according to the particular rating and characteristics of the motor.

[Parameter setting]

Title	Function	Adjustment range				Default setting
EHr	Motor electronic-thermal protection level 1	10 – 100 (%) / (A) *1				100
OLn	Electronic-thermal protection characteristic selection	Setting value	Standard motor	Overload protection	Overload stall	0
		0		valid	invalid	
		1		valid	valid	
		2		invalid	invalid	
		3	VF motor (special motor)	invalid	valid	
		4		valid	invalid	
		5		valid	valid	
		6		invalid	invalid	
7	invalid	valid				
F173	Motor electronic-thermal protection level 2	10 – 100 (%) / (A) *1				100
F607	Motor 150% overload detection time	10 – 2400 (s)				300
F632	Electronic-thermal memory	0: Disabled 1: Enabled *2				0

*1: The inverter's rated current is 100%. When **F707** (current and voltage unit selection) = 1 (A (amps)/V (volts)) is selected, it can be set at A (amps).

*2: The thermal status (overload totaling level) of the inverter or motor is saved when the power is turned off, and is calculated when the power is turned on from the off status.

- 1) Setting the electronic thermal protection characteristics selection $\boxed{0L1}$ and motor electronic thermal protection level 1 \boxed{tHr} , 2 $\boxed{F173}$

The electronic thermal protection characteristics selection $\boxed{0L1}$ is used to enable or disable the motor overload trip function ($\boxed{0L2}$) and the overload stall function.

While the inverter overload trip ($\boxed{0L1}$) will be in constant detect operation, the motor overload trip ($\boxed{0L2}$) can be selected using the parameter $\boxed{0L1}$.

Explanation of terms

Overload stall: This is an optimum function for equipment such as fans, pumps and blowers with variable torque characteristics that the load current decreases as the operating speed decreases.

When the inverter detects an overload, this function automatically lowers the output frequency before the motor overload trip $\boxed{0L2}$ is activated. With this function, operation can be continued, without tripping, by operating using a frequency balanced by load current.

Note: Do not use the overload stall function with loads having constant torque characteristics (such as conveyor belts in which load current is fixed with no relation to speed).

[Using standard motors (other than motors intended for use with inverters)]

When a motor is used in the lower frequency range than the rated frequency, that will decrease the cooling effects for the motor. This speeds up the start of overload detection operations when a standard motor is used in order to prevent overheating.

■ Setting of electronic thermal protection characteristics selection $\boxed{0L1}$

Setting value	Overload protection	Overload stall
$\boxed{0}$	valid	invalid
$\boxed{1}$	valid	valid
$\boxed{2}$	invalid	invalid
$\boxed{3}$	invalid	valid

■ Setting of motor electronic thermal protection level 1 \boxed{tHr} (Same as $\boxed{F173}$)

When the capacity of the motor in use is smaller than the capacity of the inverter, or the rated current of the motor is smaller than the rated current of the inverter, adjust thermal protection level 1 \boxed{tHr} for the motor in accordance with the motor's rated current.

* When displaying as a percentage, 100% = rated output current (A) of the inverter is displayed.

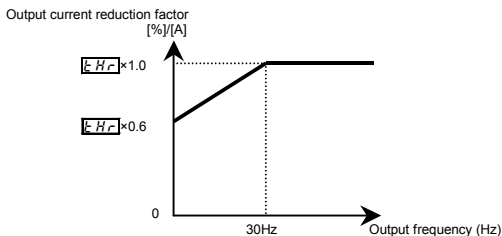

Note: The motor overload protection start level is fixed at 30Hz.

[Example of setting: When the VFNC3-2007P is running with a 0.4kW motor having 2A rated current]

Operation panel action	LED display	Operation
	0.0	Displays the output frequency. (Perform during operation stopped.) (When standard monitor display selection $F7: I0=0$ [Output frequency])
	RUH	The first basic parameter "RUH" (history function) is displayed.
	I_r	Turn the setting dial to change the parameter to I_r .
	100	Parameter values can be read by pressing the center of the setting dial (default setting is 100%).
	48	Turn the setting dial to change the parameter to 48% (= motor rated current/inverter output rated current $\times 100 = 2.0/4.2 \times 100$)
	$48 \leftrightarrow I_r$	Press the center of the setting dial to save the changed parameter. I_r and the parameter are displayed alternately.

Note: The rated output current of the inverter should be calculated from the rated current for frequencies below 4kHz, regardless of the setting of the PWM carrier frequency parameter ($F300$).

[Using a VF motor (motor for use with inverter)]

■ Setting of electronic thermal protection characteristics selection 0 L N

Setting value	Overload protection	Overload stall
4	valid	invalid
5	valid	valid
6	invalid	invalid
7	invalid	valid

VF motors (motors designed for use with inverters) can be used in frequency ranges lower than those for standard motors, but their cooling efficiency decreases at frequencies below 6Hz.

■ Setting of motor electronic thermal protection level 1 \boxed{LHr} (Same as $\boxed{F17}$)

If the capacity of the motor is smaller than the capacity of the inverter, or the rated current of the motor is smaller than the rated current of the inverter, adjust the electronic thermal protection level 1 LHr so that it fits the motor's rated current.

* If the indications are in percentages (%), then 100% equals the inverter's rated output current (A).

Output current reduction factor [%][A]

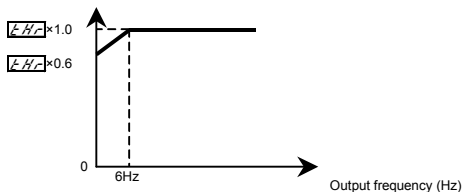

Note) The start level for motor overload reduction is fixed at 6 Hz.

2) Motor 150%-overload time $\boxed{F507}$

Parameter $F507$ is used to set the time elapsed before the motor trips under a load of 150% (overload trip $UL2$) within a range of 10 to 2400 seconds.

3) Inverter overload characteristics

Set to protect the inverter itself. The setting of this parameter cannot be turned off.

When an inverter overload trip ($UL1$) operates, operation can be improved by lowering stall operating level $F501$, or increasing acceleration time ACC and deceleration time DEC .

Inverter overload

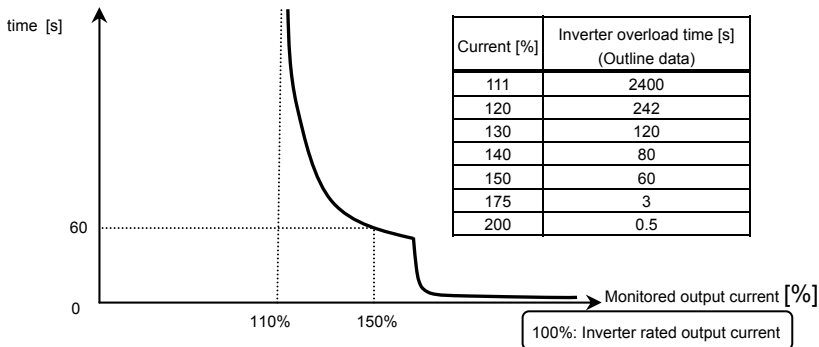

Inverter overload protection characteristic

Note1 : At extremely low speeds of lower than 1 Hz, an overload trip ($\overline{OL} 3$) occurs in a short period of time to protect the inverter.

Note2 : At over 150%, an overload trip ($\overline{OL} 1$) occurs in a short period of time to protect the inverter.

4) Electronic thermal memory $\overline{F632}$

When the power is OFF, it is possible to reset or maintain the overload totaling level.

This parameter's settings are applied both to the motor's electronic thermal memory and the electronic thermal memory for inverter protection.

[Parameters settings]

Title	Function	Adjustment range	Default setting
$\overline{F632}$	Electronic thermal memory	0: Disabled 1: Enabled	0

※ $\overline{F632} = 1$ is a function for complying with the U.S. NEC standards.

3.6 Preset-speed operation (speeds in 15 steps)

$5r1$ - $5r7$: Preset-speed frequency 1-7

$F287$ - $F294$: Preset-speed frequency 8-15

- Function
A maximum of 15 speed steps can be selected just by switching an external logic signal. Multi-speed frequencies can be programmed anywhere from the lower limit frequency L_L to the upper limit frequency U_L .

[Setting method]

1) Run/stop

The starting and stopping control is done from the terminal board.

Title	Function	Adjustment range	Setting
$Fn0d$	Command mode selection	0: Terminal board 1: Panel keypad (including extension panel) 2: RS485 communication	0

Note: When switching between preset-speed operation and other speed commands (analog signal, setting dial, communication, etc.), select the frequency setting mode at $Fn0d$. ⇒ Refer to section 3) or 5.5.

2) Preset-speed frequency setting

Set the speed (frequency) of the number of steps necessary.

[Parameter setting]

Setting from speed 1 to speed 7

Title	Function	Adjustment range	Default setting
$5r1$ - $5r7$	Preset-speed frequency 1-7	L_L - U_L (Hz)	0.0

Setting from speed 8 to speed 15

Title	Function	Adjustment range	Default setting
$F287$ - $F294$	Preset-speed frequency 8-15	L_L - U_L (Hz)	0.0

Preset-speed logic input signal example: $F \ 1 \ 2 \ 7$ (sink/source switching) = \square : With sink settings
 O: ON - : OFF (Speed commands other than preset-speed commands are valid when all are OFF)

Terminal	Preset-speed														
	1	2	3	4	5	6	7	8	9	10	11	12	13	14	15
S1-CC	○	-	○	-	○	-	○	-	○	-	○	-	○	-	○
S2-CC	-	○	○	-	-	○	○	-	-	○	○	-	-	○	○
R-CC	-	-	-	○	○	○	○	-	-	-	-	○	○	○	○
VI-CC	-	-	-	-	-	-	-	○	○	○	○	○	○	○	○

★ Terminal functions are as follows.

- Terminal S1Input terminal function selection 3A (S1)
 $F \ 1 \ 3 = 1 \square$ (Preset-speed command 1: SS1)
- Terminal S2Input terminal function selection 4A (S2)
 $F \ 1 \ 4 = 1 \square$ (Preset-speed command 2: SS2)
- Terminal RInput terminal function selection 2A (R)
 $F \ 1 \ 2 = 1 \square$ (Preset-speed command 3: SS3)
- Terminal VI
 - Analogue/ logic input selection (VI)
 - $F \ 1 \ 9 = 2$ (logic input)
 - Input terminal function selection 5 (VI)
 - $F \ 1 \ 5 = 1 \square$ (preset-speed command 4: SS4)

★ In the default settings, SS3 and SS4 are not assigned. Assign SS3 and SS4 to R and VI with input terminal function selection. VI terminal must also be set for switching to logic input.

[Example of a connection diagram]
 (with sink settings)

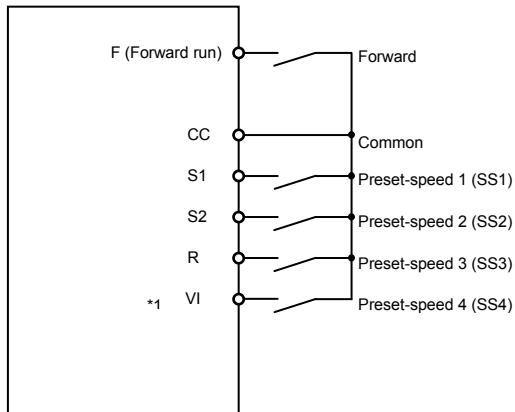

*1: When VI terminal is used for the logic input terminal, refer to page B-12 for details.

3) Using other speed commands with preset-speed command

Command mode selection <i>C P Q d</i>		0: Terminal board			1: Panel keypad (including extension panel), 2: RS485 communication		
Frequency setting mode selection <i>F P Q d</i>		0: Terminal board VI 5: UP/DOWN from external logic input	1: Setting dial 1 (press in center to save) 2: Setting dial 2 (save even if power is off)	3: RS485 communication	0: Terminal block VI 5: UP/DOWN from external logic input	1: Setting dial (press in center to record) 2: Setting dial	3: RS485 communication
Preset-speed command	Active	Preset-speed command valid			Terminal command valid	Setting dial command valid	Communication command valid
	Inactive	Terminal command valid	Setting dial command valid	Communication command valid	(The inverter doesn't accept Preset-speed command.)		

Note) The preset-speed command is always given priority when other speed commands are input at the same time.

An example of three-speed operation with the default settings is shown below. (Frequency settings are required for $f_r 1$ to 3)

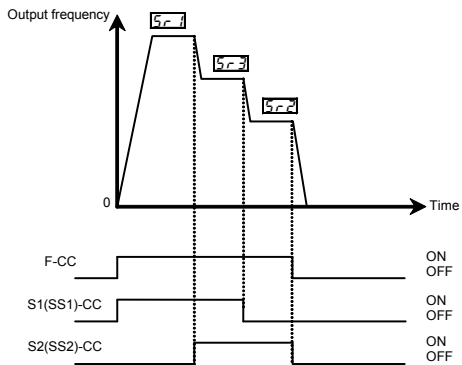

Example of 3-speed operation

4. Setting parameters

4.1 Setting and Display Modes

The VF-nC3 has the following three display modes.

Standard monitor mode

The standard inverter mode. This mode is enabled when inverter power goes on.

This mode is for monitoring the output frequency and setting the frequency reference value. If also displays information about status alarms during running and trips.

- Display of output frequency, etc.
 - $F 7 1 0$ Initial panel display selection
 - $(F 7 2 0)$ Initial extension panel display selection)
 - $F 7 0 2$ Free unit display scale
- Setting frequency reference values.
- Status alarm and trip

If there is an error in the inverter, the alarm signal or the trip signal be displayed in the LED display.

Setting monitor mode

The mode for setting inverter parameters.

⇒ How to set parameters, refer to section 4. 2.

There are two parameter read modes. Refer to section 4. 2 for details about selection and switching of modes.

Easy setting mode : Only the seven most frequently used parameters are displayed.

Parameters can be registered as necessary. (max. 24 parameters)

Standard setting mode : Both basic and extended all parameters are displayed.

☆ Each press of the EASY key switches between the Easy setting mode and the Standard setting mode.

Status monitor mode

The mode for monitoring all inverter status.

Allows monitoring of set frequencies, output current/voltage and terminal information.

⇒ Refer to chapter 8.

The inverter can be moved through each of the modes by pressing the MODE key.

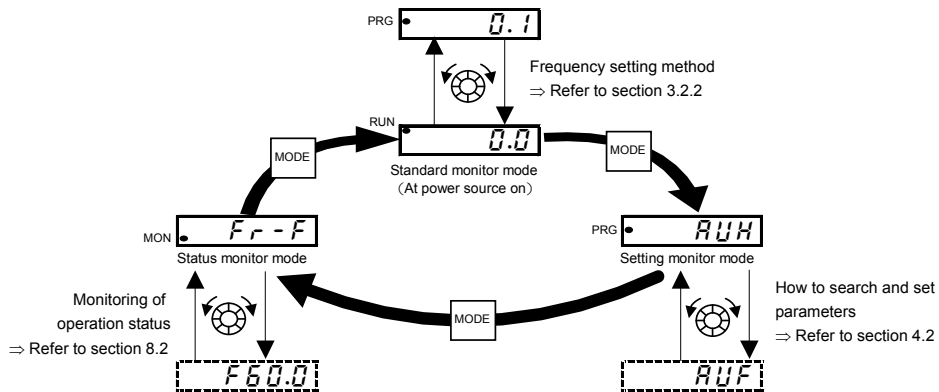

4.2 How to set parameters

There are two types of setting monitor modes: Easy mode and Standard setting mode. The mode active when power is turned on can be selected at $PSE L$ (EASY key mode selection), and the mode can be switched by the EASY key. Note, however, that the switching method differs when only the Easy mode is selected. Refer to section 4.5 for details.

Setting dial and panel key operations are as follows:



Turning the setting dial
Used to select items and incrementing/
decrementing values. Note)



Pressing the center of the setting dial
Used for executing operations and determining
values. Note)



Used to select the mode and return to
the previous menu



Used to switch between the Easy and Standard
setting modes.
Each press alternately switches between the two
modes in the standard monitor mode.

Easy setting mode

: The mode changes to the Easy setting mode when the EASY key is pressed and "E R S Y" is displayed. Only the most frequently used 7 basic parameters are displayed. (standard default)

Easy setting mode

Title	Function
$C N D$	Command mode selection
$F N D$	Frequency setting mode selection
$R C C$	Acceleration time 1
$d E C$	Deceleration time 1
$t H r$	Motor overload protection level 1
$F N$	Meter adjustment
$P S E L$	EASY key mode selection

- ☆ In the Easy setting mode, the PRG lamp blinks.
- ☆ If the EASY key is pressed while the setting dial is being turned, values continue to be incremented or decremented even if you release your finger from the setting dial.
This feature is handy when setting large values.

Note) Of the available parameters, number value parameters ($R C C$ etc.) are reflected in actual operation when the setting dial is turned. Note, however, that the center of the setting dial must be pressed to save values even when the power is turned off.

Note, also, that item selection parameters ($F N D$ etc.) are not reflected in actual operation by just turning the setting dial. To reflect these parameters, press the center of the setting dial.

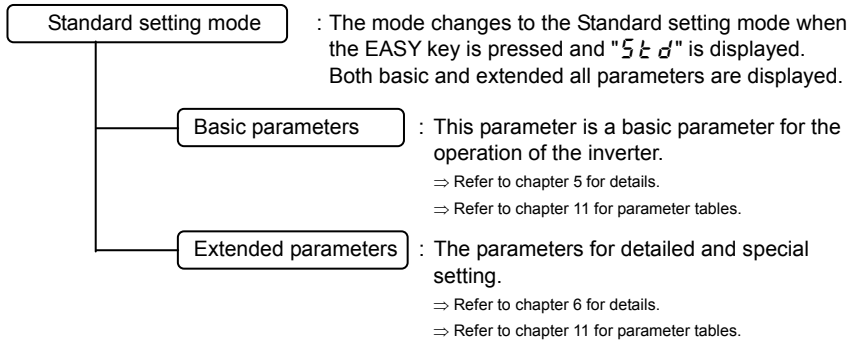

Note) Refer to section 11.8 for unchangeable parameters in running.

4.2.1 Settings in the Easy setting mode

The inverter enters this mode by pressing the MODE key when the Easy setting mode is selected

When you are unsure of something during operation:
You can return to the Standard monitor mode by pressing the MODE key several times.

Easy setting mode (Default registered parameters)

Title	Function
<i>CNOd</i>	Command mode selection
<i>FNOd</i>	Frequency setting mode selection
<i>ACC</i>	Acceleration time 1
<i>dEC</i>	Deceleration time 1
<i>tHr</i>	Motor overload protection level 1
<i>FN</i>	Connection meter adjustment
<i>PSEL</i>	EASY key mode selection

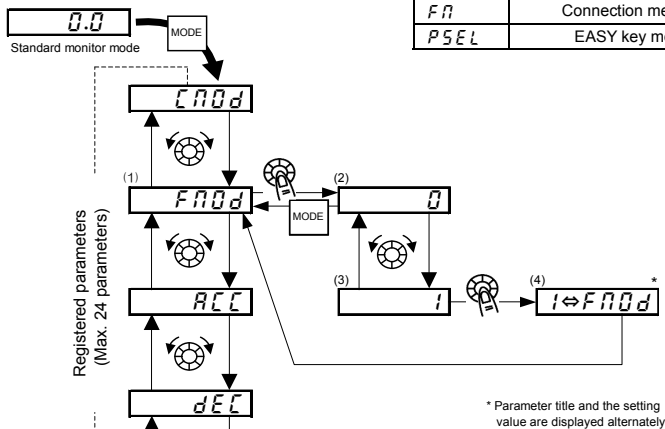

■ Setting parameters in the Easy setting mode

- (1) Selects parameter to be changed. (Turn the setting dial.)
- (2) Reads the programmed parameter setting. (Press the center of the setting dial.)
- (3) Change the parameter value. (Turn the setting dial.)
- (4) Press this key to save the change. (Press the center of the setting dial.)

☆ To switch to the Standard setting mode, press the EASY key in the Standard monitor mode. "5 t d" is displayed, and the mode is switched.

4.2.2 Settings in the Standard setting mode

The inverter enters this mode by pressing the MODE key when the Standard setting mode is selected.

When you are unsure of something during operation:
You can return to the Standard setting mode by pressing the MODE key several times.

■ How to set basic parameters

- (1) Selects parameter to be changed. (Turn the setting dial.)
- (2) Reads the programmed parameter setting. (Press the center of the setting dial.)
- (3) Change the parameter value. (Turn the setting dial.)
- (4) Press this key to save the change. (Press the center of the setting dial.)

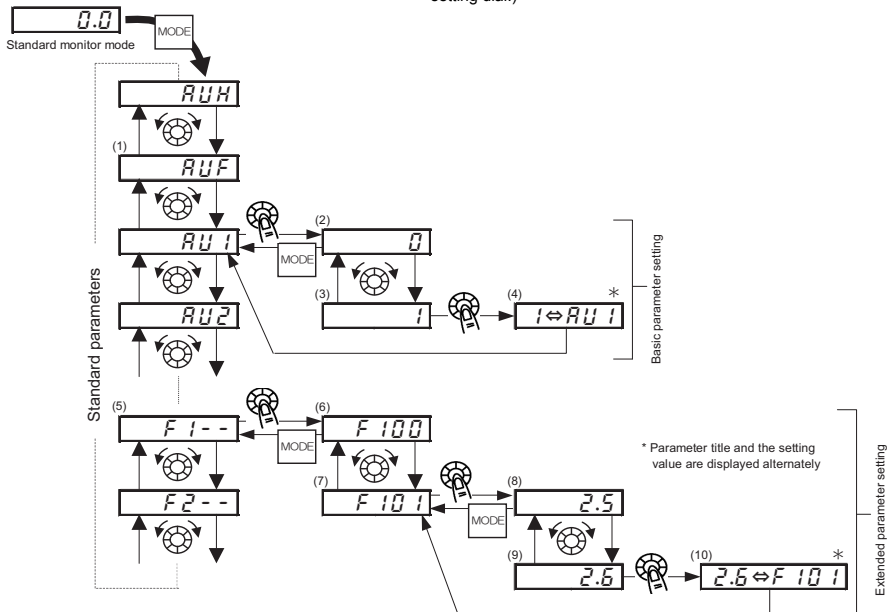

☆ To switch to the Easy setting mode, press the EASY key in the Standard monitor mode. *EASY* is displayed, and the mode is switched.

■ How to set extended parameters

Each extended parameter is composed of an "F"suffixed with a 3-digit figure, so first select and read out the heading of the parameter you want "F 1 - -" to "F 8 - -". ("F 1 - -": Parameter starting point is 100, "F 8 - -": Parameter starting point is 800.)

- (5) Select the title of the parameter you want to change. (Turn the setting dial.)
- (6) Press the Enter key to activate the selected parameter. (Press the center of the setting dial.)
- (7) Selects parameter to be changed. (Turn the setting dial.)
- (8) Reads the programmed parameter setting. (Press the center of the setting dial.)
- (9) Change the parameter value. (Turn the setting dial.)
- (10) Press this key to save the change. (Press the center of the setting dial.)

■ Adjustment range and display of parameters

H I: An attempt has been made to assign a value that is higher than the programmable range. (Note that the setting of the currently selected parameter may exceed the upper limit as a result of changing other parameters.)

L O: An attempt has been made to assign a value that is lower than the programmable range. (Note that the setting of the currently selected parameter may fall below the lower limit as a result of changing other parameters.)

If the above alarm is flashing on and off, values that exceed **H I** or are equal or lower than **L O** cannot be set.

4

4.3 Functions useful in searching for a parameter or changing a parameter setting

This section explains functions useful in searching for a parameter or changing a parameter setting. To use these functions, a parameter needs to be selected or set in advance.

Changed parameters history search (History function) **RUH**

This function automatically searches for the last five parameters whose settings have been changed. To use this function, select the **RUH** parameter. (Any changes are displayed regardless of whether or not they are the same as standard defaults.)

The parameters set by communication option or RS485 communication are not searched and not displayed.

⇒ Refer to section 5.1 for details.

Set parameters by purpose (Guidance function) **RUF**

Only parameters required for a special purpose can be called up and set.

To use this function, select parameter **RUF**

⇒ Refer to section 5.2 for details.

Reset parameters to default settings $\boxed{E\ Y\ P}$

Use the $E\ Y\ P$ parameter to reset all parameters back to their default settings. To use this function, set parameter $E\ Y\ P=3$ or 13 .

⇒ Refer to section 4.3.2 for details.

Call saved customer settings $\boxed{E\ Y\ P}$

Customer settings can be batch-saved and batch-called. These settings can be used as customer-exclusive default settings. To use this function, set parameter $E\ Y\ P=7$ or 8 .

⇒ Refer to section 4.3.2 for details.

Search changed parameters $\boxed{G\ r\ U}$

Automatically searches for only those parameters that are programmed with values different from the standard default setting. To use this function, select the $G\ r\ U$ parameter.

⇒ Refer to section 4.3.1 for details.

4.3.1 Searching for and resetting changed parameters

$\boxed{G\ r\ U}$: Automatic edit function

• Function









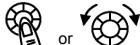

Automatically searches for only those parameters that are programmed with values different from the standard default setting and displays them in the $G\ r\ U$. Parameter setting can also be changed within this group.

Note 1: If you reset a parameter to its factory default, the parameter will no longer appear in $G\ r\ U$.

Note 2: It may take several seconds to display changed parameters because all data stored in the user parameter group $G\ r\ U$ is checked against the factory default settings. To cancel a parameter search, press the MODE key.

Note 3: Parameters which cannot be reset to the default setting after setting $E\ Y\ P$ to 3 are not displayed.
⇒ Refer to section 4.3.2 for details.

■ How to search and reprogram parameters

Panel operation	LED display	Operation
	<i>0.0</i>	Displays the output frequency (operation stopped). (When standard monitor display selection <i>F 7 ! 0=0</i> [Output frequency])
	<i>R U H</i>	Displays the first basic parameter "History function (<i>R U H</i>)."
	<i>U r U</i>	Turn the setting dial, and select <i>U r U</i> .
	<i>U - -</i>	Press the center of the setting dial to enter the user parameter setting change search mode.
	<i>R C C</i>	Searches for and displays parameters different to the default settings. Parameters are changed by either pressing the center of the setting dial or turning it to the right. (Turning the setting dial to the left searches for parameter in the reverse direction.)
	<i>8.0</i>	Press the center of the setting dial to display set values.
	<i>5.0</i>	Turn the setting dial, and change set values.
	<i>5.0 ↔ R C C</i>	Press the center of the setting dial to set values. The parameter name and set value light alternately and are written.
	<i>U - - F</i> (<i>U - - r</i>)	Use the same steps as those above and turn the setting dial to display parameters to search for or whose settings must be changed, and check or change the parameter settings.
	<i>U r U</i>	When <i>U r U</i> appears again, the search is ended.
  	Parameter display ↓ <i>U r U</i> ↓ <i>F r - F</i> ↓ <i>0.0</i>	A search can be canceled by pressing the MODE key. Press the key once while the search is underway to return to the display of parameter setting mode. Pressing it while searching returns to the <i>U r U</i> display. After that you can press the MODE key to return to the status monitor mode or the standard monitor mode (display of output frequency).

4.3.2 Return to default settings

Ⓔ Ⓐ Ⓟ : Default setting

- Function

It is possible to return groups of parameters to their defaults, clear run times, and record/recall set parameters.

[Parameter setting]

Title	Function	Adjustment range	Default setting
Ⓔ Ⓐ Ⓟ	Default setting	0: - 1: 50Hz default setting 2: 60Hz default setting 3: Default setting 1 (Initialization) 4: Trip record clear 5: Cumulative operation time clear 6: Initialization of type information 7: Save user setting parameters 8: Load user setting parameters 9: Cumulative fan operation time record clears 10 to 12: - 13: Default setting 2 (complete initialization)	0

★ This function will be displayed as 0 during reading on the right. This previous setting is displayed on the left.

Example: **Ⓔ Ⓐ Ⓟ**

★ Ⓔ Ⓐ Ⓟ cannot be set during the inverter operating. Always stop the inverter first and then program.

Programmed value

50 Hz default setting (Ⓔ Ⓐ Ⓟ = 1)

Setting Ⓔ Ⓐ Ⓟ to 1 sets the following parameters for base frequency 50 Hz use.

(The setting values of other parameters are not changed.)

- | | | | |
|--|--------|-------------------------------|--------------------------|
| • Max. frequency (F H) | : 50Hz | • Upper limit frequency (U L) | : 50Hz |
| • Base frequency 1 (ω L) | : 50Hz | • Base frequency 2 (F 1 7 0) | : 50Hz |
| • V1 input point 2 frequency (F 2 0 4) | : 50Hz | • Motor rated RPM (F 4 1 7) | : 1410 min ⁻¹ |

60 Hz default setting (Ⓔ Ⓐ Ⓟ = 2)

Setting Ⓔ Ⓐ Ⓟ to 2 sets the following parameters for base frequency 60 Hz use.

(The setting values of other parameters are not changed.)

- | | | | |
|--|--------|-------------------------------|--------------------------|
| • Max. frequency (F H) | : 60Hz | • Upper limit frequency (U L) | : 60Hz |
| • Base frequency 1 (ω L) | : 60Hz | • Base frequency 2 (F 1 7 0) | : 60Hz |
| • V1 input point 2 frequency (F 2 0 4) | : 60Hz | • Motor rated RPM (F 4 1 7) | : 1710 min ⁻¹ |

Default setting 1 ($\text{tYP} = 3$)

Setting tYP to 3 will return parameters to the standard values that were programmed at the factory.

☆ When 3 is set, [InIk] is displayed for a short time after the settings are configured, and then disappears. Then the inverter is in standard motor mode. In this case, the trip history data is cleared.

Be aware that the following parameters do not return to the standard factory settings even if $\text{tYP} = 3$ is set for maintainability. (To initialize all parameters, set $\text{tYP} = 13$.)

- $F75L$: Meter selection
- $F7A$: Meter adjustment gain
- SEt □: Checking the region setting
- $F109$: Analog/logic input selection (VI terminal)
- $F127$: Sink/source switching
- $F470$: VI input bias
- $F471$: VI nput gain
- $F659$: Logic output/pulse train output selection (OUT-NO)
- $F6B1$: Analog output signal selection
- $F691$: Inclination characteristic of analog output
- $F692$: Analog output bias
- $F693$: Factory specific coefficient 6D
- $F880$: Free notes

Trip record clear ($\text{tYP} = 4$)

Setting tYP to 4 initializes the past four sets of recorded error history data.

☆ The parameter does not change.

Cumulative operation time clear ($\text{tYP} = 5$)

Setting tYP to 5 resets the cumulative operation time to the initial value (zero).

Initialization of type information ($\text{tYP} = 6$)

Setting tYP to 6 clears the trips when an $E\text{tYP}$ format error occurs. But if the $E\text{tYP}$ displayed, call us.

Save user setting parameters ($\text{tYP} = 7$)

Setting tYP to 7 saves the current settings of all parameters. (Refer to section 4.2.7)

Load user setting parameters ($\text{tYP} = 8$)

Setting tYP to 8 loads parameter settings to (calls up) those saved by setting tYP to 7. (Refer to section 4.2.7)

☆ By setting tYP to 7 or 8, you can use parameters as your own default parameters.

Cumulative fan operation time record clear ($\text{tYP} = 9$)

Setting tYP to 9 resets the cumulative operation time to the initial value (zero).

Set this parameter when replacing the cooling fan, and so on

Default setting 2 ($\text{tYP} = 13$)

Set tYP to 13 to return all parameters to their default settings.

When 13 is set, [InIk] is displayed for a short time after the settings are configured, and then disappears. Then setup menu SEt is displayed. After reviewing the setup menu items, make a setup menu selection. In this case, all parameters are returned to their defaults, and the trip history data is cleared. (Refer to section 3.1.)

4.4 Checking the region settings selection

5 E L: Checking the region setting

- Function

The region selected on the setup menu can be checked.

Also, the setup menu can be started to change to a different region.

[Parameter setting]

Title	Function	Adjustment range	Default setting
5 E L	Checking the region setting	0: Start setup menu 1: Japan (read only) 2: North America (read only) 3: Asia (read only) 4: Europe (read only)	*

* Default setting values vary depending on the setup menu setting. Refer to section 11.5. 1 to 4 are displayed.

- Content of region settings

The number displayed when parameter 5 E L is read indicates which of the following regions was selected on the setup menu.

1: J P (Japan) is selected on the setup menu.

2: U S A (North America) is selected on the setup menu.

3: R S I A (Asia, Oceania) is selected on the setup menu.

4: E U (Europe) is selected on the setup menu.

The setup menu is started by writing 5 E L = 0.

Refer to section 3.1 for details.

Note: 1 to 4 set to parameter 5 E L are read-only. Be aware that they cannot be written.

4.5 EASY key function

PSEL : EASY key mode selection

F751 - **F774** : Easy setting mode parameter 1 to 24

• **Function**

It is possible to switch between standard mode and easy setting mode using the EASY key.
Up to 24 arbitrary parameters can be registered to easy setting mode.

[Parameter setting]

Title	Function	Adjustment range	Default setting
PSEL	EASY key mode selection	0: Standard setting mode at power on 1: Easy setting mode at power on 2: Easy setting mode only	0

It is possible to switch between standard mode and easy setting mode using the EASY key.
The way parameters are read out and displayed varies according to the mode selected.

Easy setting mode

Allows pre-registration (easy setting mode parameters) of frequently changed parameters and reading of only registered parameters (maximum of 24 types).

Standard setting mode

Standard setting mode in which all parameters are read out.

[How to read out parameters]

To enter the setting monitor mode, switch to the setting monitor mode using the EASY key, and then press the MODE key.

Turn the setting dial to read the parameter.

The relation between the parameter and the mode selected is shown below.

PSEL=0

* When the power is turned on, the inverter is in standard mode. Press the EASY key to switch to easy setting mode.

PSEL=1

* When the power is turned on, the inverter is in easy setting mode. Press the EASY key to switch to standard mode.

PSEL=2

* Always in easy setting mode.

[How to select parameters]

In easy setting mode, only parameters registered to parameters 1 to 24 are displayed in order of registration.

The values of the default settings are shown in the table below.

[Parameter setting]

Title	Function	Adjustment range	Default setting
F 75 1	Easy setting mode parameter 1	0-999	3 (C00d)
F 75 2	Easy setting mode parameter 2	0-999	4 (F00d)
F 75 3	Easy setting mode parameter 3	0-999	9 (RCC)
F 75 4	Easy setting mode parameter 4	0-999	10 (dEC)
F 75 5	Easy setting mode parameter 5	0-999	600 (tHr)
F 75 6	Easy setting mode parameter 6	0-999	6 (FR)
F 75 7	Easy setting mode parameter 7	0-999	999 (No function)
F 75 8	Easy setting mode parameter 8		
F 75 9	Easy setting mode parameter 9		
F 76 0	Easy setting mode parameter 10		
F 76 1	Easy setting mode parameter 11		
F 76 2	Easy setting mode parameter 12		
F 76 3	Easy setting mode parameter 13		
F 76 4	Easy setting mode parameter 14		
F 76 5	Easy setting mode parameter 15		
F 76 6	Easy setting mode parameter 16		
F 76 7	Easy setting mode parameter 17		
F 76 8	Easy setting mode parameter 18		
F 76 9	Easy setting mode parameter 19		
F 77 0	Easy setting mode parameter 20	0-999	50 (PSEL)
F 77 1	Easy setting mode parameter 21		
F 77 2	Easy setting mode parameter 22		
F 77 3	Easy setting mode parameter 23		
F 77 4	Easy setting mode parameter 24		

Note: If any number other than communication numbers is specified, it is regarded as 999 (no function assigned).

5. Main parameters

Before you operate the inverter, the parameters that you must first program are the basic parameters.

Refer to section 11 tables of basic parameters.

5.1 Searching for changes using the history function

RUH : History function







History function (*RUH*):

Automatically searches for 5 latest parameters that are programmed with values different from the standard default setting and displays them in the *RUH*. Parameter setting can also be changed within this group *RUH*.

Notes on operation

- If no history information is stored, this parameter is skipped and the next parameter "*RUH*" is displayed.
- *HERd* and *ENd* are added respectively to the first and last parameters in a history of changes.

■ How to use the history function

Operation panel action	LED display	Operation
	0.0	Displays the output frequency (operation stopped). (When standard monitor display selection <i>F 7 IU=0</i> [Output frequency])
	<i>RUH</i>	The first basic parameter " <i>RUH</i> " (history function) is displayed.
	<i>ACC</i>	The parameter that was set or changed last is displayed.
	8.0	Press the center of the setting dial to display the set value.
	5.0	Turn the setting dial to change the set value.
	5.0 ↔ <i>ACC</i>	Press the center of the setting dial to save the changed value. The parameter name and the programmed value will flash on and off alternately.
	****	Turn the dial as described above to search for and display changed parameters to check and change the settings.
	<i>HERd</i> (<i>ENd</i>)	<i>HERd</i> : First historic record <i>ENd</i> : Last historic record

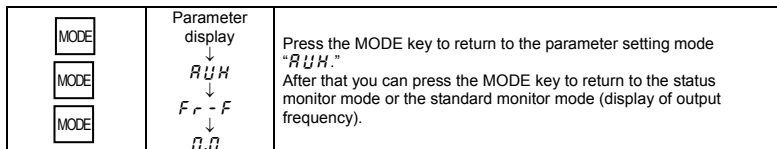

Note1: The following parameters are not displayed in this *RUH*, even if they are the most recent changes.

F C (Operation frequency of operation panel), *RU F* (Guidance function), *RU I* (Automatic acceleration/deceleration), *RU Z* (Torque boost setting macro function), *t Y P* (Default setting), *S E t* (Checking the region setting), *F 7 0 0* (Prohibition of change of parameter settings)

Note2: The parameters set by communication option or RS485 communication are not searched and not displayed.

5.2 Setting a parameter using the guidance function

RU F : Guidance function

Guidance function (*RU F*):

The guidance function refers to the special function of calling up only functions necessary to set up the inverter in response to the user's needs. When a purpose-specific guidance is selected, a group of parameters needed for the specified application (function) is formed and the inverter is switched automatically to the mode of setting the group of parameters selected. You can set up the inverter easily by simply setting the parameters in the group one after another. The guidance function (*RU F*) provides four purpose-specific guidance.











[Parameter setting]

Title	Function	Adjustment range	Default setting
<i>RU F</i>	Guidance function	0: - 1: - Note 1 2: Preset speed guidance 3: Analog signal operation guidance 4: Motor 1/2 switching operation guidance 5: Motor constant setting guidance	0

Note: 1 is for manufacturer's settings. Do not change the settings.

■ How to use the guidance function

Here are the steps to follow to set parameters, using the guidance function. (When the basic setting guidance (*RUF*) is set to 1)

Operation panel action	LED display	Operation
	0.0	Displays the output frequency (operation stopped). (When standard monitor display selection <i>F 7</i> : 0=0 [Output frequency])
	<i>RUH</i>	The first basic parameter "History (<i>RUH</i>)" is displayed.
	<i>RUF</i>	Turn the setting dial to select the guidance function (<i>RUF</i>).
	0	Press the center of the setting dial to display 0.
	2	Turn the setting dial to change to the purpose-specific guidance setting value "2".
	<i>END</i>	Press the center of the setting dial to display the purpose-specific guidance parameter group (refer to table below).
	****	After moving to the purpose-specific guidance parameter group, use the setting dial to change the parameters.
	<i>END</i>	<i>END</i> is dialyzed on completion of the setting of the guidance parameter group.
  	Display of parameter ↓ <i>RUF</i> ↓ <i>F r - F</i> ↓ 0.0	Press the MODE key to exit the guidance parameter group. By pressing the MODE key, you can return to the default monitoring mode (display of output frequency).

If there is anything you do not understand during this operation, press the MODE key several times to start over from the step of *RUH* display.

HERd or *END* is affixed respectively to the first or last parameter in each guidance wizard parameter group.

Table of parameters that can be changed using the guidance function

Preset-speed setting guidance <i>RUF=2</i>	Analog input operation guidance <i>RUF=3</i>	Motor 2 switching operation guidance <i>RUF=4</i>	Motor constant setting guidance <i>RUF=5</i>
<i>Cn0d</i>	<i>Cn0d</i>	<i>F111</i>	<i>Pl</i>
<i>Fn0d</i>	<i>Fn0d</i>	<i>F112</i>	<i>uL</i>
<i>RCC</i>	<i>RCC</i>	<i>F113</i>	<i>uLv</i>
<i>dEC</i>	<i>dEC</i>	<i>F114</i>	<i>F405</i>
<i>FH</i>	<i>FH</i>	<i>uL</i>	<i>F415</i>
<i>UL</i>	<i>UL</i>	<i>uLv</i>	<i>F417</i>
<i>F109</i>	<i>LL</i>	<i>ub</i>	<i>F400</i>
<i>F111</i>	<i>F109</i>	<i>F415</i>	
<i>F112</i>	<i>F201</i>	<i>EHr</i>	
<i>F113</i>	<i>F202</i>	<i>F601</i>	
<i>F114</i>	<i>F203</i>	<i>RCC</i>	
<i>F115</i>	<i>F204</i>	<i>dEC</i>	
<i>Sr1</i>		<i>F170</i>	
<i>Sr2</i>		<i>F171</i>	
<i>Sr3</i>		<i>F172</i>	
<i>Sr4</i>		<i>F173</i>	
<i>Sr5</i>		<i>F185</i>	
<i>Sr6</i>		<i>F500</i>	
<i>Sr7</i>		<i>F501</i>	
<i>F287</i>			
<i>F288</i>			
<i>F289</i>			
<i>F290</i>			
<i>F291</i>			
<i>F292</i>			
<i>F293</i>			
<i>F294</i>			

5.3 Setting acceleration/deceleration time

5.3.1 Automatic acceleration/deceleration

$R U I$: Automatic acceleration/deceleration

- Function
This automatically adjusts acceleration and deceleration time in line with load.
Refer to section 5.3.2 for setting acceleration/ deceleration time manually.

$R U I$ = 1

- * Adjusts the acceleration/deceleration time automatically within the range of 1/8 to 8 times as long as the time set with the $R C C$ or $d E C$, depending on the current rating of the inverter.

$R U I$ = 2

- * Automatically adjusts speed during acceleration only. During deceleration, speed is not adjusted automatically but reduced at the rate set with $d E C$.

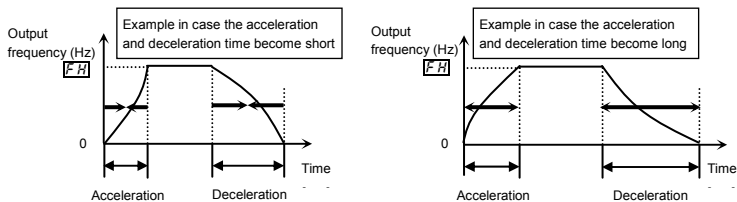





Set $R U I$ (automatic acceleration/deceleration) to 1 or 2.

[Parameter setting]

Title	Function	Adjustment range	Default setting
$R U I$	Automatic acceleration/deceleration	0: Disabled (manual setting) 1: Automatic 2: Automatic (only at acceleration)	0

- ★ When automatically setting acceleration/deceleration time, always change the acceleration/deceleration time so that it conforms to the load. For inverters that require a fixed acceleration/deceleration time, use the manual settings ($R C C$, $d E C$).
- ★ Setting acceleration/deceleration time ($R C C$, $d E C$) in conformance with mean load allows optimum setting that conforms to further changes in load.
- ★ Use this parameter after actually connecting the motor.
- ★ When the inverter is used with a load that fluctuates considerably, it may fail to adjust the acceleration or deceleration time in time, and therefore may be tripped.
- ★ Do not use $R U I$ = 1 when using a brake module (optional).

[Methods of setting automatic acceleration/deceleration]

Operation panel action	LED display	Operation
	0.0	Displays the output frequency. (When standard monitor display selection $F7$ is 0) (Output frequency))
	RUH	The first basic parameter "RUH" (history function) is displayed.
	RU 1	Turn the setting dial to the right to change the parameter to RU 1.
	0	Parameter values can be read by pressing the center of the setting dial.
	1	Turn the setting dial to the right to change the parameter to 1 or 2.
	1 → RU 1	Press the center of the setting dial to save the changed parameter. RU 1 and the parameter are displayed alternately.

★ Assigning the forced deceleration command (function number 122, 123) to any logic input terminal, it can be changed automatic deceleration by compulsion.

5.3.2 Manually setting acceleration/deceleration time

ACC : Acceleration time 1

DEC : Deceleration time 1

- Function

- For acceleration time 1 **ACC** programs the time that it takes for the inverter output frequency to go from 0.0Hz to maximum frequency FH .
- For deceleration time 1 **DEC** programs the time that it takes for the inverter output frequency to go from maximum frequency FH to 0.0Hz.

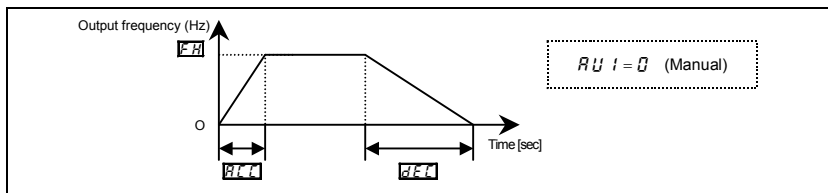

[Parameter setting]

Title	Function	Adjustment range	Default setting
ACC	Acceleration time 1	0.0-3000 s	10.0
DEC	Deceleration time 1	0.0-3000 s	10.0

Note: When the acceleration/deceleration time is set to 0.0 seconds, the inverter accelerates and decelerates 0.05 seconds.

- ★ If the programmed value is shorter than the optimum acceleration/deceleration time determined by load conditions, overcurrent stall or overvoltage stall function may make the acceleration/deceleration time longer than the programmed time. If an even shorter acceleration/deceleration time is programmed, there may be an overcurrent trip or overvoltage trip for inverter protection. (Refer to section 13.1 for details)

5.4 Increasing starting torque

RU2: Torque boost setting macro function

- **Function**
Simultaneously switches inverter output (V/F) control and programs motor constants automatically (On-line automatic-tuning function) to improve torque generated by the motor. This parameter integrates the setting of special V/F control selection such as vector control.

[Parameter setting]

Title	Function	Adjustment range	Default setting
<i>RU2</i>	Torque boost setting macro function	0: - 1: Automatic torque boost + auto-tuning 2: Vector control + auto-tuning 3: Energy saving + auto-tuning	0

Note: Parameter displays on the right always return to 0 after setting. The previous setting is displayed on the left.

Ex. 1 0

Caution:

When the torque boost setting macro function *RU2* is set, look at the motor's name plate and set the following parameters.

- uL* : Base frequency 1 (rated frequency)
- uLv* : Base frequency voltage 1 (rated voltage)
- F405* : Motor rated capacity
- F415* : Motor rated current
- F417* : Motor rated speed

Set the other motor constants as necessary.

1) Increasing torque automatically according to the load

RU2 is set to 1 (Automatic torque boost + auto-tuning)

When torque boost setting macro function control *RU2* is set to 1 (automatic torque boost + auto-tuning), the inverter keeps track of the load current in any speed range and automatically adjusts the output voltage to ensure enough torque and stable operation.

Note 1: The same characteristic can be obtained by setting the V/F control mode selection parameter P_{L} to 2 (automatic torque boost control) and the auto-tuning parameter F_{400} to 2 (auto-tuning).

⇒ Refer to section 6.14

Note 2: Setting R_{U2} to 1 automatically programs P_{L} to 2.

2) When using vector control (increasing starting torque and high-precision operations)

R_{U2} is set to 2 (Vector control + auto-tuning)

Setting torque boost setting macro function control R_{U2} to 2 (vector control + auto-tuning) provides high starting torque bringing out the maximum in motor characteristics from the low-speed range. This suppresses changes in motor speed caused by fluctuations in load to provide high precision operation. This is an optimum feature for elevators and other load transporting machinery.

Note 1: The same characteristic can be obtained by setting the V/F control mode selection parameter P_{L} to 3 (vector control) and the auto-tuning parameter F_{400} to 2 (auto-tuning).

⇒ Refer to section 6.14

Note 2: Setting R_{U2} to 2 automatically programs P_{L} to 3.

3) Energy-saving operation





R_{U2} is set to 3 (Energy saving + auto-tuning)

When torque boost setting macro function control R_{U2} is set to 3 (energy saving + auto-tuning), the inverter always passes a current appropriate to the load for energy saving.

Note 1: The same characteristic can be obtained by setting the V/F control mode selection parameter P_{L} to 4 (automatic energy saving) and the auto-tuning parameter F_{400} to 2 (auto-tuning).

Note 2: When R_{U2} is set to 3, P_{L} is automatically set to 4.

Example of parameter setting

Operation panel action	LED display	Operation
	0. 0	Displays the output frequency. (Perform during operation stopped.) (When standard monitor display selection $F_{710}=0$ [Output frequency])
	R_{UH}	The first basic parameter " R_{UH} " (history function) is displayed.
	R_{U2}	Turn the setting dial to the right to change the parameter to R_{U2} (torque boost setting macro function).
	0 0	Parameter values can be read by pressing the center of the setting dial.
	0 3	Turn the setting dial to the right to change the parameter to 3 (energy saving + auto-tuning). (Right side is the setting value, left side is the history of the previous setting.)
	0 3 ⇔ R_{U2}	Press the center of the setting dial to save the changed parameter. R_{U2} and the parameter are displayed alternately.

When vector control cannot be programmed

First read the precautions about vector control in section 5.11-6).

- 1) If the desired torque cannot be obtained ⇒ Refer to section 6.14 selection 2
- 2) If auto-tuning error "E₁" appears ⇒ Refer to section 6.14 selection 3

■ **RUZ** (Torque boost setting macro function) and **Pt** (V/F control mode selection)

Automatic torque boost is the parameter for setting V/F control mode selection (**Pt**) and auto-tuning (**F400**) together. That is why all parameters related to change automatically when **RUZ** is changed.

		Automatically programmed parameters		
		Pt	F400	
0	Displays 0 after resetting	-	Check the programmed value of Pt .	-
1	Automatic torque boost + auto-tuning	2	Automatic torque boost	2 Auto-tuning executed (after execution: 0)
2	Vector control + auto-tuning	3	Vector control	2 Auto-tuning executed (after execution: 0)
3	Energy saving + auto-tuning	4	Energy saving	2 Auto-tuning executed (after execution: 0)

5

4) Increasing torque manually (V/F constant control)

This is the setting of constant torque characteristics that are suited for such things as conveyors. It can also be used to manually increase starting torque.

If V/F constant control is programmed after changing **RUZ**,

Set V/F control mode selection **Pt** = **0** (V/F constant).

⇒ Refer to section 5.11

Note 1: To further increase torque, increase the torque boost amount **1ub**.

How to set the torque boost amount **1ub** ⇒ Refer to section 5.12

Note 2: V/F control selection **Pt** = **1** (variable torque) is an effective setting for load such as fans and pumps.

⇒ Refer to section 5.11

5.5 Selection of operation mode

COMMAND: Command mode selection

FREQ: Frequency setting mode selection

- Function

These parameters are used to specify which input device (panel keypad, terminal block, or RS485 communication) takes priority in entering an operation stop command or frequency setting mode (terminal VI, setting dial, RS485 communication, or UP/DOWN from external logic).

<Command mode selection>

[Parameter setting]

Title	Function	Adjustment range	Default setting
COMMAND	Command mode selection	0: Terminal board 1: Panel keypad (including extension panel) 2: RS485 communications	1

Programmed value

0: Terminal board operation ON and OFF of an external signal run and stop operation.

1: Panel keypad operation Press the RUN and STOP keys on the panel keypad to run and stop. Operation can also be done from the extension panel.

2: RS485 communication Run/stop operations by RS485 communication from an external device.
⇒ Refer to section 6.19.

- * There are two types of function: the function that conforms to commands selected by **COMMAND**, and the function that conforms only to commands from the terminal board. (function number 108, 109) See the table of input terminal function selection in section 11.6.
- * When priority is given to commands from a linked computer or terminal board, they have priority over the setting of **COMMAND**.





<Frequency setting mode selection>

[Parameter setting]

Title	Function	Adjustment range	Default setting
FREQ	Frequency setting mode selection	0: Terminal board VI 1: Setting dial 1 (press in center to save) 2: Setting dial 2 (saved even if power is off) 3: RS485 communication 4: - 5: UP/DOWN from external logic input	2

- When frequency setting by an extension panel option, **FREQ** is set to **1** or **2**.

[Programmed value]

- 0**: Terminal board VI A frequency command is set by means of external signals (VI terminal: 0 - 5/0 - 10 Vdc, or 0 (4) - 20 mAdc).
⇒ Refer to section 3.2.2 and 7.3
- 1**: Setting dial 1 Frequencies are set by rotating the setting dial on the inverter. Press the center of the setting dial to save the frequency setting value.
The frequency setting value is set by   keys on an extension panel option.
⇒ Refer to section 3.2.2
- 2**: Setting dial 2 Frequencies are set by rotating the setting dial on the inverter. Like the position of notches in a volume knob, the frequency setting value at the position of the notch is saved.
The frequency setting value is set by   keys on an extension panel option.
⇒ Refer to section 3.2.2
- 3**: RS485 communication Frequencies are set by commands from an external control unit.
⇒ Refer to section 6.19
- 5**: UP/DOWN from external logic input Frequencies are set by up/down commands from a terminal.
⇒ Refer to section 6.5.3
- ★ The control input terminal in which the following functions are set is always valid regardless of the setting of $\text{C}n\text{O}d$ and $Fn\text{O}d$.
- Reset (valid only for tripping)
 - Standby
 - External input tripping stop command
 - Coast stop command terminal
- ★ To make changes in the command mode selection $\text{C}n\text{O}d$ and the frequency setting mode selection $1Fn\text{O}d$, first stop the inverter temporarily.
(Can be changed while in operation when $F735$ is set to 0.)
- ★ Priority commands from communications or terminal blocks are given priority over $Fn\text{O}d$.

■ Preset-speed operation

$\text{C}n\text{O}d$: Set to 0 (Terminal board).

$Fn\text{O}d$: Valid in all setting values.

■ Input terminal settings

Assign the following functions to the input terminal to allow switching of the frequency command by turning the terminal ON/OFF.

Input terminal function		ON	OFF
48	Forced local from communication	Enabled during communication Local (Setting of $\text{C}n\text{O}d$, $Fn\text{O}d$)	Communication
106	Frequency setting mode terminal board VI	Terminal board (VI) enabled	setting of $Fn\text{O}d$

Each of the following numbers (49, 107) are reverse signals.

■ Example of run and frequency command switching

Command mode and frequency setting mode switching

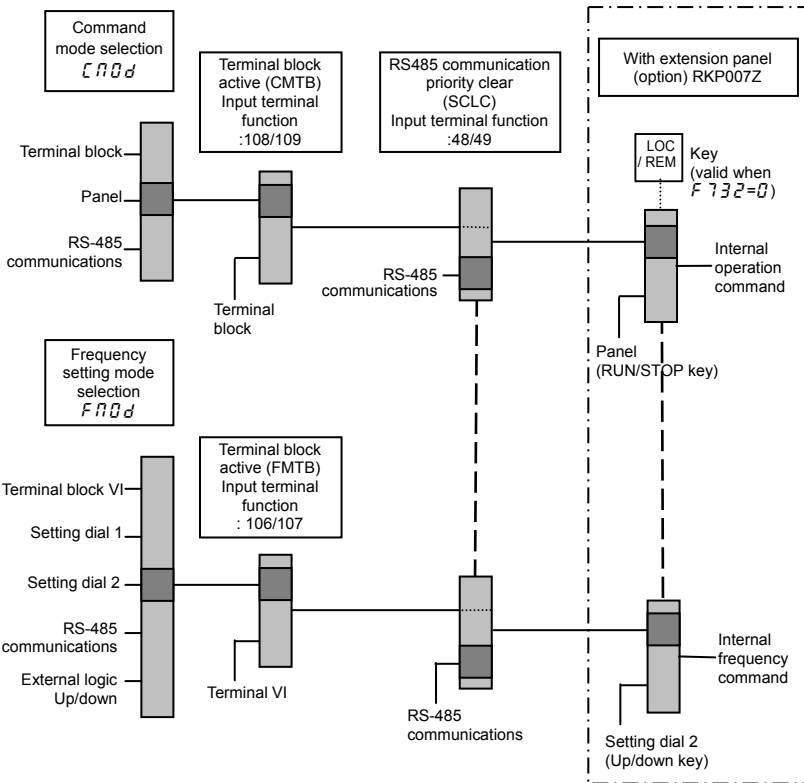

5

5.6 Meter setting and adjustment

FNSL: Meter selection

FN: Meter adjustment gain

Refer to section 3.4 for details.

5.7 Forward/reverse run selection (Panel keypad)

Fr: Forward/reverse run selection (Panel keypad)

- Function
Program the direction of rotation of the motor when the running and stopping are made using the RUN key and STOP key on the operation panel.
Valid when CND (command mode) is set to 1 (operation panel).

[Parameter setting]

Title	Function	Adjustment range	Default setting
F_r	Forward/reverse run selection (Panel keypad)	0: Forward run 1: Reverse run 2: Forward run (F/R switching on extension panel) 3: Reverse run (F/R switching on extension panel)	0

- ★ Using extension panel RKP007Z (option) : When F_r is set to 2 and the standard monitor is displayed, pressing the FWD/REV key changes the direction of rotation from forward to reverse after displaying the message $F_r - r$.
Pressing the FWD/REV key again changes the direction of rotation from reverse to forward after displaying the message $F_r - F$.
- ★ Using extension panel RKP002Z (option) : When F_r is set to 2 and the standard monitor is displayed, pressing the DOWN key while pressing the ENT key changes the direction of rotation from forward to reverse after displaying the message $F_r - r$.
Pressing the UP key while pressing the ENT key again changes the direction of rotation from reverse to forward after displaying the message $F_r - F$.
- ★ Check the direction of rotation on the status monitor. Refer to section 8.1 for details about monitor.
 $F_r - F$: Forward run
 $F_r - r$: Reverse run
- ★ When the F and R terminals are used for switching between forward and reverse rotation from the terminal board, the F_r forward/reverse run selection parameter is rendered invalid.
Short across the F-CC terminals: forward rotation
Short across the R-CC terminals: reverse rotation.

- × The inverter was factory-configured by default so that shorting terminals F-CC and terminals R-CC simultaneously would cause the motor to slow down to a stop.

Using the parameter $F105$, however, you can select between forward run and reverse run.

5.8 Maximum frequency

FH : Maximum frequency

- Function

- 1) Programs the range of frequencies output by the inverter (maximum output values).
- 2) This frequency is used as the reference for acceleration/deceleration time.

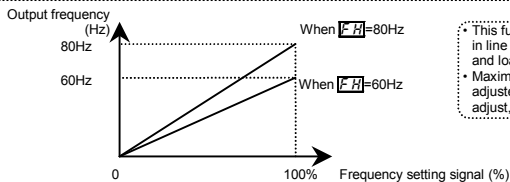

This function determines the value in line with the ratings of the motor and load.
 • Maximum frequency cannot be adjusted during operation. To adjust, first stop the inverter.

- × If FH is increased, adjust the upper limit frequency UL as necessary.

[Parameter setting]

Title	Function	Adjustment range	Default setting
FH	Maximum frequency	30.0-400.0 (Hz)	*

* Default setting values vary depending on the setup menu setting. Refer to section 11.5.

Note 1) When UL (Base frequency 1) or $F170$ (Base frequency 2) are set to 190Hz or more, set FH to bigger value or more of UL and $F170$.

5.9 Upper limit and lower limit frequencies

\overline{UL} : Upper limit frequency

\underline{LL} : Lower limit frequency

- Function

Programs the lower limit frequency that determines the lower limit of the output frequency and the upper limit frequency that determines the upper limit of that frequency.

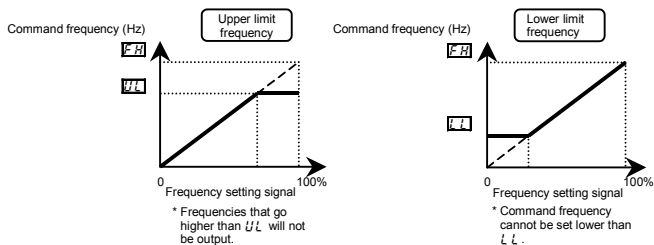

[Parameter setting]

Title	Function	Adjustment range	Default setting
\overline{UL}	Upper limit frequency	0.5 - FH (Hz)	*
\underline{LL}	Lower limit frequency	0.0 - \underline{UL} (Hz)	0.0

* Default setting values vary depending on the setup menu setting. Refer to section 11.5.

Note1) Do not set a value 10 times larger than ωL (base frequency 1) and $F170$ (base frequency 2) for \overline{UL} .

If a large number is set, the output frequency can only be output at 10 times of minimum value ωL and $F170$ and $A-05$ alarm is displayed.

Note2) Output frequency lower than parameter $F240$ (Starting frequency) is not output. Parameter $F240$ setting is needed.

Note3) When the stall prevention function operates, the inverter may drive beyond the limit frequency \overline{UL} or \underline{LL} .

5.10 Base frequency

$\underline{u} \underline{L}$: Base frequency 1

$\underline{u} \underline{L} \underline{u}$: Base frequency voltage 1

- Function
Set the base frequency and the base frequency voltage in conformance with load specifications or the base frequency.

Note: This is an important parameter that determines the constant torque control area.

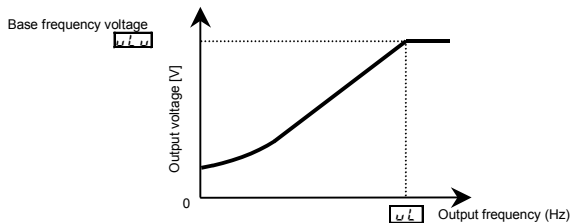

[Parameter setting]

Title	Function	Adjustment range	Default setting
$\underline{u} \underline{L}$	Base frequency 1	20.0-400.0 (Hz)	*
$\underline{u} \underline{L} \underline{u}$	Base frequency voltage1	50-330 (V)	*

* Default setting values vary depending on the setup menu setting. Refer to section 11.5.

Note 1) When $\underline{u} \underline{L}$ (Base frequency 1) or $F \ 1 \ 7 \ 0$ (Base frequency 2) are set to 190Hz or more, set $F \ H$ to bigger value or more of $\underline{u} \underline{L}$ and $F \ 1 \ 7 \ 0$.

5.11 Selecting control mode

P_Ł: V/F control mode selection

- Function

With VF-nC3, the V/F controls shown below can be selected.

- V/F constant
- Variable torque
- Automatic torque boost control *1
- Vector control *1
- Energy saving *1

(*1) Parameter setting macro torque boost: **RUZ** parameter can automatically set this parameter and auto-tuning at a time. (Refer to section 5.4)

[Parameter setting]

Title	Function	Adjustment range	Default setting
P _Ł	V/F control mode selection	0: V/F constant 1: Variable torque 2: Automatic torque boost control 3: Vector control 4: Energy-saving	0





Note: P_Ł (V/F control mode selection) is valid only for the first motor.

Changes to "V/F constant control" when switching to the second motor, regardless of the P_Ł setting.

Steps in setting are as follows

(In this example, the V/F control mode selection parameter P_Ł is set to 3 (Vector control).)

[Setting V/F control mode selection to 3 (sensorless vector control)]

Operation panel action	LED display	Operation
	0. 0	Displays the output frequency. (Perform during operation stopped.) (When standard monitor display selection F 7 : 0=0 [Output frequency])
	RUH	The first basic parameter "RUH" (history function) is displayed.
	P _Ł	Rotate the setting dial to the right, and change the parameter to P _Ł (control selection).
	0	Parameter values can be read by pressing the center of the setting dial (the default setting is 0:V/F constant).
	3	Rotate the setting dial to the right, and change the parameter to 3 (vector control).
	3 ⇔ P _Ł	Press the center of the setting dial to save the changed parameter. P _Ł and parameter set value "3" are displayed alternately.

Caution:

When the V/F control mode selection P_{ξ} is set to $\mathcal{2}$: Automatic torque boost control, $\mathcal{3}$: Vector control, or $\mathcal{4}$: Energy-saving, be sure to set the following parameters according to the motor's name plate.

$\omega_{\xi 1}$: Base frequency 1 (rated frequency)

$\omega_{\xi 1 v}$: Base frequency voltage 1 (rated voltage)

F_{405} : Motor rated capacity

F_{415} : Motor rated current

F_{417} : Motor rated speed

Set the other motor constants as necessary

1) Constant torque characteristics

Setting of V/F control mode selection P_{ξ} to $\mathcal{0}$ (V/F constant)

This is applied to loads with equipment like conveyors and cranes that require the same torque at low speeds as at rated speeds.

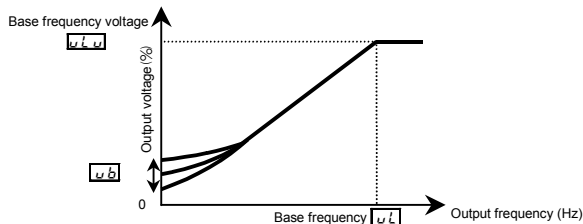

* To increase the torque further, increase the setting value of the manual torque boost ω_b .

⇒ Refer to section 5.12 for details.

2) Setting for fans and pumps

Setting of V/F control mode selection P_{ξ} to $\mathcal{1}$ (variable torque)

This is appropriate for load characteristics of such things as fans, pumps and blowers in which the torque in relation to load rotation speed is proportional to its square.

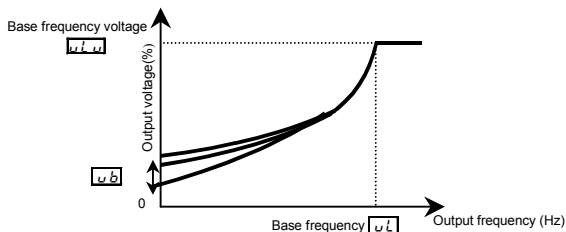

3) Increasing starting torque

Setting of V/F control mode selection $P_{\text{L}} \rightarrow 2$ (automatic torque boost control)

Detects load current in all speed ranges and automatically adjusts voltage output (torque boost) from inverter. This gives steady torque for stable runs.

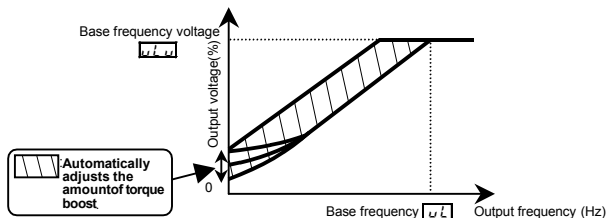

Note: This control system can oscillate and destabilize runs depending on the load. In this case, set V/F mode selection $P_{\text{L}} = 0$ (V/F constant) and increase manual torque boost u_{b} .

★ Motor constant must be set

If the motor you are using is a 4P Toshiba standard motor and if it has the same capacity as the inverter, there is basically no need to set the motor constant. In any other case, set the following parameters according to the motor's name plate.

u_{L} (Base frequency 1), $u_{\text{L}u}$ (Base frequency voltage 1), F_{405} (Motor rated capacity), F_{415} (Motor rated current), F_{417} (Motor rated speed)

There are three procedures for setting the other motor constants.

- 1) Auto torque boost and a motor constant (auto-tuning) can be set at once.
To do so, set the basic parameter R_{U2} to 1. \Rightarrow Refer to section 5.4-1) for details.
- 2) The motor constant can be automatically set (auto-tuning).
Set the extended parameter F_{400} to 2. \Rightarrow Refer to section 6.14 selection 2 for details.
- 3) Each motor constant can be set individually. \Rightarrow Refer to section 6.14 selection 3 for details.

4) Vector control - increasing starting torque and achieving high-precision operation.

Setting of V/F control mode selection $P_{\text{L}} \rightarrow 3$ (Vector control)

Using sensor-less vector control will provide the highest torque at the low speed ranges.

- (1) Provides large starting torque.
- (2) Effective when stable operation is required to move smoothly up from the low speeds.
- (3) Effective in elimination of load fluctuations caused by motor slippage.

★ Motor constant must be set

If the motor you are using is a 4P Toshiba standard motor and if it has the same capacity as the inverter, there is basically no need to set the motor constant. In any other case, set the following parameters according to the motor's name plate.

ωL (Base frequency 1), $\omega L u$ (Base frequency voltage 1), $F 4 Q 5$ (Motor rated capacity), $F 4 I 5$ (Motor rated current), $F 4 I 7$ (Motor rated speed)

There are three procedures for setting the other motor constants.

- 1) The sensorless vector control and motor constants (auto-tuning) can be set at a time.
Set the basic parameter $H U 2$ to 2 . \Rightarrow Refer to section 5.4-2) for details.
- 2) The motor constant can be automatically set (auto-tuning).
Set the extended parameter $F 4 Q Q$ to 2 . \Rightarrow Refer to section 6.14 selection 2 for details.
- 3) Each motor constant can be set individually. \Rightarrow Refer to section 6.14 selection 3 for details.

5) Energy-saving

Setting of V/F control mode selection $P L$ to 4 (Energy-saving)
--

Energy can be saved in all speed areas by detecting load current and flowing the optimum current that fits the load.

★ Motor constant must be set

If the motor you are using is a 4P Toshiba standard motor and if it has the same capacity as the inverter, there is no need to set the motor constant. In any other case, set the following parameters according to the motor's name plate.

ωL (Base frequency 1), $\omega L u$ (Base frequency voltage 1), $F 4 Q 5$ (Motor rated capacity), $F 4 I 5$ (Motor rated current), $F 4 I 7$ (Motor rated speed)

There are three procedures for setting the other motor constants.

- 1) Automatic energy-saving operation and a motor constant can be set at once.
Set the basic parameter $H U 2$ to 3 . \Rightarrow Refer to section 5.4-3) for details.
- 2) The motor constant can be automatically set (auto-tuning).
Set the extended parameter $F 4 Q Q$ to 2 . \Rightarrow Refer to section 6.14 selection 2 for details.
- 3) Each motor constant can be set individually. \Rightarrow Refer to section 6.14 selection 3 for details.

6) Cautions for vector control

- 1) When performing vector control, look at the motor's name plate and set the following parameters.

ωL (Base frequency 1), $\omega L u$ (Base frequency voltage 1), $F 4 Q 5$ (Motor rated capacity), $F 4 I 5$ (Motor rated current), $F 4 I 7$ (Motor rated speed)

- 2) The sensorless vector control exerts its characteristics effectively in frequency areas of the base frequency (ωL) or less. The same characteristics will not be obtained in areas over the base frequency.
- 3) Set the base frequency to anywhere from 40 to 120Hz during vector control ($P L = 3$).
- 4) Use a general purpose squirrel-cage motor with a capacity that is the same as the inverter's rated capacity or one rank below.

The minimum applicable motor capacity is 0.05kW.

- 5) Use a motor that has 2-8 P.
- 6) Always operate the motor in single operation (one inverter to one motor). Sensorless vector control cannot be used when one inverter is operated with more than one motor.
When using a combination of several motors, set the V/F constant ($P \xi = G$).
- 7) The maximum length of wires between the inverter and motor is 30 meters. If the wires are longer than 30 meters, set standard auto-tuning with the wires connected to improve low-speed torque during sensorless vector control.
However the effects of voltage drop cause motor-generated torque in the vicinity of rated frequency to be somewhat lower.
- 8) When a reactor is connected between the inverter and a motor, the motor's generated torque may fall.
Setting auto-tuning may also cause a trip ($E \xi n \ i$) rendering sensorless vector control unusable.

5.12 Manual torque boost - increasing torque boost at low speeds

ub: Torque boost 1

- Function
If torque is inadequate at low speeds, increase torque by raising the torque boost rate with this parameter.

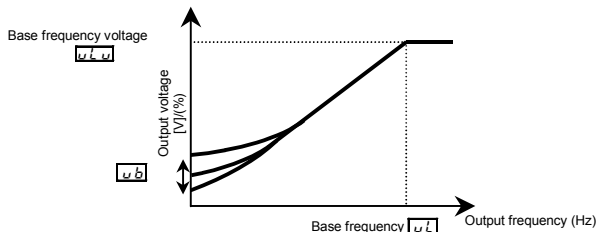

[Parameter setting]

Title	Function	Adjustment range	Default setting
ub	Torque boost value 1	0.0 - 30.0 (%)	According to model (Refer to section 11.4)

★ Valid when $P \xi$ is set to G (V/F constant) or i (square reduction)

Note 1: The optimum value is programmed for each inverter capacity. Be careful not to increase the torque boost rate too much because it could cause an overcurrent trip at startup.

5.13 Setting the electronic thermal

EHF : Motor electronic-thermal protection level 1

OLN : Electronic thermal protection characteristic selection

Refer to section 3.5 for details

5.14 Preset-speed operation (speeds in 15 steps)

5r1 - **5r7**: Preset-speed frequency 1-7

Refer to section 3.6 for details.

5 5.15 Standard default setting

E4P: Default setting

Refer to section 4.3.2 for details.

5.16 Checking the region setting selection

SET: Checking the region setting

Refer to section 4.4 for details.

5.17 EASY key mode selection

PSEL: EASY key mode selection

Refer to section 4.5 for details.

6. Other parameters

Extended parameters are provided for sophisticated operation, fine adjustment and other special purposes. Modify parameter settings as required. Refer to section 11 tables of extended parameters.

6.1 Input/output parameters

6.1.1 Low-speed signal

F100: Low-speed signal output frequency

- **Function**
When the output frequency is $F100$ or more, an ON signal will be generated. This signal can be used as an electromagnetic brake excitation/release signal. (Refer to "Motors with a brake" in section 1.4.1 for application.)
This signal can also be used as an operation signal when $F100$ is set to 0.0Hz, because an ON signal is put out if the inverter is in output state.
- ★ **Output from the open collector output terminal OUT. (Default)**
Output from relay output FLA-FLB-FLC is possible depending on the parameter settings.

[Parameter setting]

Title	Function	Adjustment range	Default setting
$F100$	Low-speed signal output frequency	0.0 - FH (Hz)	0.0

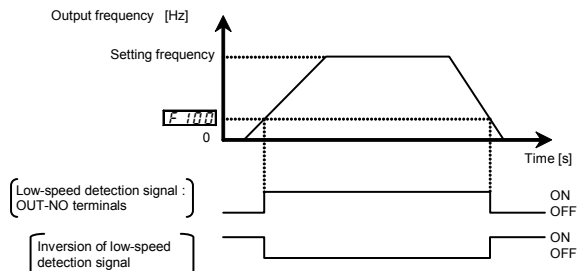

An example of the connection of the open collector OUT terminal (sink logic)

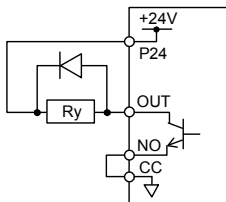

An example of the connection of the relay output terminals

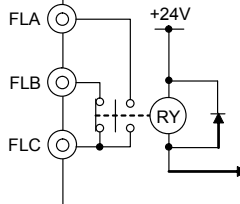

- Output terminal setting
Default outputs low-speed signal (ON signal) to OUT terminal. This setting must be changed to invert the polarity of the signal.

[Parameter setting]

Title	Function	Adjustment range	Default setting
F 130	Output terminal selection 1A (OUT)	0-255 (Refer to section 11.7)	4: LOW (Low-speed detection signal)

Setting value 5 is reverse signal.
Set F 132 to output to FLA-FLC-FLB terminals.

6.1.2 Output of designated frequency reach signal

F 102: Speed reach detection band

- Function
When the output frequency becomes equal to the setting by designated frequency $\pm F 102$, an ON or OFF signal is generated.

[Parameter setting]

■Parameter setting of designated frequency and detection band

Title	Function	Adjustment range	Default setting
F 102	Speed reach detection band	0.0 - FH (Hz)	2.5

■Parameter setting of output terminal selection

Title	Function	Adjustment range	Setting
F 130	Output terminal selection 1A (OUT)	0-255 (Refer to section 11.7.)	6: RCH (Output frequency attainment signal (acceleration/deceleration completed))

Setting value 7 is reverse signal.
Note: Set F 132 to output to FLA-FLC-FLB terminals.

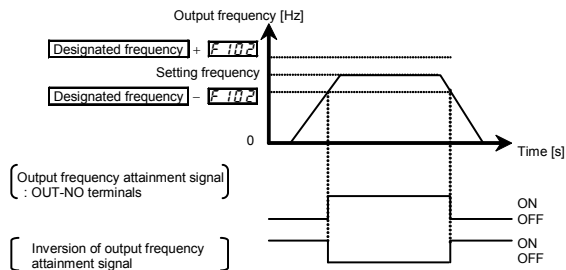

6.1.3 Output of set frequency speed reach signal

$F 101$: Speed reach setting frequency

$F 102$: Speed reach detection band

- Function
When the output frequency becomes equal to the frequency set by $F 101 \pm F 102$, an ON or OFF signal is generated.

[Parameter setting]

■Parameter setting of frequency and detection band

Title	Function	Adjustment range	Default setting
$F 101$	Speed reach setting frequency	0.0 - $F H$ (Hz)	0.0
$F 102$	Speed reach detection band	0.0 - $F H$ (Hz)	2.5

■Parameter setting of output terminal selection

Title	Function	Adjustment range	Setting
$F 130$	Output terminal selection 1A (OUT)	0-255 (Refer to section 11.7)	8: RCHF (Set frequency attainment signal)

Setting value 9 is reverse signal.

Note: Set $F 132$ to assign to FLA-FLC-FLB terminals.

If the detection band value + the set frequency is less than the designated frequency

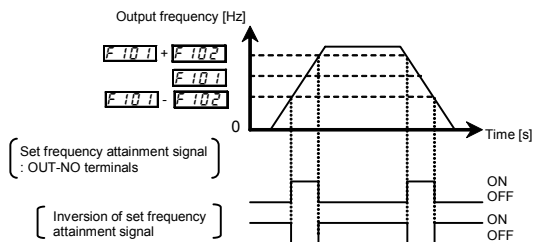

6.2 Input signal selection

6.2.1 Priority selection (Both F and R are ON)

F105: Priority selection (Both F and R are ON)

- Function
This parameter allows you to select the direction in which the motor runs when a forward run (F) command and a reverse run (R) command are entered simultaneously.
 - Reverse
 - Slowdown stop

[Parameter setting]

Title	Function	Adjustment range	Default setting
F105	Priority selection (Both F and R are ON)	0: Reverse 1: Slowdown stop	1

- (1) [$F \ \cancel{R} \ S = \cancel{R}$ (Reverse)]: If an F command and an R command are entered simultaneously, the motor will run in the reverse direction.

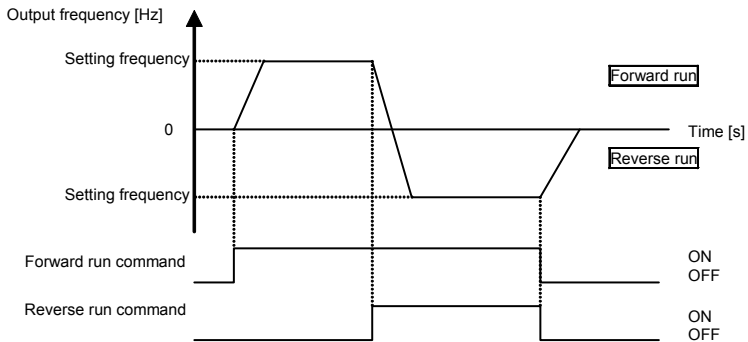

- (2) [$F \ \cancel{R} \ S = \cancel{F}$ (Stop)]: If an F command and an R command are entered simultaneously, the motor will slow down to a stop.

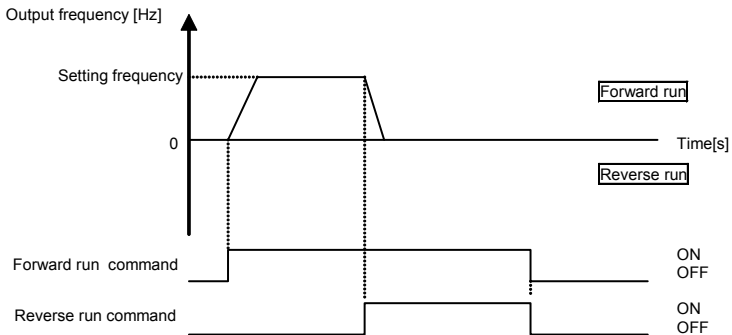

6.2.2 Changing the functions of VI terminal

F109: Analog/logic input selection (VI terminal)

- Function
This parameter allows you to choose between analog input and logic input for the VI terminal.

[Parameter setting]

Title	Function	Adjustment range	Default setting
<i>F109</i>	Analog/logic input selection (VI terminal)	0: Voltage signal input (0 - 10V) 1: Current signal input (4 - 20mA) 2: Logic input 3: Voltage signal input (0 - 5V)	0

- ☆ Resolution is maximum 1/1000 when VI terminal is used as analog input terminal (*F109=0 . 1 . 3*).
- * In sink logic connection, be sure to insert a resistor between the P24 terminal and the VI terminal, when using it as the logic input terminal. Refer to section 2.3.2 for details (page B-11).
- * For information about the interface with the programmable controller, refer to section 7.2.1 (page G-3).

6.3 Terminal function selection

6.3.1 Changing control logic switching

F 127: Sink/source switching

- Function
Logic input terminal sink logic (minus common)/source logic (plus common) and using an external power supply are switched.

[Parameter setting]

Title	Function	Adjustment range	Default setting
F 127	Sink/source switching	0: Sink(Internal power supply), 100: Source, 200: Sink(External power supply) 1-99, 101-199, 201-255: invalid	*1

* 1: Default setting values vary depending on the setup menu setting. Refer to section 11.5.

- ☆ Sink/source settings are basically selected on the setup menu. (Refer to section 3.1)
- ☆ After selecting them on the setup menu, the parameters are used for switching sink/source. However, disconnect the control circuit terminals of the inverter. Otherwise, the equipment may malfunction. After setting F 127 switching, the check alarms (E - 49, E - 50, E - 51) are displayed, reset panel, external signal, or power.
Refer to pages B-10 and B-11 regarding sink/source logic connections.

6.3.2 Keeping an input terminal function always active (ON)

F 108: Always active function selection 1

F 110: Always active function selection 2

- Function
This parameter specifies an input terminal function that is always to be kept active (ON).

[Parameter setting]

Title	Function	Adjustment range	Default setting
F 108	Always active function selection 1	0-7, 10-123: Refer to section 11.6. 8, 9: -	0 (No function)
F 110	Always active function selection 2	0-7, 10-123: Refer to section 11.6. 8, 9: -	6 (ST)

- ★ Explanation of the coast stop function
 When ST (Standby) is OFF, coast stops.
 The default setting for ST (Standby) is ON, change the following settings.
- $F110=0$ (no function)
 - Assign open input terminal 6: ST (Standby).
- Coast stops if terminal set for ST (Standby) is set to OFF. The monitor on the inverter at this time displays $0FF$

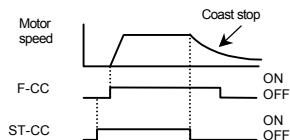

6.3.3 Modifying input terminal functions

- $F111$: Input terminal selection 1A (F) $F151$: Input terminal selection 1B (F)
- $F112$: Input terminal selection 2A (R) $F152$: Input terminal selection 2B (R)
- $F113$: Input terminal selection 3A (S1) $F153$: Input terminal selection 3B (S1)
- $F114$: Input terminal selection 4A (S2) $F154$: Input terminal selection 4B (S2)
- $F109$: Analog/logic input selection (VI Terminal) $F155$: Input terminal selection 1C (F)
- $F115$: Input terminal selection 5 (VI) $F156$: Input terminal selection 2C (R)

⇒ Refer to section 7.2.1 for details about input terminal functions.

6.3.4 Modifying output terminal functions

- $F130$: Output terminal selection 1A (OUT)
- $F132$: Output terminal selection 2 (FL)
- $F137$: Output terminal selection 1B (OUT)
- $F139$: Output terminal logic selection (OUT)

⇒ Refer to section 7.2.2 for details about output terminal functions.

6.4 Basic parameters 2

6.4.1 Switching motor characteristics via terminal input

F170: Base frequency 2

F171: Base frequency voltage 2

F172: Torque boost value 2

F173: Motor electronic-thermal protection level 2

F185: Stall prevention level 2

- Function

Use the above parameters to switch the operation of two motors with a single inverter and to select motor V/F characteristics (two types) according to the particular needs or operation mode.

Note: The $P\grave{L}$ (V/F control mode selection) parameter is enabled only for motor1.
If motor 2 is selected, V/F control will be given constant torque characteristics.

[Parameter setting]

Title	Function	Adjustment range	Default setting
F170	Base frequency 2	25.0-400.0 (Hz)	*1
F171	Base frequency voltage 2	50-330 (V)	*1
F172	Torque boost value 2	0.0-30.0 (%)	Depending on model (Refer to section 11.4)
F173	Motor electronic-thermal protection level 2	10-100 (%) / (A) *2	100
F185	Stall prevention level 2	10-199 (%) / (A), *2 200 : Disabled	150

*1: Default setting values vary depending on the setup menu setting. Refer to section 11.5.

*2: The inverter's rated current is 100%. When $F170$ (current and voltage unit selection) = I (A (amps)/V (volts)) is set, it can be set at A (amps).

Note 1) When ωL (Base frequency 1) or $F170$ (Base frequency 2) are set to 190Hz or more, set FH to bigger value or more of ωL and $F170$.

■ Setting of switching terminals

To switch to motor 2, assign the following functions to a terminal not being used. It is also possible to switch to acceleration/deceleration 2 (AD2). Refer to section 6.15.1 for details.

It is possible to set 3 functions for terminal F and R, and 2 functions for terminal S1 and S2.

Input terminal function number			Parameters changed from applicable parameters and default standards
24 AD2	28 VF2	32 OCS2	
OFF	OFF	OFF	Standard default: $Pt, \omega L, \omega L \omega, \omega b, tHr, RCL, dEC, F502, F601$
ON	OFF	OFF	$RCL \rightarrow F500, dEC \rightarrow F501, F502 \rightarrow F503$
OFF	ON	OFF	$Pt \rightarrow V/F \text{ constant}, \omega L \rightarrow F170, \omega L \omega \rightarrow F171, \omega b \rightarrow F172, tHr \rightarrow F173$
OFF	OFF	ON	$F601 \rightarrow F185$

Note 1: Each of the following numbers (25, 29, 33) are reverse signals.

Note 2: Pt and "V/F constant" cannot be switched while running. Stop the motor before switching.

After the change, please drive after 0.2 seconds or more.

ωL and $F170$, $\omega L \omega$ and $F171$, ωb and $F172$ can be switched while running.

Note 3: Integral value of motor electronic thermal is cleared, after the motor switching.

However, the setting that can memorize an integral value is possible.

■ Example of setting a terminal for switching : Sink logic

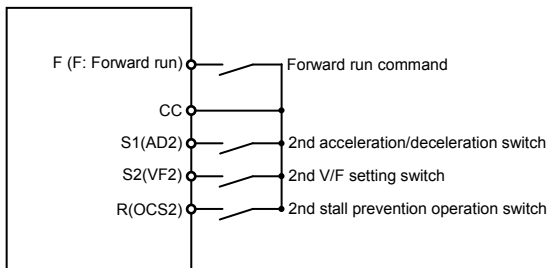

6.5 Setting frequency command

6.5.1 Switching frequency command

F10d : Frequency setting mode selection

F111 - **F115** : Input terminal selection 1A, 2A, 3A, 4A, 5

F151 - **F156** : Input terminal selection 1B, 2B, 3B, 4B, 1C, 2C

- Function
Frequency command can be changed according to the terminal block input.

Refer to section 5.5 for details.

6.5.2 Setting frequency command characteristics

F109: Analog/logic input selection (VI terminal)

F201: VI Input point 1 setting

F202: VI Input point 1 frequency

F203: VI Input point 2 setting

F204: VI Input point 2 frequency

F209: Analog input filter

- Function

Output frequency is adjusted in relation to frequency command according to external analog signals.

Analog signal is **F109** set to 0: 0 to 10Vdc, 1: 4 to 20mAdc, 3: 0 to 5Vdc.

F209 analog input filter is effective for eliminating noise from frequency setting circuit. Increase if operation cannot be done because noise effects stability.

- ★ To fine adjust the frequency command characteristics for VI input, use the parameters **F470** and **F471**. (Refer to section 6.5.4)

[Parameter setting]

Title	Function	Adjustment range	Default setting
F109	Analog/logic input selection (VI terminal)	0: Voltage signal input (0 - 10V) 1: Current signal input (4 - 20mA) 2: Logic input 3: Voltage signal input (0 - 5V)	0
F201	VI point 1 setting	0 - 100(%)	0
F202	VI point 1 frequency	0.0 - 400.0 (Hz)	0.0
F203	VI point 2 setting	0 - 100(%)	100
F204	VI point 2 frequency	0.0 - 400.0 (Hz)	*
F209	Analog input filter	4 - 1000 (ms)	64

* Default setting values vary depending on the setup menu setting. Refer to section 11.5.

Note 1: Do not set point 1 and 2 (**F201** and **F203**) to the same value. If they are set to the same value, **Err1** is displayed.

1) 0-10Vdc voltage input adjustment

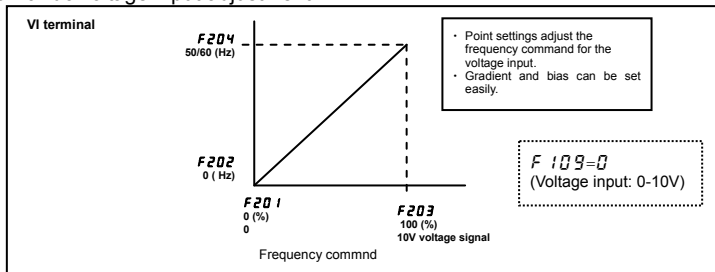

2) 4-20mA current input adjustment

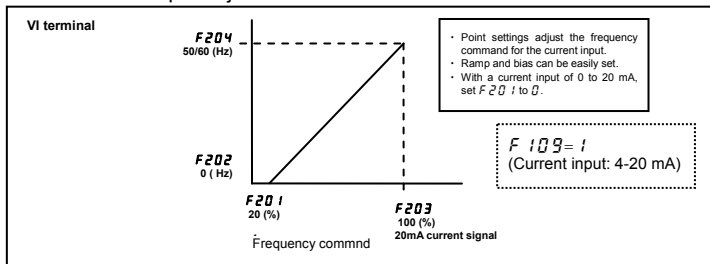

3) 0-5 Vdc voltage input, or used to adjust external volume (P5-VI-CC)

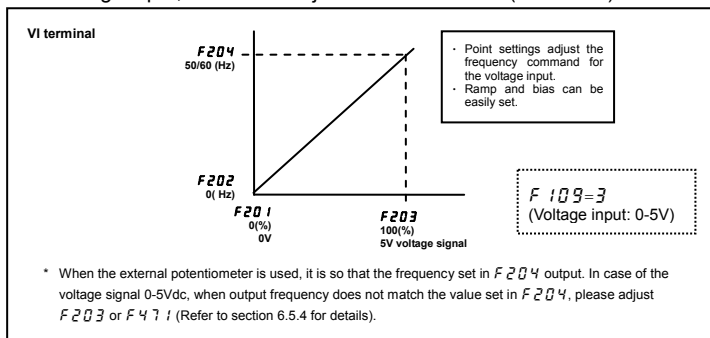

6.5.3 Setting of frequency with the input from an external logic

F264: External logic input - UP response time

F265: External logic input - UP frequency steps

F266: External logic input - DOWN response time

F267: External logic input - DOWN frequency steps

F268: Initial value of UP/DOWN frequency

F269: Change of the initial value of UP/DOWN frequency

- Function

These parameters are used to set an output frequency by means of a signal from an external device.

[Parameter setting]

Title	Function	Adjustment range	Default setting
F264	External logic input - UP response time	0.0 - 10.0 (S)	0.1
F265	External logic input - UP frequency steps	0.0 - <i>FH</i> (Hz)	0.1
F266	External logic input - DOWN response time	0.0 - 10.0 (S)	0.1
F267	External logic input - DOWN frequency steps	0.0 - <i>FH</i> (Hz)	0.1
F268	Initial value of UP/DOWN frequency	$L_L - U_L$ (Hz)	0.0
F269	Change of the initial value of UP/DOWN frequency	0: Not changed 1: Setting of F268 changed when power is turned off	1

☆ This function is valid when the parameter *FND* (frequency setting mode selection) = 5 is set.

■ Input terminal settings

Assign the following functions to the input terminal, you can change (up/down) or clear the output frequency by using the terminal's ON/OFF.

Input terminal function		ON	OFF
88	Frequency UP	Frequency setting increase	Clear
90	Frequency DOWN	Frequency setting decrease	Clear
92	Clear frequency UP/DOWN	OFF → ON: External logic up/down frequency Clear settings	<i>FND</i> settings

Each of the following numbers (89, 91, 93) are reverse signals.

■ Adjustment with continuous signals (Operation example 1)

Set parameters as follows to adjust the output frequency up or down in proportion to the frequency adjustment signal input time:

Panel frequency incremental gradient = $F 2 6 5 / F 2 6 4$ setting time

Panel frequency decremental gradient = $F 2 6 7 / F 2 6 6$ setting time

Set parameters as follows to adjust the output frequency up or down almost in synchronization with the adjustment by the panel frequency command:

$F 2 6 4 = F 2 6 6 = 1$

$(F H I R C L) \geq (F 2 6 5 / F 2 6 4 \text{ setting time})$

$(F H I D E L) \geq (F 2 6 7 / F 2 6 6 \text{ setting time})$

<<Sample sequence diagram 1: Adjustment with continuous signals>>

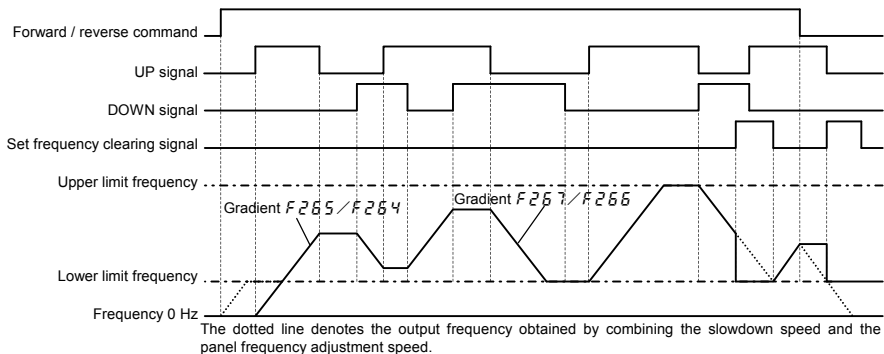

Note: If the operation frequency is set to the lower limit frequency, it will increase from 0Hz when power is turned on for the first time after the setting, and therefore the output frequency will not rise until the operation frequency reaches the lower limit frequency. (Operation at the lower limit frequency)
In this case, the time required for the operation frequency to reach the lower limit frequency can be shortened by setting $F 2 6 4$ to the lower limit frequency.

■ Adjustment with pulse signals (Operation example 2)

Set parameters as follows to adjust the frequency in steps of one pulse:

$F 2 6 4, F 2 6 6 =$ Pulse On time

$F 2 6 5, F 2 6 7 =$ Frequency obtained with each pulse

* The inverter does not respond to any pulses with an ON time shorter than that set with $F 2 6 4$ or $F 2 6 6$. 12ms or more of clearing signal is allowed.

<<Sample sequence diagram 2: Adjustment with pulse signals>>

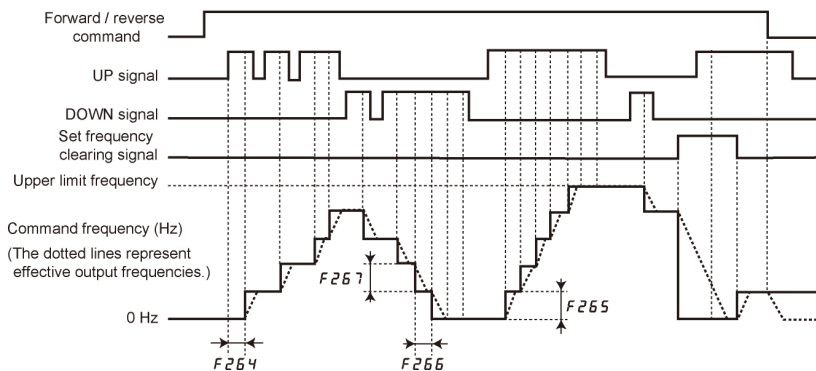

- 6**
- If two signals are impressed simultaneously
 - If a clear signal and an up or down signal are impressed simultaneously, priority will be given to the clear signal.
 - If up and down signals are impressed simultaneously, The frequency will change at the specified up or down rate.
 - About the setting of the initial up/down frequency

To adjust the frequency starting at a specified frequency other than 0.0 Hz (default initial frequency) after turning on the inverter, specify the desired frequency using F_{258} (initial up/down frequency).
 - About the change of the initial up/down frequency

To make the inverter automatically save the frequency immediately before it is turned off and start operation at that frequency next time power is turned on, set F_{259} (change of initial up/down frequency) to 1 (which changes the setting of F_{258} when power is turned off).
Keep in mind that the setting of F_{258} is changed each time power is turned off.
 - Frequency adjustment range

The frequency can be set from 0.0Hz to F_H (Maximum frequency). The lower-limit frequency will be set as soon as the set frequency clearing function (function number 92, 93) is entered from the input terminal.
 - Minimum unit of frequency adjustment

If F_{702} (Frequency free unit magnification) is set to 1.00, the output frequency can be adjusted in steps of 0.01Hz.

6.5.4 Fine adjustment of frequency setting signal

F470: VI voltage bias

F471: VI voltage gain

- Function

These parameters are used to fine adjust the relation between the frequency setting signal input through the analog input terminal VI and the output frequency.

Use these parameters to make fine adjustments after making rough adjustments using the parameters *F201* to *F204*.

The figure below shows the characteristic of the frequency setting signal input through the VI terminal and that of the output frequency.

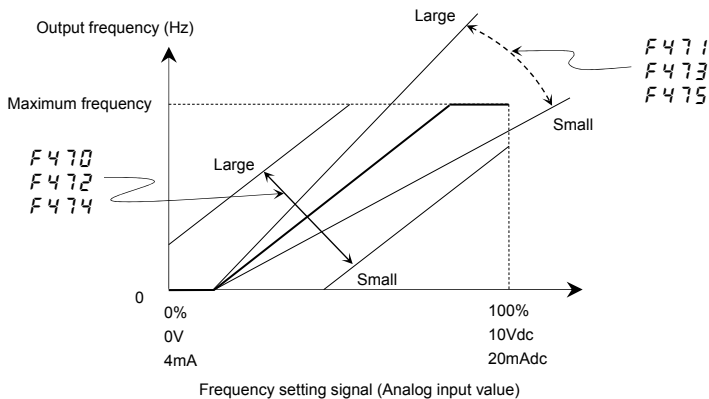

- * Bias adjustment of VI input terminal (*F470*)

Decrease the value in case frequency is output even though the frequency command is 0 (zero) Hz.

- * Gain adjustment of VI input terminal (*F471*)

Increase the value in case the output frequency doesn't reach the maximum frequency even though the maximum voltage and current are applied.

6.6 Operation frequency

6.6.1 Starting frequency

F240: Starting frequency

- Function
The function set with **F240** is put out as soon as operation is started. Use the **F240** parameter when a delay in response of starting torque according to the acceleration/deceleration time is probably affecting operation. Setting the starting frequency to a value from 0.5 to 3Hz is recommended. The occurrence of an overcurrent can be suppressed by setting this frequency below the rated slippage of the motor.

[Parameter setting]

Title	Function	Adjustment range	Default setting
F240	Starting frequency	0.1-10.0 (Hz)	0.5

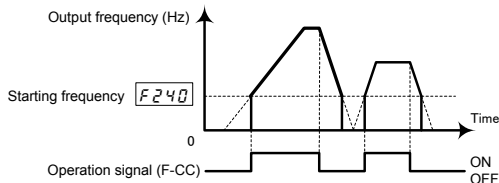

6.6.2 Run/stop control with frequency setting signals

F241: Operation starting frequency

F242: Operation starting frequency hysteresis

- Function
The Run/stop of operation can be controlled simply with frequency setting signals.

[Parameter setting]

Title	Function	Adjustment range	Default setting
F241	Operation starting frequency	0.0- F_H (Hz)	0.0
F242	Operation starting frequency hysteresis	0.0- F_H (Hz)	0.0

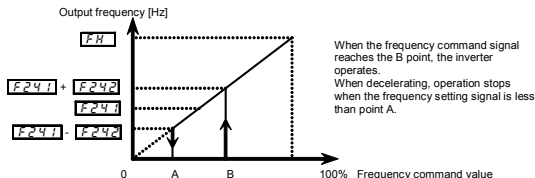

6.7 DC braking

F250: DC braking starting frequency

F251: DC braking current

F252: DC braking time

- Function

A large braking torque can be obtained by applying a direct current to the motor. These parameters set the direct current to be applied to the motor, the application time and the starting frequency.

[Parameter setting]

Title	Function	Adjustment range	Default setting
F250	DC braking starting frequency	0.0- F_H (Hz)	0.0
F251	DC braking current	0.0-100 (%) / (A)	50
F252	DC braking time	0.0-25.5 (s)	1.0

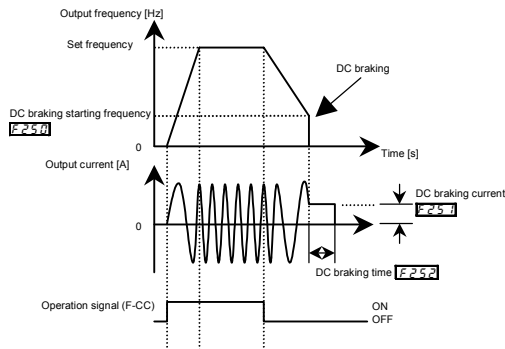

Note1: During DC braking, the overload protection sensitivity of the inverter increases. The DC braking current may be adjusted automatically to prevent tripping.

Note 2: During DC braking, the carrier frequency becomes the setting of parameter **F300** (PWM carrier frequency).

Note 3: DC braking can be done by using terminal input. Input terminal 22: Assign DC braking command (23 is reverse).

DC braking is applied while the terminal is ON, regardless of the **F250**, **F252** settings. Even if the terminal is OFF, DC braking is applied only for the **F252** time.

The amount of DC braking depends on the **F251** settings.

6.8 Time limit for lower-limit frequency operation

F256: Time limit for lower-limit frequency operation

F391: Hysteresis for lower-limit frequency operation

- Function

If operation is carried out continuously at a frequency below the lower-limit frequency ($L L$) for the period of time set with $F 2 5 6$, the inverter will automatically slow down the motor to a stop. At that time, "L L P" is displayed (alternately) on the operation panel.

This function will be canceled if a frequency command above the lower-limit frequency ($L L$) + $F 3 9 1$ (Hz).

[Parameter setting]

Title	Function	Adjustment range	Default setting
$F 2 5 6$	Time limit for lower-limit frequency operation	0.0: Disabled 0.1 - 600.0 (s)	0.0
$F 3 9 1$	Hysteresis for lower-limit frequency operation	0.0- $L L$ (Hz)	0.2

Output frequency [Hz]

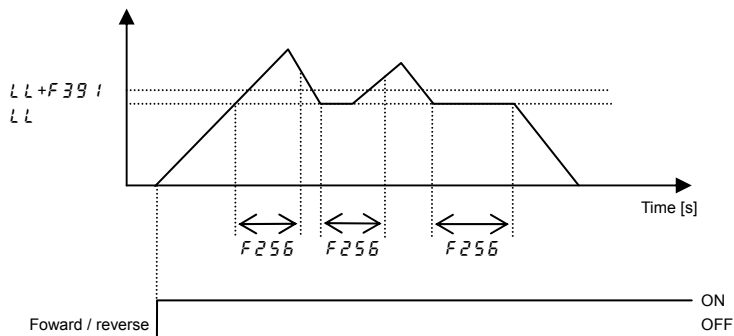

Note: This function is valid when doing forward/reverse switching.

When starting operation, does not operate until output frequency reaches $L L$.

6.9 Jump frequency - Avoiding frequency resonance

F270: Jump frequency

F271: Jumping width

- Function
Resonance due to the natural frequency of the mechanical system can be avoided by jumping the resonant frequency during operation. During jumping, hysteresis characteristics with respect to the jump frequency are given to the motor.

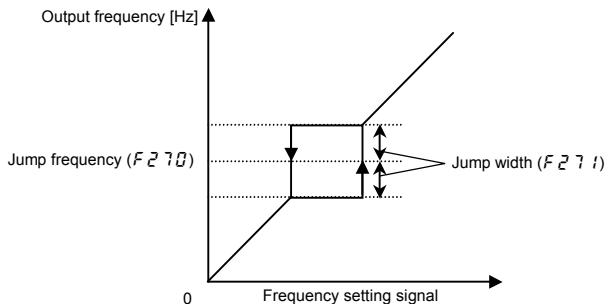

[Parameter setting]

Title	Function	Adjustment range	Default setting
F270	Jump frequency	0.0- F_H (Hz)	0.0
F271	Jump width	0.0-30.0 (Hz)	0.0

Note 1: During acceleration and deceleration, the operation frequency jumps do not occur.

6.10 Preset-speed frequencies

F287 - **F294**: Preset-speed frequency 8 to 15

Refer to section 3.6 for details.

6.11 PWM carrier frequency

F300: PWM carrier frequency

F312: Random mode

F316: Carrier frequency control mode selection

- Function

These parameters are effective in preventing the magnetic noise reduction from the motor, noise reduction, the measure against resonance with load machine, etc.

1) When you reduce the magnetic noise from the motor, increase the **F300**: PWM carrier frequency.

If **F312**: random mode is set up when the **F300** cannot be set up highly, the magnetic noise from the motor is decreased.

2) When you reduce the noise which generates from the inverter, decrease the carrier frequency.

However, the magnetic noise from the motor is increased.

3) When resonating with the load machine and the fan cover of the motor, an effect will be acquired if **F300** is changed.

4) If **F316**: PWM carrier frequency control mode selection is set to "Carrier frequency with automatic reduction" when carrying out the trip by **OH** (overheat) or **OL3** (main module overload), the carrier frequency is reduced automatically and the trip can be avoided. However, the magnetic noise from the motor is increased.

[Parameter setting]

Title	Function	Adjustment range	Default setting
F300	PWM carrier frequency	2-16 (kHz)	12
F312	Random mode	0: Disabled, 1: Automatic setting	0
F316	Carrier frequency control mode selection	0: Carrier frequency without reduction 1: Carrier frequency with automatic reduction	1

Note 1: By **F300** setting and ambient temperature, current reduction may be required.

Refer to the table on the following page.

Note 2: PWM carrier frequency is increased at high output frequency area (guide: 100 Hz or more) for stable operation, even if **F300** is set to low PWM carrier frequency.

Note 3: Random mode is exercised with the low output frequency which a magnetic noise from the motor worries when **F300** is 8kHz or less.

Note 4: If **F316** is set to "Carrier frequency without reduction", **OH** (overheat) or **OL3** (main module overload), occurs. In this case, to avoid the trip, reduce the stall prevention level (**F601**, **F185**) properly.

Load reduction (current reduction) by carrier frequency and ambient temperature

[Three phase 200 V class]

VFNC3	Ambient temperature	Carrier frequency		
		2 - 4 kHz	5 - 12 kHz	13 - 16 kHz
2001P	60°C or less	0.7 A	0.7 A	0.7 A
	50°C or less	1.4 A	1.4 A	1.4 A
2002P	Above 50 ~ 60°C	1.2 A	1.2 A	1.2 A
	50°C or less	2.4 A	2.4 A	2.4 A
2004P	Above 50 ~ 60°C	2.1 A	2.1 A	2.1 A
	40°C or less	4.2 A	3.6 A	3.0 A
2007P	Above 40 ~ 50°C	4.2 A	3.2 A	2.8 A
	Above 50 ~ 60°C	3.7 A	3.2 A	2.8 A
	40°C or less	7.5 A	7.5 A	7.1 A
2015P	Above 40 ~ 60°C	7.5 A	7.1 A	7.1 A
	40°C or less	10.0 A	8.5 A	7.5 A
2022P	Above 40 ~ 60°C	10.0 A	7.5 A	7.5 A
	50°C or less	16.7 A	14.0 A	14.0 A
2037P	Above 50 ~ 60°C	16.2 A	13.8 A	12.8 A

[Single phase 200 V class]

VFNC3S	Ambient temperature	Carrier frequency		
		2 - 4 kHz	5 - 12 kHz	13 - 16 kHz
2001PL	60°C or less	0.7 A	0.7 A	0.7 A
2002PL	50°C or less	1.4 A	1.4 A	1.4 A
	Above 50 ~ 60°C	1.2 A	1.0 A	1.0 A
2004PL	50°C or less	2.4 A	2.4 A	2.4 A
	Above 50 ~ 60°C	2.0 A	1.8 A	1.8 A
2007PL	50°C or less	4.2 A	3.2 A	2.8 A
	Above 50 ~ 60°C	3.6 A	2.5 A	2.2 A
2015PL	40°C or less	7.5 A	7.5 A	7.1 A
	Above 40 ~ 50°C	7.5 A	7.1 A	7.1 A
	Above 50 ~ 60°C	7.1 A	7.1 A	6.6 A
2022PL	40°C or less	10.0 A	9.1 A	8.0 A
	Above 40 ~ 50°C	10.0 A	7.5 A	7.5 A
	Above 50 ~ 60°C	7.5 A	7.5 A	7.0 A

[Single phase 100 V class]

VFNC3S	Ambient temperature	Carrier frequency		
		2 - 4 kHz	5 - 12 kHz	13 - 16 kHz
1001P	60°C or less	0.7 A	0.7 A	0.7 A
1002P	50°C or less	1.4 A	1.4 A	1.4 A
	Above 50 ~ 60°C	1.2 A	1.0 A	1.0 A
1004P	50°C or less	2.4 A	2.4 A	2.4 A
	Above 50 ~ 60°C	2.0 A	1.8 A	1.8 A
1007P	60°C or less	4.2 A	4.0 A	4.0 A

Note 1: : Inverter rated output current (Carrier frequency 4 kHz or less, ambient temperature 40°C or less)

Note 2: When ambient temperature is above 40°C, use after remove the caution label on the top of the inverter.

The current value on the table is the value when the inverter is general installed and with top caution label for 40°C or less, without top caution label for above 40°C.

6.12 Trip-less intensification

6.12.1 Auto-restart (Restart of coasting motor)

F301: Auto-restart control selection



Caution



Mandatory
action

- Stand clear of motors and mechanical equipment
If the motor stops due to a momentary power failure, the equipment will start suddenly when power is restored. This could result in unexpected injury.
- Attach warnings about sudden restart after a momentary power failure on inverters, motors and equipment for prevention of accidents in advance.

• Function

The **F301** parameter detects the rotating speed and rotational direction of the motor during coasting at the event of momentary power failure, and then after power has been restored, restarts the motor smoothly (motor speed search function). This parameter also allows commercial power operation to be switched to inverter operation without stopping the motor.

During operation, "r t r 4" is displayed. The acoustic noise of the motor could be increased.

[Parameter setting]

Title	Function	Adjustment range	Default setting
F301	Auto-restart control selection	0: Disabled 1: At auto-restart after momentary stop 2: At ST terminal off and on 3: 1 + 2 4: At start-up	0

* If the motor is restarted in retry mode, this function will operate, regardless of the setting of this parameter.

1) Auto-restart after momentary power failure (Auto-restart function)

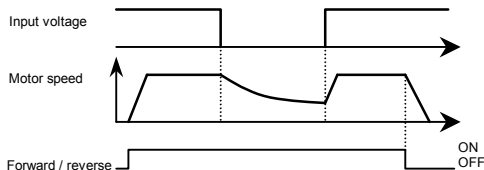

★ Setting **F301** to **1** or **3**: This function operates after power has been restored following detection of an undervoltage by the main circuits and control power.

2) Restarting motor during coasting (Motor speed search function)

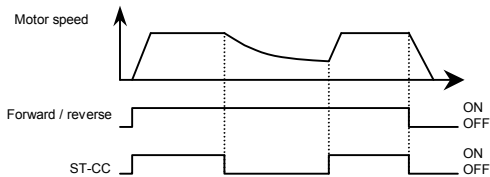

- ★ Setting $F301$ to 2 or 3: This function operates after the ST-CC terminal connection has been opened first and then connected again.

Note 1: The terminal function ST needs to be assigned to an input terminal, using the parameters $F111$ to $F115$.

3) Motor speed search at starting

When $F301$ is set to 4, a motor speed search is performed each time operation is started.

This function is useful especially when the motor is not operated by the inverter but it is running because of external force.

Warning!!

- At restart, it takes about 1 second for the inverter to check to see the number of revolutions of the motor.
For this reason, the start-up takes more time than usual.
- Use this function when operating a system with one motor connected to one inverter.
This function may not operate properly in a system configuration with multiple motors connected to one inverter.
- In case of using this function, do not set the output phase failure detection selection ($F505 = 1, 2$).

Application to a crane or hoist

The crane or hoist may have its load moved downward during the above waiting time from input of the operation starting command to the restart of the motor. To apply the inverter to such machines, therefore, set the auto-restart control mode selection parameter to " $F301 = 0$ " (Disabled). Do not use the retry function, either.

Note 2: It is not malfunction that abnormal noise might be heard from the motor during the motor speed search at the auto-restart.

6.12.2 Regenerative power ride-through control (Deceleration stop)

F302: Regenerative power ride-through control (Deceleration stop)

- Function
 - 1) Regenerative power ride-through control:
When momentary power failure occurs during operation, this function makes operation continue using the regeneration energy from a motor.
 - 2) Deceleration stop during power failure:
When momentary power failure occurs during operation, this function stops the motor quickly and compulsorily using the regeneration energy from the motor.
 - Deceleration time varies according to load.
 - When deceleration stop during power failure is operated, the message “SEOP” displays on the operation panel.
 - After the forced stop, the inverter remains static until you put off the operation command momentarily.

[Parameter setting]

Title	Function	Adjustment range	Default setting
F302	Regenerative power ride-through control (Deceleration stop)	0: Disabled 1: Regenerative power ride-through control 2: Deceleration stop during power failure	0

Note 2: Even if these functions are used, a motor may coast according to load conditions.

In this case, use the auto-restart function (F301) for the smooth restart after power supply is restored.

- An example of setting when **F302 = 1**
[When power is interrupted]

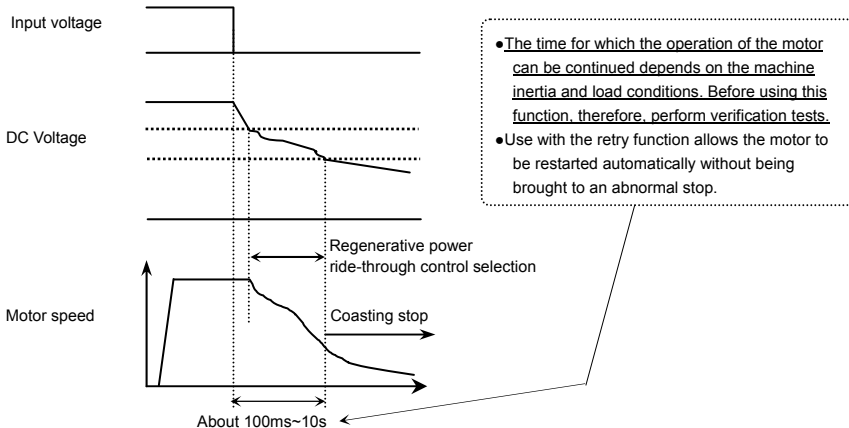

Note 4: If power is interrupted during deceleration stop, power ride-through control will not be performed.

[If momentary power failure occurs]

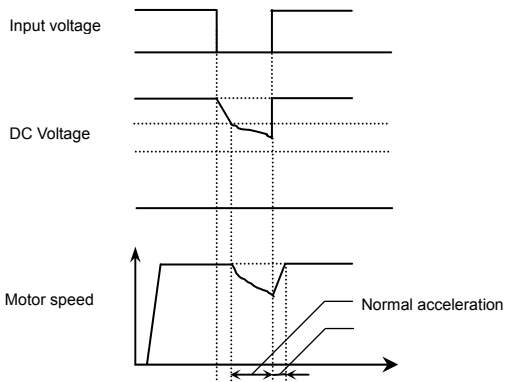

Note 5: If momentary power failure occurs during deceleration stop, power ride-through control will not be performed.

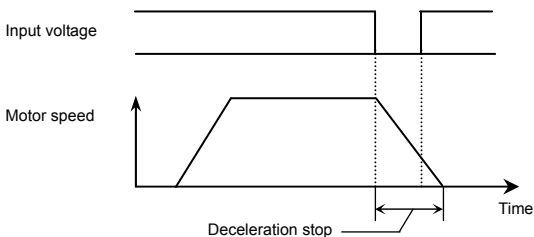

■ An example of setting when $F302=2$



- Even after the recovery from an input power failure, the motor continues deceleration stop. If the DC voltage falls below a certain level, however, control will be stopped and the motor will coast.
- If the voltage in main circuit falls below main circuit undervoltage ($F70FF$) level at operation deceleration stop during power failure, the motor will coast and inverter displays $SEOP$ and 0.0 alternately. The motor continues coasting even after power supply is restored.

6.12.3 Retry function

F303: Retry selection (number of times)

 Caution	
 Mandatory action	<ul style="list-style-type: none"> Do not go near the motor in alarm-stop status when the retry function is selected. The motor may suddenly restart, which could result in injury. Take measures for safety, e.g. attach a cover to the motor, to prevent accidents if the motor suddenly restarts.

- Function
This parameter resets the inverter automatically when the inverter gives an alarm. During the retry mode, the motor speed search function operated automatically as required and thus allows smooth motor restarting.

[Parameter setting]

Title	Function	Adjustment range	Default setting
<i>F303</i>	Retry selection (number of times)	0: Disabled, 1-10 times	0

The likely causes of tripping and the corresponding retry processes are listed below.

Cause of tripping	Retry process	Canceling conditions
Momentary power failure	Up to 10 times in succession	The retry function will be canceled at once if tripping is caused by an unusual event other than: momentary power failure, overcurrent, overvoltage or overload. This function will also be canceled if retrying is not successful within the specified number of times.
Overcurrent	1st retry: About 1 sec after tripping	
Overvoltage	2nd retry: About 2 sec after tripping	
Overload	3rd retry: About 3 sec after tripping	
Overheating	⋮	
	10th retry: About 10 sec after tripping	

- ★ Retry is only done when the following trips occur.

OC 1, OC 2, OC 3, OP 1, OP 2, OP 3, OL 1, OL 2, OL 3, OH

- ★ Protective operation detection relay signals (FLA, FLB, FLC terminal signals) are not sent during use of the retry function. (Default setting)
- ★ To allow a signal to be sent to the protective action detection relay (FLA, B and C terminals) even during the retry process, assign function numbers *146* or *147* to *F132*.
- ★ A virtual cooling time is provided for overload tripping (*OL 1, OL 2*).
In this case, the retry function operates after the virtual cooling time and retry time.
- ★ In the event of tripping caused by an overvoltage (*OP 1 - OP 3*), the retry function will not be activated until the voltage in the DC section comes down to a normal level.
- ★ In the event of tripping caused by overheating (*OH*), the retry function will not be activated until the temperature in the inverter comes down low enough for it to restart operation.
- ★ During retrying, the blinking display will alternate between *r L r Y* and the monitor display specified by status monitor display mode selection parameter *F710*.
- ★ The number of retries will be cleared if the inverter is not tripped for the specified period of time after a successful retry.
"A successful retry" means that the inverter output frequency reaches the command frequency without causing the inverter to re-trip.

6.12.4 Avoiding overvoltage tripping

F305: Overvoltage limit operation

- Function
 - These parameters are used to keep the output frequency constant or increase it to prevent overvoltage tripping in case the voltage in the DC section rises during deceleration or varying speed operation. The deceleration time during overvoltage limit operation may increase above the designated time.

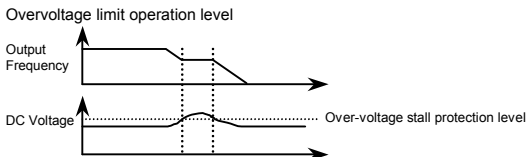

[Parameter setting]

Title	Function	Adjustment range	Default setting
<i>F305</i>	Overvoltage limit operation (Slowdown stop mode selection)	0: Enabled 1: Disabled 2: Enabled (Quick deceleration control) 3: Enabled (Dynamic quick deceleration control)	2

- ★ If *F305* is set to 2 (quick deceleration control), the inverter will increase the voltage to the motor (over-excitation control) to increase the amount of energy consumed by the motor when the voltage reaches the overvoltage protection level, and therefore the motor can be decelerated more quickly than normal deceleration.
- ★ If *F305* is set to 3 (dynamic quick deceleration control), the inverter will increase the voltage to the motor (over-excitation control) to increase the amount of energy consumed by the motor as soon as the motor begins to slow down, and therefore the motor can be decelerated still more quickly than quick deceleration.
- ★ During overvoltage limit operation, the overvoltage pre-alarm (*P* blinks) is displayed.

6.12.5 Output voltage adjustment/Supply voltage correction

ULU: Base frequency voltage 1

F307: Supply voltage correction (output voltage limitation)

- Function
 - Supply voltage correction: Prevent torque decline during low-speed operation. Maintains a constant V/F ratio, even when the input voltage fluctuates.
 - Output voltage limitation: Limits the voltage to prevent outputting the voltage over base frequency voltage (ULU).
- Applied when operating a special motor with low induced voltage.

[Parameter setting]

Title	Function	Adjustment range	Default setting
ULU	Base frequency voltage1	50-330 (V)	*1
F307	Supply voltage correction (output voltage limitation)	0: Supply voltage uncorrected, output voltage limited 1: Supply voltage corrected, output voltage limited 2: Supply voltage uncorrected, output voltage unlimited 3: Supply voltage corrected, output voltage unlimited	*1

*1: Default setting values vary depending on the setup menu setting. Refer to section 11.5.

- ★ For supply voltage uncorrected (F307=0 or 2), the output voltage will change in proportion to the input voltage.
- ★ Even if the base frequency voltage (ULU parameter) is set over the input voltage, the output voltage will not outputted over the input voltage.
- ★ When the V/F control mode selection parameter (P4) is set to any number between 2 to 4, the supply voltage is corrected regardless of the setting of F307.

[F307=0: No voltage compensation/output voltage limited]

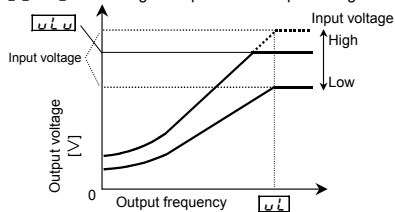

* The above applies when V/F control mode selection parameter P_L is set to "0" or "1".

[F307=1: Voltage compensation/output voltage limited]

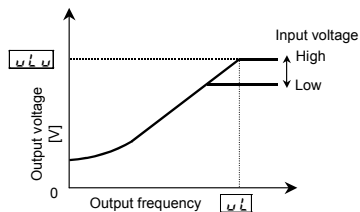

[F307=2: No voltage compensation/no output voltage limited]

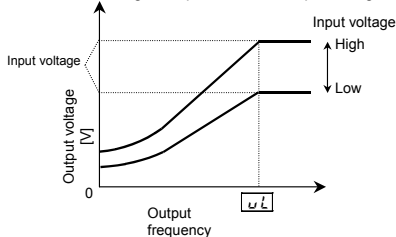

* The above applies when V/F control mode selection parameter P_L is set to "0" or "1".

[F307=3: Voltage compensation/no output voltage limited]

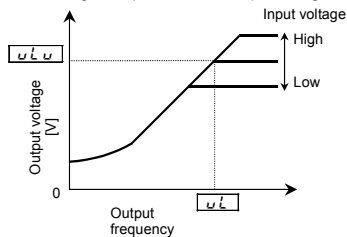

* Note that even if the input voltage is set less than uLv , for a base frequency of uL or higher output frequency, then an output voltage over uLv occurs.

6.12.6 Reverse-run prohibition

F311: Reverse-run prohibition

- Function
This function prevents the motor from running in the forward or reverse direction when it receives the wrong operation signal.

[Parameter setting]

Title	Function	Adjustment range	Default setting
<i>F311</i>	Reverse-run prohibition	0: Forward/reverse run permitted 1: Reverse run prohibited 2: Forward run prohibited	0

6.13 PID control

F359: PID control waiting time

F360: PID control

F362: Proportional gain

F363: Integral gain

F366: Differential gain

F380: PID forward/reverse characteristics selection

- Function
Using feedback signals (4 to 20mA, 0 to 5 V, 0 to 10V) from a detector, process control can be exercised, for example, to keep the airflow, amount of flow or pressure constant.
Or, it is also possible to always set 0 for integral and differential at terminal input.

[Parameter setting]

Title	Function	Adjustment range	Default setting
<i>F359</i>	PID control waiting time	0-2400 [s]	0
<i>F360</i>	PID control	0: Disabled, 1: Enabled	0
<i>F362</i>	Proportional gain	0.01-100.0	0.30
<i>F363</i>	Integral gain	0.01-100.0	0.20
<i>F366</i>	Differential gain	0.00-2.55	0.00
<i>F380</i>	PID forward/reverse characteristics selection	0: Forward 1: Reverse	0

1) Example of External connection

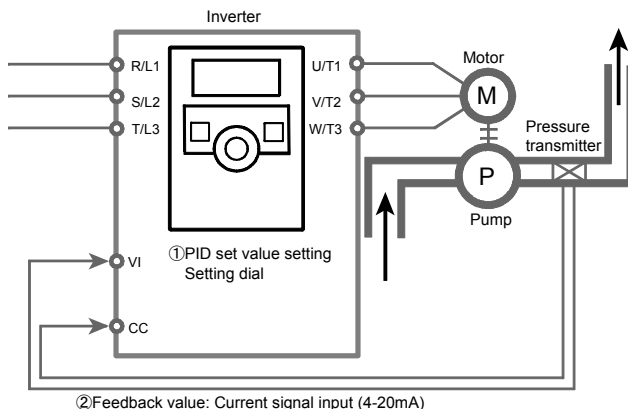

2) Selecting PID set value and feedback value

PID set value (frequency) and feedback value can be combined as follows for the PID control.

①PID set value	②Feedback value
Frequency setup mode selection: $F \ P \ Q \ d$ Note 1 1: Setting dial 1 (press in center to save) 2: Setting dial 2 (save even if power is off) 3: RS485 communication 5: UP/DOWN from external logic input	Analog/logic input Selection (VI terminal): $F \ i \ Q \ g$ Note 2 0: Voltage signal input (0-10V) 1: Current signal input (4-20mA) 3: Voltage signal input (0-5V)
Preset-speed operation ($C \ P \ Q \ d = 0$, $F \ P \ Q \ d$ are all possible)	

Note 1: Do not set $F \ P \ Q \ d = 0$ (Terminal VI).

Note 2: Do not set $F \ i \ Q \ g = 2$ (Logic input).

3) Setting PID control

Set $F \ 3 \ 6 \ 0$: PID control= 1(Enabled).

(1) Set $P \ C \ C$: Acceleration time and $d \ E \ C$: Deceleration time to the system fitting values.

(2) To limit the output frequency, set parameters $U \ L$: Upper limit frequency and $L \ L$: Lower limit frequency.

If PID set value are set with the setting dial, however, the process quantity setting range will be limited by the settings of $U \ L$ and $L \ L$.

Note 3: Assigning the terminal function number 36 (PID control prohibition) to an input terminal. PID control function is stopped temporarily while the terminal is ON.

4) Adjusting the PID control gain level

Adjust the PID control gain level according to the PID set value, the feedback value and the object to be controlled.

The following parameters are provided for gain adjustment:

Title	Function	Adjustment range	Default setting
F 362	Proportional gain (P)	0.01 - 100.0	0.30
F 363	Integral gain (I)	0.01 - 100.0	0.20
F 365	Derivative gain (D)	0.00 - 2.55	0.00

F 362 (P-gain adjustment parameter)

This parameter adjusts the proportional gain level during PID control. A correction value proportional to the particular deviation (the difference between the PID set value and the feedback value) is obtained by multiplying this deviation by the parameter setting.

A larger P-gain adjustment value gives faster response. Too large an adjustment value, however, results in an unstable event such as hunting.

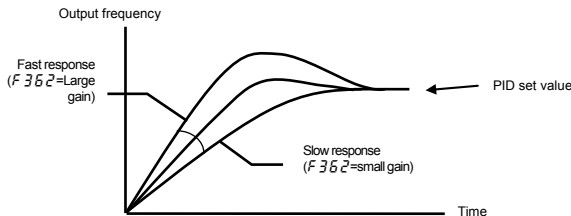

F 363 (I-gain adjustment parameter)

This parameter adjusts the integral gain level during PID control. Any deviations remaining unremoved during proportional action are cleared to zero (residual deviation offset function).

A larger I-gain adjustment value reduces residual deviations. Too large an adjustment value, however, results in an unstable event such as hunting.

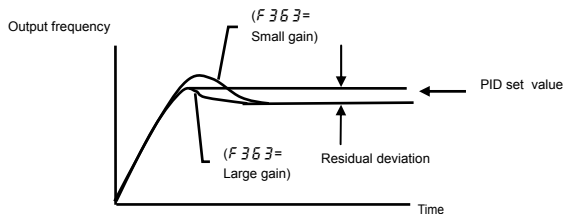

- ★ Assign the terminal function number 52 (PID integral/derivative) to an input terminal, when the input terminal is ON, it is possible to calculate integral/derivative amounts always as 0 (zero).

F355 (D-gain adjustment parameter)

This parameter adjusts the differential gain level during PID control. This gain increases the speed of response to a rapid change in deviation (difference between the PID set value and the feedback value). Note that setting the gain more than necessary may cause fluctuations in output frequency, and thus operation to become unstable.

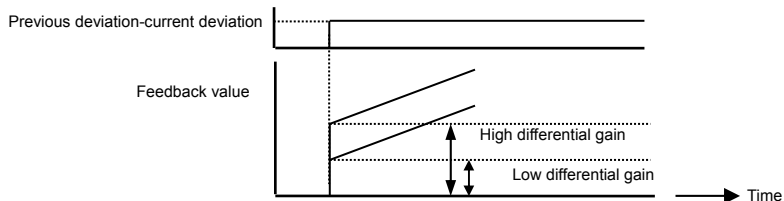

- ✦ Assign the input terminal function number 52 (PID integral/derivative) to an input terminal, when the input terminal is ON, it is possible to calculate integral/derivative amounts always as 0 (zero).

5) Adjusting feedback value

To use external feedback value (VI terminal), perform voltage-scaling adjustments (input point setting) as required. Refer to section 6.5.2 for details.

Example of 0 - 10 Vdc voltage input setting ($F109=0$)

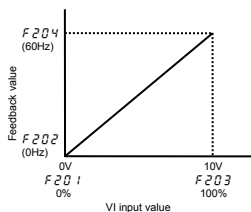

Example of 0 - 5 Vdc voltage input setting ($F109=3$)

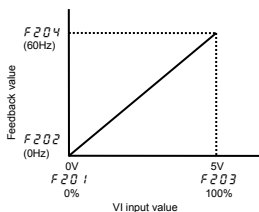

Example of 4 - 20 mAdc current input setting ($F109=1$)

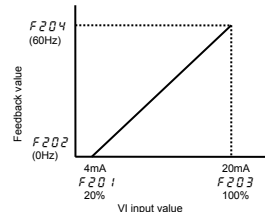

6) Setting the time elapsed before PID control starts

You can specify a waiting time for PID control to prevent the inverter from starting PID control before the control system becomes stable, for example, after start-up.

The inverter ignores the feedback value, carries out operation at the frequency determined by the frequency command value for the period of time specified with $F359$ and enters the PID control mode after a lapse of the specified time.

7) PID control forward/reverse characteristic switch

PID input characteristics can be reversed.

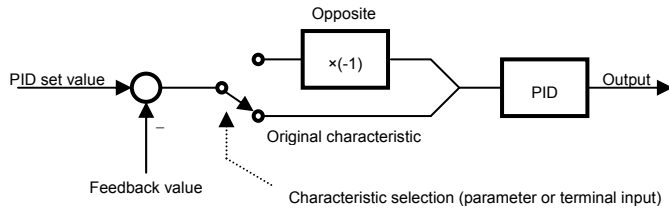

- When characteristic is reversed according to parameters
Set $F\ 3\ 8\ 0$: PID forward/reverse characteristics selection = 1 (Reverse).
 - When characteristic is reversed using logic input terminal
Assign the terminal function number 54/55 (PID characteristics switching) to an input terminal.
- (Caution) If reverse characteristics is selected for $F\ 3\ 8\ 0$ and terminal input at the same time, they become forward characteristic.

6.14 Setting motor constants

F400: Auto-tuning

F415: Motor rated current

F401: Slip frequency gain

F416: Motor no-load current

F402: Automatic torque boost value

F417: Motor rated speed

F405: Motor rated capacity

F459: Load inertia moment ratio

To use vector control, automatic torque boost and automatic energy saving, motor constant setting (motor tuning) is required. The following three methods are available to set motor constants.

- Using the torque boost setting macro function (**RU2**) for setting the V/F control mode selection (**P1**) and auto-tuning (**F400**) at the same time
- Setting V/F control mode selection (**P1**) and auto-tuning (**F400**) independently
- Combining the V/F control mode selection (**P1**) and manual tuning

Caution:

If the settings for V/F control mode selections **P1** are **2**: automatic torque boost control, **3**: vector control, **4**: energy saving.

Look at the motor's name plate and set the following parameters.

- UL**: Base frequency 1 (rated frequency)
- ULV**: Base frequency voltage 1 (rated voltage)
- F405**: Motor rated capacity
- F415**: Motor rated current
- F417**: Motor rated speed

Set the other motor constants as necessary.

[Selection 1: Setting by parameter setting macro torque boost]

This is the easiest of the available methods. It conducts vector control and auto-tuning at the same time.

Be sure to set the motor for **UL**, **ULV**, **F405**, **F415**, **F417**.

Set **RU2** to **1** (Automatic torque boost + auto-tuning)

Set **RU2** to **2** (Vector control + auto-tuning)

Set **RU2** to **3** (Energy-saving + auto-tuning)

Refer to section 5.4 for details of the setting method.

[Selection 2: Setting vector control and auto-tuning independently]

Set vector control, automatic torque boost, and energy saving and auto-tuning individually.

After setting $P\bar{L}$ (V/F control mode selection), auto-tuning occurs.

Set the auto-tuning parameter $F400$ to $\bar{2}$ (Auto-tuning enabled)

[Parameter setting]

Title	Function	Adjustment range	Default setting
$F400$	Auto-tuning	0: Auto-tuning disabled 1: Initialization of $F400$ (reset to 0) 2: Auto-tuning executed (after execution: 0)	0

Set $F400$ to $\bar{2}$ before the start of operation. Tuning is performed at the start of the motor.

+ Precautions on auto-tuning

- (1) Conduct auto-tuning only after the motor has been connected and operation completely stopped.
If auto-tuning is conducted immediately after operation stops, the presence of a residual voltage may result in abnormal tuning.
- (2) Voltage is applied to the motor during tuning even though it barely rotates. During tuning, " $R\bar{L}n\bar{I}$ " is displayed on the operation panel.
- (3) Tuning is performed when the motor starts for the first time after $F400$ is set to $\bar{2}$.
Tuning is usually completed within three seconds. If it is aborted, the inverter trips with the display of $\bar{E}\bar{L}n\bar{I}$ and no constants are set for that motor. Set $F400$ to $\bar{0}$ and perform manual tuning with selection 3.
- (4) High-speed motors, high-slip motors or other special motors cannot be auto-tuned. For these motors, perform manual tuning using Selection 3 described below.
- (5) Provide cranes and hoists with sufficient circuit protection such as mechanical braking. Without sufficient circuit protection, the resulting insufficient motor torque during tuning could create a risk of machine stalling/falling.
- (6) If auto-tuning is impossible or an " $\bar{E}\bar{L}n\bar{I}$ " auto-tuning error is displayed, perform manual tuning with Selection 3.

[Selection 3: Setting vector control and manual tuning independently]

If an " $\bar{E}\bar{L}n\bar{I}$ " tuning error is displayed during auto-tuning or when vector control characteristics are to be improved, set independent motor constants.

[Parameter setting]

Title	Function	Adjustment range	Default setting
$F401$	Slip frequency gain	0-250 (%)	50
$F402$	Automatic torque boost value	0.1-30.0 (%)	Depends on the capacity (Refer to section 11.4)
$F405$	Motor rated capacity	0.01-5.50 (kW)	
$F415$	Motor rated current	0.1-30.0 (A)	
$F416$	Motor no-load current	10-90 (%)	
$F417$	Motor rated speed	100-32000 (min ⁻¹)	*1
$F459$	Load inertia moment ratio	0.1-100.0 (times)	1.5
$\bar{L}Hr$	Motor electronic thermal protection level 1	10-100 (%) / (A)	100

*1: Default setting values vary depending on the setup menu setting. Refer to section 11.5.

Setting procedure Adjust the following parameters:

- F401**: Set the compensation gain for the slipping of the motor. A higher slip frequency reduces motor slipping correspondingly. After setting **F417**, set **F401** to adjust in detail. Be careful as inputting a value larger than necessary causes hunting and other unstable operation.
- F402**: Adjust the primary resistive component of the motor. Decreases in torque due to a possible voltage drop during low-speed operation can be suppressed by setting a large value in this parameter. Be careful as setting a value larger than necessary may lead to an increased current causing a trip at low speeds. (Perform adjustments according to the actual operation.)
- F405**: Set the motor's rated capacity according to the motor's name plate or test report.
- F415**: Set the rated current of the motor. For the rated current, see the motor's nameplate or test report.
- F416**: Set the ratio of the no-load current of the motor to the rated current. Enter the value in % that is obtained by dividing the no-load current specified in the motor's test report by the rated current. Increasing this value increases the excitation current.
- F417**: Set the rated rotational speed of the motor. For the rated current, see the motor's nameplate or test report.

★ Adjustment method for the moment of inertia of the load

F459: Adjusts the excess response speed. A larger value gives a smaller overshoot at the acceleration/deceleration completion point. In the default settings, the moment of inertia of the load (including the motor shaft) value is optimally set considering a motor shaft of 1x. When the moment of inertia of the load is not 1x, set a value that matches that actual moment of inertia of the load.

tHr: If the rated capacity of the motor is one size smaller than that of the inverter, lower the thermal protective level according to the rated current of the motor.

* Sensorless vector control may not operate properly if the motor capacity differs from the applicable rated capacity of the inverter by more than two grades.

Caution:

If a combination of the inverter rating and the motor capacity is different for more than 2 items, vector control may not operate correctly.

Note 1: **F412**, **F458**, **F460**, **F461**, **F462**, **F467**, **F480**, **F485**, and **F495** (Motor specific coefficient 1-9) are parameters for manufacturer settings. Do not change the parameters.

6.15 2nd acceleration/deceleration

6.15.1 Switching acceleration/deceleration time 1 & 2

F500: Acceleration time 2

F501: Deceleration time 2

F505: Acceleration/deceleration 1 & 2 switching frequency

- Function
Acceleration and deceleration times can be set individually. Select from the following two methods for selecting and switching.
 - 1) Switching by frequency
 - 2) Switching by terminal

[Parameter setting]

Title	Function	Adjustment range	Default setting
F500	Acceleration time 2	0.0 - 3000 (s)	10.0
F501	Deceleration time 2	0.0 - 3000 (s)	10.0

- 1) Switching according to frequency (automatically switching from the set frequency to the acceleration/deceleration time)

[Parameter setting]

Title	Function	Adjustment range	Default setting
F505	Acceleration/deceleration 1 & 2 switching frequency	0.0 (disabled), 0.1-44	0.0

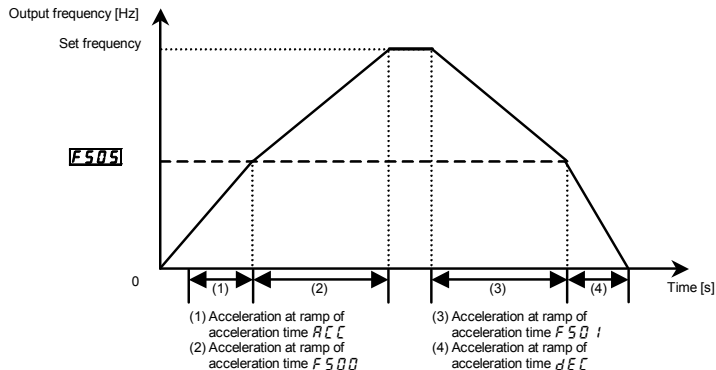

2) Switching according to terminal (switching acceleration/deceleration time by external terminal)

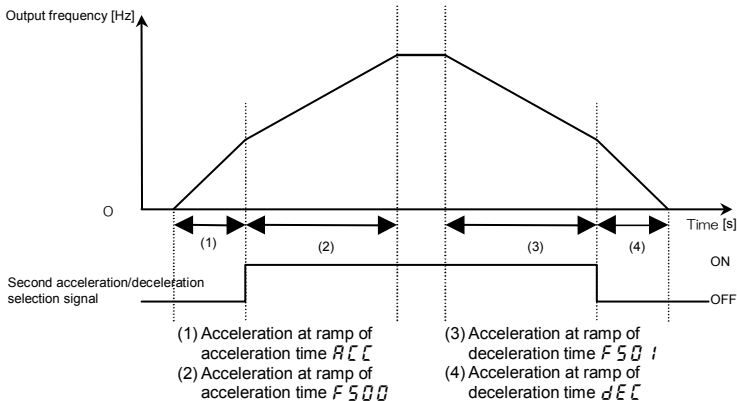

■ Parameter configuration method

- a) Method of operation from terminal input
 Set run operation selection LRd to 0 (terminal block).
- b) Set the second acceleration/deceleration switching to any input terminal.

The following shows an example of setting to input terminal S2.

Title	Function	Adjustment range	Setting
$F114$	Input terminal selection 4A (S2)	0 ~ 201	24: AD2 (2nd acceleration/deceleration)

Setting value 25 is reverse signal.

6.15.2 Acceleration/deceleration pattern setting

$F502$: Acceleration/deceleration 1 pattern

$F503$: Acceleration/deceleration 2 pattern

- Function
 Select a acceleration and deceleration pattern appropriate for the application.

Parameter setting

Title	Function	Adjustment range	Default setting
$F502$	Acceleration/deceleration 1 pattern	0: Linear	0
$F503$	Acceleration/deceleration 2 pattern	1: S-pattern 1 2: S-pattern 2	0

1) Linear acceleration/deceleration

Normal acceleration/deceleration pattern.
Normally, this setting can be used.

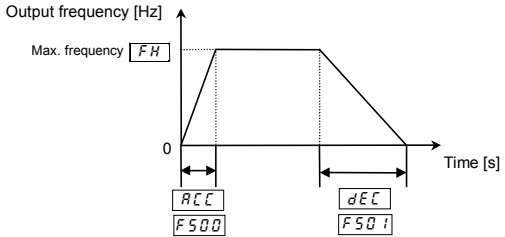

2) S-pattern acceleration/deceleration 1

Select this pattern to accelerate/decelerate the motor rapidly to an output frequency over 60Hz or to minimize the shocks applied during acceleration/deceleration. Perfect for conveyance machinery.

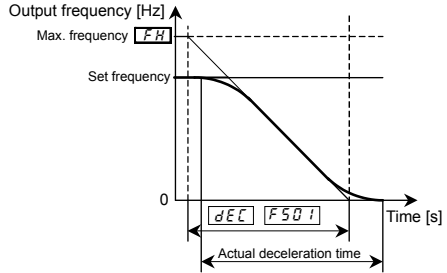
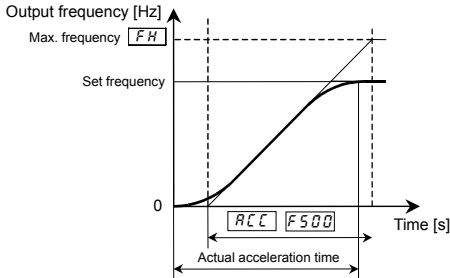

3) S-pattern acceleration/deceleration 2

Motor acceleration torque increases slowly in areas with a small weak magnetic field. Perfect for operation of high-speed spindles.

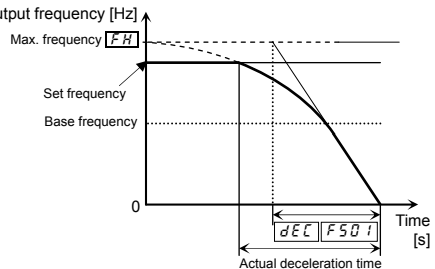
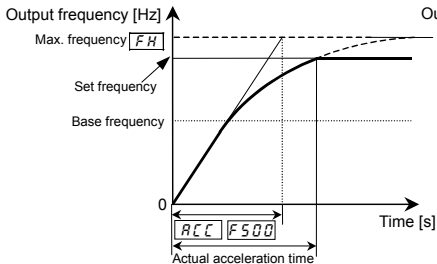

6.16 Protection functions

6.16.1 Setting motor electronic thermal protection

EHr: Motor electronic-thermal protection level 1

F173: Motor electronic-thermal protection level 2

F507: Motor 150% overload detection time

F632: Electronic-thermal memory

- Function
This parameter allows selection of the appropriate electronic thermal protection characteristics according to the particular rating and characteristics of the motor.

[Parameter setting]

Title	Function	Adjustment range	Default setting
EHr	Motor electronic-thermal protection level 1	10-100 (%) / (A)	100
F173	Motor electronic-thermal protection level 2	10-100 (%) / (A)	100
F507	Motor 150% overload detection time	10-2400 (s)	300
F632	Electrical-thermal memory	0: Disabled, 1: Enabled	0



Refer to section 3.5 for details.

Note : The 100% standard value is the rated output current indicated on the nameplate.

6.16.2 Setting of stall prevention level

F501: Stall prevention level 1

F185: Stall prevention level 2

 Caution	
 Prohibited	<ul style="list-style-type: none"> Do not set the stall prevention level (F501) extremely low. If the stall prevention level parameter (F501) is set at or below the no-load current of the motor, the stall preventive function will be always active and increase the frequency when it judges that regenerative braking is taking place. Do not set the stall prevention level parameter (F501) below 30% under normal use conditions.

- Function
This parameter adjusts the output frequency by activating a current stall prevention function against a current exceeding the **F501**-specified level.

[Parameter setting]

Title	Function	Adjustment range	Default setting
<i>F601</i>	Stall prevention level 1	10-199 (%) / (A), 200: Disabled	150
<i>F185</i>	Stall prevention level 2		

[Display during operation of the stall prevention]

During an \overline{OL} alarm status, (that is, when there is a current flow in excess of the stall prevention level), the output frequency changes. At the same time, to the left of this value, "L" is displayed flashing on and off.

Example of display

- ★ The switching from *F601* to *F185* can be performed by entering a command through terminals. Refer to section 6.4.1 for details.

Note. The 100% standard value is the rated output current indicated on the nameplate.

6.16.3 Inverter trip retention

F602: Inverter trip retention selection

- Function
If the inverter trips, this parameter will retain the corresponding trip information. Trip information that has thus been stored into memory can be displayed, even after power has been reset.

[Parameter setting]

Title	Function	Adjustment range	Default setting
<i>F602</i>	Inverter trip retention selection	0: Cleared with power off 1: Retained with power off	0

- ★ The causes of up to four trips that occurred in the past can be displayed in status monitor mode. (Refer to section 8.3)
- ★ Data displayed in status monitor mode when the inverter is tripped is cleared when power is turned off. Check the details monitor for the history of past trips. (Refer to section 8.2.2)
- ★ Trip records are retained even if power is turned off and turned back on during retry operation.

■ Flow of operation when $F602 = 1$

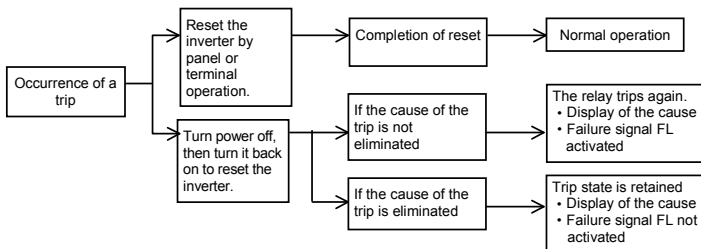

6.16.4 Emergency stop

F603: Emergency stop selection

- Function
Set the stop method for an emergency. When operation stops, a trip occurs (E displays) and failure signal FL operates. Also, when **F603** is set to 2 (emergency DC braking stop) set **F251** (DC braking amount) and **F252** (DC braking time).

1) Emergency stop from terminal

Emergency stop occurs at contact a or b. Follow the procedure below to assign a function to an input terminal and select a stop method.

[Parameter setting]

Title	Function	Adjustment range	Default setting
F603	Emergency stop selection	0: Coast stop 1: Slowdown stop 2: Emergency DC braking	0
F251	DC braking current	0 - 100(%)	50
F252	DC braking time	0.0-25.5 (s)	1.0

Setting example) When assigning the emergency stop function to S2 terminal

Title	Function	Adjustment range	Setting
F114	Input terminal selection 4A (S2)	0 - 201	20: EXT (Emergency stop by external signal)

Setting value 21 is reverse signal.

Note 1) Emergency stopping via the specified terminal is possible, even during panel operation.

2) Emergency stopping from the operation panel

Emergency stopping from the operation panel is possible

by pressing the STOP key on the panel twice while the inverter is not in the panel control mode.

(1) Press the STOP key..... "E0FF" will blink.

(2) Press the STOP key once again Operation will come to a trip stop in accordance with the setting of the F003 parameter.

After this, "E" will be displayed and a failure detection signal generated (FL relay deactivated).

Note: While an emergency stop signal is input at a terminal, the trip cannot be reset. Clear the signal and then reset the trip.

6.16.5 Output phase failure detection

F005: Output phase failure detection selection

- Function

This parameter detects inverter output Phase failure. If the Phase failure status persists for one second or more, the tripping function and the FL relay will be activated. At the same time, a trip information EPH0 will also be displayed.

Set F005 to 2 to open the motor-inverter connection by switching commercial power operation to inverter operation.

Detection errors may occur for special motors such as high-speed motors.

F005=0: No tripping (FL relay deactivated).

F005=1: With the power on, the phase failure detection is enabled only at the start of the first operation. The inverter will trip if the Phase failure status persists for one second or more.

F005=2: The inverter checks for output phase failures each time it starts operation. The inverter will trip if the Phase failure status persists for one second or more.

Note: A check for output phase failures is made during auto-tuning, regardless of the setting of this parameter.

[Parameter setting]

Title	Function	Adjustment range	Default setting
F005	Output phase failure detection selection	0: Disabled 1: At start-up (only one time after power on) 2: At start-up (each time)	0

6.16.6 Input phase failure detection

F608: Input phase failure detection selection

- Function

This parameter detects inverter input Phase failure. If the abnormal voltage status of main circuit capacitor persists for few minutes or more, the tripping function and the FL relay will be activated. Trip display is *EPH 1*. Detection may not be possible when operating with a light load, or when the motor capacity is smaller than the inverter capacity.

If the power capacity is larger than the inverter capacity (more than 200kVA or more than 10 times), detection errors may occur. If this actually happens, install an input AC or DC reactor.

F608=0: No tripping (Failure signal FL not activated)

F608=1: Phase failure detection is enabled during operation. The inverter will trip if the abnormal voltage status of main circuit capacitor persists for few minutes or more. (Failure signal FL activated)

[Parameter setting]

Title	Function	Adjustment range	Default setting
<i>F608</i>	Input phase failure detection selection	0: Disabled, 1: Enabled	1

Note1: Setting *F608* to 0 (input phase failure detection: disabled) may result in a breakage of the capacitor in the inverter main circuit if operation is continued under a heavy load in spite of the occurrence of an input phase failure.

Note2: Parameter *F608* is invalid for single-phase input model.

Note3: When operating the inverter with DC input, set *F608=0*: (none).

6.16.7 Control mode for small current

F609: Small current detection hysteresis

F610: Small current trip/alarm selection

F611: Small current detection current

F612: Small current detection time

- Function

If the output current falls below the value set at *F611* and doesn't return above *F611+F609* for a time that exceeds the value set at *F612*, tripping or output alarm will be activated.

UL is displayed in the event of a trip.

F610=0: No tripping (Failure signal FL not activated).

A small current alarm can be put out by setting the output terminal function selection parameter.

F610=1: The inverter will trip (Failure signal FL activated) if a current below the current set with *F611* flows for the period of time specified with *F612*.

[Parameter setting]

Title	Function	Adjustment range	Default setting
$F609$	Small current detection hysteresis	1-20 (%)	10
$F610$	Small current trip/alarm selection	0: Alarm only 1: Tripping	0
$F611$	Small current detection current	0-150 (%) / (A)	0
$F612$	Small current detection time	0-255 (s)	0

<Example of operation>

Output terminal function: 26 (UC) Low current detection

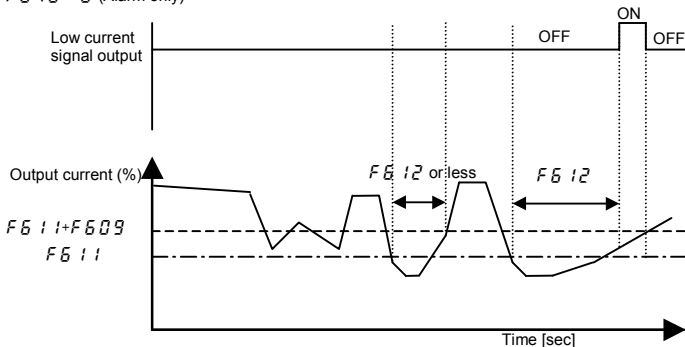
 $F610 = 0$ (Alarm only)

* When setting $F610$ to 1 (Trip), trip after low current detection time setting of $F612$. After tripping, the low current signal remains ON.

6.16.8 Detection of output short-circuit

$F613$: Detection of output short-circuit at start-up

- Function

This parameter detects inverter output short-circuit. It can be usually detected in the length of the standard pulse. When operating low-impedance motor such as high-speed motor, however, select the short-time pulse.

$F613=0$: Detection is executed in the length of the standard pulse every time you start up the inverter.

$F613=1$: Detection is executed in the length of standard pulse only during the first start-up after putting on the power or after resetting.

$F613=2$: Detection is executed with the short-time pulse every time you start up the inverter.

$F613=3$: Detection is executed with the short-time pulse only for the first time after putting power on or after resetting.

[Parameter setting]

Title	Function	Adjustment range	Default setting
<i>F6 13</i>	Detection of output short-circuit at start-up	0: Each time (standard pulse) 1: Only one time after power on (standard pulse) 2: Each time (short pulse) 3: Only one time after power on (short pulse)	0

6.16.9 Over-torque trip

F6 15: Over-torque trip/alarm selection

F6 16: Over-torque detection level

F6 18: Over-torque detection time

F6 19: Over-torque detection hysteresis

- Function

If the torque value exceeds the value set at *F6 16* and doesn't return below *F6 16-F6 19* for a time that exceeds the value set at *F6 18*, tripping or output alarm will be activated. *OL* is displayed in the event of a trip.

F6 15=0: No tripping (FL relay deactivated).

An over-torque alarm can be put out by setting the output terminal function selection parameter.

F6 15=1: The inverter is tripped (FL relay activated) only after a torque exceeding the *F6 16*-specified level has been detected for more than the *F6 18*-specified time.

[Parameter setting]

Title	Function	Adjustment range	Default setting
<i>F6 15</i>	Over-torque trip/alarm selection	0: Alarm only 1: Tripping	0
<i>F6 16</i>	Over-torque detection level	0 (disabled), 1-200(%)	150
<i>F6 18</i>	Over-torque detection time	0.0-10.0 (s) Note	0.5
<i>F6 19</i>	Over-torque detection hysteresis	0-100 (%)	10

Note: *F6 18* = 0.0 seconds is the shortest time detected on control.

<Example of operation>

1) Output terminal function: 28 (OT) Over-torque detection

$F615=0$ (Alarm only)

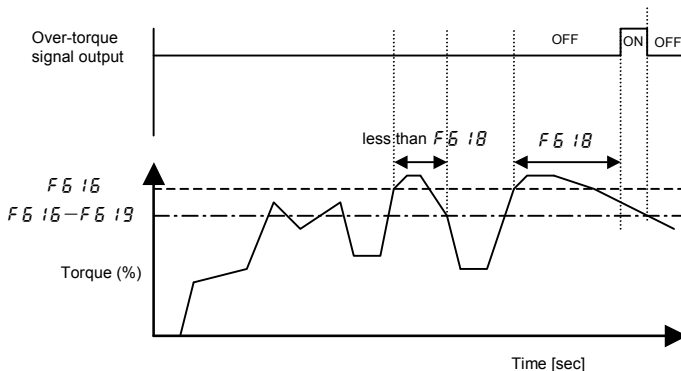

When $F615 = 1$ (tripping), the inverter will trip if over-torque lasts for the period of time set with $F618$. In such a case, the over-torque signal remains ON.

6.16.10 Cooling fan control selection

$F620$: Cooling fan ON/OFF control

- Function

Set to operate the fan only when the ambient temperature is high during operation. When the inverter is on, the service life of the cooling fan is longer than if it is always running.

$F620=0$: Cooling fan automatically controlled. Cooling fan operates only when the ambient temperature is high and during run.

$F620=1$: Cooling fan not automatically controlled. Fan is always running when the inverter is on.

- If the ambient temperature is high, even when the inverter is stopped, the cooling fan automatically operates.

[Parameter setting]

Title	Function	Adjustment range	Default setting
$F620$	Cooling fan ON/OFF control	0: ON/OFF control 1: Always ON	0

6.16.11 Cumulative operation time alarm setting

F621: Cumulative operation time alarm setting

- Function
This parameter allows you to set the inverter so that it will put out an alarm signal after a lapse of the cumulative operation time set with **F621**.

* "0.1" displayed on the monitor refers to 10 hours, and therefore "1" denotes 100 hours.
Ex.: 38.5 displayed on the monitor = 3850 (hours)

[Parameter setting]

Title	Function	Adjustment range	Default setting
F621	Cumulative operation time alarm setting	0.0-999.0	610.0

■ Setting of output signal

Ex.: When assigning the cumulative operation alarm signal output function to the OUT terminal

Title	Function	Adjustment range	Setting
F130	Output terminal selection 1A (OUT)	0-255	56: COT (Cumulative operation time alarm)

Setting value 57 is reverse signal.

6.16.12 Undervoltage trip

F627: Undervoltage trip/alarm selection

- Function
This parameter is used for selecting the control mode when an undervoltage is detected. Trip information is displayed as "**UP**".

F627=0: The inverter is stopped. However, it is not tripped (Failure signal FL not activated).

The inverter is stopped when the voltage does not exceed 64 % or less of its rating.

F627=1: Inverter is stopped. It is also tripped (Failure signal FL activated), only after detection of a voltage not exceeding 64% or less of its rating.

F627=2: Inverter is stopped. However, it is not tripped (Failure signal FL not activated). The inverter stop (Failure signal FL not activated.), only after detection of a voltage not exceeding 50% of its rating. Be sure to connect the input AC or DC reactor specified in section 10.4.

[Parameter setting]

Title	Function	Adjustment range	Default setting
F627	Undervoltage trip/alarm selection	0: Alarm only (detection level 64% or less) 1: Tripping (detection level 64% or less) 2: Alarm only (detection level 50% or less, input AC or DC reactor required)	0

6.16.13 VI analog input break detection

F633: VI analog input break detection level

- Function
The inverter will trip if the VI value remains below the specified value for about 0.3 seconds. In such a case, "E-18" is displayed.

F633=0: Disabled...Not detected.

F633=1-100...The inverter will trip if the VI input remains below the specified value for about 0.3 seconds.

[Parameter setting]

Title	Function	Adjustment range	Default setting
F633	VI analog input break detection level	0: Disabled 1-100%	0

Note : The VI input value may be judged earlier to be abnormal, depending on the degree of deviation of the analog data detected.

6.16.14 Parts replacement alarms

F634: Annual average ambient temperature (Parts replacement alarms)

- Function
You can set the inverter so that it will calculate the remaining useful lives of the cooling fan, main circuit capacitor and on-board capacitor from the ON time of the inverter, the operating time of the motor, the output current (load factor) and the setting of F634, and that it will display and send out an alarm through output terminals when each component is approaching the time of replacement.

[Parameter setting]

Title	Function	Adjustment range	Default setting
F634	Annual average ambient temperature (parts replacement alarms)	1: -10 to +10°C 2: 11-20°C 3: 21-30°C 4: 31-40°C 5: 41-50°C 6: 51-60°C	3

- ★ Display of part replacement alarm information
Part replacement alarm information (Refer to page H-4) in the Status monitor mode allows you to check on the time of replacement.

An example of display: 

- ★ Output of part replacement alarm signal
The parts replacement alarm is assigned to the output terminal.

Setup example) When the parts replacement alarm is assigned to the OUT terminal

Title	Function	Adjustment range	Setting
F130	Output terminal selection 1A (OUT)	0 - 255	128: LTA (Parts replacement alarm)

Setting value 129 is reverse signal.

Note 1: Using F634 enter the annual average temperature around the inverter. Be careful not to enter the annual highest temperature.

Note 2: Set F634 at the time of installation of the inverter, and do not change its setting after the start of use. Changing the setting may cause parts replacement alarm calculation error.

6.17 Adjustment parameters

6.17.1 Pulse train output for meters

F559: Logic output/pulse train output selection (OUT)

F575: Pulse train output function selection (OUT)

F577: Maximum numbers of pulse train

- Function

Pulse trains can be sent out through the OUT output terminals.

To do so, it is necessary to select a pulse output mode and specify the number of pulses.

Ex.: When operations frequencies (0 to 60Hz) are put out by means of 0 to 600 pulses

$FH=60.0$, $F559=1$, $F575=0$, $F577=0.60$

[Parameter setting]

Title	Function	Adjustment range	Reference of maximum value of F577	Default setting
F559	Logic output/pulse train output selection (OUT)	0: Logic output 1: Pulse train output	-	0
F575	Pulse train output function selection (OUT)	0: Output frequency 1: Output current 2: Frequency command value 3: Input voltage (DC detection) 4: Output voltage (command value) 5 to 11: - 12: Stator frequency 13: VI input value 14: - 15: Fixed output 1 (Output current: 100% equivalent) 16: Fixed output 2 (Output current: 50% equivalent) 17: Fixed output 3 (Other than the output current) 18: RS485 communication data 19-22: -	FH 185% FH 150% 150% - FH 10 V/20 mA 185% 185% 100% 100.0% -	0
F577	Maximum numbers of pulse train	0.50-1.60 (kpps)	-	0.80

★ Digital panel meter for reference
Type: K3MA-F (OMRON)
Connection terminal: OUT-E4, NO-E5

Note 1: When item of **F575** reaches "Reference of max. value", the number of pulse train set by **F577** are sent to output terminals (OUT)

Note 2: The pulse ON/OFF duty ratio is fixed at 50%.

Note 3: The minimum pulse output rate is 25pps. Keep in mind that no pulses can be put out at any rate smaller than 25pps.

Note 4: $F575 = i2$ is the motor drive frequency.

6.17.2 Calibration of analog output

F681: Analog output signal selection

F691: Inclination characteristic of analog output

F692: Analog output bias

- Function

Output signal from the FM terminal can be switched between 0 to 1mA dc output, 0 to 20mA dc output, and 0 to 10V dc output with the **F681** setting. The standard setting is 0 to 1mA dc output.

* Optional frequency meter: When using QS6T, set **F681** to 0 (meter option (0 to 1mA) output).

[Parameter setting]

Title	Function	Adjustment range	Default setting
F681	Analog output signal selection	0: Meter option (0 to 1mA) 1: Current (0 to 20mA) output 2: Voltage (0 to 10V) output	0
F691	Inclination characteristic of analog output	0: Negative inclination (downward slope) 1: Positive inclination (upward slope)	1
F692	Analog output bias	-1.0 - +100.0%	0

Note: With 0 to 20mA dc (4 to 20mA dc) output, or 0 to 10V dc output, set **F681** to 1 or 2.

■ Example of setting

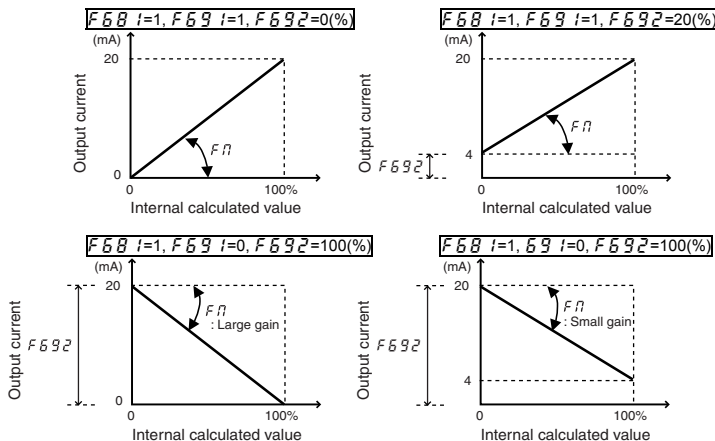

+ The analog output inclination can be adjusted using the parameter $F\Omega$.

6.18 Operation panel parameter

6.18.1 Prohibition of key operations and parameter settings

F700: Parameter write protection selection

F730: Panel frequency setting prohibition (FL)

F732: Local/remote key prohibition of extension panel

F733: Panel operation prohibition (RUN/STOP keys)

F734: Panel emergency stop operation prohibition

F735: Panel reset operation prohibition

F736: *LRNDRFRNDR* change prohibition during operation

F738: Password setting (F700)

F739: Password verification

- Function

These parameters allow you to prohibit or allow operation of the RUN and STOP keys on the operation panel and the change of parameters. Using these parameters, you can also prohibit various key operations. Lock parameters with a password to prevent configuration.

[Parameter setting]

Title	Function	Adjustment range	Default setting
F700	Parameter write protection selection	0: Permitted 1: Prohibited (Panel and extension panel) 2: Prohibited (1 + RS485 communication)	0
F730	Panel frequency setting prohibition (FL)	0: Permitted, 1: Prohibited	0
F732	Local/remote key prohibition of extension panel	0: Permitted, 1: Prohibited	1
F733	Panel operation prohibition (RUN/STOP keys)	0: Permitted, 1: Prohibited	0
F734	Panel emergency stop operation prohibition	0: Permitted, 1: Prohibited	0
F735	Panel reset operation prohibition	0: Permitted, 1: Prohibited	0
F736	<i>LRNDRFRNDR</i> change prohibition during operation	0: Permitted, 1: Prohibited	1
F738	Password setting (F700)	0: Password unset 1-9998 9999: Password set	0
F739	Password verification	0: Password unset 1-9998 9999: Password set	0

★ Assigning the parameter editing permission (function number 110, 111) to any logic input terminal, parameters can be written regardless of the setting of $F 700$.

Note1: $F 700=2$ will be available after reset operation.

When protection using a password is necessary, set and remove with the following method.

■ Password setup method

Preparation: Parameters other than $F 700$, $F 738$, and $F 739$ cannot be changed when $F 700$ is set to 1 or 2.

- (1) When $F 738$ or $F 739$ are read out and the value is 0, a password is not set. A password can be set.
- (2) When $F 738$ or $F 739$ are read out and the value is 9999, a password is already set.
- (3) If a password is not set, one can be set. Select and register a value between 1 and 9999 for $F 738$. The number becomes the password. It must be entered to remove the password, so do not forget it.
- (4) The settings for parameter $F 700$ cannot be changed.

Note2: If you forget the password, it cannot be removed. Do not forget this password as we cannot retrieve it.

Note3: Password cannot be set when parameter $F 700=0$ setting.

Set the password after parameter $F 700=1$ to 4 setting.

Note4: Reading out password to parameter writer (option) is possible in 5 minutes after setting $F 738$.

Please note that reading out is impossible after elapse of 5 minutes or power off because of protection of password.

■ Password examination method

- (1) When $F 738$ or $F 739$ are read out and the value is 9999, a password is set. Changing the parameter requires removing the password.
- (2) Enter a the number (1 to 9999) registered to $F 738$ when the password was set for $F 739$.
- (3) If the password matches, $PR55$ blinks on the display and the password is removed.
- (4) If the password is incorrect, $PR1L$ blinks on the display and $F 739$ is displayed again.
- (5) When the password is removed, the setting for parameter $F 700$ can be changed.
- (6) By setting parameter $F 700=0$, the settings of all parameters can be changed.

Note5: Entry of $F 739$ setting is possible up to 3 times. Please note it is impossible to set, if you set the wrong number over 3 times. Number of times is reset after power off.

When protecting a parameter is necessary with the external logic input terminal, set with the following method.

■ Prohibit changing parameter settings with logic input

Set "Parameter editing prohibited" for any input terminal.

Activating the "Parameter editing prohibited" function prevents changes to all parameters.

The following table shows an example of setting input terminal S2.

Title	Function	Adjustment range	Setting
$F 114$	Input terminal selection 4A (S2)	0-201	200: PWP(Parameter editing prohibited)

Setting value 201 is reverse signal.

6.18.2 Changing the unit (A/V) from a percentage of current and voltage

F701: Current/voltage unit selection

- Function
These parameters are used to change the unit of monitor display.
% ↔ A (ampere)/V (volt)

Current 100% = Rated current of inverter
 100 V class: Input voltage 100% = 100Vac
 Output voltage 100% = 200Vac
 200 V class: Input/output voltage 100% = 200Vac

■ Example of setting

During the operation of the VFNC3-2037P (rated current: 16.7A) at the rated load (100% load), units are displayed as follows:

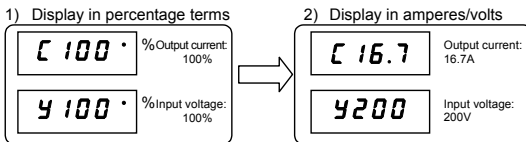

[Parameter setting]

Title	Function	Adjustment range	Default setting
F 701	Current/voltage unit selection	0: % 1: A (ampere) / V (volt)	0

- * The **F 701** converts the following parameter settings:
 - A display
 - Current monitor display: Load current, torque current
Motor electronic-thermal protection level 1 & 2
t H r, F 173
 - DC braking current *F 251*
 - Stall prevention level 1 & 2 *F 601, F 185*
 - Small current detection current *F 611*
 - V display: Input voltage, output voltage
Note) Base frequency voltage 1 & 2 (*u L u, F 171*) always displayed in the unit of V.

6.18.3 Displaying the motor or the line speed

F702: Free unit display scale

- Function
The frequency or any other item displayed on the monitor can be converted freely into the rotational speed of the motor, the operating speed of the load, and so on.

The value obtained by multiplying the displayed frequency by the **F702**-set value will be displayed as follows:

$$\text{Value displayed} = \text{Monitor-displayed or parameter-set frequency} \times \text{F702}$$

1) Displaying the motor speed

To switch the display mode from 60Hz (default setting) to 1800min⁻¹ (the rotating speed of the 4P motor)

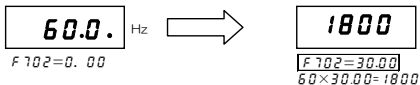

2) Displaying the speed of the loading unit

To switch the display mode from 60Hz (default setting) to 6m/min⁻¹ (the speed of the conveyer)

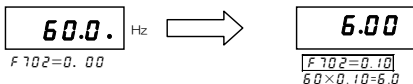

Note: This parameter displays the inverter output frequency as the value obtained by multiplying it by a positive number. This does not mean that the actual motor speed or line speed are indicated with accuracy.

[Parameter setting]

Title	Function	Adjustment range	Default setting
<i>F 702</i>	Free unit display scale	0.00: Disabled (display of frequency) 0.01-200.0	0.00

* The *F 702* converts the following parameter settings:

- Free unit Frequency monitor display Output frequency, Frequency command value, PID feedback value, Stator frequency
- Frequency-related parameters *F C, F H, U L, L L, S r 1 ~ S r 7,*
F 100, F 101, F 102, F 202, F 204,
F 240, F 241, F 242, F 250, F 265,
F 267, F 268, F 270, F 271,
F 287 ~ F 294, F 391, F 505, F 707

(Note) The unit of the Base frequency 1 and 2 (*U L, F 170*) are always Hz.

6.18.4 Changing the steps in which the value increment

F 707: Free step (1-step rotation of setting dial)

- Function

It is possible to change the step width changed at panel frequency setting.

This function is useful when only running with frequencies of intervals of 1 Hz, 5 Hz, and 10 Hz units.

Note 1: The settings of these parameters have no effect when the free unit selection (*F 702*) is enabled.

Note 2: Set *F 707* to other than 0. When increasing the frequency by rotating the setting dial and if *U L* (Upper limit frequency) is exceeded by rotating 1 step more, be careful as the *H I* alarm displays before this happens and the frequency cannot be increased beyond this point.

Similarly, when rating the settings dial to lower the frequency, if the rotating 1 step more lowers it below *L L* (lower limit frequency), the *L O* alarm displays before this happens and the frequency cannot be lowered beyond this point.

[Parameter setting]

Title	Function	Adjustment range	Default setting
<i>F 707</i>	Free step (1-step rotation of setting dial)	0.00: Automatic 0.01- <i>F H</i> (Hz)	0.00

■ Operation example

F 707 = 0.00 (Automatic)

By rotating the setting dial 1 step, the panel frequency command value changes only 0.1 Hz.

When *F 707* = 10.00 (Hz) is set

Rotating the setting dial 1 step changes the panel frequency command value in 10.00 Hz increments, from 0.00 up to 60.00 (Hz).

6.18.5 Changing the initial display of the panel

F710: Initial panel display selection

F720: Initial extension panel display selection

- Function
This parameter specifies display format while power is ON.

■ Changing the display format while power is ON

When the power is ON, the standard monitor mode displays the output frequency (default setting) in the format of "0.0" or "0.FF". This format can be changed to any other monitor display format by setting **F710**. This new format, however, will not display an assigned prefix such as ξ or ζ . When the power is ON, the display of the extension panel is set at **F720**.

★ When the power is ON, the main panel and the extension panel can be set to display differently.

[Parameter setting]

Title	Function	Adjustment range	Default setting
F710	Initial panel display selection	0: Output frequency (Hz/free unit) 1: Output current (%/A) 2: Frequency command value (Hz/free unit) 3 to 17: - 18: Arbitrary code from communication	0
F720	Initial extension panel display selection	19 to 51: - 52: Frequency command value / output frequency (Hz/free unit)	0

★ **F710** For details on / **F720**=18, see the Communications Function Instruction Manual.

6.18.6 Changing display of the status monitor

F711 - **F716**: Status monitor 1 to 6

Change monitor display items in the status monitor mode.

⇒ Refer to chapter 8 for details.

6.18.7 Cancel the operation command

F719: Selection of operation command clear

- Function

This parameter allows you to select operation command retained or operation command canceled, when coast stop occurs due to standby terminal function (ST) or coast stop command terminal function (FRR), and when under voltage in main circuit alarm (RUFF) occurs, during panel operation or RS485 communication operation.

Parameter setting	At coast stop	At under voltage in main circuit alarm (RUFF)
F719=0	Operation command canceled	Operation command retained
F719=1	Operation command retained	
F719=2	Operation command canceled	

Operation command retained :

Inverter restarts due to canceling coast stop at coast stop.

Inverter restarts due to supply power source again when the under voltage in main circuit alarm (RUFF) occurs.

Operation command canceled :

Inverter doesn't restart after coast stop or occurring the under voltage in main circuit alarm (RUFF).

Press RUN key to operate again in panel operation.

Switch to ON the operation command in RS485 communication operation.

Title	Function	Adjustment range	Default setting
F719	Selection of operation command clear	0: Clear at coast stop and retained at RUFF. 1: Retained at coast stop and RUFF. 2: Clear at coast stop and RUFF.	1

[Setup example of input terminal]

When it is assigned to the S1 terminal.

Title	Function	Adjustment range	Setting
F113	Input terminal selection 3A (S1)	0-201	6: ST (Standby)
F113	Input terminal selection 3A (S1)	0-201	96: FRR (Coast stop command)

Setting value 7, 97 are reverse signa

6.18.8 Parameter registration to easy setting mode

F751 - **F774**: Easy setting mode parameter 1 to 24

Up to 24 arbitrary parameters can be registered to easy setting mode. → Refer to section 4.5 for details.

6.19 Communication function (RS485)

F800: Baud rate

F801: Parity

F802: Inverter number

F803: Communication time-out time

F804: Communication time-out action

F805: Communication waiting time

F808: Communication time-out
detection condition

F829: Selection of communication
protocol

F870: Block write data 1

F871: Block write data 2

F875: Block read data 1

F876: Block read data 2

F877: Block read data 3

F878: Block read data 4

F879: Block read data 5



Warning



Mandatory
action

- Set the parameter Communication time-out time (**F803**) and Communication time-out action (**F804**). If these are not properly set, the inverter cannot be stopped immediately in breaking communication and this could result in injury and accidents.
- An emergency stop device and the interlock that fit with system specifications must be installed. If these are not properly installed, the inverter cannot be stopped immediately and this could result in injury and accidents.

Refer to the Communications Function Instruction Manual (E6581657) for details.

- **Function**
2-wire RS485 communication is built-in as standard.
Connect with the host to create a network for transmitting data between multiple inverters. A computer link function is available.
<Computer-linking functions>
The following functions are enabled by data communication between the computer and inverter
 - (1) Monitoring inverter status (such as the output frequency, current, and voltage)
 - (2) Sending RUN, STOP and other control commands to the inverter
 - (3) Reading, editing and writing inverter parameter settings
- ★ **Timer function** …Function used to detect cable interruptions during communication.
When data is not sent even once to the inverter during a user-defined period of time, an inverter trip (**E r r 5** is displayed on the panel) or an output terminal alarm can be output.
- ★ **Broadcast communication function** …Function used to send a command (data write) to multiple inverters with a single communication.

★ 2-wire RS485 communication option is as follows.

- (1) USB communication exchange unit (Type: USB001Z)
Cable for communication between the inverter and the unit (Type: CAB0011 (1m), CAB0013 (3m), CAB0015 (5m))
Cable for communication between the unit and computer: Use a commercially available USB 1.1 or 2.0 cables. (Type: A-B, Cable length: 0.25 to 1.5m)

- (2) Parameter writer (Type: RKP002Z)
Communication cable (Type: CAB0011 (1m), CAB0013 (3m), CAB0015 (5m))
- (3) Extension panel (Type: RKP007Z)
Communication cable (Type: CAB0071 (1m), CAB0073 (3m), CAB0075 (5m))

■ Settings for run/stop via communication

Title	Function	Adjustment range	Standard defaults	Setting example
<i>CNDd</i>	Command mode selection	0~2	1 (panel)	2 (RS485 communications)

■ Settings for speed command via communication

Title	Function	Adjustment range	Standard defaults	Setting example
<i>FNDd</i>	Frequency setting mode selection	0 ~ 5	2 (Setting dial)	3 (RS485 communications)

■ Communication function parameters (2-wire RS485 communication)

Communication speed, parity, inverter number, and communication error trip time settings can be changed via panel operations or communication.

[Parameter setting]

Title	Function	Adjustment range	Default setting
<i>FBD0</i>	Baud rate	3: 9600bps 4: 19200bps 5: 38400bps	4
<i>FBD1</i>	Parity	0: NON (No parity) 1: EVEN (Even parity) 2: ODD (Odd parity)	1
<i>FBD2</i>	Inverter number	0-247	0
<i>FBD3</i>	Communication time-out time *1	0: Disabled (*) 0.1-100.0 (s)	0.0
<i>FBD4</i>	Communication time-out action *2	0: Alarm only 1: Trip (Coast stop) 2: Trip (Deceleration stop)	0
<i>FBD5</i>	Communication waiting time	0.00-2.00 (s)	0.00
<i>FBD8</i>	Communication time-out detection condition	0: Valid at any time 1: Communication selection of <i>FNDd</i> or <i>CNDd</i> 2: 1 + during operation	1
<i>FBD9</i>	Selection of communication protocol	0: Toshiba inverter protocol 1: ModbusRTU protocol	0

*1: Disabled Indicates that the inverter will not be tripped even if a communication error occurs.

*2: Trip The inverter trips when a communication time-over occurs.

In this case a trip information *E r S* flashes on and off on the operation panel.

Alarm When a communication time-over occurs, an alarm can be output from the output terminal.

Output terminal function: 78 (RS485 communication error) or 79 (RS485 communication error reverse)

Title	Function	Adjustment range	Default setting
<i>FB70</i>	Block write data 1	0: No selection 1: Command information 2: - 3: Frequency command value	0
<i>FB71</i>	Block write data 2	4: Output data on the terminal board 5: Analog output for communication	0
<i>FB75</i>	Block read data 1	0: No selection 1: Status information	0
<i>FB76</i>	Block read data 2	2: Output frequency 3: Output current	0
<i>FB77</i>	Block read data 3	4: Output voltage 5: Alarm information	0
<i>FB78</i>	Block read data 4	6: PID feedback value 7: Input terminal board monitor	0
<i>FB79</i>	Block read data 5	8: Output terminal board monitor 9: VI terminal board monitor	0

■ Communication function settings

Commands and frequency settings are given priority by communication. (Prioritized by commands from the panel or terminal block.) Thus, command and frequency settings from communication are activated, regardless of the command mode selection ($\overline{C} \overline{N} \overline{D}$) or frequency settings mode selection settings ($\overline{F} \overline{N} \overline{D}$).

However, setting 48: SCLC (switching from communication to local) with input terminal function selection and when inputting from an external device, it is possible to operate at command mode selection ($\overline{C} \overline{N} \overline{D}$) and frequency setting mode selection ($\overline{F} \overline{N} \overline{D}$) settings.

Moreover, connecting the optional extension panel and selecting local mode with the LOC/REM key changes to panel frequency/panel operation mode.

■ Transmission specifications

Item	Specifications
Interface	RS485 compliant
Transmission path configuration	Half duplex [Serial bus type (Line terminations resistor necessary at both ends of system)]
Wiring	2-wire
Transmission distance	500 m max. (total length)
Connection terminals	32max. (including upper host computer) Inverters connected in the system: 32max.
Synchronization	Asynchronous
Transmission speed	Default: 19200 bps (parameter setting) 9600/19200/38400 bps selectable
Transmission character	ASCII mode ... JIS X 0201 8 bits (ASCII) Binary code ... Binary code, 8 bits fixed
Stop bit length	Received by inverter : 1 bit / Sent by inverter : 2 bits
Error detection	Battery Even number/odd number/non Selection (parameter setting), checksum
Error correction	None
Response monitoring	None
Transmission character type	11 bit characters (Stop bit = 1, with parity)
Other	Inverter operation at communication time-over: Select from trip/alarm/none → When alarm is selected, an alarm is output from the output terminal. When trip is selected, $\overline{E} \overline{r} \overline{r} \overline{S}$ blinks on the panel.

■ Configuration of RS485 connector and wiring

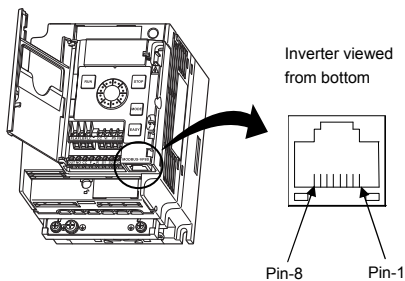

Pin number	Name	Description	RS485 communication
1	-	For factory	Do not connect
2	-		
3	(SG)		
4	RXD+/TXD+	Same phase reception data	Using
5	RXD-/TXD-	Anti-phase reception data	
6	-	Open	Do not connect
7	P8	Power supply for option	
8	SG	Ground	Using

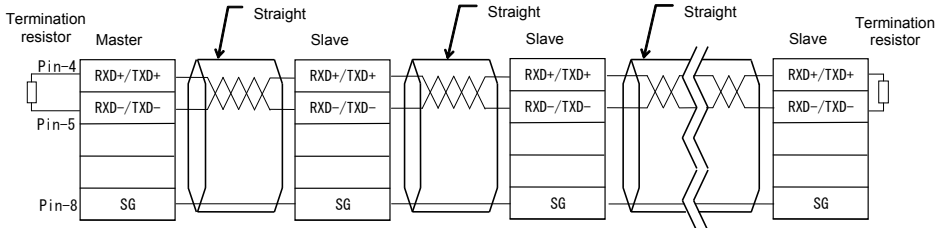

Termination resistor : 100 to 120Ω -1/4W or more

★ Connect only Pin-4, 5, 8 when manufacturing on the communication cable on the user side.
Never use pin-7. Note 1)

In case branch cables, use the terminal board or refer to following table.

Full length must be within 500m and stab length of branches must be within 1m each.

Examples of products available on the market (as of October 2010) Note 2)

Product	Type	Maker
Jack / jack type branch adaptor	BJ8888W	SANWA DENKI KOGYO CO.,LTD.
Branch connector	BMJ-8	
Branch connector with termination resistor	BMJ-8P	HACHIKO ELECTRIC CO.,LTD.
Rosette (additional 8 units)	OMJ-88R	

Note 1) Pin-7 provides power to the extension panel for option. Do not use this pin for RS485 communication.

Incorrect connect may result in the inverter malfunction or failure.

Note 2) All pins of these connectors are connected. Pull out pins except pin-4, 5, 8 by cable side.

■ Connection example when using the computer link function

<Independent communication>

Perform computer-inverter connection as follows to send operation frequency commands from the host computer to inverter No. 3:

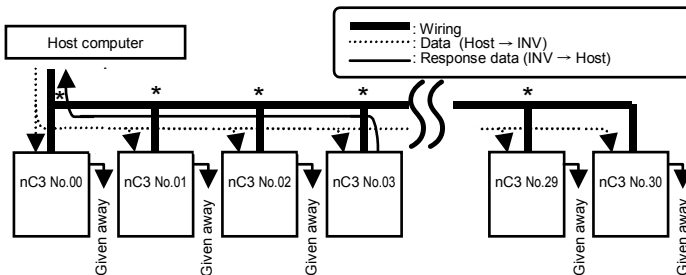

"Given away": Only the inverter with the selected inverter number conducts data processing. All other inverters, even if they have received the data, give it away and stand by to receive the next data.

* : Use the terminal board to branch the cable.

- (1) Data is sent from the host computer.
- (2) Data from the computer is received at each inverter and the inverter numbers are checked.
- (3) The command is decoded and processed only by the inverter with the selected inverter number.
- (4) The selected inverter responds by sending the processing results, together with its own inverter number, to the host computer.
- (5) As a result, only the selected inverter starts operating in accordance with the operation frequency command by communicating independently.

<Broadcast communication>

When sending an operation frequency command via a broadcast from the host computer

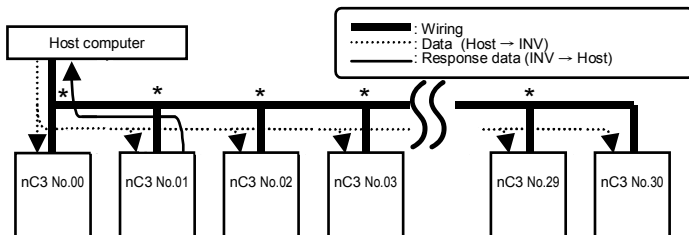

★ : Split the cable among terminal blocks.

- (1) Send data from the host computer.
- (2) The inverters receive data from the host computer and the inverter number is checked.
- (3) When * is next to the position of an inverter number, it is judged a broadcast. The command is decoded and processed.
- (4) To prevent data conflicts, only inverters where * is overwritten to 0 can reply with data to the host computer.
- (5) As a result, all inverters are operating with the broadcast operation frequency command.

Note: Specify inverter numbers by group for group broadcasts.

(Function only for ASCII mode. For parity mode, see the Communications Function Instruction Manual.)

(Ex) When *1 is set, inverters 01, 11, 21, 31 to 91 can be broadcast to.

In this case, the inverter specified in 01 can reply.

6.20 Free notes

F880: Free notes

- Function
To enable easier management and maintenance of the inverter, it is possible to enter the identification number.

[Parameter setting]

Title	Function	Adjustment range	Default setting
F880	Free notes	0 - 65535	0

7. Operations with external signal

7.1 Operating external signals

You can control the inverter externally.

The parameter settings differ depending upon your method of operation. Determine your method of operation (the operational signal input method, speed command input method) before using the procedure below to set the parameters.

[Procedure for setting parameters]

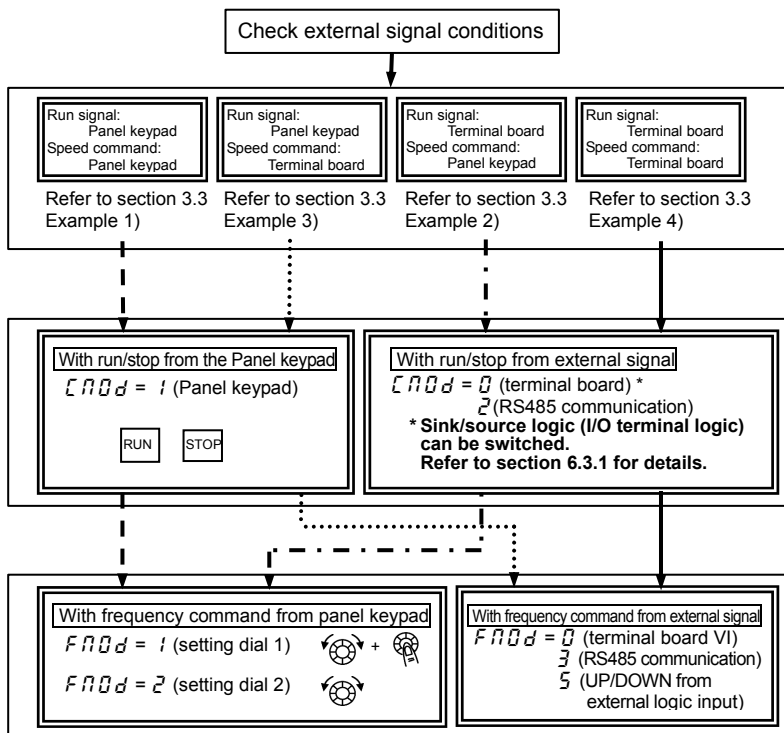

* For settings based on communication, refer to the Communication Manual (E6581657) or section 6.19.

7.2 Applied operations by an I/O signal (operation from the terminal block)

Input terminal sink and source logic are set according to the selection on the setup menu. (Refer to section 3.1)

7.2.1 Input terminal function

This function is used to send a signal to the input terminal from an external programmable controller to operate or configure the inverter.

The ability to select from a variety of functions allows for flexible system design.

[Control terminal board]

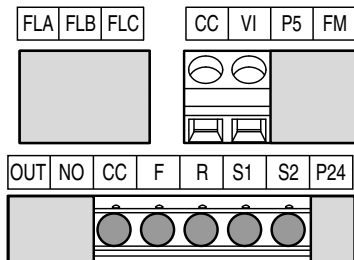

■ Settings for the logic input terminal function

Terminal symbol	Title	Function	Adjustment range	Default setting
F	F 1 1 1	Input terminal selection 1A (F)	0-201 Note 1)	2 (F)
	F 1 5 1	Input terminal selection 1B (F)		0 (No function)
	F 1 5 5	Input terminal selection 1C (F)		0 (No function)
R	F 1 1 2	Input terminal selection 2A (R)	0-201 Note 1)	4 (R)
	F 1 5 2	Input terminal selection 2B (R)		0 (No function)
	F 1 5 6	Input terminal selection 2C (R)		0 (No function)
S1	F 1 1 3	Input terminal selection 3A (S1)	0-201 Note 1)	10 (SS1)
	F 1 5 3	Input terminal selection 3B (S1)		0 (No function)
S2	F 1 1 4	Input terminal selection 4A (S2)	0-201 Note 1)	12 (SS2)
	F 1 5 4	Input terminal selection 4B (S2)		0 (No function)
VI	F 1 0 9	Analog/logic input Selection (VI terminal)	0: Voltage signal input (0 - 10 V) 1: Current signal input (4 - 20 mA) 2: Logic input 3: Voltage signal input (0 - 5 V)	0
	F 1 1 5	Input terminal selection 5 (VI)	8-55 Note 3)	14 (SS3)

Note 1) Multiple functions assigned to a single terminal operate simultaneously.

Note 2) In case of setting always active function, assign the menu number F 1 0 8 and F 1 1 0 (always active function selection).

Note 3) When VI is used for the logic input, always connect a resistor between VI and terminal P24 in sink logic, between VI and terminal CC in source logic. Refer to page B-12 for details.

■ Connecting

- 1) For logic input a

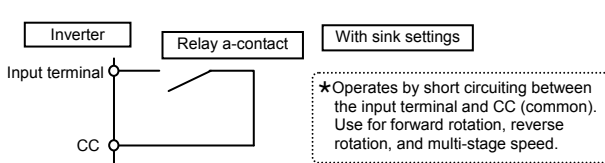

- 2) For connection (sink logic) via transistor output

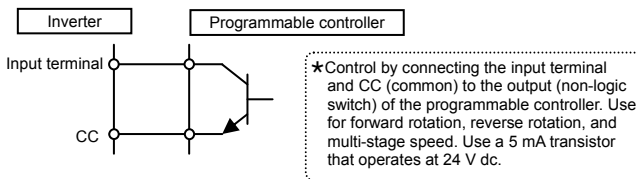

* About programmable controllers and interfaces

Supply the power for logic input terminal from external to P24 terminal (external 24Vdc input terminal) in case of controlling the inverter by using an open collector output of programmable controller.

■ Usage example 1 ... 3-wire operation (one-push operation)

Use the 3-wire operation function to operate the inverter, maintaining operation without using the sequence circuit by inputting an external signal (reset logic signal).

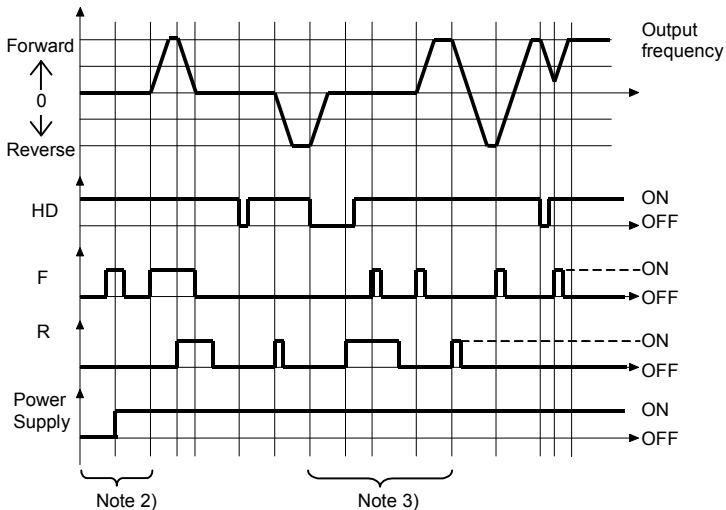
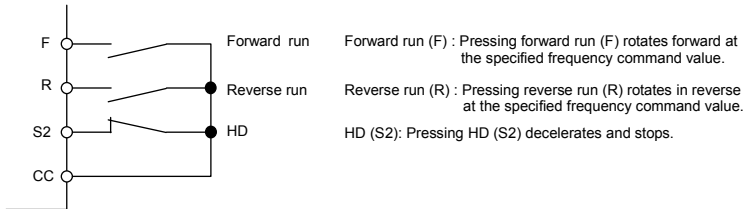

Note 1) Set $F \setminus \setminus \setminus = \setminus$ (ST: standby) and $\setminus \setminus \setminus \setminus = \setminus$ (terminal board) for 3 wire operation. Assign HD (operation hold) to any input terminal at input terminal selection. When assigning the S2 terminal as shown above, set $F \setminus \setminus \setminus = \setminus$ (HD: operation hold).

Note 2) If the terminals are ON before turning on the power, terminal input is ignored when the power is turned ON. (Prevents sudden movements.) After turning the power ON, turn terminal input ON again.

Note 3) When HD is OFF, F and R are ignored even when ON. R does not operate even if it's ON when HD is ON. Likewise in this state, F does not operate even if it's ON. Turn F and R OFF and then turn them ON.

Note 4) During 3 wire operation, sending the jog run mode command stops operation.

Note 5) Be aware that DC braking continues even if a startup signal is input during DC braking.

Note 6) Only F and R maintain HD (operation hold). When using F or R in combination with other functions, be aware that the other functions do not hold. For example, when F and SS1 are assigned, F holds, but SS1 does not.

[Parameter settings]

Terminal symbol	Title	Function	Adjustment range	Setting example
S2	$F \setminus \setminus 4$	Input terminal selection 4A (S2)	0-201	50 (HD operation hold)

■ Usage example 2 ... Jog run

Jog run is used for inching the motor. When a jog run signal is input, a jog run frequency is immediately output, regardless of the acceleration time set.

Assign the jog run function to any input terminal. For example, when assigned to the S2 terminal, set $F \setminus \setminus 4 = \setminus \setminus 8$. Jog run is done while the jog input terminal (S2 terminal) and either F or R are ON.

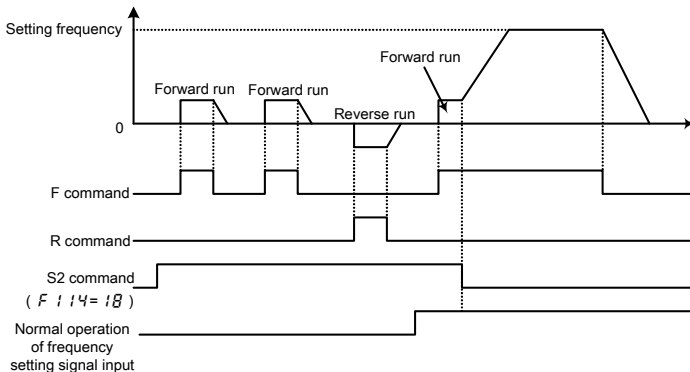

- The jog frequency is fixed at 5Hz.
- The stop pattern is slowdown stop.
- The jog run setting terminal is valid when the operation frequency is less than the jog frequency. Jog run does not function when the operation frequency is higher than the jog frequency.
- Even if an operation command is input midway, jog operation is prioritized.
- The jog frequency is not limited by the upper limit frequency (parameter $\setminus \setminus L$).

■ List of logic input terminal function settings

Parameter programmed value		Function	Parameter programmed value		Function
Positive logic	Negative logic		Positive logic	Negative logic	
0	1	No function	36	37	PID control prohibition
2	3	Forward run command	48	49	Forced local from communication
4	5	Reverse run command	50	51	Operation hold (hold of 3-wire operation)
6	7	Standby	52	53	PID integral/differential clear
8	9	Reset command	54	55	PID characteristics switching
10	11	Preset-speed command 1	88	89	Frequency UP *1
12	13	Preset-speed command 2	90	91	Frequency DOWN *1
14	15	Preset-speed command 3	92	93	Clear frequency UP/DOWN *1
16	17	Preset-speed command 4	96	97	Coast stop command
18	19	Jog run mode	106	107	Frequency setting mode terminal board VI
20	21	Emergency stop by external signal	108	109	Command mode terminal board
22	23	DC braking command	110	111	Parameter editing permission
24	25	2nd acceleration/deceleration	122	123	Forced deceleration command
28	29	2nd V/F control mode switching	200	201	Parameter editing prohibition
32	33	2nd stall prevention level			

*1: Active when $F R Q d$ (frequency setting mode selection) = 5 (UP/DOWN from external logic input) is set. The frequency setup range is from 0.0 to UL (upper limit frequency). The acceleration/deceleration time relative to the set frequency is $R L C / d E C$ while the acceleration/deceleration speed is not switched.

☆ Refer to section 11.6 for details about the input terminal function.

7.2.2 Output terminal function (sink logic)

This function is used to output a variety of signals to external devices from the inverter.

With the logic output terminal function, you can select from multiple output terminal functions. Set two types of functions for the OUT terminal and then you can output when either one or both of them is ON.

[Control terminal block]

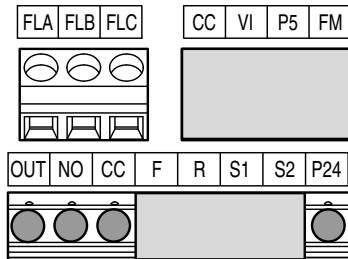

■ Usage

FLA, B, C function: Set at parameter $F 132$.

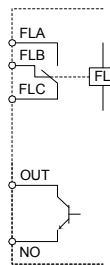

OUT function: Set at parameter $F 130$ and 137 .

Note 1) A chattering (momentary ON/OFF of contact) is generated by external factors of the vibration and the impact, etc. In particular, please set the filter of 10ms or more, or timer for measures when connecting it directly with input unit terminal of programmable controller. Please use the OUT terminal as much as possible when the programmable controller is connected.

■ Assign one type of function to an output terminal

Terminal symbol	Title	Function	Adjustment range	Default setting
OUT	$F 130$	Output terminal selection 1A	0 - 255	4 (Low-speed detection signal)
FL (A, B, C)	$F 132$	Output terminal selection 2		10 (Fault signal (trip output))

Note 2) When assigning 1 type of function to the OUT terminal, set only $F 130$.

Leave parameter $F 137$ as the standard setting ($F 137 = 255$).

■ Assign two types of functions to the output terminal (OUT)

Terminal symbol	Title	Function	Adjustment range	Default setting
OUT	<i>F 130</i>	Output terminal selection 1A	0 - 255	4 (Low-speed detection signal)
	<i>F 137</i>	Output terminal selection 1B		255 (Always ON)
	<i>F 139</i>	Output terminal logic selection	0: <i>F 130</i> and <i>F 137</i> 1: <i>F 130</i> or <i>F 137</i>	0

Note 3) *F 130* and *F 137* are active only when *F 669* = 0: Logic output (default).

Function is inactive when *F 669* = 1: Pulse train output is set.

(1) Output signals when two types of functions are simultaneously turned ON.

Signals are output when parameter *F 139* is the default (*F 139* = 0), and the functions set at parameters *F 130* and *F 137* are simultaneously turned ON.

☆ Timing chart

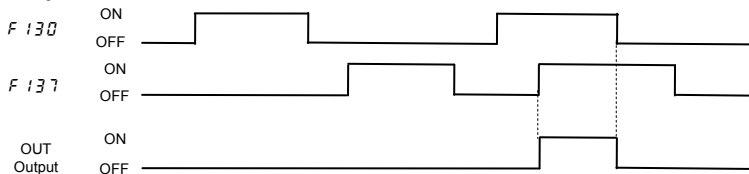

(2) Output signals when either one of two types of functions are simultaneously turned ON.

Signals are output when parameter *F 139* = 1, and either of the functions set at parameters *F 130* and *F 137* are turned on.

☆ Timing chart

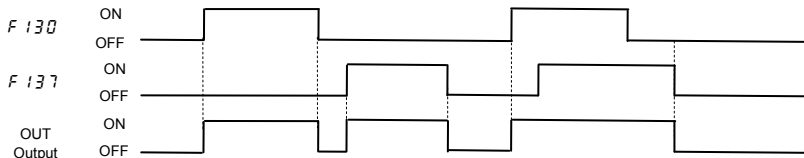

■ List of output terminal function settings

<Explanation of terminology>

- Alarm Alarm output when a setting has been exceeded.
- Pre-alarm Alarm output when the inverter may cause a trip during continued operation.

List of detection levels for output terminal selection

Parameter programmed value		Function	Parameter programmed value		Function
Positive logic	Negative logic		Positive logic	Negative logic	
0	1	Frequency lower limit	25	27	Small current detection
2	3	Frequency upper limit	28	29	Over-torque detection
4	5	Low-speed detection signal	40	41	Run/Stop
5	7	Output frequency attainment signal (acceleration/deceleration completed)	55	57	Cumulative operation time alarm
8	9	Set frequency attainment signal	60	61	Forward/reverse run
10	11	Fault signal (trip output)	78	79	RS485 communication error
14	15	Over-current pre-alarm	92	93	Designated data output
16	17	Overload pre-alarm	128	129	Parts replacement alarm
20	21	Overheat pre-alarm	145	147	Fault signal (output also at a ready)
22	23	Overvoltage pre-alarm	254		Always OFF
24	25	Power circuit undervoltage detection	255		Always ON

- Note 1) ON with positive logic : Open collector output transistor or relay turned ON.
 OFF with positive logic : Open collector output transistor or relay turned OFF.
 ON with negative logic : Open collector output transistor or relay turned OFF.
 OFF with negative logic: Open collector output transistor or relay turned ON.

☆ Refer to section 11.7 for details about the output terminal functions or levels.

7.3 Speed instruction (analog signal) settings from external devices

You can select from voltage input (0 to 10V, 0 to 5V), and current input (4 to 20mA) for an analog input terminal (VI). The maximum resolution is 1/1000.

[Control terminal block]

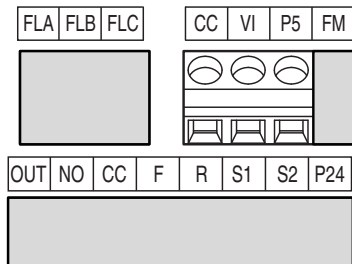

■ Analog input terminal (VI) function settings

Title	Function	Adjustment range	Default setting
<i>F109</i>	Analog/logic input selection (VI terminal)	0: Voltage signal input (0 - 10V) 1: Current signal input (4 - 20mA) 2: Logic input 3: Voltage signal input (0 - 5V)	0
<i>F201</i>	VI input point 1 setting	0 - 100%	0
<i>F202</i>	VI input point 1 frequency	0.0 - 400.0Hz	0.0
<i>F203</i>	VI input point 2 setting	0 - 100%	100
<i>F204</i>	VI input point 2 frequency	0.0 - 400.0Hz	*
<i>F209</i>	Analog input filter	4 - 1000 ms	64

* Depends upon the setup menu settings. Refer to section 11.5

Note1) When stable operation cannot be attained because of frequency setting circuit noise, increase *F209*.

Note2) Semiconductor switch is used to switch between current input and voltage input.

When power supply is off, it is high impedance between VI-CC terminals in spite of current input selecting.

The break detection might operate when current generator (4-20mA) with the break detection function is used.

Please correspond as following to prevent this problem.

1) Solution by sequence

Power supply is switched off inverter and current generator (PLC etc...) at same time with interlock sequence not to operate break detection function.

2) Solution by external resistor connection

Connect resistor 1/2W-500Ω or 470Ω between VI-CC terminals, and set the following parameter (voltage input setting).

F109=0 (Voltage input : Default setting)

7.3.1 Settings depending on voltage (0 to 10 V) input

You can set the frequency settings by inputting an analog voltage signal of 0 to 10Vdc between the VI and CC terminals.

The following shows examples when the run command is input from the terminal.

Title	Function	Adjustment range	Default setting	Setting example
<i>CmD</i>	Command mode selection	0 - 2	1 (panel keypad)	0 (terminal board)
<i>FmD</i>	Frequency setting mode selection	0 - 5	2 (setting dial)	0 (terminal board VI)
<i>F109</i>	Analog/logic input selection (VI terminal)	0: Voltage signal input (0 - 10V) 1: Current signal input (4 - 20mA) 2: Logic input 3: Voltage signal input (0 - 5V)	0	0 (Voltage signal (0 - 10V))
<i>F201</i>	VI input point 1 setting	0 - 100%	0	0
<i>F202</i>	VI input point 1 frequency	0.0 - 400.0Hz	0.0	0.0
<i>F203</i>	VI input point 2 setting	0 - 100%	100	100
<i>F204</i>	VI input point 2 frequency	0.0 - 400.0Hz	*	60.0
<i>F209</i>	Analog input filter	4 - 1000 ms	64	64

* Depends upon the setup menu settings. Refer to section 11.5.

* Connect a single-phase input model to R/L1 and S/L2/N.

Run and stop settings
You can switch between forward run (F) and reverse run (R), and run/stop with external signals.

Setting characteristics for the frequency setting signal and operation frequency
Set characteristics at two points in the diagram below.

Connecting and calibrating the frequency meter
Select the type of meter connected at *F581* and calibrate.
⇒ Refer to section 3.4 for details.

***F109* = 0: Voltage signal input (0 - 10 V) (default)**

7.3.2 Settings depending on current (4 to 20 mA) input

You can set the frequency settings by inputting an analog current signal of 4 (0) to 20mA dc between the VI and CC terminals.

The following shows examples when the run command is input from the terminal.

Title	Function	Adjustment range	Default setting	Setting example
<i>F000</i>	Command mode selection	0 - 2	1 (panel keypad)	0 (terminal board)
<i>F000</i>	Frequency setting mode selection	0 - 5	2 (setting dial)	0 (terminal board VI)
<i>F109</i>	Analog/logic input selection (VI terminal)	0: Voltage signal input (0 - 10V) 1: Current signal input (4 - 20mA) 2: Logic input 3: Voltage signal input (0 - 5V)	0	1 (Current signal (4 - 20mA))
<i>F201</i>	VI input point 1 setting	0 - 100%	0	20(0)
<i>F202</i>	VI input point 1 frequency	0.0 - 400.0Hz	0.0	0.0
<i>F203</i>	VI input point 2 setting	0 - 100%	100	100
<i>F204</i>	VI input point 2 frequency	0.0 - 400.0Hz	*	60.0
<i>F209</i>	Analog input filter	4 - 1000 ms	64	64

* Depends upon the setup menu settings. Refer to section 11.5.

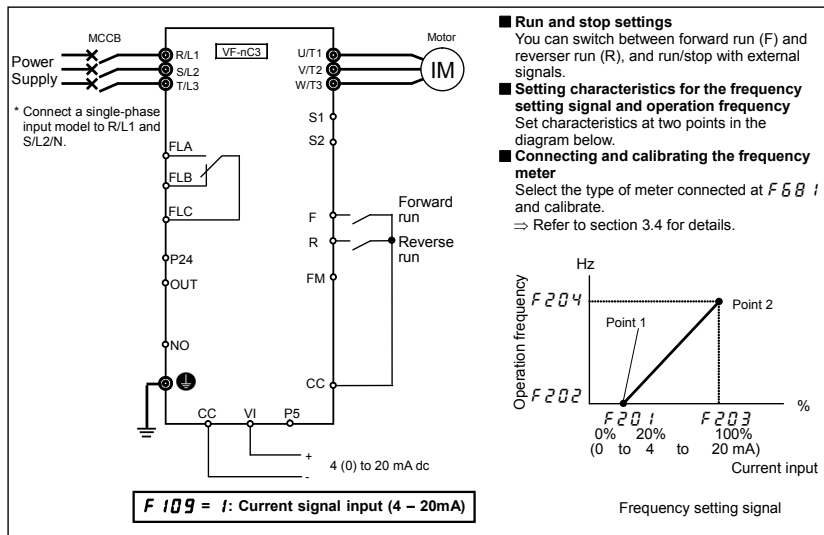

7.3.3 Settings depending on voltage (0 to 5 V) input <external potentiometer>

You can set the frequency by connecting the FRH kit (optional), or a potentiometer (1 to 10k Ω – 1/4W) to the VI terminal.

Connect the potentiometer between the P5, VI, and CC terminals. The standard voltage for the P5 terminal is 5Vdc. Instead of using the potentiometer, you can set the frequency settings by inputting an analog voltage signal of 0 to 5Vdc between the VI and CC terminals.

The following shows examples when the run command is input from the terminal.

Title	Function	Adjustment range	Default setting	Setting example
<i>C n d</i>	Command mode selection	0 - 2	1 (panel keypad)	0 (terminal board)
<i>F n d</i>	Frequency setting mode selection	0 - 5	2 (setting dial)	0 (terminal board VI)
<i>F 1 0 9</i>	Analog/logic input selection (VI terminal)	0: Voltage signal input (0 - 10V) 1: Current signal input (4 - 20mA) 2: Logic input 3: Voltage signal input (0 - 5V)	0	3 (Voltage signal (0 - 5V))
<i>F 2 0 1</i>	VI input point 1 setting	0 - 100%	0	0
<i>F 2 0 2</i>	VI input point 1 frequency	0.0 - 400.0Hz	0.0	0.0
<i>F 2 0 3</i>	VI input point 2 setting	0 - 100%	100	100
<i>F 2 0 4</i>	VI input point 2 frequency	0.0 - 400.0Hz	*	60.0
<i>F 2 0 9</i>	Analog input filter	4 - 1000 ms	64	64

*Depends upon the setup menu settings. Refer to section 11.5.

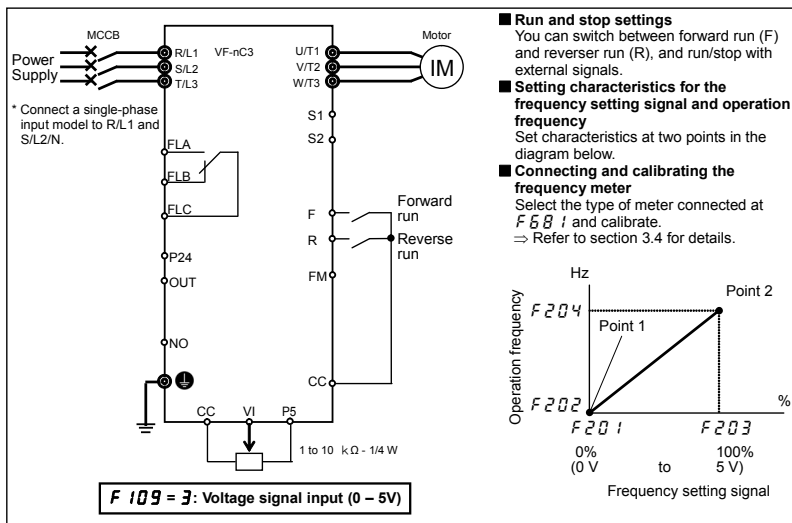

8. Monitoring the inverter status in operation / before tripping

8.1 Flow of status monitor mode

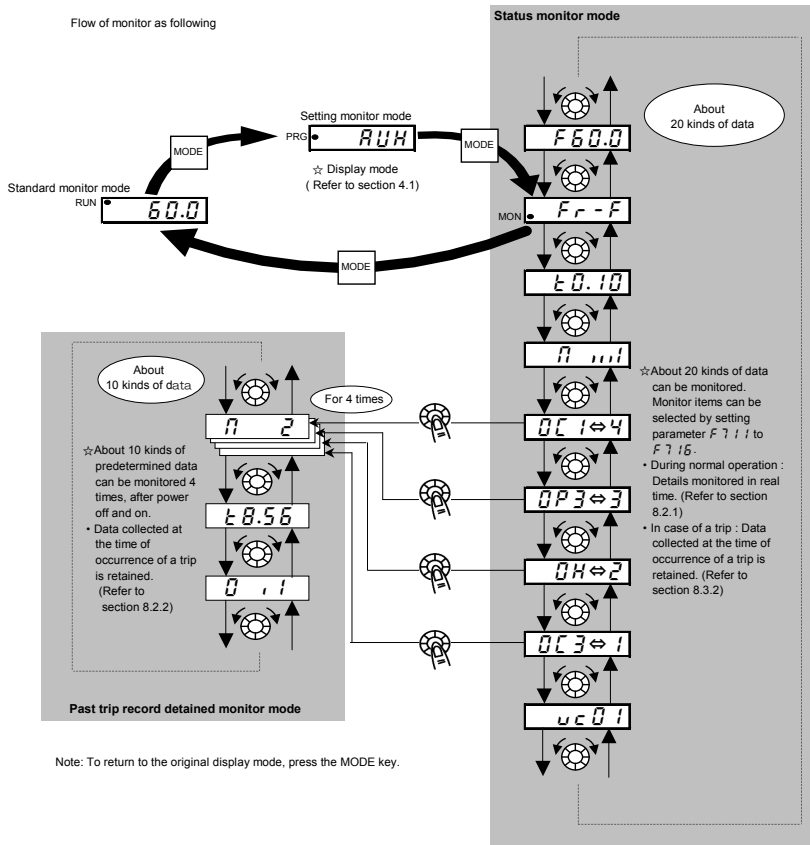

8.2 Status monitor mode







8.2.1 Status monitor under normal conditions

In this mode, you can monitor the operation status of the inverter.

To display the operation status during normal operation:

Press the MODE key twice.

Setting procedure (eg. operation at 60Hz)

Item displayed	Panel operated	LED display	Communication No.	Description
Output frequency *		60.0		The output frequency is displayed (Operation at 60Hz). (When standard monitor display selection $F710$ [output frequency])
Parameter setting mode	MODE	RUH		The first basic parameter "RUH" (history function) is displayed.
Direction of rotation	MODE	F _r -F	FE01	The direction of rotation is displayed. (F _r -F: forward run, F _r -r: reverse run)
Frequency command value *		F60.0	FE02	The frequency command value (Hz/free unit) is displayed. (In case of $F711=2$)
Note 2 Output current *		□ 80	FE03	The inverter output current (load current) (%A) is displayed. (In case of $F712=1$)
Note 3 Input voltage *		4100	FE04	The inverter input voltage (DC detection) (%V) is displayed. (In case of $F713=3$)
Output voltage *		P 100	FE05	The inverter output voltage (%V) is displayed. (In case of $F714=4$)
Inverter load factor *		L 70	FE27	The inverter load factor (%) is displayed. (In case of $F715=27$)
Output frequency *		o 60.0	FE00	The output frequency (Hz/free unit) is displayed. (In case of $F716=0$)

(Continued overleaf)

* Monitor items can be selected by setting parameters $F710$ to $F716$, ($F720$). Refer to Note 11. Refer to page H-8 for notes.











(Continued)

	Item displayed	Panel operated	LED display	Communication No.	Description
Note 4	Input terminal		R	FE06	The ON/OFF status of each of the control signal input terminals (F, R, S1, S2, V1) is displayed in bits. ON: OFF: .
Note 5	Output terminal		O . .	FE07	The ON/OFF status of each of the control signal output terminals (OUT and FL) is displayed in bits. ON: OFF: .
	Logic input terminals setting		L - 5	FD31	Logic setting by F 1 2 7 is displayed. L - 4 9 : Sink logic (External power supply) L - 5 0 : Source logic L - 5 1 : Sink logic (Internal power supply)
Note 6	CPU1 version		v 1 0	FE08	The version of the CPU1 is displayed.
	CPU2 version		v c 0	FE73	The version of the CPU2 is displayed.
Note 6	Past trip 1		0 C 3 ⇔ 1	FE10	Past trip 1 (displayed alternately)
Note 6	Past trip 2		0 H ⇔ 2	FE11	Past trip 2 (displayed alternately)
	Past trip 3		0 P 3 ⇔ 3	FE12	Past trip 3 (displayed alternately)
Note 6	Past trip 4		n E r r ⇔ 4	FE13	Past trip 4 (displayed alternately)

(Continued overleaf)

Refer to page H-8 for notes.















(Continued)

	Item displayed	Panel operated	LED display	Communication No.	Description
Note 7	Parts replacement alarm information			FE79	The ON/OFF status of each of the cooling fan, circuit board capacitor, main circuit capacitor of parts replacement alarm or cumulative operation time are displayed in bits. ON:  OFF:  
Note 8	Cumulative operation time			FE14	The cumulative operation time is displayed. (0.01=1 hour, 1.00=100 hours)
	Default display mode				The output frequency is displayed (Operation at 60Hz).

8.2.2 Display of detailed information on a past trip

Details on a past trip (of trips 1 to 4) can be displayed, as shown in the table below, by pressing the center of the setting dial when the trip record is selected in the status monitor mode.







Unlike the "Display of trip information at the occurrence of a trip" in 8.3.2, details on a past trip can be displayed, even after the inverter is turned off or reset.

	Item displayed	Panel operated	LED display	Description
Note 9	Past trip 1			Past trip 1 (displayed alternately)
	Continuous trips			For OCA, OCL, and Err5, the number of times (maximum of 31) the same trip occurred in succession is displayed (unit: times). Detailed information is recorded at the beginning and ending numbers.
	Output frequency			The output frequency when the trip occurred is displayed.
	Direction of rotation			The direction of rotation when the trip occurred is displayed. (F r - F: Forward run, F r - r: Reverse run)
	Frequency command value			The frequency command value when the trip occurred is displayed.
Note 2	Output current			The inverter output current when the trip occurred is displayed. (%A)
Note 3	Input voltage			The inverter input voltage (DC detection) when the trip occurred is displayed. (%V).

(Continued overleaf)

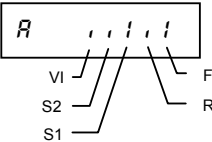
Refer to page H-8 for notes.

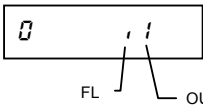
(Continued)

	Item displayed	Panel operated	LED display	Description
	Output voltage		P 100	The inverter output voltage when the trip occurred is displayed. (%N)
Note 4	Input terminal		R	The ON/OFF statuses of the control input terminals (F, R, S1, S2, V1) are displayed in bits. ON: ! OFF: , <div style="text-align: right;">  </div>
Note 5	Output terminal		0 . .	The ON/OFF statuses of the control output terminals (OUT and FL) are displayed in bits. ON: ! OFF: , <div style="text-align: right;">  </div>
Note 8	Cumulative operation time		t 8.56	The cumulative operation time when the trip occurred is displayed. (0.01=1 hour, 1.00=100 hours)
	Past trip 1		0C1 ↔ !	Press this key to return to past trip 1.

* The monitor value of a trip is not always recorded as the maximum value because of the time required for detection.

Refer to page H-8 for notes.

8.3 Display of trip information

8.3.1 Trip code display

If the inverter trips, an error code is displayed to suggest the cause. Since trip records are retained, information on each trip can be displayed anytime in the status monitor mode.

Refer to section 13.1 for details about trip code display.







☆ The monitor value of a trip is not always recorded as the maximum value because of the time required for detection.

8.3.2 Display of trip information at the occurrence of a trip

At the occurrence of a trip, the same information as that displayed in the mode described in " 8.2.1 Status monitor under normal conditions ", can be displayed, as shown in the table below, if the inverter is not turned off or reset.

To display trip information after turning off or resetting the inverter, follow the steps described in " 8.2.2 Display of detailed information on a past trip ".

■ Example of call-up of trip information

Item displayed	Panel operated	LED display	Communication No.	Description
Cause of trip		OPZ		Status monitor mode (The code blinks if a trip occurs.) The motor coasts and comes to a stop (coast stop).
Parameter setting mode	MODE	RUH		The first basic parameter "RUH" (history function) is displayed.
Direction of rotation	MODE	F _r -F	FE01	The direction of rotation at the occurrence of a trip is displayed. (F _r - F: forward run, F _r - r: reverser run).
Note 1 Frequency command value *		F60.0	FE02	The frequency command value (Hz/free unit) at the occurrence of a trip is displayed. (In case of F711=2)
Note 3 Output current *		C130	FE03	The output power of the inverter at the occurrence of a trip (%A) is displayed. (In case of F712=1)
Note 3 Input voltage *		Y141	FE04	The inverter input voltage (DC detection) (%V) at the occurrence of a trip is displayed. (In case of F713=3)
Note 3 Output voltage *		P100	FE05	The output voltage of the inverter at the occurrence of a trip (%V) is displayed. (In case of F714=4)
Note 1 Inverter load factor *		L70	FE27	The inverter load factor (%) at the occurrence of a trip is displayed. (In case of F715=27)
Note 1 Output frequency *		o60.0	FE00	The inverter output frequency (Hz/free unit) at the occurrence of a trip is displayed. (In case of F716=0)

(Continued overleaf)

* Monitor items can be selected by settings parameters F710 to F716, (F720). Refer to Note 11.

Refer to page H-8 for notes.





(Continued)

Item displayed	Panel operated	LED display	Communication No.	Description
Note 4 Input terminal		R	FE06	The ON/OFF statuses of the control input terminals (F, R, S1, S2, V1) are displayed in bits. ON: . OFF: .
Note 5 Output terminal		0 . .	FE07	The ON/OFF status of each of the control signal output terminals (OUT and FL) at the occurrence of a trip is displayed in bits. ON: . OFF: .
Logic input terminals setting		L - 5 0	FD31	Logic setting by F 1 2 7 is displayed. L - 4 9: Sink logic (External power supply) L - 5 0: Source logic L - 5 1: Sink logic (Internal power supply)
CPU1 version		u 1 0 1	FE08	The version of the CPU1 is displayed.
CPU2 version		u c 0 1	FE73	The version of the CPU2 is displayed.
Note 6 Past trip 1		0 P 2 ⇄ 1	FE10	Past trip 1 (displayed alternately)
Note 6 Past trip 2		0 H ⇄ 2	FE11	Past trip 2 (displayed alternately)
Note 6 Past trip 3		0 P 3 ⇄ 3	FE12	Past trip 3 (displayed alternately)
Note 6 Past trip 4		n E r r ⇄ 4	FE13	Past trip 4 (displayed alternately)

(Continued overleaf)

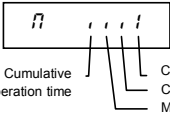
Refer to page H-8 for notes.

(Continued)

	Item displayed	Panel operated	LED display	Communication No.	Description
Note 7	Parts replacement alarm information		$n \dots i$	FE79	The ON/OFF status of each of the cooling fan, circuit board capacitor, main circuit capacitor of parts replacement alarm or cumulative operation time are displayed in bits. ON: i OFF: \cdot 
Note 8	Cumulative operation time		$t 0 . 1 0$	FE14	The cumulative operation time is displayed. (0.01=1 hour, 1.00=100 hours)
	Default display mode		$0 P 2$		The cause of the trip is displayed.

Note 1: The characters to the left disappear above 100 Hz. (Ex: 120 Hz is $1 2 0 . 0$)

Note 2: You can switch between % and A (ampere)/V (volt), using the parameter $F 7 0 i$ (current/voltage unit selection).

Note 3: The input (DC) voltage displayed is $1/\sqrt{2}$ times as large as the rectified d.c. input voltage.

In case of 120V models, $2/\sqrt{2}$ times of input voltage is displayed because 120V models have a voltage doubler circuit. (Ex: "200V" is displayed when input voltage is AC100V).

Note 4: If $F 1 0 9 = 2$ (Logic input): VI bar is activated depend on VI terminal ON/OFF.

If $F 1 0 9 = 0, 1$ or 3 (Voltage/current input): VI bar is always OFF.

Note 5: If $F 5 5 9 = 0$ (Logic output): Out bar is activated depend on OUT terminal ON/OFF.

If $F 5 5 9 = 1$ (Pulse train output): OUT bar is always OFF.

Note 6: Past trip records are displayed in the following sequence: 1 (latest trip record) \leftrightarrow 2 \leftrightarrow 3 \leftrightarrow 4 (oldest trip record). If no trip occurred in the past, the message "n E r r" will be displayed. Details on past trip record 1, 2, 3 or 4 can be displayed by pressing the center of the setting dial when past trip 1, 2, 3 or 4 is displayed. Refer to section 8.2.2 for details.

Note 7: Parts replacement alarm is displayed based on the value calculated from the annual average ambient temperature specified using $F 5 3 4$, the ON time of the inverter, the operating time of the motor and the output current (load factor). Use this alarm as a guide only, since it is based on a rough estimation.

Note 8: The cumulative operation time increments only when the machine is in operation.

Note 9: If there is no trip record, n E r r is displayed.

Note 10: Of the items displayed on the monitor, the reference values of items expressed in percent are listed below.

- Load current: The reference value (100% value) is the rated output current indicated on the nameplate. The unit can be switched to A (amperes).

- Input voltage:** The voltage displayed is the voltage determined by converting the voltage measured in the DC section into an AC voltage. The reference value (100% value) is 200 volts for 240V models, 100 volts for 120V models. The unit can be switched to V (volts).
- Output voltage:** The voltage displayed is the output command voltage. 100% reference value is 200V on both 120V and 240V models. This unit can be switched to V (volts).
- Torque current:** The reference value (100% value) is the rated output current indicated on the nameplate. The current required to generate torque is calculated from the load current by vector operations. The value thus calculated is displayed.
- Load factor of inverter:** Depending on the PWM carrier frequency ($F300$) setting and so on, the actual rated current may become smaller than the rated output current indicated on the nameplate. With the actual rated current at that time (after a reduction) as 100%, the proportion of the load current to the rated current is indicated in percent. The load factor is also used to calculate the conditions for overload trip (OL).

Note 11: Status monitor of * mark is displayed by $F710$ to $F718$ and $F720$ setting.

The left side character is as following table by each parameter setting number.

Parameter	Setting No.	LED display	Function	Unit	
$F710$ to $F716$, $F720$	0	050.0	Output frequency	Hz / free unit	
	1	115.5	Output current	% / A	
	2	$F50.0$	Frequency command value	Hz / free unit	
$F711$ to $F716$	3	410.0	Input voltage (DC detection)	% / V	
	4	$P90$	Output voltage (command value)	% / V	
	5	$h3.0$	Input power	kW	
	6	$H2.8$	Output power	kW	
	7	980	Torque	%	
	8	$c90$	Torque current	% / A	
	9-11	-	-	-	
	12	$b51.0$	Stator frequency	Hz / free unit	
	13-17	-	-	-	
	$F710$, $F720$	18	****	Arbitrary code from communication	-
	$F711$ to $F716$	19-22	-	-	-
23		$d40.0$	PID feedback value	Hz / free unit	
24-26		-	-	-	
27		$L70$	Drive load factor	%	
$F710$ to $F716$, $F720$	28-51	-	-	-	
	52	$c50.0$	During stop : Frequency command value During operation : Output frequency	Hz / free unit	

9. Measures to satisfy the standards

9.1 How to cope with the CE directive

In Europe, the EMC directive and the low-voltage directive, which took effect in 1996 and 1997, respectively, made it obligatory to put the CE mark on every applicable product to prove that it complies with the directives. Inverters do not work alone but are designed to be installed in a control panel and always used in combination with other machines or systems which control them, so they themselves are not considered to be subject to the EMC directive. However, the CE mark must be put on all inverters because they are subject to the low-voltage directive.

The CE mark must be put on all machines and systems with built-in inverters because such machines and systems are subject to the above directives. It is the responsibility of the manufacturers of such final products to put the CE mark on each one. If they are "final" products, they might also be subject to machine-related directives. It is the responsibility of the manufacturers of such final products to put the CE mark on each one. In order to make machines and systems with built-in inverters compliant with the EMC directive and the low-voltage directive, this section explains how to install inverters and what measures should be taken to satisfy the EMC directive.

We have tested representative models with them installed as described later in this manual to check for conformity with the EMC directive. However, we cannot check all inverters for conformity because whether or not they conform to the EMC directive depends on how they are installed and connected. In other words, the application of the EMC directive varies depending on the composition of the control panel with a built-in inverter(s), the relationship with other built-in electrical components, the wiring condition, the layout condition, and so on. Therefore, please verify yourself whether your machine or system conforms to the EMC directive.

9.1.1 About the EMC directive

The CE mark must be put on every final product that includes an inverter(s) and a motor(s). In the VF-nC3 series of inverters, the single-phase 200 V class is equipped with an EMI filter and complies with the EMC directive if wiring is carried out correctly.

- EMC directive
2004/108/EC

The EMC standards are broadly divided into two categories; immunity- and emission-related standards, each of which is further categorized according to the operating environment of each individual machine. Since inverters are intended for use with industrial systems under industrial environments, they fall within the EMC categories listed in Table 1 below. The tests required for machines and systems as final products are almost the same as those required for inverters.

Table 1 EMC standards

Category	Subcategory	Product standards	Test standard
Emission	Radiation noise	IEC 61800-3	CISPR11(EN55011)
	Transmission noise		CISPR11(EN55011)
	Static discharge		IEC61000-4-2
Immunity	Radioactive radio-frequency magnetic contactor field		IEC61000-4-3
	First transient burst		IEC61000-4-4
	Lightning surge		IEC61000-4-5
	Radio-frequency induction/transmission interference		IEC61000-4-6
	Voltage dip/Interruption of power		IEC61000-4-11

9.1.2 Measures to satisfy the EMC directive

This subsection explains what measures must be taken to satisfy the EMC directive.

- (1) Insert a recommended EMI filter (Table 2) on the input side of the inverter to reduce and transmission noise and radiation noise from input cables.

In the combinations listed in Table 2, Inverters are tested in these combinations to see if they comply with transmission noise standards.

Table 2 lists noise filters recommended for the inverters.

Table 2 Combinations of inverter and EMI filter

Three-phase 240V class

Combination of inverter and filter		
Inverter type	Transmission noise IEC61800-3 Category C1 Applicable filters (Length of motor connecting cable: Max. 5 m, PWM carrier frequency : 4 to 12kHz)	Transmission noise IEC61800-3 Category C2 Applicable filters (Length of motor connecting cable: Max. 20 m, PWM carrier frequency : 4 to 12kHz)
VFNC3-2001P	-	EMFA2006Z
VFNC3-2002P	-	EMFA2006Z
VFNC3-2004P	-	EMFA2006Z
VFNC3-2007P	-	EMFA2006Z
VFNC3-2015P	EMFA2015Z	
VFNC3-2022P	EMFA2015Z	

Single-phase 240 V class

Combination of inverter and filter				
Inverter type	Transmission noise IEC61800-3, category C1 applicable filters (motor wiring length of less than 5 m)	Transmission noise IEC61800-3, category C2 applicable filters (motor wiring length of less than 10 m)	Transmission noise IEC61800-3 Category C1 Applicable filters (Length of motor connecting cable: Max. 20 m, PWM carrier frequency : 4 to 12kHz)	Transmission noise IEC61800-3 Category C2 Applicable filters (Length of motor connecting cable: Max. 50 m, PWM carrier frequency : 4 to 12kHz)
VFNC3S-2001PL	Built-in filter	Built-in filter	EMFAS2011Z	
VFNC3S-2002PL			EMFAS2011Z	
VFNC3S-2004PL			EMFAS2011Z	
VFNC3S-2007PL			EMFAS2011Z	
VFNC3S-2015PL			EMFAS2025Z	
VFNC3S-2022PL			EMFAS2025Z	

Single-phase 120 V class

Combination of inverter and filter		
Inverter type	Transmission noise IEC61800-3 Category C1 Applicable filters (Length of motor connecting cable: Max. 5 m, PWM carrier frequency : 4 to 12kHz)	Transmission noise IEC61800-3 Category C2 Applicable filters (Length of motor connecting cable: Max. 20 m, PWM carrier frequency : 4 to 12kHz)
VFNC3S-1001P	EMFAS2011Z	
VFNC3S-1002P	EMFAS2011Z	
VFNC3S-1004P	EMFAS2011Z	
VFNC3S-1007P	EMFAS2025Z	

- (2) Use shielded power cables, such as inverter output cables, and shielded control cables. Route the cables and wires so as to minimize their lengths. Keep a distance between the power cable and the control cable and between the input and output wires of the power cable. Do not route them in parallel or bind them together, instead cross at right angle.
- (3) It is more effective in limiting the radiation noise to install the inverter in a sealed steel cabinet. Using wires as thick and short as possible, earth the metal plate and the control panel securely with a distance kept between the earth cable and the power cable.
- (4) Route the input and output wires apart from each other.
- (5) To suppress radiation noise from cables, ground all shielded cables through a noise cut plate. It is effective to earth shielded cables in the vicinity of the inverter and cabinet (within a radius of 10cm from each of them). Inserting a ferrite core in a shielded cable is even more effective in limiting the radiation noise.
- (6) To further limit the radiation noise, insert a zero-phase reactor in the inverter output line and insert ferrite cores in the earth cables of the metal plate and cabinet.

[Example of wiring]

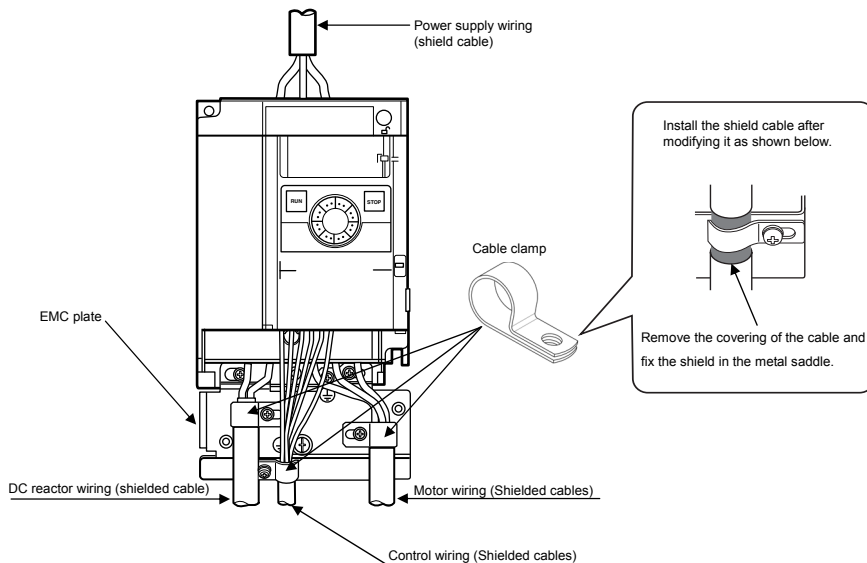

Note 1) Refer to the section 12.2 for optional EMC plate.

Note 2) Use commercial products for cable clamps and screws.

Example:

Cable clamp: Screw Mount ,P Style, Aluminum (Essentra Components)

Screw: ISO 261:1993 / JIS B205:2001 coarse pitch screw M4x10, M5x12

9.1.3 About the low-voltage directive

The low-voltage directive provides for the safety of machines and systems. All Toshiba inverters are CE-marked in accordance with the standard EN 50178 specified by the low-voltage directive, and can therefore be installed in machines or systems and imported without problem to European countries.

Applicable standard: IEC61800-5-1

Pollution level: 2

Overvoltage category: 3

9.1.4 Measures to satisfy the low-voltage directive

When incorporating the inverter into a machine or system, it is necessary to take the following measures so that the inverter satisfies the low-voltage directive.

- (1) Install the inverter in a cabinet and ground the inverter enclosure. When doing maintenance, be extremely careful not to put your fingers into the inverter through a wiring hole and touch a charged part, which may occur depending on the model and capacity of the inverter used.
- (2) Connect earth wiring to the earth terminal on the EMC plate. Or install the EMC plate (attached as standard) and another cable connect to earth terminal on the EMC plate. Refer to the table in 10.1 for details about earth cable sizes.
- (3) Install a non-fuse circuit breaker or a fuse on the input side of the inverter. (Refer to section 10.1 and 9.2.3)

9.2 Compliance with UL Standard and CSA Standard

The VF-nC3 models, that conform to the UL Standard and CSA Standard have the UL/CSA mark on the nameplate.

9.2.1 General

The following steps must be performed before wiring and servicing.

- (1) Turn off all input power.
- (2) Wait at least fifteen minutes and check to make sure that the charge lamp is no longer lit.
- (3) Use a tester that can measure DC voltage (400VDC or more), and check to make sure that the voltage to the DC main circuits (across PA/+ and PC/-) is 45V or less.

If these steps are not properly performed, the wiring will cause electric shock.

9.2.2 Compliance with Installation

A UL certificate was granted on the assumption that the inverter would be installed in an enclosure.

Therefore, the environments in an enclosure take measures to maintain the following table.

(Refer to section 1.4.4)

■Environments

Location of use	Indoors; not exposed to direct sunlight, corrosive gas, explosive gas, flammable gas, oil mist, or dust; and vibration of less than 5.9m/s ² (10 to 55Hz).
Elevation	1000 m or less
Ambient temperature	-10 to +40°C (50°C) Maximum Surrounding Air Temperature 0.1kW to 0.4kW in 100V class / 0.1kW to 0.75kW in 200V class : 40 °C 0.75kW in 100V class / 1.5kW to 3.7kW in 200V class : 50 °C
Storage temperature	-25 to +70°C

■Current reduction

According to the carrier frequency F_{300} setting, you may need to reduce the inverter's continuous output current. Reduction rates vary depending on the capacity of the inverter.

[Three-phase/Single-phase 200 V class]

Inverter model	Ambient temperature	Input voltage 200V to 240V	
		PWM Carrier frequency	
		2 to 4 kHz	5 to 12 kHz
VFNC3-2001P VFNC3S-2001PL	40°C or less *1	0.7 A	0.7 A
VFNC3-2002P VFNC3S-2002PL	40°C or less *1	1.4 A	1.4 A
VFNC3-2004P VFNC3S-2004PL	40°C or less *1	2.4 A	2.4 A
VFNC3-2007P VFNC3S-2007PL	40°C or less *1	4.2 A	3.6 A 3.2 A
VFNC3-2015P VFNC3S-2015PL	40°C or less *1 Above 40 to 50°C *2	7.5 A	7.5 A 7.1 A
VFNC3-2022P VFNC3S-2022PL	40°C or less *1	10.0 A	8.5 A 9.1 A
VFNC3-2022P VFNC3S-2022PL	Above 40 to 50°C *2	10.0 A	7.5 A
VFNC3-2037P	40°C or less *1 Above 40 to 50°C *2	16.7 A	14.0 A

[Single-phase 100 V class]

Inverter model	Ambient temperature	Input voltage 100V to 120V	
		PWM Carrier frequency	
		2 to 4 kHz	5 to 12 kHz
VFNC3S-1001P	40°C or less *1	0.7 A	0.7 A
VFNC3S-1002P	40°C or less *1	1.4 A	1.4 A
VFNC3S-1004P	40°C or less *1	2.4 A	2.4 A
VFNC3S-1007P	40°C or less *1 Above 40 to 50°C *2	4.2 A	4.0 A

*1: Maintain the ambient temperature of 40°C or less for the compliance with UL standard.

*2: Remove the protective label on the top of the inverter for the compliance with UL standard for the ambient temperature above 40°C to 50°C.

9.2.3 Compliance with Connection

Use the UL conformed cables (Rating 75 °C or more, Use the copper conductors only.) to the main circuit terminals (R/L1, S/L2, S/L2/N, T/L3, U/T1, V/T2, W/T3).

For instruction in the United States, Integral solid state short circuit protection does not provide branch circuit protection. Branch circuit protection must be provided in accordance with the National Electrical Code and any additional local codes.

For instruction in the Canada, Integral solid state short circuit protection does not provide branch circuit protection. Branch circuit protection must be provided in accordance with the Canadian Electrical Code and any additional local codes.

-> For recommended tightening torque for the main terminal, refer to section 1.3.3.

-> Use the ring terminal for the earth cables except grounding terminal on power supply terminal block, see Table 1.

-> For recommended wire size for the main terminal, see Table 2.

->Use the electric wire of Class 1 for the control wire. (For wire size and tightening torque, see the label on unit)

Table 1 Ring terminal sizes for earth cables

Earth Cable Sizes	M4 (grounding terminal)	M5 (grounding terminal)
AWG14	R2-4 [JIS standard]	R2-5 [JIS standard]
AWG12	R5.5-4 [JIS standard]	R5.5-5 [JIS standard]
AWG10	R5.5-4 [JIS standard]	R5.5-5 [JIS standard]

9.2.4 Compliance with Peripheral devices

■Connections with peripheral equipment

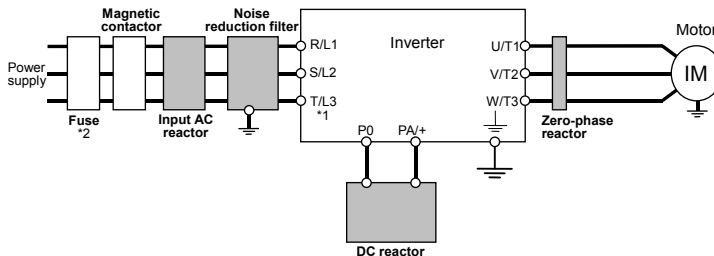

*1: The T/L3 terminal is not provided for any single-phase class.

So if you are using single-phase class, use the R/L1 and S/L2/N terminals to connect power cables.

*2: Use the UL listed fuses at connecting to power supply.

Short circuit test is performed under the condition of the power supply short-circuit currents.

These interrupting capacities and fuse rating currents depend on the applicable motor capacities.

For input withstanding rating, fuse rating currents and wire size, see Table 2.

Table 2 AIC, Fuse and Wire sizes

Inverter model	Maximum voltage (V)	Input withstand rating (kA) (1)	Output interrupt rating (kA) (2)	Branch circuit protection	Rating (A)	Wire sizes of power circuit	Earth Cable
	<Y>		<X>	<Z1>	<Z2>		
VFNC3-2001P	240	5	5	Class CC	3	AWG 14	AWG 14
VFNC3-2002P	240	5	5	Class CC	5	AWG 14	AWG 14
VFNC3-2004P	240	5	5	Class CC	7	AWG 14	AWG 14
VFNC3-2007P	240	5	5	Class J	15	AWG 14	AWG 14
VFNC3-2015P	240	5	5	Class J	25	AWG 14	AWG 14
VFNC3-2022P	240	5	5	Class J	25	AWG 12	AWG 14
VFNC3-2037P	240	5	5	Class J	45	AWG 10	AWG 10
VFNC3S-2001PL	240	1	5	Class CC	5	AWG 14	AWG 14
VFNC3S-2002PL	240	1	5	Class CC	7	AWG 14	AWG 14
VFNC3S-2004PL	240	1	5	Class J	15	AWG 14	AWG 14
VFNC3S-2007PL	240	1	5	Class J	25	AWG 14	AWG 14
VFNC3S-2015PL	240	1	5	Class J	40	AWG 10	AWG 12
VFNC3S-2022PL	240	1	5	Class J	45	AWG 10	AWG 10
VFNC3S-1001P	120	1	5	Class CC	8	AWG 14	AWG 14
VFNC3S-1002P	120	1	5	Class J	15	AWG 14	AWG 14
VFNC3S-1004P	120	1	5	Class J	25	AWG 14	AWG 14
VFNC3S-1007P	120	1	5	Class J	40	AWG 10	AWG 12

Suitable for use on a circuit capable of delivering not more than X rms symmetrical kilo Amperes, Y Volts maximum, when protected by Z1 with a maximum rating of Z2 .

- (1) Input withstand rating is that for which the product has been designed thermally. Installation on a supply greater than this level will require additional inductance to satisfy this level.
- (2) Output interrupt rating relies on Integral solid state short circuit protection. This does not provide branch circuit protection. Branch circuit protection must be provided in accordance with the National Electrical Code and any additional local codes. This is dependant on the type of installation.

9.2.5 Overload protection

VF-nC3 has overload protection.

Over current rating: 150%-1min. , 200%-0.5sec.

Refer to the nameplate for the rated current.

9.2.6 Motor thermal protection

The devices VF-nC3 are provided with integral overload and over-speed protection for the motor after activation of this function by setting.

Protection at 100% of the full load motor current. The motor thermal protection current (I_{Hr}) must be set to the rated current indicated on the motor nameplate.





In case of multi motor operation with one inverter, thermal relay should be connected to each motor.

For setting parameters of the motor thermal protection, refer to section 3.5.

9.2.7 Other

Please contact where you purchase the inverter, your Toshiba sales representative, if you need the hard copy (paper) of CD-ROM. Or please contact to phone number of back cover in instruction manual.

10. Peripheral devices

 Warning	
 Prohibited	<ul style="list-style-type: none"> When supplying power from a wall socket, do not exceed the rated capacity of the socket. Otherwise, this may generate excessive heat which can start a fire.
 Mandatory action	<ul style="list-style-type: none"> When using switchgear for the inverter, it must be installed in a cabinet. Failure to do so can lead to risk of electric shock and can result in death or serious injury.
 Be Grounded	<ul style="list-style-type: none"> Connect grounding cables securely. Failure to do so can lead to risk of electric shock or fire in case of a failure or short-circuit or electric leak.

10.1 Selection of wiring materials and devices

Voltage class	Capacity of applicable motor (kW)	Inverter model	Wire size (See Note 4)					
			Power circuit (mm ²) (Note 1.)		DC reactor (optional) (mm ²)		Grounding cable (mm ²)	
			IEC compliant	For Japan (JEAC800 1-2005)	IEC compliant	For Japan (JEAC800 1-2005)	IEC compliant	For Japan (JEAC800 1-2005)
Three-phase 240V class	0.1	VFNC3-2001P	1.5(1.5)	2.0(2.0)	1.5	2.0	2.5	2.0
	0.2	VFNC3-2002P	1.5(1.5)	2.0(2.0)	1.5	2.0	2.5	2.0
	0.4	VFNC3-2004P	1.5(1.5)	2.0(2.0)	1.5	2.0	2.5	2.0
	0.75	VFNC3-2007P	1.5(1.5)	2.0(2.0)	1.5	2.0	2.5	2.0
	1.5	VFNC3-2015P	1.5(1.5)	2.0(2.0)	1.5	2.0	2.5	2.0
	2.2	VFNC3-2022P	2.5(1.5)	2.0(2.0)	1.5	2.0	2.5	2.0
Single-phase 240V class	0.1	VFNC3S-2001PL	1.5(1.5)	2.0(2.0)	1.5	2.0	2.5	2.0
	0.2	VFNC3S-2002PL	1.5(1.5)	2.0(2.0)	1.5	2.0	2.5	2.0
	0.4	VFNC3S-2004PL	1.5(1.5)	2.0(2.0)	1.5	2.0	2.5	2.0
	0.75	VFNC3S-2007PL	1.5(1.5)	2.0(2.0)	1.5	2.0	2.5	2.0
	1.5	VFNC3S-2015PL	2.5(2.5)	2.0(2.0)	1.5	2.0	2.5	2.0
	2.2	VFNC3S-2022PL	4.0(4.0)	2.0(2.0)	1.5	2.0	4.0	3.5
Single-phase 120V class	0.1	VFNC3S-1001P	1.5	2.0	-	-	2.5	2.0
	0.2	VFNC3S-1002P	1.5	2.0	-	-	2.5	2.0
	0.4	VFNC3S-1004P	2.5	2.0	-	-	2.5	2.0
	0.75	VFNC3S-1007P	4.0	2.0	-	-	4.0	3.5

Note 1: Sizes of the wires connected to the input terminals R/L1, S/L2 and T/L3 and the output terminals U/T1, V/T2 and W/T3 when the length of each wire does not exceed 30m.

The numeric values in parentheses refer to the sizes of wires to be used when a DC reactor is connected.

Note 2: For the control circuit, use shielded wires 0.75 mm² or more in diameter.

Note 3: For grounding, use a cable with a size equal to or larger than the above.

Note 4: The wire sizes specified in the above table apply to HIV wires (copper wires shielded with an insulator with a maximum allowable temperature of 75°C) used at an ambient temperature of 50°C or less.

Note 5: If there is a need to bring the inverter into UL compliance, use wires specified in chapter 9.

■ Selection of wiring devices

Voltage class	Applicable motor (kW) ^r	Input current (A)		Molded-case circuit breaker (MCCB) Earth leakage circuit breaker (ELCB)		Magnetic contactor (MC)	
		Without DCL	With DCL	Rated current (A)		Rated current (A)	
				Without DCL	With DCL	Without DCL	With DCL
Three-phase 240V class	0.1	1.2	0.6	5	5	20	20
	0.2	2.0	0.9	5	5	20	20
	0.4	3.6	1.8	5	5	20	20
	0.75	6.3	3.5	10	5	20	20
	1.5	11.1	6.6	15	10	20	20
	2.2	14.9	9.3	20	15	20	20
	4.0	23.8	16.1	30	30	32	20
Single-phase 240V class	0.1	2.0	1.2	5	5	20	20
	0.2	3.4	2.1	5	5	20	20
	0.4	5.9	4.1	10	5	20	20
	0.75	10.2	7.7	15	10	20	20
	1.5	17.8	14.8	30	20	20	20
	2.2	24	20.3	30	30	32	32
Single-phase 120V class	0.1	3.5	-	5	-	20	-
	0.2	6.0	-	10	-	20	-
	0.4	11.4	-	15	-	20	-
	0.75	18.9	-	30	-	20	-

Note 1: Be sure to attach a surge killer to the exciting coil of the relay and the magnetic contactor.

Note 2: When using the auxiliary contacts 2a of the magnetic contactor MC for the control circuit, connect the contacts 2a in parallel to increase reliability.

Note 3: When a motor is driven by commercial power supply using commercial power supply / inverter switching circuit, use a magnetic contactor appropriated AC-3 class the motor rated current.

Note 4: Select an MCCB with a current breaking rating appropriate to the capacity of the power supply, because short-circuit currents vary greatly depending on the capacity of the power supply and the condition of the wiring system. The MCCB, MC and ELCB in this table were selected, on the assumption that a power supply with a normal capacity would be used.

10.2 Installation of a magnetic contactor

If using the inverter without installing a magnetic contactor (MC) in the primary circuit, use an MCCB (with a power cutoff device) to open the primary circuit when the inverter protective circuit is activated.

When using an optional brake module, install a magnetic contactor (MC) or non-fuse circuit breaker with a power cutoff device on the primary power supply of the inverter, so that the power circuit opens when the failure detection relay (FL) in the inverter or the externally installed overload relay is actuated.

■ Magnetic contactor in the primary circuit

To detach the inverter from the power supply in any of the following cases, insert a magnetic contactor (primary-side magnetic contactor) between the inverter and the power supply.

- (1) If the motor overload relay is tripped
- (2) If the protective detector (FL) built into the inverter is activated
- (3) In the event of a power failure (for prevention of auto-restart)
- (4) If the resistor protective relay is tripped when a braking resistor and braking module (option) are used

When using the inverter with no magnetic contactor (MC) on the primary side, install a non-fuse circuit breaker with a voltage tripping coil instead of an MC and adjust the circuit breaker so that it will be tripped if the protective relay referred to above is activated. To detect a power failure, use an undervoltage relay or the like.

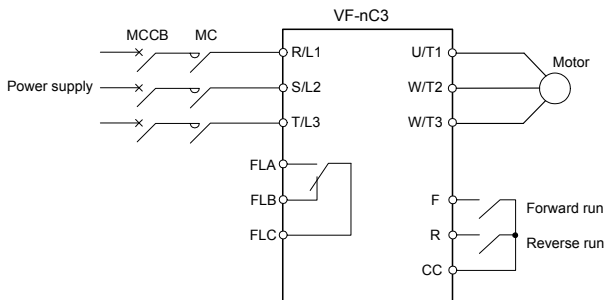

Example of connection of a magnetic contactor in the primary circuit

Notes on wiring

- When frequently switching between start and stop, do not use the magnetic contactor on the primary side as an on-off switch for the inverter.
Avoid switching a magnetic contactor on the primary side more frequently than once every 1 hour. Instead, stop and start the inverter by using terminals F and CC (forward run) or R and CC (reverse run).
- Be sure to attach a surge killer to the exciting coil of the magnetic contactor (MC).

■ Magnetic contactor in the secondary circuit

A magnetic contactor may be installed on the secondary side to switch controlled motors or supply commercial power to the load when the inverter is out of operation.

Notes on wiring

- Be sure to interlock the magnetic contactor on the secondary side with the power supply to prevent commercial power from being applied to the inverter output terminals.
- When installing a magnetic contactor (MC) between the inverter and the motor, avoid turning the magnetic contactor on or off during operation. Turning the magnetic contactor on or off during operation causes a current to rush into the inverter which could lead to malfunction.

10.3 Installation of an overload relay

- 1) The VF-nC3 inverter has an electronic-thermal overload protective function.
In the following cases, however, an overload relay suitable for the adjustment of the motor electronic thermal protection level ($\underline{L} H r$) and appropriate to the motor used should be installed between the inverter and the motor.
 - When using a motor with a current rating different to that of the corresponding Toshiba general-purpose motor
 - When operating a single motor with an output smaller than that of the applicable standard motor or more than one motor simultaneously.
- 2) When using the VF-nC3 inverter to operate a constant-torque motor, such as the Toshiba VF motor, adjust the protection characteristic of the electronic thermal protection unit ($\underline{D} \underline{L} \underline{P}$) to the VF motor use.
- 3) It is recommended to use a motor with a thermal relay embedded in the motor coil to give sufficient protection to the motor, especially when it runs in a low-speed range.

10.4 Optional external devices

The following external devices are optionally available for this inverter.

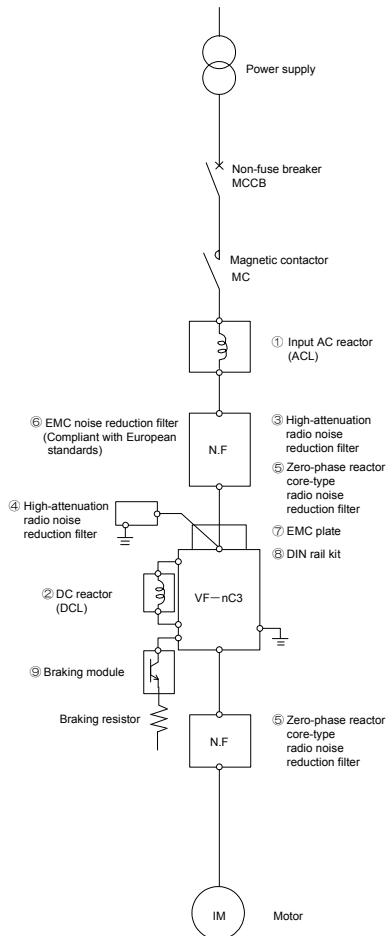

Note)

When copying parameters by the Parameter writer, execute after setting the setup menu. Refer to section 3.1 for details.

(10) Parameter writer	: PWU003Z
Note)	: RKP002Z
(11) Extension panel	: RKP007Z
(12) Remote control panel	: CBVR-7B1
(13) Frequency meter	: QS6T
(14) FRH kit	: FRH kit
(15) USB communication converter	: USB001Z

11. Table of parameters and data

11.1 User parameters

Title	Function	Unit	Minimum setting unit Panel/Communication	Adjustment range	Default setting	User setting	Reference
$F\checkmark$	FC	Operation frequency of operation panel	Hz	0.1/0.01	$L L - U U$	0.0	3.2.2

11.2 Basic parameters

• Four navigation functions

Title	Communication No.	Function	Unit	Minimum setting unit Panel/Communication	Adjustment range	Default setting	User setting	Reference
$R U H$	AUH	-	History function	-	-	-	-	4.3 5.1
$R U F$	AUF	0093	Guidance function	-	-	0	-	4.3 5.2
$R U 1$	AU1	0000	Automatic acceleration/ deceleration	-	-	0	-	5.3
$R U 2$	AU2	0001	Torque boost setting macro function	-	-	0	-	5.4

• Basic parameters

Title	Communication No.	Function	Unit	Minimum setting unit Panel/Communication	Adjustment range	Default setting	User setting	Reference
$C M O D$	CMOD	0003	Command mode selection	-	-	1	-	3 5.5 7.3
$F M O D$	FMOD	0004	Frequency setting mode selection *1	-	-	2	-	3 5.5 6.5.1 7.3

*1: When frequency setting by an extension panel option, $F M O D$ is set to 1 or 2.

Title	Communication No.	Function	Unit	Minimum setting unit Panel/Communication	Adjustment range	Default setting	User setting	Reference	
$F\dot{A}5L$	FMSL	0005	Meter selection	-	-	0: Output frequency 1: Output current 2: Frequency command value 3: Input voltage (DC detection) 4: Output voltage (command value) 5 to 11: - 12: Stator frequency 13: VI input value 14: - 15: Fixed output 1 (output current 100% equivalent) 16: Fixed output 2 (output current 50% equivalent) 17: Fixed output 3 (Other than the output current) 18: RS485 communication data 19: For adjustments ($F\dot{A}$ set value is displayed.) 20 to 22: -	0		3.4
$F\dot{A}$	FM	0006	Meter adjustment gain	-	-	-	-		
F_r	FR	0008	Forward/reverse run selection (Panel keypad)	-	-	0: Forward run 1: Reverse run 2: Forward run (F/R switching on extension panel) 3: Reverse run (F/R switching on extension panel)	0		5.7
$R\dot{E}L$	ACC	0009	Acceleration time 1	S	0.1/0.1	0.0-3000	10.0		5.3
$d\dot{E}L$	DEC	0010	Deceleration time 1	S	0.1/0.1	0.0-3000	10.0		
$F\dot{H}$	FH	0011	Maximum frequency	Hz	0.1/0.01	30.0-400.0	*2		5.8
$\dot{U}L$	UL	0012	Upper limit frequency	Hz	0.1/0.01	0.5- $F\dot{H}$	*2		5.9
$\dot{L}L$	LL	0013	Lower limit frequency	Hz	0.1/0.01	0.0- $\dot{U}L$	0.0		
$\omega\dot{L}$	VL	0014	Base frequency 1	Hz	0.1/0.01	20.0-400.0	*2		5.10
$\omega\dot{L}\omega$	VLV	0409	Base frequency voltage 1	V	1/0.1	50-330	*2		5.10 6.12,5
$P\dot{E}$	PT	0015	V/F control mode selection	-	-	0: V/F constant 1: Variable torque 2: Automatic torque boost control 3: Vector control 4: Energy-saving	0		5.11
$\omega\dot{b}$	VB	0016	Torque boost value 1	%	0.1/0.1	0.0-30.0	* 3		5.12
$\dot{t}Hr$	THR	0600	Motor electronic-thermal protection level 1	% (A)	1/1	10-100	100		3.5 6.16.1

*2: Default setting values vary depending on the setup menu setting. Refer to section 11.5.

*3: Default setting values vary depending on the capacity. Refer to section 11.4.

Title	Communication No.	Function	Unit	Minimum setting unit Panel/Communication	Adjustment range	Default setting	User setting	Reference		
OLP	OLM	0017	Electronic-thermal protection characteristic selection	-	-	Setting	Overload protection	OL stat	0	3.5
						0	valid	invalid		
						1	valid	valid		
						2	invalid	invalid		
						3	invalid	valid		
						4	valid	invalid		
						5	valid	valid		
						6	invalid	invalid		
7	invalid	valid								
SR1	SR1	0018	Preset-speed frequency 1	Hz	0.1/0.01	LL-UU	0.0	3.6		
SR2	SR2	0019	Preset-speed frequency 2	Hz	0.1/0.01	LL-UU	0.0			
SR3	SR3	0020	Preset-speed frequency 3	Hz	0.1/0.01	LL-UU	0.0			
SR4	SR4	0021	Preset-speed frequency 4	Hz	0.1/0.01	LL-UU	0.0			
SR5	SR5	0022	Preset-speed frequency 5	Hz	0.1/0.01	LL-UU	0.0			
SR6	SR6	0023	Preset-speed frequency 6	Hz	0.1/0.01	LL-UU	0.0			
SR7	SR7	0024	Preset-speed frequency 7	Hz	0.1/0.01	LL-UU	0.0			
TYP	TYP	0007	Default setting	-	-	0:- 1: 50Hz default setting 2: 60Hz default setting 3: Default setting 1 (Initialization) 4: Trip record clear 5: Cumulative operation time clear 6: Initialization of type information 7: Save user setting parameters 8: Load user setting parameters 9: Cumulative fan operation time record clears 10 to 12: - 13: Default setting 2 (Complete initialization)	0	4.3 4.3.2		
SET	SET	0099	Checking the region setting	-	-	0: Start setup menu 1: Japan (read only) 2: North America (read only) 3: Asia (read only) 4: Europe (read only)	* 2 * 6	4.4		
PSEL	PSEL	0050	EASY key mode selection	-	-	0: Standard setting mode at power on 1: Easy setting mode at power on 2: Easy setting mode only	0	4.5		
F1--	F1--	-	Extended parameter starting at 100	-	-	-	-	4.2.2		
F2--	F2--	-	Extended parameter starting at 200	-	-	-	-			
F3--	F3--	-	Extended parameter starting at 300	-	-	-	-			
F4--	F4--	-	Extended parameter starting at 400	-	-	-	-			
F5--	F5--	-	Extended parameter starting at 500	-	-	-	-			
F6--	F6--	-	Extended parameter starting at 600	-	-	-	-			
F7--	F7--	-	Extended parameter starting at 700	-	-	-	-			
F8--	F8--	-	Extended parameter starting at 800	-	-	-	-			
GRU	GRU	-	Automatic edit function	-	-	-	-	4.3.1		

*2: Default setting values vary depending on the setup menu setting. Refer to section 11.5.

*6: The region is set to 1 to 4 when parameter SET is read. To re-select a region, set "0" to start up the setup menu.

11.3 Extended parameters

• Input/output parameters 1

Title	Communication No.	Function	Unit	Minimum setting unit Panel/Communication	Adjustment range	Default setting	User setting	Reference
F 100	F100	0100	Low-speed signal output frequency	Hz	0.1/0.01	0.0-FH	0.0	6.1.1
F 101	F101	0101	Speed reach setting frequency	Hz	0.1/0.01	0.0-FH	0.0	6.1.3
F 102	F102	0102	Speed reach detection band	Hz	0.1/0.01	0.0-FH	2.5	6.1.2 6.1.3
F 105	F105	0105	Priority selection (Both F and R are ON)	-	-	0: Reverse 1: Slowdown Stop	1	6.2.1
F 108	F108	0108	Always active function selection 1	-	-	0-7, 10-123 *7 7, 8: -	0 (No function)	6.3.2
F 109	F109	0109	Analog/logic input Selection (VI terminal)	-	-	0: Voltage signal input (0-10V) 1: Current signal input (4-20mA) 2: Logic input 3: Voltage signal input (0-5V)	0	6.2.2 6.3.3 6.5.2 7.2.1 7.3
F 110	F110	0110	Always active function selection 2	-	-	0-7, 10-123 *7 7, 8: -	6 (ST)	6.3.2
F 111	F111	0111	Input terminal selection 1A (F)	-	-	0-201 *7	2 (F)	6.3.3 6.5.1
F 112	F112	0112	Input terminal selection 2A (R)	-	-		4 (R)	7.2.1
F 113	F113	0113	Input terminal selection 3A (S1)	-	-		10 (SS1)	
F 114	F114	0114	Input terminal selection 4A (S2)	-	-		12 (SS2)	
F 115	F115	0115	Input terminal selection 5 (VI)	-	-	8-55 *7	14 (SS3)	
F 127	F127	0127	Sink/source switching	-	-	0: Sink (Internal power supply), 100: Source, 200: Sink (External power supply) 1-99, 101-199, 201-255: invalid	*2	6.3.1
F 130	F130	0130	Output terminal selection 1A (OUT)	-	-	0-255 *8	4 (LOW)	6.3.4 7.2.2
F 132	F132	0132	Output terminal selection 2 (FL)	-	-		10 (FL)	
F 137	F137	0137	Output terminal selection 1B (OUT)	-	-		255 (always ON)	
F 139	F139	0139	Output terminal logic selection (OUT)	-	-	0: F 130 and F 137 1: F 130 or F 137	0	6.3.4 7.2.2
F 144	F144	0144	Factory specific coefficient 1A	-	-	-	-	*4

*2: Default setting values vary depending on the setup menu setting. Refer to section 11.5.

*4: Factory specific coefficient parameters are manufacturer setting parameters. Do not change the value of these parameters.

*7: Refer to section 11.6 for details about input terminal function.

*8: Refer to section 11.7 for details about output terminal function.

Title	Communication No.	Function	Unit	Minimum setting unit Panel/Communication	Adjustment range	Default setting	User setting	Reference
F 151	F151	0151	Input terminal selection 1B (F)	-	-	0-201 *7	0	6.3.3 6.5.1 7.2.1
F 152	F152	0152	Input terminal selection 2B (R)	-	-		0	
F 153	F153	0153	Input terminal selection 3B (S1)	-	-		0	
F 154	F154	0154	Input terminal selection 4B (S2)	-	-		0	
F 155	F155	0155	Input terminal selection 1C (F)	-	-		0	
F 156	F156	0156	Input terminal selection 2C (R)	-	-		0	

• Basic parameter 2

Title	Communication No.	Function	Unit	Minimum setting unit Panel/Communication	Adjustment range	Default setting	User setting	Reference
F 170	F170	0170	Base frequency 2	Hz	0.1/0.01	20.0-400.0	*2	6.4.1
F 171	F171	0171	Base frequency voltage 2	V	1/0.1	50-330	*2	
F 172	F172	0172	Torque boost value 2	%	0.1/0.1	0.0-30.0	*3	
F 173	F173	0173	Motor electronic-thermal protection level 2	% (A)	1/1	10-100	100	3.5 6.4.1 6.16.1
F 185	F185	0185	Stall prevention level 2	% (A)	1/1	10-199, 200 (disabled)	150	6.4.1 6.19.2

• Frequency parameters

Title	Communication No.	Function	Unit	Minimum setting unit Panel/Communication	Adjustment range	Default setting	User setting	Reference
F 201	F201	0201	VI input point 1 setting	%	1/1	0-100	0	6.5.2 7.3
F 202	F202	0202	VI input point 1 frequency	Hz	0.1/0.01	0.0-400.0	0.0	
F 203	F203	0203	VI input point 2 setting	%	1/1	0-100	100	6.6.1
F 204	F204	0204	VI input point 2 frequency	Hz	0.1/0.01	0.0-400.0	*2	
F 209	F209	0209	Analog input filter	ms	1/1	4-1000	64	
F 240	F240	0240	Starting frequency	Hz	0.1/0.01	0.1-10.0	0.5	
F 241	F241	0241	Operation starting frequency	Hz	0.1/0.01	0.0-FH	0.0	
F 242	F242	0242	Operation starting frequency hysteresis	Hz	0.1/0.01	0.0-FH	0.0	
F 249	F249	0249	Factory specific coefficient 2A	-	-	-	-	*4

*2: Default setting values vary depending on the setup menu setting. Refer to section 11.5.

*3: Default setting values vary depending on the capacity. Refer to section 11.4.

*4: Factory specific coefficient parameters are manufacturer setting parameters. Do not change the value of these parameters.

*7: Refer to section 11.6 for details about input terminal function.

Title	Communication No.	Function	Unit	Minimum setting unit Panel/Communication	Adjustment range	Default setting	User setting	Reference
F250	F250	0250	DC braking starting frequency	Hz	0.1/0.01	0.0-FH	0.0	6.7
F251	F251	0251	DC braking current	%(A)	1/1	0-100	50	
F252	F252	0252	DC braking time	s	0.1/0.1	0.0-25.5	1.0	
F256	F256	0256	Time limit for lower-limit frequency operation	s	0.1/0.1	0: Disabled 0.1-600.0	0.0	6.8
F264	F264	0264	External logic input - UP response time	s	0.1/0.1	0.0-10.0	0.1	6.5.3
F265	F265	0265	External logic input - UP frequency steps	Hz	0.1/0.01	0.0-FH	0.1	
F266	F266	0266	External logic input - DOWN response time	s	0.1/0.1	0.0-10.0	0.1	
F267	F267	0267	External logic input - DOWN frequency steps	Hz	0.1/0.01	0.0-FH	0.1	
F268	F268	0268	Initial value of UP/DOWN frequency	Hz	0.1/0.01	LL-UL	0.0	
F269	F269	0269	Change of the initial value of UP/DOWN frequency	-	-	0: Not changed 1: Setting of F268 changed when power is turned off	1	
F270	F270	0270	Jump frequency	Hz	0.1/0.01	0.0-FH	0.0	
F271	F271	0271	Jumping width	Hz	0.1/0.01	0.0-30.0	0.0	
F287	F287	0287	Preset-speed frequency 8	Hz	0.1/0.01	LL-UL	0.0	3.6 6.10
F288	F288	0288	Preset-speed frequency 9	Hz	0.1/0.01	LL-UL	0.0	
F289	F289	0289	Preset-speed frequency 10	Hz	0.1/0.01	LL-UL	0.0	
F290	F290	0290	Preset-speed frequency 11	Hz	0.1/0.01	LL-UL	0.0	
F291	F291	0291	Preset-speed frequency 12	Hz	0.1/0.01	LL-UL	0.0	
F292	F292	0292	Preset-speed frequency 13	Hz	0.1/0.01	LL-UL	0.0	
F293	F293	0293	Preset-speed frequency 14	Hz	0.1/0.01	LL-UL	0.0	
F294	F294	0294	Preset-speed frequency 15	Hz	0.1/0.01	LL-UL	0.0	

• Operation mode parameters

Title	Communication No.	Function	Unit	Minimum setting unit Panel/Com munication	Adjustment range	Default setting	User setting	Reference
F300	F300	0300	PWM carrier frequency	kHz	1/0.1	2-16	12	6.11
F301	F301	0301	Auto-restart control selection	-	-	0: Disabled 1: At auto-restart after momentary stop 2: At ST terminal off and on 3: 1+2 4: At start-up	0	6.12.1
F302	F302	0302	Regenerative power ride-through control (Deceleration stop)	-	-	0: Disabled 1: Regenerative power ride-through control 2: Deceleration stop during power failure	0	6.12.2
F303	F303	0303	Retry selection (number of times)	Times	1/1	0: Disabled 1-10	0	6.12.3
F305	F305	0305	Overvoltage limit operation (Slowdown stop mode selection)	-	-	0: Enabled 1: Disabled 2: Enabled (Quick deceleration control) 3: Enabled (Dynamic quick deceleration control)	2	6.12.4
F307	F307	0307	Supply voltage correction (output voltage limitation)	-	-	0: Supply voltage uncorrected, output voltage limited 1: Supply voltage corrected, output voltage limited 2: Supply voltage uncorrected, output voltage unlimited 3: Supply voltage corrected, output voltage unlimited	* 2	6.12.5
F311	F311	0311	Reverse-run prohibition	-	-	0: Forward/reverse run permitted 1: Reverse run prohibited 2: Forward run prohibited	0	6.12.6
F312	F312	0312	Random mode	-	-	0: Disabled 1: Automatic setting	0	6.11
F315	F315	0315	Factory specific coefficient 3A	-	-	-	-	* 4
F316	F316	0316	Carrier frequency control mode selection	-	-	0: Carrier frequency without reduction 1: Carrier frequency with automatic reduction	1	6.11
F359	F359	0359	PID control waiting time	s	1/1	0-2400	0	6.13
F360	F360	0360	PID control	-	-	0: Disabled, 1: Enabled	0	
F362	F362	0362	Proportional gain	-	0.01/0.01	0.01-100.0	0.30	
F363	F363	0363	Integral gain	-	0.01/0.01	0.01-100.0	0.20	
F366	F366	0366	Differential gain	-	0.01/0.01	0.00-2.55	0.00	
F380	F380	0380	PID forward/reverse characteristics selection	-	-	0: Forward 1: Reverse	0	
F391	F391	0391	Hysteresis for lower-limit frequency operation	Hz	0.1/0.01	0.0-LL	0.2	6.8.1

*2: Default setting values vary depending on the setup menu setting. Refer to section 11.5.

*4: Factory specific coefficient parameters are manufacturer setting parameters. Do not change the value of these parameters.

• Torque boost parameters 1

Title	Communication No.	Function	Unit	Minimum setting unit Panel/Communication	Adjustment range	Default setting	User setting	Reference
F400	F400	0400	Auto-tuning	-	-	0: Auto-tuning disabled	0	6.14
						1: Initialization of F402 (reset to 0)		
						2: Auto-tuning executed (after execution: 0)		
F401	F401	0401	Slip frequency gain	%	1/1	0-250	50	
F402	F402	0402	Automatic torque boost value	%	0.1/0.1	0.1-30.0	*3	
F405	F405	0405	Motor rated capacity	kW	0.01/0.01	0.01-5.50	*3	
F412	F412	0412	Motor specific coefficient 1	-	-	-	-	*5
F415	F415	0415	Motor rated current	A	0.1/0.1	0.1-30.0	*3	6.14
F416	F416	0416	Motor no-load current	%	1/1	10-90	*3	
F417	F417	0417	Motor rated speed	min-1	1/1	100-32000	*3	
F457	F457	0457	Motor specific coefficient 11	-	-	-	-	*5
F458	F458	0458	Motor specific coefficient 2	-	-	-	-	*5
F459	F459	0459	Load inertia moment ratio	Times	0.1/0.1	0.1-100.0	1.5	6.14
F460	F460	0460	Motor specific coefficient 3	-	-	-	-	*5
F461	F461	0461	Motor specific coefficient 4	-	-	-	-	
F462	F462	0462	Motor specific coefficient 5	-	-	-	-	
F467	F467	0467	Motor specific coefficient 6	-	-	-	-	

• Input/output parameters 2

Title	Communication No.	Function	Unit	Minimum setting unit Panel/Communication	Adjustment range	Default setting	User setting	Reference
F470	F470	0470	VI input bias	-	1/1	0-255	128	6.5.4
F471	F471	0471	VI input gain	-	1/1	0-255	128	

• Torque boost parameters 2

Title	Communication No.	Function	Unit	Minimum setting unit Panel/Communication	Adjustment range	Default setting	User setting	Reference
F480	F480	0480	Motor specific coefficient 7	-	-	-	-	*5
F485	F485	0485	Motor specific coefficient 8	-	-	-	-	
F491	F491	0491	Motor specific coefficient 10	-	-	-	-	
F495	F495	0495	Motor specific coefficient 9	-	-	-	-	

*2: Default setting values vary depending on the setup menu setting. Refer to section 11.5.

*3: Default setting values vary depending on the capacity. Refer to section 11.4.

*5: Motor specific coefficient parameters are manufacturer setting parameters. Do not change the value of these parameters.

• Acceleration/deceleration time parameters

Title	Communication No.	Function	Unit	Minimum setting unit Panel/Communication	Adjustment range	Default setting	User setting	Reference
F500	F500	0500	Acceleration time 2	s	0.1/0.1	0.0-3000	10.0	6.15
F501	F501	0501	Deceleration time 2	s	0.1/0.1	0.0-3000	10.0	
F502	F502	0502	Acceleration/deceleration 1 pattern	-	-	0: Linear 1: S-pattern 1 2: S-pattern 2	0	
F503	F503	0503	Acceleration/deceleration 2 pattern	-	-		0	
F505	F505	0505	Acceleration/deceleration 1 & 2 switching frequency	Hz	0.1/0.01	0.0 (disabled) 0.1-100	0.0	

• Protection parameters

Title	Communication No.	Function	Unit	Minimum setting unit Panel/Communication	Adjustment range	Default setting	User setting	Reference
F601	F601	0601	Stall prevention level 1	% (A)	1/1	10-199, 200 (disabled)	150	6.16.2
F602	F602	0602	Inverter trip retention selection	-	-	0: Cleared with power off 1: Retained with power off	0	6.16.3
F603	F603	0603	Emergency stop selection	-	-	0: Coast stop 1: Slowdown stop 2: Emergency DC braking	0	6.16.4
F605	F605	0605	Output phase failure detection selection	-	-	0: Disabled 1: At start-up (only one time after power on) 2: At start-up (each time)	0	6.16.5
F607	F607	0607	Motor 150% overload detection time	s	1/1	10-2400	300	3.5 6.16.1
F608	F608	0608	Input phase failure detection selection	-	-	0: Disabled, 1: Enabled	1	6.16.6

Title	Communication No.	Function	Unit	Minimum setting unit Panel/Communication	Adjustment range	Default setting	User setting	Reference
F609	F609	0609	Small current detection hysteresis	%	1/1	1-20	10	6.16.7
F610	F610	0610	Small current trip/alarm selection	-	-	0: Alarm only 1: Tripping	0	
F611	F611	0611	Small current detection current	% (A)	1/1	0-150	0	
F612	F612	0612	Small current detection time	s	1/1	0-255	0	
F613	F613	0613	Detection of output short-circuit at start-up	-	-	0: Each time (standard pulse) 1: Only one time after power on (standard pulse) 2: Each time (short pulse) 3: Only one time after power on (short pulse)	0	6.16.8
F615	F615	0615	Over-torque trip/alarm selection	-	-	0: Alarm only 1: Tripping	0	6.16.9
F616	F616	0616	Over-torque detection level	%	1/1	0 (disabled) 1-200	150	
F618	F618	0618	Over-torque detection time	s	0.1/0.1	0.0-10.0	0.5	
F619	F619	0619	Over-torque detection hysteresis	%	1/0.01	0-100	10	
F620	F620	0620	Cooling fan ON/OFF control	-	-	0: ON/OFF control 1: Always ON	0	6.16.10
F621	F621	0621	Cumulative operation time alarm setting	100 hours	0.1/0.1 (=10 hours)	0.0-999.0	610.0	6.16.11
F627	F627	0627	Undervoltage trip/alarm selection	-	-	0: Alarm only (detection level 64% or less) 1: Tripping (detection level 64% or less) 2: Alarm only (detection level 50% or less, input AC or DC reactor required)	0	6.16.12
F631	F631	0631	Factory specific coefficient 6A	-	-	-	-	* 4
F632	F632	0632	Electronic-thermal memory	-	-	0: Disabled 1: Enabled	0	3.5 6.16.1
F633	F633	0633	VI analog input break detection level	%	1/1	0: Disabled, 1-100	0	6.16.13
F634	F634	0634	Annual average ambient temperature (parts replacement alarms)	-	-	1: -10 to +10°C 2: 11-20°C 3: 21-30°C 4: 31-40°C 5: 41-50°C 6: 51-60°C	3	6.16.14

*4: Factory specific coefficient parameters are manufacturer setting parameters. Do not change the value of these parameters.

• Output parameters

Title	Communication No.	Function	Unit	Minimum setting unit Panel/Com munication	Adjustment range	Default setting	User setting	Reference
F669	F669	0669	Logic output/pulse train output selection (OUT)	-	-	0: Logic output 1: Pulse train output	0	6.17.1
F676	F676	0676	Pulse train output function selection (OUT)	-	-	0: Output frequency 1: Output current 2: Frequency command value 3: Input voltage (DC detection) 4: Output voltage (command value) 5 to 11: - 12: Stator frequency 13: VI input value 14: - 15: Fixed output 1 (output current 100% equivalent) 16: Fixed output 2 (output current 50% equivalent) 17: Fixed output 3 (Other than the output current) 18: RS485 Communication data 19 to 22: -	0	
F677	F677	0677	Maximum numbers of pulse train	kpps	0.01/0.01	0.50-1.60	0.80	
F678	F678	0678	Factory specific coefficient 6B	-	-	-	-	*4
F681	F681	0681	Analog output signal selection	-	-	0: Meter option (0 to 1 mA) 1: Current (0 to 20 mA) output 2: Voltage (0 to 10 V) output	0	6.17.2
F684	F684	0684	Factory specific coefficient 6C	-	-	-	-	*4
F691	F691	0691	Inclination characteristic of analog output	-	-	0: Negative inclination (downward slope) 1: Positive inclination (upward slope)	1	6.17.2
F692	F692	0692	Analog output bias	%	0.1/0.1	-1.0--+100.0	0	
F693	F693	0693	Factory specific coefficient 6D	-	-	-	-	*4

• Operation panel parameters

Title	Communication No.	Function	Unit	Minimum setting unit Panel/Com munication	Adjustment range	Default setting	User setting	Reference
F700	F669	0700	Parameter write protection selection	-	-	0: Permitted 1: Prohibited (Panel and extension panel) 2: Prohibited (1 + RS485 communication)	0	6.18.1
F701	F676	0701	Current/voltage unit selection	-	-	0: % 1: A (ampere)/V (volt)	0	6.18.2
F702	F677	0702	Free unit display scale	Times	0.01/0.01	0.00: Disabled (display of frequency) 0.01-200.0	0.00	6.18.3
F707	F707	0707	Free step (1-step rotation of setting dial)	Hz	0.01/0.01	0.00: Automatic 0.01-FH	0.00	6.18.4

*4: Factory specific coefficient parameters are manufacturer setting parameters. Do not change the value of these parameters.

Title		Communication No.	Function	Unit	Minimum setting unit Panel/Communication	Adjustment range	Default setting	User setting	Reference
F710	F710	0710	Initial panel display selection	-	-	0: Output frequency (Hz/free unit) 1: Output current (%A) 2: Frequency command value (Hz/free unit) 3 to 17: - 18: Arbitrary code from communication 19 to 51: - 52: Frequency command value / output frequency (Hz/free unit)	0		6.18.5 8.2.1 8.3.2
F711	F711	0711	Status monitor 1	-	-	0: Output frequency (Hz/free unit) 1: Output current (%A) 2: Frequency command value (Hz/free unit)	2		8.2.1 8.3.2
F712	F712	0712	Status monitor 2	-	-	3: Input voltage (DC detection) (%V) 4: Output voltage (command value) (%V) 5: Input power (kW) 6: Output power (kW) 7: Torque (%) 8: Torque current (%A) 9 to 11: - 12: Stator frequency (Hz/free unit) 13 to 22: - 23: PID feedback value (Hz/free unit) 24 to 26: - 27: Drive load factor (%) 28 to 51: - 52: Frequency command value / output frequency (Hz/free unit)	1		
F713	F713	0713	Status monitor 3	-	-		3		
F714	F714	0714	Status monitor 4	-	-		4		
F715	F715	0715	Status monitor 5	-	-		27		
F716	F716	0716	Status monitor 6	-	-		0		
F719	F719	0719	Selection of operation command clear	-	-	0: Clear at coast stop and retained at $\overline{R} \overline{D} \overline{F}$ 1: Retained at coast stop and $\overline{R} \overline{D} \overline{F}$ 2: Clear at coast stop and $\overline{R} \overline{D} \overline{F}$	1		6.18.7
F720	F720	0720	Initial extension panel display selection	-	-	0-52 (Same as F710)	0		6.18.5 8.2.1 8.3.2
F730	F730	0730	Panel frequency setting prohibition (F.C.)	-	-	0: Permitted 1: Prohibited	0		6.18.1
F732	F732	0732	Local/remote key prohibition of extension panel	-	-	0: Permitted 1: Prohibited	1		
F733	F733	0733	Panel operation prohibition (RUN/STOP keys)	-	-	0: Permitted 1: Prohibited	0		
F734	F734	0734	Panel emergency stop operation prohibition	-	-	0: Permitted 1: Prohibited	0		
F735	F735	0735	Panel reset operation prohibition	-	-	0: Permitted 1: Prohibited	0		
F736	F736	0736	CRd / FRd change prohibition during operation	-	-	0: Permitted 1: Prohibited	1		
F738	F738	0738	Password setting (F700)	-	-	0: Password unset 1-9998	0		
F739	F739	0739	Password verification	-	-	9999: Password set	0		

Title	Communication No.	Function	Unit	Minimum setting unit Panel/Communication	Adjustment range	Default setting	User setting	Reference
F 746	F746	0746	Factory specific coefficient 7A	-	-	-	-	* 4
F 751	F751	0751	Easy setting mode parameter 1	-	-	0-999 (Set by communication number)	3	4.5
F 752	F752	0752	Easy setting mode parameter 2	-	-		4	
F 753	F753	0753	Easy setting mode parameter 3	-	-		9	
F 754	F754	0754	Easy setting mode parameter 4	-	-		10	
F 755	F755	0755	Easy setting mode parameter 5	-	-		600	
F 756	F756	0756	Easy setting mode parameter 6	-	-		6	
F 757	F757	0757	Easy setting mode parameter 7	-	-		999	
F 758	F758	0758	Easy setting mode parameter 8	-	-		999	
F 759	F759	0759	Easy setting mode parameter 9	-	-		999	
F 760	F760	0760	Easy setting mode parameter 10	-	-		999	
F 761	F761	0761	Easy setting mode parameter 11	-	-		999	
F 762	F762	0762	Easy setting mode parameter 12	-	-		999	
F 763	F763	0763	Easy setting mode parameter 13	-	-		999	
F 764	F764	0764	Easy setting mode parameter 14	-	-		999	
F 765	F765	0765	Easy setting mode parameter 15	-	-		999	
F 766	F766	0766	Easy setting mode parameter 16	-	-		999	
F 767	F767	0767	Easy setting mode parameter 17	-	-		999	
F 768	F768	0768	Easy setting mode parameter 18	-	-		999	
F 769	F769	0769	Easy setting mode parameter 19	-	-		999	
F 770	F770	0770	Easy setting mode parameter 20	-	-	999		
F 771	F771	0771	Easy setting mode parameter 21	-	-	999		
F 772	F772	0772	Easy setting mode parameter 22	-	-	999		
F 773	F773	0773	Easy setting mode parameter 23	-	-	999		
F 774	F774	0774	Easy setting mode parameter 24	-	-	50		
F 799	F799	0799	Factory specific coefficient 7B	-	-	-	-	* 4

*4: Factory specific coefficient parameters are manufacturer setting parameters. Do not change the value of these parameters.

• Communication parameters

Title	Communication No.	Function	Unit	Minimum setting unit Panel/Communication	Adjustment range	Default setting	User setting	Reference
F800	F800	0800	Baud rate	-	-	3: 9600bps 4: 19200bps 5: 38400bps	4	6.19
F801	F801	0801	Parity	-	-	0: NON (No parity) 1: EVEN (Even parity) 2: ODD (Odd parity)	1	
F802	F802	0802	Inverter number	-	1/1	0-247	0	
F803	F803	0803	Communication time-out time	s	0.1/0.1	0.0: Disabled, 0.1-100.0	0.0	
F804	F804	0804	Communication time-out action	-	-	0: Alarm only 1: Trip (Coast stop) 2: Trip (Deceleration stop)	0	
F805	F805	0805	Communication waiting time	s	0.01/0.01	0.00-2.00	0.00	
F808	F808	0808	Communication time-out detection condition	-	-	0: Valid at any time 1: Communication selection of F803 or F804 2: 1 + during operation	1	
F829	F829	0829	Selection of communication protocol	-	-	0: Toshiba inverter protocol 1: Modbus RTU protocol	0	
F870	F870	0870	Block write data 1	-	-	0: No selection 1: Command information 2: -	0	
F871	F871	0871	Block write data 2	-	-	3: Frequency command value 4: Output data on the terminal board 5: Analog output for communication	0	
F875	F875	0875	Block read data 1	-	-	0: No selection 1: Status information	0	
F876	F876	0876	Block read data 2	-	-	2: Output frequency 3: Output current	0	
F877	F877	0877	Block read data 3	-	-	4: Output voltage 5: Alarm information	0	
F878	F878	0878	Block read data 4	-	-	6: PID feedback value 7: Input terminal board monitor	0	
F879	F879	0879	Block read data 5	-	-	8: Output terminal board monitor 9: VI terminal board monitor	0	
F880	F880	0880	Free notes	-	1/1	0-65535	0	6.20

11.4 Default settings by inverter rating

Inverter type	Torque boost value	Automatic torque boost value	Motor rated capacity	Motor rated current	Motor no-load current	Motor rated speed	
	$\omega b / F 172$ (%)	$F 402$ (%)	$F 405$ (kW)	$F 415$ (A)	$F 416$ (%)	$F 417$ (JP,USA) (min ⁻¹)	$F 417$ (ASIA,EU) (min ⁻¹)
VFNC3-2001P	6.0	10.3	0.10	0.6	75	1710	1410
VFNC3-2002P	6.0	8.3	0.20	1.2	70	1710	1410
VFNC3-2004P	6.0	6.2	0.40	2.0	65	1710	1410
VFNC3-2007P	4.8	4.3	0.75	3.4	55	1730	1440
VFNC3-2015P	4.8	4.4	1.50	6.4	42	1740	1445
VFNC3-2022P	3.1	2.9	2.20	9.4	50	1755	1460
VFNC3-2037P	3.1	2.8	4.00	14.6	38	1755	1460
VFNC3S-2001PL	6.0	10.3	0.10	0.6	75	1710	1410
VFNC3S-2002PL	6.0	8.3	0.20	1.2	70	1710	1410
VFNC3S-2004PL	6.0	6.2	0.40	2.0	65	1710	1410
VFNC3S-2007PL	4.8	4.3	0.75	3.4	55	1730	1440
VFNC3S-2015PL	4.8	4.4	1.50	6.4	42	1740	1445
VFNC3S-2022PL	3.1	2.9	2.20	9.4	50	1755	1460
VFNC3S-1001P	6.0	10.3	0.10	0.6	75	1710	1410
VFNC3S-1002P	6.0	8.3	0.20	1.2	70	1710	1410
VFNC3S-1004P	6.0	6.2	0.40	2.0	65	1710	1410
VFNC3S-1007P	4.8	4.3	0.75	3.4	55	1730	1440

11.5 Default settings by setup menu

Setting	Main regions	Max. frequency	Frequency	Base frequency voltage 1 & 2	Sink/source switching	Supply voltage correction (output voltage limitation)	Motor rated speed
		$F 1$ (Hz)	$\omega L \omega L$, $F 170$, $F 204$ (Hz)	$\omega L \omega$, $F 171$ (V)	$F 127$	$F 307$	$F 417$ (min ⁻¹)
ωP	Japan	80.0	60.0	200	0 (Sink)	3	Refer to section 11.4
$\omega S R$	North America	60.0	60.0	230	0 (Sink)	2	
$R S 1 R$	Asia	50.0	50.0	230	0 (Sink)	2	
$E U$	Europe	50.0	50.0	230	100 (Source)	2	

11.6 Input Terminal Function

It can be assigned the function No. in the following table to parameter $F100$, $F110$ to $F115$, $F151$ to $F156$.

Refer to the following table for the action condition of each function No. (valid / invalid of input terminal function when input from terminal block).

- a: Always active (independent of $EN0d$)
- b: Valid when $EN0d$ (command mode selection) = 0 (terminal board)

• Table of input terminal functions 1

Function No.	Code	Function	Action	Action condition	Reference
0,1	-	No function	Disabled	-	-
2	F	Forward run command	ON: Forward run, OFF: Slowdown stop	b	3.2.1
3	FN	Inversion of forward run command	Inversion of F		7.2.1
4	R	Reverse run command	ON: Reverse run, OFF: Slowdown stop	b	3.2.1
5	RN	Inversion of reverse run command	Inversion of R		7.2.1
6	ST	Standby	ON: Ready for operation OFF: Coast stop (gate OFF)	a	3.2.1
7	STN	Inversion of standby	Inversion of ST		
8	RES	Reset command	ON: Acceptance of reset command ON → OFF: Trip reset	a	13.2
9	RESN	Inversion of reset command	Inversion of RES		
10	SS1	Preset-speed command 1	Selection of 15-speed SS1 to SS4 (SS1N to SS4N) (4 bits)	b	3.6 7.2.1
11	SS1N	Inversion of preset-speed command 1			
12	SS2	Preset-speed command 2			
13	SS2N	Inversion of preset-speed command 2			
14	SS3	Preset-speed command 3			
15	SS3N	Inversion of preset-speed command 3			
16	SS4	Preset-speed command 4			
17	SS4N	Inversion of preset-speed command 4			3.6
18	JOG	Jog run mode	ON: Jogging mode (fixed at 5Hz) OFF: Jog run canceled	b	7.2.1
19	JOGN	Inversion of jog run mode	Inversion of JOG		
20	EXT	Emergency stop by external signal	ON: \bar{E} trip stop OFF: After stopped by $F603$, E trip	a	6.16.4
21	EXTN	Inversion of emergency stop by external signal	Inversion of EXT		
22	DB	DC braking command	ON: DC braking, OFF: Brake canceled	b	6.7.1
23	DBN	Inversion of DC braking command	Inversion of DB		
24	AD2	2nd acceleration/deceleration	ON: Acceleration/deceleration 2 OFF: Acceleration/deceleration 1	b	6.4.1 6.15.1
25	AD2N	Inversion of 2nd acceleration/deceleration	Inversion of AD2		
28	VF2	2nd V/F control mode switching	ON: 2nd V/F control mode (V/F fixed $F170$, $F171$, $F172$, $F173$) OFF: 1st V/F control mode ($P\bar{t}$ setting, $\omega\bar{L}$, $\omega\bar{L}\omega$, $\omega\bar{b}$, $\bar{t}Hr$)	b	6.4.1
29	VF2N	Inversion of 2nd V/F control switching	Inversion of VF2		
32	OCS2	2nd stall prevention level	ON: Enabled at the value of $F185$ OFF: Enabled at the value of $F601$	b	6.4.1 6.16.2
33	OCS2N	Inversion of 2nd stall prevention level	Inversion of OCS2		
36	PID	PID control prohibition	ON: PID control prohibited OFF: PID control enabled	a	6.13
37	PIDN	Inversion of PID control prohibition	Inversion of PID		

• Table of input terminal functions 2

Function No.	Code	Function	Action	Action condition	Reference
48	SCLC	Forced local from communication	Enabled during communication ON: Local (Setting of f_{n0d} , F_{n0d}) OFF: Communication	a	5.5 6.19
49	SCLCN	Inversion of forced local from communication	Inversion of SCLC		
50	HD	Operation hold (hold of 3-wire operation)	ON: F (forward run), R: (reverse run) held, 3-wire operation OFF: Slowdown stop	a	7.2.1
51	HDN	Inversion of operation hold (hold of 3-wire operation)	Inversion of HD		
52	IDC	PID integral/differential clear	ON: Integral/differential clear, OFF: Clear canceled	a	6.13
53	IDCN	Inversion of PID integral/differential clear	Inversion of IDC		
54	PIDSW	PID characteristics switching	ON: Inverted characteristics of F_{300} selection OFF: Characteristics of F_{300} selection		
55	PIDSWN	Inversion of PID characteristics switching	Inversion of PIDSW		
88	UP	Frequency UP	ON: Frequency increased OFF: Frequency increase canceled	a	6.5.3
89	UPN	Inversion of frequency UP	Inversion of UP		
90	DWN	Frequency DOWN	ON: Frequency decreased OFF: Frequency decrease canceled		
91	DWNN	Inversion of frequency DOWN	Inversion of DWN		
92	CLR	Clear frequency UP/DOWN	OFF → ON: Clear frequency UP/DOWN		
93	CLRn	Inversion of clear frequency UP/DOWN	Inversion of CLR		
96	FRR	Coast stop command	ON: Coast stop (Gate OFF) OFF: Coast stop canceled	a	3.2.1
97	FRRN	Inversion of coast stop command	Inversion of FRR		
106	FMTB	Frequency setting mode terminal board VI	ON: Terminal board (VI) enabled OFF: Setting of f_{n0d}	a	5.5
107	FMTBN	Inversion of frequency setting mode terminal board VI	Inversion of FMTB		
108	CMTB	Command mode terminal board	ON: Terminal board enabled OFF: Setting of f_{n0d}		
109	CMTBN	Inversion of command mode terminal board	Inversion of CMTB		
110	PWE	Parameter editing permission	ON: Parameter editing permitted OFF: Setting of f_{n0d}	a	6.18.1
111	PWEN	Inversion of parameter editing permission	Inversion of PWE		
122	FST	Forced deceleration command	ON: Forced deceleration command (Automatic deceleration) OFF: Forced deceleration canceled (Note that operation is resumed when forced deceleration is canceled)	b	5.3.1
123	FSTN	Inversion of forced deceleration command	Inversion of FST		
200	PWP	Parameter editing prohibition	ON: Parameter editing prohibited OFF: Setting of f_{n0d}	a	6.18.1
201	PWPN	Inversion of parameter editing prohibition	Inversion of PWP		

Note 1: Function No. 26, 27, 30, 31, 34, 35, 38 to 47, 50, 51, 56 to 87, 94, 95, 98 to 105, 112 to 121 and 124 to 199 are assigned "No function".

Note 2: Function No. are different from those on the VF-nC1. Pay attention to substitute function No. from VF-nC1 to VF-nC3. The combination function in VF-nC1 (e.g. F+SS1) can be realized by plural assignable functions (F_{15i} to F_{15j}). As a combination is not constraint, various operation is possible. Refer to section 7.2.1 for details.

• Input terminal function priority

Code	Function No.	2,3 4,5	6,7	8,9	10,11 12,13 14,15 16,17	18 19	20 21	22 23	24,25 28,29 32,33	36,37 52,53 54,55	48 49 106 107 108 109	50 51	88,89 90,91 92,93	96 97	110 111 200 201	122 123
F/ R	2,3 4,5		X	○	○	○	X	X	○	○	○	○	○	X	○	X
ST	6,7	⊙	○	○	⊙	⊙	○	⊙	○	○	○	⊙	○	○	○	⊙
RES	8,9	○	○	○	○	○	X	○	○	○	○	○	○	○	○	○
SS1/ SS2/ SS3/ SS4	10,11 12,13 14,15 16,17	○	X	○	○	X	X	X	○	○	○	○	○	X	○	X
JOG	18,19	○	X	○	⊙	○	X	X	○	⊙	○	X	○	X	○	X
EXT	20,21	⊙	○	⊙	⊙	⊙	○	⊙	○	○	○	⊙	○	○	○	⊙
DB	22,23	⊙	X	○	⊙	⊙	X	○	○	⊙	○	⊙	○	X	○	X
AD2/ VF2/ OCS2	24,25 28,29 32,33	○	○	○	○	○	○	○	○	○	○	○	○	○	○	○
PID/ IDC/ PIDSW	36,37 52,53 54,55	○	○	○	○	X	○	X	○	○	○	○	○	○	○	○
SCLC/ FMTB/ CMTB	48,49 106,107 108,109	○	○	○	○	○	○	○	○	○	○	○	○	○	○	○
HD	50,51	○	X	○	○	X	X	X	○	○	○	○	○	X	○	X
UP/ DWN/ CLR	88,89 90,91 92,93	○	○	○	○	○	○	○	○	○	○	○	○	○	○	○
FRR	96,97	⊙	○	○	⊙	⊙	○	⊙	○	○	○	⊙	○	○	○	⊙
PWE/ PWP	110,111 200,201	○	○	○	○	○	○	○	○	○	○	○	○	○	○	○
FST	122,123	⊙	X	○	⊙	⊙	X	⊙	○	○	○	⊙	○	X	○	

⊙ Priority ○ Enabled X Disabled

11.7 Output Terminal Function

• Table of output terminal functions 1

Function No.	Code	Function	Action	Reference
0	LL	Frequency lower limit	ON: Output frequency is more than $L L$ OFF: Output frequency is $L L$ or less	5.9
1	LLN	Inversion of frequency lower limit	Inversion of LL	
2	UL	Frequency upper limit	ON: Output frequency is $U L$ or more OFF: Output frequency is less than $U L$	5.9
3	ULN	Inversion of frequency upper limit	Inversion of UL	
4	LOW	Low-speed detection signal	ON: Output frequency is $F 100$ or more OFF: Output frequency is less than $F 100$	7.2.2 6.1.1
5	LOWN	Inversion of low-speed detection signal	Inversion of LOW	
6	RCH	Output frequency attainment signal (acceleration/deceleration completed)	ON: Output frequency is within command frequency $\pm F 102$ OFF: Output frequency is more than command frequency $\pm F 102$	6.1.2
7	RCHN	Inversion of output frequency attainment signal (inversion of acceleration/deceleration completed)	Inversion of RCH	
8	RCHF	Set frequency attainment signal	ON: Output frequency is within $F 101 \pm F 102$ OFF: Output frequency is more than $F 101 \pm F 102$	6.1.3
9	RCHFN	Inversion of set frequency attainment signal	Inversion of RCHF	
10	FL	Fault signal (trip output)	ON: Inverter tripped OFF: Inverter not tripped	7.2.2
11	FLN	Inversion of fault signal (inversion of trip output)	Inversion of FL	
14	POC	Over-current detection pre-alarm	ON: Output current is $F 601$ or more OFF: Output current is less than $F 601$	6.16.2
15	POCN	Inversion of over-current detection pre-alarm	Inversion of POC	
16	POL	Overload detection pre-alarm	ON: 50% or more of calculated value of overload protection level OFF: Less than 50% of calculated value of overload protection level	3.5
17	POLN	Inversion of overload detection pre-alarm	Inversion of POL	
20	POH	Overheat detection pre-alarm	ON: Approx. 95°C or more of IGBT element OFF: Less than approx. 95°C of IGBT element (90°C or less after detection is turned on)	-
21	POHN	Inversion of overheat detection pre-alarm	Inversion of POH	
22	POP	Overvoltage detection pre-alarm	ON: Overvoltage limit in operation OFF: Overvoltage detection canceled	6.12.4
23	POPEN	Inversion of overvoltage detection pre-alarm	Inversion of POP	
24	MOFF	Power circuit undervoltage detection	ON: Power circuit undervoltage (MOFF) detected OFF: Undervoltage detection canceled	6.16.12
25	MOFFN	Inversion of power circuit undervoltage detection	Inversion of MOFF	
26	UC	Small current detection	ON: After output current comes to $F 511$ or less, value of less than $F 511 + F 509$ for $F 512$ set time OFF: Output current is more than $F 511$ ($F 511 + F 509$ or more after detection turns on)	6.16.7
27	UCN	Inversion of small current detection	Inversion of UC	
28	OT	Over-torque detection	ON: After torque comes to $F 515$ or more, value of more than $F 515 - F 519$ for $F 518$ set time OFF: Torque is less than $F 515$ ($F 515 - F 519$ or less after detection turns on)	6.16.9
29	OTN	Inversion of over-torque detection	Inversion of OT	

• Table of output terminal functions 2

Function No.	Code	Function	Action	Reference
40	RUN	Run/stop	ON: While operation frequency is output or DC braking is in operation (<i>db</i>) OFF: Operation stopped	3.2.1
41	RUNN	Inversion of run/stop	Inversion of RUN	
56	COT	Cumulative operation time alarm	ON: Cumulative operation time is $F 6 2 t$ or more OFF: The cumulative operation time is less than $F 6 2 t$	6.16.11
57	COTN	Inversion of cumulative operation time alarm	Inversion of COT	
60	FR	Forward/reverse run	ON: Reverse run OFF: Forward run (Operation command state is output while motor operation is stopped. No command is to OFF.)	3.2.1
61	FRN	Inversion of forward/reverse run	Inversion of FR	
78	COME	RS485 communication error	ON: Communication error occurred OFF: Communication works	6.19
79	COMEN	Inversion of RS485 communication error	Inversion of COME	
92	DATA	Designated data output	ON: bit0 of FA50 is ON OFF: bit0 of FA50 is OFF	6.19
93	DATAN	Inversion of designated data output	Inversion of DATA	
128	LTA	Parts replacement alarm	ON: Any one of cooling fan, control board capacitor, or main circuit capacitor reaches parts replacement time OFF: Any one of cooling fan, control board capacitor, or main circuit capacitor does not reach parts replacement time	6.16.14
129	LTAN	Inversion of parts replacement alarm	Inversion of LTA	
146	FLR	Fault signal (output also at a retry waiting)	ON: While inverter is tripped or retried OFF: While inverter is not tripped and not retried	6.12.3
147	FLRN	Inversion of fault signal (output also at a retry waiting)	Inversion of FLR	
254	AOFF	Always OFF	Always OFF	7.2.2
255	AON	Always ON	Always ON	7.2.2

Note 1: As function No. 12, 13, 18, 19, 30 to 39, 42 to 55, 58, 59, 62 to 77, 80 to 91, 94 to 127, 130 to 145 and 148 to 253 are "No function", output signal is always "OFF" at even number, output signal is always "ON" at odd number.

Note 2: Function No. are different from those on the VF-nC1. Pay attention to substitute function No. from VF-nC1 to VF-nC3.

11.8 Unchangeable parameters in running

For reasons of safety, the following parameters cannot be changed during inverter running.
Change parameters while inverter stops.

[Basic parameters]

<i>RUF</i>	(Guidance function)	<i>FH</i>	(Maximum frequency)
<i>RU1</i>	(Automatic acceleration/deceleration)	<i>Pt</i>	(V/F control mode selection)
<i>RU2</i>	(Torque boost setting macro function)	<i>tYP</i>	(Default setting)
<i>CRQd*</i>	(Command mode selection)	<i>SEt</i>	(Checking the region setting)
<i>FRQd*</i>	(Frequency setting mode selection)		

[Basic parameters]

<i>F1Q5</i>	(Priority selection (Both F and R are ON))	<i>F311</i>	(Reverse-run prohibition)
<i>F1Q8 / F11Q</i>	(Always-active function selection 1/2)	<i>F316</i>	(Carrier frequency control mode selection)
<i>F1Q9</i>	Analog/logic input selection (VI terminal)	<i>F36Q</i>	(PID control)
<i>F111 to F115</i>	(Input terminal selection 1A to 5)	<i>F4QQ</i>	(Auto-tuning)
<i>F127</i>	(Sink/source switching)	<i>F458</i>	(Motor specific coefficient 2)
<i>F13Q to F137</i>	(Output terminal selection 1A~1B)	<i>F48Q to F495</i>	(Motor specific coefficient 7 to 9)
<i>F139</i>	(Output terminal logic selection(OUT-NO))	<i>F6Q3</i>	(Emergency stop selection)
<i>F144</i>	(Factory specific coefficient 1A)	<i>F6Q5</i>	(Output phase failure detection mode selection)
<i>F151 to F156</i>	(Input terminal selection 1B~2C)	<i>F6Q8</i>	(Input phase failure detection mode selection)
<i>F3Q1</i>	(Auto-restart control selection)	<i>F613</i>	(Detection of output short-circuit during start-up)
<i>F3Q2</i>	(Regenerative power ride-through control (Deceleration stop))	<i>F627</i>	(Undervoltage trip/alarm selection)
<i>F3Q5</i>	(Overvoltage limit operation (Slowdown stop mode selection))	<i>F631</i>	(Factory specific coefficient 6A)
<i>F3Q7</i>	(Supply voltage correction (limitation of output voltage))	<i>F669</i>	(Logic output/pulse train output selection (OUT-NO))
		<i>F681</i>	(Analog output signal selection)

**CRQd* and *FRQd* can be changed during operation by setting *F736=0*.

12. Specifications

12.1 Models and their standard specifications

■ Standard specifications

Item		Specification						
Input voltage class		3-phase 240V class						
Applicable motor (kW)		0.1	0.2	0.4	0.75	1.5	2.2	4.0
Rating	Type	VFNC3						
	Form	2001P	2002P	2004P	2007P	2015P	2022P	2037P
	Capacity (kVA) Note 1)	0.3	0.6	1.0	1.6	2.9	3.9	6.4
	Output current (A) Note 2)	0.7	1.4	2.4	4.2	7.5	10.0	16.7
	(A) Note 2)	(0.7)	(1.4)	(2.4)	(3.6)	(7.5)	(8.5)	(14.0)
Output voltage Note 3)		3-phase 200V to 240V						
Overload current rating		150%-60 seconds, 200%-0.5 second						
Power supply	Voltage-frequency	3-phase 200V to 240V - 50/60Hz						
	Allowable fluctuation	Voltage 170 to 264V Note 4), frequency ±5%						
	Required Power supply capacity (kVA) Note 5)	0.5	0.8	1.4	2.5	4.3	5.7	9.2
Protective method (IEC60529)		IP20						
Cooling method		Self-cooling				Forced air-cooled		
Color		RAL 3002 / 7016						
Built-in filter		-						

Item		Specification									
Input voltage class		1-phase 240V class					1-phase 120V class				
Applicable motor (kW)		0.1	0.2	0.4	0.75	1.5	2.2	0.1	0.2	0.4	0.75
Rating	Type	VFNC3S									
	Form	2001PL	2002PL	2004PL	2007PL	2015PL	2022PL	1001P	1002P	1004P	1007P
	Capacity (kVA) Note 1)	0.3	0.6	1.0	1.6	2.9	3.9	0.3	0.6	1.0	1.6
	Output current (A) Note 2)	0.7	1.4	2.4	4.2	7.5	10.0	0.7	1.4	2.4	4.2
	(A) Note 2)	(0.7)	(1.4)	(2.4)	(3.2)	(7.5)	(9.1)	(0.7)	(1.4)	(2.4)	(4.0)
Rated output voltage Note 3)		3-phase 200V to 240V					3-phase 200V to 240V				
Overload current rating		150%-60 seconds, 200%-0.5 second					150%-60 seconds, 200%-0.5 second				
Power supply	Voltage-frequency	1-phase 200V to 240V - 50/60Hz					1-phase 100V to 120V - 50/60Hz				
	Allowable fluctuation	Voltage 170 to 264V Note 4), frequency ±5%					Voltage 85 to 132V Note 4), frequency ±5%				
	Required Power supply capacity (kVA) Note 5)	0.5	0.8	1.3	2.3	4.0	5.4	0.4	0.7	1.3	2.1
Protective method (IEC60529)		IP20					IP20				
Cooling method		Self-cooling				Forced air-cooled	Self-cooling			Forced air-cooled	
Color		RAL 3002 / 7016					RAL 3002 / 7016				
Built-in filter		EMC filter					-				

Note 1. Capacity is calculated at 220V for output voltage.

Note 2. Indicates rated output current setting when the PWM carrier frequency (parameter F_{300}) is 4kHz or less. Between 5 kHz and 12 kHz, the rated output current is indicated in the (). Above 13 kHz, the output current must be reduced. The default setting of the PWM carrier frequency is 12kHz. (Refer to section 6.11)

Note 3. Maximum output voltage is the same as the input voltage. In case of 1-phase 120V class, maximum output voltage is same as twice the input voltage.

With regard to 120V models, the output voltage may decrease about 10 to 20 % if motor load is applied. When operating VFNC3 in conjunction with general-purpose motor (200V), it is necessary to reduce the motor load.

Note 4. 180V-264V (240V class), 90V-132V (120V class) when the inverter is used continuously (load of 100%).

Note 5. Required power supply capacity varies with the value of the power supply side inverter impedance (including those of the input reactor and cables).

■ Common specification

	Item	Specification
Principal control functions	Control system	Sinusoidal PWM control
	Output frequency range	0.1 to 400.0Hz, default setting: 0.5 to 60Hz, maximum frequency: 30 to 400Hz
	Minimum setting steps of frequency	Analog input: 1/1000 of the max. frequency (At 60Hz : 0.06Hz); V1 terminal (0-10V), V1 terminal (4-20mA) 1/500 of the max. frequency (At 60Hz : 0.12Hz); V1 terminal (0-5V) Operation panel setting: 0.01Hz (99.99Hz or less), 0.1Hz (100.0Hz or more) Communication setting: 0.01Hz
	Frequency accuracy	Analog setting: within $\pm 1.0\%$ of the max. frequency ($25^{\circ}\text{C} \pm 10^{\circ}\text{C}$) Digital setting: within $\pm 0.1\%$ of the max. frequency (-10 to $+60^{\circ}\text{C}$)
	Voltage/frequency characteristics	V/f constant, variable torque, automatic torque boost, vector control, automatic energy-saving, Auto-tuning, Base frequency (20-400Hz) adjusting to 1 & 2, torque boost (0-30%) adjusting to 1 & 2, adjusting frequency at start (0.1-10Hz)
	Frequency setting signal	Setting dial on the front panel, external frequency potentiometer (connectable to a potentiometer with a rated impedance of 1k-10k Ω), 0-10Vdc / 0-5Vdc (input impedance: V1=40k Ω), 4-20mA (input impedance: 250 Ω). Note 2)
	Terminal board base frequency	The characteristic can be set arbitrarily by two-point setting. Possible to set: analog input (V1).
	Frequency jump	Setting of the jump frequency and the range.
	Upper- and lower-limit frequencies	Upper-limit frequency: 0 to max. frequency, lower-limit frequency: 0 to upper-limit frequency
	PWM carrier frequency	Adjustable range of 2k to 16kHz (default: 12kHz).
Operation specifications	PID control	Setting of proportional gain, integral gain, differential gain and control waiting time.
	Acceleration/deceleration time	Selectable from among acceleration/deceleration times 1 & 2 (0.0 to 3000 sec.). Automatic acceleration/deceleration function. S-pattern acceleration/deceleration 1 & 2. Control of forced rapid deceleration.
	DC braking	Braking start-up frequency: 0 to maximum frequency, braking rate: 0 to 100%, braking time: 0 to 25.5 seconds, emergency DC braking.
	Dynamic Braking Drive Circuit	None (braking mode is optional)
	Input terminal function (programmable)	Possible to select from among about 60 functions, such as forward/reverse run signal input, jog run signal input, operation base signal input and reset signal input, to assign to 5 input terminals. Logic selectable between sink and source.
	Output terminal functions (programmable)	Possible to select from among about 40 functions, such as upper/lower limit frequency signal output, low speed detection signal output, specified speed reach signal output and failure signal output, to assign to FL relay output, open collector output terminals.
	Forward/reverse run	The RUN and STOP keys on the operation panel are used to start and stop operation, respectively. Forward/reverse run possible through communication and logic inputs from the terminal block.
	Jog run	Jog mode, if selected, allows jog operation from the terminal board.
	Preset speed operation	Frequency references + 15-speed operation possible by changing the combination of 4 contacts on the terminal board.
	Retry operation	Capable of restarting automatically after a check of the main circuit elements in case the protective function is activated. 10 times (Max.) (selectable with a parameter)
	Various prohibition settings / Password setting	Possible to write-protect parameters and to prohibit the change of panel frequency settings and the use of operation panel for operation, emergency stop or resetting. Possible to write-protect parameters by setting 4 digits password and terminal input.
	Regenerative power ride-through control	Possible to keep the motor running using its regenerative energy in case of a momentary power failure (default: OFF).
	Auto-restart operation	In the event of a momentary power failure, the inverter reads the rotational speed of the coasting motor and outputs a frequency appropriate to the rotational speed in order to restart the motor smoothly. This function can also be used when switching to commercial power.
Failure detection signal	1c- contact output Note 3) Maximum switching capacity : 250Vac-2A , 30Vdc-2A (At resistive load $\cos\Phi=1$), 250Vac-1A ($\cos\Phi=0.4$) , 30Vdc-1A (L/R=7ms) Minimum permissible load : 5Vdc-100mA, 24Vdc-5mA	

<Continued overleaf>

<Continued>

Item		Specification
Protective function	Protective function	Stall prevention, current limitation, over-current, output short circuit, over-voltage, over-voltage limitation, undervoltage, ground fault detection, input phase failure, output phase failure, overload protection by electronic thermal function, armature over-current at start-up, load side over-current at start-up, over-torque, undercurrent, overheating, cumulative operation time, life alarm, emergency stop, various pre-alarms
	Electronic thermal characteristic	Switching between standard motor and constant-torque VF motor, switching between motors 1 & 2, setting of overload trip time, adjustment of stall prevention levels 1 & 2, selection of overload stall
	Reset function	Panel reset / External signal reset / Power supply reset. This function is also used to save and clear trip records.
Display function	Alarms	Stall prevention, overvoltage, overload, under-voltage, setting error, retry in process, upper/lower limits
	Causes of failures	Over-current, overvoltage, overheat, output short-circuit, ground fault, overload on inverter, arm overcurrent at start-up, overcurrent on the load side at start-up, CPU fault, EEPROM fault, RAM fault, ROM fault, communication error. (Selectable: emergency stop, under-voltage, small current, over-torque, motor overload, input phase failure, output phase failure)
	Monitoring function	Output frequency, frequency command value, forward/reverse run, output current, input voltage (DC detection), output voltage, torque, torque current, load factor of inverter, input power, output power, information on input terminals, information on output terminals, logic input terminals setting, version of CPU1, version of CPU2, PID feedback value, frequency command (after compensation), causes of past trips 1to 4, parts replacement alarm, cumulative operation time
	Past trip monitoring function	Stores data on the past four trips: number of trips that occurred in succession, output frequency, frequency command value, forward/reverse run, output current, input voltage (DC detection), output voltage, information on input terminals, information on output terminals, and cumulative operation time when each trip occurred.
	Output for frequency meter	Analog output for meter: 1mA dc full-scale dc ammeter 0 - 20mA (4 to 20mA) output: DC ammeter (allowable load resistance: Less than 750Ω) 0 - 10V output: DC voltmeter (allowable load resistance: Over 1kΩ) Resolution: Maximum of 1/255
	4-digit 7-segments LED	Frequency: inverter output frequency. Alarm: overcurrent pre-alarm "L", overvoltage pre-alarm "P", overload pre-alarm "L", overheat pre-alarm "H", communication pre-alarm "L". Status: inverter status (frequency, cause of activation of protective function, input/output voltage, output current, etc.) and parameter settings. Free-unit display: arbitrary unit (e.g. rotating speed) corresponding to output frequency.
Indicator	Lamps indicating the inverter status by lighting, such as RUN lamp, MON lamp, PRG lamp, % lamp, Hz lamp. The charge lamp indicates that the main circuit capacitors are electrically charged.	
Environments	Location of use	Indoors: not exposed to direct sunlight, corrosive gas, explosive gas, flammable gas, oil mist, or dust; and vibration of less than 5.9m/s ² (10 to 55Hz).
	Elevation	3000 m or less (current reduction required above 1000 m) Note 3)
	Ambient temperature	-10 to +60°C Note 4)
	Storage temperature	-25 to +70°C (Temperature applicable for a short term)
	Relative humidity	5 to 95% (free from condensation and vapor).

Note 1. Be careful, if 4-20mA is selected, when the inverter's power is ON, the internal impedance is 250Ω, but when the power is OFF, the internal impedance increases very much to approximately 40kΩ.

Note 2. A chattering (momentary ON/OFF of contact) is generated by external factors of the vibration and the impact, etc. In particular, please set the filter of 10ms or more, or timer for measures when connecting it directly with input unit terminal of programmable controller. Please use the OUT terminal as much as possible when the programmable controller is connected.

Note 3. Current must be reduced by 1% for each 100 m above 1000 m. For example, 90% at 2000m and 80% at 3000m.

Note 4. Above 40°C : Remove caution label on the top of the inverter.

Above 50°C: Remove caution label on the top of the inverter and use the inverter with the output current reduced.

Side by side installation (with no space between inverters): Remove the seal from the top of each inverter. When installing the inverter where the ambient temperature will rise above 40°C, remove the seal from the top of the inverter and use the inverter with the output current reduced.

(Refer to section 6.11 for details)

12.2 Outside dimensions and mass

■ Outside dimensions and mass

Voltage class	Applicable motor (kW)	Inverter type	Dimensions (mm)							Drawing	Approx. weight (kg)	
			W	H	D	W1	H1	H2	Thickness of mounting holes			
3-phase 240V	0.1	VFNC3-2001P	72	130	102	60	131	13	2	A	0.7	
	0.2	VFNC3-2002P			121		118					
	0.4	VFNC3-2004P			131	93						
	0.75	VFNC3-2007P	105	170	141	126	157	14	8	D	1.2	
	1.5	VFNC3-2015P			156							93
	2.2	VFNC3-2022P			166							93
4.0	VFNC3-2037P	140	170	141	126	157	14	8	E	2.0		
1-phase 240V	0.1	VFNC3S-2001PL	72	130	102	60	131	13	2	A	0.7	
	0.2	VFNC3S-2002PL			121		118					
	0.4	VFNC3S-2004PL			131	93						
	0.75	VFNC3S-2007PL	105	170	141	126	157	14	8	B	0.8	
	1.5	VFNC3S-2015PL			156							93
	2.2	VFNC3S-2022PL			166							93
1-phase 120V	0.1	VFNC3S-1001P	72	130	102	60	131	13	2	A	0.7	
	0.2	VFNC3S-1002P			121		118					
	0.4	VFNC3S-1004P	105	170	141	126	157	14	8	B	0.8	
	0.75	VFNC3S-1007P			156							93

■ Outline drawing

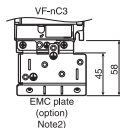
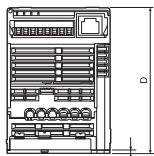
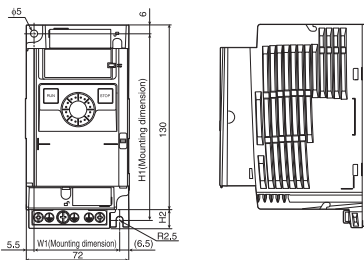

Fig.A

Note 1. To make it easier to grasp the dimensions of each inverter, dimensions common to all inverters in these figures are shown with numeric values but not with symbols.

Here are the meanings of the symbols used.

W: Width

H: Height

D: Depth

W1: Mounting dimension (horizontal)

H1: Mounting dimension (vertical)

H2: Height of EMC plate mounting area

Note 2. Here are the available EMC plate

Fig.A, B : EMP007Z (Approx. weight : 0.3kg)

Fig.C, D : EMP008Z (Approx. weight : 0.4kg)

Fig.E : EMP009Z (Approx. weight : 0.5kg)

Note 3. The models shown in Fig. A to Fig. D are fixed at two points: in the upper left and lower right corners.

Note 4. The model shown in Fig. A, B is not equipped with a cooling fan.

Note 5. Height measurements in Fig. A do not include the protuberance for installation.

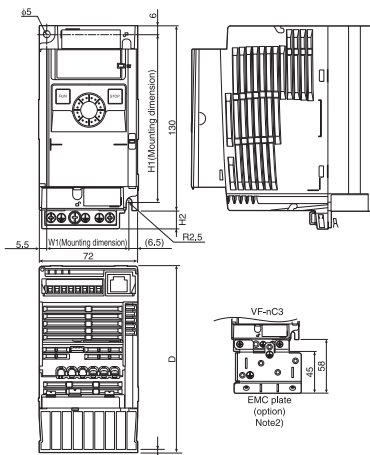

Fig.B

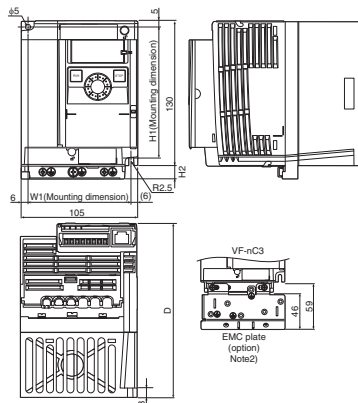

Fig.C

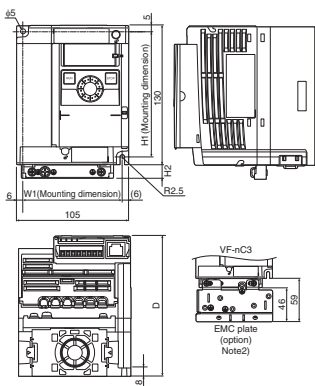

Fig.D

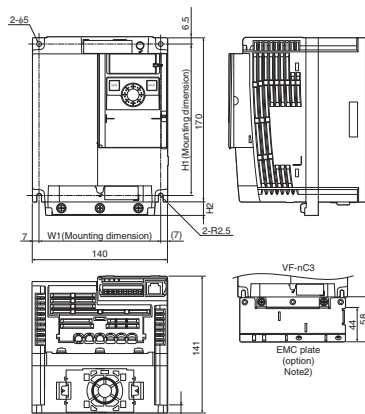

Fig.E

13. Before Contacting your Toshiba distributor

- Trip information and remedies

13.1 Trip causes/warnings and remedies

When a problem arises, diagnose it in accordance with the following table.

If it is found that replacement of parts is required or the problem cannot be solved by any remedy described in the table, contact your Toshiba distributor.

[Trip information]

Error code	Failure code	Name	Description	Remedies	
\mathcal{E}	E	0011	Emergency stop	<ul style="list-style-type: none"> During automatic operation or remote operation, an emergency stop command is entered from the operation panel or an external (terminal or communication). 	<ul style="list-style-type: none"> Reset the inverter. If the emergency stop signal is input, reset after releasing this signal.
$\mathcal{E} - 13$	E-13	0045	Over speed fault	<ul style="list-style-type: none"> The input voltage fluctuates abnormally. Over speed fault due to the overvoltage limit operation. 	<ul style="list-style-type: none"> Check the input voltage. Install an optional braking module.
* $\mathcal{E} - 18$	E-18	0032	Brea in analog signal cable	<ul style="list-style-type: none"> The input signal from VI is equal to or less than the $F 6 3 3$ setting. 	<ul style="list-style-type: none"> Check the VI signal cable for breaks. Also, check the input signal value or setting of $F 6 3 3$.
$\mathcal{E} - 19$	E-19	0033	CPU communications error	<ul style="list-style-type: none"> A communications error occurs between control CPUs. 	<ul style="list-style-type: none"> Contact your Toshiba distributor.
$\mathcal{E} - 20$	E-20	0034	Excessive torque boosted	<ul style="list-style-type: none"> The automatic torque boost parameter $F 4 0 2$ setting is too high. The motor has too small impedance. 	<ul style="list-style-type: none"> Set a lower automatic torque boost parameter $F 4 0 2$ setting. Make an auto-tuning.
$\mathcal{E} - 21$	E-21	0035	CPU fault 2	<ul style="list-style-type: none"> The control CPU is defective. 	<ul style="list-style-type: none"> Contact your Toshiba distributor.
$\mathcal{E} - 26$	E-26	003A	CPU fault 3		
$\mathcal{E} \mathcal{E} \mathcal{P} 1$	EEP1	0012	EEPROM fault 1	<ul style="list-style-type: none"> The EEPROM is writing error. 	<ul style="list-style-type: none"> Turn off the inverter, then turn it again. If it does not recover from the error, contact your Toshiba distributor.
$\mathcal{E} \mathcal{E} \mathcal{P} 2$	EEP2	0013	EEPROM fault 2	<ul style="list-style-type: none"> $\mathcal{E} \mathcal{Y} \mathcal{P}$ operation was aborted by power supply off etc. The EEPROM is reading error. 	<ul style="list-style-type: none"> Turn off the inverter, then turn it again, and then try $\mathcal{E} \mathcal{Y} \mathcal{P}$ operation again. Turn off the inverter, then turn it again. If it does not recover from the error, contact your Toshiba distributor.
$\mathcal{E} \mathcal{E} \mathcal{P} 3$	EEP3	0014	EEPROM fault 3	<ul style="list-style-type: none"> The EEPROM is defective. 	<ul style="list-style-type: none"> Contact your Toshiba distributor.
$\mathcal{E} \mathcal{F} 2$	EF2	0022	Ground fault trip	<ul style="list-style-type: none"> A ground fault occurs in the output cable or the motor. 	<ul style="list-style-type: none"> Check the cable and the motor for ground faults.
* $\mathcal{E} \mathcal{P} \mathcal{H} 1$	EPHI	0008	Input phase failure	<ul style="list-style-type: none"> A phase failure occurred in the input line of the main circuit. The capacitor in the main circuit lacks capacitance. 	<ul style="list-style-type: none"> Check the main circuit input line for phase failure. Set input phase failure detection selection $F 6 0 8 = 0$. Check the capacitor in the main circuit for exhaustion.
* $\mathcal{E} \mathcal{P} \mathcal{H} 0$	EPHO	0009	Output phase failure	<ul style="list-style-type: none"> A phase failure occurred in the output line of the main circuit. The motor has too big impedance. 	<ul style="list-style-type: none"> Check the main circuit output line, motor, etc. for phase failure. Set output phase failure detection selection $F 6 0 5 = 0$.

* You can select a trip ON/OFF by parameters.

[Trip information]

Error code	Failure code	Name	Description	Remedies	
$\overline{E}rr2$	ERR2	0015	Main unit RAM fault	<ul style="list-style-type: none"> The control RAM is defective. 	<ul style="list-style-type: none"> Contact your Toshiba distributor.
$\overline{E}rr3$	ERR3	0016	Main unit ROM fault	<ul style="list-style-type: none"> The control ROM is defective. 	
$\overline{E}rr4$	ERR4	0017	CPU fault 1	<ul style="list-style-type: none"> The control CPU is defective. 	
$\overline{E}rr5$	ERR5	0018	Remote control error	<ul style="list-style-type: none"> The communication with external devices was broken off. 	<ul style="list-style-type: none"> Check the remote control device, cables, etc.
$\overline{E}tn$	ETN	0028	Auto-tuning error	<ul style="list-style-type: none"> The motor parameter νL, $\nu L \nu$, $F405$, $F415$, $F417$ are not set correctly. 	<ul style="list-style-type: none"> Set the left column parameters correctly as a motor name plate and make an auto-tuning again. Set parameter $F416$ to smaller 70% of the present value, and execute the auto-tuning again.
$\overline{E}tn1$	ETN1	0054		<ul style="list-style-type: none"> The motor with the capacity of 2 classes or less than the inverter is used. 	<ul style="list-style-type: none"> Set the left column parameters correctly as a motor name plate and make an auto-tuning again.
$\overline{E}tn2$	ETN2	0055		<ul style="list-style-type: none"> The output cable is too thin. The inverter is used for loads other than those of three-phase induction motors. 	<ul style="list-style-type: none"> Then set $F400 = 1$, when trip occurs.
$\overline{E}tn3$	ETN3	0056		<ul style="list-style-type: none"> The motor is not connected. 	<ul style="list-style-type: none"> Connect the motor. Check whether the secondary magnetic contactor.
				<ul style="list-style-type: none"> The motor is rotating. 	<ul style="list-style-type: none"> Make an auto-tuning again after the rotation of the motor stops.
$\overline{E}tYP$	ETYP	0029	Inverter type error	<ul style="list-style-type: none"> It may be a breakdown failure. 	<ul style="list-style-type: none"> Contact your Toshiba distributor.
$\overline{O}C1$	OC1	0001	Overcurrent during acceleration	<ul style="list-style-type: none"> The acceleration time RCC is too short. 	<ul style="list-style-type: none"> Increase the acceleration time RCC.
				<ul style="list-style-type: none"> The V/F setting is improper. 	<ul style="list-style-type: none"> Check the V/F parameter.
				<ul style="list-style-type: none"> A restart signal is input to the rotating motor after a momentary stop, etc. 	<ul style="list-style-type: none"> Use $F301$ (auto-restart) and $F302$ (ride-through control).
				<ul style="list-style-type: none"> A special motor (e.g. motor with a small impedance) is used. 	<ul style="list-style-type: none"> In case of $Pt=0$, 1, decrease νb. In case of $Pt=2, 3, 4$, set $F415$ (Motor rated current) and make an auto-tuning.
				<ul style="list-style-type: none"> The cable length to a motor is long. 	<ul style="list-style-type: none"> AC reactors etc. are required for the output side. (Refer to section 1.4.3-(4))
$\overline{O}C2$	OC2	0002	Overcurrent during deceleration	<ul style="list-style-type: none"> The deceleration time dEC is too short. 	<ul style="list-style-type: none"> Increase the deceleration time dEC.
				<ul style="list-style-type: none"> The cable length to a motor is long. 	<ul style="list-style-type: none"> AC reactors etc. are required for the output side. (Refer to section 1.4.3-(4))
$\overline{O}C3$	OC3	0003	Overcurrent during constant speed operation	<ul style="list-style-type: none"> The load fluctuates abruptly. The load is in an abnormal condition. 	<ul style="list-style-type: none"> Reduce the load fluctuation. Check the load (operated machine).
				<ul style="list-style-type: none"> The cable length to a motor is long. 	<ul style="list-style-type: none"> AC reactors etc. are required for the output side. (Refer to section 1.4.3-(4))
$\overline{O}CA$	OCA	0005	Arm overcurrent at start-up	<ul style="list-style-type: none"> A main circuit elements is defective. 	<ul style="list-style-type: none"> Contact your Toshiba distributor.
$\overline{O}CL$	OCL	0004	Overcurrent (An overcurrent on the load side at start-up)	<ul style="list-style-type: none"> The insulation of the output main circuit or motor is defective. The motor has too small impedance. 	<ul style="list-style-type: none"> Check the secondary wiring and insulation state. Set $F513=2, 3$
$\overline{O}H$	OH	0010	Overheat	<ul style="list-style-type: none"> The cooling fan is life or fault 	<ul style="list-style-type: none"> The cooling fan requires replacement if it does not rotate during operation. Contact your Toshiba distributor.
				<ul style="list-style-type: none"> The ambient temperature is high or low outside a specified ambient temperature. 	<ul style="list-style-type: none"> Operate at a specified ambient temperature.

* You can select a trip ON/OFF by parameters.

[Trip information]

Error code	Failure code	Name	Description	Remedies	
OL1	OL1	000D	Inverter overload	• The acceleration time ACC is too short.	• Increase the acceleration time ACC .
				• The DC braking amount is too large.	• Reduce the DC braking amount $F251$ and the DC braking time $F252$.
				• The V/F setting is improper.	• Check the V/F parameter setting.
				• A restart signal is input to the rotating motor after a momentary stop, etc.	• Use $F3B1$ (auto-restart) and $F3B2$ (ride-through control).
				• The load is too large.	• Use an inverter with a larger rating. • Reduce $F300$ (PWM carrier frequency) to 4kHz or less.
OL2	OL2	000E	Motor overload	• The V/F setting is improper.	• Check the V/F parameter setting.
				• The motor is locked up.	• Check the load (operated machine).
				• Low-speed operation is performed continuously.	• Adjust OLN to the overload that the motor can withstand during operation in a low speed range.
				• An excessive load is applied to the motor during operation.	
OL3	OL3	003E	Main module overload	• The carrier frequency is high and load current has increased at low speeds (mainly at 15Hz or less).	• Raise the operation frequency. • Reduce the load. • Reduce $F300$: PWM carrier frequency. • When an operating motor is started up at 0Hz, use the auto-restart function. • Set $F315=1$ (Carrier frequency with automatic reduction).
OP1	OP1	000A	Overvoltage during acceleration	• The input voltage fluctuates abnormally. (1) The power supply has a capacity of 200kVA or more. (2) A power factor improvement capacitor is opened or closed. (3) A system using a thyristor is connected to the same power distribution line.	• Insert a suitable input reactor.
				• A restart signal is input to the rotating motor after a momentary stop, etc.	
OP2	OP2	000B	Overvoltage during deceleration	• The deceleration time dEC is too short. (Regenerative energy is too large.)	• Increase the deceleration time dEC .
				• Overvoltage limit operation $F3B5$ is set to i . (Disabled).	• Set overvoltage limit operation $F3B5$ to $0, 2, 3$.
				• The input voltage fluctuates abnormally. (1) The power supply has a capacity of 200kVA or more. (2) A power factor improvement capacitor is opened and closed. (3) A system using a thyristor is connected to the same power distribution line.	• Insert a suitable input reactor.
OP3	OP3	000C	Overvoltage during constant-speed operation	• The input voltage fluctuates abnormally. (1) The power supply has a capacity of 200kVA or more. (2) A power factor improvement capacitor is opened or closed. (3) A system using a thyristor is connected to the same power distribution line.	• Insert a suitable input reactor.
				• The motor is in a regenerative state because the load causes the motor to run at a frequency higher than the inverter output frequency.	

[Trip information]

Error code	Failure code	Name	Description	Remedies
* O _t	OT	Over-torque trip	• Over-torque reaches to a detection level during operation.	• Enable <i>F 6 15</i> (over-torque trip selection). • Check system error.
* U _C	UC	Low-current operation Trip	• The output current decreased to a low-current detection level during operation.	• Enable <i>F 6 10</i> (low-current detection). • Check the suitable detection level for the system (<i>F 6 03</i> , <i>F 6 11</i> , <i>F 6 12</i>). • Contact your Toshiba distributor if the setting is correct.
* U _{P 1}	UP1	Under voltage trip (main circuit)	• The input voltage (in the main circuit) is too low.	• Check the input voltage. • Enable <i>F 6 2 7</i> (undervoltage trip selection). • To take measures to momentary power failure, set <i>F 6 2 7=0</i> or <i>2</i> . Regenerative power ride-through control <i>F 3 0 2</i> and Auto-restart control selection <i>F 3 0 1</i> .

* You can select a trip ON/OFF by parameters.

[Alarm information] Each message in the table is displayed to give a warning but does not cause the inverter to trip.

Error code	Name	Description	Remedies	
<i>A-05</i>	A-05	Output frequency upper limit	• An attempt was made to operate at a frequency higher than 10 times the base frequency (<i>U_L</i> or <i>F 1 7 0</i>).	• Operate at a frequency within 10 times the base frequency.
<i>A-17</i>	A-17	Operation panel key alarm	• The RUN or STOP key is held down for more than 20 seconds. • The RUN or STOP key is faulty.	• Check the operation panel.
<i>Atn</i>	ATN	Auto-tuning	• Auto-tuning in process	• Normal if it the message disappears after a few seconds.
<i>CLR</i>	CLR	Clear command acceptable	• This message is displayed when pressing the STOP key while an error code is displayed.	• Press the STOP key again to clear the trip.
<i>db</i>	DB	DC braking	• DC braking in process	• The message goes off in several tens of seconds if no problem occurs. Note 1)
<i>E1</i> <i>E2</i> <i>E3</i>	E1 E2 E3	Flowing out of excess number of digits	• The number of digits such as frequencies is more than 4. (The upper digits have a priority.)	• Lower the frequency free unit magnification <i>F 7 0 2</i> .
<i>E-49</i>	E-49	External power supply input logic switching check alarm	• The input terminal was switched to sink logic of external power supply input (+24V).	• After removing connection of the control circuit terminals reset or turn the power off and then back on again. This switches the logic.
<i>E-50</i>	E-50	Source logic switching check alarm	• The input terminal was switched to source logic.	
<i>E-51</i>	E-51	Sink logic switching check alarm	• The input terminal was switched to sink logic.	
<i>EASY/ Std</i>	EASY/ STD	Switching display of Easy setting mode / Standard setting mode	• The EASY key was pushed in the standard monitor mode.	• When <i>E R S Y</i> is displayed, setting mode becomes easy setting mode. When <i>S t d</i> is displayed, it becomes standard setting mode.
<i>EOFF</i>	EOFF	Emergency stop command acceptable	• The operation panel is used to stop the operation in automatic control or remote control mode.	• Press the STOP key for an emergency stop. To cancel the emergency stop, press any other key.
<i>Err 1</i>	ERR1	Frequency point setting error alarm	• The frequency setting signals at points 1 and 2 are set too close to each other.	• Set the frequency setting signals at points 1 and 2 apart from each other.
<i>HEAD/ End</i>	HEAD/ END	Display of first/last data items	• The first and last data item in the <i>R U H</i> data group is displayed.	• Press MODE key to exit the data group.
<i>H I/ L O</i>	HI/ LO	Setting error alarm / An error code and data are displayed alternately twice each.	• An error is found in a setting when data is reading or writing.	• Check whether the setting is made correctly.

Note 1) When the ON/OFF function is selected for DC braking (DB), using the input terminal selection parameter, you can judge the inverter to be normal if "db" disappears when opening the circuit between the terminal and CC.

[Alarm information] Each message in the table is displayed to give a warning but does not cause the inverter to trip.

Error code	Name	Description	Remedies
<i>in i t</i>	INIT	Parameters in the process of initialization	<ul style="list-style-type: none"> Parameters are being initialized to default values. Normal if the message disappears after a while (several seconds to several tens of seconds).
<i>L S t P</i>	LSTP	Auto-stop because of continuous operation at the lower-limit frequency	<ul style="list-style-type: none"> The automatic stop function selected with <i>F 2 5 6</i> was activated. This function is cancelled, when frequency reference reaches LL+0.2Hz or operation command is OFF.
<i>U O F F</i>	MOFF	Undervoltage in main circuit	<ul style="list-style-type: none"> The supply voltage between R, S and T is under voltage. Measure the main circuit supply voltage. If the voltage is at a normal level, the inverter requires repairing. In case of single phase 120V class, the shorting-bar between P0 and PA/+ is removed. Connect the shorting-bar between P0 and PA/+.
<i>n E r r</i>	NERR	No trip of past trip	<ul style="list-style-type: none"> No new record of past trip, after past trips were clear. Normal operation.
<i>n - -</i>	N---	No detailed information of past trip	<ul style="list-style-type: none"> The detailed information of past trip is read by pushing the center of setting dial during blinking <i>n E r r</i> ⇔ number. Normal operation. To be returned by pressing MODE key.
<i>O F F</i>	OFF	ST terminal OFF	<ul style="list-style-type: none"> The ST-CC circuit is opened. Close the ST-CC circuit.
<i>P A S S / F A I L</i>	PASS/FAIL	Password verification result	<ul style="list-style-type: none"> After the password setting (<i>F 7 3 0</i>), the password was input to <i>F 7 3 9</i> (password verification). If the password is correct, <i>P A S S</i> is displayed and if it is incorrect, <i>F A I L</i> is displayed.
<i>r t r y</i>	RTRY	Retry in process	<ul style="list-style-type: none"> The inverter is in process of retry. A momentary stop occurred. The motor speed is being detected. The inverter restarts automatically. Be careful of the machine because it may suddenly restart.
<i>S E t</i> Note 2)	SET	Input requirement of region setting	<ul style="list-style-type: none"> Power was supplied to the inverter at first time. Set the parameter <i>S E t</i> to 0. Set the parameter <i>t 4 P</i> to 13. Set a region setting by using setting dial. Refer to section 3.1.
<i>S t O P</i>	STOP	Deceleration stop during power failure function activated.	<ul style="list-style-type: none"> The deceleration stop during power failure with <i>F 3 0 2</i> is activated. To restart operation, power supply reset or input an operation signal again.

Note 2) *S E t* is blinking when setup menu starts. Key operation is not allowed.

But parameter *S E t* doesn't blink as same as other parameters.

[Pre-alarm information] Each message in the table is displayed to give a warning but does not cause the inverter to trip.

The following error code and the frequency will flash alternately.

Error code	Name	Description	Remedies
<i>U</i>	C	Overcurrent pre-alarm	<ul style="list-style-type: none"> When a current flows at or higher than the over current stall prevention level. Same as <i>U C</i> (overcurrent)
<i>H</i>	H	Overheat pre-alarm	<ul style="list-style-type: none"> When the overheat protection pre-alarm level is reached. Same as <i>U H</i> (overheat)
<i>L</i>	L	Overload pre-alarm	<ul style="list-style-type: none"> When the cumulative amount of overload reaches 50% or more of the overload trip value. When the main circuit element temperature reaches the overload pre-alarm level. Same as <i>U L</i> (overload)
<i>P</i>	P	Overvoltage pre-alarm	<ul style="list-style-type: none"> When a voltage is generated at or higher than the over voltage stall prevention level. When a voltage is generated at or higher than the over voltage stall prevention level. Even if it was lower than the over voltage stall prevention level, when a voltage is generated at sharp increase. Same as <i>U P</i> (overvoltage)
<i>t</i>	T	Communication pre-alarm	<ul style="list-style-type: none"> When the communication was broken off at or higher than the over parameter <i>F 8 0 3</i> setting. Same as <i>E r r 5</i> (communication fault)

If two or more problems arise simultaneously, one of the following pre-alarms appears and blinks.
U P, P L, U P L (The blinking alarms *U, P, L, H, t* are displayed in this order from left to right.)

13.2 Restoring the inverter from a trip

Do not reset the inverter when tripped because of a failure or error before eliminating the cause. Resetting the tripped inverter before eliminating the problem causes it to trip again.

The inverter can be restored from a trip by any of the following operations:

- (1) By turning off the power (Keep the inverter off until the LED turns off.)
Note) See inverter trip hold selection $F5\text{U}2$ for details.
- (2) By means of an external signal (Short circuit across RES and CC on control terminal block → Open): The reset function must be assigned to the input terminal block. (function number 8, 9)
- (3) By panel keypad operation
- (4) By inputting a trip clear signal from communication
(Refer to communication manual (E6581657) for details.)

To reset the inverter by panel keypad operation, follow these steps.

1. Press the STOP key and make sure that $L\text{L}r$ is displayed.
2. Pressing the STOP key again will reset the inverter if the cause of the trip has already been eliminated.

- ★ When any overload function [$\text{UL}1$: inverter overload, $\text{UL}2$: motor overload] is active, the inverter cannot be reset by inputting a reset signal from an external device or by operation panel operation before the virtual cooling time has passed.

Virtual cooling time ... $\text{UL}1$: about 30 seconds after the occurrence of a trip

$\text{UL}2$: about 120 seconds after a occurrence of a trip

- ★ As to $\text{UL}3$ (Main module overload), there is no virtual cooling time.
- ★ In case of a trip due to overheat (OH), the inverter checks the temperature within. Wait until the temperature in the inverter falls sufficiently before resetting the inverter.
- ★ The inverter cannot be reset while the emergency stop signal is being input from the terminal.

[Caution]

Turning the inverter off then turning it on again resets the inverter immediately. You can use this mode of resetting if there is a need to reset the inverter immediately. Note, however, that this operation may damage the system or the motor if it is repeated frequently.

13.3 If the motor does not run while no trip message is displayed ...

If the motor does not run while no trip message is displayed, follow these steps to track down the cause.

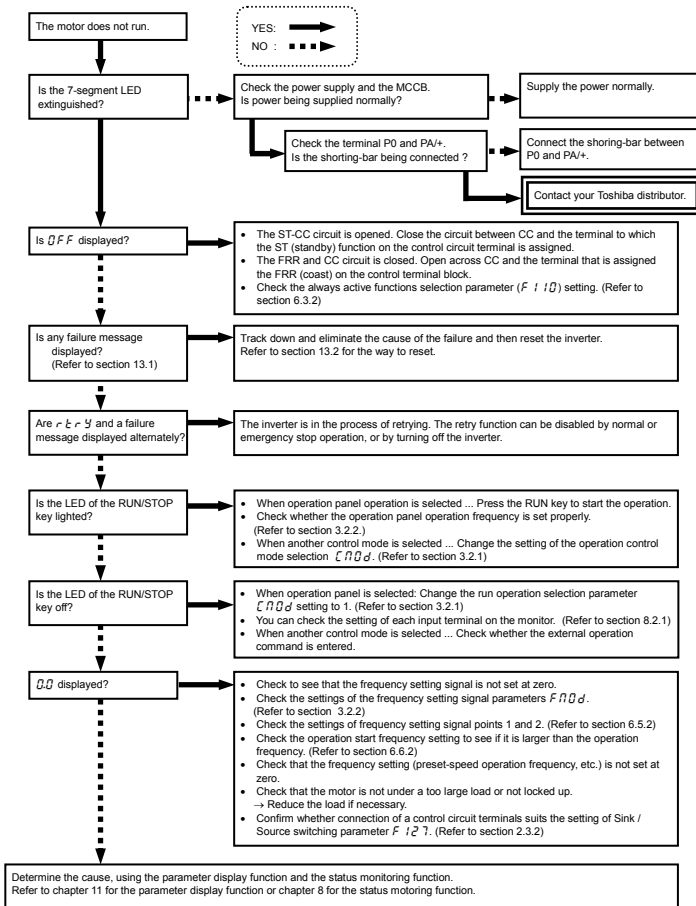

13.4 How to determine the causes of other problems



The following table provides a listing of other problems, their possible causes and remedies.

Problems	Causes and remedies
The motor runs in the wrong direction.	<ul style="list-style-type: none"> • Invert the phases of the output terminals U, V and W. • Invert the forward/reverse run-signal terminals of the external input device. (Refer to section 7.2.1 "Assignment of functions to control terminals") • Change the setting of the parameter F_r in the case of panel operation.
The motor runs but its speed does not change normally.	<ul style="list-style-type: none"> • The load is too heavy. Reduce the load. • The soft stall function is activated. Disable the soft stall function. (Refer to section 3.5) • The maximum frequency F_H and the upper limit frequency U_L are set too low. Increase the maximum frequency F_H and the upper limit frequency U_L. • The frequency setting signal is too low. Check the signal set value, circuit, cables, etc. • Check the setting characteristics (point 1 and point 2 settings) of the frequency setting signal parameters. (Refer to section 6.5.2) • If the motor runs at a low speed, check to see that the stall prevention function is activated because the torque boost amount is too large. Adjust the torque boost amount (ω_b) and the acceleration time (R_L). (Refer to section 5.12 and 5.3)
The motor does not accelerate or decelerate smoothly.	<ul style="list-style-type: none"> • The acceleration time (R_L) or the deceleration time (dE) is set too short. Increase the acceleration time (R_L) or the deceleration time (dE).
A too large current flows into the motor.	<ul style="list-style-type: none"> • The load is too heavy. Reduce the load. • If the motor runs at a low speed, check whether the torque boost amount is too large. (Refer to section 5.12)
The motor runs at a higher or lower speed than the specified one.	<ul style="list-style-type: none"> • The motor has an improper voltage rating. Use a motor with a proper voltage rating. • The motor terminal voltage is too low. Check the setting of the base frequency voltage parameter (ω_L). (Refer to section 5.10) Replace the cable with a cable larger in diameter. • The reduction gear ratio, etc., are not set properly. Adjust the reduction gear ratio, etc. • The output frequency is not set correctly. Check the output frequency range. • Adjust the base frequency. (Refer to section 5.10)
The motor speed fluctuates during operation.	<ul style="list-style-type: none"> • The load is too heavy or too light. Reduce the load fluctuation. • The inverter or motor used does not have a rating large enough to drive the load. Use an inverter or motor with a rating large enough. • Check whether the frequency setting signal changes. • If the V/F control selection parameter P_L is set at 3, check the vector control setting, operation conditions, etc. (Refer to section 5.11)
Parameter settings cannot be changed.	<p>Change the setting of the parameter setting selection prohibited parameter F_{I} to I (enabled) if it is set to I or 2 (prohibited).</p> <p>* For reasons of safety, some parameters cannot be reprogrammed while the inverter is running. (Refer to section 6.18.1 and 11.8)</p>
Communication will not take place.	Refer to "Appendix 4 Troubleshooting" in Communication Manual (E6581656).
The 7-segment LED display " $dRtR^*$ " or " 00000 ".	<ul style="list-style-type: none"> • The setting of the parameter F_{I} (Initial panel display selection) is set at I (Arbitrary code from communication). • Change the setting of the parameter F_{I}. \Rightarrow See section 6.18.5. • For more information of the F_{I} set "I", refer to "RS485 Communication Function Instruction Manual (E6581657)."

How to cope with parameter setting-related problems

If you forget parameters which have been reset	<ul style="list-style-type: none"> • You can search for all reset parameters and change their settings. * Refer to section 4.3.1 for details.
If you want to return all reset parameters to their respective default settings	<ul style="list-style-type: none"> • You can return all parameters which have been reset to their default settings. * Refer to section 4.3.2 for details.

14. Inspection and maintenance

 Warning	
 Mandatory action	<ul style="list-style-type: none"> • The equipment must be inspected every day. If the equipment is not inspected and maintained, errors and malfunctions may not be discovered which could lead to accidents. • Before inspection, perform the following steps. <ol style="list-style-type: none"> (1) Shut off all input power to the inverter. (2) Wait at least 15 minutes and check to make sure that the charge lamp is no longer lit. (3) Use a tester that can measure DC voltages (400V DC or more), and check that the voltage to the DC main circuits (across PA-PC) does not exceed 45V. <p style="text-align: center;">Performing an inspection without carrying out these steps first could lead to electric shock.</p>

Be sure to inspect the inverter regularly and periodically to prevent it from breaking down because of the environment of use, such as temperature, humidity, dust and vibration, or deterioration of its components with aging.

14.1 Regular inspection

Since electronic parts are susceptible to heat, install the inverter in a cool, well-ventilated and dust-free place. This is essential for increasing the service life.

The purpose of regular inspections is to maintain the correct environment of use and to find any sign of failure or malfunction by comparing current operation data with past operation records.

Subject of inspection	Inspection procedure			Criteria for judgement
	Inspection item	Inspection cycle	Inspection method	
1. Indoor environment	1) Dust, temperature and gas	Occasionally	1) Visual check, check by means of a thermometer, smell check	1) Improve the environment if it is found to be unfavorable. 2) Check for any trace of water condensation. 3) Max. temperature: 60°C
	2) Drop of water or other liquid	Occasionally	2) Visual check	
	3) Room temperature	Occasionally	3) Check by means of a thermometer	
2. Units and components	1) Vibration and noise	Occasionally	Tactile check of the cabinet	Is something unusual is found, open the door and check the transformer, reactors, contactors, relays, cooling fan, etc., inside. If necessary, stop the operation.
3. Operation data (output side)	1) Load current	Occasionally	Moving-iron type AC ammeter	To be within the rated current, voltage and temperature. No significant difference from data collected in a normal state.
	2) Voltage (*)	Occasionally	Rectifier type AC voltmeter	
	3) Temperature	Occasionally	Thermometer	

*) The voltage measured may slightly vary from voltmeter to voltmeter. When measuring the voltage, always take readings from the same circuit tester or voltmeter.

■ Check points

1. Something unusual in the installation environment
2. Something unusual in the cooling system
3. Unusual vibration or noise
4. Overheating or discoloration
5. Unusual odor
6. Unusual motor vibration, noise or overheating
7. Adhesion or accumulation of foreign substances (conductive substances)

■ Cautions about cleaning





To clean the inverter, wipe dirt off only its surface with a soft cloth but do not try to remove dirt or stains from any other part. If stubborn stains persist, remove them by wiping gently with a cloth dampened with neutral detergent or ethanol.

Never use any of the chemicals in the table below; the use of any of them may damage or peel the coating away from molded parts (such as plastic covers and units) of the inverter.

Acetone	Ethylene chloride	Tetrachloroethane
Benzene	Ethyl acetate	Trichloroethylene
Chloroform	Glycerin	Xylene

14.2 Periodical inspection

Make a periodical inspection at intervals of 3 or 6 months depending on the operating conditions.

 Warning	
 Mandatory action	<ul style="list-style-type: none"> • Before inspection, perform the following steps. <ol style="list-style-type: none"> (1) Shut off all input power to the inverter. (2) Wait at least 15 minutes and check to make sure that the charge lamp is no longer lit. (3) Use a tester that can measure DC voltages (400V DC or more), and check that the voltage to the DC main circuits (across PA-PC) does not exceed 45V. Performing an inspection without carrying out these steps first could lead to electric shock.
 Prohibited	<ul style="list-style-type: none"> • Do not replace parts. This will result in electric shock, fire and other injury. Please call your Toshiba distributor for repairs and replacement of expendable parts.
 Important	<ul style="list-style-type: none"> • Estimated time of replacement of parts with life span varies depending on frequency of use and conditions. • The above are only guidelines and do not promise to fail or repair free of charge. In addition, parts replacement (charged) is required even if it is used for a long time, such as continuous use, depending on usage conditions at an early stage or within the product warranty period.

■ Check items

1. Check to see if all screwed terminals are tightened firmly. If any screw is found loose, tighten it again with a screwdriver.
2. Check to see if all caulked terminals are fixed properly. Check them visually to see that there is no trace of overheating around any of them.
3. Check all cables and wires for damage. Check them visually.
4. Remove dirt and dust. With a vacuum cleaner, remove dirt and dust. When cleaning, clean the vents and the printed circuit boards. Always keep them clean to prevent an accident due to dirt or dust.
5. If no power is supplied to the inverter for a long time, the performance of its main circuit smoothing aluminum electrolytic capacitor declines.
When leaving the inverter unused for a long time, energize it for an hour or more each without load accordance to the table section 14.4, to recover the performance of the electrolytic capacitor.
Then check the function of the inverter.
6. If the need arises, conduct an insulation resistance test on the main circuit terminal block only, using a 500V insulation resistance tester under changing the grounding capacitor's capacity to small by the grounding capacitor switch about single-phase 200V class. Never conduct an insulation resistance test on control terminals other than terminals on the printed circuit board or on control terminals. When testing the motor for insulation, separate it from the inverter in advance by disconnecting the cables from the inverter output terminals U/T1, V/T2 and W/T3. When conducting an insulation resistance test on peripheral circuits other than the motor circuit, disconnect all cables from the inverter so that no voltage is applied to the inverter during the test.
If it is 5 M Ω or more, there is no problem.
(Single-phase 200 V class with built-in noise filter will have lower values.)

(Note) Before an insulation resistance test, always disconnect all cables from the main circuit terminal board and test the inverter separately from other equipment.

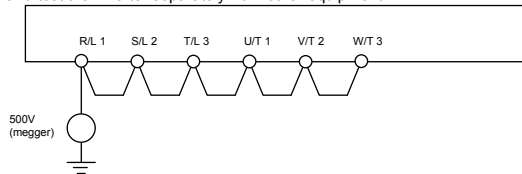

7. Never test the inverter for pressure. A pressure test may cause damage to its components.
8. Voltage and temperature check

Recommended voltmeter : Input side ... Moving-iron type voltmeter (Ⓢ)

 Output side ... Rectifier type voltmeter (▶|)

It will be very helpful for detecting a defect if you always measure and record the ambient temperature before, during and after the operation.

■ Periodical inspection on the replacement parts

Inverters include lifetime parts (aluminum electrolytic capacitors, cooling fans, etc.). These parts age because of the configurations or the physical properties. If they are left unused for a long time, the performance of the inverter will deteriorate, thus resulting in a failure. Be sure to perform periodical inspection for preventive maintenance.

For replacement of each replacement part, contact your Toshiba distributor. Do not replace the parts on your own for safety.

1) Cooling fan inspection

The inspection items for the cooling fans are as follows:

- Are the cooling fans rotating stably?
- Is any unusual sound or vibration found?

Estimated time of replacement of the cooling fans that cool down the heat-generating parts are 10 years.

* Average ambient temperature 40°C, relative humidity 65%, load factor 80%, 24-hour operation per day

However, do not have corrosive gas, oil mist, dust, metal powder and so on.

Also, replace the fans when unusual sound or vibration is found.

For replacement of the cooling fans, contact your Toshiba distributor.

2) Smoothing aluminum electrolytic capacitor inspection

The inspection items for the smoothing aluminum electrolytic capacitor are as follows:

- Is liquid leak found?
- Is the safety valve lifted?

Estimated time of replacement of the smoothing aluminum electrolytic capacitor is 10 years.

* Average ambient temperature 40°C, relative humidity 65%, load factor 80%, 24-hour operation per day

However, do not have corrosive gas, oil mist, dust, metal powder and so on.

The replacement of the smoothing aluminum electrolytic capacitor is replaced the inverter itself.

Contact your Toshiba distributor.

☆ You can check the parts replacement alarm and output signals in [Monitor mode].

For details, refer to [6. 16. 14].

☆ Estimated timing of replacement of the smoothing aluminum electrolytic capacitor becomes shorter at high ambient temperature, and becomes longer at low ambient temperature.

■ Estimated time of replacement of the other principal parts

The estimated parts replacement cycles are shown in the following table. They are based on the assumption that they will be used under normal use conditions (average ambient temperature of 40°C, relative humidity 65%, load factor of 80%, 24-hour operation per day, with no corrosive gas, oil mist, dust, metal powder, etc. present). Estimated time of replacement of lifetime parts are not the lives of the parts. They are based on the assumption that more parts will become abnormal when they are used over these cycles.

Part name	Estimated time of replacement *1, *2, *3	Replacement method
Relays	-	To be determined by inspection
Aluminum electrolytic capacitor mounted on the printed circuit board	10 years *4	Replacement with a new inverter itself (To be determined by inspection)

*1 Estimated time of replacement of lifetime parts varies depending on usage frequency and conditions.

*2 The above are only guidelines and do not promise to fail or repair free of charge. In addition, parts replacement (charged) is required even if it is used for a long time, such as continuous use, depending on usage conditions at an early stage or within the product warranty period.

*3 The condition of Estimated time of replacement are average ambient temperature 40°C, relative humidity 65%, 24-hour operation per day.

However, do not have corrosive gas, oil mist, dust, metal powder and so on.

*4 It is based on the case where the inverter output current is 80% of the inverter rated current.

14.3 Contacting with your Toshiba distributor

For the Toshiba distributor, refer to the back cover of this instruction manual. If defective conditions are encountered, please contact the Toshiba service section in charge via your Toshiba distributor.

When making a call for servicing, please inform us of the contents of the name plate on the side of the inverter, the presence or absence of optional devices, etc., in addition to the details of the failure.

14.4 Keeping the inverter in storage

If you store the inverter temporarily or for a long time after purchase, follow the instructions below.

1. Storage location

Store the inverter indoors. Avoid to be exposed to direct sunlight, corrosive, explosive or flammable gases, salt, oil mist, dust, metal powder, vapor or condensation.

Storage temperature and Relative humidity are shown in the table below.

2. Periodical check

If no power is supplied to the inverter for a long time, the performance of its main circuit smoothing aluminum electrolytic capacitor declines.

When leaving the inverter unused for a long time, energize it for an hour or more each without load in accordance with the table below, to recover the performance of the electrolytic capacitor.

Then check the function of the inverter.

	Storage temperature [°C]	Relative humidity	How to recover the performance of the electrolytic capacitor
Short-term Storage (within one month such as during transportation)	-25 to 70	within 95%	Supplying power without load is not required.
Long-term Storage (exceeding one month)	-10 to 40	Within 90%	Supply power once every two years for an hour or more.

15. Warranty

■ Warranty period

This product's warranty period is 12 months after the purchase, or 18 months from the date of manufacture printed on the rating plate, whichever precedes the other.

The warranty period of repaired products will not exceed the warranty period before the repair takes place.

■ Scope of warranty

If a product failure is found during the warranty period due to our negligence, please return the product to Toshiba distributor of purchase, for a replacement or repair of the defective component.

The warranty shall only cover the purchased or delivered product itself.

The following circumstances will incur paid service even before the warranty period expires.

- Product replacement or repair when the product is not returned.
- Product failure or damage due to misuse, inappropriate repair or modification of the product.
- Product failure or damage for reasons such as but not limited to a fall after purchase, an accident during transport, or handling (e.g. smoking) during transport.
- Product failure or damage by natural disasters or unforeseeable external causes such as but not limited to fire, salt exposure, gas exposure, earthquakes, storms, floods, lightning and abnormal voltage.
- Product failure or damage by use under inappropriate circumstances, environments or use not suggested in the product catalog or instruction manual, or use not complying with the original use intended for the product.
- Product failure or damage by the lack of proper maintenance or replacement of expiring parts suggested in the instruction manual.
- In case the product is embedded in your equipment, product failure or damage by causes irrelevant to the product, such as the design of your equipment and software.
- In case the product is embedded in your equipment, product failure that could have been avoided if your equipment had featured a safety device in compliance with the law that governs your equipment, or any feature or structure that is considered the norm by the industry standard.
- Any product failure or damage by accidents that were unforeseeable with the technological standard at shipment.

■ Warranty exemptions

Irrespective of the warranty period, the warranty shall not cover the following conditions.

- Compensation for any damage not attributed to our negligence.
- Compensation for any loss of business opportunity or income caused by failure of the product.
- All liabilities and compensations for any damage, secondary damage, accidents, damage to any entity that is not the product and damage to any other operations that arise from special circumstances, that we may or may not foresee.
- Any compensations for the results of your product replacement, readjustment of the local equipment after replacement, launch test, inspections, or any other operations.

■ Service after the stop production

Please ask Toshiba distributor of purchase about the stop of production and repair work for each product.

16. Disposal of the inverter



Caution



Mandatory
action

- If you dispose of the inverter, have it done by a specialist in industry waste disposal(*). If you dispose of the inverter by yourself, this can result in explosion of capacitor or produce noxious gases, resulting in injury.
(*) Persons who specialize in the processing of waste and known as "industrial waste product collectors and transporters" or "industrial waste disposal persons." If the collection, transport and disposal of industrial waste is done by someone who is not licensed for that job, it is a punishable violation of the law. (Laws in regard to cleaning and processing of waste materials)

For safety's sake, do not dispose of the disused inverter yourself but ask an industrial waste disposal agent.

Disposing of the inverter improperly could cause its capacitor to explode and emit toxic gas, causing injury to persons.

17. Appendix

■ 한국 KC 마크

도시바산업용 인버터 TOSVERT VF-nC3 은, 한국 전과법에 적합한 기기입니다.
한국에서 본제품을 사용하게될 경우, 아래내용에 주의하여 주십시오.

A 급 기기 (업무용 방송통신기자재)

이 기기는 업무용(A 급) 전자파적합기기로서 판매자 또는 사용자는 이 점을 주의하시기 바라며,
가정이외의 지역에서 사용하는 것을 목적으로 합니다.

본제품은, 다음의 EMC대책을 마련하는것을 조건으로하여 한국 전과법 준하고 있습니다. 올바른 EMC대책을 준비하신후
사용하여 주십시오.

- ① 인버터 입력측에 EMC필터를 삽입하여 주십시오.
EMC 필터는 아래의 표에 포함되어 있는 제품을 사용하여 주십시오. 전도 노이즈의 적합성 평가는 이 조합으로 진행되고
있습니다. 일부기종에서는 EMC 필터를 내장하고 있으나, 동력선이 길 경우와 노이즈 억제 효과를 높이고 싶을 경우는,
EMC 필터를 삽입해 주십시오.
- ② 인버터 출력 케이블등의 차폐 전원 케이블과 차폐 제어 케이블을 사용하십시오. 그리고 케이블과 전선을 잘 배선하여
길이를 가능한 짧게하여 주십시오. 전원 케이블과 제어 케이블 사이 및 전원 케이블의 입력 전선과 출력 전선 사이에
공간을 두고, 나란히 배선하거나 함께 묶지 않도록 주의하여 주십시오. 만약 필요하실 경우 직각교차형태로 사용하여
주십시오.
- ③ 인버터를 철재 제어반안에 설치할 경우 방사노이즈를 제한하는데 더 효과적입니다. 가능한 두껍고 짧은 전선을 사용하여,
접지 케이블과 전원 케이블 사이에 공간을 둔 상태로 금속판과 제어판을 확실하게 접지시켜주십시오.
- ④ 가능한 입력 전선과 출력 전선을 따로 배선하십시오.
- ⑤ 케이블의 방사노이즈를 억제하려면 노이즈 차단판으로 모든 차폐 케이블을 접지시키십시오. 인버터와 조작반사이의
공간(서로 반경 10cm 이내)에 차폐 케이블을 접지시키는 것이 효과적입니다. 차폐 케이블에 페라이트 코어를 삽입하면
방사 노이즈를 제한하는데 더욱 효과적입니다.
- ⑥ 인버터 출력선에 영상(零相)리액터를 삽입하고, 금속판과 제어반의 접지 케이블에 페라이트 코어를 삽입하면 더욱
효과적인 방사노이즈가 가능합니다.

표 인버터와 EMC 필터 결합

3 상 240V 급

인버터 타입	인버터와 필터의 결합	
	20m 이하의 모터 배선 길이	
VFNC3-2001P	EMFA2006Z	
VFNC3-2002P	EMFA2006Z	
VFNC3-2004P	EMFA2006Z	
VFNC3-2007P	EMFA2006Z	
VFNC3-2015P	EMFA2015Z	
VFNC3-2022P	EMFA2015Z	

단상 240V 급

인버터 타입	인버터와 필터의 결합	
	10m 이하의 모터 배선 길이	50m 이하의 모터 배선 길이
VFNC3S-2001PL	내장형 필터	EMFAS2011Z
VFNC3S-2002PL	내장형 필터	EMFAS2011Z
VFNC3S-2004PL	내장형 필터	EMFAS2011Z
VFNC3S-2007PL	내장형 필터	EMFAS2011Z
VFNC3S-2015PL	내장형 필터	EMFAS2025Z
VFNC3S-2022PL	내장형 필터	EMFAS2025Z

단상 120V 급

인버터 타입	인버터와 필터의 결합	
	20m 이하의 모터 배선 길이	
VFNC3S-1001P	EMFAS2011Z	
VFNC3S-1002P	EMFAS2011Z	
VFNC3S-1004P	EMFAS2011Z	
VFNC3S-1007P	EMFAS2025Z	

주의) 베이스 플레이트 타입(인버터 타입 말미가 "B". 예를 들면, VFNC3-2001PB)은, 한국 전과법에 적합하고 있지 않습니다.

■VF-nC3 motor control parameter default setting update information

■Adaptation to TOSHIBA IE3 motor

TOSHIBA standard motor has been changed from traditional IE1 motor to IE3 motor for energy efficiency improvement. VF-nC3 inverter parameter default setting values are changed to adapt the motor control characteristics of IE3 motor. If the inverter of the new software version V120 or later is applied to traditional IE1 motor, adjust the parameters according to this sheet, because the motor control characteristics may not be same as the inverter of the old software version V112 or earlier.

This sheet explains the product identification, the default setting values changed for IE3 motor and the adjustment of the inverter parameter for traditional IE1 motor.

■Product identification

Identify the software version as following method.

- a) Status monitor mode by the panel
CPU1 version shows the software version.
(Refer to section 8.2)
- b) Name plate or packaging label of the inverter
Product version (refer to right figure) on the name plate or packaging label shows following identification number.

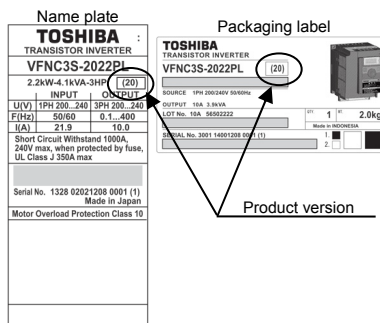

Product version	Software version	Target motor as default
(0)~(7)	V100~V112	Traditional IE1 motor
(20)~	V120~	IE3 motor

■In case of new adoption of inverter

All parameters on Table1 should be set as follows.

- a) In case of using IE3 motor, the parameters on Table1 can be used without change.
- b) In case of using traditional IE1 motor, the parameters values should be adjusted according to Table4.
- c) In case of using other motor or in case of setting $P\zeta$ (V/F control mode selection) except 0 or 1 the parameter values should be adjusted to suit to applied motor. (For example: To do auto tuning)

■In case of replacing inverter of software version V112 or earlier

Regarding all the parameters on Table1, copy all of the parameter setting values from V112 or earlier version inverter, and then set them to V120 or later version inverter. Same motor control characteristics will be obtained.

$F457$ and $F45B$ are manufacturer setting parameters. However, change these parameters according to Table 4 for achieving same motor control characteristics.

($F457$ does not exist on V112 or earlier version inverter.)

■Impact of using traditional IE1 motor with default setting

In case traditional IE1 motor is driven by V120 or later version inverter with their default setting values described on Table3, following operation can be impacted.

- Torque boost is set to low. Therefore, motor torque can be insufficient at low speed.

Countermeasure: Set the parameter on Table4.

- Motor rated speed is set to high. Therefore, motor slip can become larger than expected one at vector control.

Countermeasure: Set the parameter values on Table4, and apply auto tuning.

■Search changed parameters (G r U)

In case of copying parameters from V112 or earlier version inverter to V120 or later version inverter, the parameters described on Table1 are searched on the Searching Changed Parameters (G r U: Automatic edit function).

Copying on opposite direction is led to the similar result.

(F 4 5 7 does not exist on V112 or earlier version inverter.)

■Communication tool (PCM002Z)

In case of reading the parameters of V112 or earlier version inverter by the parameter list of V120 or later version (for IE3 motor) in maintenance communication tool (PCM002Z), PCM002Z displays as 'modified' for the parameters described on Table1.

Reading with the opposite relation of their software version is led to the similar result.

(F 4 5 7 does not exist on V112 or earlier version inverter.)

■Parameters changed default setting values

Table1: Parameter list changed default setting values at software V120 or later version

Title	Com. No.	Function	Unit	Minimum setting unit Panel/Com.	Adjustment range	Default setting	Reference
<i>F 1 7 2</i>	0016	Torque boost value 1	%	0.1/0.1	0.0-30.0	*1	5.12
<i>F 1 7 2</i>	0172	Torque boost value 2	%	0.1/0.1	0.0-30.0	*1	6.4.1
<i>F 4 0 2</i>	0402	Automatic torque boost value	%	0.1/0.1	0.1-30.0	*1	6.14
<i>F 4 1 5</i>	0415	Motor rated current	A	0.1/0.1	0.1-30.0	*1	
<i>F 4 1 6</i>	0416	Motor no-load current	%	1/1	10-90	*1	
<i>F 4 1 7</i> *2	0417	Motor rated speed	min-1	1/1	100-32000	*1	
<i>F 4 5 7</i>	0457	Motor specific constant 11	-	1/1	5-75	50	-
<i>F 4 5 8</i>	0458	Motor specific constant 2	-	1/1	0-101	101	-
<i>F 4 5 9</i>	0459	Load inertia moment ratio	Times	0.1/0.1	0.1-100.0	1.5	6.14

*1: Default setting values are different depending on the inverter ratings. (Refer to Table3.)

*2: *F 4 5 7* is added at software V120.

■Default setting, region setting

Regarding the change of the parameter default setting values described on Table1, the several functions described below are changed from V120 or later version.

Table2: Function changed at V120 or later version inverter

Title	Before (V112 or earlier version)	After (V120 or later version)	Reference
50Hz default setting (<i>t y P = 1</i>)	Function is not changed. <i>F 4 1 7</i> (Motor rated speed): 1410(min⁻¹) is set. It is NOT dependent on the inverter ratings.		4.3.2
60Hz default setting (<i>t y P = 2</i>)	Function is not changed. <i>F 4 1 7</i> (Motor rated speed): 1710(min⁻¹) is set. It is NOT dependent on the inverter ratings.		
Default setting 1 (<i>t y P = 3</i>)	Parameters on Table1 are initialized to the values described on Table4 .	Parameters on Table1 are initialized to the values described on Table3 .	
Default setting 2 (<i>t y P = 1 3</i>)	Parameters on Table1 are initialized to the values described on Table4 . (Region setting is required in advance)	Parameters on Table1 are initialized to the values described on Table3 . (Region setting is required in advance)	
Region setting (<i>5 E t</i>)	Parameters on Table1 are initialized to the values described on Table4 .	Parameters on Table1 are initialized to the values described on Table3 .	6.14 11.5

(*F 4 5 7* does not exist on V112 or earlier version drive.)

Table 3: Parameter setting values for the IE3 motor (V120 or later version defaults)

Type form	F4172 ⁴ %	F402 %	F415 A	F416 %	F4173 ³ (JP, USA) min ⁻¹	F4173 ³ (ASIA, EU) min ⁻¹	F457 —	F458 —	F459 Times
VFNC3-2001P	Same values as Table4 (V112 or earlier version)						50	101	1.5
VFNC3-2002P	Same values as Table4 (V112 or earlier version)								
VFNC3-2004P	Same values as Table4 (V112 or earlier version)								
VFNC3-2007P	4.8	4.3	3.4	55	1730	1440			
VFNC3-2015P	4.8	4.4	6.4	42	1740	1445			
VFNC3-2022P	3.1	2.9	9.4	50	1755	1460			
VFNC3-2037P	3.1	2.8	14.6	38	1755	1460			
VFNC3S-2001PL	Same values as Table4 (V112 or earlier version)						50	101	1.5
VFNC3S-2002PL	Same values as Table4 (V112 or earlier version)								
VFNC3S-2004PL	Same values as Table4 (V112 or earlier version)								
VFNC3S-2007PL	4.8	4.3	3.4	55	1730	1440			
VFNC3S-2015PL	4.8	4.4	6.4	42	1740	1445			
VFNC3S-2022PL	3.1	2.9	9.4	50	1755	1460			
VFNC3S-1001P	Same values as Table4 (V112 or earlier version)								
VFNC3S-1002P	Same values as Table4 (V112 or earlier version)								
VFNC3S-1004P	Same values as Table4 (V112 or earlier version)								
VFNC3S-1007P	4.8	4.3	3.4	55	1730	1440			

Table4: Parameter default setting values for traditional IE1 motor (V112 or earlier version defaults)

Type form	F4172 ⁴ %	F402 %	F415 A	F416 %	F4173 ³ (JP, USA) min ⁻¹	F4173 ³ (ASIA, EU) min ⁻¹	F457 ⁴ —	F458 ⁴ —	F459 Times
VFNC3-2001P	6.0	10.3	0.6	75	1710	1410	75	0	1.0
VFNC3-2002P	6.0	8.3	1.2	70					
VFNC3-2004P	6.0	6.2	2.0	65					
VFNC3-2007P	6.0	5.8	3.4	60					
VFNC3-2015P	6.0	4.3	6.2	55					
VFNC3-2022P	5.0	4.1	8.9	52					
VFNC3-2037P	5.0	3.4	14.8	48					
VFNC3S-2001PL	6.0	10.3	0.6	75	1710	1410	75	0	1.0
VFNC3S-2002PL	6.0	8.3	1.2	70					
VFNC3S-2004PL	6.0	6.2	2.0	65					
VFNC3S-2007PL	6.0	5.8	3.4	60					
VFNC3S-2015PL	6.0	4.3	6.2	55					
VFNC3S-2022PL	5.0	4.1	8.9	52					
VFNC3S-1001P	6.0	10.3	0.6	75					
VFNC3S-1002P	6.0	8.3	1.2	70					
VFNC3S-1004P	6.0	6.2	2.0	65					
VFNC3S-1007P	6.0	5.8	3.4	60					

³: Refer to section 3.1 'How to Set the Setup Menu' and 4.4 'Checking the region settings selection'.

⁴: F457 and F458 are manufacturer setting parameters. However, change these parameters according to Table4 for achieving same motor control characteristics. F457 is not copied from V112 or earlier version inverter by Parameter writer or other options, because F457 does not exist on V112 or earlier version inverter. Therefore, change F457 manually.

TOSHIBA

TOSHIBA INDUSTRIAL PRODUCTS AND SYSTEMS CORPORATION

Motor Drive Division
580, Horikawa-cho, Saiwai-Ku, Kawasaki, Kanagawa
212-0013 Japan
TEL : +81-44-520-0828
FAX : +81-44-520-0508

<https://www.toshiba-tps.co.jp/en/contact/eu.html>

TOSHIBA INTERNATIONAL CORPORATION
13131 West Little York RD., Houston
TX 77041, U.S.A
TEL : +1-713-466-0277
FAX : +1-713-896-5242

**TOSHIBA INDUSTRIAL PRODUCTS AND SYSTEMS
SHANGHAI CORPORATION**
Raffles City (Office Tower), No. 268,
Xizang Middle Road, Huangpu District, Shanghai,
P.R.China
TEL : +86-21-6361-3300
FAX : +86-21-6373-1760

TOSHIBA ASIA PACIFIC PTE LTD
20 Pasir Panjang Road #12-2528,
Mapletree Business City, Singapore 117439
TEL : +65-6297-0990
FAX : +65-6305-5560

TOSHIBA INTERNATIONAL CORPORATION PTY LTD
11A Gibbon Road, Winston Hills, Sydney, NSW 2153,
Australia
TEL : +61-2-8867-6200
FAX : +61-2-9624-7104

TOSHIBA INDIA PRIVATE LIMITED
3RD Floor, Building No.10, Tower B, Phase-II,
DLF Cyber City, Gurgaon-122022, Haryana, India
TEL : +91-124-4996600
FAX : +91-124-4996665

TOSHIBA GULF FZE
P.O.Box 61028, Jebel Ali, Free Zone, Dubai, U.A.E
TEL : +971-4-8817789
FAX : +971-4-3814093