

# HIOKI

---

---

Instruction Manual

## 3197

# POWER QUALITY ANALYZER

HIOKI E. E. CORPORATION

May 2012 Revised edition 7 3197A981-07 12-05H

---



\*600124367\*



# Contents

Introduction.....	1
Confirming Package Contents.....	2
Safety Information .....	4
Operating Precautions.....	7
Operating Procedure Descriptions in this Manual .....	12

## **Chapter 1** **Overview** \_\_\_\_\_ **13**

1.1 Product Overview .....	13
1.2 Features .....	14
1.3 Measurement Flowchart .....	17
■ Initial instrument preparations .....	19
■ Install and connect the instrument, and turn the power on .....	19
■ Other preparations .....	19
■ Confirming Instrument Settings and Connecting to the Lines to be Measured .....	20
■ Start recording and analyze recorded measurement data. ....	21

## **Chapter 2** **Names and Functions of Parts and Basic Setup** \_\_\_\_\_ **23**

2.1 Panel and Operating Keys .....	23
2.2 Basic Operations .....	27
2.3 Screen Configurations .....	28
2.4 Common Screen Elements .....	32
2.5 Internal Operating Status and Memory Usage .....	34
■ When Memory Partitioning is Disabled (Partition: [OFF]) .....	34
■ Using Memory Partitioning (Partition: [ON]) .....	35

## **Chapter 3** **Measurement Preparations** \_\_\_\_\_ **37**

3.1 Initial Instrument Preparations .....	37
■ Apply the appropriate label to the input terminals .....	37
■ Apply the appropriate labels to the voltage measurement and clamp sensor leads .....	38
■ Attach the strap .....	38

■ Install the 9459 Battery Pack .....	39
■ Charge the 9459 Battery Pack .....	40
3.2 Connecting the AC Adapter .....	41
3.3 Connecting the Voltage Cords .....	42
3.4 Connecting Clamp Sensors .....	44
3.5 Turning the Power On and Off .....	46
3.6 Other Preparations .....	48
■ Select the screen color scheme to match the input terminal labels .....	48
■ Select the naming convention to be applied to each phase line measurement on the display .....	49
3.7 Auxiliary Function (KEY LOCK) .....	51
3.8 Auxiliary Function (Save screen image) .....	52

## Chapter 4

### Pre-Measurement and System Settings **53**

4.1 Basic Setup (Typical Settings) .....	54
4.2 Selecting the Measurement Method (SYSTEM Screen)[MEASURE] .....	57
■ Selecting the Line Frequency (Frequency) .....	58
■ Setting the Wiring Method (Wiring) .....	58
■ Setting the Line Voltage (Nominal Line Voltage) of the Lines to be Measured .....	59
■ Selecting the Clamp Sensor Model and Current Range .....	60
■ Setting the PT Ratio (when measuring using a transformer) ....	61
■ Setting the CT Ratio (when measuring using a transformer) ....	61
■ Selecting the Voltage Harmonic Calculation Method .....	62
■ Selecting the Power Factor Calculation Method (PF Type) .....	62
4.3 Setting the Recording Method [REC&EVENT] .....	63
■ Setting the Method for Recording to Internal Memory (Partition) .....	63
■ Setting the Recording Interval (Interval) .....	64
■ Setting Demand Period .....	65
■ Setting Recording Start and Stop Times .....	66
4.4 Setting Event Detection [REC&EVENT] .....	67
■ Start Event/ Stop Event .....	68
■ Manual Events .....	68
■ Setting Timed Events .....	69
■ Setting Inrush Events .....	69
■ Setting Transient Events .....	70
■ Setting Voltage Swell, Dip and Interruption Events .....	71

4.5	Changing Instrument System Settings [SYSTEM] .....	72
■	Displaying the Instrument's Version Number (Version) .....	72
■	Changing the Display Language (Language) .....	73
■	Changing Screen Colors (Color) .....	73
■	Enable or Disable Beep Sounds (Beep) .....	74
■	Setting the LCD Backlight Timeout (Backlight) .....	74
■	Adjusting Screen Contrast (Contrast) .....	75
■	Setting the Clock (Clock) .....	76
■	Viewing the Serial No. ....	76
4.6	Initializing the Instrument (System Reset) .....	77

## **Chapter 5** **Making Connections and Starting & Stopping Measurement** \_\_\_\_\_ **79**

5.1	Pre-Operation Inspection .....	79
5.2	Connecting to the Lines to be Measured .....	81
5.3	Verifying Correct Wiring (Connection Check) .....	86
5.4	Starting and Stopping Recording .....	88
■	Starting and Stopping Recording Without Memory Partitioning (Partition: OFF) .....	89
■	Starting and Stopping Recording with Partitioned Memory (Partition: ON) .....	92
5.5	Erasing Data .....	93
5.6	Recovering From a Long-Term Power Outage .....	94

## **Chapter 6** **Viewing Data** \_\_\_\_\_ **95**

6.1	Viewing Instantaneous Data (VIEW Screen) .....	96
■	Holding the Screen Display..... (Common to all VIEW screens)	96
■	Viewing Waveforms [WAVEFORM] .....	97
■	Vector Display [VECTOR] .....	98
■	Displaying Harmonics [HARMONICS] .....	99
■	Displaying the DMM Screen (voltage, current and instantaneous power values)[DMM] .....	101
6.2	Displaying a Time Series Plot (TIME PLOT screen) 102	
■	Common Operations and Screen Items (Common to TIME PLOT screens) .....	102
■	Displaying the Rms Fluctuation Graph [RMS] .....	103
■	Displaying a Voltage Fluctuation Graph [DIP/SWELL] .....	105
■	Displaying a Demand Graph [DEMAND] .....	106

- Displaying an Energy Consumption Graph [ENERGY] ..... 107
- 6.3 Viewing Anomalous Phenomena (EVENT screen) . 108
  - Viewing the [RMS WAVE] Screen ..... 108
  - Viewing the [INRUSH] Screen ..... 109
  - Detection Methods and Recording Contents of Events ..... 110
  - Operations Common to the EVENT Screens ..... 114
  - Viewing Event Detection Details [DETAILS] ..... 117
  - Displaying Detected Event Waveforms [WAVEFORM] ..... 120
  - Displaying Detected Voltage Fluctuation Events [RMS WAVE] 121
  - Displaying Detected Inrush Current Events [INRUSH] ..... 122
- 6.4 Viewing Recorded Data ([REVIEW] State) ..... 123
  - Viewing Only Data Recorded in Memory Partition No. 1 ..... 123
  - Viewing Data Recorded in Multiple Memory Partitions ..... 124
  - Analyzing TIME PLOT data ..... 125
  - Analyzing EVENT data ..... 125

**Chapter 7**  
**Viewing Data on a Computer** \_\_\_\_\_ **127**

- 7.1 Overview ..... 127
  - PC System Requirements ..... 128
  - Files on the CD ..... 128
  - Preparing to Run the Application Programs ..... 129
  - Running the Application Programs ..... 129
- 7.2 Installing JRE ..... 130
- 7.3 Installing the Application Programs ..... 132
- 7.4 Connecting the Instrument and Computer with the Supplied USB Cable ..... 134
- 7.5 Starting the Instrument Application Programs ..... 138

**Chapter 8**  
**Specifications** \_\_\_\_\_ **139**

- 8.1 General Specifications ..... 139
- 8.2 Detailed Specifications of Measurement Parameters ..144
- 8.3 Event Specifications ..... 150
- 8.4 Function Specifications ..... 152
- 8.5 Calculation Formulas ..... 156

**Chapter 9**  
**Maintenance and Service** \_\_\_\_\_ **163**

---

9.1 Troubleshooting ..... 163

9.2 Cleaning ..... 165

9.3 Battery Pack Replacement and Disposal ..... 166

9.4 Disposing of the Instrument ..... 167

**Appendix** \_\_\_\_\_ **A1**

Appendix 1 Interval and Recording Time Settings ..... A1

Appendix 2 Relation Between Graph Divisions and Time ..... A5

Appendix 3 3197 Data-header Composition ..... A7

Appendix 4 Displayed and Measurement Ranges ..... A8

Appendix 5 Power Range Structure ..... A9

Appendix 6 Clamp Sensor Combined Accuracy ..... A10

Appendix 7 How to Resolve USB Data Transfer Problems ..... A11

Appendix 8 List of Settings (Default Settings) ..... A13

Appendix 9 Definitions ..... A14

- Detecting Anomalies and Phenomena Due to Drops in Power Quality ..... A14
- Power Measurement by the Two-Meter Method, and U3, I3 Measurement Theory ..... A16
- Terminology ..... A18

**Index** \_\_\_\_\_ **Index 1**







## Introduction

Thank you for purchasing the HIOKI Model 3197 Power Quality Analyzer. To obtain maximum performance from the instrument, please read this manual carefully, and keep it handy for future reference.

In this document, the “instrument” means the Model 3197 Power Quality Analyzer.

Optional clamp-on sensors (or clamp-on leakage sensors (p. 3)) are required to measure current with this instrument. These are called clamp sensors in the rest of this manual.

Refer to the manual provided with the clamp sensors for details.

### **Registered trademarks**

- Windows is a registered trademark of Microsoft Corporation in the United States and/or other countries.
  - Sun, Sun Microsystems and Java are trademarks or registered trademarks of Sun Microsystems, Inc. in the USA and other countries.
  - Adobe and Reader are either registered trademarks or trademarks of Adobe Systems Incorporated in the United States and/or other countries.
-

# Confirming Package Contents

When you receive the instrument, inspect it carefully to ensure that no damage occurred during shipping. In particular, check the accessories, panel switches, and connectors. If damage is evident, or if it fails to operate according to the specifications, contact your dealer or Hioki representative.

## Confirm that these contents are provided.

### Accessories

- Model 3197 Power Quality Analyzer



- Instruction Manual..... 1



- Measurement Guide ..... 1



- PC application program for Model 3197 (CD) ..... 1



- 9418-15 AC Adapter (AC power cord included)..... 1



- 9459 Battery Pack ..... 1



- L9438-55 Voltage Cord (Four black voltage cords)..... 1 set



- USB Cable ..... 1



- Carrying Case..... 1

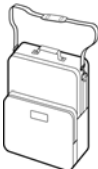

### Install these on the instrument before operating (p. 37)

- Measurement lead labels.....1 sheet  
(For channel identification of the voltage measurement and clamp sensor leads)

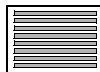

(p. 38)

- Input terminal labels .....1 sheet  
(Apply the appropriate labels around the input terminals according to usage)

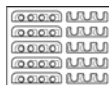

(p. 37)

- Strap ..... 1

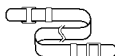



(p. 38)

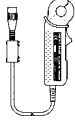
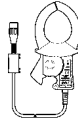
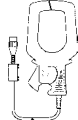
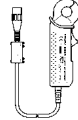

### Options

For the details, contact your supplier or Hioki representative for details.

Clamp-On Sensor Products (voltage-output type)

Clamp-On Sensors	9660	9661	9669	9694	9695-02	9695-03
(Arms current rating)						
	100	500	1000	5	50	100

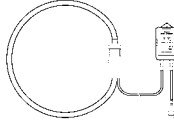
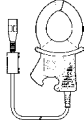
Accessory: Model 9219 Connection Cable (for Models 9695-02 and -03)

Flexible Clamp-On Sensors	9667	Clamp-On Leakage Sensors (for measuring leakage current)	9657-10	9675
(Arms current rating)		(Arms current rating)		
	500, 5000		10	10

### Software (PC application programs)

For computer analysis of measurement data

9624-50 PQA-HiVIEW PRO

### Power Sources

9418-15 AC Adapter (includes power cord)

9459 Battery Pack

## Safety Information



This instrument is designed to comply with IEC 61010 Safety Standards, and has been thoroughly tested for safety prior to shipment. However, mishandling during use could result in injury or death, as well as damage to the instrument. However, using the instrument in a way not described in this manual may negate the provided safety features.

Be certain that you understand the instructions and precautions in the manual before use. We disclaim any responsibility for accidents or injuries not resulting directly from instrument defects.

This manual contains information and warnings essential for safe operation of the instrument and for maintaining it in safe operating condition. Before using it, be sure to carefully read the following safety precautions.



## Safety Symbols

	In the manual, the  symbol indicates particularly important information that the user should read before using the instrument.
	The  symbol printed on the instrument indicates that the user should refer to a corresponding topic in the manual (marked with the  symbol) before using the relevant function.
	Indicates DC (Direct Current).
	Indicates AC (Alternating Current).
	Indicates a grounding terminal.
	Indicates the ON side of the power switch.
	Indicates the OFF side of the power switch.

The following symbols in this manual indicate the relative importance of cautions and warnings.

	Indicates that incorrect operation presents an extreme hazard that could result in serious injury or death to the user.
	Indicates that incorrect operation presents a significant hazard that could result in serious injury or death to the user.
	Indicates that incorrect operation presents a possibility of injury to the user or damage to the instrument.
	Indicates advisory items related to performance or correct operation of the instrument.

## Other Symbols

	Indicates the prohibited action.
(p. )	Indicates the location of reference information.
	Indicates quick references for operation and remedies for troubleshooting.
*	Indicates that descriptive information is provided below.
[ ]	Screen labels such as menu items, setting items, dialog titles and buttons are indicated by square brackets [ ].
<b>SET</b> (Bold)	Bold characters within the text indicate operating key labels.

Unless otherwise specified, "Windows" represents Windows 95, 98, Me, Windows NT4.0, Windows 2000, or Windows XP.

## Accuracy

We define measurement tolerances in terms of f.s. (full scale), rdg. (reading) and dgt. (digit) values, with the following meanings:

- f.s. (maximum display value or scale length)  
The maximum displayable value or scale length. This is usually the name of the currently selected range.
- rdg. (reading or displayed value)  
The value currently being measured and indicated on the measuring instrument.

**Measurement categories**

This instrument complies with CAT III (600 V) and CAT IV (300 V) safety requirements.

To ensure safe operation of measurement instruments, IEC 61010 establishes safety standards for various electrical environments, categorized as CAT II to CAT IV, and called measurement categories. These are defined as follows.

**CAT II:** Primary electrical circuits in equipment connected to an AC electrical outlet by a power cord (portable tools, household appliances, etc.)

CAT II covers directly measuring electrical outlet receptacles.

**CAT III:** Primary electrical circuits of heavy equipment (fixed installations) connected directly to the distribution panel, and feeders from the distribution panel to outlets.

**CAT IV:** The circuit from the service drop to the service entrance, and to the power meter and primary overcurrent protection device (distribution panel).

Using a measurement instrument in an environment designated with a higher-numbered category than that for which the instrument is rated could result in a severe accident, and must be carefully avoided.

Use of a measurement instrument that is not CAT-rated in CAT II to CAT IV measurement applications could result in a severe accident, and must be carefully avoided.

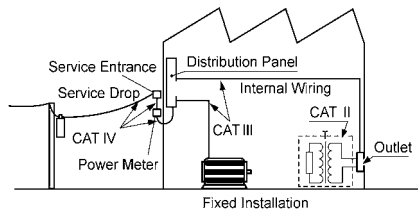

## Operating Precautions

Follow these precautions to ensure safe operation and to obtain the full benefits of the various functions.

### Before Use

- Before using the instrument the first time, verify that it operates normally to ensure that no damage occurred during storage or shipping. If you find any damage, contact your dealer or Hioki representative.
- Before using the instrument, make sure that the insulation on the L9438-55 Voltage Cord and clamp sensor leads is undamaged, and that no bare conductors are improperly exposed. Using the instrument in such conditions could cause an electric shock, so contact your dealer or Hioki representative for replacements.

### Instrument Installation

- Operating temperature and humidity:  
0 to 40°C at 80% RH or less (non-condensating)
- Temperature and humidity range for guaranteed accuracy:  
23±5°C, 80%RH or less

Avoid the following locations that could cause an accident or damage to the instrument.



Exposed to direct sunlight  
Exposed to high temperature



In the presence of corrosive or explosive gases



Exposed to liquids  
Exposed to high humidity or condensation



Exposed to strong electromagnetic fields  
Near electromagnetic radiators



Exposed to high levels of particulate dust



Subject to vibration

### Placement

Do not place the instrument on an unstable or slanted surface.

#### Using without the stand

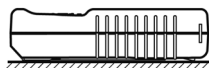

#### Using with the stand

**See:** "Opening and closing the stand" (p. 26)

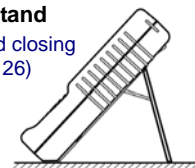

**Handling the Instrument**

- Do not allow the instrument to get wet, and do not take measurements with wet hands. This may cause an electric shock.
- Never modify the instrument. Only Hioki service engineers should disassemble or repair the instrument. Failure to observe these precautions may result in fire, electric shock, or injury.
- To avoid electric shock when measuring live lines, wear appropriate protective gear, such as insulated rubber gloves, boots and a safety helmet.



To avoid damage to the instrument, protect it from physical shock when transporting and handling. Be especially careful to avoid physical shock from dropping.



This instrument may cause interference if used in residential areas. Such use must be avoided unless the user takes special measures to reduce electromagnetic emissions to prevent interference to the reception of radio and television broadcasts.

**Handling the cords and clamps**

Connect the clamp-on sensors or voltage cords to the instrument first, and then to the active lines to be measured. Observe the following to avoid electric shock and short circuits.

- To avoid short circuits and potentially life-threatening hazards, never attach the clamp to a circuit that operates at more than the maximum rated voltage to earth (9660: 300 VAC, 9661: 600 VAC, 9667: 1000 VAC, 9669: 600 VAC, 9694:300 VAC), or over bare conductors.

Maximum rated voltage to earth	Clamp sensors
AC1000 V	9667
AC600 V	9661, 9669
AC300 V	9660, 9694, 9695-02, 9695-03, 9657-10, 9675

- Clamp sensor and voltage cords should only be connected to the secondary side of a breaker, so the breaker can prevent an accident if a short circuit occurs. Connections should never be made to the primary side of a breaker, because unrestricted current flow could cause a serious accident if a short circuit occurs.
- Do not allow the voltage cord clips to touch two wires at the same time. Never touch the edge of the metal clips.
- Use only the supplied L9438-55 Voltage Cord to connect the product input terminals to the circuit to be tested.
- When the clamp sensor is opened, do not allow the metal part of the clamp to touch any exposed metal, or to short between two lines, and do not use over bare conductors.



**CAUTION**

- Avoid stepping on or pinching cables, which could damage the cable insulation.
- To avoid breaking the cables, do not bend or pull them.
- To avoid damaging the power cord, grasp the plug, not the cord, when unplugging it from the power outlet.
- Keep the cables well away from heat sources, as bare conductors could be exposed if the insulation melts.
- Be careful to avoid dropping the clamps or otherwise subjecting them to mechanical shock, which could damage the mating surfaces of the core and adversely affect measurement.
- Be careful when handling the cords, since the conductor being measured may become very hot.
- When disconnecting the BNC connector, be sure to release the lock before pulling off the connector. Forcibly pulling the connector without releasing the lock, or pulling on the cable, can damage the connector.

**Before Turning Power On****WARNING****Battery Pack Operation**

- For battery operation, use only the HIOKI Model 9459 Battery Pack. We cannot accept responsibility for accidents or damage related to the use of any other batteries.

**See:** "Charge the 9459 Battery Pack"(p. 40)  
"9.3 Battery Pack Replacement and Disposal" (p. 166)

**AC Adapter Operation**

- Use only the supplied Model 9418-15 AC Adapter. AC adapter input voltage range is 100 to 240 VAC (with  $\pm 10\%$  stability) at 50/60 Hz. To avoid electrical hazards and damage to the instrument, do not apply voltage outside of this range.
- Turn the instrument off before connecting the AC adapter to the instrument and to AC power.
- To avoid electrical accidents and to maintain the safety specifications of this instrument, connect the power cord only to a 3-contact (two-conductor + ground) outlet.
- Before turning the instrument on, make sure the supply voltage matches that indicated on the its power connector. Connection to an improper supply voltage may damage the instrument and present an electrical hazard.

**See:** "3.2 Connecting the AC Adapter" (p. 41)

**Input and Measurement Precautions**

- The maximum input voltage is as follows:  
Voltage input section: 780 Vrms, 1103 V peak. Current input section: 1.7 Vrms, 2.4 V peak  
Attempting to measure voltage in excess of the maximum input could destroy the instrument and result in personal injury or death.
- The maximum rated voltage between the inputs and ground is 600 Vrms AC. To avoid damage to the instrument and personal injury, never attempt to measure voltage that exceeds this rated voltage above ground.



- The voltage input terminals U1, U2, and U3 are not isolated from one another.  
To avoid electric shock accidents, use care to prevent wires from inadvertently touching the wrong input terminals whenever voltage is present.
- Note that the instrument may be damaged if current or voltage exceeding the selected measurement range is applied for a long time
- When the power is turned off, do not apply voltage or current to the voltage input terminals or clamp sensor. Doing so may damage the product.
- To prevent damage to the instrument and sensor, never connect or disconnect a sensor while the power is on, or while the sensor is clamped around a conductor.



Correct measurement may be impossible in the presence of strong magnetic fields, such as near transformers and high-current conductors, or in the presence of strong electromagnetic fields such as near radio transmitters.

**Measurement values**

- To ensure measurements are precise, warm up the instrument for at least 30 minutes after plugging it in.
- This instrument is designed to measure commercial power lines with a frequency of 50 or 60 Hz. It cannot measure power lines of other frequencies or power lines where the waveforms are controlled using an inverter.
- This instrument cannot measure power lines with superposed direct current.
- This instrument uses algorithms to measure values for input voltage and current waveforms using (see the specifications). On device using different operation principles or algorithms differ, differences in measurement values may result.
- When the display value for voltage or current is less than 1% of the range, zero is displayed.

## Using VT and CT

### NOTE

- When the voltage or current for the power line being measured exceeds the maximum rated input for this device, use an external PT or CT.
- When using an external PT or CT, make sure you use a device with a minimal phase difference. By setting the PT or CT ratio, you can read measurement values directly.

## Instrument Storage

- The storage temperature range is -10 to 50°C at relative humidity not exceeding 80%.
- The battery pack should be removed when the instrument is stored. Store the battery pack in a cool place.
- The instrument should be recalibrated before use after long-term storage.

## CD Handling

### CAUTION

- Always hold the disc by the edges, so as not to make fingerprints on the disc or scratch the printing.
- Never touch the recorded side of the disc. Do not place the disc directly on anything hard.
- Do not wet the disc with volatile alcohol or water, as there is a possibility of the label printing disappearing.
- To write on the disc label surface, use a spirit-based felt pen. Do not use a ball-point pen or hard-tipped pen, because there is a danger of scratching the surface and corrupting the data. Do not use adhesive labels.
- Do not expose the disc directly to the sun's rays, or keep it in conditions of high temperature or humidity, as there is a danger of warping, with consequent loss of data.
- To remove dirt, dust, or fingerprints from the disc, wipe with a dry cloth, or use a CD cleaner. Always wipe radially from the inside to the outside, and do not wipe with circular movements. Never use abrasives or solvent cleaners.
- Hioki shall not be held liable for any problems with a computer system that arises from the use of this CD, or for any problem related to the purchase of a Hioki product.



# Overview

# Chapter 1

1

## 1.1 Product Overview

**The 3197 Power Quality Analyzer is a measurement instrument designed to detect power line anomalies and to analyze the power quality of power lines.**

Power lines can be monitored and recorded for anomalies over long periods, and the causes of anomalies can be analyzed by comparing measurements with particular standard characteristics. In addition, utilizing remote computer control, abnormal events at a remote site can be noticed as soon as they occur. Measurement data recorded in internal memory can be transferred to a computer for analysis by PC application program for Model 3197.

### Power Quality Deterioration

Flickering light bulbs, short bulb life, malfunctioning office machines, intermittent device operation, overheating of equipment with capacitively compensated reactance, overloads, opposite- and missing-phase relays sometimes occur.

Connect the instrument to the lines to be measured.

Verify the vectors and waveforms of three-phase power sources.

Three-phase voltage/  
current waveform and  
vector displays

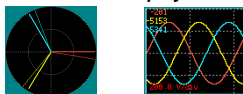

Observe voltage fluctuations of commercial power and determine the occurrence of events.

Power quality measurement

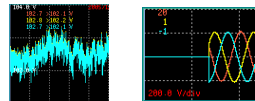

Verify energy consumption and load demand at distribution panels.

Energy consumption and  
demand measurement

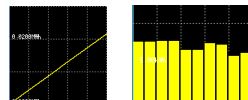

Verify inrush current, such as upon motor startup.

Inrush current measurement

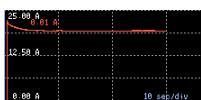

Verify conditions of harmonic power and distortion

Harmonic measurement

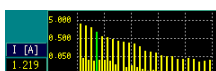

Capture images of measurement conditions.

Display screens can be captured as BMP files (p. 52).

Remote Control

The instrument can be remotely controlled by a computer using the supplied USB cable and special-purpose PC application programs.

Data transfer and analysis

Transfer data to a computer connected to the instrument by USB cable, and view measurement data using the supplied PC application program for Model 3197 (p. 127).

Optional analytical application programs are also available for precise data analysis.

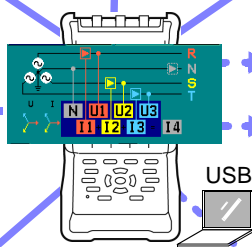

## 1.2 Features

### ◆ Supports various power line wiring configurations

Measures three channels of voltage and current.

With just one instrument, measure voltage, current and power on single-phase 2-wire, single-phase 3-wire, three-phase 3-wire and three-phase 4-wire systems.

Neutral current in three-phase 4-wire systems is available by calculation.

### ◆ Vector multi-meter function

Measurement line wiring connections can be checked from the initial screen.

Verify phase detection (vector check), measure voltage and current, and check for miswired connections on a single screen.

### ◆ Basic Setup

Use "Basic Setup" to configure settings for the wiring configuration connections and the clamp sensors to be used. Standard line frequencies and voltages are detected and set automatically. The default settings can be used for detecting typical events.

### ◆ Automatic data recording compression function

This function begins recording at one-second intervals and automatically lengthens the recording interval to up to an hour as internal memory fills. This function helps to ensure that suitable data quantities are acquired for analysis, whether the overall measurement period is short or long. This function supports continuous measurement sessions of up to about 125 days.

### ◆ Broad selection of clamp sensors

Select from our present line of voltage-output type clamp sensors

- Clamp-on sensor Models 9660, 9661, 9669, 9694, 9695-02, 9695-03
  - Clamp-on leak sensor Models 9657-10, 9675
  - Flexible clamp-on sensor Model 9667
-

### ◆ Simultaneous measurement of various power quality parameters

The following power quality parameters can be simultaneously measured and recorded.

- Transient overvoltage (impulse)
- Voltage swells, voltage dips, interruptions, frequency, voltage, voltage waveform peaks, current, current waveform peaks, active power, apparent power, reactive power, power factor, displacement power factor, voltage unbalance factor, harmonic voltage, harmonic current, harmonic power, fundamental voltage phase difference, fundamental current phase difference, total harmonic voltage distortion factor (THD-F), K factor, active power value, reactive power value, active power demand, reactive power demand

**See:** "Detecting Anomalies and Phenomena Due to Drops in Power Quality" (p. A14)

### ◆ Display time series plots of rms values and voltage fluctuations

Record and display fluctuations in various power quality parameters as a time series plot.

Display and record calculated maximum, average and minimum values during each measurement interval.

Rms voltage is calculated for one waveform shifted by half of a cycle, and is recorded and displayed as a time series plot of voltage fluctuations to detect voltage swell, voltage dip and interruption events.

### ◆ Measure demand and energy consumption

Measure polarity-specific demand parameters such as consumption, regeneration, lag, lead and energy consumption. Demand and energy consumption can be verified on a time series plot.

### ◆ Event detection function

Set thresholds at which to detect and record events while measuring.

Detected events can be analyzed using the event monitor, event list or event waveform display.

Event detection is available for voltage swells, voltage dips (instantaneous dips), interruptions, inrush current, transient overvoltage, timed and manually triggered events.

### ◆ Measure inrush current

Measure motor startup current. Rms current is recorded for 30 seconds and displayed graphically.

### ◆ Internal memory with backup battery preserves recorded measurement data

Measurement data is recorded into the 4 MB internal memory and retained by a lithium-ion battery that should not require replacement for about 10 years. So data is preserved even during power outages.

◆ **Color LCD included**

The instrument includes a 4.7-inch color STN liquid crystal display. Numerical values, waveforms and graphs are clearly displayed.

◆ **Selectable display languages**

Select English, Chinese, Japanese, or other language display text. Help messages describing the settings appear in the selected language

◆ **Selectable channel (input terminal) colors**

Select from five channel color schemes.

Match the screen display colors (waveforms, vectors and numerical values) to the input terminal and measurement lead labels.

◆ **AC adapter and rechargeable battery pack included**

The AC adapter and NiMH rechargeable battery pack are included as standard accessories. The battery can be charged whether the instrument is turned on or off, and powers the instrument for up to six hours of continuous operation.

◆ **Hand-held design**

The instrument weighs only 1.2 kg, and the rubber grip makes it comfortably hand portable.

◆ **USB 2.0 interface and PC application program for Model 3197 are included**

The instrument can be remotely controlled, and data can be transferred and analyzed on a computer using the supplied USB cable and special-purpose PC application programs.

◆ **Detect wiring connections**

Detection of phases, disconnected voltage cords and reverse-connected clamp sensors can be determined from the Wiring Confirmation screen, so miswiring can be avoided when measuring.

◆ **Optional data analysis application programs**

Detailed analysis of measurement data recorded by the instrument is available with the optional Model 9624-50 PQA-HiView PRO data analysis application programs.

---



## 1.3 Measurement Flowchart

### First Steps Upon Unpacking

See: 3.1 (p. 37)

Flow process descriptions are also on page 19 to page 21 .

1

### Install & Connect

See: "Instrument Installation" (p. A7)

3.2 (p. 41)

3.3 (p. 42)

3.4 (p. 44)

3.5 (p. 46)

Install the  
instrument

Connect the  
instrument cables

Turn power on

### Make Instrument Settings

See: Chapter 4 (p. 53)

#### Basic Setup

Execute Basic Setup to configure minimal settings such as the wiring configuration for recording measurements.

#### Advanced Setup (to change settings)

Make settings as needed to change threshold levels or to specify recording times.

### Confirm Measurement Connections

See: 5.2 (p. 81), 5.3 (p. 86)

On the screen, verify that the instrument is properly connected to the lines to be measured (SYSTEM) (Wiring Confirmation screen).

### Measure instaneous data without recording

VIEW

When finished ⇒ Turn power off

### Measure

See: 5.4 (p. 88)

Manual recording

START  
STOP

Time controlled  
recording

Measure automatically at preset start time

### Finish

See: 5.4 (p. 88)

START  
STOP

Stop automatically at preset stop time  
To immediately stop measuring

Go to the next page.

Analyze Recording Data

See: Chapter 6 (p. 95)

View data on the instrument

View instaneous data

VIEW

View recorded time series data

TIME PLOT

View recorded anomaly waveforms

EVENT

View data on a computer

Connect the instrument to a computer using the supplied USB cable. Then using the supplied PC application program for Model 3197, transfer recorded data for analysis.

Finish

Turn the power off

---

## 1 Initial instrument preparations

- ❑ Apply the appropriate label to the input terminals (p. 37)
- ❑ Apply the appropriate labels to the voltage measurement and clamp sensor leads (p. 38)
- ❑ Attach the strap (p. 38)
- ❑ Install the 9459 Battery Pack (p. 39), and charge it (p. 40).

## 2 Install and connect the instrument, and turn the power on

### 1 Install this instrument (p. 7)

Refer to "5.1 Pre-Operation Inspection" (p. 79) before using the instrument.

### 2 Connect the required measurement leads to the voltage input terminals (p. 42).



### 3 Connect the required clamp sensors to the current input terminals (p. 44).



### 4 Connect the power cord. (p. 41)

1. Connect power cord to the AC adapter.
2. Plug the AC adapter into the instrument.
3. Connect the power cord to a power outlet.

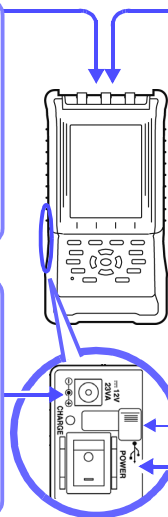

#### To use a computer

Connect the USB cable to the USB port on the instrument. (p. 134)

### 5 Turn the power on (p. 46).

- OFF  
 ON



The POWER LED flashes.

## 3 Other preparations

- ❑ Select another display language (p. 47)
- ❑ Select the screen color scheme to match the input terminal labels (p. 48)
- ❑ Select the naming convention to be applied to each phase line measurement on the display (p. 49)

## 4 Confirming Instrument Settings and Connecting to the Lines to be Measured

### SYSTEM



1

**Make the required settings before connecting (p. 57).**

Select the appropriate wiring configuration and clamp sensor model settings.

2

**Select the appropriate wiring configuration and clamp sensor model settings (p. 81).**

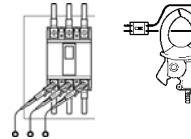

3

**Confirm the correct connection status (p. 86).**

Confirm measurement values and vector display.

4

**Basic Setup measurement values and vector display**

**Advanced Setup Make the appropriate settings for measurement as occasion demands (p. 53).**



Press **(F1)** to select Basic Setup, and press **(ENTER)** to execute (p. 54).

Set measurement and recording conditions such as the recording method (memory partitioning and interval) and event settings.

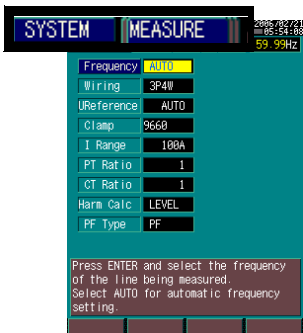

Press ENTER and select the frequency of the line being measured. Select AUTO for automatic frequency setting.

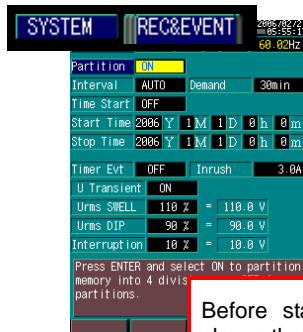

Press ENTER and select ON to partition memory into 4 divisions partitions.

Before starting recording, confirm that the instrument's clock shows the correct time. If not, set the clock (p. 76).

Note that correct clock setting is especially important when recording start and end times are specified.

## 5 Start recording and analyze recorded measurement data.

### Starting and stopping measurement by key presses

Start recording measurements



[RECORDING]

Stop recording measurements



### Recording measurements at a specified time

Set the timers beforehand (p. 66)

Start Time Stop Time



[WAITING]

[RECORDING]

- Settings cannot be changed while recording. To change a setting, first press the **START/STOP** key to stop measuring.
- When you press the **START/STOP** key while recording, a confirmation message asks whether you want to temporarily stop recording. Press the **ENTER** key to stop the measurement.
- Enable the KEY LOCK function to avoid inadvertent key operations while recording. (p. 51)
- To restart, press the **DATA RESET** key.

### Analyze instaneous measurement data

Viewing instaneous data (p. 29)

VIEW

Analysis can be performed during or after recording

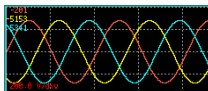

### Analyze recorded measurement data

Viewing changes over time (time series data) (p. 30)

TIME PLOT

Analysis can be performed in the same way during or after recording

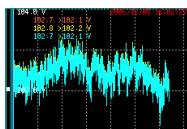

Select views of trends, demand and energy consumption.

Viewing data anomalies (when an event occurs) (p. 31)

EVENT

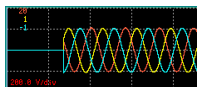

Verify detailed event waveforms, graphs and the number of occurrences.

View on a computer

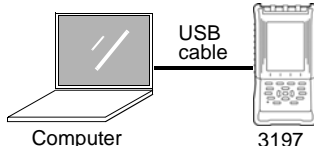

Using remote control

Transfer data  
Analyze data  
(p. 127)

See the references for details



# Names and Functions of Parts and Basic Setup **Chapter 2**

## 2.1 Panel and Operating Keys

2

### Front Panel

**Display Screen**  
4.7-inch STN color  
LCD

**Operating Keys**  
(p. 25)

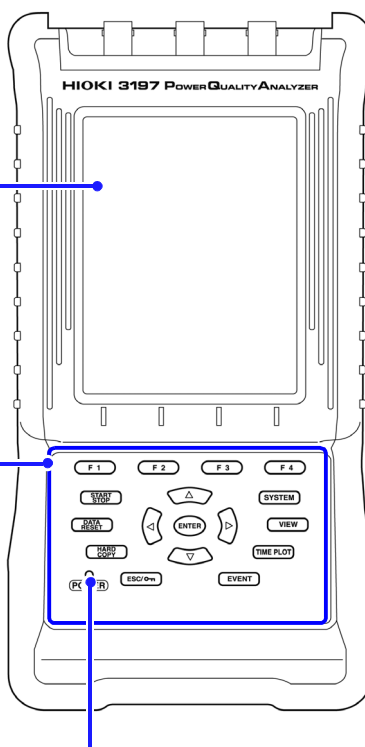

#### **POWER LED (green)**

This LED flashes when the power switch is on, operating from the AC adapter or battery. The flashing state depends on the operating conditions. (p. 46)

2.1 Panel and Operating Keys

Left Side

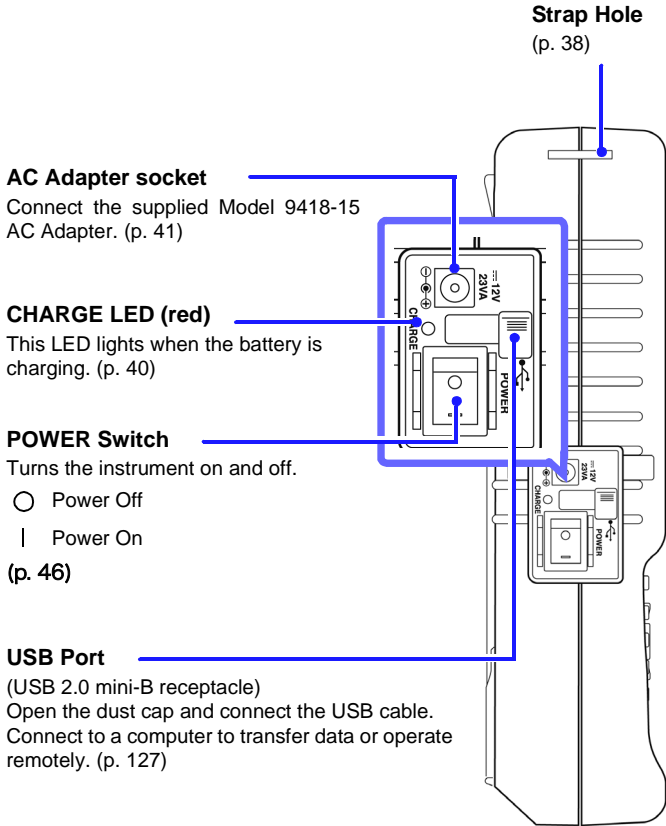

Top Panel

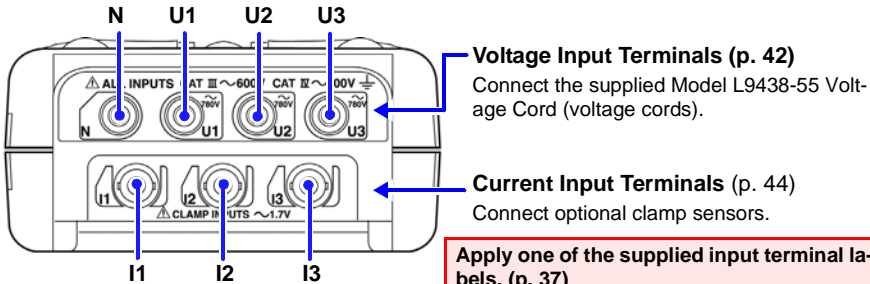

Apply one of the supplied input terminal labels. (p. 37)  
Attach the corresponding labels to the clamp sensor and voltage cords. (p. 38)



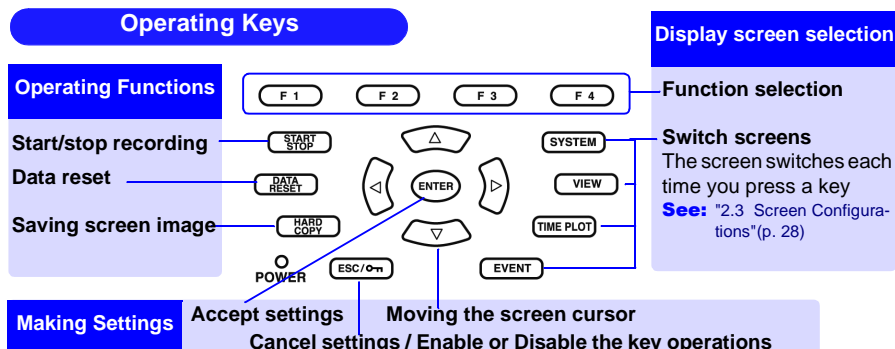

2

	<b>Function keys</b>	Selects from the functions displayed along the bottom of the screen. Displayed functions depend on the selected screen.
	<b>SYSTEM key</b>	Displays the SYSTEM screen for setting instrument measurement status and checking connections. (p. 28)
	<b>VIEW key</b>	Displays the VIEW screen to show measured data in waveform, vector, harmonics or DMM views. (p. 29)
	<b>TIME PLOT key</b>	Displays the TIME PLOT screen for analyzing measurement data fluctuations as a time series plot. (p. 30)
	<b>EVENT key</b>	Displays the EVENT screen for analyzing data when an event occurs. (p. 31)
	<b>Cursor keys</b>	These keys move the cursor on the screen, and scroll time series graphs.
	<b>ENTER key</b>	Accepts and applies selections and changed settings.
	<b>ESC / KEY LOCK key</b>	Cancels selections and changed settings and reverts to the original settings. KEY LOCK (disables the operating keys): hold for three seconds to lock or unlock the keys. (p. 51)
	<b>START / STOP key</b>	Starts and stops recording (p. 33) To restart recording: Press the <b>DATA RESET</b> key to clear the data, then press this key.
	<b>DATA RESET key</b>	Press this key to return to the <b>[SET]</b> state from the <b>[ANALYZE]</b> state. (p. 34)
	<b>HARD COPY (Screen shot) key</b>	Saves the screen image as a bitmap (BMP format) file in internal memory. (p. 52)

**Rear Panel**

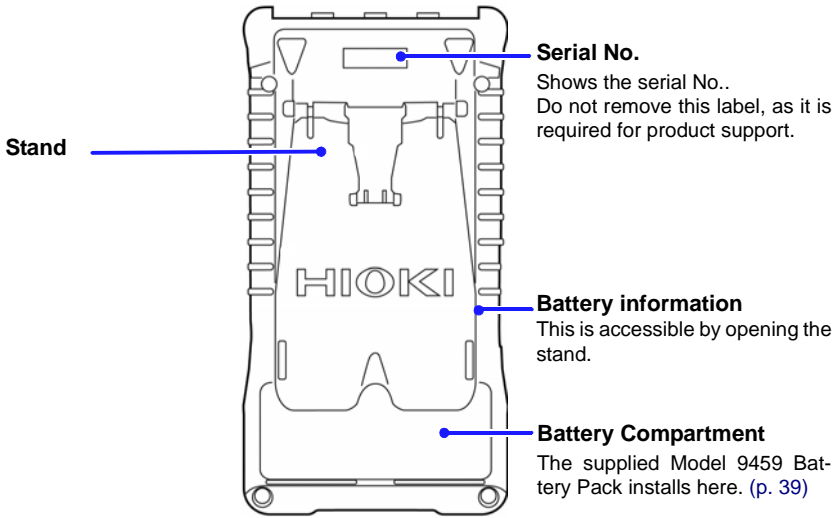

**Opening and closing the stand**

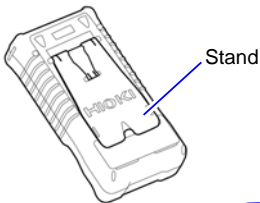

**CAUTION**

Do not apply heavy downward pressure with the stand extended. The stand could be damaged.

**1 Opening the stand**



**1.** Pull the stand out until it clicks.

**2 Closing the stand**

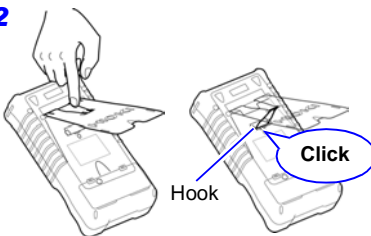

**2.** Push the stand holder in until it clicks in the hook on the rear cover.

**Closing the stand**  
Return the stand holder to its original position, and close the stand until it clicks.

## 2.2 Basic Operations

### Switching Screens

The screen switches every time you press the **SYSTEM**, **VIEW**, **TIMEPLOT**, or **EVENT** key.

Screen Type	Display Contents			
	System	WIRING	MEASURE	REC&EVENT
View	WAVEFORM	VECTOR	HARMONICS	DMM
Time Plot	RMS	DIP/SWELL	DEMAND	ENERGY
Event	WAVEFORM	DETAIL	RMS WAVE	INRUSH

2

SYSTEM MEASURE

USB 2005.782721  
05:54:38

3E1 11.2W 300R 120V 59.99Hz

Frequency AUTO  
Wiring 1P2W  
UReference 120V  
Clamp 9661  
I Range 500A  
PT Ratio 1  
CT Ratio 1  
Harm Calc LEVEL  
PF Type PF

Press ENTER and select the frequency of the line being measured. Select AUTO for automatic frequency setting.

### Settings

Frequency AUTO  
Wiring 1P2W  
UReference 120V  
Clamp 9661

Frequency AUTO  
Wiring 1P2W  
UReference 1P2W  
Clamp 1P3W  
I Range 3P3W3M  
PT Ratio 3P4W  
CT Ratio 1

Frequency AUTO  
Wiring 3P4W  
UReference 120V

**Move between items to change settings**

**Opens pull-down menus**

**Selects from the menu**

**Accepts the setting**

**Cancels the setting**

### Function key usage



Display differs depending on the screen type.

### Help Comment

Shows a description of the item at the cursor position on the SYSTEM screen.

**NOTE**

Voltage fluctuation and inrush current screens can be displayed when data is present.

## 2.3 Screen Configurations

### SYSTEM (Setting Conditions and System Settings)

Make the necessary settings before measuring.

The displayed screen changes each time you press **SYSTEM**

The [WIRING] screen displays a three-phase wiring diagram with terminals labeled U1, U2, U3, I1, I2, I3, I4. Below the diagram are two circular vector displays for voltage and current. At the bottom, a table shows measurement data:

U1	120.0 V	I1	5.010 A	Psum	1.68kW
U2	120.0 V	I2	5.006 A	Uunb	0.2 %
U3	120.1 V	I3	5.008 A	I4	0.000 A

Labels on the right side of the screen indicate 'Correct Wiring Diagram' and 'Connection Check'.

View the selected system wiring diagram while connecting the voltage cords and clamp sensors. Three-phase vectors and voltage, current and power values can be verified. (p. 86)

The [MEASURE] screen shows various measurement parameters:

- Frequency: AUTO
- Wiring: 3P4W
- UReference: AUTO
- Clamp: 9660
- I Range: 100A
- PT Ratio: 1
- CT Ratio: 1
- Harm Calc: LEVEL
- PF Type: PF

A note at the bottom states: 'Press ENTER and select the frequency of the line being measured. Select AUTO for automatic frequency setting.'

Make basic settings for measurement. You can set the measurement frequency, wiring configuration, clamp sensor model, current range, PT and CT ratios.

The [SYSTEM] screen displays system configuration options:

- Version: V 1.00
- Language: English
- Line Type: R S T
- Color: COLOR 1
- Beep: ON
- Backlight: AlwaysOn
- Contrast: +0
- Clock: 2006 Y 2 M 21 D 5 h 58 m
- System Reset

A note at the bottom says: 'Press ENTER to adjust the display language.'

Make instrument-related system settings such as display language, beep sounds, screen colors, LCD backlight, LCD contrast, real-time clock, phase names and phase colors. The instrument's version and serial No. are also displayed.

The [REC&EVENT] screen shows recording and event settings:

- Partition: 01
- Interval: AUTO
- Time Start: OFF
- Start Time: 2006 Y 1 M 1 D 0 h 0 m
- Stop Time: 2006 Y 1 M 1 D 0 h 0 m
- Timer Evt: OFF
- U Transient: ON
- Urms SWELL: 110 % = 110.0 V
- Urms DIP: 90 % = 90.0 V
- Interruption: 10 % = 10.0 V

Labels on the right side of the screen indicate 'Recording Settings' and 'Event Settings'.

Make recording-related settings here. You can set memory partitioning, recording interval, demand period, and enable/disable status and threshold values for each type of event.

VIEW

(View Measurement Results)

Shows instantaneous measurement results.

The displayed screen changes each time you press



[WAVEFORM]

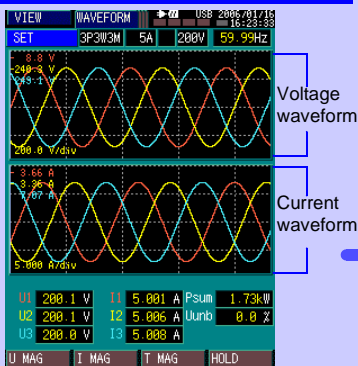

Voltage waveform  
Current waveform

This screen displays voltage and current waveforms, and numerical voltage amplitudes, current amplitudes and the time axis setting. Cursor values can be displayed, and screen refreshing can be paused by the HOLD function.

[VECTOR]

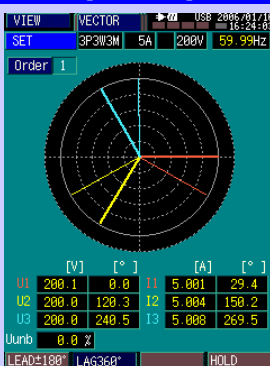

This screen displays a voltage and current vector diagram. Voltage amplitudes, current amplitudes and phase angles are displayed numerically. Phase angle display can be switched  $\pm 180^\circ$  leading or  $360^\circ$  lagging. Screen refreshing can be paused by the HOLD function.

[DMM]

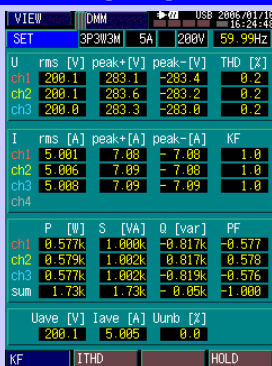

This screen displays the following numerical measurement results for each measurement channel: voltage and voltage waveform peak values, THD value, current and current waveform peak values, K factor, active power, apparent power, reactive power and power factor.

[HARMONICS]

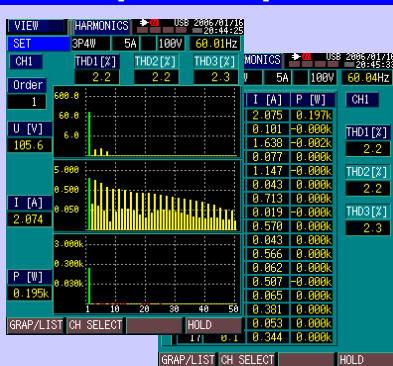

This screen displays the results of harmonic waveform measurements of voltage, current and active power to the 50th order. The function keys switch between bar graph and numerical value list displays.

2

2.3 Screen Configurations

TIME PLOT (Viewing Time Series Graphs)

Displays recording state and recorded results as a fluctuation graph.

The displayed screen changes each time you press **TIME PLOT**

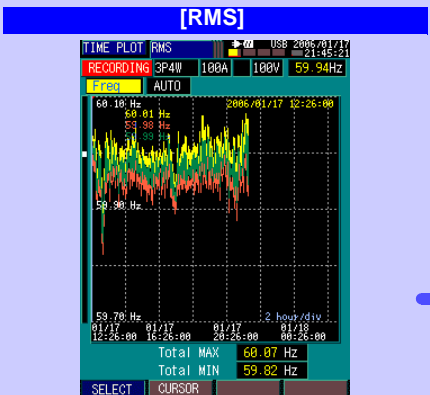

Various calculated rms values are displayed in a time series graph with maximum, minimum and average values during every interval. Displayed parameters can be selected from voltage; current; voltage and current peak values; frequency; active, reactive and apparent power; power factor; THD and voltage unbalance factor.

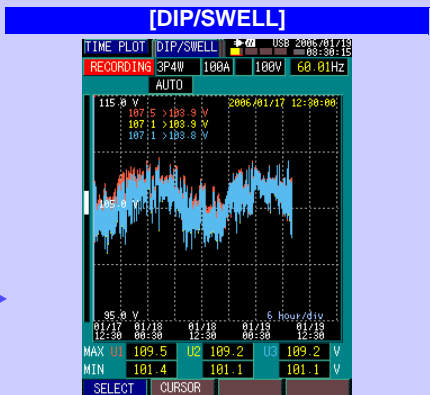

Calculated rms voltage for one waveform shifted by one-half cycle is displayed as a time series graph. Minimum and maximum values within each period and over the whole measurement period are displayed.

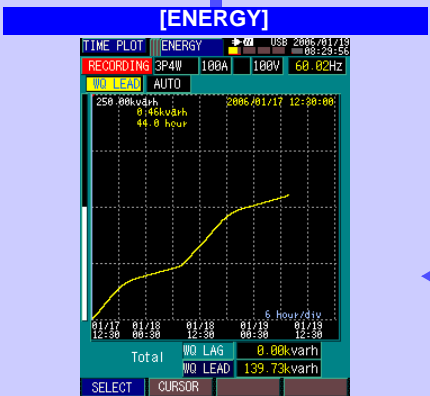

Energy consumption values of active power [kWh] or reactive power [kvarh] are displayed as a time series graph. Energy consumption values for consumption/regeneration and lag/lead can be displayed.

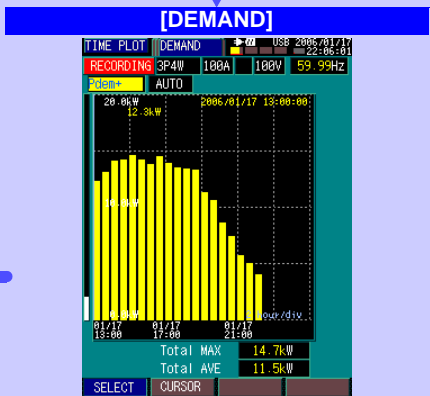

Graphically displays demand values (the average power [kW] consumed during the "demand period" used in power company transactions) for each specified demand period. The maximum value within each period (maximum demand power) and average value within each period and over the whole measurement period are also displayed.

## EVENT

## (Viewing Anomalous Events)

Displays power anomaly detection results.

The displayed screen changes each time you press **EVENT**

## [WAVEFORM]

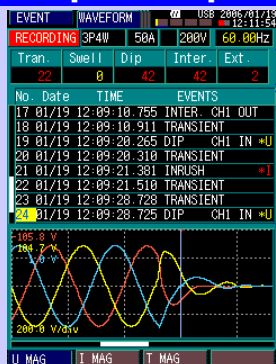

Event Monitor

Event List

Event occurrences are monitored and contents displayed in a list. The Event Monitor shows the number of occurrences of each type of event. Use the cursor keys to select event waveforms from the list for display. Use the function keys to switch between voltage and current waveforms.

## [DETAIL]

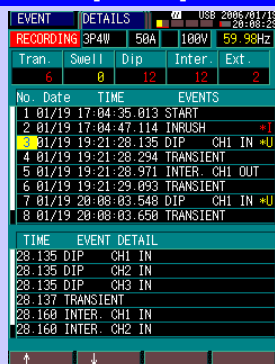

Each row of the Event List may include multiple events, in which case the details of the event contents are displayed in order of occurrence in the Event Detail display.

## [INTRUSH]

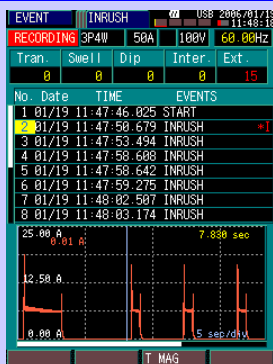

When an inrush current event has occurred, a graph showing details of rms current fluctuations appears.

## [RMS WAVE]

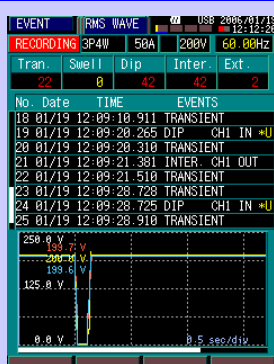

When a swell, dip or interruption event has occurred, a graph showing details of rms voltage fluctuations appears.

**NOTE**

Voltage fluctuation and inrush current screens can be displayed when data is present.

## 2.4 Common Screen Elements

### Common Display Area

This area appears on all screens.

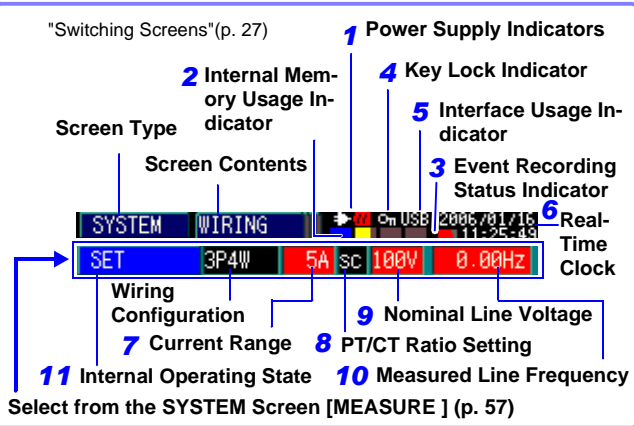
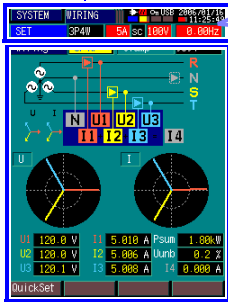

### Selectable Screen Display Area

Display contents depend on the selected screen

**See:** "2.3 Screen Configurations"(p. 28)

#### 1 Power Supply Indicators

Indicates the type and status of the instru8951J\_06.zipment's power source.

	Powered by AC adapter No battery pack
	Powered by AC adapter Battery pack charging
	Powered by AC adapter Battery pack installed, charging complete
	Powered by battery pack
	Powered by battery pack, low charge state

#### 3 Event Recording Status Indicator

Indicates the status of event occurrence. Up to 50 events can be recorded.

	Six events have been recorded
	Forty-six events have been recorded

#### 5 Interface Usage Indicator



Lights when the instrument is connected to a computer via USB cable (and the computer is on).

#### 2 Internal Memory Usage Indicator

Indicates the memory partitioning method and memory usage state. The amount of memory occupied by TIMEPLOT data is indicated by a level meter.

	No memory partitioning, when starting recording
	No memory partitioning, when about two-thirds of memory recorded
	Four partitions, second measurement, when starting recording
	Four partitions, second measurement, when about two-thirds of memory recorded
	Four partitions, recording in the fourth partition (Memory No. 4)

No. 1 2 3 4

"2.5 Internal Operating Status and Memory Usage"(p. 34)

#### 4 KEY LOCK Indicator



Lights after holding the key for three seconds, indicating that the KEY LOCK state is active (and operating keys are disabled).

#### 6 Real-Time Clock

Shows the current time.  
Setting the clock: (p. 76)



**7 Current Range**

A red field indicates that the crest factor is out of range.

Select a higher range

**9 Normal Line Voltage**

The currently selected nominal line voltage is displayed.

This field is red when the measured voltage (on channel 1) is far from the selected nominal line voltage.

**8 PT/CT Ratio****SC**

Appears when a PT or CT ratio has been set.

Nothing appears here when the PT and CT ratio settings are 1 (1:1).

**10 Measured Line Frequency**

Red field indicates indicate that the measured frequency does not match the nominal line frequency setting.

When no voltage is applied, 0.00 Hz is displayed.

**11 Internal Operating States (p. 34)**

The internal operating state changes when you press the **START/STOP** key to start and stop recording data to internal memory.

Internal Operation Indication	Internal State Description	Data Recording	Settings Available
<b>SET</b> [SET]	Appears after turning power on, until recording starts.	Before Recording	All Available
<b>WAITING</b> [WAITING]	When a preset start time has been set, appears while waiting for the recording start time after pressing Start.	Before Recording	Some Not Available
<b>RECORDING</b> [RECORD-ING]	Appears when recording starts, and until measurement data has finished being saved to internal memory.	Recording	Some Not Available
<b>ANALYZE</b> [ANALYZE]	Appears after recording is finished, indicating that the data stored in the internal memory is ready for analysis	Recording Stops	Some Not Available
<b>REVIEW</b> [REVIEW]	Indicates that the data recorded to internal memory is ready for analysis.	Recorded (Other data)	Some Not Available

In order to measure again, [SET] must be displayed.

To return to the [SET] state, press the **DATA RESET** key, and select whether to save or erase recorded data.

## 2.5 Internal Operating Status and Memory Usage

How data is recorded to internal memory (internal operating status) depends on whether memory partitioning is enabled.



### When Memory Partitioning is Disabled (Partition: [OFF])

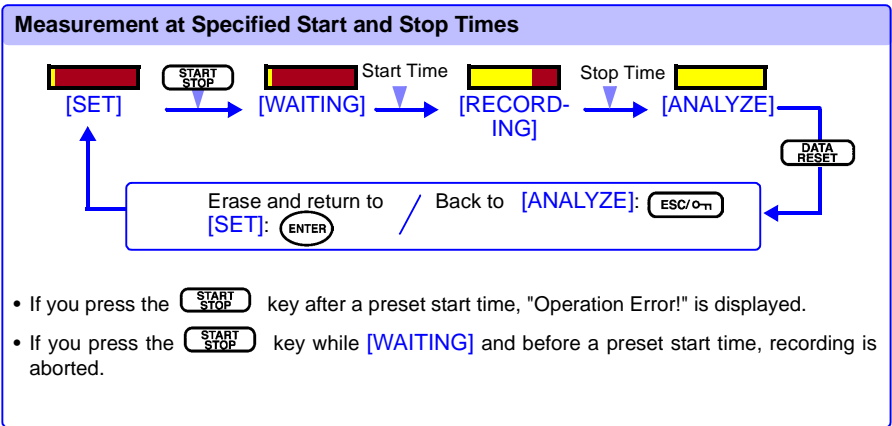
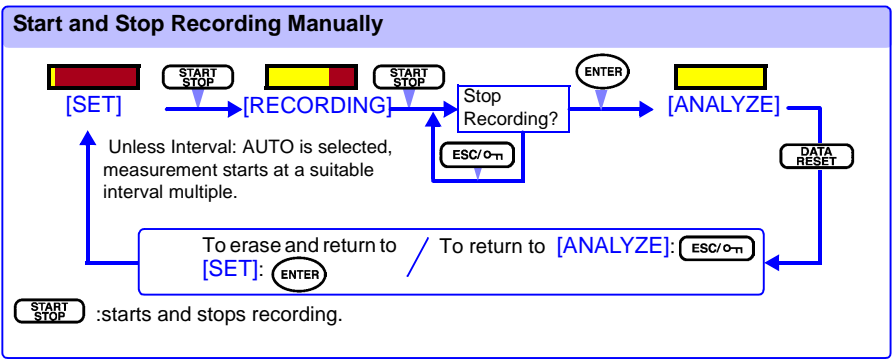

## Using Memory Partitioning (Partition: [ON])

(Blue) indicates recorded data.

(Red) indicates the memory partition currently being used.



(Brown) indicates no stored data.

(Yellow) indicates the amount of recorded Time Plot data as a level meter.

## Start and Stop Recording Manually

## First Measurement

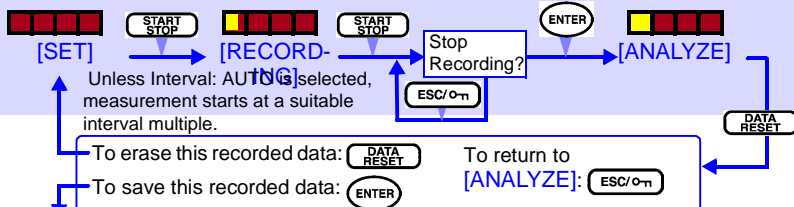

## Second Measurement

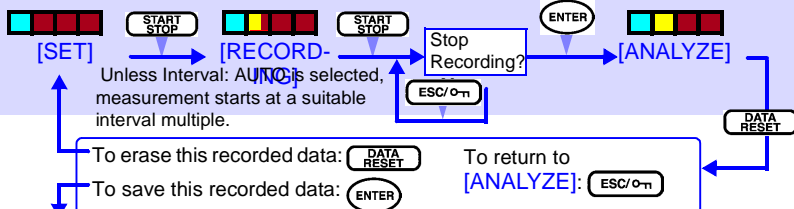

## Third Measurement

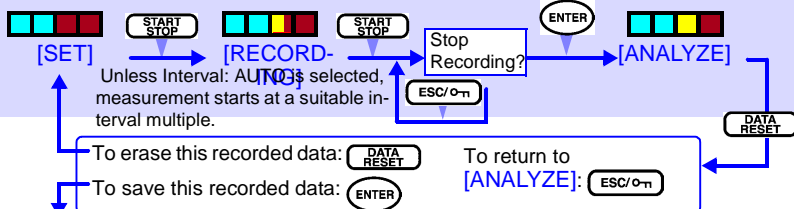

## Fourth Measurement

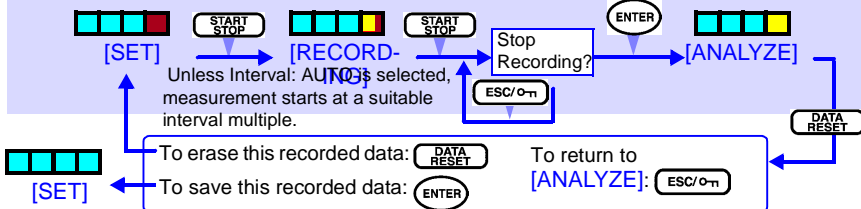

Pressing the **DATA RESET** key in the [SET] state erases all data from internal memory.

Select the [REVIEW] state to review recorded data. (p. 123)

In the Real-Time Control operating state, settings are applied at the time of each measurement.



# Measurement Preparations

## Chapter 3

### 3.1 Initial Instrument Preparations

Perform the following before starting measurement the first time.

3

#### 1 Apply the appropriate label to the input terminals

For the voltage input terminals

For the current input terminals

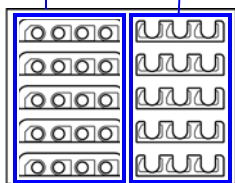

Input terminal labels

**Before applying the labels**  
Wipe any dust from the surface around the terminals, and ensure that it is dry.

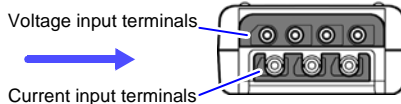

- 1 Peel the labels appropriate for your region from the supplied sheet.

Two types of labels are provided: one type for the voltage input terminals, and another type for the current input terminals.

- 2 Confirm that the labels are properly oriented, and apply them around the input terminals.

The display colors that identify the phases on screen should be set to match the terminal colors on the input terminal labels (p. 48).

TYPE 1 phase colors are the factory default.

#### Phase Colors (Input Terminal Colors)

Selection	N	U1 I1	U2 I2	U3 I3	Region
TYPE1	Black	Red	Yellow	Blue	HIOKI & UK
TYPE2	Blue	Orange	Black	Gray	New EU & UK
TYPE3	Black	Yellow	Green	Red	China
TYPE4	Blue	Black	Red	White	EU
TYPE5	White	Black	Red	Blue	US

### 3.1 Initial Instrument Preparations

## 2 Apply the appropriate labels to the voltage measurement and clamp sensor leads

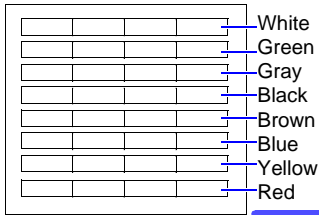

Measurement lead labels

Apply the same color labels as the input terminals to the corresponding voltage and clamp sensor leads.

**Before applying the labels**  
Wipe any dust from the surface around the terminals, and ensure that it is dry.

**Apply labels to both ends of the voltage cords**

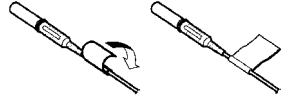

**Apply labels to both ends of the clamp sensor leads.**

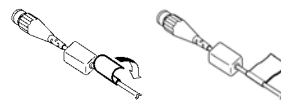

**NOTE** There are four measurement lead labels of each color.

## 3 Attach the strap

Use the strap to avoid dropping the instrument while carrying, or when you need to hang it on a hook.

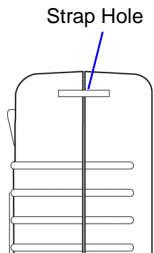

**Feed the strap through the buckle so that it is tight and not twisted.**

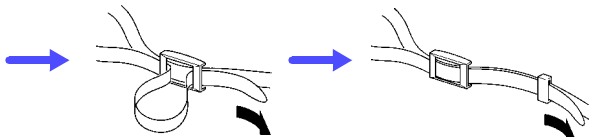

- 1** Push the strap through one of the strap holes on the instrument.
- 2** Feed the strap through the buckle
- 3** Put the end of the strap under the retaining loop.

- 4** Repeat the same procedure with the other end of the strap and the other strap hole.

### **CAUTION**

Attach the strap carefully.  
If it is not attached correctly, the instrument may be damaged by accidental dropping.

## 4 Install the 9459 Battery Pack

When it is not possible to supply AC mains power to the instrument through the AC adapter, it can be powered by the Model 9459 Battery Pack instead.

Also, when operating the instrument from the AC mains, the battery serves as a backup power source in case a power interruption occurs.

**Required tool:**  
One Philips screwdriver

### Important

Disconnect the AC adapter when installing the battery pack.

Battery Compartment Cover

Connect the battery leads with the white wire to the right.

The label is on the other side.

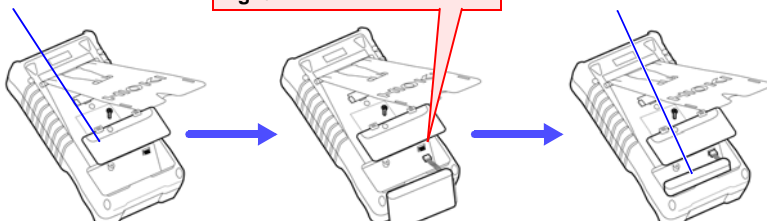
- 
- 1** Turn the instrument over to remove the retaining screw from the battery compartment cover, and remove the cover.
  - 2** Connect the plug from the battery pack to the connector.
  - 3** Insert the battery pack in the direction of the battery pack label. Insert while holding the wiring toward the right side.

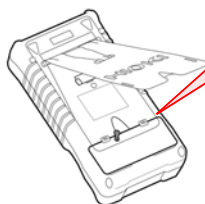

Avoid pinching the battery pack leads

- 4** Replace the battery pack compartment cover, and its retaining screw.

**For battery operation, use only the HIOKI Model 9459 Battery Pack. We cannot accept responsibility for accidents or damage related to the use of any other batteries.**

**5 Charge the 9459 Battery Pack**

Charge the battery pack before using it the first time.

By connecting the Model 9418-15 AC Adapter to the instrument and to an AC power outlet, the battery pack can be charged without turning the instrument on.

When to charge:

When powering the instrument from the battery pack without the AC adapter, the low battery indicator (  ) is displayed when the battery charge is depleted, indicating that the battery pack requires charging.

- 1** Connect the AC adapter to its power cord and to the instrument.

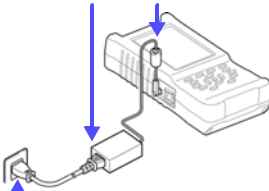

- 2** Plug the power cord into an outlet.

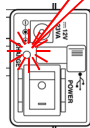

The CHARGE LED lights red when charging begins. The "  " indicator appears red on the display.

Charging is finished when the CHARGE LED turns off. If the "  " indicator appears white when the AC adapter is unplugged, charging was successful.

Refer to "3.2 Connecting the AC Adapter" (p. 41) for details about the AC adapter.

**Nominal continuous operating time (when powered only by the battery pack)**

(operating at 23°C)

After a full charge, with the LCD backlight off (five minutes after last keypress): approximately six hours

After a full charge, with the LCD backlight always on: approximately four hours

- The battery pack is subject to self-discharge. Be sure to charge the battery before initial use. If the battery capacity remains very low after correct recharging, the useful battery life is at an end.
- To avoid problems with battery operation, remove the batteries from the instrument if it is to be stored for a long time.
- The instrument is designed to be able to charge the Model 9459 Battery Pack during operation. Although the CHARGE LED may light red when using the Model 9418-15 AC Adapter, this does not affect measurement.



## 3.2 Connecting the AC Adapter

Connect the power cord and the instrument to the supplied Model 9418-15 AC Adapter, then plug the power cord into an outlet. When used with the battery pack installed, the battery serves as an operating backup supply in case of power failure, and the AC adapter otherwise has priority.

### Before Connecting



- Use only the supplied Model 9418-15 AC Adapter input voltage range is 100 to 240 VAC (with  $\pm 10\%$  stability) at 50/60 Hz. To avoid electrical hazards and damage to the instrument, do not apply voltage outside of this range.
- Turn the instrument off before connecting the AC adapter to the instrument and to AC power.
- To avoid electrical accidents and to maintain the safety specifications of this instrument, connect the power cord only to a 3-contact (two-conductor + ground) outlet.

3

### NOTE

If the AC adapter is used without the battery pack installed, be aware that a power interruption lasting more than two cycles causes measurement to be interrupted and the instrument to turn off.

### AC Adapter Connection Procedure

- 1** Connect the power cord to the inlet socket on the AC adapter.

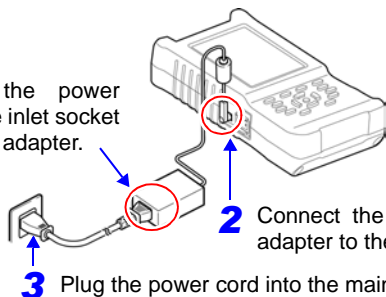

Rated supply voltage is 100 to 240 VAC, and rated supply frequency is 50 or 60 Hz.

- 2** Connect the output plug of the AC adapter to the instrument.

- 3** Plug the power cord into the mains outlet.

The output plug of the AC adapter should be oriented in one of the three directions shown below while connected to the instrument. Otherwise, the plug may inadvertently disengage.

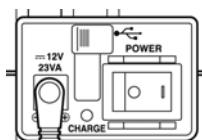
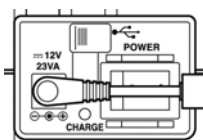
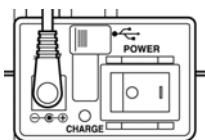

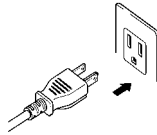
**Grounded and Ungrounded Outlets****Using a Grounded Outlet**

Plug the power cord into the outlet

**3.3 Connecting the Voltage Cords**

The color and number of voltage cords to use depends on the wiring configuration of the system being measured. Connect the supplied Model L9438-55 Voltage Cord Set to the voltage input terminals on the instrument.

**Before Connecting**

**Connect the voltage cords to the instrument first, and then to the active lines to be measured.**

**Observe the following to avoid electric shock and short circuits.**

- **Voltage cord should only be connected to the secondary side of a breaker, so the breaker can prevent an accident if a short circuit occurs. Connections should never be made to the primary side of a breaker, because unrestricted current flow could cause a serious accident if a short circuit occurs.**
- **Do not allow the voltage cord clips to touch two wires at the same time. Never touch the edge of the metal clips.**



- For safety reasons, when taking measurements, only use the L9438-55 Voltage Cord set provided with the instrument. The supplied voltage cords are colored black. Do not connect any leads that are not required for a particular measurement.

- Removable caps are attached to the metal pins at the ends of the test leads.

To prevent a short circuit accident, be sure to use the test leads with the caps attached when performing measurements in the CAT III and CAT IV measurement categories. The test leads can be used with the caps removed when taking measurements in the CAT I and CAT II measurement categories.

For details on measurement categories, see "Measurement categories" (p. 6).

- To prevent an electric shock accident, confirm that the white or red portion (insulation layer) inside the cable is not exposed. If a color inside the cable is exposed, do not use the cable.

Removing and attaching the caps



The tips of the metal pins are sharp, so take care not to injure yourself.

**Removing the caps** Gently hold the bottom of the caps and pull the caps off. Safely store the removed caps so as not to lose them.

**Attaching the caps** Insert the metal pins of the test leads into the holes of the caps, and firmly push them all the way in.

3

Voltage Cord Connections

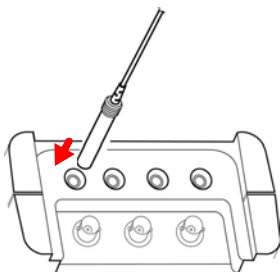

Insert the plugs into the terminals as far as they will go.

Insert each voltage cord plug into the terminal labeled with the corresponding color.

Refer to "5.2 Connecting to the Lines to be Measured" (p. 81) regarding measurement line wiring configuration diagrams.

Voltage Input Terminals Wiring Diagrams

Example: TYPE 1

B: Black, R: Red, Y: Yellow, b: blue

Wiring Configuration	Voltage Input Terminals	Wiring Configuration	Voltage Input Terminals
Single-Phase 2-Wire (1P2W)		Single-Phase 3-Wire (1P3W)	
Three-Phase 3-Wire (3P3W2M)		Three-phase, 3-wire (3P3W3M)	
Three-Phase 4-Wire (3P4W)		Three-Phase 4-Wire 2.5 Element (3P4W2.5E)	

## 3.4 Connecting Clamp Sensors

Connect the optional clamp sensors to the current input terminals on the instrument. The clamp sensors that are compatible with this instrument are voltage output types.

Compatible clamp sensors provide about 0.5 Vrms output corresponding to full scale current. Refer to the instruction manual provided with the clamp sensors.

### Before Connecting



Connect the clamp sensors to the instrument first, and then to the active lines to be measured.

Observe the following to avoid electric shock and short circuits.

- Clamp sensors should only be connected to the secondary side of a breaker, so the breaker can prevent an accident if a short circuit occurs. Connections should never be made to the primary side of a breaker, because unrestricted current flow could cause a serious accident if a short circuit occurs.
- When the clamp sensor is opened, do not allow the metal part of the clamp to touch any exposed metal, or to short between two lines, and do not use over bare conductors.



- To prevent damage to the instrument and sensor, never connect or disconnect a connector while the power is on, or while the sensor is clamped around a conductor.
- When disconnecting the BNC connector, be sure to release the lock before pulling off the connector. Forcibly pulling the connector without releasing the lock, or pulling on the cable, can damage the connector.

## Clamp Sensor Connection Procedure

Connect each clamp sensor plug to the terminal labeled with the corresponding color.

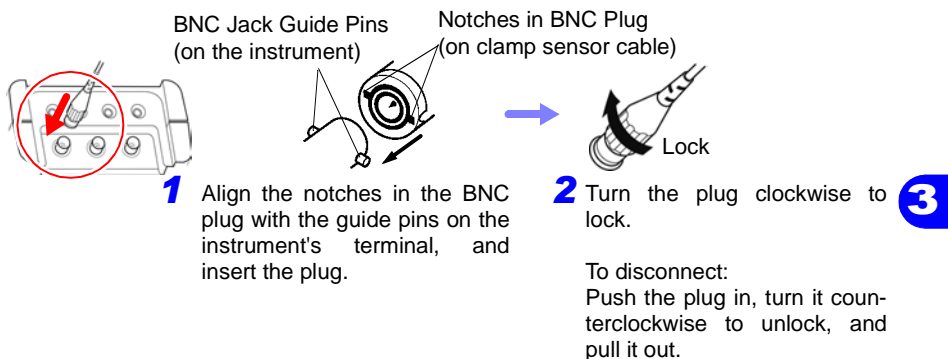

Refer to "5.2 Connecting to the Lines to be Measured" (p. 81) regarding measurement line wiring configuration diagrams.

## Current Input Terminals Wiring Diagrams

Example: TYPE 1

R: Red, Y: Yellow, b: Blue

Wiring Configuration	Current Input Terminals	Wiring Configuration	Current Input Terminals
Single-Phase 2-Wire (1P2W)		Single-Phase 3-Wire (1P3W)	
Three-Phase 3-Wire (3P3W2M)		Three-phase, 3-wire (3P3W3M)	
Three-Phase 4-Wire (3P4W)		Three-Phase 4-Wire 2.5 Element (3P4W2.5E)	

Before taking measurements, confirm that the clamp sensor model setting is correct (p. 60).

## 3.5 Turning the Power On and Off



**Before turning power on**

Confirm that the instrument and related accessories are installed and connected properly.

**When using the AC adapter**

Before turning the instrument on, make sure the supply voltage matches that indicated on the its power connector. Connection to an improper supply voltage may damage the instrument and present an electrical hazard.

**AC adapter rated supply voltage: 100 to 240 VAC**

(Voltage fluctuations of  $\pm 10\%$  from the rated supply voltage are taken into account.)

**Rated supply frequency: 50 or 60 Hz**

### Turning Power On

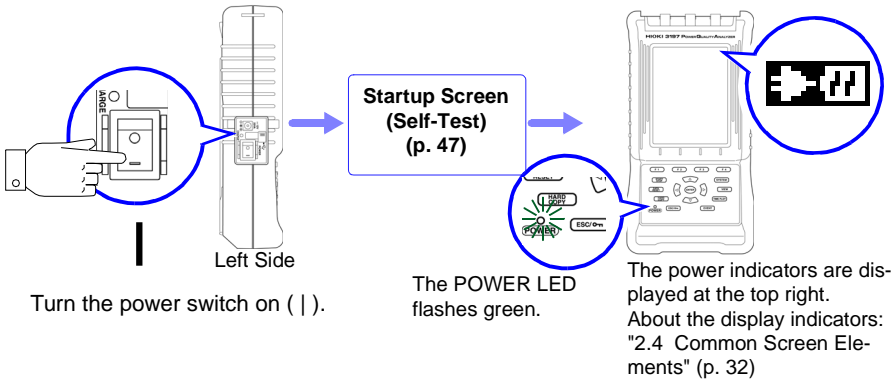

- If the "⚡" indicator is not displayed, the instrument is not being powered from the AC line. In this state, the battery charge will be depleted if measuring for a long time, and measurement may be interrupted. Verify that the AC adapter is securely connected to an AC power source and to the instrument.
- About battery pack operating time:(p. 40)

**Startup Screen**

When the instrument is turned on, the startup screen appears as the self-test starts.

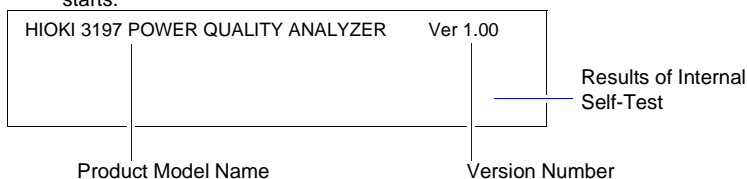

When no internal test results are displayed

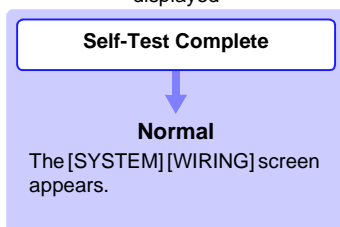

When the internal test result is [System Error]

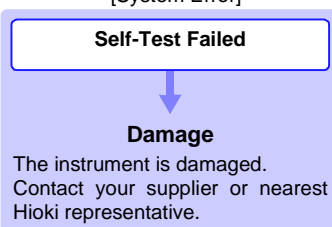

If the self-test fails, an Error or Warning message shows more information about the fault.

**NOTE** When first powered on after purchase, you may want to select another display language. Select from Japanese, English or Chinese. The display language can be changed again later.

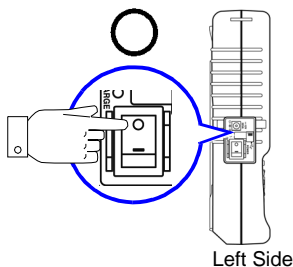
**Turning Power Off**

Turn the power switch off (○).

The POWER LED and display turn off.

When power is turned on again, the display appears with the settings that existed when power was last turned off. As long as the AC adapter is plugged in, battery charging continues even when the instrument is turned off.

# 3.6 Other Preparations

## 1 Select the screen color scheme to match the input terminal labels

Phase wiring is easier to keep track of when the color of each phase line indication on the display matches the label color of the corresponding input terminal. As an example, this procedure shows how to change the color scheme from TYPE 1 to TYPE 5.

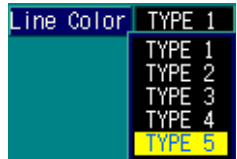
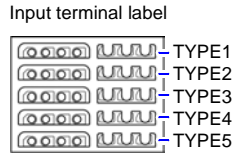
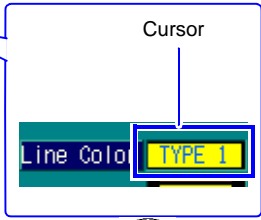
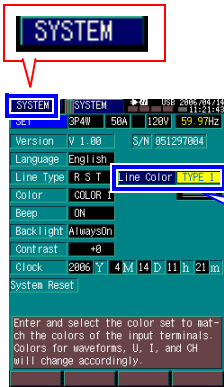

**1** Turn the instrument on, and press the **SYSTEM** key to display the [SYSTEM] screen.

**2** Press the keys to move the cursor to the [TYPE 1] setting.

**3** Press the **ENTER** key and then the cursor keys to select the TYPE number with the colors that match the input terminal label colors for your power system.

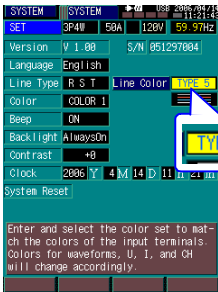

**4** Press the **ENTER** key to accept the new setting.

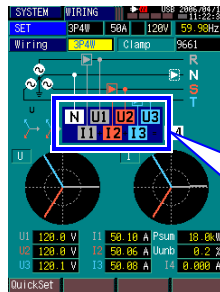

**5** Press the **SYSTEM** key to display the [WIRING] Configuration screen.

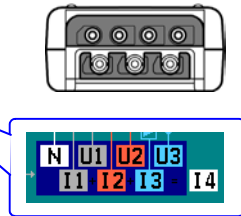

**6** Confirm that each displayed phase line color matches the corresponding input terminal label color.



## 2 Select the naming convention to be applied to each phase line measurement on the display

Phase line measurements can be identified on the display by the following conventions: R S T, A B C, L1 L2 L3 or U V W.

The factory default setting is R S T, but should be changed to suit your local convention.

As an example, this procedure shows how to change the phase line naming convention to U V W.

- 
- 1 Press the **SYSTEM** key to display the [SYSTEM] screen.
  - 2 Press the keys to move the cursor to the [RST] (factory default) setting.
  - 3 Press the **ENTER** key and then the keys to select the desired naming convention.

- 
- 4 Press the **ENTER** key to accept the new setting.
  - 5 Press the **SYSTEM** key to display the [WIRING] Configuration screen.
  - 6 Confirm that the phase (line) names displayed on screen match your selection.

Measurement data for each phase line is now identified as U1, U2 and U3 for voltage measurements, and as I1, I2 and I3 for current measurements.

Phase Naming Lists

With 1P2W selected

Select	U1 I1	N
R S T	L	N
A B C	A	N
L1 L2 L3	L1	N
U V W	H	N

With 1P3W selected

Select	U1 I1	U2 I2	N
R S T	R	T	N
A B C	A	B	N
L1 L2 L3	L1	L2	N
U V W	H	C	N

With 3P3W3M selected

Select	U1 I1	U2 I2	U3 I3
R S T	R	S	T
A B C	A	B	C
L1 L2 L3	L1	L2	L3
U V W	U	V	W

With 3P4W or 3P4W2.5E selected

Select	U1 I1	U2 I2	U3 I3	N
R S T	R	S	T	N
A B C	A	B	C	N
L1 L2 L3	L1	L2	L3	N
U V W	U	V	W	N

With 3P3W2M selected

Select	U1 I1	N	U2 I2
R S T	R	S	T
A B C	A	B	C
L1 L2 L3	L1	L2	L3
U V W	U	V	W

## 3.7 Auxiliary Function (KEY LOCK)

Use the KEY LOCK function to avoid inadvertent operations while recording.

### Locking and Unlocking

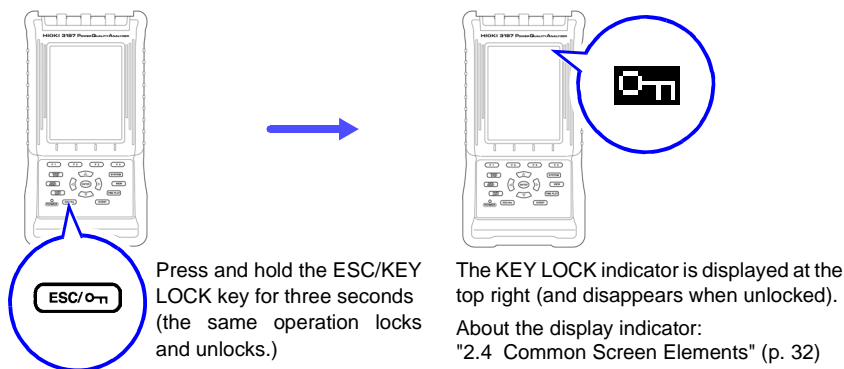

#### NOTE

- When the KEY LOCK function is enabled, all other key operations are disabled.
- The KEY LOCK state is retained when the instrument is turned off and back on.

## 3.8 Auxiliary Function (Save screen image)

An image of the screen is stored as a bitmap (BMP format) file in internal memory.

Saved screen images can be viewed by transferring to a computer (p. 127).

### Save screen image

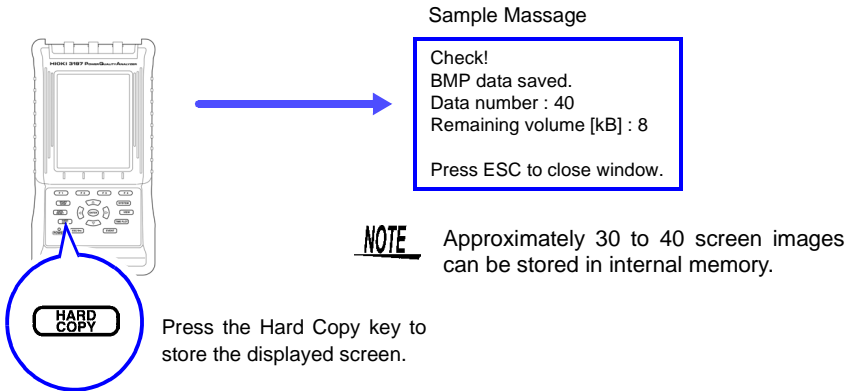

### To erase saved screen image files

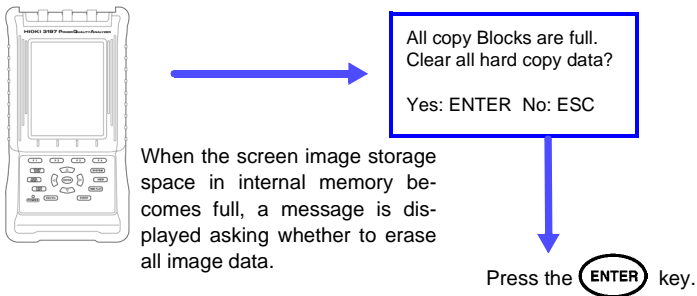

**NOTE** When the screen image storage space in internal memory becomes full, we recommend transferring the image files to a computer using the supplied USB cable. To transfer the image files, use the application programs supplied with the instrument (p. 127).

# Pre-Measurement and System Settings

## Chapter 4

After connecting the instrument to the lines to be measured and before starting recording, verify the instrument settings. Settings can be made in the following three ways.

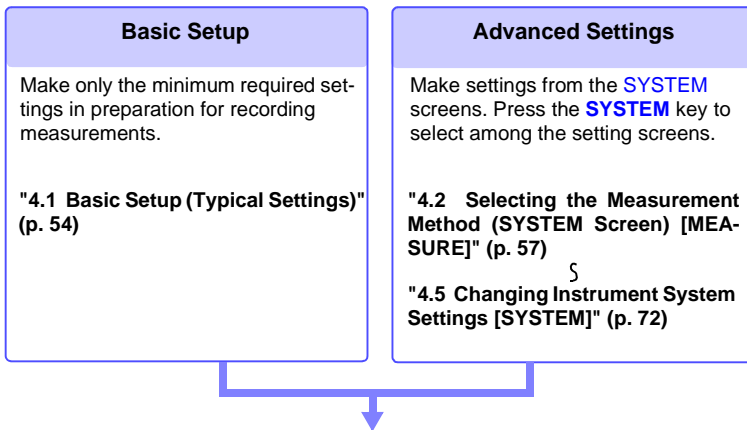

Begin measuring when finished making settings and connections.

**"5.2 Connecting to the Lines to be Measured"** (p. 81)

§

**"5.4 Starting and Stopping Recording"** (p. 88)

### Setting Screen Contents

(Pressing the **SYSTEM** key selects among setting screens)

Setting Contents	Settings Screen	Refer To
Basic measurement settings	[MEASURE]	"4.2 Selecting the Measurement Method (SYSTEM Screen) [MEASURE]" (p. 57)
Recording method settings	[REC&EVENT]	"4.3 Setting the Recording Method [REC&EVENT]" (p. 63)
Event detection settings	[REC&EVENT]	"4.4 Setting Event Detection [REC&EVENT]" (p. 67)
Instrument system settings	[SYSTEM]	"4.5 Changing Instrument System Settings [SYSTEM]" (p. 72)

**NOTE** Refer to "Appendix 8 List of Settings (Default Settings)" (p. A13).

# 4.1 Basic Setup (Typical Settings)

## The Basic Setup Function

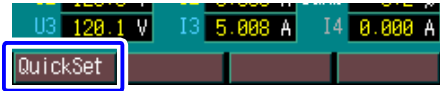

After turning the instrument on, preparations for recording can be easily performed by making only the minimum required settings (wiring configuration and clamp sensor settings) on the initial operating screen, confirming wiring configuration connections and executing Basic Setup.

Complex settings are made automatically, or set to default recommended values. Measurement recording can be started just by pressing the **START/STOP** key.

### Initial Operating Screen

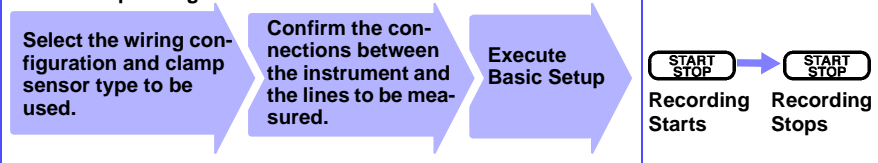









We recommend switching to the **SYSTEM** screen to confirm settings as occasion demands.

## Basic Setup Settings (set automatically)

Setting Item	Setting Contents
Frequency	AUTO The input frequency is automatically detected as 50 or 60 Hz immediately upon starting measurement.
Nominal Line Voltage	AUTO The nominal line voltage that serves as a reference value for voltage dips, swells and interruptions is detected immediately upon starting measurement. Nominal line voltage is detected from 14 standard levels, including 100, 120 and 230 V.
Interval	AUTO Recording starts at one-second intervals, which are automatically lengthened as memory fills up (p. 64). This is to ensure that suitable measurement data is recorded.
Voltage Swells	110% The event detection threshold for voltage swells is set to 110% of the nominal line voltage.
Voltage Dips	90% The event detection threshold for voltage dips is set to 90% of the nominal line voltage.
Interruptions	10% The event detection threshold for voltage interruptions is set to 10% of the nominal line voltage.
Transients	ON Transient event detection is enabled.

Other settings are unaffected

## 1. Select the wiring configuration and clamp sensor model.

- 1 **SYSTEM** → Select the **SYSTEM [WIRING]** screen (Initial Operating Screen). 
- 2  → Move to the **[Wiring]** setting. 
- 3 **ENTER** → Select from the pull-down menu.   
**ENTER** → Accept  **Setting details:**  
**See:** "Setting the Wiring Method (Wiring)" (p. 58)
- 4  → Move to the **[Clamp]** setting. 
- 5 **ENTER** → Select from the pull-down menu.   
**ENTER** → Accept  **Setting details:**  
**See:** "Selecting the Clamp Sensor Model and Current Range" (p. 60)

4

## 2. Setting details

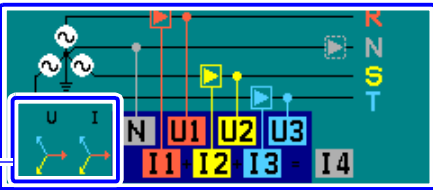
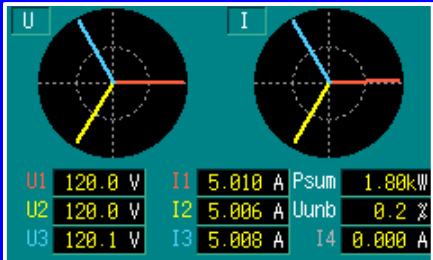
- 1 Connect to the lines to be measured while viewing the wiring diagram.   
**Wiring procedure:**  
**See:** "5.2 Connecting to the Lines to be Measured" (p. 81)  
Correct vector diagram
- 2 Verify that the vector diagram and measurement values are displayed correctly.   
**Connection checking procedure:**  
**See:** "5.3 Verifying Correct Wiring (Connection Check)" (p. 86)

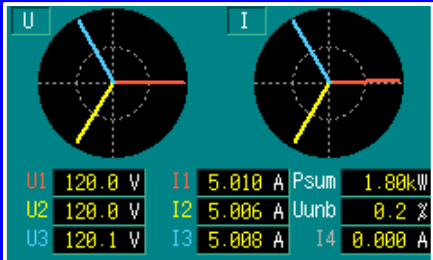

4.1 Basic Setup (Typical Settings)

**3. Execute Basic Setup.**

**1** **F 1**

Select [QuickSet].



A confirmation message appears.

**2** **ENTER**

Execute basic setup.  
Pressing **ESC** key reverts to the original screen without executing Basic Setup.

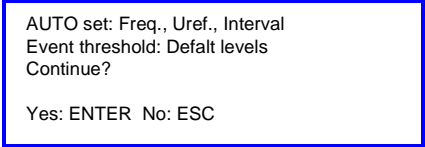

**3** **START STOP**

Start recording.

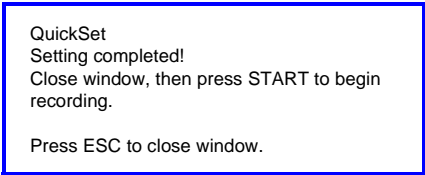



## 4.2 Selecting the Measurement Method (SYSTEM Screen) [MEASURE]

Before connecting to the lines to be measured, change these settings as occasion demands.

Make settings on the SYSTEM-[MEASURE] screen.

To open the screen:

Press the **SYSTEM** key to display the [MEASURE] screen. Set the following items.

The screenshot shows the SYSTEM [MEASURE] screen with the following settings:

Setting	Value
Frequency	AUTO
Wiring	3P4W
UReference	AUTO
Clamp	9660
I Range	100A
PT Ratio	1
CT Ratio	1
Harm Calc	LEVEL
PF Type	PF



Annotations and their corresponding settings:

- Selects the nominal frequency of the measurement lines (p. 58). (Points to Frequency)
- Selects the wiring configuration (p. 58). (Points to Wiring)
- Selects the nominal voltage of the measurement lines (p. 59). (Points to UReference)
- Selects the clamp sensor model to be used (p. 60). (Points to Clamp)
- Selects the current range (p. 60). (Points to I Range)
- When using P or CT, select the ratio. (Points to PT Ratio and CT Ratio)
- Select the calculation formula for harmonics or power factor (p. 62). (Points to Harm Calc and PF Type)

Additional text on the screen: Press ENTER and select the frequency of the line being measured. Select AUTO for automatic frequency setting.

## 4.2 Selecting the Measurement Method (SYSTEM Screen) [MEASURE]

### Selecting the Line Frequency (Frequency)

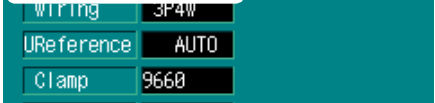
- 1 **SYSTEM** → Select the screen. 
- 2  → Move to the setting item. 
- 3 **ENTER** → Select from the pull-down menu. 



**ENTER** Accept / **ESC/OFF** Cancel

#### Setting Contents

**AUTO/ 50Hz/ 60Hz**

The AUTO setting automatically selects 50 or 60 Hz internally when measurement starts.

### Setting the Wiring Method (Wiring)

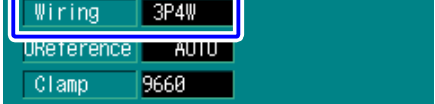
- 1 **SYSTEM** → Select the screen. 
- 2  → Move to the setting item. 
- 3 **ENTER** → Select from the pull-down menu. 

**ENTER** Accept / **ESC/OFF** Cancel

#### Setting Contents

<b>1P2W</b>	Measure single-phase, 2-wire lines
<b>1P3W</b>	Measure single-phase, 3-wire lines
<b>3P3W2M</b>	Measure three-phase, 3-wire lines (Delta configuration, using the two-meter method) (Use to measure three-phase power by measuring current at just two points.)
<b>3P3W3M</b>	Measure three-phase, 3-wire lines (Delta configuration, using the three-meter method)
<b>3P4W</b>	Measure three-phase, 4-wire (star configuration)
<b>3P4W2.5E</b>	Measure three-phase, 4-wire, 2.5-element lines (star configuration) (Use to measure three-phase power by measuring voltage at just two points.)

### Setting the Line Voltage (Nominal Line Voltage) of the Lines to be Measured

**1** **SYSTEM** Select the screen (initial operating screen).

**2**  Move to the setting item.

**3** **ENTER** Select from the pull-down menu.

**ENTER** Accept / **ESC/ON** Cancel

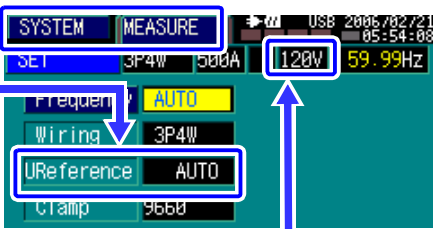

The AUTO setting automatically selects the nominal voltage when measurement starts, and the internally set value is displayed here.

4

#### Setting Contents

**AUTO / VARIABLE (50 to 600) 100V/ 101V/ 110V/ 120V/ 127 V/ 200V/ 202V/ 208V/ 220V/ 230V/ 240V/ 277V/ 347V/ 380V/ 400V/ 415V/ 480V/ 600V**

To set  
"VARIABLE"



Select a digit to change (◀ : move up, ▶ : move down)



Change the digit's value (▲ : increase the value, ▼ : decrease the value)

## 4.2 Selecting the Measurement Method (SYSTEM Screen) [MEASURE]

### Selecting the Clamp Sensor Model and Current Range

Select the model name of the clamp sensors to be used.

This setting is ignored if no clamp sensors are used.

For the detail about the clamp sensor, refer to the instruction manual provided with the device.

**1** **SYSTEM** Select the screen.

**2** Move to the setting item.

**3** **ENTER** Select from the pull-down menu.

**ENTER** Accept / **ESC/On** Cancel

Clamp sensor	Current range	
<b>9660</b>	10A/ 100A	9660 Clamp-on Sensor
<b>9661</b>	50A/ 500A	9661 Clamp-on Sensor
<b>9667_500</b>	50A/ 500A	9667 Flexible Clamp-on Sensor (500A range)
<b>9667_5k</b>	500A/ 5000A	9667 Flexible Clamp-on Sensor (5000A range)
<b>9669</b>	100A/1000A	9669 Clamp-on Sensor
<b>9694</b>	5A/ 50A	9694 Clamp-on Sensor
<b>9695-02</b>	5A/ 50A	9695-02 Clamp-on Sensor
<b>9695-03</b>	10A/ 100A	9695-03 Clamp-on Sensor
<b>9657-10</b>	0.5A/ 5A	9657-10 Clamp-on Leak Sensor
<b>9675</b>	0.5A/ 5A	9675 Clamp-on Leak Sensor

The current ranges available for selection depend on the clamp sensor model. The range setting applies to all channels (1 to 3). Different ranges cannot be set for individual channels.







To use non-Hioki clamp sensors, bear in mind the following requirements:

- Only voltage-output type clamp sensors can be used.
- Output should not exceed 1.7 Vrms (2.4 Vpeak).
- The ratio of output voltage to input current should be the same as Hioki clamp sensors. Refer to "Appendix 5 Power Range Structure" (p. A9).

**NOTE** When the clamp sensor model setting is changed, the highest current range is initially selected.



### Setting the PT Ratio (when measuring using a transformer)

When measuring the secondary side of a High Voltage line, measured values can be converted to display the voltage value at the primary side.

- 1 **SYSTEM** → Select the screen. 
- 2  → Move to the setting item. 
- 3 **ENTER** → Select from the pull-down menu. 
  -  →
  -  →
  - ENTER** Accept / **ESC/ON** Cancel





#### Setting Contents

VARIABLE (1.00 to 999.99) / 1/ 60/ 100/ 200/ 300/ 600/ 700

- To set "VARIABLE"
-  Select a digit to change (◀ : move up, ▶ : move down)
  -  Change the digit's value (▲ : increase the value, ▼ : decrease the value)

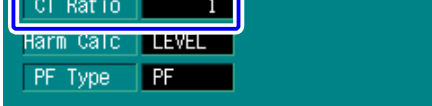

### Setting the CT Ratio (when measuring using a transformer)

When measuring the secondary side of a High Voltage line, measured values can be converted to display the current value at the primary side.

- 1 **SYSTEM** → Select the screen (initial operating screen). 
- 2  → Move to the setting item. 
- 3 **ENTER** → Select from the pull-down menu. 
  -  →
  -  →
  - ENTER** Accept / **ESC/ON** Cancel







#### Setting Contents

VARIABLE (0.01 to 999.99) / 1/ 4/ 6/ 8/ 10/ 12/ 15/ 20/ 30/ 40/ 60/ 80/ 100/ 120/ 160

- To set "VARIABLE"
-  Select a digit to change (◀ : move up, ▶ : move down)
  -  Change the digit's value (▲ : increase the value, ▼ : decrease the value)

## 4.2 Selecting the Measurement Method (SYSTEM Screen) [MEASURE]





### Selecting the Voltage Harmonic Calculation Method

- 1 **SYSTEM** → Select the screen. 
- 2  → Move to the setting item. 
- 3 **ENTER** → Select from the pull-down menu. 
  

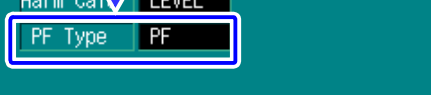

  
**ENTER** Accept / **ESC/OFF** Cancel

#### Setting Contents

<b>Rms Value</b>	Displays rms harmonic voltage.
<b>Percentage Content</b>	Displays the amplitude (harmonic voltage percentage) of an harmonic order component relative to that of the fundamental waveform.

### Selecting the Power Factor Calculation Method (PF Type)

- 1 **SYSTEM** → Select the screen. 
- 2  → Move to the setting item. 
- 3 **ENTER** → Select from the pull-down menu. 
  

  

  
**ENTER** Accept / **ESC/OFF** Cancel

#### Setting Contents

<b>PF</b>	Displays power factor.
<b>DPF</b>	Displays displacement power factor.

#### What is the power factor?

- PF (Power Factor) is the ratio of apparent power to active power. Its calculation includes all frequency components, so large harmonic components result in a small power factor.
- DPF (Displacement Power Factor) is the cosine of the phase difference between the fundamental voltage and current waveforms. Its calculation includes only fundamental waveform contents, so harmonics have no effect.

## 4.3 Setting the Recording Method[REC&EVENT]

Make recording method settings before measuring, as occasion demands. Make settings on the SYSTEM-[REC&EVENT] screen.

Opening the [REC&EVENT] screen

Press the **SYSTEM** key to display the [REC&EVENT] screen.

Specifies whether memory is to be partitioned for recording (when partitioned, four sets of measurement results can be stored internally) (p. 63).

Recording interval setting (p. 64).

Event threshold settings (for anomalous phenomena)  
Event Settings (p. 67)

Specified demand period (demand calculation period) (p. 65)

Specified start and stop times for timed recording (p. 66).

**4**

### Setting the Method for Recording to Internal Memory (Partition)

Selects whether to record multiple measurement (start and stop recording) sessions to separate partitions of internal memory.

- 1** **SYSTEM** → Select the screen.
- 2** → Move to the setting item.
- 3** **ENTER** → Select from the pull-down menu.

**ENTER** Accept / **ESC/ON** Cancel

#### Setting Contents

<b>ON</b>	Four measurement sessions can be recorded. (maximum recordable period is one-fourth that of unpartitioned memory)
<b>OFF</b>	Only one measurement session can be recorded.

When data has been recorded in partitioned memory, memory partitioning cannot be canceled until the data has been erased.

4.3 Setting the Recording Method [REC&EVENT]

**Setting the Recording Interval (Interval)**

Measurement data during the specified intervals is recorded as a time series graph.

**1** **SYSTEM** Select the screen.

**2** Move to the setting item.

**3** Select from the pull-down menu.

**ENTER** Accept / **ESC/C-T** Cancel

**Setting Contents**  
**AUTO/ 1 min/ 5 min/ 15 min/ 30 min/ 60 min**

**Time Series Graph Recording**

"RMS" records maximum, average and minimum values within each interval.  
 "Rms voltage" records maximum and minimum values within each interval.  
 The recordable length of a time series graph depends on the specified interval.  
 When memory partitioning is disabled ([No]), the measurements of about 3,000 times intervals can be recorded. When memory partitioning is enabled ([ON]), measurements from about 750 times intervals can be recorded during each measurement session.

**See:** "Appendix 1 Interval and Recording Time Settings" (p. A1)







**The [AUTO] Interval Setting**

The interval automatically increases sequentially from 1, 2, 10 and 30 seconds and 1, 5, 15, 30 and 60 minutes.  
 Recording begins at one-second intervals, and increases to the next longer interval as memory fills up, so that the most suitable measurement data is usually recorded.  
 The time axis of the TIME PLOT screen at each interval setting is shown in "Appendix 1 Interval and Recording Time Settings" (p. A1).



## Setting Demand Period

Set the demand period for recordings.

- 1 **SYSTEM** → Select the screen. 
  - 2  → Move to the setting item. 
  - 3 **ENTER** → Select from the pull-down menu. 
    - 
    - 
- ENTER** Accept / **ESC/ON** Cancel

### Setting Contents

15 min/ 30 min/ 60 min

#### What is Demand?

"Demand" here is the average power [kW] consumed during the "demand period" (typically 30 minutes), used in power company transactions.

4.3 Setting the Recording Method [REC&EVENT]

Setting Recording Start and Stop Times

When timed recording is enabled, recording start and stop times can be set.

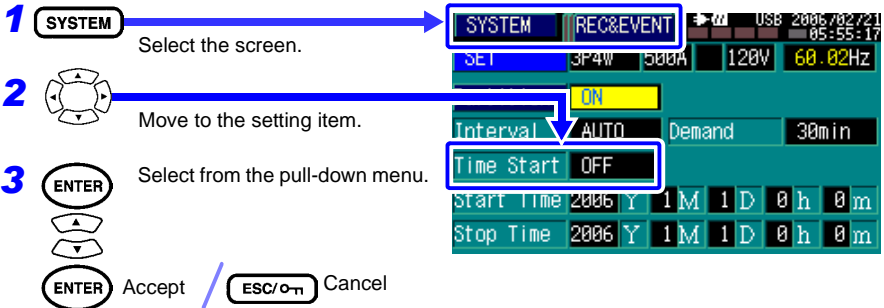

Setting Contents

- OFF** Start and stop recording by pressing the **START/STOP** key. However, note that after pressing the **START/STOP** key, and depending on the specified interval, recording starts only at appropriate times.
- ON** Operates as though you pressed the **START/STOP** key at the specified start and stop times.

When OFF (recording start time depends on interval setting)

Example: If the following intervals are selected and you press **START/STOP** at current time 10:41:22

Interval Setting



Recording does not actually start until the beginning of the next scheduled interval.

When ON

When an interval is specified, recording does not actually start until the appropriate time. Start and stop times can be set by two methods.

Manual Setting



Selects year, month, day, hour and minute



Change a numerical value ([▲]: increase the value, [▼]: decrease the value)

Automatic Setting [Start Time]



Sets to the current time

[Stop Time]



Sets to one hour from the start time.



Sets one day from the start time.



Sets one week from the start time.

**NOTE** If the start time has already passed when you press the **START/STOP** key, "Operation Error!" is displayed. During the [WAITING] mode, pressing the **START/STOP** key before the start time aborts the recording.

## 4.4 Setting Event Detection [REC&EVENT]

With this instrument, an "event" is the detection of an anomaly (abnormal phenomena) that may occur on power lines.

The detection criteria (Event Settings) are specified before recording measurements.

When the specified criteria are satisfied while recording, the data is recorded as an event, and can be analyzed on the EVENT screen.

Event settings are made on the SYSTEM-[REC&EVENT] screen.

Parameter that can be analyzed on the EVENT screen:

- View event occurrences on the Event Monitor.
- View sequence, date, time and event parameter.
- View the voltage or current event waveform.
- On the detailed fluctuation graph, view rms fluctuations when an event occurs.

**See:** "Viewing Anomalous Phenomena (EVENT screen)" (p. 108)

4

This instrument supports eight types of events

Manual	Inrush Current
Timer	Transients
Voltage Swell	Voltage Dip
Interruption	Start, Stop

**See:** Refer to: Event Details, "Detection Methods and Recording Contents of Events" (p. 110)

### Event Recording

- Event criteria can be ORed together (logical sum).
- Events are recorded when recording starts and stops, regardless of criteria settings.
- The instrument can record data from up to 50 events (in the Event List and Event Waveforms).
- Depending on the type of event, two recordings may occur: once when a threshold is exceeded [IN] and again upon return [OUT].

**4.4 Setting Event Detection [REC&EVENT]**

**Opening the [REC&EVENT] Screen**

Press the **[SYSTEM]** key to display the [REC&EVENT] screen.

The screenshot shows the [REC&EVENT] screen with the following settings:

- SET**: 3P4W, 500A, 120V, 60.02Hz
- Partition**: ON
- Interval**: AUTO Demand, 30min
- Time Start**: OFF
- Start Time**: 2006 Y 1 M 1 D 0 h 0 m
- Stop Time**: 2006 Y 1 M 1 D 0 h 0 m
- Timer Evt**: OFF, Inrush 3.0s
- U Transient**: ON
- Urms SWELL**: 110 % = 110.0 V
- Urms DIP**: 90 % = 90.0 V
- Interruption**: 10 % = 10.0 V

Annotations on the left side:

- Timed Event**: Records events at specified time intervals.
- Voltage Swell, Dip and Interruption**: Any momentary deviation of rms voltage from the nominal voltage is recorded as an event.

Annotations on the right side:

- Inrush Event (Inrush, Starting or Surge Current)**: An event is recorded when the specified value is exceeded.
- Transient Event (Transient Overvoltage)**: An event is recorded when high frequency impulse noise is imposed on the mains voltage waveform.

**Start Event/ Stop Event**

By enabling Start/Stop Events, measurements are recorded as an event each time recording is started and stopped.

**Manual Events**

Manual event recording records the measurement state at the current time as an event.







Manual event recording is always enabled.

**See:** "Manual" (p. 113)

**[ESC/O-m] + [EVENT]** The time of a manual event is the moment at which these keys are pressed simultaneously.

## Setting Timed Events

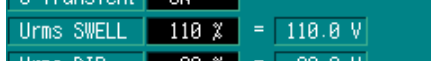
Timed events are recordings made automatically at a predefined interval.

- 1 **SYSTEM** → Select the screen. 
- 2  → Move to the setting item. 
- 3 **F 1** OFF / **F 2** ON 
- 4 **ENTER** → Select from the pull-down menu.   
  
**ENTER** Accept / **ESC/ON** Cancel 







### Setting Contents

OFF/1 min/5 min/15 min/30 min/1 hour/2 hour/ 12 hour/ 1 day

See: "Timer" (p. 113)

## Setting Inrush Events

Inrush events indicate that inrush current (inrush, starting or surge current) has exceeded the specified threshold.

- 1 **SYSTEM** → Select the screen. 
- 2  → Move to the setting item. 
- 3 **F 1** OFF / **F 2** ON 
- 4 **ENTER** → Change a numerical value ([ ▲ ]: increase the value, [ ▼ ]: decrease the value)   
  
**ENTER** Accept / **ESC/ON** Cancel 

### Setting Contents

0A to 5000A





The inrush current threshold setting is an rms current value.

See: "Inrush Current" (p. 113)

When an event occurs, a graph of the inrush current is recorded in addition to the event waveform.

### Setting Transient Events

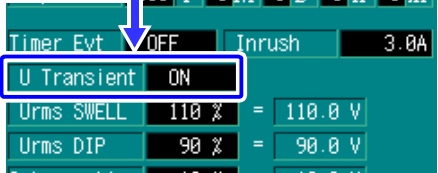
An event is recorded when high frequency impulse noise is imposed on the mains voltage waveform.

- 1 **SYSTEM** → Select the screen. 
- 2  → Move to the setting item. 
- 3 **F 1** OFF / **F 2** ON
- 4 **ENTER** → Select from the pull-down menu.   
**ENTER** Accept / **ESC/O-TT** Cancel

#### Setting Contents

##### OFF/ ON (disable/enable transient event recording)

An event is detected as the presence, during any single cycle of the mains voltage waveform, of a frequency component at 10 to 100 kHz with 50 Vrms ( $\pm 70.7$  Vpeak equivalent) or greater amplitude in either the positive or negative direction on any of the three channels.

**See:** "Transient Overvoltage" (p. 112)

#### What is a transient?

On this instrument, a "transient overvoltage" is also called a "transient".

Transient overvoltage is sometimes also called an "excessive voltage spike" or "Impulsive voltage".





#### NOTE

Only the existence or non-existence of transient overvoltage is detected.

Although voltage and current waveforms can be displayed when an event is detected, the transient overvoltage waveform cannot be displayed.

## Setting Voltage Swell, Dip and Interruption Events

A voltage swell, voltage dip or interruption of the nominal voltage is recorded as an event.

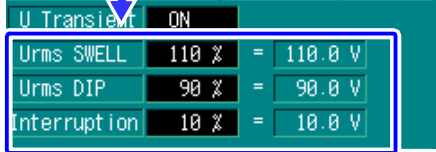
- 1 **SYSTEM** → Select the screen. 
- 2  Move to the setting item. 
- 3 **ENTER**  Change a numerical value ([▲]: increase the value, [▼]: decrease the value) 

Urms SWELL	110 %	=	110.0 V
Urms DIP	90 %	=	90.0 V
Interruption	10 %	=	10.0 V

**ENTER** Accept / **ESC/ON** Cancel 4

### Setting Contents

Voltage Swell	Set a percentage larger than the nominal line voltage (default 110%).
Voltage Dip	Set a percentage smaller than the nominal line voltage (default 90%).
Interruption	Set a percentage smaller than the nominal line voltage (default 10%).

In all cases, an event is recorded when the threshold is breached in either direction (once upon onset, and once again upon recovery).

Upon event recovery ("event out"), the continuous period and worst-case voltage swell values are displayed.

Upon event onset ("event in"), an event voltage fluctuation graph is recorded.

### What is Voltage Swell?

Voltage swell is a rise of rms voltage, where a threshold is set above the nominal voltage.

When the rms voltage rises above the threshold, it is detected as an "event in (onset)" voltage swell event. Subsequently, when the voltage falls back below the threshold (minus appropriate hysteresis), it is detected as an "event out (recovery)" voltage swell event.

### What is Voltage Dip?

Voltage dip is the opposite of voltage swell, that is a fall of rms voltage where a threshold is set below the nominal voltage.

When the rms voltage falls below the threshold, it is detected as an "event in (onset)" voltage dip event. Subsequently, when the voltage rises back above the threshold (plus appropriate hysteresis), it is detected as an "event out (recovery)" voltage dip event.

### What is Interruption?

This is the power suspension state when voltage drops to a threshold below the nominal voltage and further below the voltage dip threshold.

When the rms voltage falls below the threshold, it is detected as an "event in (onset)" voltage interruption event. Subsequently, when the voltage rises back above the threshold (plus appropriate hysteresis), it is detected as an "event out (recovery)" voltage interruption event.

**See:** "Voltage Swell" (p. 110), "Voltage Dip" (p. 111), "Interruption" (p. 111)

## 4.5 Changing Instrument System Settings [SYSTEM]

The instrument's version information can be viewed, and the display language, beep sounds and screen colors can be changed from the SYSTEM screen.

Confirm that the clock is set correctly before starting recording. If the clock is not set correctly, recording results may not be analyzed correctly (p. 76).

### Opening the [SYSTEM] Screen

Press the **[SYSTEM]** key to display the [SYSTEM] screen.

The screenshot shows the SYSTEM menu with the following options and callouts:

- Version V 1.00**: Displays the instrument's version information.
- Language English**: Changes the display language (p. 73).
- Line Type R S T**: Changes the wiring configuration diagram (p. 48).
- Color COLOR 1**: Changes screen colors (p. 73).
- Beep ON**: Enables or disables the beep sound (p. 74).
- BackLight AlwaysOn**: Sets the LCD back-light timeout (p. 74).
- Contrast +0**: Adjusts LCD contrast (p. 75).
- Clock 2006 Y 2 M 21 D 5 h 58 m**: Sets the clock (p. 76).
- System Reset**: Resets the system (p. 77).
- S/N 051297013**: Displays the serial No..
- Line Color TYPE 1**: Select the displayed terminal colors to match the label colors. Sets the clock (p. 49).

### Displaying the Instrument's Version Number (Version)

Shows the instrument's version number.







The screenshot shows the navigation process:

- Pressing the **[SYSTEM]** key leads to the SYSTEM menu.
- Pressing the **[Version]** key (indicated by a blue box) displays the Version screen.
- The Version screen shows: **Version V 1.00** and **S/N 051297013**.
- The Language screen below shows: **Language English**.



## Changing the Display Language (Language)

The display language can be selected from Japanese, English or Chinese.







- 1 **SYSTEM** → Select the screen. 
  - 2  → Move to the setting item. 
  - 3 **ENTER** → Select from the pull-down menu. 
    - 
    - 
- ENTER** Accept / **ESC/ON** Cancel

### Setting Contents

English/ Chinese/ Korean/ Japanese

4

## Changing Screen Colors (Color)

- 1 **SYSTEM** → Select the screen. 
  - 2  → Move to the setting item. 
  - 3 **ENTER** → Select from the pull-down menu. 
    - 
    - 
- ENTER** Accept / **ESC/ON** Cancel

### Setting Contents

<b>COLOR1</b>	Dark green
<b>COLOR2</b>	Dark blue
<b>COLOR3</b>	Monochrome (white characters)
<b>COLOR4</b>	Light blue
<b>MONO</b>	Monochrome (black characters)



For printing black and white reports and such, select [MONO] and perform a saving screen images (press the Hard Copy key).

4.5 Changing Instrument System Settings [SYSTEM]

**Enable or Disable Beep Sounds (Beep)**

Keypress beep sounds can be enabled or disabled.

**1** **SYSTEM** → Select the screen. 

**2**  → Move to the setting item. 

**3** **ENTER** → Select from the pull-down menu. 

**ENTER** Accept / **ESC/ON** Cancel



**Setting Contents**

<b>ON</b>	Keypress beeps are enabled
<b>OFF</b>	Keypress beeps are disabled.

**Setting the LCD Backlight Timeout (Backlight)**

When operating from the battery pack only, operating time can be maximized by setting the LCD backlight to turn off automatically after a specified period of key inactivity.

**1** **SYSTEM** → Select the screen. 

**2**  → Move to the setting item. 

**3** **ENTER** → Select from the pull-down menu. 

**ENTER** Accept / **ESC/ON** Cancel

**Setting Contents**

<b>AlwaysOn</b>	Keeps the backlight always on.
<b>1min/ 5min/ 10min/ 30min/ 1hour</b>	The backlight turns off automatically after the selected period of inactivity.





**To turn the backlight back on**

Press any key to turn the backlight back on after it has turned off automatically. The backlight comes back on even if Key Lock is active.

**NOTE** The LCD backlight automatically switches from high to low brightness when there is no key press for ten seconds. No setting is available to retain high brightness at all times.

## Adjusting Screen Contrast (Contrast)

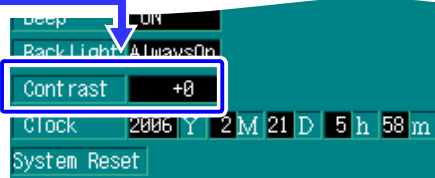
Because screen contrast is temperature dependent, you may need to adjust LCD contrast to retain visibility.

- 1 **SYSTEM** Select the screen. 
- 2  Move to the setting item. 
- 3 **ENTER** Change a numerical value  
 ([ ▲ ]: increase the value, [ ▼ ]: decrease the value)  
  
  
**ENTER** Accept

### Setting Contents

+0









-30 to -2 Lower setting values make the screen lighter.

+2 to +20 Higher setting values make the screen darker.

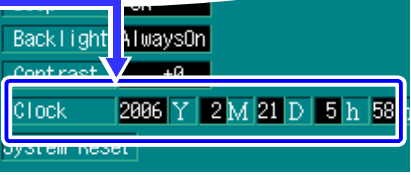
4.5 Changing Instrument System Settings [SYSTEM]

**Setting the Clock (Clock)**

Set the instrument's real-time clock to the current date and time. Data recording and management depends on the clock being set correctly.

- 1  Select the screen. 
- 2  Move to the setting item.  
Move between the year, month, day, hour and minute to set. 
- 3   Change a numerical value ([ ▲ ]: increase the value, [ ▼ ]: decrease the value)  
 Accept /  Cancel
- 4 Verify the correct time display 

**NOTE** Especially when recording with specified start and stop times, confirm that the instrument's clock is set correctly before recording. If not set to the correct time, time-dependent analyses will give incorrect results. Before starting recording, we recommend setting the clock using a standard time source such as a telephone or internet time service (NTP).

**Viewing the Serial No.**

The serial No. of the instrument is displayed. The displayed number should match the number on the label pasted on the back of the instrument. The serial No. is used to identify the instrument for purposes such as user registration.

- 1  Select the screen. 

**NOTE** If the displayed serial No. is not the same as that on the label, please contact your dealer or Hioki representative

## 4.6 Initializing the Instrument (System Reset)

If the instrument begins to exhibit unusual behavior, refer to the "Before returning for repair" (p. 164).

If the cause of the unusual behavior remains undetermined, perform a system reset.

**1** **SYSTEM** Select the screen.

**2** Move to the setting item.

**3** **ENTER**

Resetting system  
Are you sure?  
Yes: ENTER No: ESC

**ENTER** Accept / **ESC/ON** Cancel

**4**

**NOTE** System reset initializes all settings to their factory defaults except for the display language, phase names and phase color settings. System reset also erases all measurement data in internal memory, and all data displayed on screen.

**See:** "Appendix 8 List of Settings (Default Settings)" (p. A13)



# Making Connections and Starting & Stopping Measurement

## Chapter 5

Before recording, be sure to read "Operating Precautions" (p. 7) and "Chapter 3 Measurement Preparations" (p. 37)

### 5.1 Pre-Operation Inspection

Before using the instrument the first time, verify that it operates normally to ensure that no damage occurred during storage or shipping. If you find any damage, contact your dealer or Hioki representative.

#### 1 Inspection before connection

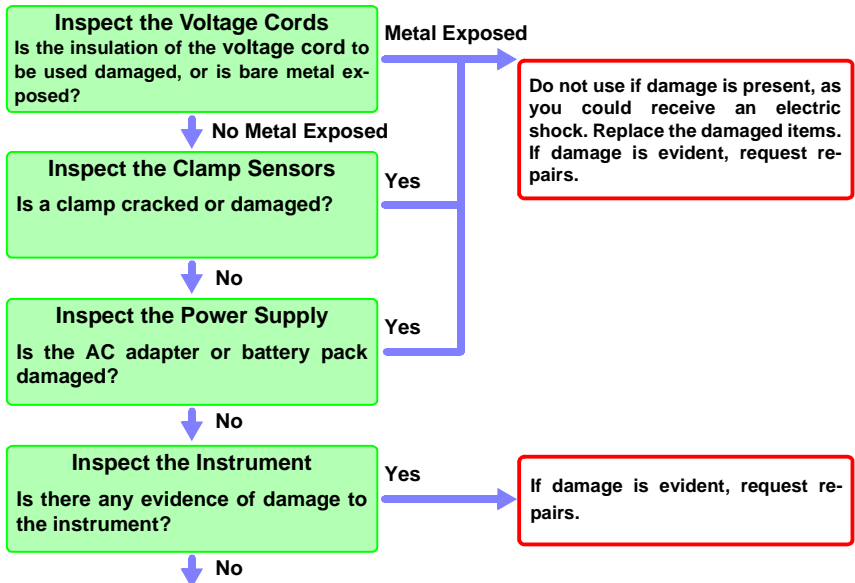

5.1 Pre-Operation Inspection

**2 Confirmation during Connection**

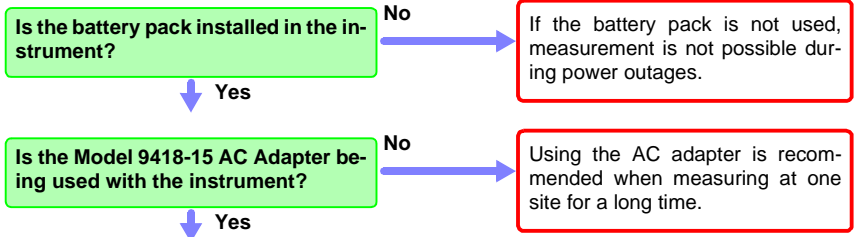

**3 Power-On Confirmation**

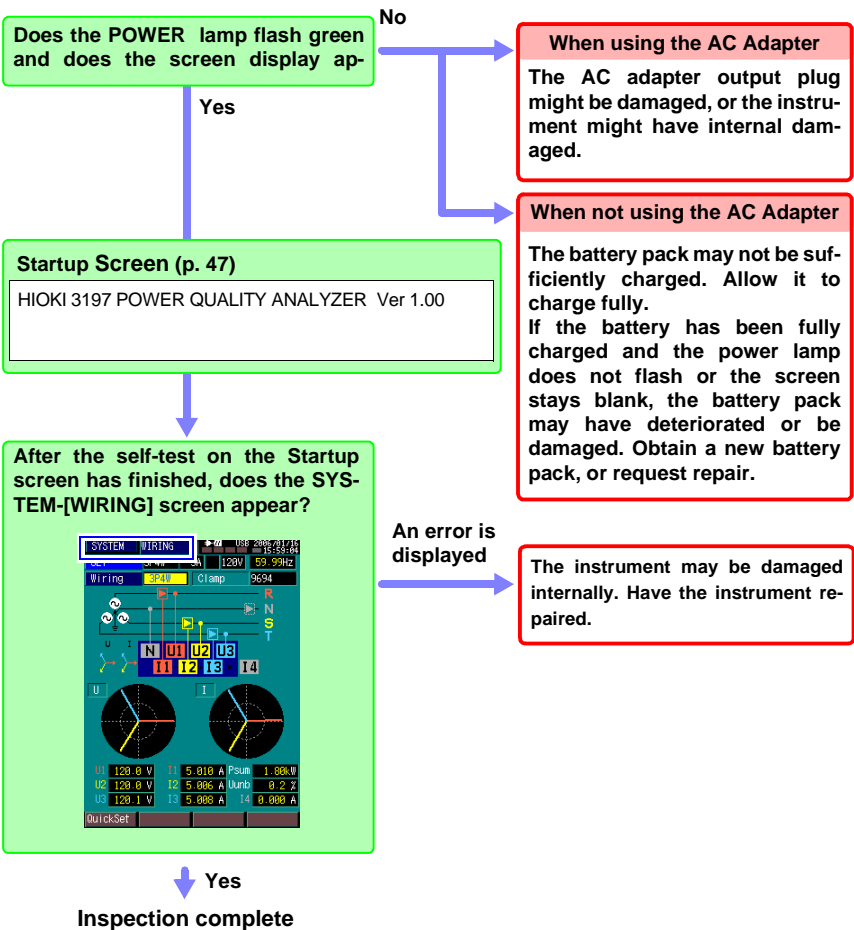



## 5.2 Connecting to the Lines to be Measured

Connect the voltage cords and clamp sensors to the lines to be measured. To ensure proper connections for correct measurements, look at the wiring configuration diagram (p. 83) while making connections.

### NOTE

- When measuring three-phase lines, make connections to the lines to be measured in the same sequence as the measurement channels (channels 1, 2 and 3).
- Although this one instrument can measure various wiring configurations from single-phase 2-wire to three-phase 4-wire, it cannot measure single-phase power in three different systems.

### Connecting voltage cords to lines to be measured

Example:

Secondary side of breaker

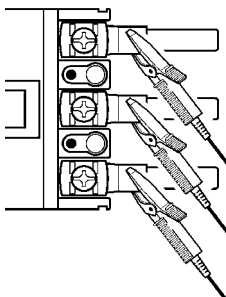

Securely clip the leads to metal parts such as load-side screw terminals or bus bars.

L9438-55 Voltage Cord

5

Connecting clamp sensors to lines to be measured

To measure load current

(Example: Model 9660)

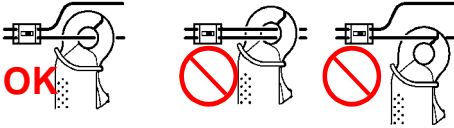

Be sure to attach each clamp around only one conductor. Correct measurement cannot be obtained if a clamp is attached around more than one conductor.

(Example: Model 9660)

(Example: Model 9661)

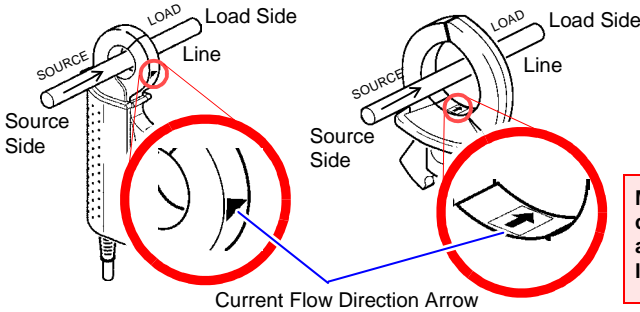

Make certain that the current flow direction arrow points toward the load.

To measure leakage current

(Example: Model 9675)

- Single-phase, 2-wire line: clamp around both wires
- Single-phase, 3-wire line: clamp around all three wires
- Three-phase, 3-wire line: clamp around all three wires
- Earth ground: clamp around just the one line

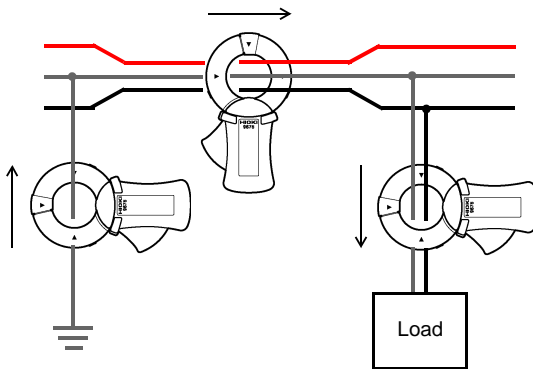

Make certain that the current flow direction arrow points toward the load.

Current Flow Direction Arrow

## System Wiring Diagrams

Press the **[SYSTEM]** key to display the **[WIRING]** screen.

While looking at the diagram, pay attention to the colors of the input terminals and leads.

These examples use the R S T phase names and TYPE 1 (HIOKI) phase colors.

### Single-Phase 2-Wire (1P2W)

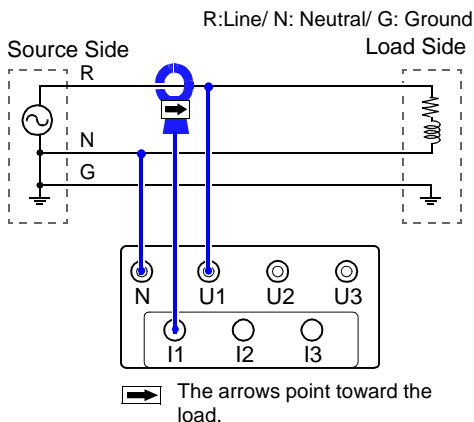
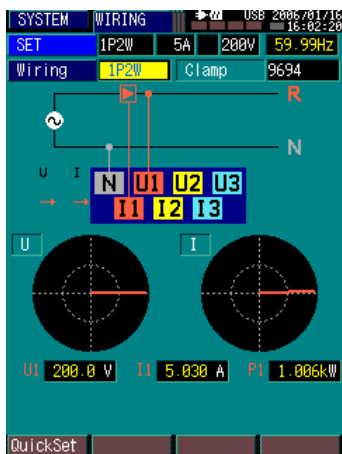

5

### Single-Phase 3-Wire (1P3W)

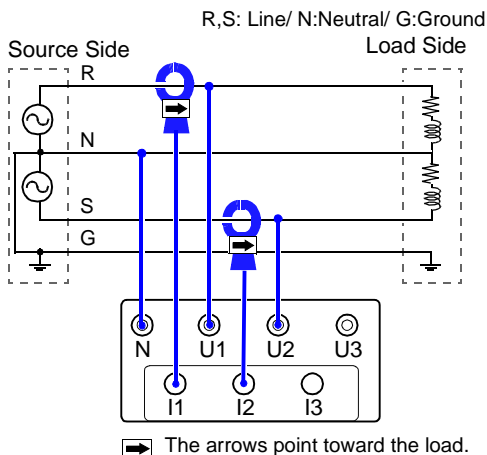
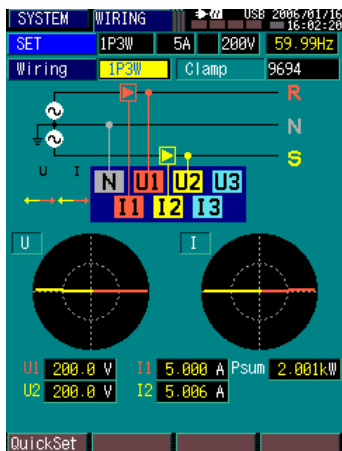

5.2 Connecting to the Lines to be Measured

Three-Phase 3-Wire (3P3W2M)

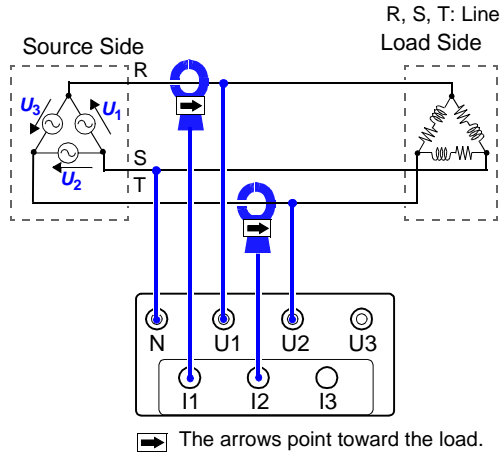
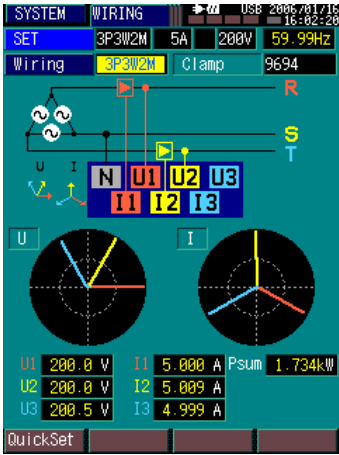

Three-Phase 3-Wire (3P3W3M)

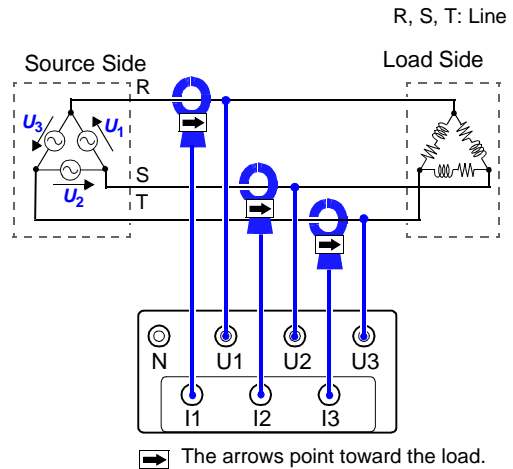
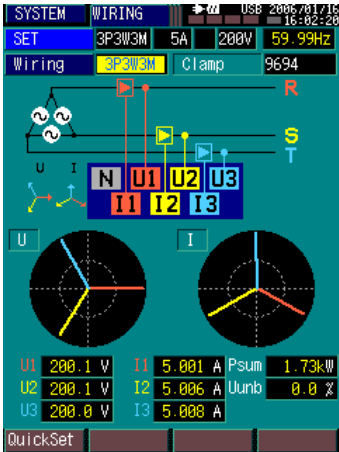

## Three-Phase 4-Wire (3P4W)

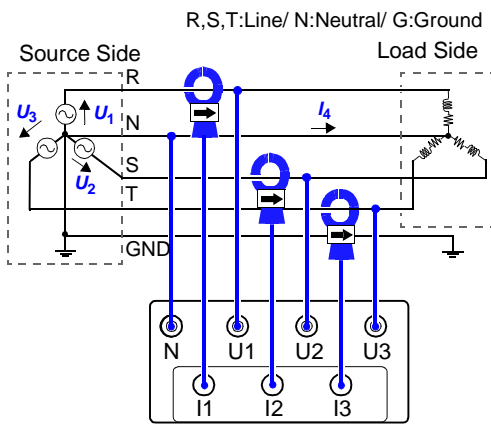
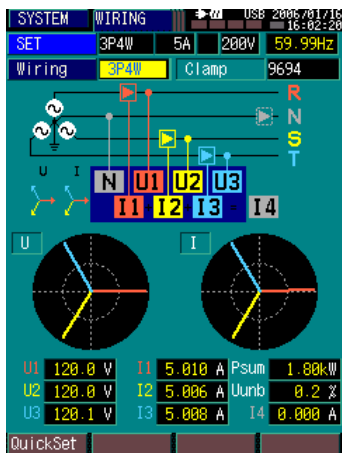

➡ The arrows point toward the load.

5

## Three-Phase 4-Wire (3P4W2.5E)

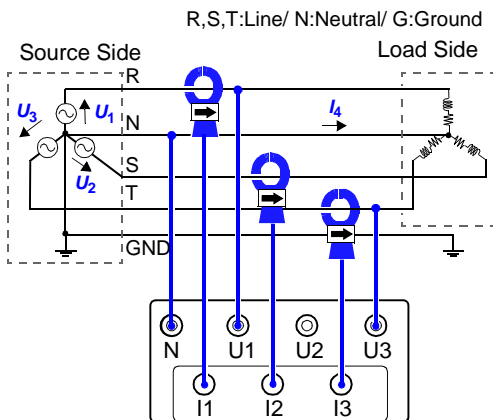
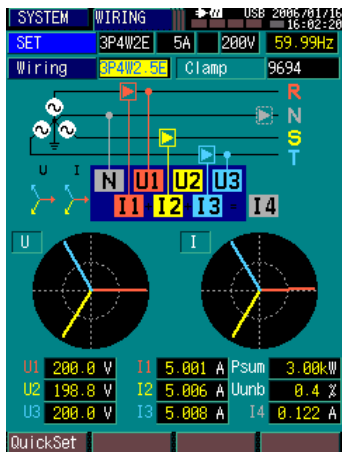

➡ The arrows point toward the load.

## 5.3 Verifying Correct Wiring (Connection Check)

Press the **[SYSTEM]** key to display the **[WIRING]** screen. Verify that the connections are correct from the measured values and vector display.

**1** Verify settings

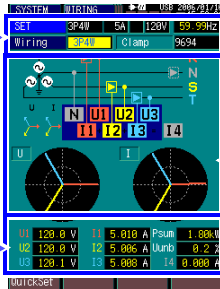

Setting values  
Nominal voltage value

**3** Verify vector display

**2** Verify measured values

Measurement Values

(Example: three-phase 4-wire (3P4W))

### Confirming Measured Values

U1, U2, U3 voltages

I1, I2, I3 currents

U1	120.0 V	I1	5.010 A	Psum	1.00kW
U2	120.0 V	I2	5.006 A	Uunb	0.2 %
U3	120.1 V	I3	5.008 A	I4	0.000 A

Psum ...total 3-phase active power  
Uunb ....voltage unbalance  
I4 .....calculated neutral line current

In this case	Check
If the voltage is above or below the selected [Nominal Voltage]	<ul style="list-style-type: none"> <li>Are the voltage cords securely clipped to the conductors to be measured?</li> <li>Are the voltage cords firmly inserted into the voltage input terminals?</li> <li>Is the nominal voltage setting correct?</li> </ul>
If the current is not suitably within the [Current Range]*	<ul style="list-style-type: none"> <li>Are the clamp sensor cables securely connected to the current input terminals?</li> <li>Are the clamp sensors properly clamped around the conductors to be measured?</li> <li>Is the current range setting correct? Measurement is not possible if the range is set too high for the input level, or if its set so low that the input level reads overrange.</li> </ul>
If the displayed active power value is negative	<ul style="list-style-type: none"> <li>Are the voltage cords misconnected to the input terminals so that measurements display as negative numerical values?</li> <li>Is a clamp sensor indicating a negative value because the current flow direction arrow incorrectly points toward the source?</li> </ul>

\* Value set on the SYSTEM [MEASURE] screen.

## Verify Settings



**Current Range**  
Values displayed in red indicate over-range. Select a higher range, or use a clamp sensor with a higher rating.

**Frequency**  
Values are displayed in red when different from the line frequency setting. Change the line frequency setting if necessary.

## Verify the Vector Display

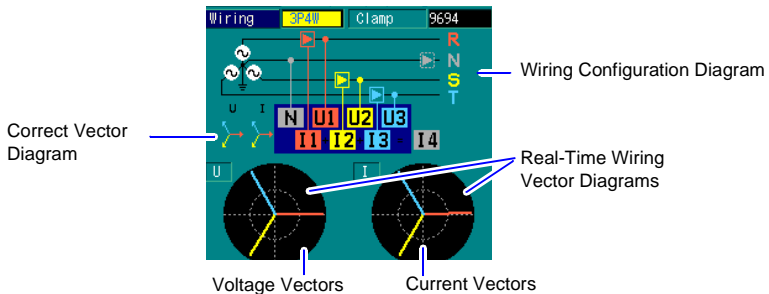

5

## In this case

If the length of the vectors is too short, or of differing lengths

If a vector's direction (phase) or color is wrong

## Check

- Voltage vector  
Verify that the voltage cords are securely connected to the voltage input terminals and lines to be measured.
- Current vector  
Verify that the clamp sensor leads are securely connected to the current input terminals and lines to be measured.
- Voltage vector  
Verify that the voltage cord connections correspond to the wiring diagram.
- Current vector  
Verify that the clamp sensor leads are securely connected to the current input terminals and lines to be measured

## 5.4 Starting and Stopping Recording

### To start and stop recording

Recording can be started and stopped either manually or at preset times.

- Manual recording  
Press the **START/STOP** key to start and stop recording.
- Timed recording  
After setting start and stop times, recording starts and stops at the preset times.

With either method, always press the **START/STOP** key to start recording. You can start and stop recording by pressing **START/STOP** with any screen displayed.

When recording starts, data is recorded to internal memory.

### When recording with partitioned memory

#### To erase recorded data

Press the **DATA RESET** key.

- After pressing the **DATA RESET** key, execute "Store Recording Data".
- After pressing the **DATA RESET** key, execute "Erase the Data Just Recorded".

### When you want to measure once (such as for long-term recording)

### When measuring multiple times (up to four

These are selected by setting memory partitioning.

**See:** "Setting the Method for Recording to Internal Memory (Partition)" (p. 63)

Recording start and stop operations differ according to whether memory partitioning is enabled.

- When memory partitioning is disabled  
Only one-time measurement is available, but available recording time is longer than when memory partitioning is enabled.
- When memory partitioning is enabled  
Four measurement sessions can be recorded, but only one quarter of the amount of data can be recorded (compared to when memory partitioning is disabled).

**See:** "2.5 Internal Operating Status and Memory Usage" (p. 34)  
"Appendix 1 Interval and Recording Time Settings" (p. A1)

#### NOTE

Up to 50 events can be recorded, whether or not memory is partitioned. Verify the number of recordable events before starting recording.



## Starting and Stopping Recording Without Memory Partitioning (Partition: OFF)

### Starting and Stopping Recording Without Memory Partitioning

Confirm that the [Partition] setting on the SYSTEM-[REC&EVENT] screen is set to [OFF] (p. 63).

#### To manually start and stop recording

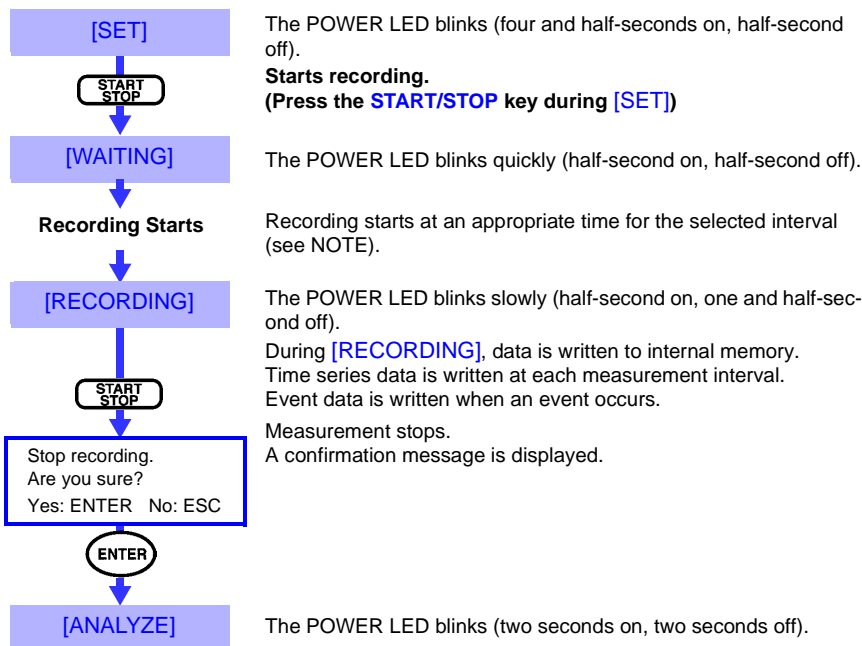

5

#### NOTE The Effect of the Interval Setting on the Start Time

The actual start time depends on the interval setting and current time, as follows. If you press the **START/STOP** key when the current time is 10:41:22

Example 1. If the interval setting is 5 minutes



Example 2. If the interval setting is 30 minutes



[Partition]: with either setting to [ON] or [OFF], recording starts at the appropriate time.

## 5.4 Starting and Stopping Recording

### Starting and Stopping Recording at Preset Times (Time Start)

Before starting recording, confirm that the [Time Start] setting on the SYSTEM-[REC&EVENT] is [ON], and that the start and stop times are set as required.

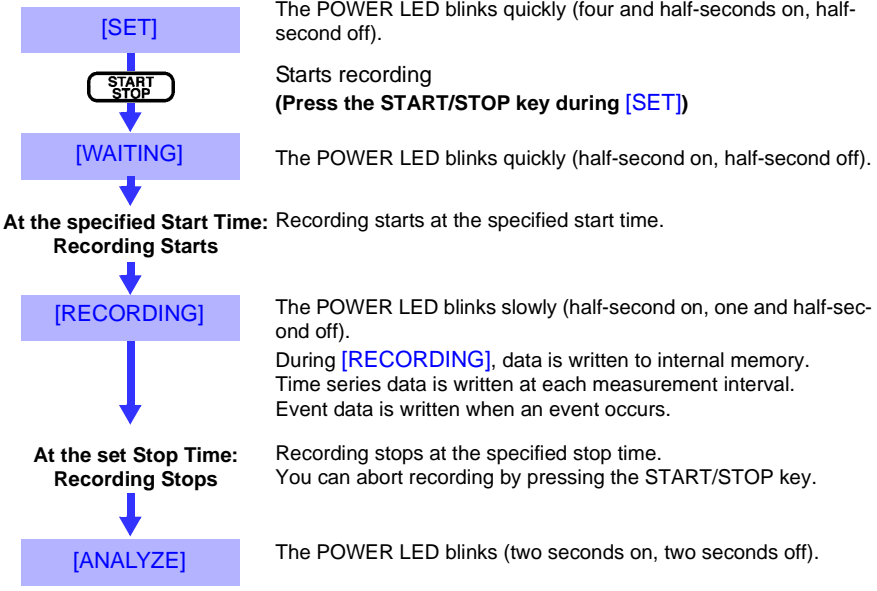

**NOTE** If the specified start time has already passed when you press the **START/STOP** key, "Operation Error!" is displayed.  
In the **[WAITING]** states, if you press the **START/STOP** key before the specified start time, recording is aborted.

### Recording Again, or Erasing Recording Data (Reset)

When recording stops, the [ANALYZE] message indicates that data has been stored in internal memory.

To restart measurement, erase the data stored in the instrument (perform data reset).

[ANALYZE]

DATA  
RESET

Press the **DATA RESET** key when [ANALYZE] appears)

DATA RESET has been  
pressed.  
ALL DATA from internal  
memory will be deleted.  
Continue?  
Yes: ENTER No: ESC

A confirmation message is displayed.

Executes data reset

ENTER

[SET]

5

**NOTE** Recorded data is not erased even when the instrument is turned off. However, it is erased by executing Data Reset.  
To preserve measurement data, copy it to a computer via USB cable

5.4 Starting and Stopping Recording

**Starting and Stopping Recording with Partitioned Memory (Partition: ON)**

When memory partitioning is enabled, the internal memory is partitioned into four parts, and data is recorded into each partition. However, no more than 50 events can be recorded, regardless of whether partitioning is enabled.

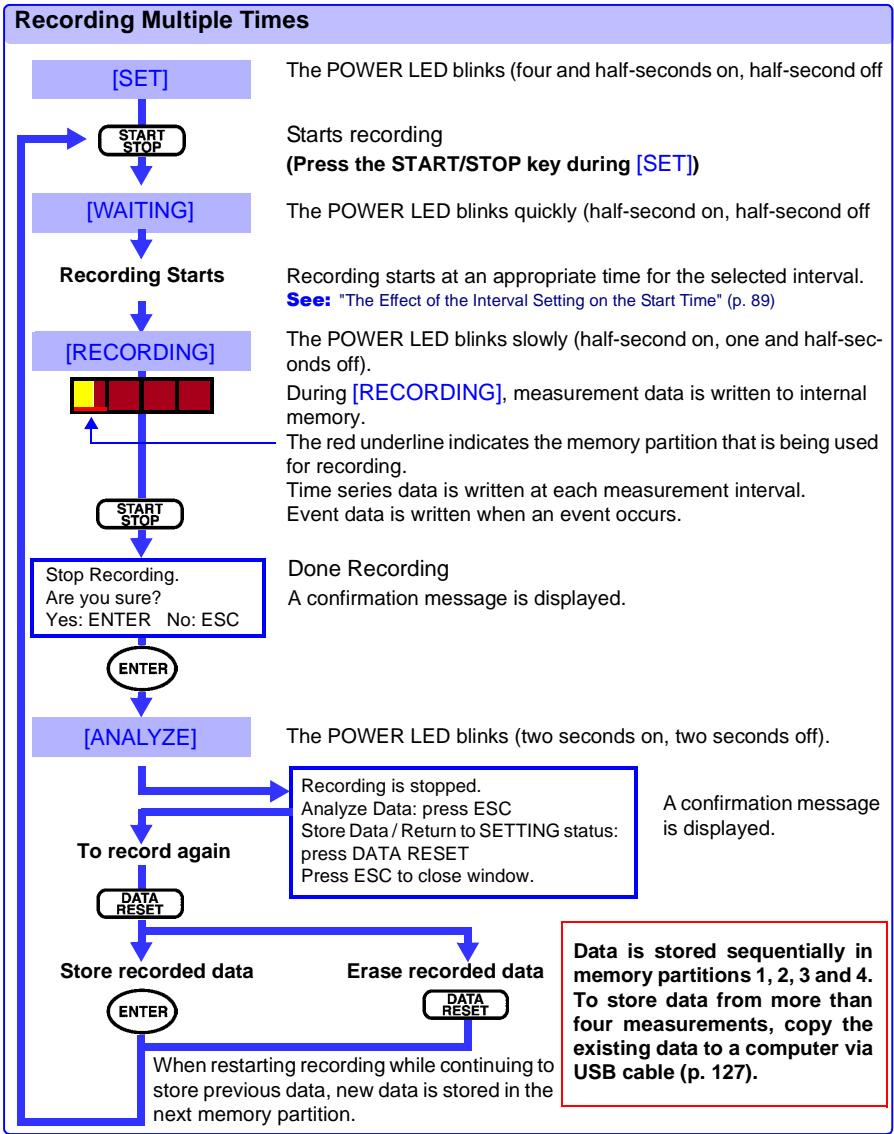

## 5.5 Erasing Data

The method to use for erasing data depends on the internal operating state.

Internal Operating State

Partition: OFF

Partition: ON

[SET]

No data exists.

DATA RESET

DATA RESET has been pressed.  
ALL DATA from internal memory  
will be deleted. Continue?

Yes: ENTER No: ESC

ENTER

Erases all data

5

[ANALYZE]

DATA RESET

DATA RESET has been pressed.  
ALL DATA from internal memory  
will be deleted. Continue?

Yes: ENTER No: ESC

ENTER

Erase

DATA RESET

Save the recorded data: ENTER  
Cancel / Analyze: ESC  
Delete the recorded data: DATA RESET

DATA RESET

Erases the current data

## 5.6 Recovering From a Long-Term Power Outage

If the power supplied to the instrument is interrupted, operation continues on the (charged) battery pack. However, if the power is not restored for a long time (four to six hours or more), the instrument shuts off.

However, if memory partitioning is set [ON], and power fails while recording, recording resumes in the next partition when power is restored (for example, if power fails while recording in Memory Partition 2, recording resumes in Partition 3).

The following message appears initially when power is restored, and recording resumes immediately.

```
HIOKI 3197 POWER QUALITY ANALYZER V 1.00

Recording Re-started.
```

**NOTE** However, if recording in Memory Partition 4 or with memory partitioning set [OFF] when power is interrupted, recording does not resume when power is restored (even though "Recording Re-started" still appears)

Internal Operating State	Partition	Memory No.	Operation when power is restored
[RECORDING]	[ON]	No. 1, 2, or 3	Recording resumes in the next memory partition.
		No. 4	Recording does not resume.
	[OFF]	-	

### Nominal continuous operating time (battery only)

After full charge, with LCD backlight auto-off (after 5 min.) enabled: Approx. 6 hours

After full charge, with LCD backlight always on : Approx. 4 hours

(operating at 23°C)

# Viewing Data

# Chapter 6

The three data display screen types are called [VIEW], [TIME PLOT] and [EVENT].

## Viewing Instantaneous Data

(displays the measurement status about once per second)

Screen Display	Setting Contents	Ref.
<b>VIEW</b>	[WAVEFORM] [VECTOR] [HARMONICS] [DMM]	Displays instantaneous measurement values. Measurement data can be viewed at any time regardless of recording start or stop state.
		"6.1 Viewing Instantaneous Data (VIEW Screen)" (p. 96)

## View Recording Data

(displays the current recording conditions or recorded results)

<b>TIME PLOT</b>	[RMS] [DIP/SWELL] [DEMAND] [ENERGY]	Displays data at each measurement interval as a time series graph. Shows fluctuations that occur between recording start and stop.
		"6.2 Displaying a Time Series Plot (TIME PLOT screen)" (p. 102)
<b>EVENT</b>	[WAVEFORM] [DETAILS] [RMS WAVE] [INRUSH]	Displays the results of event detection. Shows the contents of events detected between recording start and stop.
		"6.3 Viewing Anomalous Phenomena (EVENT screen)" (p. 108)

## 6.1 Viewing Instantaneous Data (VIEW Screen)

There are four types of VIEW screens: [WAVEFORM], [VECTOR], [HARMONICS] and [DMM]. Press the VIEW key to switch between them. The VIEW screens display instantaneous data by refreshing about once per second, regardless of the internal operating state ([SET], [RECORDING] or [ANALYZE]).

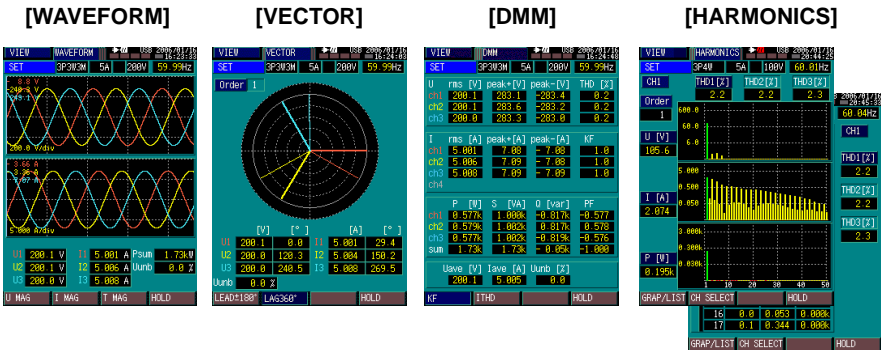

### Holding the Screen Display (Common to all VIEW screens)

The screen display can be held (screen refresh stopped). Although the VIEW screen is refreshed in real-time, values and graphs can be easier to read by holding the display.

Display hold is also useful prior to executing screen shot (**HARD COPY**).

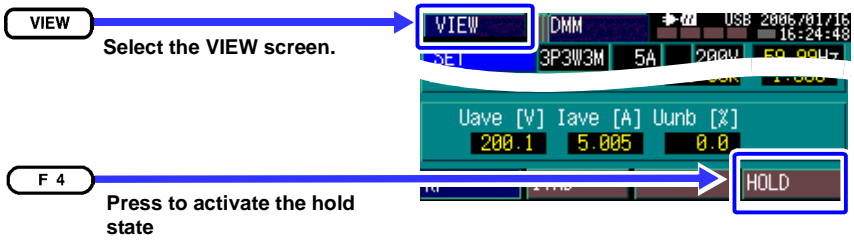

Press to activate the hold state

When you press the F4 key, its display label changes to **HOLD** as the display is held.

To cancel, press the F4 (Cancel Hold) key once.

**NOTE**

While the F4 key label is **HOLD**, the display is not refreshed. To refresh the display, press the **F4** (Cancel Hold) key to cancel the hold state.



## Viewing Waveforms

[WAVEFORM]

Voltage and current waveforms and rms values (voltage, current and active power) are displayed together.

The number of displayed channel waveforms depends on the selected wiring configuration.

**VIEW** → Select the screen.

**Magnifying and Compressing Waveforms on the Vertical Axis**  
Changing magnification of the vertical axis (voltage/current)

Vertical magnification can be selected from factors of 1/2, 1, 2.5, 5, 10, 25, 50 and 100.

**To change voltage magnification** **F 1**

Scale per division:  
1 kV/div, or 500, 200, 100, 50, 20, 10 or 5 V/div

**To change current magnification** **F 2**

Scale per division:  
Available settings are multiples of the current range.  
Available magnification factors are 0.5, 1, 2.5, 5, 10, 25, 50 or 100 times the current range.

**Magnifying and Compressing Waveforms on the Horizontal Axis**  
Changing magnification of the horizontal (time) axis

Available magnification factors are 1, 2, 4 or 8 times horizontally.

**To change time axis magnification** **F 3**

**F 1** **F 2** **F 3** **F 4**  
(p. 96)

Magnification changes each time you press a key.

## Viewing Instantaneous Waveform Values



Move the cursor along a waveform and read the instantaneous values at the cursor.

Press the right or left cursor key to move the cursor in the respective direction.

6.1 Viewing Instantaneous Data (VIEW Screen)

**Vector Display [VECTOR]**

Voltage and current vectors are displayed. The rms voltages and phase angles, and the rms currents and phase angles of the fundamental waveform are also displayed. The number of channels for which vectors are displayed depends on the selected wiring configuration.

**VIEW** → Select the screen.

**Changing the phase angle display method**

**To display ±180° lead** **F 1**

Displays -180° to -0° or 0° to 180° as positive lead.

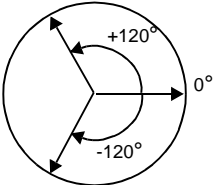

**To display 360° lag** **F 2**

Displays 0° to 360° as positive lag.

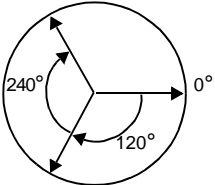
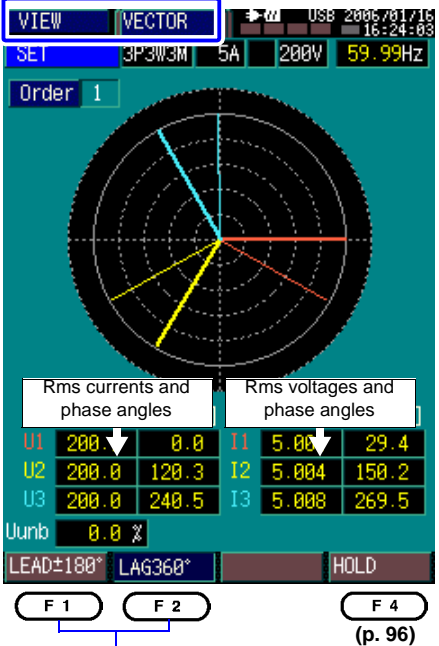
VIEW VECTOR

SET 3P3W3M 5A 200V 59.99Hz

Order 1

Rms currents and phase angles		Rms voltages and phase angles			
U1	200.0	0.0	I1	5.00	29.4
U2	200.0	120.3	I2	5.004	150.2
U3	200.0	240.5	I3	5.008	269.5
Uunb	0.0	%			

LEAD±180° LAG360° HOLD

F 1 F 2 F 4 (p. 96)

The selected item is indicated by its "key-pressed" appearance on the display. Press another key to change the selection.

Thick lines indicate voltage vectors, and thin lines indicate current vectors.

## Displaying Harmonics

[HARMONICS]

Harmonics can be displayed in a bar graph or in a list. The display method is selected by the F1 key.

### Displaying the harmonics bar graph

The harmonics bar graph displays voltage, current and power from the fundamental waveform to the 50th order.

In the bar graph, yellow indicates positive values and red indicates negative values. Voltage total harmonic distortion (THD) is also displayed.

**1** **VIEW** → Select the screen.

**2** **F 1** → Select the bar graph [GRAP/LIST] display

**To change the displayed channel**  
Changes in the sequence: Channels that can be switched are determined by the wiring configuration.

**F 2** → CH1 → CH2 → CH3

**To view the values of each harmonic order**  
Green indicates the cursor position. Move the cursor to read the value of each harmonic order. Press the right or left cursor key to move the cursor in the respective direction.

**GRAP/LIST** **CH SELECT** **HOLD**

**F 1** **F 2** **F 4** (p. 96)

The channel changes each time you press the key.

The bar graph and list selection changes each time you press the key.

**NOTE** The voltage harmonic calculation method (RMS [V] ↔ Content Percentage [%]) can be changed on the SYSTEM-[MEASURE] screen (p. 62).

6.1 Viewing Instantaneous Data (VIEW Screen)

Displaying the Harmonic List

The harmonic list shows values of voltage, current and power.  
The voltage total harmonic distortion (THD) is also displayed.

**1** **VIEW** Select the screen.

**2** **F 1** Select the [GRAP/LIST] display

**To change the displayed channel**  
Changes in the sequence: Channels that can be switched are determined by the wiring configuration.  
F 2 → CH1 → CH2 → CH3

**Changes the displayed order**  
Changes the displayed order   
The list scrolls from the fundamental waveform up to the 50th order.

**GRAP/LIST** CH SELECT HOLD

F 1 F 2 F 3 F 4 (p. 96)

The channel changes with each key press.  
The bar graph and list selection changes with each key press.

Order	U [V]	I [A]	P [W]	
1	1.0	0.7	0.705	0.000k
2	0.0	0.0	0.000k	0.000k
3	1.3	1.028	-0.002k	0.000k
4	0.0	0.0	0.000k	1.000k
5	1.5	1.147	-0.000k	0.000k
6	0.0	0.043	0.000k	0.000k
7	1.0	0.713	0.000k	0.000k
8	0.1	0.019	-0.000k	0.000k
9	0.2	0.570	0.000k	0.000k
10	0.0	0.0	0.000k	0.000k
11	0.1	0.0	0.000k	0.000k
12	0.0	0.0	0.000k	0.000k
13	0.2	0.507	-0.000k	0.000k
14	0.0	0.065	0.000k	0.000k
15	0.2	0.381	0.000k	0.000k
16	0.0	0.053	0.000k	0.000k
17	0.1	0.344	0.000k	0.000k

Labels on screen: Voltage, Active Power, Current, THD1 [%], THD2 [%], THD3 [%], Voltage Total Harmonic Distortion.

**NOTE** The voltage harmonic calculation method (RMS [V] ↔ Content Percentage [%]) can be changed on the SYSTEM-[MEASURE] screen (p. 62).

### Displaying the DMM Screen (voltage, current and instantaneous power values) [DMM]

The following measurement values are displayed numerically (DMM screen).

<b>U rms</b>	<b>U peak+</b>	<b>U peak-</b>	<b>U THD</b>
rms voltage	Voltage Waveform Peak Value		Voltage Total Harmonic Distortion
<b>I rms</b>	<b>I peak+</b>	<b>I peak-</b>	<b>KF/ I THD</b>
Rms Current	Current Waveform Peak Value		K Factor/ Current Total Harmonic Distortion
<b>P</b>	<b>S</b>	<b>Q</b>	<b>PF</b>
Active Power	Apparent Power	Reactive Power	Power Factor (or DPF - Displacement Power Factor)
<b>Uave</b>	<b>Iave</b>	<b>Uunb</b>	
Rms Voltage Channel average	Rms Current Channel average	Voltage Unbalance	

The number of channels for which parameters are displayed depends on the selected wiring configuration.

Select the screen.

U rms [V]	peak+ [V]	peak- [V]	THD [%]
ch1 200.1	283.1	-283.4	0.2
ch2 200.1	283.6	-283.2	0.2
ch3 200.0	283.3	-283.0	0.2

I rms [A]	peak+ [A]	peak- [A]	KF
ch1 5.001	7.08	-7.08	1.0
ch2 5.006	7.09	-7.08	1.0
ch3 5.008	7.09	-7.09	1.0
ch4			

P [W]	S [VA]	Q [var]	PF
ch1 0.577k	1.000k	-0.817k	-0.577
ch2 0.579k	1.002k	0.817k	0.578
ch3 0.577k	1.000k	-0.817k	-0.577
sum 1.73k	1.73k	-0.05k	-1.000

3 phase summation

Select KF or I THD (p. 96)

#### NOTE

When 3P3W2M or 3P3W3M is selected, the active power(P1,P2,P3), reactive power(Q1,Q2,Q3), apparent power(S1,S2,S3), and power factor(PF1,PF2,PF3) of each channel are meaningless data. Use the total values of Psum,Qsum,Ssum, and Psum only. The data of each channel is used as reference data for checking the wiring.

## 6.2 Displaying a Time Series Plot (TIME PLOT screen)

There are four TIME PLOT screens, called [RMS], [DIP/SWELL], [DEMAND] and [ENERGY]. The displayed screen changes each time you press the TIME PLOT key. During the [RECORDING] internal operating state, the graphs on the TIME PLOT screen are refreshed at each measurement interval.

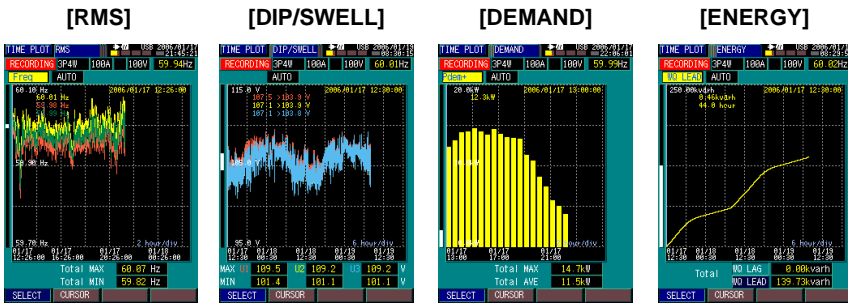

### Common Operations and Screen Items (Common to TIME PLOT screens)

#### Screen Refresh

All graph plots begin from the left side, and extend to the right each time the display refreshes. When a plot reaches the right side, it is horizontally compressed by about half as it is continued.

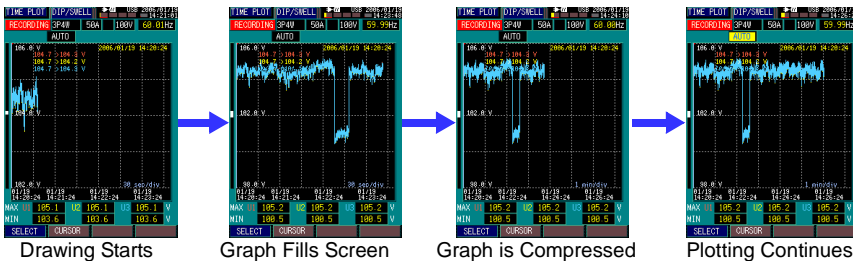

#### Internal memory compression

When internal memory becomes filled with recorded memory data for graphs, the internal memory is compressed and recording continues at a longer interval.



**NOTE** For additional details about screen refresh, internal memory compression and maximum recording times, refer to "Recordable TIME PLOT data period" (p. 155), "Appendix 1 Interval and Recording Time Settings" (p. A1).

## Displaying the Rms Fluctuation Graph [RMS]

[RMS]

View a fluctuation graph of parameters selected from voltage; current; voltage and current waveform peak values ( $\pm$ ); frequency; active, reactive and apparent power; power factor; displacement power factor; THD and voltage unbalance factor.

**TIME PLOT** Select the screen.

**TIME PLOT RMS**

RECORDING 3P4W 100A 100V 59.94Hz

Freq AUTO

2006/01/17 12:26:00

Cursor Date/Time

Graph Display Position

Maximum Value: Yellow  
Average Value: Green  
Minimum Value: Red

59.90 Hz

60.07 Hz

59.98 Hz

59.70 Hz

2 hour/div

01/17 01/17 01/17 01/18  
12:26:00 15:26:00 20:26:00 00:26:00

Total MAX 60.07 Hz  
Total MIN 59.82 Hz

SELECT CURSOR

F 1 F 2

Selects cursor operation.  
Changes displayed parameters.

Shows the global maximum (Total MAX), and minimum (Total MIN) values over the whole measurement period.

**Selecting, Magnifying and Reducing Display Parameters on the Vertical Axis**

**F 1** Moving to a setting item  
Left: Display contents (p. 104)  
Right: Time axis (display magnification)  
AUTO, x1, x2, x5, x10, x25, x50

**ENTER** Select from a pull-down menu

**ENTER**

**Viewing Values with the Cursor**

**F 2**

**Scrolls the fluctuation graph vertically**

**F 2** Scrolling is useful for analyzing the display after magnifying the vertical axis.

6.2 Displaying a Time Series Plot (TIME PLOT screen)

Selectable Display Parameters

Display Parameter	Display Contents	Display Parameter	Display Contents
Freq	Frequency	U3peak+	CH3 (+) voltage waveform peaks
U1	CH1 voltage	U3peak-	CH3 (-) voltage waveform peaks
I1	CH1 current	I3peak+	CH3 (+) current waveform peaks
U2	CH2 voltage	I3peak-	CH3 (-) current waveform peaks
I2	CH2 current	Uave	CH average voltage
U3	CH3 voltage	Iave	CH average current
I3	CH3 current	Psum	3-phase total active power
I4	Neutral current (calculated)	Qsum	3-phase total reactive power
U1peak+	CH1 (+) voltage waveform peaks	Ssum	3-phase total apparent power
U1peak-	CH1 (-) voltage waveform peaks	PFsum	3-phase total power factor / Displacement power factor
I1peak+	CH1 (+) current waveform peaks	THD1	CH1 voltage total harmonic distortion
I1peak-	CH1 (-) current waveform peaks	THD2	CH2 voltage total harmonic distortion
U2peak+	CH2 (+) voltage waveform peaks	THD3	CH3 voltage total harmonic distortion
U2peak-	CH2 (-) voltage waveform peaks	Uunb	Voltage unbalance factor
I2peak+	CH2 (+) current waveform peaks		
I2peak-	CH2 (-) current waveform peaks		

Some parameters are not selectable depending on the selected wiring configuration.

For each displayed parameter, the maximum, average and minimum values within the interval are calculated and recorded.

TIME PLOT - [RMS]

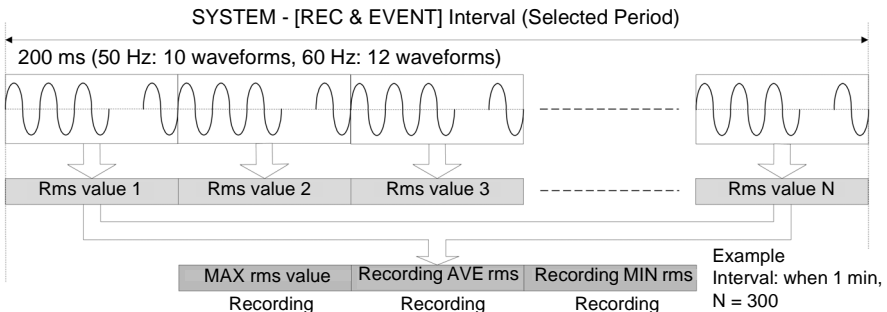



Displaying a Voltage Fluctuation Graph

[DIP/SWELL]

An rms voltage fluctuation graph is displayed.

You can view this graph to confirm rms voltage fluctuations when evaluating voltage dip (DIP), voltage swell (SWEL) and interruptions.

TIME PLOT

Select the screen.

TIME PLOT [DIP/SWELL]

RECORDING 3P4W 100A 100V 60.01Hz

AUTO

Magnifying and Compressing on Vertical Axis

F 1

Moving to a setting item  
Vertical axis (display magnification)  
AUTO, x1, x2, x5, x10, x25, x50  
Left: Display contents (see table below)  
Right: Time axis

ENTER

ENTER

ENTER

Viewing Values with the Cursor

F 2

Maximum value Minimum value  
U1 102.7 V > 102.1V  
U2 102.8 V > 102.2V  
U3 102.7 V > 102.1V

ENTER

Scrolls the fluctuation graph vertically

F 2

Scrolling is useful for analyzing the display after magnifying the vertical axis.

ENTER

ENTER

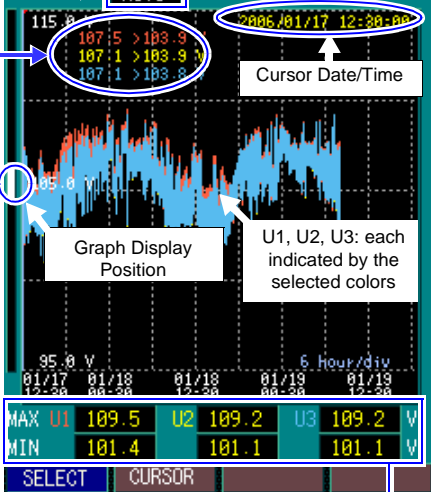

F 1

Selects cursor operation.

Changes displayed parameters.

Shows the global maximum (Total MAX), and minimum (Total MIN) values over the whole measurement period for each channel.

TIME PLOT -[DIP/SWELL]

SYSTEM-[REC & EVENT] Interval (Selected Period)

200 ms (50 Hz: 10 waveforms, 60 Hz: 12 waveforms)

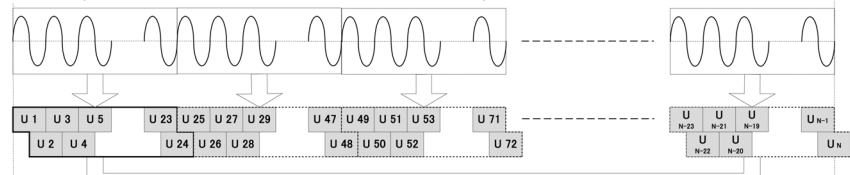

Rms voltage is calculated for each waveform shifted by one-half cycle.  
Example. When measuring 12 cycles at 60 Hz, 24 values of U are calculated within 200 ms.

MAX U U  
MIN U U

Example.  
Interval: 1 min,  
N = 7200

6.2 Displaying a Time Series Plot (TIME PLOT screen)

Displaying a Demand Graph [DEMAND]

The demand value is the average power [kW] consumed during the demand period (typically 30 minutes), and is used in power company transactions. The demand graph is refreshed after each demand period. A bar graph is displayed at the start of recording, but for long-term recording, the display changes to a fluctuation graph.

**TIME PLOT** Select the screen.

**Selecting, Magnifying and Reducing Display Parameters**

**F 1** Moving to a setting item  
 Left: Display contents (see table below)  
 Right: Vertical axis  
 AUTO, x1, x2, x5, x10, x25, x50

**ENTER**  
 Select from a pull-down menu

**ENTER**

**Viewing Values with the Cursor**

**F 2** 3-Phase Total Demand Value

**Scrolls the fluctuation graph vertically**

**F 2** Scrolling is useful for analyzing the display after magnifying the vertical axis.

**F 1** **F 2**  
 Selects cursor operation.  
 Changes displayed parameters.

Shows the global maximum demand value (Total MAX) and average demand value (Total AVE) for the whole measurement period.

Display Parameter	Display Contents
Pdem+	Active Power Demand (consumption only)
Pdem-	Active Power Demand (regenerated only)
QdemLAG	Reactive Power Demand (lagging only)
QdemLEAD	Reactive Power Demand (leading only)

**NOTE** The interval and demand period for a time series graph can be set independently. So there are some cases where the recordable period for the time series graph and the demand period are different (p. 155).

## Displaying an Energy Consumption Graph

[ENERGY]

Energy values are calculated as power times time.

Active power value [Wh] = Active power [W] x Time [h]

Reactive power value [Varh] = Reactive power [Var] x Time [h]

Example. When a 100 W light bulb is lit continuously for two hours, 200 Wh of active power is consumed.

Power values used for power company transactions are usually active power values [kWh]. This instrument displays the cumulative power value from the beginning to the end of a recording as a graph.

**TIME PLOT** → **TIME PLOT ENERGY**

Select the screen.

**Selecting, Magnifying and Reducing Display Parameters**

**F 1**

Moving to a setting item  
 Left: Display contents (see table below)  
 Right: Vertical axis  
 AUTO, x1, x2, x5, x10, x25, x50

**ENTER**

Select from a pull-down menu

**ENTER**

**Viewing Values with the Cursor**

**F 2**

The energy value is the 3-phase total  
 Elapsed time is also displayed (HH:MM:SS)

**Scrolls the fluctuation graph vertically**

**F 2**

Scrolling is useful for analyzing the display after magnifying the vertical axis.

**Cursor Date/Time**

**Graph Display Position**

**Total** WQ LAG 0.00kvarh  
 WQ LEAD 139.73kvarh

**F 1** **F 2**

**Selects cursor operation. Changes displayed parameters.**

Shows the global maximum energy value over the whole measurement period.

Display Parameter	Display Contents
WP+	Active Power (consumption only)
WP-	Active Power (regenerated only)
WQLAG	Reactive Power (lagging only)
WQLEAD	Reactive Power (leading only)

## 6.3 Viewing Anomalous Phenomena (EVENT screen)

There are four EVENT screens, called [LIST], [WAVEFORM], [VOLTAGE] and [INRUSH]. The displayed screen changes each time you press the EVENT key.

The Event List appears on all screens.

During the [RECORDING] internal operating state, the EVENT screens are refreshed every time an event occurs. During the [ANALYZE] internal operating state, event occurrence results are preserved.

Each screen is related to the others by the event occurrence. For example, if you select the No. 24 voltage dip event on the event [DETAILS] screen and then switch to the [WAVEFORM] screen, the voltage waveform of the No. 24 voltage dip is displayed, and switching to the [RMS WAVE] screen displays the event voltage fluctuation graph of the No. 3 voltage dip.

### Viewing the [RMS WAVE] Screen

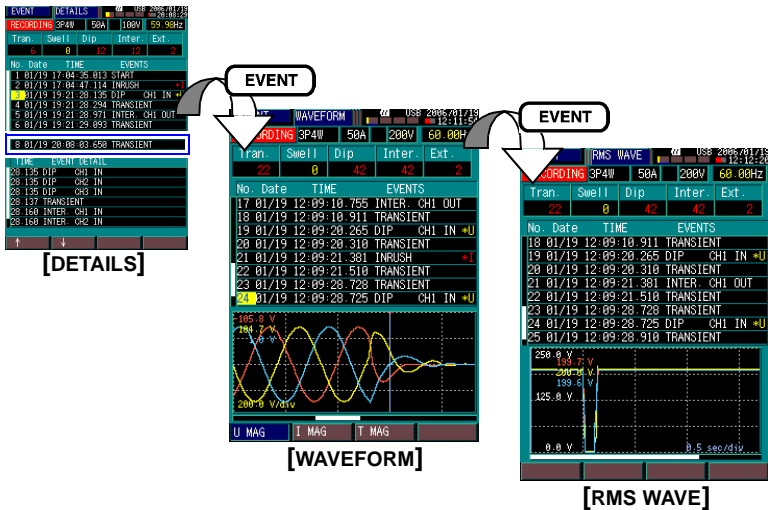

## Viewing the [INRUSH] Screen

Tran.	Swell	Dip	Infer.	Ext.
0	0	0	0	220

  

No.	Date	TIME	EVENTS
1	02/06	13:36:55.020	START
2	02/06	13:36:55.351	INRUSH
3	02/06	13:36:55.436	INRUSH
4	02/06	13:36:55.635	INRUSH
5	02/06	13:36:56.036	INRUSH
6	02/06	13:36:56.268	INRUSH
7	02/06	13:36:59.268	INRUSH
8	02/06	13:36:59.435	INRUSH

  

TIME	EVENT DETAIL
55-351	INRUSH

[DETAILS]

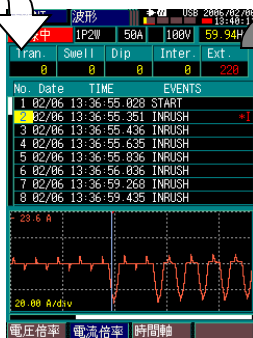

[WAVEFORM]

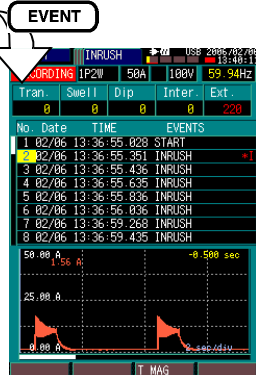

[INRUSH]

Detection Methods and Recording Contents of Events

Rms voltage (Urms1/2)  
(use to detect voltage swells, voltage dips and interruptions)

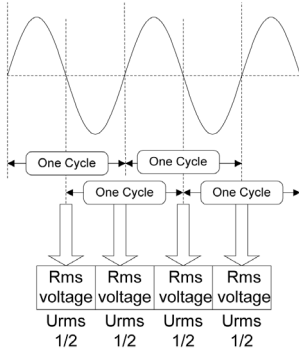

- Calculation Method  
Rms voltage (Urms 1/2) is calculated separately for three channels at every half cycle.

Voltage Swell

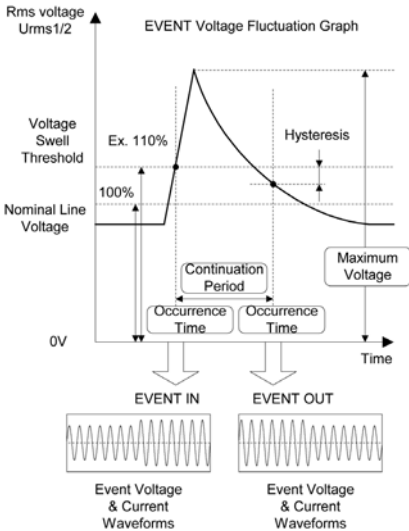

- Detection Method  
Detect Using Urms 1/2.  
Set the threshold as a percentage of nominal voltage.  
When the rms voltage rises above the positive threshold, it is detected as an "EVENT IN (on set)" event. Subsequently, when the voltage falls back below the threshold (minus appropriate hysteresis), it is detected as an "EVENT OUT (recovery)" event.
- Recording Contents  
Event list data, voltage/current waveforms, event voltage fluctuation graph
- Event Data Format  
EVENT IN (On set): Event no., occurrence date, occurrence time, event type, channel and IN  
EVENT OUT (Recovery): Event no., occurrence date, occurrence time, event type, channel, OUT, maximum voltage and continuation period
- Event Voltage Fluctuation Graph  
Fluctuation graph of Urms from about 0.5 seconds before detection to about 2.5 seconds after detection

## Voltage Dip

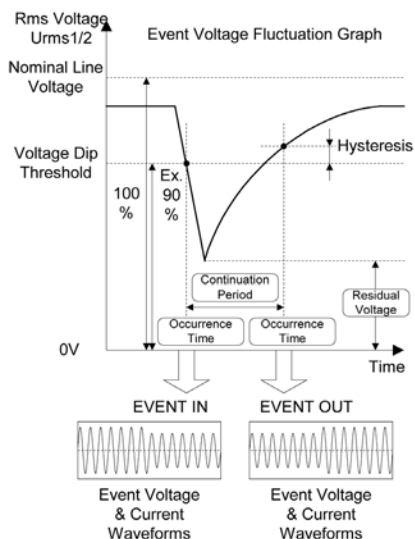

- Detection Method  
Detect Using Urms 1/2.  
Set the threshold as a percentage of nominal voltage. When the rms voltage falls below the negative threshold, it is detected as an "EVENT IN (onset)" event. Subsequently, when the voltage rises back above the threshold (plus appropriate hysteresis), it is detected as an "EVENT OUT (recovery)" event.
- Recording Contents  
Event list data, voltage/current waveforms, event voltage fluctuation graph
- Event Data Format  
EVENT IN (Onset): Event no., occurrence date, occurrence time, event type, channel, IN  
EVENT OUT (Recovery): Event no., occurrence date, occurrence time, event type, channel, OUT, residual voltage, continuation period
- Event Voltage Fluctuation Graph  
Fluctuation graph of Urms from about 0.5 seconds before detection to about 2.5 seconds after detection

6

## Interruption

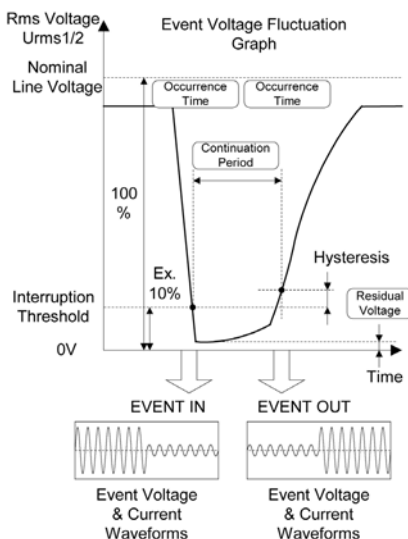

- Detection Method  
Detect using Urms 1/2. Set the threshold as a percentage of nominal voltage. When the rms voltage falls below the threshold, it is detected as an "EVENT IN (onset)" event. Subsequently, when the voltage rises back above the threshold (plus appropriate hysteresis), it is detected as an "EVENT OUT (recovery)" event.
- Recording Contents  
Event list data, voltage/current waveforms, event voltage fluctuation graph
- Event Data Format  
EVENT IN (Onset): Event no., occurrence date, occurrence time, event type, channel, IN  
Event EVENT OUT (Recovery): Event no., occurrence date, occurrence time, event type, channel, OUT, residual voltage, continuation period
- Event Voltage Fluctuation Graph  
Fluctuation graph of Urms from about 0.5 seconds before detection to about 2.5 seconds after detection

6.3 Viewing Anomalous Phenomena (EVENT screen)

**Transient Overvoltage**

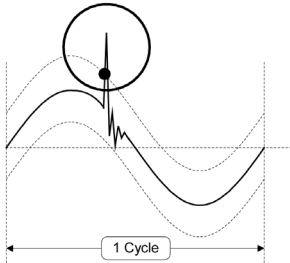

- Detection Method  
During each cycle, signals between 10 and 100 kHz are detected by comparator on any of three voltage channels if their amplitude exceeds  $\pm 70.7 V_{peak}$ .
- Presence Detection
- Recording Contents  
Event List data, voltage/current waveforms
- Event Data Format
- EVENT IN (On set): Event number, occurrence date, occurrence time, Event type, IN
- EVENT OUT (Recovery): Event number, occurrence date, occurrence time, Event type, OUT, duration

Note 1:  
Only the presence or non-presence of transient overvoltage is detected.  
Voltage and current waveforms at the time of event detection can be displayed. However, the transient overvoltage waveform itself (circled in the diagram) cannot be displayed.

Note 2:  
Transient overvoltage that occurs repeatedly will be detected as IN/OUT events. A transient overvoltage occurring even once during a 200 ms period will be identified as an IN event. Subsequent occurrence will be monitored every 200 ms and when it is no longer detected, an OUT event will be identified.

**Rms Current (used to detect inrush current)**

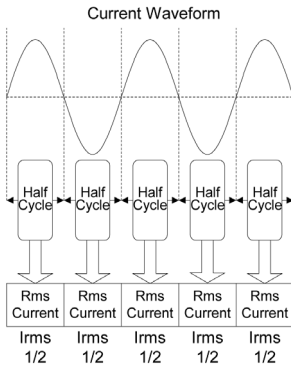

- Calculation Method  
Rms current is calculated separately at each half-cycle on three current channels ( $I_{rms} 1/2$ ).



## Inrush Current

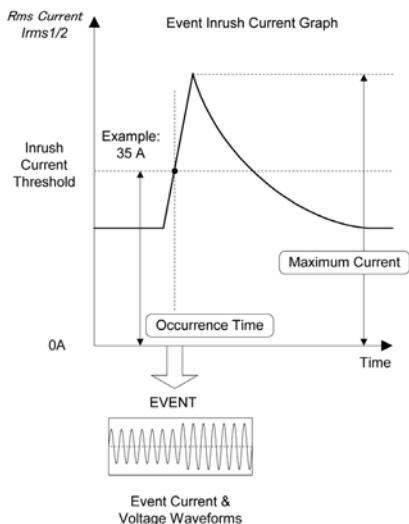

- **Detection Method**  
Detects using Irms 1/2.  
Set the current threshold value.  
An event is detected when the current exceeds the threshold in the positive direction.
- **Recording Contents**  
Event list data, voltage/current waveforms, inrush current fluctuation graph
- **Event Data Format**  
Event number, occurrence date, occurrence time, event type, channel and maximum current
- **Inrush Current Fluctuation Graph**  
Fluctuation graph of Irms from about 0.5 seconds before detection to about 29.5 seconds after detection

6

## Timer

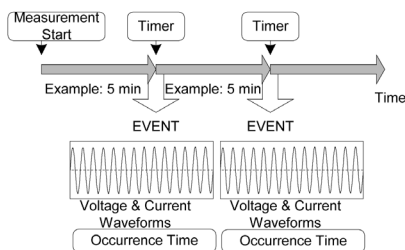

- **Detection Method**  
A detected event occurs after every set timer interval.
- **Recording Contents**  
Event list data, voltage/current waveforms
- **Event Data Format**  
Event number, occurrence date, occurrence time, event type

## Manual

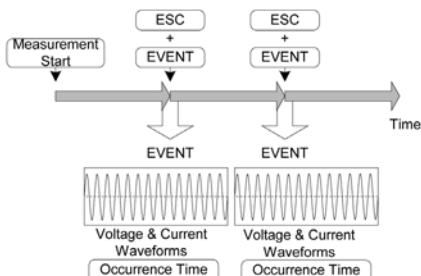

- **Detection Method**  
A detected event occurs whenever the **ESC** and **EVENT** keys are pressed simultaneously.
- **Recording Contents**  
Event list data, voltage/current waveforms
- **Event Data Format**  
Event number, occurrence date, occurrence time, event type

6.3 Viewing Anomalous Phenomena (EVENT screen)

**Operations Common to the EVENT Screens**

All EVENT screens display the same info in the top half, and the Event List. The first event to occur is displayed as No. 1, with subsequent events displayed as No. 2, No. 3, up to No. 50. Each time an event occurs, the display is refreshed to the latest event list.

Because the [DETAILS] screen can display only eight events, scroll the Event List up and down to display other events as needed. Similarly, on the [WAVEFORM], [RMS WAVE] and [INRUSH] screens, you can scroll the Event List when more than eight events have occurred.

**For Users of the Model 3196 Power Quality Analyzer**

Note that the event number assignment method of the Model 3197 Power Quality Analyzer is the opposite of Model 3196.

**NOTE** Multiple events occurring within the same 200-ms period are displayed together as a single event.

**EVENT**

Number of events recorded

Tran.	Swell	Dip	Inter.	Ext.
6	0	12	12	2

Event Type      Event Occurrence No.

"Event Monitor" (p. 115)

No.	Date	TIME	EVENTS
1	01/19	17:04:35.013	START
2	01/19	17:04:47.114	INRUSH
3	01/19	19:21:28.135	DIP CH1 IN
4	01/19	19:21:28.294	TRANSIENT
5	01/19	19:21:28.971	INTER CH1 OUT
6	01/19	19:21:29.093	TRANSIENT
7	01/19	20:08:03.548	DIP CH1 IN
8	01/19	20:08:03.650	TRANSIENT

Event Number      Date      Time      Event Type      Channels      IN/OUT      Graph data indicator

"The Event List" (p. 116)

Display appearance depends on the selected screen.

### 6.3 Viewing Anomalous Phenomena (EVENT screen)

#### Recordable Number of Events

The number of events that can be recorded is as follows regardless of whether internal memory is partitioned.

Event	Recordable Qty.	Description
Event data	Total 50	Overall Event List, details, voltage/current waveforms
Event voltage fluctuation graph data	Total 20	Event voltage fluctuation graph for 3 seconds (*U)
Inrush current fluctuation graph data	1	Inrush current fluctuation graph for 30 seconds (*I)

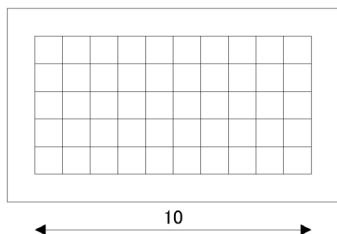

The number of recorded events is indicated on the upper part of the screen.  
 Events recorded in internal memory are represented by colored blocks.  
 A total of 50 blocks can be colored, beginning at the bottom left and ending at the top right.

 Indicates that six events have been recorded

 Indicates that 46 events have been recorded

**NOTE** Although up to 50 inrush events can be detected, inrush current fluctuation data can be recorded (and a graph displayed) for only one INRUSH event (indicated by \*I in the Event List).

#### Event Monitor

The number of occurrences of each event type is displayed. Event types that have not occurred are indicated by "0". When an event occurs, the number of occurrences is displayed in red.

Item	Description	
Event Type	Tran.	Transient Overvoltage
	Swell	Voltage Swell*
	Dip	Voltage Dip*
	Inter.	Interruption*
	Ext.	External (Start, Stop, Timer, Manual or Inrush current)

\* Voltage swell, voltage dip and interruption events have EVENT IN (onset) and EVENT OUT (recovery) occurrences. Therefore, most such events occur in pairs (onset and recovery), and the monitored values are usually multiples of two.

## 6.3 Viewing Anomalous Phenomena (EVENT screen)

### The Event List

Item	Example	Description	Details
Event Number	3	Event Number	Displays from 1 to 50.
Date	10/03	Month/Day	
Time	13:49:11.320	Hour:Min:Sec	1 ms resolution
Event Type	START	Start	
	STOP	Stop	
	MANUAL	Manual	
	TIMER	Timer	
	SWELL	Voltage Swell	
	DIP	Voltage Dip	
	INTER.	Interruption	
	TRANSIENT	Transient Overvoltage	
Channels	CH1	Channel 1	Displayed for voltage swell, dip and interruption
	CH2	Channel 2	
	CH3	Channel 3	
IN/OUT	IN	EVENT IN (Onset)	Displayed for voltage swell, voltage dip, interruption and transient overvoltage
	OUT	EVENT OUT (recovery)	
Graph indicators	*U	Voltage Fluctuation Graph	Indicates analysis is available on the voltage fluctuation screen
	*I	Inrush Current Graph	Indicates analysis is available on the inrush current screen

Refer to the “Event Detail List” for details about contents for multiple events (p. 118).

## Viewing Event Detection Details

[DETAILS]

Details of an event selected in the Event List can be viewed in the Event Detail List. When multiple events have occurred, the details of the events can be viewed in the Event Detail List. Multiple events occurring within the same 200-ms period are displayed together as a single event.

**EVENT** →

Select the screen.

Select an event

No.	Date	TIME	EVENTS	
1	01/20	10:36:29.144	START	
2	01/20	10:36:34.321	INRUSH *I	
3	01/20	10:36:41.197	DIP	CH1 IN *U
4	01/20	10:36:42.826	INTER.	CH1 OUT
5	01/20	10:36:42.943	TRANSIENT	
6	01/20	10:37:28.649	INRUSH	
7	01/20	10:37:34.473	DIP	CH3 IN *U
8	01/20	10:37:34.923	DIP	CH3 OUT

TIME	EVENT	DETAIL
42.826	INTER. CH1	1.1 V 0:00:01.620
42.826	INTER. CH2	1.1 V 0:00:01.620
42.826	INTER. CH3	1.2 V 0:00:01.620
42.832	TRANSIENT	
42.847	DIP CH1	1.1 V 0:00:01.650
42.847	DIP CH2	1.1 V 0:00:01.650

F1 F2

The Event Detail List can be scrolled when it contains more than six items.

TIME	EVENT	DETAIL
42.826	INTER. CH1	1.1 V 0:00:01.620
42.826	INTER. CH2	1.1 V 0:00:01.620
42.826	INTER. CH3	1.2 V 0:00:01.620
42.832	TRANSIENT	

Time Channels Voltage Value Continuation Period

Event Type Numerical fields are displayed for IN (Onset) events (Fields are blank for OUT (Recovery) events.)

"Event Detail List" (p. 118)

## 6.3 Viewing Anomalous Phenomena (EVENT screen)

### Event Detail List

Item	Example	Description	Description
Time	11.320	Seconds	1 ms resolution
Event Type	START	Start	
	STOP	Stop	
	MANUAL	Manual	
	TIMER	Timer	
	SWELL	Voltage Swell	
	DIP	Voltage Dip	
	INTER.	Interruption	
	TRANSIENT	Transient Overvoltage	
	INRUSH	Inrush Current	
Channels	CH1	Channel 1	Displayed for voltage swell, dip and interruption
	CH2	Channel 2	
	CH3	Channel 3	
IN/OUT	IN	EVENT IN (Onset)	
	(blank)	EVENT OUT (Recovery)	
Voltage Value	0.7V	Max. voltage before voltage swell detection	
		Min. voltage before voltage dip detection	
		Min. voltage before interruption detection	
Continuation Period	0:00:00.564	Hour:Min:Sec (1 ms resolution)	

## Waveform Anomaly Recording Methods (Data Displayed on EVENT Screen)

### Event Types other than Voltage Swell, Voltage Dip and Interruption

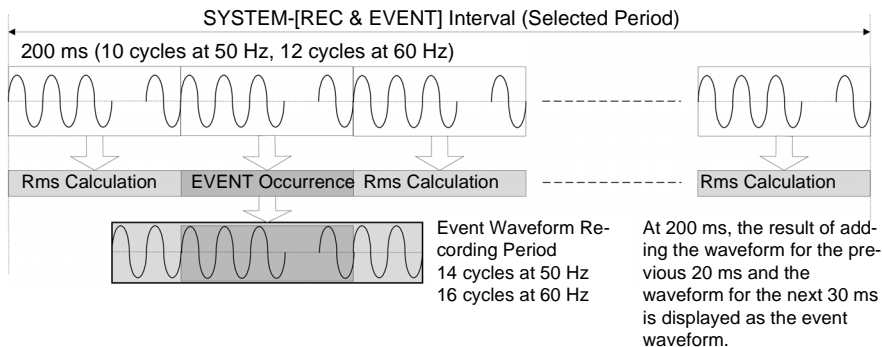

### Voltage Swell, Voltage Dip and Interruption Event Types

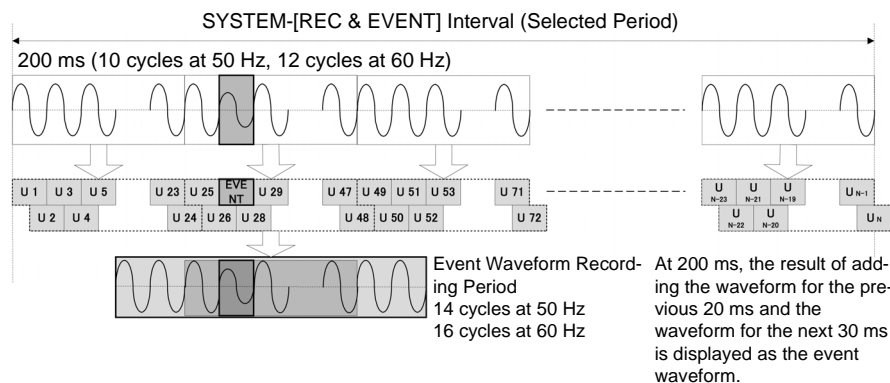

6.3 Viewing Anomalous Phenomena (EVENT screen)

Displaying Detected Event Waveforms [WAVEFORM]

The event waveform is displayed for the event selected in the Event List. Pressing the up and down cursor keys sequentially changes the selected event waveform.

**EVENT** → Select the screen.

Select voltage or current waveforms.

Display voltage waveforms. **F 1**

Display current waveforms. **F 2**

Select an event.



Changing magnification of the vertical axis

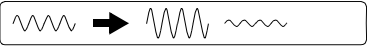

Vertical magnification can be selected from factors of 1/2, 1, 2.5, 5, 10, 25, 50 and 100.

To change voltage magnification **F 1**

Scale per division:  
1 kV/div, or 500, 200, 100, 50, 20, 10 or 5 V/div

To change current magnification **F 2**

Scale per division:  
Available settings are multiples of the current range.

Available settings are multiples of the current range.



Available multiples are 1, 2, 4 or 8 times horizontally.

To change time axis magnification **F 3**

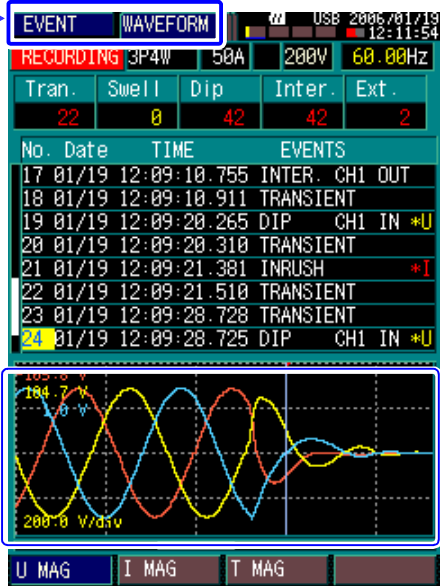

**F 1** Selects voltage waveforms and changes vertical axis magnification

**F 2** Selects current waveforms and changes vertical axis magnification

**F 3** Changes time axis magnification

The Event Detail List can be scrolled up and down when it contains more than four items. The number of channels of displayed waveforms depends on the selected wiring configuration.



## Displaying Detected Voltage Fluctuation Events

[RMS WAVE]

Select a voltage dip, voltage swell or interruption EVENT IN (Onset) event having an \*U indicator in the Event List to display its voltage fluctuation graph.

Pressing the up/down cursor keys switches the display sequentially between events. The rms voltage fluctuation graph is calculated from each half-cycle-shifted waveform (Urms 1/2).

The event voltage fluctuation graph begins about 0.5 seconds before detection and continues to about 2.5 seconds after detection. The graph is drawn according to the selected channel colors.

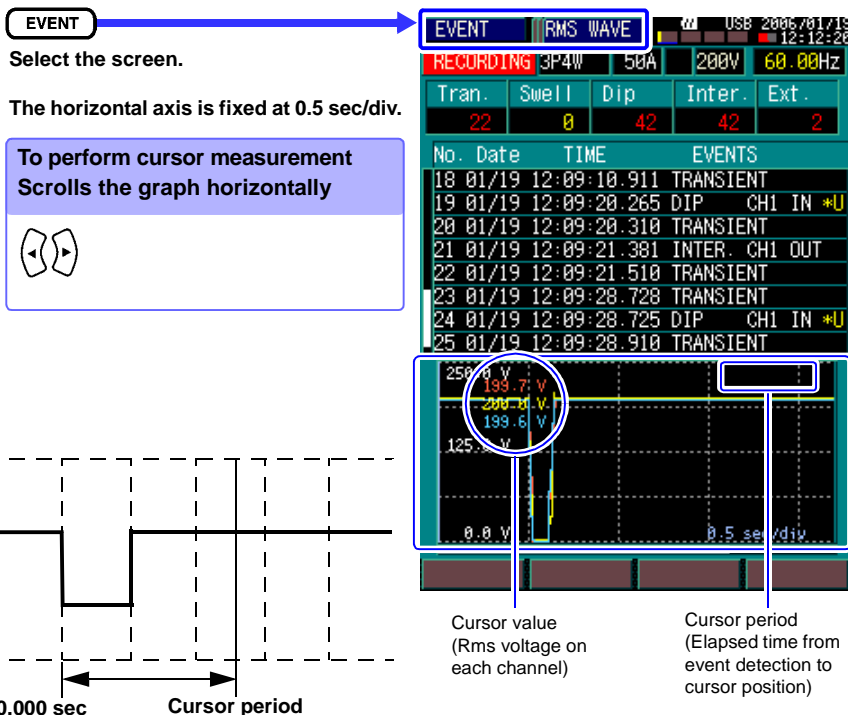

6

**NOTE** Cursor period calculation is valid only for 50 or 60 Hz line frequency.

6.3 Viewing Anomalous Phenomena (EVENT screen)

Displaying Detected Inrush Current Events [INRUSH]

Select the event with the \*I indicator in the Event List to display its inrush current graph.

Pressing the up/down cursor keys switches the display sequentially between events. The rms current fluctuation graph is calculated from each half-cycle measurement ( $I_{rms} 1/2$ ). The event inrush current fluctuation graph begins about 0.5 seconds before detection and continues to about 29.5 seconds after detection. The graph is drawn according to the selected channel colors.

EVENT

Select the screen.

Magnifying and Compressing Waveforms

The horizontal axis can be set to 0.5, 1, 2 or 5 sec/div.

To change time axis magnification F 3

To perform cursor measurement Scrolls the graph horizontally

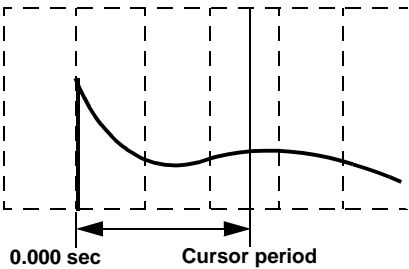
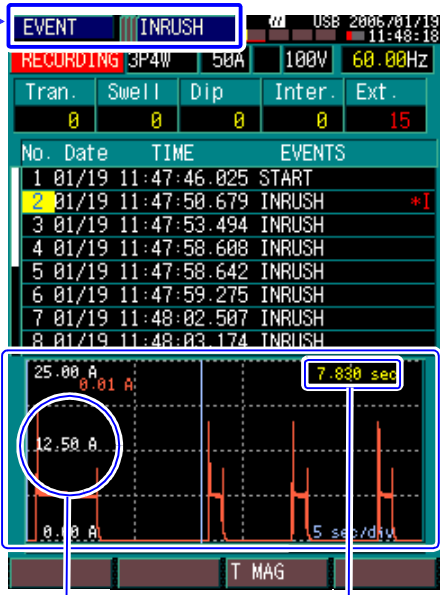

Cursor value (Rms current on each channel)

Cursor period (Elapsed time from event detection to cursor position)

**NOTE**

- Cursor period calculation is valid only for 50 or 60 Hz line frequency.
- The inrush current fluctuation graph displays rms current fluctuations.

## 6.4 Viewing Recorded Data ([REVIEW] State)

Data stored in internal memory when memory is partitioned [ON] can be viewed and re-analyzed.

After recording data in the [SET] state, switch to the [REVIEW] state to re-analyze data. To select the [REVIEW] state, press the F4 (Re-Analyze) key from the [TIME PLOT] or [EVENT] screen.

### Viewing Only Data Recorded in Memory Partition No. 1

In the [REVIEW] state, [SYSTEM], [TIME PLOT] and [EVENT] data recorded in Memory No. 1 can be analyzed. ([VIEW] data cannot be analyzed.)

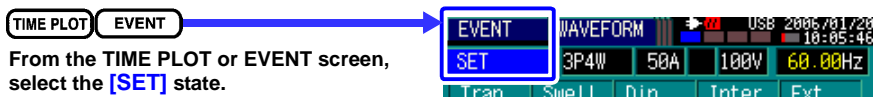

Memory indicator:



#### Reviewing

Select the [REVIEW] state

F 4

The following message appears.

The [REVIEW] state is enabled.  
Press the DATA RESET key to return to the [SET] state.

Memory indicator:

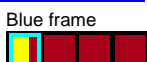

Recorded data can be analyzed by selecting the [SYSTEM], [TIME PLOT] and [EVENT] screens.

#### To exit from Reviewing

Select the [SET] state

DATA RESET

The following message appears.

Exiting the [REVIEW] state and returning to the [SET] state.

Memory indicator:

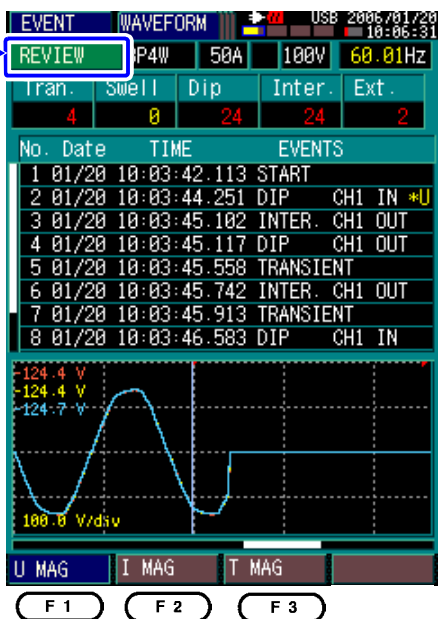

6

6.4 Viewing Recorded Data ([REVIEW] State)

Viewing Data Recorded in Multiple Memory Partitions

In the [REVIEW] state, [SYSTEM], [TIME PLOT] and [EVENT] data recorded in multiple memory partitions (Nos. 1 to 4) can be analyzed.

TIME PLOT    EVENT

From the TIME PLOT or EVENT screen, select the [SET] state.

Memory indicator:

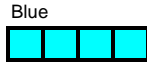

Reviewing

Select the [REVIEW] state

F 4

The following message appears.

The [REVIEW] state is enabled. Press the DATA RESET key to return to the [SET] state.

Memory indicator:

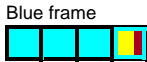

Recorded data can be analyzed by selecting the [SYSTEM], [TIME PLOT] and [EVENT] screens.

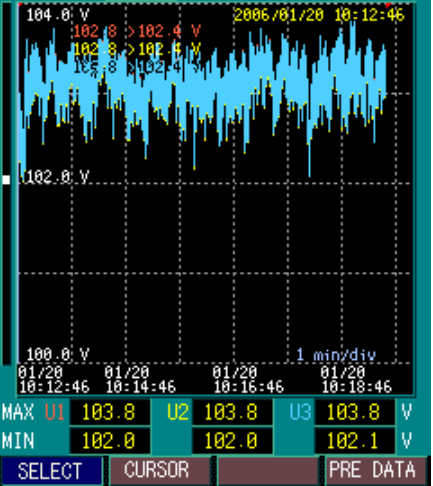

SELECT    CURSOR    PRE DATA

F 1    F 2    F 4

To finish Reviewing

Select the [SET] state

DATA RESET

The following message appears.

Exiting the [REVIEW] state and returning to the [SET] state.

Memory indicator:







# Viewing Data on a Computer

## Chapter 7

This chapter describes the preparations to make before using the PC application programs designed for this instrument. Refer to the instructions on the CD for details about program operation.

### 7.1 Overview

Communication between the instrument and a computer is available by connecting the supplied USB cable between them.

The supplied CD contains communication programs. The two application programs for this instrument are called "3197 Communicator" and "3197 Data Viewer".

#### PC application program for Model 3197

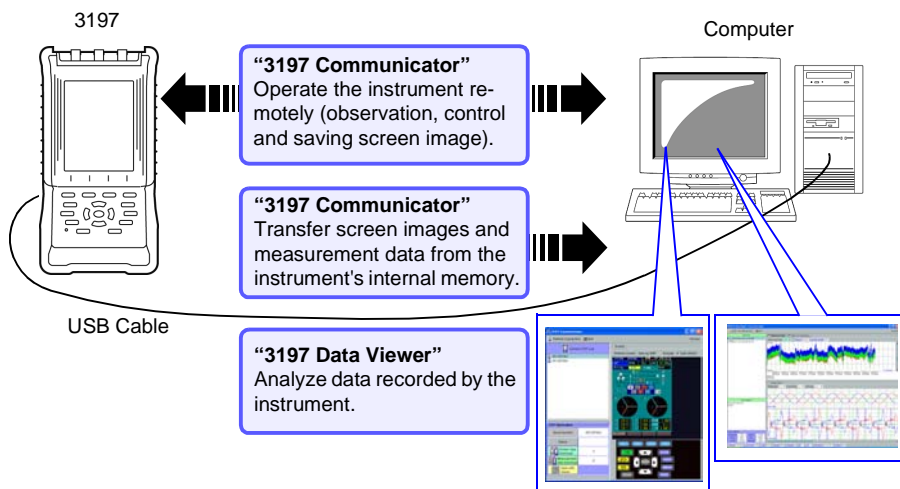

Availability	Software	Description	
Download	JRE		The application for this instrument utilizes Java™ developed by Sun Microsystems, Inc., which requires that the JRE be installed on the PC. Check for the presence of the Java applet in the Windows Control Panel to confirm that Java is installed.
Supplied	Application for this instrument	3197 Communicator	Operates the instrument remotely (observation, control and saving screen image). Transfers screen images and measurement data from the instrument's internal memory.
		3197 Data Viewer	Analyzes data recorded by the instrument.
Optional	Applications for this instrument and Model PW3198	9624-50 PQA-HiView PRO	Analyzes (binary) measurement data recorded on this instrument as well as on the Model PW3198 Power Quality Analyzer.

Sun, Sun Microsystems, Java and all logos with Sun or Java are trademarks or registered trademarks of Sun Microsystems, Inc. in the USA and other countries.

## PC System Requirements

<b>Computer</b>	PC/AT-compatible (at least 1-GHz CPU)
<b>OS</b>	Windows 2000/XP Japanese or English edition
<b>Display</b>	1024 x 768 dots, at least 16-bit color
<b>Memory</b>	At least 128 MB (256 MB or more recommended)
<b>Hard Disk Space</b>	At least 128 MB free space
<b>Communications Port</b>	USB 1.1 or 2.0 (Full-Speed)

## Files on the CD

English	setup.exe	English installer for application programs
	3197appli_manual_e_00.pdf	English manual for the application programs
Japanese	setup.exe	Japanese installer for application programs
	3197appli_manual_j_00.pdf	Japanese manual for the application programs
Chinese	setup.exe	Chinese installer for application programs
	3197appli_manual_c_00.pdf	Chinese manual for the application programs

**NOTE** Adobe Reader must be installed on the PC in order to read the manuals. If Adobe Reader is not already installed on the PC, download it from Adobe's website and install it.



## Preparing to Run the Application Programs

- 1** Turn on the computer.
- 2** Download and install JRE.  
If the computer does not have Java Runtime Environment, please download and install it from the Java homepage (<http://www.java.com/>). (p. 130).
- 3** Install the application programs (p. 132).  
(The necessary USB driver is also installed.)

## Running the Application Programs

- 1** Turn on the computer.
- 2** Turn on the instrument.
- 3** Connect the instrument to the computer with the supplied USB cable (p. 134).  
(Connect if using "3197 Communicator".)
- 4** Start the application programs.



To avoid malfunctions and data loss, do not plug or unplug the USB cable while in use.

## 7.2 Installing JRE

### Installation procedure

- 1 Download the Java Runtime Environment from the Java homepage (<http://www.java.com/>).
- 2 Follow the instructions on the screen, run and install the Java (TM) SE Runtime Environment.
- 3 Select [[I accept the terms in the license agreement](#)] and click [[Next](#)] if you agree to the terms of the License Agreement.

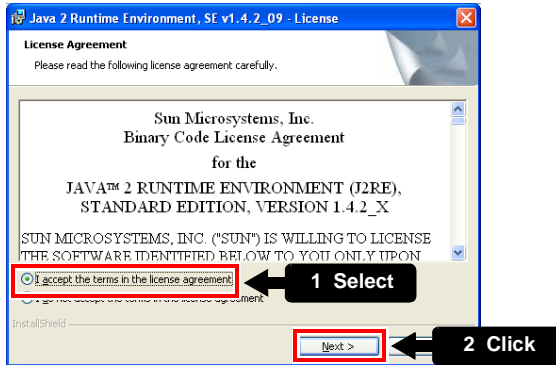

- 4 Select [[Typical](#)], and click [[Next](#)].

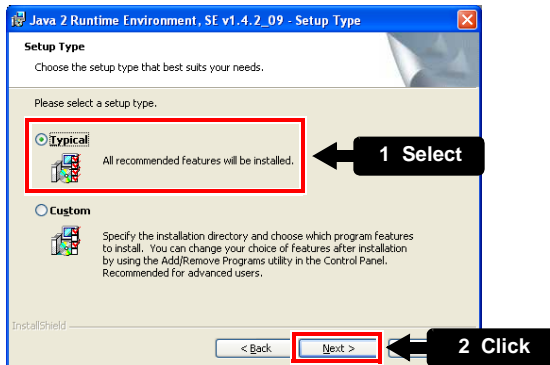

- 5 When the installation process has completed successfully, click [\[Finish\]](#).

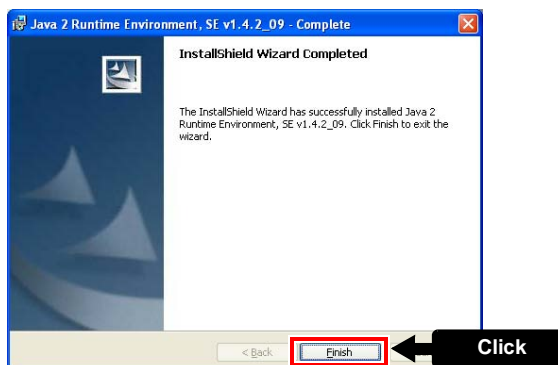
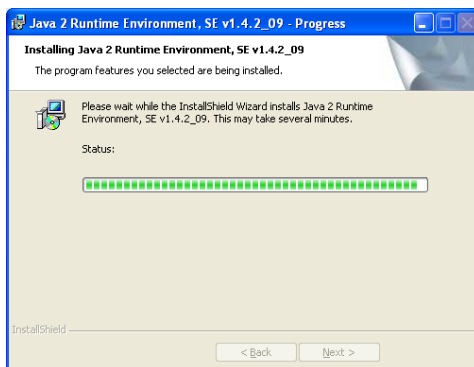

## 7.3 Installing the Application Programs

In addition to the USB driver, two instrument application programs can be installed on the computer: "3197 Communicator" and "3197 Data Viewer". The procedure for installing the instrument applications on a Windows XP computer is described here.

### Installation procedure

- 1** If the computer's operating system is Windows 2000 or XP Professional, log on as an "administrator" user.
- 2** Before starting the installer, close all currently running applications.
- 3** Run the program E:\3197Application\English\setup.exe (assuming your CD-ROM is drive E:)

After running setup.exe, installation continues with the following on-screen instructions.

- 1** Click [Next].

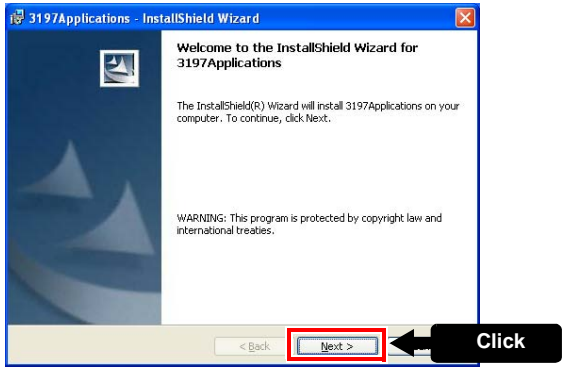

- 2** To change the installation destination, click [Change] and select the destination. Then click [Next].

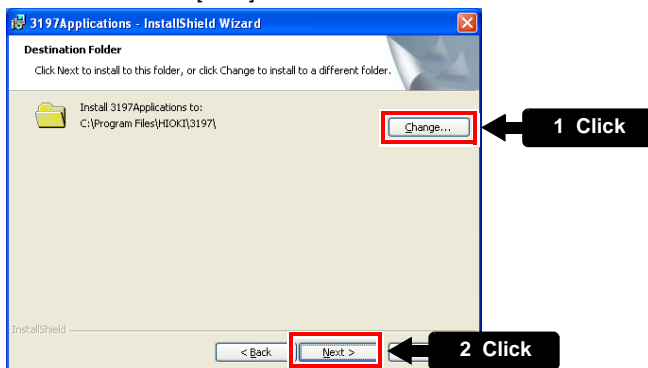

- 3** Click [Install].

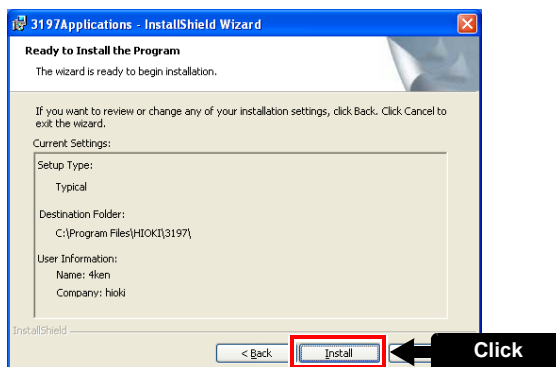

- 4** Click [Finish] to complete the installation.

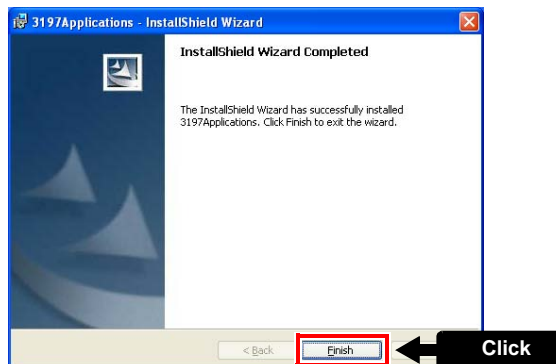

### Uninstall Procedure

To uninstall, open Add or Remove Programs in the Windows Control Panel, and select [3197 Applications].

**NOTE** When updating the applications, first uninstall the old versions.

## 7.4 Connecting the Instrument and Computer with the Supplied USB Cable

Use only the supplied USB cable to connect the instrument to the computer, by the following procedure.



### CAUTION

- To avoid malfunctions and data loss, do not plug or unplug the USB cable while in use.
- Connect the earth grounds of this instrument and the computer to a common grounding point. Grounding to different points may result in a potential difference between the grounds of the instrument and the computer, which could cause malfunctions or damage when connecting the USB cable.

### USB connection procedure

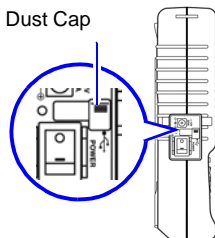

- 1** Remove the dust cap from the USB port.

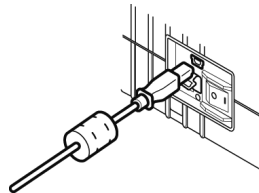

- 2** With attention to connector orientation, insert the USB cable plug into the port.

The "Found New Hardware Wizard" launches when you connect the instrument to the computer with the USB cable.



### CAUTION

To avoid malfunctions and data loss, do not plug or unplug the USB cable while in use.



### NOTE

The "Found New Hardware Wizard" launches whenever an instrument with a different serial No. is connected to the computer. It does not launch again when the same instrument is reconnected later.

## 7.4 Connecting the Instrument and Computer with the Supplied USB Cable

This example presumes the computer is running Windows XP.

- 1 Select "No, not this time", and click [Next].

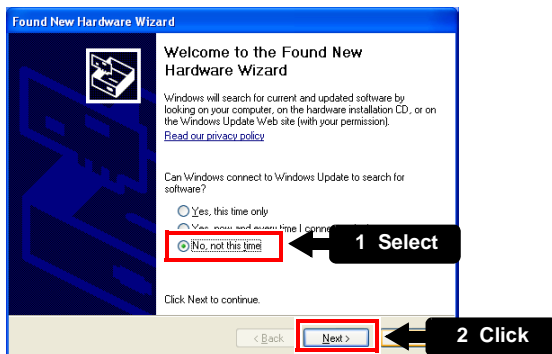

- 2 Select "Install from a list or specific location (Advanced)", and click [Next]

Making the wrong selection can prevent the correct driver from installing.  
If the Wizard does not continue normally, see: "Appendix 7 How to Resolve USB Data Transfer Problems" (p. A11)

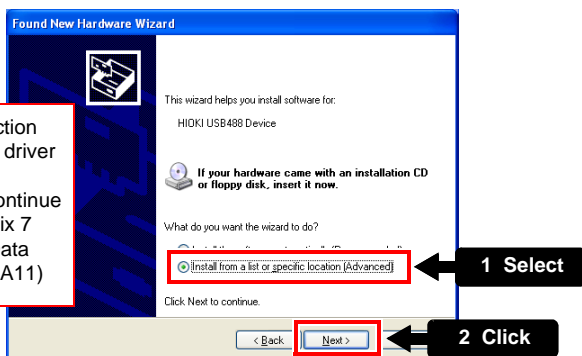

- 3 Select "Include this location in the search", and click [Browse] to specify the destination installed the USB driver.

Selecting the wrong source location can prevent the correct driver from installing.  
If the Wizard does not continue normally, see: "Appendix 7 How to Resolve USB Data Transfer Problems" (p. A11)

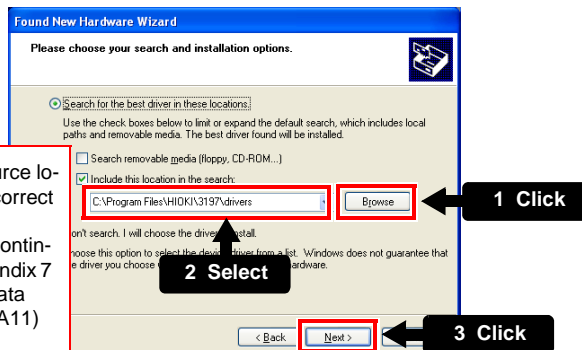

Installation starts automatically when you click [Next].

## 7.4 Connecting the Instrument and Computer with the Supplied USB Cable

- 4 Click [Finish] to close the wizard.

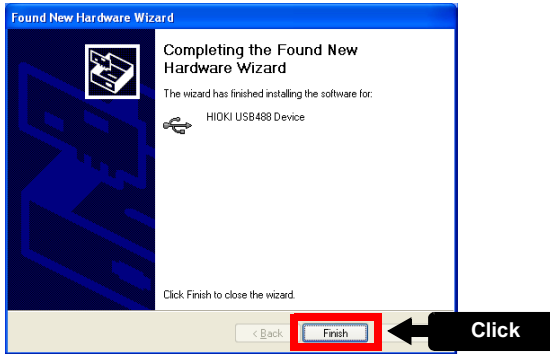

### Confirming connections

#### Instrument Connection

When connected, the [USB] indicator appears on the instrument's screen.

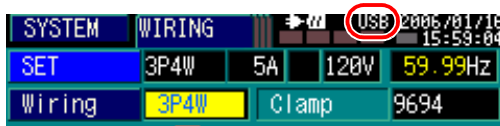

#### Computer Connection

On-screen confirmation is accessible at [Control Panel] - [System] - [Hardware] - [Device Manager]. The instrument's model name and serial No. are displayed in [HIOKI USB488-Device].

Multiple instruments are recognized when connected.

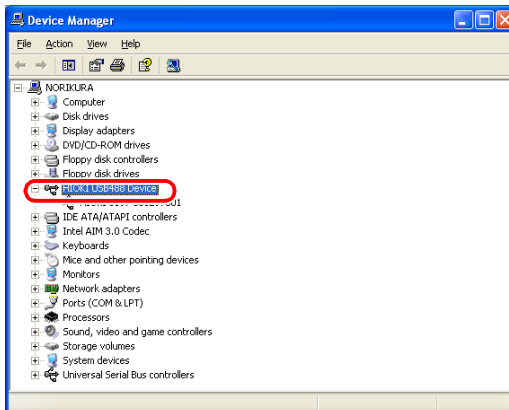



**Disconnecting the USB cable**

When disconnecting a USB cable between the instrument and a running computer, perform the following steps:

- Turn the instrument off.
- Open the "Safely Remove Hardware" icon in the computer's Notification area, and select the instrument to disconnect.

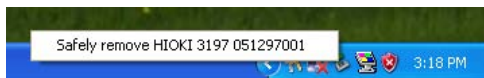

To avoid malfunctions and data loss, do not plug or unplug the USB cable while in use.

## 7.5 Starting the Instrument Application Programs

### "3197 Communicator" application

From the Windows [start] menu, select [All Programs] - [HIOKI] - [3197 Applications] - [3197 Communicator].



### To start the "3197 Data Viewer" application

From the Windows [start] menu, select [All Programs] - [HIOKI] - [3197 Applications] - [3197 Data Viewer].

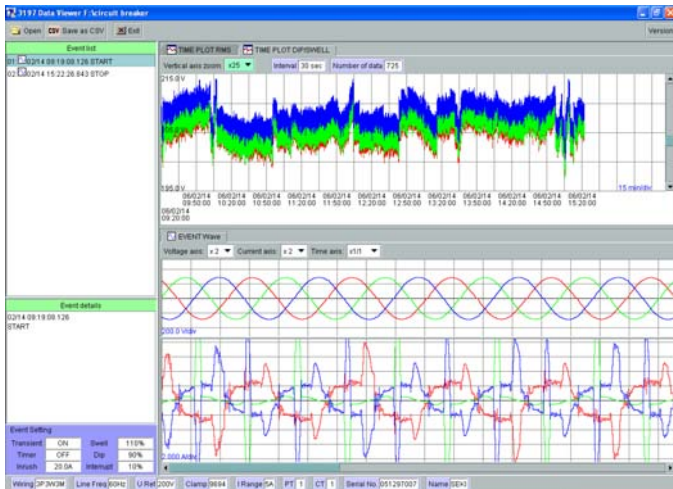

For operating instructions, refer to the pdf manual on the CD.

# Specifications

# Chapter 8

## 8.1 General Specifications

### Environmental and Safety-Related Specifications

Operating environment	Indoors, up to 2000 m (6562-ft.) ASL
Storage temperature and humidity	-10 to 50°C (14 to 122°F), 80% RH or less (non-condensating)
Operating temperature and humidity	0 to 40°C (32 to 104°F), 80% RH or less (non-condensating)
Withstand voltage	@50/60 Hz, for 15 s 5.312 kVrms AC (1 mA sense current) from voltage measurement terminals to chassis 3.32 kVrms AC (1 mA sense current) from voltage measurement terminals to current measurement terminals and USB port
Applicable standards	Safety EN61010 Pollution degree 2, Measurement Categories III (600 V) and IV (300 V) (anticipated transient overvoltage 6000 V) EMC EN61326 Class A EN61000-3-2 EN61000-3-3
Power source	Model 9418-15 AC Adapter Rated supply voltage 100 to 240V AC (with up to ±10% voltage variation) Rated supply frequency 50/60 Hz Model 9459 Battery Pack NiMH Battery (7.2 V, 2700 mAh)
Maximum rated power	23 VA (with AC adapter, at maximum load)
Continuous operating time	When using Model 9459 Battery Pack (@23°C, 73°F) Approx. 6 hours (after full charge, with 5 min. auto-off LCD backlight) Approx. 4 hours (after full charge, with LCD backlight always on)
Charging function	Available for the Model 9459 Battery Pack, with the Model 9418-15 AC Adapter connected
Quick-Charging time	Approx. 3 hours (@23°C, 73°F) After quick charging, trickle charging continues (to prevent self discharge)
Dimensions	Approx. 128 W × 246 H × 63 D mm (5.04"W × 9.69"H × 2.48"D) (including stand)
Mass	Approx. 1.2 kg (42.3 oz.) (With battery pack installed, without AC adapter)

## 8.1 General Specifications

---

### Measurement Input Specifications

Wiring configurations	Single-phase 2-wire (1P2W), single-phase 3-wire (1P3W), three-phase 3-wire (3P3W2M and 3P3W3M), three-phase four-wire (3P4W and 3P4W2.5E), Neutral current calculation and display
Measurement line frequency	Autoselecting (50/60 Hz)
Measurement input method	Voltage: isolated inputs and differential inputs (not isolated between U1, U2, U3 and N) Current: isolated inputs by clamp-on sensors
Input impedance (50/60 Hz)	Voltage: 3.2 M $\Omega$ $\pm$ 10% (differential inputs) Current: 200 k $\Omega$ $\pm$ 10%
Max. allowable input voltage	Voltage input section: 780 V AC (1103 V <sub>peak</sub> ) Current input section: 1.7 V AC (2.4 V <sub>peak</sub> )
Maximum rated voltage to ground	Voltage input section: 600 V AC (50/60 Hz) (Measurement Category III) 300 V AC (50/60 Hz) (Measurement Category IV) Current input section: per clamp-on sensors used

### Basic Measurement Specifications

Measurement method	Simultaneous digital sampling of voltage and current
A/D converter resolution	16 bits
Sampling frequency	10.24 kHz per channel (204.8 points per cycle at 50 Hz, 170.67 points per cycle at 60 Hz)
Calculation processing	<ul style="list-style-type: none"> <li>• Voltage (1/2) Alternately calculated for every full cycle at half-cycle intervals, continuous measurement without gaps (interpolation available)</li> <li>• Current (1/2) Calculated every half-cycle, continuous measurement without gaps (interpolation available)</li> <li>• Rms (measurement values other than voltage (½), current (½) and harmonic-related) 200 ms calculation of continuous measurements with no gaps (with interpolation)</li> <li>• Harmonics 2048-point calculation of continuous measurements without gaps (10 cycles @50 Hz, 12 cycles @60 Hz)</li> </ul>

## Measured and Detected Parameter Specifications

Measured parameters	Voltage (½), Current (½) Voltage, peak voltage, current, peak current, frequency, active power, reactive power, apparent power, power factor, displacement power factor, active power, reactive power, active power demand, reactive power demand, voltage harmonics, current harmonics, power harmonics, fundamental waveform phase angle, voltage total harmonic distortion, K factor, voltage unbalance factor
Event types	Voltage swell, voltage dip, interruption, inrush current, transient over-voltage, timer, manual, upon start/stop

## Display Specifications

Display refresh rate	Approx. once per second
Measurement display range	Voltage and current: 1 to 130% of range (zero-suppressed below 1%), power (active, reactive, apparent, power factor, displacement power factor), total power, energy consumption and demand are zero-suppressed when voltage or current is zero.
Usable measurement range	5 to 110% of range
Display	4.7-inch color STN LCD (portrait orientation)
Resolution	240 × 320 dots (RGB)
Dot pitch	0.10 × 0.30 mm
Display languages	English, Chinese (Simplified), Korean or Japanese
LCD backlight	Always On or Auto-Off (after 1, 5, 10 or 30 s, or after 1 h)
LCD brightness adjustment	If no key is pressed for ten seconds, the backlight switches from high to low brightness.
LCD contrast adjustment	Provided

## Interface Specifications

Interface	USB 2.0 (Full Speed)
Connection destination	Computer
Functions	Data transfer, remote control and data analysis Change settings, transfer measurement values

## 8.1 General Specifications

---

### Guaranteed Accuracy Specifications

Conditions of guaranteed accuracy	After 30 minutes warm-up, sine wave input, power factor 1, frequency 50/60 Hz $\pm 2$ Hz
Temperature and humidity range for guaranteed accuracy	@23 $\pm 5^{\circ}\text{C}$ (73 $\pm 9^{\circ}\text{F}$ ), 80% RH or less This temperature and humidity specification applies unless specified otherwise
Display range of guaranteed accuracy	Usable measurement range
Period of guaranteed accuracy	1 year

---

### Other Accuracy-Related Specifications

Real-Time Clock accuracy	$\pm 5$ ppm (within 13 s/mo., @25 $^{\circ}\text{C}$ , 77 $^{\circ}\text{F}$ )
Temperature coefficient	$\pm 0.03\%$ f.s./ $^{\circ}\text{C}$ or better (in the ranges 0 to 18 $^{\circ}\text{C}$ , 32 to 64 $^{\circ}\text{F}$ and 28 to 40 $^{\circ}\text{C}$ , 82 to 104 $^{\circ}\text{F}$ )
Effect of same-phase voltages	$\pm 0.2\%$ f.s. or better (600 Vrms AC, 50/60 Hz, between shorted voltage input terminals and instrument case)
Effect of external magnetic field	$\pm 1.5\%$ f.s. or better (in a magnetic field of 400 Arms/m AC, 50/60 Hz)
Effect of radiated RF electromagnetic field	Using Model 9667 Flexible Clamp-on Sensor, current $\pm 5\%$ f.s. or better at 10 V/m (f.s. is rated primary current of sensor), no effect with other clamp-on sensors
Effect of conducted RF electromagnetic field	Using Model 9667 Flexible Clamp-On Sensor, current $\pm 5\%$ f.s. or better at 3 V (f.s. is rated primary current of sensor), no effect with other clamp-on sensors

---

### Other Basic Specifications

Backup battery life	To retain clock data, settings data and measurement data (lithium battery) Approx. 10 years (@23 $^{\circ}\text{C}$ , 73 $^{\circ}\text{F}$ )
Clock functions	Auto calendar, auto leap year, 24-hour format
Data capacity of internal memory	4 MB (backed up by lithium battery)

---

## Accessory and Option Specifications

Accessories	<ul style="list-style-type: none"><li>• Model L9438-55 Voltage Cord (Four black measurement leads, EN61010-22031 :2001, for international)</li><li>• Model 9418-15 AC Adapter</li><li>• Power cord (region-specific)</li><li>• Model 9459 Battery Pack</li><li>• Input terminal label sheet (5 wiring types)</li><li>• Measurement lead label set (for voltage measurement and clamp sensor leads)</li><li>• Strap</li><li>• Instruction Manual</li><li>• Measurement Guide</li><li>• USB cable (USB 2.0, with ferrite core, approx. 0.9 m)</li><li>• CD (application programs for this instrument)</li><li>• Carrying Case</li></ul>
Options	<ul style="list-style-type: none"><li>• Model 9418-15 AC Adapter</li><li>• Model 9459 Battery Pack</li><li>• Model 9660 Clamp-on Sensor (100 <math>A_{rms}</math> rating)</li><li>• Model 9661 Clamp-on Sensor (500 <math>A_{rms}</math> rating)</li><li>• Model 9667 Flexible Clamp-on Sensor (500 <math>A_{rms}</math> rating, 5000 <math>A_{rms}</math> rating)</li><li>• Model 9669 Clamp-on Sensor (1000 <math>A_{rms}</math> rating)</li><li>• Model 9694 Clamp-on Sensor (5 <math>A_{rms}</math> rating)</li><li>• Model 9695-02 Clamp-on Sensor (50 <math>A_{rms}</math> rating)</li><li>• Model 9695-03 Clamp-on Sensor (100 <math>A_{rms}</math>)</li><li>• Model 9219 Connection Cable (for Models 9695-02, 03)</li><li>• Model 9657-10 Clamp on Leak Sensor (10 <math>A_{rms}</math> rating)</li><li>• Model 9675 Clamp-on Leak Sensor (10 <math>A_{rms}</math> rating)</li><li>• Model 9624-50 PQA HiView PRO (PC application program)</li></ul>

## 8.2 Detailed Specifications of Measurement Parameters

### Measurement Parameter

<b>[Voltage]</b> <b>Urms</b>	Measurement method	200 ms calculation
	Measurement range	600.0 V <sub>rms</sub>
	Measurement accuracy	±0.3% rdg. ±0.2% f.s.
	Crest factor	2 or less (w/full-scale input)
<b>[Voltage(1/2)]</b> <b>Urms1/2</b>	Measurement method	rms method, one cycle calculation refreshed every half cycle
	Measurement range	same as U <sub>rms</sub> voltage
	Measurement accuracy	±0.3% rdg. ±0.2% f.s.
<b>[Peak Voltage]</b> <b>Upeak</b>	Measurement method	200 ms calculation
	Displayed parameters	Positive and negative waveform peaks (max. and min. values)
	Measurement range	Voltage range × Crest factor
<b>[Current]</b> <b>Irms</b>	Measurement method	rms method, 200 ms calculation
	Measurement range	When using Models 9657-10, 9675 500.0 mA/5.000 A When using Models 9694, 9695-02 5.000 A/50.000 A When using Models 9660, 9695-03 10.00 A/100.0 A When using Models 9661, 9667_500A 50.00 A/500.0 A When using Model 9669 100.0 A/1.000 kA When using Model 9667_5k 500.0 A/5.000 kA
	Range selection	Manual ranging
	Measurement accuracy	±0.3% rdg. ±0.2% f.s. + specified clamp-on sensor accuracy
	Crest factor	3 or less (with full-scale input)
<b>[Current](1/2)]</b> <b>Irms1/2</b>	Measurement method	rms method, half-cycle calculation (half-cycle voltage synchronized)
	Measurement range	same as I <sub>rms</sub> current
	Measurement accuracy	±0.3% rdg. ±0.2% f.s. + specified clamp-on sensor accuracy
<b>[Peak Current]</b> <b>Ipeak</b>	Measurement method	200 ms calculation
	Displayed parameters	Positive and negative waveform peaks (max. and min. values)
	Measurement range	Current range × Crest factor



## Measurement Parameter

[Frequency] f	Measurement source	U1 Voltage
	Measurement method	200 ms calculation
	Measurement display range	40.00 to 70.00 Hz
	Usable measurement range	45.00 to 66.00 Hz
	Measurement range	99.99 Hz
	Measurement accuracy	$\pm 0.01$ Hz $\pm 1$ dgt. or less (with a sine wave between 10 and 110% of the range applied to U1)
	Display when measurement is impractical	0.00 Hz $\pm 1$ dgt.
[Active Power] P	Measurement range	Depends on combined voltage x current range
	Measurement method	200 ms calculation
	Measurement accuracy	$\pm 0.3\%$ rdg. $\pm 0.2\%$ f.s. + clamp-on sensor specification (Power Factor = 1)
	Effect of Power Factor	$\pm 1.0\%$ rdg. (50 /60Hz, Power Factor = 0.5)
	Polarity indication	None for consumption, “-” for regeneration
[Reactive Power] Q	Measurement range	Depends on combined voltage x current range
	Measurement method	Calculates from active and apparent power, 200 ms calculation
	Measurement accuracy	$\pm 1$ dgt. of calculation from each measurement value
	Polarity indication	No sign for lagging phase (current lags voltage) Minus sign (-) for leading phase (current leads voltage)
[Apparent Power] S	Measurement range	Depends on combined voltage x current range
	Measurement method	200 ms calculation
	Measurement accuracy	$\pm 1$ dgt. of calculation from each measurement value
	Polarity indication	No polarity
[Power Factor] PF	Measurement method	200 ms calculation
	Measurement range	-0.000 to -1.000 (leading), +0.000 to +1.000 (lagging)
	Measurement accuracy	$\pm 1$ dgt. of calculation from each measurement value
	Polarity indication	No sign for lagging phase (current lagging voltage) Minus sign (-) for leading phase (current leading voltage)
	Non-Input display	“1.000” (when voltage or current is zero)

**8.2 Detailed Specifications of Measurement Parameters**

**Measurement Parameter**

<b>[Displacement Power Factor] DPF</b>	Measurement method	Calculated from phase difference between fundamental voltage and current waveforms, 200 ms calculation
	Measurement range	-0.000 to -1.000 (leading), +0.000 to +1.000 (lagging) 0.0000 to 1.0000 (leading), + 0.0000 to + 1.0000 (lagging)
	Measurement accuracy	±1 dgt. of calculation from each measurement value
	Polarity indication	No sign for lagging phase (current lags voltage) Minus sign (–) for leading phase (current leads voltage)
	Non-Input display	"1.000"(when voltage or current is zero)
<b>[Energy Consumption]</b>	Measurement parameter	Active power value: WP+ (consumption), WP- (regeneration) Reactive power value: WQLAG (lagging), WQLEAD (leading) Active or reactive power value (selectable)
	Measurement method	Cumulative consumption and regeneration are calculated separately using active power Cumulative lagging and leading values are calculated separately using reactive power
	Measurement accuracy	±1 dgt. applied to active and reactive power measurement accuracy
	Time accuracy	±10 ppm ±1s (@23°C, 73°F)
<b>[DEMAND]</b>	Measurement parameter	Active or reactive power demand (selectable) Active power demand (3-phase total value) Pdem+ (consumption only), Pdem (regeneration only) Reactive power demand (3-phase total value) QdemLAG (Lagging only), QdemLEAD (Lagging only)
	Measurement method	Calculated using active or reactive power within the demand calculation period
	Measurement accuracy	±1 dgt. applied to active and reactive power measurement accuracy

## Measurement Parameter

[HARMONICS]	Measurement method	2048-point DFT (frequency is calculated as correct 50/60 Hz)
	Harmonic analysis window width	200 ms (10 cycles @50 Hz, 12 cycles @60 Hz)
	Points per window	2048
	Harmonic analysis window	Rectangular
	Harmonic analysis orders	Up to 50 <sup>th</sup> order
	Measurement Parameter	Harmonic voltage: rms voltage or percentage content of each harmonic order (Fundamental = 100%) Harmonic current: rms current of each harmonic order Harmonic power: rms active power of each harmonic order Total voltage harmonic distortion : Voltage THD-F Total current harmonic distortion : Current THD-F Fundamental phase difference: phase difference relative to the fundamental voltage on channel 1 (LAG360°, LEAD180° display)
	Measurement accuracy	Harmonic voltage and current 1 <sup>st</sup> to 15 <sup>th</sup> order $\pm 0.5\%$ rdg. $\pm 0.2\%$ f.s. 16 <sup>th</sup> to 25 <sup>th</sup> order $\pm 1.0\%$ rdg. $\pm 0.3\%$ f.s. 26 <sup>th</sup> to 35 <sup>th</sup> order $\pm 2.0\%$ rdg. $\pm 0.3\%$ f.s. 36 <sup>th</sup> to 45 <sup>th</sup> order $\pm 3.0\%$ rdg. $\pm 0.3\%$ f.s. 46 <sup>th</sup> to 50 <sup>th</sup> order $\pm 4.0\%$ rdg. $\pm 0.3\%$ f.s. Accuracy is not specified for harmonic power
Guaranteed accuracy range	Fundamental waveform voltage is specified for 50/60 Hz Add clamp-on sensor accuracy to harmonic rms current specifications	
[K Factor] KF	Measurement method	Calculated from rms harmonic waveform of the fundamental to 50 <sup>th</sup> order (magnification ratio)
	Display range	0.00 to 500.00
	Measurement accuracy	unspecified
[Voltage Unbalance Factor] Uunb	Measurement method	For three-phase 3 wire (3P3W3M) and three-phase 4-wire, the value for each phase is calculated from the fundamental waveform voltage (inter-line)
	Display range	0.0 to 100.0
	Measurement accuracy	unspecified

## 8.2 Detailed Specifications of Measurement Parameters

### Wiring Configuration Measurement Parameters

Measurement Parameter		1P2W	1P3W	3P3W2M,3P3W3M	3P4W,3P4W2.5E
Voltage (1/2)	Urms1/2	1	1, 2	1, 2, 3	1, 2, 3
Voltage	Urms	1	1, 2, ave	1, 2, 3, ave	1, 2, 3, ave
Peak voltage ( $\pm$ )	Upeak	1	1, 2	1, 2, 3	1, 2, 3
Current(1/2)	Irms1/2	1	1, 2	1, 2, 3	1, 2, 3
Current	Irms	1	1, 2, ave	1, 2, 3, ave	1, 2, 3, 4, ave
Peak current ( $\pm$ )	Ipeak	1	1, 2	1, 2, 3	1, 2, 3, 4
Frequency	f	1	1	1	1
Active power	P	1	sum,( $\ast$ 1,2)	sum,( $\ast$ 1,2,3)	sum,( $\ast$ 1,2,3)
Reactive power	Q	1	sum,( $\ast$ 1,2)	sum,( $\ast$ 1,2,3)	sum,( $\ast$ 1,2,3)
Apparent power	S	1	sum,( $\ast$ 1,2)	sum,( $\ast$ 1,2,3)	sum,( $\ast$ 1,2,3)
Power factor/Displacement power factor	PF/DPF	1	sum	sum	sum
Active power value	WP+/WP-	sum	sum	sum	sum
Reactive power value	WQLAG/WQLEAD	sum	sum	sum	sum
Active power demand	Pdem+/Pdem-	sum	sum	sum	sum
Reactive power demand	QdemLAG/QdemLEAD	sum	sum	sum	sum
Harmonic voltage	U1 to U50*	1	1, 2	1, 2, 3	1, 2, 3
Harmonic current	I1 to I50*	1	1, 2	1, 2, 3	1, 2, 3
Harmonic power	P1 to P50*	1	1, 2, sum	1, 2, 3, sum	1, 2, 3, sum
Fundamental waveform voltage phase difference	$\phi_U$ *	1	1, 2	1, 2, 3	1, 2, 3
Fundamental waveform current phase difference	$\phi_I$ *	1	1, 2	1, 2, 3	1, 2, 3
Voltage (Current) total harmonic distortion	THD-F I THD-F*	1	1, 2	1, 2, 3	1, 2, 3
K factor	KF*	1	1, 2	1, 2, 3	1, 2, 3
Voltage unbalance factor	Uunb	–	–	sum**	sum

Note 1. "ave" indicates the average value between channels.

Note 2. "sum" indicates the sum of the values between channels.

\* : Only displayed on VIEW screen

\*\* : Not measurable in 3P3W2M systems

### Time Series Calculations

Time series calculation values	MAX, MIN and AVE values More negative peak voltage (-) and peak current (-) values are handled as minima, and less negative values are handled as maxima
Time series calculation method	MAX, MIN and AVE values are calculated within the specified interval (but no AVE voltage (½) value is calculated)

### Time Series Recording Measurement Parameters and Averaging

Measurement Parameter		Time Series Recording	AVE Value Calculation Method	
			CHs 1, 2, 3	sum/ave
Voltage(1/2)	Urms1/2	<input type="radio"/>	–	–
Voltage	Urms	<input type="radio"/>	Calculated average	Calculated average of the average result for each channel
Peak voltage(±)	Upeak	<input type="radio"/>	Signed calculated average	–
Current	Irms	<input type="radio"/>	Calculated average	Calculated average of the average result for each channel
Peak current (±)	Ipeak	<input type="radio"/>	Signed calculated average	–
Frequency	f	<input type="radio"/>	Calculated average	–
Active power	P	<input type="radio"/>	–	Calculated average of sum values
Reactive power	Q	<input type="radio"/>	–	Calculated average of sum values
Apparent power	S	<input type="radio"/>	–	Calculated average of sum values
Power factor/displacement power factor	PF/DPF	<input type="radio"/>	–	Calculated average of sum values (per Note)
Voltage total harmonic distortion	THD-F	<input type="radio"/>	Calculated average	–
Voltage unbalance factor	Uunb	<input type="radio"/>	–	Calculated average

Note. For power factor, the AVE value is the average centered around  $\pm 1$ , MAX value is the worst-case value when +0 is the maximum, and MIN value is the worst-case value centered around -0.

Measurement Parameter		Time Series Recording
Active power value	WP+/WP-	<input type="radio"/>
Reactive power value	WQLAG/WQLEAD	<input type="radio"/>
Active power demand	Pdem+/Pdem-	<input type="radio"/>
Reactive power demand	QdemLAG/QdemLEAD	<input type="radio"/>

## 8.3 Event Specifications

### Event Type

Voltage Swell, Voltage Dip, Interruption	Measurement method	Detection using voltage ( $\frac{1}{2}$ ) measured every half cycle
	Detected event types	Voltage Swell: Maximum voltage (worst value), occurrence time, recovery time, period Voltage Dip: Residual voltage (worst value), occurrence time, recovery time, period Interruption: Residual voltage voltage, detection date/time, recovery date/time, period
	Threshold	Swell: 100 to 150% of nominal voltage Dip, Interruption: 0 to 100% of nominal voltage
	Hysteresis	2% of nominal voltage
	Recording contents	Event data, event waveform, event voltage fluctuation graph
	Event data format	Event number, date, time, event type, channel, status (EVENT IN (Onset) / EVENT OUT (Recovery)), period, worst value
Inrush Current	Measurement method	Detection using current ( $\frac{1}{2}$ ) every half cycle
	Detected event types	Maximum current (worst value), detection time
	Threshold	0 A to 5000 A (independent of current range and CT ratio)
	Recording contents	Event data, event waveform, inrush current graph
	Event data format	Event number, date, time, event type
Transient Overvoltage	Measurement method	Comparator
	Detection criteria	Displays whether a positive or negative transient exists during every voltage cycle on any of three channels
	Transient detection range	50 Vrms ( $\pm 70.7$ Vpeak equiv.) or more, 10 to 100 kHz
	Recording contents	Event Data, Event waveform
	Event data format	Event number, date, time, event type, status (EVENT IN (Onset) / EVENT OUT (Recovery)), continuation period

## Event Type

Timer	Measurement method	Detect events at preset intervals
	Timer event interval	OFF, 1, 5, 15 or 30 minutes; 1, 2 or 12 hours; or 1 day interval
	Detection criteria	Occurrence time
	Recording contents	Event data, event waveform
	Event data format	Event number, date, time, event type
Manual	Measurement method	Detect events when keys are pressed (pressing the [ESC] and [EVENT] keys at the same time)
	Recording contents	Event data, event waveform
	Event data format	Event number, date, time, event type
Start, Stop	Measurement method	Recording start and stop operations are detected as events
	Recording contents	Event data, event waveform,
	Event data format	Event number, date, time, event type

## Event Detection

Event detection method	Detection by ORing each event type
Event setting	Events other than manual events, and start/stop can be enabled/disabled (set on/off)
Event waveform recording length	Waveform from 20 ms before detection + 200 ms upon detection + 30 ms after detection
Event voltage fluctuation graph length	0.5 s before + 2.5 s after detection
Inrush current graph length	0.5 s before + 29.5 s after detection
Maximum event count	1000
Maximum recording event number	50 event waveforms 20 event voltage fluctuation graphs 1 inrush current graph

## 8.4 Function Specifications

### Display

SYSTEM	Settings
VIEW	Waveforms, DMM, vectors, harmonics (bar graph/list)
TIME PLOT	Voltage (½), voltage, current, frequency, active power, power factor, voltage total harmonic distortion, voltage unbalance factor, energy consumption, demand
EVENT	Event list, event monitor, event waveform, event voltage fluctuation graph, inrush current graph

### Setting Contents (factory defaults in bold)

Measurement frequency	<b>AUTO</b> , 50 Hz, 60 Hz
Phase colors (input terminal colors)	<b>TYPE1</b> , TYPE2, TYPE3, TYPE4, TYPE5
Phase names	<b>R S T</b> , A B C, L1 L2 L3, U V W
Wiring Configuration	1P2W, 1P3W, 3P3W2M, 3P3W3M, <b>3P4W</b> , 3P4W2.5E
Nominal Line Voltage	<b>AUTO</b> , 100, 101, 110, 120, 127, 200, 202, 208, 220, 230, 240, 277, 347, 380, 400, 415, 480, 600 or VALIABLE (VALIABLE = any integer from 50 to 600 V)
Clamp sensors	Models 9660, <b>9661</b> , 9667_500, 9667_5k, 9669, 9694, 9695-02, 9695-03, 9657-10 or 9675

### Current range

Clamp Model	Measurement range
9657-10, 9675	500.0 mA, 5.000 A
9694, 9695-02	5.000 A, 50.00 A
9660, 9695-03	10.00 A, 100.0 A
9661, 9667 (using 500 A range)	50.00 A, <b>500.0 A</b>
9669	100.0 A, 1.000 kA
9667 (using 5 kA range)	500.0 A, 5.000 kA

PT ratio	1, 60, 100, 200, 300, 600, 700 or VALIABLE_ (1.00 to 999.99)
CT ratio	1, 4, 6, 8, 10, 12, 15, 20, 30, 40, 60, 80, 100, 120, 160 or VALIABLE (0.01 to 999.99)
Harmonic voltage calculation	<b>Rms value</b> , percentage content
Power factor calculation	<b>Power factor</b> /displacement power factor (PF/DPF)
Memory partitioning	ON / OFF
Interval	<b>AUTO</b> , 1, 5, 15 and 30 min., and 1 hour (AUTO sequentially selects 1, 2, 10, 30 seconds, 1, 5, 15 and 30 min., and 1 hour automatically)



### Setting Contents (factory defaults in bold)

Demand period	15 min., <b>30 min.</b> and 1 hour
Real-time control	ON / OFF (both starting from zero seconds)
Settable start time	Year, month, day, hour and minute (24-hour system, valid for the specified time)
Settable stop time	Year, month, day, hour and minute (24-hour system, valid for the specified time)
Version information	Firmware version display
Display language	English, Chinese, Korean, Japanese
Beep sound	<b>ON</b> , OFF
Screen colors	<b>COLOR1</b> , <b>COLOR2</b> , <b>COLOR3</b> , <b>COLOR4</b> , <b>MONO</b>
LCD backlight	<b>Always ON</b> /Auto, OFF (1, 5, 15 and 30 min., and 1 hour)
LCD contrast	-30 to <b>+0</b> to +20
Clock setting	Year, month, day, hour and minute (24-hour system)
System reset	System reset returns the instrument to factory default setting condition (time and display language are not reset)
Serial No. information	Serial No. information
Version information	Version information

#### Event settings

Event	ON/OFF and Setting Value	
Voltage Swell	OFF	ON (100 to 150%)
Voltage Dip	OFF	ON (0 to 100%)
Interruption	OFF	ON (0 to 100%)
Inrush current	OFF	0.0 A to 5.000 kA (set in 1 A steps)
Transient Overvoltage	OFF	ON
Timer	OFF	1, 5, 15 and 30 min., 1, 2 and 12 hours, and 1 day

Manual events and Start and Stop events cannot be changed (always on)

#### Basic setup

##### Basic Setup Contents

Setting Item	Setting
Frequency	AUTO
Nominal Line Voltage	AUTO
Interval	AUTO
Voltage Swell	110%
Voltage Dip	90%
Interruption	10%
Transient Overvoltage	ON

**Other Functions**

Wiring configuration diagram display	Wiring configuration diagram display
Phase (input terminal) color selection	Displays wiring configurations, numerical values, waveforms and vectors with selected phase colors
Battery check	Remaining battery charge
Display hold	Display Hold on/off (VIEW screen only)
Warning indicators	Crest factor out-of-range, frequency selection error, internal memory overwrite error
Numerical over-range display	"- - - -" (Numerical display when 130% of voltage or current range is exceeded)
Key-lock	Enable/disable by holding [ESC] key for 3 seconds Disables all key operations except the power switch
Help messages	Displays a description of the selected item on the SYSTEM screen

**Memory Backup Operation**

Savable data	Measurement data and image data
Data management function	Amount of recorded data, remaining recording capacity displays Data deletion
Recording format	Settings data: Binary format Image data: BMP format Measurement data: Binary format

---

## Memory Backup Operation

Maximum recordable data  
 Image data: 10 images  
 Measurement data  
 Event Data: 50 events  
 Event voltage fluctuation graph data: 20 graphs  
 Inrush current data: 1 measurement  
 TIME PLOT data: see following table

Interval	Recordable TIME PLOT data period	
	No Memory Partitioning	4 Memory Partitions
1 min.	50 hours (approx. 2 days)	12.5 hours (approx. 0.5 days)
5 min.	250 hours (approx. 10 days)	62.5 hours (approx. 2 days)
15 min.	750 hours (approx. 31 day)	187.5 hours (approx. 7 days)
30 min.	1500 hours (approx. 62 days)	375 hours (approx. 15 days)
1 hour	3000 hours (approx. 125 days)	750 hours (approx. 31 day)

(The recordable period for demand data is the demand period applied to the interval period.)

## 8.5 Calculation Formulas

### Basic Calculation Formulas

Wiring Configuration Parameter	Single-Phase 2-Wire *1	Single-Phase 3-Wire	Three-phase, 3-wire		Three-Phase 4-Wire	
	1P2W	1P3W	3P3W2M	3P3W3M	3P4W	3P4W2.5E
<b>Voltage (1/2) U(1/2) [Vrms]</b>	$U_1$	$U_1$ $U_2$	Inter-line voltage $U_1$ $U_2$ $U_3 (U_{3s} = -U_{1s} + U_{2s})$ ( $U_{1s} + (-U_{2s}) + U_{3s} = 0$ are assumed)	Inter-line voltage $U_1 (U_{1s} = u_{1s} - u_{2s})$ $U_2 (U_{2s} = u_{2s} - u_{3s})$ $U_3 (U_{3s} = u_{3s} - u_{1s})$	Phase voltage $U_1$ $U_2$ $U_3$	
	$U_c = \sqrt{\frac{1}{M} \sum_{s=0}^{M-1} (U_{cs})^2}$					
<b>Voltage U [Vrms]</b>	$U_1$	$U_1$ $U_2$	Inter-line voltage $U_1$ $U_2$ $U_3 (U_{3s} = -U_{1s} + U_{2s})$ ( $U_{1s} + (-U_{2s}) + U_{3s} = 0$ are assumed)	Inter-line voltage $U_1 (U_{1s} = u_{1s} - u_{2s})$ $U_2 (U_{2s} = u_{2s} - u_{3s})$ $U_3 (U_{3s} = u_{3s} - u_{1s})$	Phase voltage $U_1$ $U_2$ $U_3$	
	$U_{ave} = \frac{U_1 + U_2}{2}$		$U_{ave} = \frac{U_1 + U_2 + U_3}{3}$		$U_2 (U_{2s} = -U_{1s} - U_{3s})$ ( $U_{1s} + U_{2s} + U_{3s} = 0$ are assumed)	
	$U_c = \sqrt{\frac{1}{M} \sum_{s=0}^{M-1} (U_{cs})^2}$					

- Subscript definitions  
c: Measurement channel (1 to 3); 1, 2, 3: Measurement channel; M: Sample count; s: Sample point number; ave: average of multiple channels; sum: sum of multiple channels
  - Variable definitions  
U: Inter-line voltage (three-phase 4-wire phase voltage), u: phase voltage from virtual neutral
- \*1. Formulas that apply to inputs 1 to 3 for single-phase wiring also apply to c in other wiring configurations.

Wiring Configuration Parameter	Single-Phase 2-Wire *1	Single-Phase 3-Wire	Three-phase, 3-wire		Three-Phase 4-Wire	
	1P2W	1P3W	3P3W2M	3P3W3M	3P4W	3P4W2.5E
<b>Current (1/2)</b> <b>I(1/2) [Arms]</b>	$I_1$	$I_1$ $I_2$	$I_1$ $I_2$ $I_3(I_{3s}=-I_{1s}-I_{2s})$ ( $I_{1s}+I_{2s}+I_{3s}=0$ are assumed)	$I_1$ $I_2$ $I_3$		
	$I_c = \sqrt{\frac{1}{M} \sum_{s=0}^{M-1} (I_{cs})^2}$					
<b>Current</b> <b>I [Arms]</b>	$I_1$	$I_1$ $I_2$	$I_1$ $I_2$ $I_3(I_{3s}=-I_{1s}-I_{2s})$ (Assuming $I_{1s}+I_{2s}+I_{3s}=0$ )	$I_1$ $I_2$ $I_3$	$I_1$ $I_2$ $I_3$	$I_4(I_{4s}=I_{1s}+I_{2s}+I_{3s})$
	$I_{ave} = \frac{I_1 + I_2}{2}$		$I_{ave} = \frac{I_1 + I_2 + I_3}{3}$			
	$I_c = \sqrt{\frac{1}{M} \sum_{s=0}^{M-1} (I_{cs})^2}$					

- Subscript definitions  
c: Measurement Channel (1 to 3), 1, 2, 3: Measurement Channel, M: Sample count, s: Sample point number, ave: average of multiple channels; sum: sum of multiple channels
  - Variable definitions  
I: line current, u: phase voltage from virtual neutral
- \*1. Formulas that apply to inputs 1 to 3 for single-phase wiring also apply to c in other wiring configurations.

8.5 Calculation Formulas

Wiring Configuration	Single-Phase 2-Wire *1	Single-Phase 3-Wire	Three-phase, 3-wire		Three-Phase 4-Wire	
Parameter	1P2W	1P3W	3P3W2M	3P3W3M	3P4W	3P4W2.5E
Active Power *2 P [W]	$P_I$	$P_{sum} = P_1 + P_2$		$P_{sum} = P_1 + P_2 + P_3$ (Using $U_c$ as phase voltage)		
	$P_c = \frac{1}{M} \sum_{s=0}^{M-1} (U_{cs} \times I_{cs})$					
Apparent Power S [VA]	$S_I$	$S_{sum} = S_1 + S_2$	$S_{sum} = \frac{\sqrt{3}}{3} (S_1 + S_2 + S_3)$ (Using $U_c$ as inter-line voltage)		$S_{sum} = S_1 + S_2 + S_3$ (Using $U_c$ as phase voltage)	
	$S_c = U_c \times I_c$					
Reactive Power Q [var]	$Q_I$	$Q_{sum} = si \sqrt{S_{sum}^2 - P_{sum}^2}$				
	$Q_c = si \sqrt{S_c^2 - P_c^2}$					
Power Factor PF	$PF_I$	$PF_{sum} = si \left  \frac{P_{sum}}{S_{sum}} \right $				
	$PF_c = si \left  \frac{P_c}{S_c} \right $					
Displacement Power Factor DPF	$DPF_I$	$DPF_{sum} = si \left  \frac{P_{sum}(l)}{\sqrt{P_{sum}(l)}^2 + Q_{sum}(l)} \right $				

- Subscript definitions  
 c: Measurement Channel (1 to 3), 1, 2, 3: Measurement Channel, M: Sample count, s: Sample point number, ave: average of multiple channels; sum: sum of multiple channels
- Variable definitions  
 U: Inter-line voltage (three-phase 4-wire phase voltage), l: line current, u: phase voltage from virtual neutral  
 si: Polarity sign of lead and lag (using sign of fundamental waveform reactive power)  
 The polarity sign of the leading phase (LEAD) is “-” when the polarity of fundamental waveform reactive power is positive.  
 The polarity of the lagging phase (LAG) is unsigned when the polarity of fundamental waveform reactive power is negative.
- \*1. Formulas that apply to inputs 1 to 3 for single-phase wiring also apply to c in other wiring configurations.
- \*2. The polarity of Active Power P is (+) for consumption and (-) for regeneration, indicating the power flow direction.
- \*3. When  $S < |P|$  due to a measurement error or unbalance effect, processing is performed with  $S = |P|$ ,  $Q = 0$  and  $PF = 1$
- \*4. When  $S = 0$ , processing is performed with  $PF = 1.000$

## Energy Consumption and Demand Formulas

Wiring Configuration Parameter	Single-Phase 2-Wire	Single-Phase 3-Wire	Three-phase, 3-wire		Three-Phase 4-Wire
	1P2W	1P3W	3P3W2M	3P3W3M	3P4W, 3P4W2.5E
<b>Active Power value (amount of consumption) WP+ [kWh]</b>	$WP_{1+}$	$WP_{sum+} = WP_{1+} + WP_{2+}$		$WP_{sum+} = WP_{1+} + WP_{2+} + WP_{3+}$	
	$WP_{c+} = k \sum_1^h ( P_{C(+)} )$				
<b>Active Power value (amount of regeneration) WP- [kWh]</b>	$WP_{1-}$	$WP_{sum-} = WP_{1-} + WP_{2-}$		$WP_{sum-} = WP_{1-} + WP_{2-} + WP_{3-}$	
	$WP_{c-} = k \sum_1^h ( P_{C(-)} )$				
<b>Reactive Power value (amount of lag) WQLAG [kVarh]</b>	$WQ_{1LAG}$	$WQ_{sumLAG} = k \sum_1^h ( Q_{sum(+)} )$			
	$WQ_{cLAG} = k \sum_1^h ( Q_{c(+)} )$				
<b>Reactive Power value (amount of lead) Active Power demand WQLEAD [kVarh]</b>	$WQ_{1LEAD}$	$WQ_{sumLEAD} = k \sum_1^h ( Q_{sum(-)} )$			
	$WQ_{cLEAD} = k \sum_1^h ( Q_{c(-)} )$				
<b>Active Power demand Pdem+ [kW]</b>	$P_{dem1+}$	$P_{demsum} = P_{dem1+} + P_{dem2+}$		$P_{demsum} = P_{dem1+} + P_{dem2+} + P_{dem3+}$	
	$P_{demc+} = \frac{1}{h} \sum_1^h ( P_{C(+)} )$				
<b>Active Power demand Pdem- [kW]</b>	$P_{dem1-}$	$P_{demsum} = P_{dem1-} + P_{dem2-}$		$P_{demsum} = P_{dem1-} + P_{dem2-} + P_{dem3-}$	
	$P_{demc-} = \frac{1}{h} \sum_1^h ( P_{C(-)} )$				
<b>Reactive Power demand QdemLAG [kVar]</b>	$Q_{dem1LAG}$	$Q_{demsumLAG} = \frac{1}{h} \sum_1^h ( Q_{sum(+)} )$			
	$Q_{demcLAG} = \frac{1}{h} \sum_1^h ( Q_{c(+)} )$				
<b>Reactive Power demand QdemLEAD [kVar]</b>	$Q_{dem1LEAD}$	$Q_{demsumLEAD} = \frac{1}{h} \sum_1^h ( Q_{sum(-)} )$			
	$Q_{demcLEAD} = \frac{1}{h} \sum_1^h ( Q_{c(-)} )$				

Note. h: Measurement period, k: 1-hour conversion coefficient

(+): Use this value (amount of consumption for Active Power or amount of lag for Reactive Power) only when the numerical value is positive.

(-): Use this value (amount of regeneration for Active Power or amount of lead for Reactive Power) only when the numerical value is negative.

Harmonic Formulas

Wiring Configuration	Single-Phase 2-Wire	Single-Phase 3-Wire	Three-phase, 3-wire		Three-Phase 4-Wire
Parameter	1P2W	1P3W	3P3W2M	3P3W3M	3P4W, 3P4W2.5E
<b>Harmonic Voltage</b> $U_k$ [Vrms] *1	$U_{1k}$	$U_{1k}$ $U_{2k}$	Inter-Line Voltage $U_{1k}$ $U_{2k}$ $U_{3k}$ ( $U_{1s}+(-U_{2s})+U_{3s}=0$ are assumed)	Phase Voltage $U_{1k}$ $U_{2k}$ $U_{3k}$	Phase Voltage $U_{1k}$ $U_{2k}$ $U_{3k}$
<b>Harmonic Current</b> $I_k$ [Arms]	$I_{1k}$	$I_{1k}$ $I_{2k}$	$I_{1k}$ $I_{2k}$ $I_{3k}$ (Assuming $I_{1s}+I_{2s}+I_{3s}=0$ )	$I_{1k}$ $I_{2k}$ $I_{3k}$	
<b>Harmonic Power *2</b> $P_k$ [W]	$P_{1k}$	$P_{sumk}=P_{1k} + P_{2k}$		$P_{sumk}=P_{1k} + P_{2k} + P_{3k}$ (U is phase voltage for FFT)	
	$P_{ck} = U_{kr} \times I_{kr} + U_{ki} \times I_{ki}$				

c: Measurement channel, k: Analysis order, r: Amount of resistance after FFT, i: Amount of reactance after FFT

\*1. Harmonic content percentage (harmonic voltage) divide each value by the fundamental waveform amplitude to make 100%.

\*2. The phase value from the virtual neutral point is used to calculate  $P_k$  and  $Q_k$  for 3P3W3M.

Wiring Configuration	Single-Phase 2-Wire	Single-Phase 3-Wire	Three-phase, 3-wire		Three-Phase 4-Wire
Parameter	1P2W	1P3W	3P3W2M	3P3W3M	3P4W, 3P4W2.5E
<b>For internal calculations*1</b> <b>Harmonics Reactive Power</b> $Q_k$ [var]	$Q_{1k}$	$Q_{sumk}=Q_{1k} + Q_{2k}$		$Q_{sumk}=Q_{1k} + Q_{2k} + Q_{3k}$ (U is phase voltage for FFT)	

\*1. The phase value from the virtual neutral point is used to calculate  $P_k$  and  $Q_k$  for 3P3W3M.

\*2. Phase angles of the fundamental voltage and current waveforms are calculated using only the first-order calculated harmonic, and are displayed by normalizing fundamental waveform U1 to 0°.



Wiring Configuration	Single-Phase 2-Wire	Single-Phase 3-Wire	Three-phase, 3-wire		Three-Phase 4-Wire
	1P2W	1P3W	3P3W2M	3P3W3M	3P4W, 3P4W2.5E
Fundamental waveform Voltage phase angle *2 $\phi_U$ [deg]	$\phi_{U_{1(1)}}$	$\phi_{U_{1(1)}}$ $\phi_{U_{2(1)}}$	$\phi_{U_{1(1)}}$ $\phi_{U_{2(1)}}$ $\phi_{U_{3(1)}}$		
	$\phi_{U_{c(1)}} = \tan^{-1}\left(\frac{U_r}{-U_i}\right)$				
Fundamental waveform Current phase angle *2 $\phi_I$ [deg]	$\phi_{I_{1(1)}}$	$\phi_{I_{1(1)}}$ $\phi_{I_{2(1)}}$	$\phi_{I_{1(1)}}$ $\phi_{I_{2(1)}}$ $\phi_{I_{3(1)}}$		
	$\phi_{I_{c(1)}} = \tan^{-1}\left(\frac{I_r}{-I_i}\right)$				

\*1. The phase value from the virtual neutral point is used to calculate Pk and Qk for 3P3W3M.

\*2. Phase angles of the fundamental voltage and current waveforms are calculated using only the first-order calculated harmonic, and are displayed by normalizing fundamental waveform U1 to 0°.

## 8.5 Calculation Formulas

Wiring Configuration Parameter	Single-Phase 2-Wire	Single-Phase 3-Wire	Three-phase, 3-wire		Three-Phase 4-Wire
	1P2W	1P3W	3P3W2M	3P3W3M	3P4W, 3P4W2.5E
<b>Voltage Total Harmonic Distortion THD</b> [%]	$THD_{UF1}$	$THD_{UF1}$ $THD_{UF2}$	$THD_{UF1}$ $THD_{UF2}$ $THD_{UF3}$		
	$THD_{Ufc} = \frac{\sqrt{\sum_{k=2}^{50} (U_{ck})^2}}{U_{c1}} \times 100$				
<b>Current Total Harmonic Distortion I THD</b> [%]	$THD_{IF1}$	$THD_{IF1}$ $THD_{IF2}$	$THD_{IF1}$ $THD_{IF2}$ $THD_{IF3}$		
	$THD_{IFc} = \frac{\sqrt{\sum_{k=2}^{50} (I_{ck})^2}}{I_{c1}} \times 100$				
<b>K factor KF</b>	$KF_1$	$KF_1$ $KF_2$	$KF_1$ $KF_2$ $KF_3$		
	$KFc = \frac{\sum_{k=1}^{50} (k^2 \times I_{ck}^2)}{\sum_{k=1}^{50} I_{ck}^2}$				

c: Measurement channel, k: Analysis order, r: Amount of resistance after FFT, i: Amount of reactance after FFT

Wiring Configuration Parameter	Single-Phase 2-Wire	Single-Phase 3-Wire	Three-phase, 3-wire		Three-Phase 4-Wire
	1P2W	1P3W	3P3W2M	3P3W3M	3P4W, 3P4W2.5E
<b>Voltage Unbalance Factor Uunb</b> [%]	/	/	/	$U_{unb} = \frac{\sqrt{1 - \sqrt{3 - 6\beta}}}{\sqrt{1 + \sqrt{3 - 6\beta}}} \times 100$ $\beta = \frac{U_{12}^4 + U_{23}^4 + U_{31}^4}{(U_{12}^2 + U_{23}^2 + U_{31}^2)^2}$	

# Maintenance and Service

## Chapter 9

### 9.1 Troubleshooting

#### Inspection and Repair



#### CAUTION

Never modify the instrument. Only Hioki service engineers should disassemble or repair the instrument. Failure to observe these precautions may result in fire, electric shock, or injury.



#### NOTE

If damage is suspected, check the "Before returning for repair" (p. 164)" section before contacting your dealer or Hioki representative.

#### Transporting

- Use the original packing materials when transporting the instrument, if possible.
- Pack the instrument so that it will not sustain damage during shipping, and include a description of existing damage. We cannot accept responsibility for damage incurred during shipping.

#### Replaceable Parts

Certain parts require replacement periodically and at the end of their useful life: (Useful life depends on the operating environment and frequency of use. Operation cannot be guaranteed beyond the following periods)

Part	Life
Lithium Battery	Approx. 10 years
Backlight (to half brightness)	Approx. 36,000 hours
Battery pack	Approx. 1 year
Electrolytic Capacitors	Deterioration occurs after about 10 years when used in severe environments (temperatures around 40°C).

- The instrument contains a built-in backup lithium battery, which offers a service life of about ten years. If the date and time deviate substantially when the instrument is switched on, it is the time to replace that battery. Contact your dealer or Hioki representative.
- The fuse is housed in the power unit of the instrument. If the power does not turn on, the fuse may be blown. If this occurs, a replacement or repair cannot be performed by customers. Please contact your dealer or Hioki representative.
- The instrument contains many electrolytic capacitors. The useful life of electrolytic capacitors varies greatly according to the operating environment, so they may need to be replaced periodically.

### Before returning for repair

If abnormal operation occurs, check the following items.

Symptom	Check Items
The POWER LED flashes, but nothing appears on the screen.	<ul style="list-style-type: none"> <li>• Is the power switch turned on?</li> <li>• Are the AC adapter and power cable securely connected?</li> <li>• Is the battery pack installed correctly?</li> <li>• Is the LCD backlight auto-off function enabled (ON)?</li> </ul>
The keys do not operate.	<ul style="list-style-type: none"> <li>• Are any of the keys stuck down?</li> <li>• Is the KEY LOCK function enabled (ON)?</li> </ul>
Measurement values are unstable.	<ul style="list-style-type: none"> <li>• Is the frequency of the lines to be measured 50/60 Hz? This instrument does not support 400-Hz lines.</li> </ul>
The expected measurement data cannot be obtained.	<ul style="list-style-type: none"> <li>• Are the voltage measurement and clamp sensor leads properly connected for the system wiring configuration?</li> <li>• Does the wiring configuration setting match the actual system wiring configuration?</li> </ul>
Operation is abnormal when connected to a computer.	<ul style="list-style-type: none"> <li>• Is the instrument power turned on?</li> <li>• Is the interface cable securely connected?</li> <li>• Is the PC application software installed?</li> </ul>
Power does not turn on.	<ul style="list-style-type: none"> <li>• A power protection component may be damaged. As these are not intended to be replaced or repaired by customers, please contact your supplier or nearest Hioki representative.</li> </ul>

### If the cause is unknown

Try performing a system reset. All settings are returned to their factory defaults.

**See:** "4.6 Initializing the Instrument (System Reset)" (p. 77)

## 9.2 Cleaning

### NOTE Cleaning the Instrument

- To clean the instrument and input modules, wipe it gently with a soft cloth moistened with water or mild detergent. Never use solvents such as benzene, alcohol, acetone, ether, ketones, thinners or gasoline, as they can deform and discolor the case.
- Wipe the LCD gently with a soft, dry cloth.

### Cleaning Clamp Sensors

- Measurements are degraded by dirt on the mating surfaces of the clamp-on sensor, so keep the surfaces clean by gently wiping with a soft cloth.

## 9.3 Battery Pack Replacement and Disposal

### **⚠ WARNING**

- To avoid electric shock when replacing the battery, turn the power switch off and disconnect all leads and cables from the instrument.
- To avoid the possibility of explosion, do not short circuit, disassemble or incinerate battery pack. Handle and dispose of batteries in accordance with local regulations.

### **NOTE**

- Expected battery pack life is about one year (or about 500 recharges). Replace only with another Hioki Model 9459 Battery Pack.
- The battery pack is subject to self-discharge. Be sure to charge the battery pack before initial use. If the battery capacity remains very low after correct recharging, the useful battery life is at an end.

### Replacement Procedure

**Important!** Disconnect the AC adapter when installing the battery pack.

Required tool: One Philips screwdriver

Battery Pack Compartment Cover

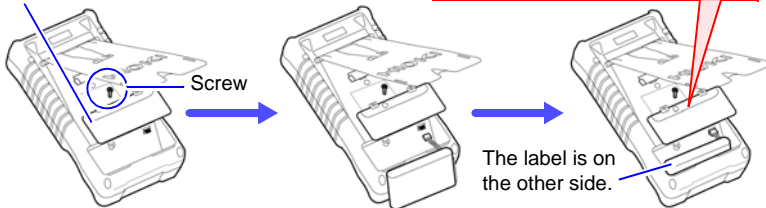

- 1** Turn the instrument over to remove the retaining screw from the battery pack compartment cover, and remove the cover.
- 2** Remove the battery pack and pull the plug out of the connector. It should be easy to remove when the instrument is laid upside down.
- 3** Connect a new battery pack to the connector, and insert it together with its wires.

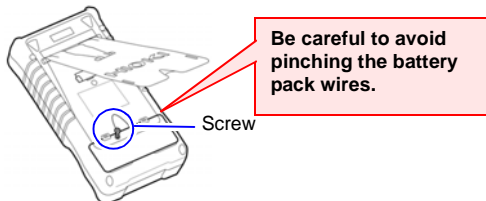

- 4** Replace the compartment cover and its retaining screw.

## 9.4 Disposing of the Instrument

### Before Disposing of the Instrument

The instrument contains a lithium battery for memory backup. Remove this battery before disposing of the instrument.



- To avoid electrocution, turn off the power switch and disconnect the power cord and cables before removing the lithium battery.
- Handle and dispose of batteries in accordance with local regulations.

### Removing the Lithium Battery

#### Required tools:

- One Philips screwdriver (to remove screws)
- One tweezers (to remove the lithium battery)

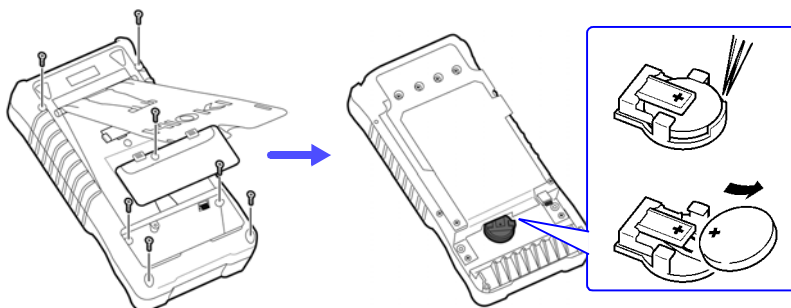

**1** Turn the instrument over to remove the retaining screw from the battery pack compartment cover, and remove the cover.

**2** Remove the six screws affixing the two halves of the case.

**3** To remove the battery, insert the tweezers between the lithium battery holder and the battery to grasp the battery.

**9**

#### CALIFORNIA, USA ONLY

This product contains a CR Coin Lithium Battery which contains Perchlorate Material - special handling may apply.  
See [www.dtsc.ca.gov/hazardouswaste/perchlorate](http://www.dtsc.ca.gov/hazardouswaste/perchlorate)





# Appendix

## Appendix 1 Interval and Recording Time Settings

Notes regarding the following table:

- \*1. The recording interval automatically changes to the next longer interval when the longest recording time for the currently selected interval is exceeded. The data at the start of measurement depends on the last interval selected when the previous measurement finished. Data from earlier measurements that does not match the last interval is deleted.
- \*2. The "Longest Recording Time" is the longest time that can be measured with the current recording interval.
- \*3. "Time Plot div" is the length of time represented by one graph division. This value is displayed at the lower right of the graph on the TIME PLOT screen.
- \*4. The "Number of divisions" is the number of divisions in a graph.
- \*5. The "Display period" is the longest time that can be displayed with the selected "Time Plot div". After this period, the next Time Plot div is displayed.

Interval setting: [Auto]

Recording Interval *1	When memory partitioning is set [OFF]				When memory partitioning is set [ON]			
	Longest Recording Time *2	Time Plot div *3 (div)	Number of divisions *4 (div)	Display period *5	Longest Recording Time *2	Time Plot div *3 (div)	Number of divisions *4 (div)	Display period *5
1sec	50min	30sec	7	3min 40sec	12min 30sec	30sec	7	3min 40sec
		1min	7	7min 20sec		1min	7	7min 20sec
		2min	7	14min 40sec		2min	7	
		5min	7	36min 40sec				
		10min	7					
2sec	1hour 40min	10min	7	1hour 13min 20sec	25min	2min	7	14min 40sec
		15min	7			5min	7	
10sec	8hours 20min	15min	7	1hour 50min	2hours 5min	5min	7	36min 40sec
		30min	7	3hours 40min		10min	7	1hour 13min 20sec
		1hour	7	7hours 20min		15min	7	1hour 50min
		2hour	7			30min	7	
30sec	1day 1hour	2hour	7	14hours 40min	6hours 15min	30min	7	3hours 40min
		3hour	7	22hours		1hour	7	
		6hour	7					
1min	2days 2hours	6hour	7	1day 20hours	12hours 30min	1hour	7	7hours 20min
		12hour	7			2hour	7	
5min	10days 10hours	6hour	9	2days 7hours	2days 14hours 30min	2hour	9	18hours 20min
		12hour	9	4days 14hours		4hour	9	1day 12hours 40min
		1day	9	9days 4hours		6hour	9	2days 7hours
		2day	9			12hour	9	

# A 2

## Appendix 1 Interval and Recording Time Settings

Interval setting: [Auto]

Recording Interval *1	When memory partitioning is set [OFF]				When memory partitioning is set [ON]			
	Longest Recording Time *2	Time Plot div *3 (/div)	Number of divisions *4 (div)	Display period *5	Longest Recording Time *2	Time Plot div *3 (/div)	Number of divisions *4 (div)	Display period *5
15min	31days 6hours	2day	9	18days 8hours	7days 19hours 30min	12hour	9	4days 14hours
		3day	9	27days 12hours		1day	9	
		4day	9					
30min	62days 12hours	4day	9	36days 16hours	15days 15hours	1day	9	9days 4hours
		5day	9	45days 20hours		2day	9	
		6day	9	55days				
		7day	9					
60min	125days	7day	9	64days 4hours	31days 6hours	2day	9	18days 8hours
		8day	9	73days 8hours		3day	9	27days 12hours
		9day	9	82days 12hours		4day	9	
		10day	9	91days 16hours				
		11day	9	100days 20hours				
		12day	9	110days				
		13day	9	119days 4hours				
		14day	9					

Recording Starts Recording Start Time: August 26, 2005, 13:09:11 (Recording Interval: 1 sec)

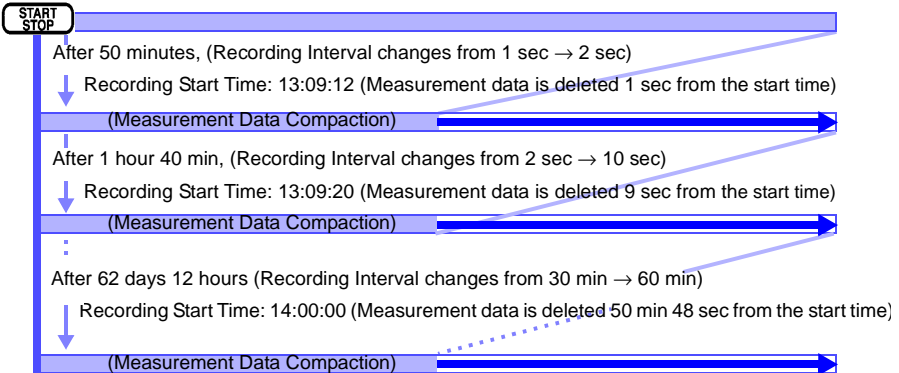

## Appendix 1 Interval and Recording Time Settings

Notes regarding the following table:

- \*1. Measurement is finished when the Longest Recording Time for the current Recording Interval has elapsed.
- \*2. The “Longest Recording Time” is the longest time that can be measured with the current recording interval.
- \*3. “Time Plot div” is the length of time represented by one graph division. This value is displayed at the lower right of the graph on the TIME PLOT screen.
- \*4. The “Number of divisions” is the number of divisions in a graph.
- \*5. The “Display period” is the longest time that can be displayed with the selected “Time Plot div”. After this period, the next Time Plot div is displayed.

Interval: 1, 5, 15, 30 and 60 min case

Recording Interval *1	When memory partitioning is set [OFF]				When memory partitioning is set [ON]			
	Longest Recording Time *2	Time Plot div *3 (div)	Number of divisions *4 (div)	Display period *5	Longest Recording Time *2	Time Plot div *3 (div)	Number of divisions *4 (div)	Display period *5
1min	2days 2hours	30min	7	3hours 40min	12hours 30min	30min	7	3hours 40min
		1hour	7	7hours 20min		1hour	7	7hours 20min
		2hour	7	14hours 40min		2hour	7	
		3hour	7	22hours				
		6hour	7	1day 20hours				
		12hour	7					
5min	10days 10hours	2hour	9	18hours 20min	2days 14hours 30min	2hour	9	18hours 20min
		4hour	9	1day 12hours 40min		4hour	9	1day12hours 40min
		6hour	9	2days 7hours	6hour	9	2days 7hours	
		12hour	9	4days 14hours	12hour	9		
		1day	9	9days 4hours				
		2day	9					
15min	31days 6hours	6hour	9	2days 7hours	7days 19hours 30min	6hour	9	2days 7hours
		12hour	9	4days 14hours		12hour	9	4days 14hours
		1day	9	9days 4hours		1day	9	
		2day	9	18days 8hours				
		3day	9	27days 12hours				
		4day	9					
30min	62days 12hours	12hour	9	4days 14hours	15days 15hours	12hour	9	4days 14hours
		1day	9	9days 4hours		1day	9	9days 4hours
		2day	9	18days 8hours		2day	9	
		3day	9	27days 12hours				
		4day	9	36days 16hours				
		5day	9	45days 20hours				
		6day	9	55days				
		7day	9					

# A 4

## Appendix 1 Interval and Recording Time Settings

Interval: 1, 5, 15, 30 and 60 min case

Recording Interval *1	When memory partitioning is set [OFF]				When memory partitioning is set [ON]			
	Longest Recording Time *2	Time Plot div *3 (div)	Number of divisions *4 (div)	Display period *5	Longest Recording Time *2	Time Plot div *3 (div)	Number of divisions *4 (div)	Display period *5
60min	125days	1day	9	9days 4hours	31days 6hours	1day	9	9days 4hours
		2day	9	18days 8hours		2day	9	18days 8hours
		3day	9	27days 12hours		3day	9	27days 12hours
		4day	9	36days 16hours		4day	9	
		5day	9	45days 20hours				
		6day	9	55days				
		7day	9	64days 4hours				
		8day	9	73days 8hours				
		9day	9	82days 12hours				
		10day	9	91days 16hours				
		11day	9	100days 20hours				
		12day	9	110days				
		13day	9	119days 4hours				
		14day	9					

## Appendix 2 Relation Between Graph Divisions and Time

Example of the case of seven graph divisions

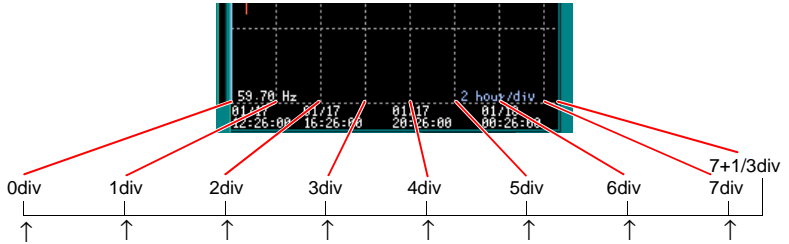

TimePlot Div (/div)	0div	1div	2div	3div	4div	5div	6div	7div
30sec	0min	0.5min	1min	1.5min	2min	2.5min	3min	3.5min
1min	0min	1min	2min	3min	4min	5min	6min	7min
2min	0min	2min	4min	6min	8min	10min	12min	14min
5min	0min	5min	10min	15min	20min	25min	30min	35min
10min	0min	10min	20min	30min	40min	50min	1hours	1hour 10min
15min	0min	10min	15min	30min	45min	1hour	1hours 15min	1hour 30min
30min	0min	30min	1hour	1hour 30min	2hours	2hours 30min	3hours	3hours 30min
1hour	0hours	1hour	2hours	3hours	4hours	5hours	6hours	7hours
2hour	0hours	2hours	4hours	6hours	8hours	10hours	12hours	14hours
3hour	0hours	3hours	6hours	9hours	12hours	15hours	18hours	21hours
6hour	0hours	6hours	12hours	18hours	1day	1day 6hours	1day 12hours	1day 18hours
12hour	0hours	12hours	1day	1day 12hours	2days	2days 12hours	3days	3days 12hours

# A 6

## Appendix 2 Relation Between Graph Divisions and Time

Example of the case of nine graph divisions

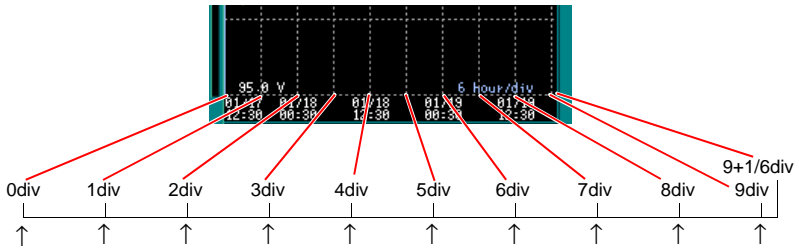

Time-Plot Div (/div)	0div	1div	2div	3div	4div	5div	6div	7div	8div	9div
2hour	0hours	2hours	4hours	6hours	8hours	10hours	12hours	14hours	16hours	18hours
3hour	0hours	3hours	6hours	9hours	12hours	15hours	18hours	21hours	1day	1day 3hours
4hour	0hours	4hours	8hours	12hours	16hours	20hours	1day	1day 4hours	1day 8hours	1day 12hours
6hour	0hours	6hours	12hours	18hours	1day	1day 6hours	1day 12hours	1day 18hours	2days	2days 6hours
12hour	0hours	12hours	1day	1day 12hours	2days	2days 12hours	3days	3days 12hours	4days	4days 12hours
1day	0days	1day	2days	3days	4days	5days	6days	7days	8days	9days
2day	0days	2days	4days	6days	8days	10days	12days	14days	16days	18days
3day	0days	3days	6days	9days	12days	15days	18days	21days	24days	27days
4day	0days	4days	8days	12days	16days	20days	24days	28days	32days	36days
5day	0days	5days	10days	15days	20days	25days	30days	35days	40days	45days
6day	0days	6days	12days	18days	24days	30days	36days	42days	48days	54days
7day	0days	7days	14days	21days	28days	35days	42days	49days	56days	63days
8day	0days	8days	16days	24days	32days	40days	48days	56days	64days	72days
9day	0days	9days	18days	27days	36days	45days	54days	63days	72days	81days
10day	0days	10days	20days	30days	40days	50days	60days	70days	80days	90days
11day	0days	11days	22days	33days	44days	55days	66days	77days	88days	99days
12day	0days	12days	24days	36days	48days	60days	72days	84days	96days	108days
13day	0days	13days	26days	39days	52days	65days	78days	91days	104days	117days
14day	0days	14days	28days	42days	56days	70days	84days	98days	112days	126days

## Appendix 3 3197 Data-header Composition

Classification	Header	Explanation
Date Time Status	Date	Date
	Time	Time
	Status	Status
TIME PLOT DIP/SWELL	Umax1, Umax2, Umax3	Voltage (1/2) Maximum value
	Umin1, Umin2, Umin3	Voltage (1/2) Minimum value
TIME PLOT RMS Maximum Values	MaxFreq	Frequency
	MaxUrms1, MaxUrms2, MaxUrms3	Voltage
	MaxU+peak1, MaxU+peak2, MaxU+peak3	Voltage Waveform Peak+
	MaxU-peak1, MaxU-peak2, MaxU-peak3	Voltage Waveform Peak-
	MaxIrms1, MaxIrms2, MaxIrms3, MaxIrms4	Current
	MaxI+peak1, MaxI+peak2, MaxI+peak3, MaxI+peak4	Current Waveform Peak+
	MaxI-peak1, MaxI-peak2, MaxI-peak3, MaxI-peak4	Current Waveform Peak-
	MaxUave	Voltage for 3phase
	MaxIave	Current for 3phase
	MaxPsum, MaxSsum, MaxQsum	Active Power, Apparent Power, Reactive Power
	MaxPFsum, MaxUunb	Power Factor
	MaxUthd1, MaxUthd2, MaxUthd3	Total Harmonic Voltage Distortion Ratio
TIME PLOT RMS Minimum Values	MinFreq	Frequency
	MinUrms1, MinUrms2, MinUrms3	Voltage
	MinU+peak1, MinU+peak2, MinU+peak3	Voltage Waveform Peak+
	MinU-peak1, MinU-peak2, MinU-peak3	Voltage Waveform Peak-
	MinIrms1, MinIrms2, MinIrms3, MinIrms4	Current
	MinI+peak1, MinI+peak2, MinI+peak3, MinI+peak4	Current Waveform Peak+
	MinI-peak1, MinI-peak2, MinI-peak3, MinI-peak4	Current Waveform Peak-
	MinUave	Voltage for 3phase
	MinIave	Current for 3phase
	MinPsum, MinSsum, MinQsum	Active Power, Apparent Power, Reactive Power
	MinPFsum, MinUunb	Power Factor
	MinUthd1, MinUthd2, MinUthd3	Total Harmonic Voltage Distortion Ratio
TIME PLOT RMS Average Values	AveFreq	Frequency
	AveUrms1, AveUrms2, AveUrms3	Voltage
	AveU+peak1, AveU+peak2, AveU+peak3	Voltage Waveform Peak+
	AveU-peak1, AveU-peak2, AveU-peak3	Voltage Waveform Peak-
	AveIrms1, AveIrms2, AveIrms3, AveIrms4	Current
	AveI+peak1, AveI+peak2, AveI+peak3, AveI+peak4	Current Waveform Peak+
	AveI-peak1, AveI-peak2, AveI-peak3, AveI-peak4	Current Waveform Peak-
	AveUave	Voltage for 3phase
	AveIave	Current for 3phase
	AvePsum, AveSsum, AveQsum	Active Power, Apparent Power, Reactive Power
	AvePFsum, AveUunb	Power Factor
	AveUthd1, AveUthd2, AveUthd3	Total Harmonic Voltage Distortion Ratio
TIME PLOT Energy Quadergy	WP+, WP-	Energy (Delivered, Received)
	WQ_LAG, WQ_LEAD	Quadergy (Lagging, Leading)

## Appendix 4 Displayed and Measurement Ranges

The displayed ranges and ranges of usable measurements (guaranteed accuracy) are as follows:

### Voltage Range

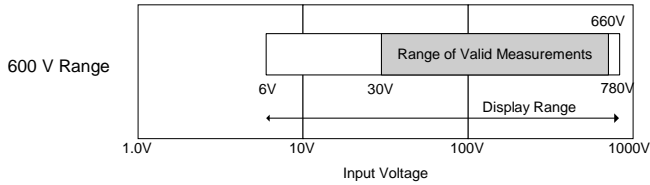

### Current Range

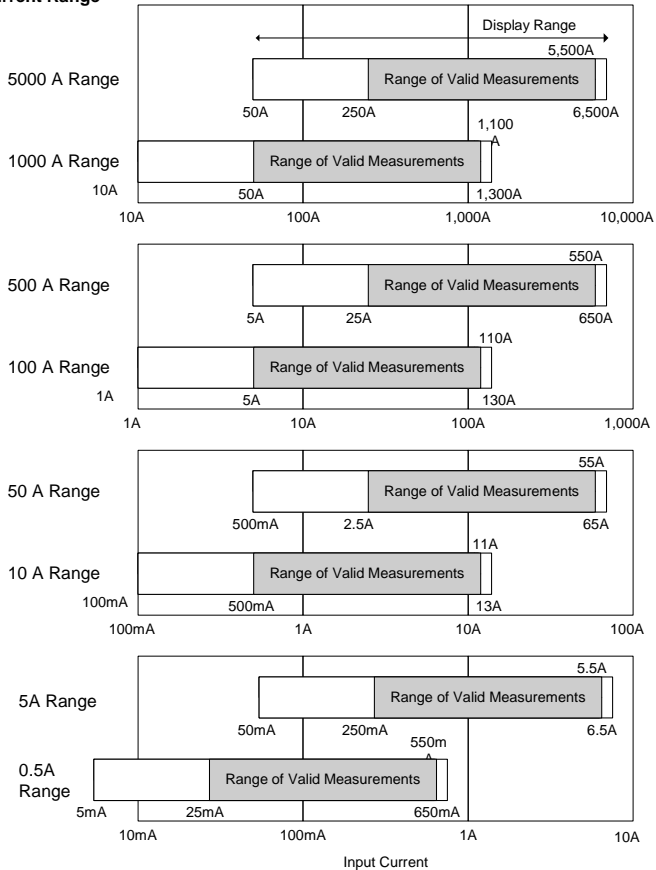



## Appendix 5 Power Range Structure

**Power Range Structure Table 1**

Current Range		Using Model 9657-10 or 9675 (100 mV/A)		Using Model 9694 or 9695-02 (10 mV/A)		Using Model 9660 or 9695-03 (5 mV/A)	
Voltage Range	Wiring Configuration	500.0mA	5.000A	5.000A	50.00A	10.00A	100.0A
600.0V	1P2W	300.0W	3.000kW	3.000kW	30.00kW	6.000kW	60.00kW
	1P3W 3P3W2M	600.0W	6.000kW	6.000kW	60.00kW	12.00kW	120.0kW
	3P3W3M, 3P4W, 3P4W2.5E	900.0W	9.000kW	9.000kW	90.00kW	18.00kW	180.0kW

**Power Range Structure Table 2**

Current Range		Using Model 9661 or 9667 in 500A range (1 mV/A)		Using Model 9669 (0.5 mV/A)		Using Model 9667 in 5 kA range (0.1 mV/A)	
Voltage Range	Wiring Configuration	50.00A	500.0A	100.0A	1.000kA	500.0A	5.000kA
600.0V	1P2W	30.00kW	300.0kW	60.00kW	600.0kW	300.0kW	3.000MW
	1P3W 3P3W2M	60.00kW	600.0kW	120.0kW	1.200MW	600.0kW	6.000MW
	3P3W3M, 3P4W, 3P4W2.5E	90.00kW	900.0kW	180.0kW	1.800MW	900.0kW	9.000MW

The range structure tables indicate the full-scale display value of each measurement range. The power range indicates summed values, with the 1P2W power range applicable to each channel regardless of the actual wiring configuration. The range structure of Apparent Power (S) and Reactive Power (Q) are the same, but in units of VA and var, respectively.

## Appendix 6 Clamp Sensor Combined Accuracy

### Current and Power Accuracy of Clamp Sensor Combinations

Clamp Sensor	3197 Range	Combined Accuracy
9657-10	0.5A	$\pm 1.3\% \text{rdg.} \pm 1.2\% \text{f.s.}$
	5A	$\pm 1.3\% \text{rdg.} \pm 0.3\% \text{f.s.}$
9675	0.5A	$\pm 1.3\% \text{rdg.} \pm 0.3\% \text{f.s.}$
	5A	$\pm 1.3\% \text{rdg.} \pm 0.21\% \text{f.s.}$
9694	5A	$\pm 0.6\% \text{rdg.} \pm 0.22\% \text{f.s.}$
	50A	No specified accuracy
9695-02	5A	$\pm 0.6\% \text{rdg.} \pm 0.4\% \text{f.s.}$
	50A	$\pm 0.6\% \text{rdg.} \pm 0.22\% \text{f.s.}$
9660	10A	$\pm 0.6\% \text{rdg.} \pm 0.4\% \text{f.s.}$
	100A	$\pm 0.6\% \text{rdg.} \pm 0.22\% \text{f.s.}$
9695-03	10A	$\pm 0.6\% \text{rdg.} \pm 0.4\% \text{f.s.}$
	100A	$\pm 0.6\% \text{rdg.} \pm 0.22\% \text{f.s.}$
9661	50A	$\pm 0.6\% \text{rdg.} \pm 0.3\% \text{f.s.}$
	500A	$\pm 0.6\% \text{rdg.} \pm 0.21\% \text{f.s.}$
9667 500A	50A	$\pm 2.3\% \text{rdg.} \pm 3.2\% \text{f.s.}$
	500A	$\pm 2.3\% \text{rdg.} \pm 0.5\% \text{f.s.}$
9669	100A	$\pm 1.3\% \text{rdg.} \pm 0.3\% \text{f.s.}$
	1kA	$\pm 1.3\% \text{rdg.} \pm 0.21\% \text{f.s.}$
9667 5kA	500A	$\pm 2.3\% \text{rdg.} \pm 3.2\% \text{f.s.}$
	5kA	$\pm 2.3\% \text{rdg.} \pm 0.5\% \text{f.s.}$

## Appendix 7 How to Resolve USB Data Transfer Problems

Problems connecting to the 3197Communicator USB Application software for Model 3197 may be due to incorrect settings of the dedicated device driver. Please follow the procedures below to resolve the problem.

### Checking the Hardware

- 1** Is the power to the 3197 turned on?
- 2** Is the USB cable properly connected to your PC and the 3197?
- 3** After starting the 3197Communicator application, does the "Refresh Communication" fail to respond?

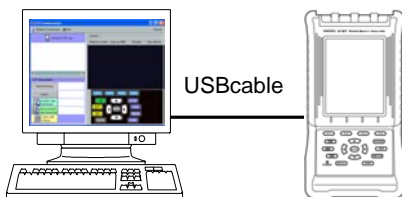

### Checking for Proper Setting of the Device Driver

Open your computer's Device Manager from the START – CONTROL PANEL – SYSTEM – Hardware Tab.

If not set properly, a question mark icon will appear in front of "Other Devices" and "3197" below it.

#### When the Device Driver is Operating Normally



#### When the Device Driver is NOT Operating Normally

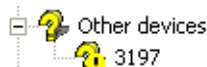

### Cause of Incorrect Settings made for Device Driver

Upon your initial connection of Model 3197 to your PC, the Windows Wizard should have appeared to help you set up the new device. If the instructions in Chapter 7 were not followed, and the default settings of the Wizard were selected, the device driver for Model 3197 may not have been properly installed.

### How to Resolve the Problem

- 1 Remove the incorrectly set device driver.  
Right-click on the file name “? 3197” under “Other devices” and select “Uninstall” from the menu.

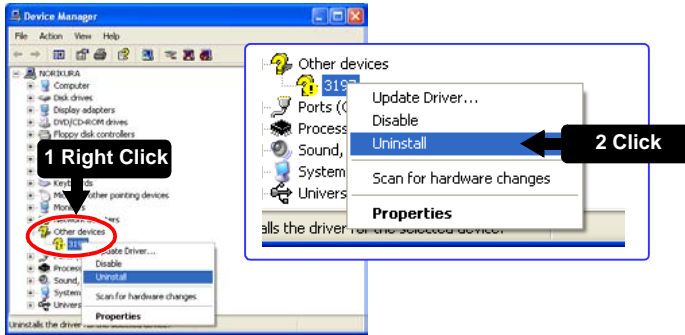

- 2 Reset the dedicated device driver.  
Follow the procedures in "7.4 Connecting the Instrument and Computer with the Supplied USB Cable"(p. 134) in the instruction manual.

Using the Windows Wizard, make sure that the options below are selected.

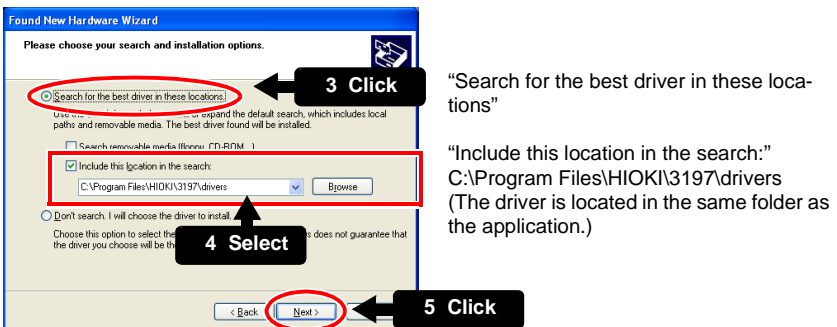
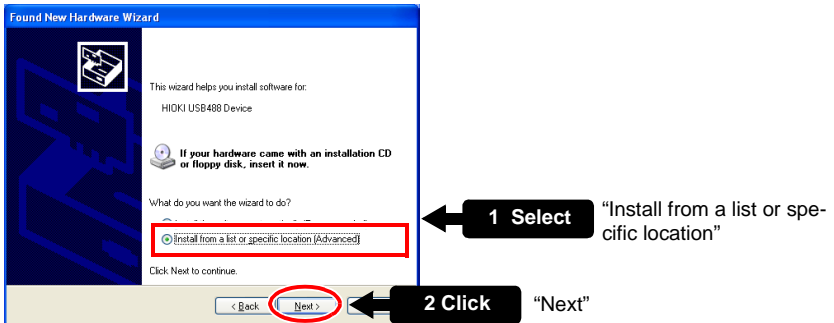

## Appendix 8 List of Settings (Default Settings)

The settings of this instrument are as follows.

Item	Initial State (Factory Default Setting)			O : Initialized x: Not Initialized		
				Power Resume	System Reset	
Setting	Measurement frequency	AUTO		x	O	
	Wiring Configuration	3P4W		x	O	
	Nominal Line Voltage	AUTO		x	O	
	Clamp Sensors	9661		x	O	
	Current Range	500A		x	O	
	PT Ratio	1 VARIABLE is also 1.00		x	O	
	CT Ratio	1 VARIABLE is also 1.00		x	O	
	Harmonic Calculation	rms value		x	O	
	Power Factor Type	PF		x	O	
	Memory Partitioning	ON		x	O	
	Interval	AUTO		x	O	
	Demand Period	30min		x	O	
	Timed Control	OFF		x	O	
	Timer Event	OFF		x	O	
	Voltage Transients	ON		x	O	
	Inrush Current	OFF (Threshold 0.0 A)		x	O	
	Voltage Swell	110%		x	O	
	Voltage Dip	90%		x	O	
	Interruption	10%		x	O	
	Display Language	Japanese	English	Chinese	x	x
	Phase Colors	TYPE1	TYPE5	TYPE3	x	x
	Phase Names	R S T	A B C	L1, L2, L3	x	x
	Beep Sounds	ON			x	O
	Screen Colors	COLOR 1			x	O
	LCD Backlight	Always ON			x	O
	LCD Contrast	+0			x	O
State	HOLD State	HOLD OFF		O	O	
	Internal Operating Status	Setting (Start key backup function)		O	O	
	Memory Recording Data	Erase		x	O	
	Browse Mode	Browse Mode OFF		O	O	
	Key Lock	Key Lock Disabled		x	O	

## Appendix 9 Definitions

### Detecting Anomalies and Phenomena Due to Drops in Power Quality

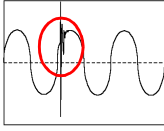
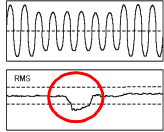
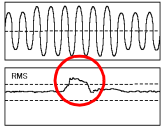
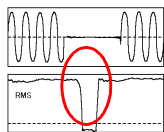
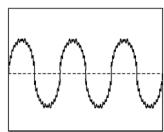
Power Quality Parameter	Waveform Display	Phenomenon	Related Malfunctions
Transient Overvoltage (Impulse)		Occurs typically as a result of lightning, circuit breaker tripping, fouled relay contacts or load shutdown. Many cases exhibit abrupt voltage changes and high peak voltage.	Near the source of the phenomena, power devices may sustain damage or operations reset abruptly because of the especially high voltage.
Voltage Dip (Sag)		As a result of large inrush current to a load such as a motor starting up, a brief voltage dip occurs.	Equipment may unexpectedly stop or reset due to low supply voltage.
Voltage Swell (Surge)		Instantaneous voltage increases that may occur as a result of lightning strikes, switching of heavily loaded power lines and other loads.	Damage to the power or reset operations of equipment may result from rising supply voltage.
Interruption		The power source may shut off momentarily or for a short or long term such as from tripping of a circuit breaker, often as a result of power company accident (electric supply interrupted by a lightning strike, etc.) or from power system short circuit.	The recent popularity of UPS (uninterruptible power supplies) has increased protection for computers and other equipment, although interruptions can still cause devices to shut down or reset.
Harmonics		Cases commonly occur when a semiconductor control system is employed to power equipment, where harmonics occur as a result of distortion of voltage and current waveforms.	When harmonic contents become large, major accidents such as resulting from abnormal heating of motors and transformers or burn out of reactances connected to leading-phase capacitors may occur.

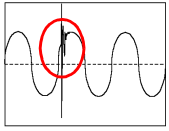
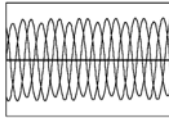
Power Quality Parameter	Waveform Display	Phenomenon	Related Malfunctions
Transient Overvoltage (Impulse)		<p>Occurs typically as a result of lightning, circuit breaker tripping, fouled relay contacts or load shutdown.</p> <p>Many cases exhibit abrupt voltage changes and high peak voltage.</p>	<p>Near the source of the phenomena, power devices may sustain damage or operations reset abruptly because of the especially high voltage.</p>
Unbalance Factor		<p>Because of the fluctuation of loads on each phase, such as when used for motive power or operation of machinery that load the phases unevenly, some phases may be more heavily loaded, causing more voltage or current waveform distortion on some phases than on others as a result of voltage drop or reactive voltage.</p>	<p>Voltage unbalance, reverse-phase voltage and harmonics can cause accidents resulting from occurrence such as unstable motor rotation, tripping of 3E breakers and transformer thermal overload.</p>

**Power Measurement by the Two-Meter Method, and U3, I3 Measurement Theory**

(3P3W2M Wiring Configuration Mode)

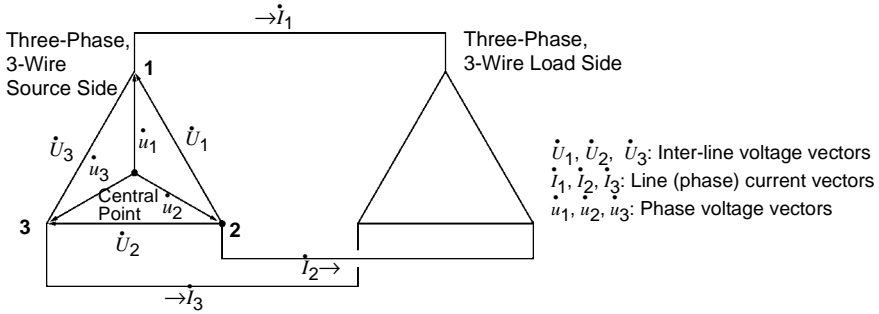

Circuit Concept of Three-Phase, 3-Wire Lines

Three-phase power P is usually calculated as the sum of the power of each phase.

$$P = \dot{u}_1 \dot{I}_1 + \dot{u}_2 \dot{I}_2 + \dot{u}_3 \dot{I}_3 \dots \dots \dots (1)$$

However, because there is no central point in three-phase, 3-wire lines, there is no way to measure the power of each phase independently, and even if there was, three wattmeters would be required to measure simultaneously. The two-wattmeter method is therefore commonly used (measuring two voltages and two currents).

Power can then be theoretically calculated by the following formulas:

When measuring  $\dot{U}_1, \dot{U}_2, \dot{I}_1$  and  $\dot{I}_2$  using wattmeters,

$$\begin{aligned}
 P &= \dot{U}_1 \dot{I}_1 + \dot{U}_2 \dot{I}_3 \text{ (where } \dot{U}_1 = \dot{u}_1 - \dot{u}_2 \text{ and } \dot{U}_2 = \dot{u}_3 - \dot{u}_2 \text{)} \dots \dots \dots (1) \\
 &= (\dot{u}_1 - \dot{u}_2) \dot{I}_1 + (\dot{u}_3 - \dot{u}_2) \dot{I}_3 \\
 &= \dot{u}_1 \dot{I}_1 + \dot{u}_2 (-\dot{I}_3 - \dot{I}_1) + \dot{u}_3 \dot{I}_3 \text{ (where the closed-circuit condition is } \dot{I}_1 + \dot{I}_2 + \dot{I}_3 = 0 \text{)} \\
 &= \dot{u}_1 \dot{I}_1 + \dot{u}_2 \dot{I}_2 + \dot{u}_3 \dot{I}_3 \dots \dots \dots (2)
 \end{aligned}$$

Here, formulas (1) and (2) match, proving the 2-wattmeter method of measuring three-phase, 3-wire power.

Also, there are no special requirements other than the closed circuit and no leakage circuit, so 3-phase power can be measured regardless of whether the phases are balanced.

The 3P3W2M wiring configuration mode of this instrument employs this method.



Also, under these conditions, the sums of the voltage and current vectors is always zero, so,

$$|\dot{U}_3| = |\dot{U}_1 - \dot{U}_2|$$

$$|\dot{I}_2| = |-\dot{I}_1 - \dot{I}_3|$$

are calculated internally to obtain measurements of the voltage and current of the third phase.

For  $\dot{U}_3$  and  $\dot{I}_2$ , measurement is performed regardless of distortion. These values affect the values of 3-phase apparent power and power factor.

**NOTE**

With the 3P3W2M wiring configuration mode of this instrument, the T phase current of the three-phase lines is applied to I2 in each circuit, so the T phase current of the three-phase lines is displayed as current I2, and the S phase calculated value of the three-phase lines is displayed as I3.

### Terminology

**K Factor** Also called the multiplication factor, the K factor expresses the power loss caused by harmonic currents in a transformer. The formula for calculating K factor (KF) is:

$$KF = \frac{\sum_{k=1}^{50} (k^2 \times I_k^2)}{\sum_{k=1}^{50} I_k^2}$$

k: Order of harmonic  
 Ik: Percentage of harmonic current relative to the fundamental current [%]  
 Higher-order harmonic currents have a greater influence on the K factor than do lower-order harmonic currents.  
 The K factor is measured while the transformer is subjected to the maximum circuit load.  
 If the measured K factor is larger than the multiplication ratio of the transformer being used, the transformer should be replaced with one having a higher K factor, or the load on the transformer must be reduced.  
 When replacing a transformer, the replacement should have a K factor one rank higher than the K factor measured with the transformer being replaced.

**Harmonic Phase Angle and Harmonic Phase Difference** The harmonic voltage phase angle and harmonic current phase angle are based upon the phase of the fundamental component of the PLL source (referenced to the PLL input, which is selected from U1 in this instrument). The phase difference between each harmonic component and the fundamental component is expressed as an angle (°), with a positive sign signifying lagging phase (LAG) and a negative sign signifying leading phase (LEAD).

The harmonic voltage-current phase difference expresses the difference between the phase of each harmonic order voltage component and the phase of each harmonic order current component for each channel, as an angle (°). The sum is the total power factor of each harmonic order (calculated from the total harmonic power and total harmonic reactive power) expressed as an angle (°). When the harmonic voltage-current phase difference is between -90° and +90°, the power of that harmonic order is flowing toward the load (inflow). When it is between +90° and +180° or between -90° and -180°, the power of that harmonic order is flowing away from the load (outflow).

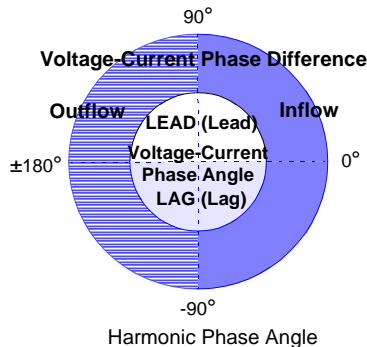

**Unbalance Factor**

- **Balanced (Symmetrical) Three-Phase Voltage (Current)**  
This term denotes three-phase alternating voltage or current when each phase has the same voltage (or current) and a phase difference of 120 degrees between phases.
- **Unbalanced (Asymmetrical) Three-Phase Voltage (Current)**  
Denotes three-phase alternating voltage or current when the voltages (or currents) of the phases are not the same, or when the phase difference between the phases is not 120 degrees.

Although the following descriptions refer to voltage, they apply to current as well.  
Degree of Unbalance in Three-Phase Alternating Voltage

Usually called the voltage unbalance factor, this is the ratio of negative-phase voltage to positive-phase voltage

$$\text{Voltage Unbalance Factor} = \frac{\text{Negative-Phase Voltage}}{\text{Positive-Phase Voltage}} \times 100 \text{ [\%]}$$

**Zero-Phase, Positive-Phase and Negative-Phase Voltage**

The concept of zero-, positive- and negative-phase components in a three-phase alternating circuit applies the method of symmetrical coordinates (in which a circuit is thought of as divided into symmetrical components of zero phase, positive phase, and negative phase).

- **Zero-phase component:** Voltage  $[V_0]$  that is equal in each phase (the “0” subscript denotes a zero-phase-sequence component).
- **Positive-phase component:** Symmetrical three-phase voltage  $[V_1]$  in which the value for each phase is equal, and each of the phases is delayed (lags) by 120 degrees in the phase sequence  $a \rightarrow b \rightarrow c$  (the “1” subscript denotes a positive-phase-sequence component).
- **Negative-phase component:** Symmetrical three-phase voltage  $[V_2]$  in which the value for each phase is equal, and each of the phases is delayed (lags) by 120 degrees in the phase sequence  $a \rightarrow c \rightarrow b$  (the “2” subscript denotes a negative-phase-sequence component).

If  $V_a$ ,  $V_b$ , and  $V_c$  are the three-phase alternating voltages, the zero-, positive- and negative-phase voltages are formulated as follows:

$$\text{Zero-phase voltage } V_0 = \frac{V_a + V_b + V_c}{3}$$

$$\text{Positive-phase voltage } V_1 = \frac{V_a + aV_b + a^2V_c}{3}$$

$$\text{Negative-phase voltage } V_2 = \frac{V_a + a^2V_b + aV_c}{3}$$

Here, “a” denotes the “vector operator”, which is a vector with magnitude 1 and phase angle of 120 degrees. Any given phase angle is advanced by 120 degrees when multiplied by a, and by 240 degrees when multiplied by  $a^2$ .

When the three-phase alternating voltage is balanced, the zero- and negative-phase voltages are 0, so only the positive-phase voltage (which in this case is equal to the rms value of the three-phase alternating voltage) is displayed remains.

**Power Factor (PF/DPF)** Power factor is the ratio of effective power to apparent power. The larger the absolute value of the power factor, the greater the proportion of effective power, which provides the power that is consumed, and the greater the efficiency. The maximum absolute value is 1. Conversely, the smaller the absolute value of the power factor, the greater the proportion of reactive power, which is not consumed, and the lower the efficiency. The minimum absolute value is 0.

For this device, the sign of the power factor indicates whether the current phase is lagging or leading the voltage. A positive value (no sign) indicates that the current phase is lagging the voltage. Inductive loads (such as motors) are characterized by lagging phase. A negative value indicates that the current phase is leading the voltage. Capacitive loads (such as capacitors) are characterized by leading phase.

The power factor (PF) is calculated using rms values that include harmonic components. Larger harmonic current components cause the power factor to deteriorate. By contrast, since the displacement power factor (DPF) calculates the ratio of effective power to apparent power from the fundamental voltage and fundamental current, no voltage or current harmonic component is included. This is the same measurement method used by reactive power meters installed at commercial-scale utility customers' facilities.

Displacement power factor, or DPF, is typically used by the electric power system, although power factor, or PF, is sometimes used to measure equipment in order to evaluate efficiency.

When a lagging phase caused by a large inductive load such as a motor results in a low displacement power factor, there are corrective measures that can be taken to improve the power factor, for example by adding a phase advance capacitor to the power system. Displacement power factor (DPF) measurements can be taken under such circumstances to verify the improvement made by the phase advance capacitor.

---

**Demand** Denotes the average power [kW] consumed during the demand period (typically 30 minutes), and is used for power company transactions.

---

# Index

## Numerics

1P2W .....	83
1P3W .....	83
3197 Communicator .....	127
3197DataViewer .....	127
3P3W2M .....	84
3P3W3M .....	84
3P4W .....	85
3P4W2.5E .....	85

## A

AC adapter .....	41
------------------	----

## B

Backlight .....	74
Basic setup .....	54, 56
Battery pack .....	40
Beep .....	74

## C

Charge .....	40
CHARGE LED .....	24
Clamp sensor .....	38, 45, 60, A10
Clock .....	32, 76
Color .....	73
Computer .....	127
Connection check .....	86
Contrast .....	75
Crest factor is out of range .....	33
CT ratio .....	61
Current flow direction arrow .....	82
Current input terminals .....	45
Current range .....	60

## D

Damage .....	163
Default .....	A13
Demand period .....	65
Display language .....	47, 73
Disposal	
Battery pack .....	166

## E

Event list .....	114, 116
Event monitor .....	114, 115
EVENT Screen .....	108
DETAILS .....	117
INRUSH .....	122
RMS WAVE .....	121
WAVEFORM .....	120

## F

Frequency .....	58
-----------------	----

## G

Ground .....	9
Grounded outlet .....	42

## H

Harmonic calculation .....	62
Harmonics .....	A14
Help comment .....	27

## I

Input terminal .....	37
Input terminal labels .....	37
Inrush current .....	69, 113
Inspection .....	79
Install .....	130, 132
Instrument Installation .....	7
Internal memory .....	32
Interruption .....	71, 111, A14
Interval .....	64

## J

JRE .....	128, 130
-----------	----------

## K

KEY LOCK .....	32, 51
Keys do not operate .....	164

## M

Manual .....	68, 113
--------------	---------

# Index 2

## Index

---

---

### N

---

Nominal Line Voltage ..... 59

### P

---

Partition ..... 34, 63, 89, 92  
    OFF ..... 89  
    ON ..... 92  
Period of guaranteed accuracy ..... 142  
PF type ..... 62  
Placement ..... 7  
Power cord ..... 19  
POWER LED ..... 23, 46  
Power range ..... A9  
Power supply indicators ..... 32  
Power switch ..... 23, 24  
PT ratio ..... 61

### R

---

Range ..... A8  
Ranges of guaranteed accuracy ..... A8  
Ranges of usable measurements ..... A8  
Repair ..... 163  
REVIEW ..... 123

### S

---

Save screen image ..... 52  
SC ..... 33  
Self-Test ..... 47  
Serial No. .... 26, 76  
Single-Phase 2-Wire ..... 83  
Single-Phase 3-Wire ..... 83  
Stand ..... 26  
Start ..... 68  
Startup screen ..... 47, 80  
Stop ..... 68  
Strap ..... 38  
Strap hole ..... 24  
System reset ..... 77  
SYSTEM screen ..... 57  
    MEASURE ..... 57  
    REC&EVENT ..... 63, 67  
    SYSTEM ..... 72

### T

---

Three-Phase 3-Wire ..... 84  
Three-Phase 4-Wire ..... 85  
TIME PLOT Screen  
    DEMAND ..... 106  
    DIP/SWELL ..... 105  
    ENERGY ..... 107

RMS ..... 103  
Time start ..... 66  
Timer ..... 69, 113  
Transient ..... 70  
Transient overvoltage ..... 112, A14  
Two-wattmeter method ..... A16  
Typical settings ..... 54

### U

---

Unbalance factor ..... A15  
USB cable ..... 127  
USB driver ..... 134  
USB port ..... 24

### V

---

Version ..... 72  
VIEW Screen ..... 96  
    Display hold ..... 96  
    DMM ..... 101  
    HARMONICS ..... 99  
    VECTOR ..... 98  
Voltage cords ..... 42  
Voltage dip ..... 71, 111, A14  
Voltage input terminals ..... 24  
Voltage inputs terminal ..... 43  
Voltage swell ..... 71, 110, A14

### W

---

WAVEFORM ..... 97  
Wiring ..... 58

---



# HIOKI

---

HIOKI E. E. CORPORATION

## Headquarters

81 Koizumi, Ueda, Nagano 386-1192, Japan  
TEL +81-268-28-0562 FAX +81-268-28-0568 E-mail: os-com@hioki.co.jp  
URL <http://www.hioki.com/>  
(International Sales and Marketing Department)

## HIOKI USA CORPORATION

6 Corporate Drive, Cranbury, NJ 08512, USA  
TEL +1-609-409-9109 FAX +1-609-409-9108 E-mail: hioki@hiokiusa.com  
URL <http://www.hiokiusa.com>

## HIOKI (Shanghai) Sales & Trading Co., Ltd.

1608-1610, Shanghai Times Square Office 93 Huaihai Zhong Road Shanghai,  
P.R.China POSTCODE: 200021  
TEL +86-21-63910090 FAX +86-21-63910360 E-mail: info@hioki.com.cn  
URL <http://www.hioki.cn>

## HIOKI INDIA PRIVATE LIMITED

Khandela House, 24 Gulmohar Colony Indore 452 018 (M.P.), India  
TEL +91-731-6548081 FAX +91-731-4020083 E-mail: info@hioki.in  
URL <http://www.hioki.in>

## HIOKI SINGAPORE PTE. LTD.

33 Ubi Avenue 3, #03-02 Vertex Singapore 408868  
TEL +65-6634-7677 FAX +65-6634-7477 E-mail: info@hioki.com.sg

1205

- 
- For regional contact information, please go to our website at <http://www.hioki.com>.
  - The Declaration of Conformity for instruments that comply to CE mark requirements may be downloaded from the HIOKI website.
  - All reasonable care has been taken in the production of this manual, but if you find any points which are unclear or in error, please contact your supplier or the International Sales and Marketing Department at Hioki headquarters.
  - In the interests of product development, the contents of this manual are subject to revision without prior notice.
  - The content of this manual is protected by copyright. No reproduction, duplication or modification of the content is permitted without the authorization of Hioki E.E. Corporation.