

BT6065

BT6075

HIOKI

Instruction Manual

PRECISION BATTERY TESTER



The latest edition of the instruction manual



Read carefully before use.
Keep for future reference.

Safety Information ▶ p. 12

Part Names and Functions ▶ p. 20

Making Measurements ▶ p. 45

Maintenance and Service ▶ p. 209

On-Screen Errors ▶ p. 218

EN

Apr. 2024 Edition 1
BT6065A961-00



Contents

Introduction.....	7	2.9	Selecting a Time Zone.....	41
Checking Package Contents.....	8	2.10	Configuring the Line-Frequency Setting.....	43
Optional Equipment.....	9			
Notations.....	10			
Safety Information.....	12			
Precautions for Use.....	13			
Conventions Used in This Manual.....	15			
1 Overview	17			
1.1 Product Overview.....	17	3.1	Selecting a Measuring Function.....	46
1.2 Features.....	17		By pressing a physical key.....	46
1.3 Part Names and Functions.....	20		By tapping the touchscreen.....	46
1.4 Screen Configuration.....	23	3.2	Configuring the Measurement Range Settings.....	47
Measurement screen.....	23		Configuring the resistance measurement settings.....	47
Settings screen.....	24		Turning high resolution mode on.....	48
Indicators on the measurement screen.....	26		Selecting a measurement current of the 3 mΩ range.....	49
1.5 Basic Operations.....	27	3.3	Configuring the voltage measurement settings.....	50
1.6 Measurement Procedure.....	30		Thresholds for the auto-ranging.....	51
		3.3	Selecting a Sampling Speed.....	52
		3.4	Performing the Self-Calibration Processes.....	53
			Performing a resistance self-calibration process.....	53
			Performing a DC-voltage self- calibration process (automatic/manual).....	54
		3.5	Performing the Zero Adjustments.....	56
			Zero-adjustment target map.....	57
			Connecting a test lead.....	57
			Arranging the test lead in the measurement environment used for the zero adjustment.....	58
			Configuring the zero-adjustment settings.....	60
			Performing a referential adjustment.....	61
			Applying the adjustment values (How to check the obtained adjustment values).....	63
		3.6	Performing the Referential Adjustments.....	65
			Overall procedure of the referential adjustment.....	66
			Referential-adjustment target map.....	67
			Configuring the reference-adjustment settings.....	68
			Performing a referential adjustment.....	69
			Applying the adjustment values (How to check the obtained adjustment values).....	74

3.7	Connecting a Test Lead to Objects Under Measurement (Batteries).....	75
3.8	Displaying Measurement Results	76
	Features of the contact check (wire-break detection)	77
	Overrange indication.....	78
3.9	Route-Resistance Monitor.....	79
	Route-resistance measurement error	81
	Information on the measured route-resistance value display area	82

4 Advanced Measurement 87

4.1	Starting Measurements With Triggers.....	87
	Making measurements by internal triggers.....	88
	Making a measurement by an external trigger.....	88
	Trigger system.....	89
4.2	Starting Sampling After Measurement Signals Stabilize (Trigger Delay).....	90
4.3	Averaging Measured Values	91
4.4	Reducing Mutual Interference During Resistance Measurement (Working in MIR Mode).....	93
4.5	Displaying Measured Values as Zero	95
4.6	Converting Negative DC-Voltage Values Into Positive Values	96
4.7	Switching Between Input Resistances.....	97
4.8	Switching Between Temperature Scales	98

5 Comparator Capability 99

5.1	Judging Measured Values of Resistance and DC Voltage.....	99
5.2	Defining the Upper and Lower Limits of the Comparator Capability.....	100
5.3	Configuring the Sound Settings	102

5.4	Configuring the Comparator Settings for the Route-Resistance Monitor	103
	Defining judgment thresholds	103
5.5	Checking Judgment Results	105
	Judgment operation (on measured resistance and voltage values)	105
	Judgment operation (on measured route-resistance value).....	106
	Externally outputting Pass/Fail judgments.....	107

6 Configuring System Settings 109

6.1	Configuring the Operation-Feedback Sound Setting	109
6.2	Adjusting the Backlight Brightness.....	110
6.3	Configuring the Screen Saver Settings	111
6.4	Configuring the Key Lock Setting	112
6.5	Calibrating the Touchscreen	113
6.6	Selecting On-Screen Colors for Measured Values and the Background	114
6.7	Checking the ROM and RAM for Proper Operation	115
6.8	Checking Reactance (X) of Objects Under Measurement and Wiring Layout	116
6.9	Resetting the Instrument	117
	Default settings and settings to be reverted to the default.....	118

7 Saving/Loading Measurement Conditions (Panel Saving/Loading Capability) 121

7.1	Saving Measurement Conditions (Panel Saving Capability).....	122
7.2	Loading Measurement Conditions (Panel Loading Capability).....	123

7.3	Changing Panel Names	124
7.4	Deleting Saved Measurement Conditions.....	125

8 Externally Controlling the Instrument (External I/O) 127

8.1	External Input/Output Terminals and Signals.....	129
	Switching between two I/O modes: current sinks (NPN) and current sources (PNP)	129
	Mounted connector and pin assignment.....	129
	Signal functions	130
8.2	Timing Charts.....	134
	When the ERR-signal output is set to asynchronous.....	134
	From starting the measurement to acquiring judgment results	135
	Zero adjustment timing.....	138
	Self-calibration timing.....	139
	Panel loading timing	140
	Output signal states when the instrument is turned on.....	141
	Obtaining judgment results with the external trigger setting	142
8.3	Internal Circuitry	143
	NPN setting	143
	PNP setting	144
	Electrical specifications	145
	Example connections.....	145
8.4	Configuring the External Input and Output Settings	147
	Configuring the TRIG-signal input filter settings.....	147
	Configuring the EOM-signal output type settings	148
	Selecting an ERR-signal output timing	149
8.5	Testing the External Input/ Output Capability (External I/O Testing Capability).....	150

9 Controlling the Instrument via Communications 151

9.1	Overview and Features of Interfaces.....	152
	Switching between the remote and local states	153
9.2	Working with the LAN Interface.....	153
9.3	Working with the RS-232C Interface.....	158
9.4	Working with the USB Port (COM mode)	160
9.5	Configuring the Communications Settings.....	164
	Displaying the communications monitor (displaying communications commands)	164
	Selecting a measured-value format	165
	Turning the command compatibility mode on.....	166

10 Outputting Measured Values (via LAN, RS-232C, and USB) 167

10.1	Selecting an Interface	167
10.2	Outputting Data.....	168
10.3	Configuring the Measured-Value Output Settings	169
10.4	Transmitting Measured Values in Batches (Memory).....	170

11 Saving Screenshots 173

11.1	Saving Screenshots (Onto a USB Flash Drive)	173
------	--	-----

12 Specifications 177

12.1 General Specifications.....177

12.2 Input, Output, and Measurement Specifications.....178

 Basic specifications178

 Accuracy Specifications182

12.3 Functional Specifications187

12.4 Interface Specifications202

12.5 Key-Input Specifications.....206

12.6 Default Settings and Settings to be Reverted to the Default.....206

12.7 Optional Equipment Specifications.....207

 L2120 Pin Type Lead (for four-terminal measurement)207

 L2121 Clip Type Lead (for four-terminal measurement)208

13 Maintenance and Service 209

13.1 Showing Various Information on the Display.....209

13.2 Repair, Inspection, and Cleaning.....210

 Calibration.....210

 Replaceable parts and service life210

 Cleaning.....211

13.3 Troubleshooting212

 Before returning for repair212

13.4 On-Screen Errors218

13.5 Disposing of the Instrument222

 Removing the lithium battery222

14 Appendix 225

14.1 When Creating a Test-Lead Assembly by Yourself.....225

14.2 AC Four-Terminal Method230

14.3 Synchronous Detection231

14.4 Variation in Measured Values According to the Test Lead232

14.5 Extending a Test Lead233

14.6 Effects of Electromagnetic Induction and Eddy Currents234

 Effect of electromagnetic induction234

 Effect of Eddy Currents235

 Countermeasures against the effects of electromagnetic induction and eddy currents236

14.7 Effect of Mutual Interference.....238

 Countermeasures against the effect of mutual interference239

14.8 Countermeasures Using MIR Mode Against Mutual Interference240

14.9 Calibrating the Instrument.....242

 Calibrating the resistance measuring function242

 Calibrating the DC-voltage measuring function243

 Calibrating the route-resistance measuring function244

 Calibrating the temperature measuring function245

14.10 Zero Adjustment246

14.11 Test Lead (Optional Equipment).....251

14.12 Rack-Mounting the Instrument254

14.13 External Views256

14.14 License Information.....257

Index 259

Introduction

Thank you for choosing the Hioki BT6065/BT6075 Precision Battery Tester. To ensure you get the most out of this instrument over the long term, please read this manual carefully and keep it available for future reference.

The difference between the BT6065 and BT6075 is as follows.

	BT6065	BT6075
DC-voltage measurement resolution	10 μ V	1 μ V

Request for product user registration

Please register this product so that you can receive important information regarding the product.

<https://www.hioki.com/global/support/myhioki/registration/>



The following instruction manuals are available. Please refer to these resources as necessary in light of your specific application.

Names of the instruction manuals	Contents	Form of supply
Instruction Manual (this manual)	Product outline, operation method, functional description, and specifications of the instrument	PDF (Downloadable from the Internet)
Startup Guide	Information regarding the safe use of this instrument, basic operations, and specifications (excerpts)	Hard copy
Communications Command Instruction Manual	Explanation of communications commands for controlling the instrument	PDF (Downloadable from the Internet)
Operating Precautions	Information regarding the safe use of this instrument Please review the separate <i>Operating Precautions</i> before using this instrument.	Hard copy

Target audience

This manual has been written for use by individuals who use the product or provide information about how to use the product.

In explaining how to use the product, it assumes electrical knowledge (equivalent of the knowledge possessed by a graduate of an electrical program at a technical high school).

Trademarks

Microsoft and Windows are trademarks of the Microsoft group of companies.

Checking Package Contents

When you receive the product, inspect them for any damage or anomalies. If you discover any damage or find that the product does not perform as indicated in the specifications, please contact your authorized Hioki distributor or reseller.

Verify that the package contents are correct.

Instrument

- BT6065/BT6075 Precision Battery Tester

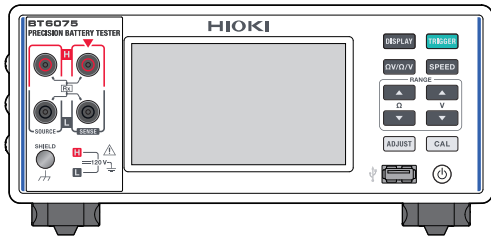

Included accessories

- Power cord

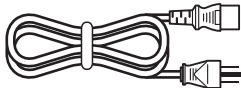







- Startup Guide
- Operating Precautions (0990A903)

Optional Equipment

The optional equipment listed below is available for the instrument. To purchase optional equipment, please contact your authorized Hioki distributor or reseller.





Optional equipment is subject to change with no advance notice. Check Hioki's website for the latest information.

Model name		Rated voltage	Rated current	Length
Z2005 Temperature Sensor		–	–	Approx. 1 m
L2100 Pin Type Lead		1000 V DC	2 A DC	Approx. 1.4 m
L2120 Pin Type Lead		1000 V DC	2 A DC	Approx. 1.4 m
L2121 Clip Type Lead		60 V DC	2 A DC	Approx. 1.2 m
9772-90 Tip Pin (Replacement tip for the L2100 and L2120)		–	–	–
Z5038 0 Adj Board (For the L2100 and L2120)		–	–	–
Z4006 USB Drive		–	–	–
L9510 USB Cable (Type A-to-type C)		–	–	Approx. 1 m
9642 LAN Cable		–	–	Approx. 5 m
L9637 RS-232C Cable (9 pins-to-9 pins, crossover)		–	–	Approx. 3 m









Notations

Safety notations



This manual classifies seriousness of risks and hazard levels as described below.

 DANGER	Indicates an imminently hazardous situation that, if not avoided, will result in death or serious injury.
 WARNING	Indicates a potentially hazardous situation that, if not avoided, could result in death or serious injury.
 CAUTION	Indicates a potentially hazardous situation that, if not avoided, could result in minor or moderate injury or potential risks of damage to the supported product (or to other property).
IMPORTANT	Indicates information or content particularly important for operating or maintaining the product.
	Indicates a prohibited action.
	Indicates a mandatory action.

Symbols on the product

	Indicates the presence of a potential hazard. See “Precautions for Use” (p. 13) and warning messages listed at the beginning of each operating instruction in the instruction manual and the accompanying document entitled Operating Precautions.
	Indicates the on position of the power switch.
	Indicates the off position of the power switch.
	Indicates the push-button switch that can turn the product on and off.
	Indicates the grounding terminal.
	Indicates the chassis terminal. The terminal is connected to the enclosure of the product.
	Indicates that the product can be used for direct current (DC).
	Indicates that the product can be used for alternating current (AC).

Symbols for various standards

	Indicates that the product is subject to the Directive on Waste Electrical and Electronic Equipment (WEEE) in EU member nations. Dispose of the product by local regulations.
	Indicates that the product complies with standards imposed by EU directives.

Other notations

Tips	Indicates useful functions and advice you should be aware of.
*	Indicates additional information is described below.
☑	Indicates the default setting value of the setting item. Resetting the product reverts the setting to this default value.
(p.)	Indicates the page number to reference.
TRIGGER (bold)	Indicates the labels and buttons on the screen.
[]	Indicates the names of user interface elements on the screen.
Windows	Unless otherwise noted, the term <i>Windows</i> is generically used to refer to <i>Windows 10</i> and <i>Windows 11</i> .

Accuracy labeling

The accuracy of the measuring instrument is expressed using a combination of the formats shown below:

- By defining limit values for errors using the same units as measured values.
- By defining limit values for errors as a percentage of the reading and in terms of digits.

Reading (display value)	Indicates the value displayed on the measuring instrument. Limit values for reading errors are expressed as a percentage of the reading (<i>% of reading</i> or <i>% rdg</i>).
Digit (resolution)	Indicates the minimum display unit (in other words, the least significant digit that can have a value of one) for a digital measuring instrument. Limit values for digit errors are expressed in terms of <i>digits</i> .

Safety Information

This instrument has been designed to conform to the international standard, IEC 61010, and thoroughly tested for safety before shipment. However, using the instrument in a way not described in this manual may negate the provided safety features.

Carefully read the following safety notes before use.

DANGER



- **Familiarize yourself with the contents of this manual before use.**

Otherwise, the instrument will be misused, resulting in serious bodily injury or damage to the instrument.

WARNING



- **If you have not previously used electrical measuring instruments, ensure adequate supervision by a technician with experience in electrical measurement.**

Failure to do so could cause the user to experience an electric shock. It could also cause serious events, such as heat generation, fire, or arc flash due to a short-circuit.

Precautions for Use

Observe the following precautions to ensure the safe use of the instrument and to maximize its capabilities.

Ensure that use of the instrument conforms not only to its specifications but also to the specifications of all equipment to be used, including accessories and optional equipment.

Placing the Instrument

WARNING

■ **Do not place the instrument in locations such as the following:**

- Where it would be subject to direct sunlight or high temperatures
- Where it would be exposed to corrosive or explosive gases
- Where it would be exposed to powerful electromagnetic radiation or close to objects carrying an electric charge
- Where there is an inductive heating device (such as high-frequency inductive heating devices and IH cooktops)
- Where there is a large amount of mechanical vibration
- Where it would be exposed to water, oil, chemicals, or solvents
- Where it would be exposed to high humidity or condensation
- Where there is an excessive amount of dust



Doing so could damage the instrument or cause it to malfunction, resulting in bodily injury.

■ **Place the instrument, leaving enough space around it to facilitate unplugging the power cord.**



If there is not enough space left around, the power cannot be shut off immediately in an emergency. Failure to do so could result in bodily injury, fire, or damage to the instrument.

CAUTION

■ **Do not place the instrument on an unstable stand or angled surface.**



Doing so could cause the instrument to fall or overturn, resulting in bodily injury or damage to the instrument.

Leave the specified distance of spaces from the instrument to prevent its temperature from rising.

- Place the instrument with its bottom facing down.
- Do not block vent openings.

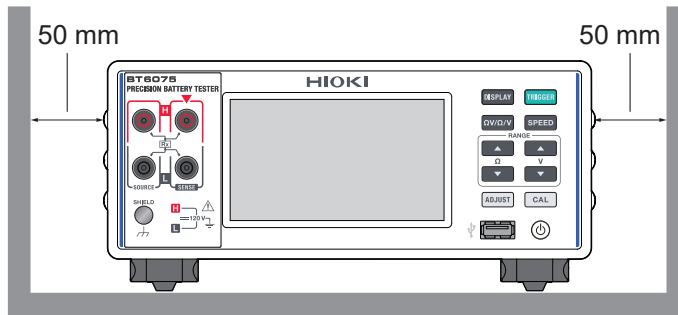

Handling the instrument

CAUTION



- Do not subject the instrument to vibration or mechanical shock while transporting or handling it.
- Do not drop the instrument on the floor.

Doing so could damage the instrument.

The instrument is classified as a Class A device under the EN 61326 standard.

Use of the instrument in a residential setting such as a neighborhood could interfere with reception of radio and television broadcasts. If this occurs, take appropriate steps to counteract the issue.

Handling test leads

DANGER



- Check the test lead for damaged insulation or exposed metal before use.

Using a damaged test lead or the instrument will cause serious bodily injury. If you find any damage on a product, replace it with a Hioki-specified one.

WARNING



- After making a measurement on a high-voltage battery, do not touch the metal tips of the test lead.

Doing so could cause the user to experience an electric shock because electric charge remains inside the instrument. (internal discharge time: about 2 s)

Precautions when transporting the instrument

Store the packaging material after unpacking the instrument. Use the original packaging when shipping the instrument.

Conventions Used in This Manual

This manual explains how to display various setting screens as described in the dotted-line frames.

[MENU] > [SYSTEM]

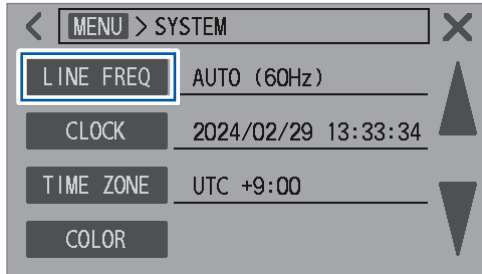

1 Tap [LINE FREQ].

The description above instructs you to operate the instrument as follows:

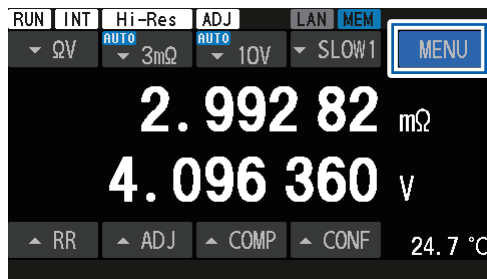

1 On the measurement screen, tap [MENU].

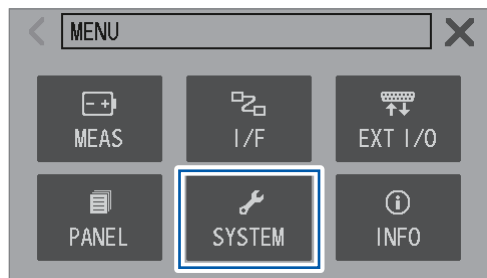

2 Tap [SYSTEM].
The setting screen appears.

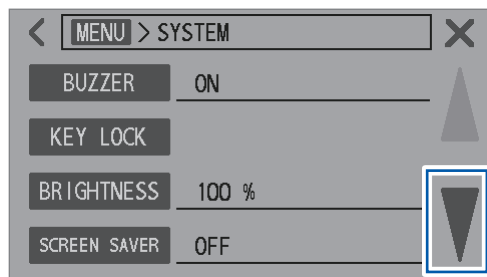

3 Tap [▼] several times until the item you want to set is displayed.

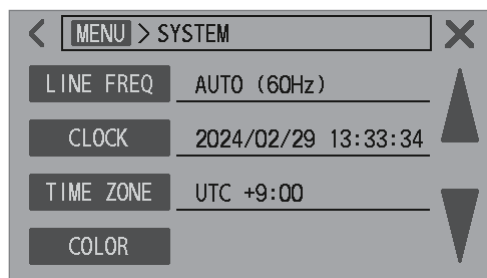

1.1 Product Overview

The BT6065/BT6075 is a battery tester capable of measuring the internal resistance of batteries using the AC four-terminal method (with a measurement frequency of 1 kHz). Additionally, it can simultaneously measure the DC voltage (electromotive force of batteries). With its high-speed and high-precision capabilities, along with a full range of interfaces, the BT6065/BT6075 is ideal for integration into battery production inspection lines.

1.2 Features

● High-resolution, high-accuracy measurement

The BT6065/BT6075 achieves the highest level of accuracy within the electric measuring instrument industry, specifically in measuring both resistance and DC voltage. This makes it an ideal tool for sorting battery cells.

	BT6065	BT6075
Resistance measurement resolution (with high resolution mode on * ¹)	0.01 $\mu\Omega$	
DC-voltage measurement resolution	10 μV	1 μV
Resistance measurement accuracy	$\pm 0.08\%$ rdg	
DC-voltage measurement accuracy	$\pm 0.002\%$ of reading	$\pm 0.0012\%$ of reading

*1. See "Turning high resolution mode on" (p.48).

● High-speed measurement of internal resistance, voltage, and route resistance of batteries at the same time

The instrument can perform a measurement in approx. 12 ms at its fastest speed.
Approx. 8 ms of response time and 4 ms of sampling time

Route-resistance monitor (p.79)

For the four-terminal connection, the route resistance of wires connected to each terminal can be measured.

The route resistance is the total value of all the resistance components from the measurement terminals of the instrument. These resistance values do not include the internal resistance of objects under measurement (batteries).

An example of route resistance is shown below.

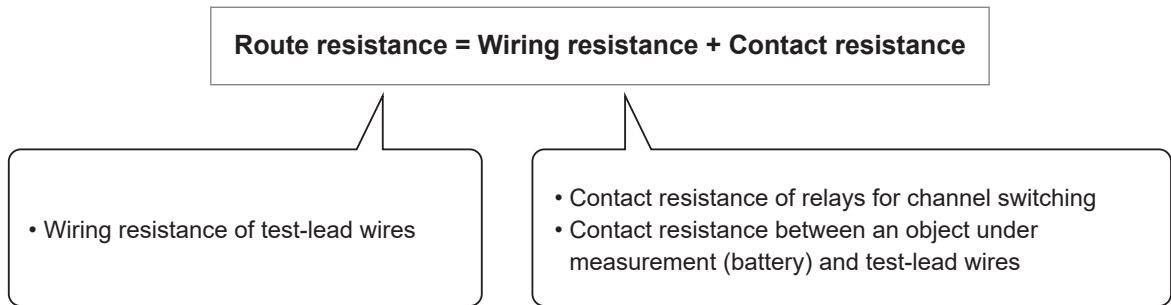

The route resistance is measured simultaneously with the internal resistance of a battery. Continuous monitoring of the route resistance allows effective maintenance management of a measurement system. Additionally, thresholds can be defined for route resistance measurement, enabling a three-level judgment (Pass, Warning, and Fail).

Breakdown of route resistance (example)

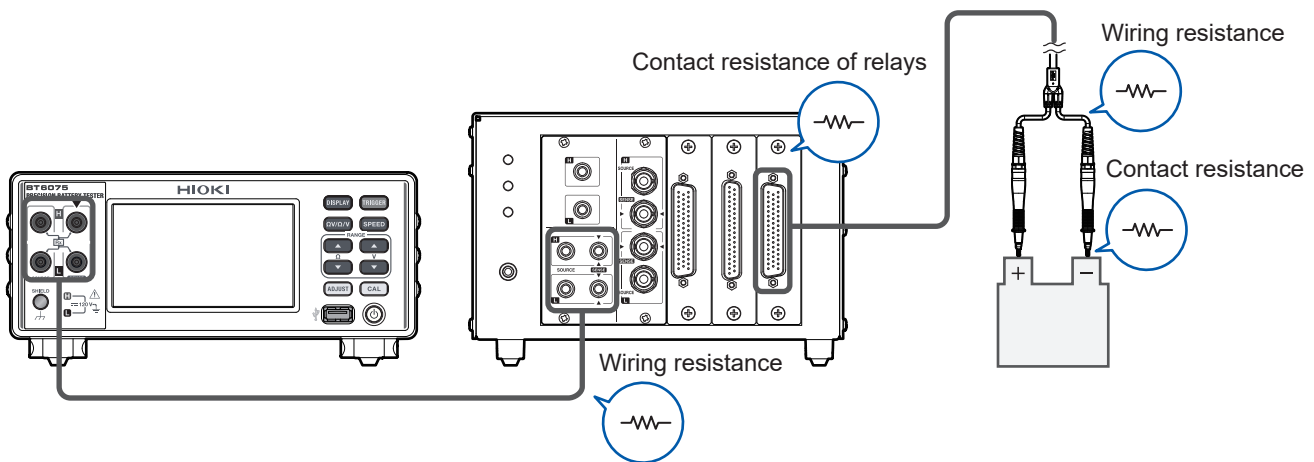

Resistance-measurement MIR mode (p.93)

MIR stands for *mutual interference reduction*.

When two instruments are simultaneously used in close proximity, employing this mode can help stabilize resistance measurements.

Zero adjustment (p.56)

The instrument has the capability to save zero-adjustment data for up to 528 channels.

Offsets*¹ caused by measurement environments are eliminated by subtracting zero-adjustment values, which are obtained through zero adjustment, from measured values.

The instrument saves offset values in its internal memory as zero-adjustment values, which are then associated with the corresponding measurement environment*².

● Referential adjustment (battery internal resistance, p.65)

The referential adjustment capability can be used to remove offset values associated with the battery position on an inspection tray from measured values.

Each position on an inspection tray has a unique offset value, attributed to variations in measurement environments*². The instrument correlates these offset values with the respective positions (channels) on the inspection tray, subsequently saving them as referential-adjustment values*³ in its internal memory.

Offsets resulting from measurement environments can be eliminated by subtracting the referential-adjustment values corresponding to the channel from actual measured values.

The instrument has the capability to save referential-adjustment data for up to 528 channels.

● Contact check (p.77)

The contact check capability can determine whether the test lead is properly in contact with objects under measurement (batteries).

● Interface (p.152)

The instrument is equipped with LAN, RS-232C, USB, and external I/O interfaces.

● Comparator capability (p.100)

The comparator capability can judge measured values of resistance and DC voltage in three levels (Hi, In, and Lo), displaying judgment results.

*1. See “14.6 Effects of Electromagnetic Induction and Eddy Currents” (p.234).

*2. Measurement environment:

- Shape and arrangement of the test lead
- Presence/absence and arrangement of metal around objects under measurement (batteries)
- Presence/absence and arrangement of metal around objects under measurement (batteries)

*3. Referential-adjustment value: Difference between the reference value and an actual measured value

1.3 Part Names and Functions

Front (The figure illustrates the BT6075.)

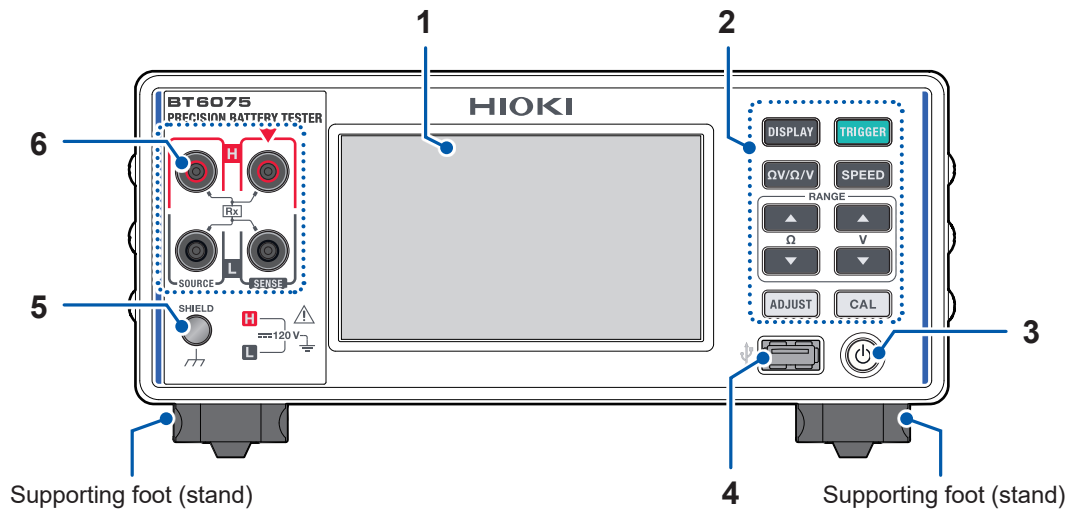

1	Display	Displays measured values. Tap to configure various settings.	p.23
2	Physical keys	DISPLAY	Press to switch between screens. p.29 Hold for 2 s to save a screenshot in a USB flash drive. p.173
		TRIGGER	Press to start/stop a measurement (with the external-trigger setting). p.29
		ΩV/Ω/V	Press to switch between measuring functions. p.46
		SPEED	Press to switch between sampling-speed settings. p.52
		▲ ▼ (RANGE Ω)	Press to cycle through the resistance range from the lowest to the highest or vice versa. p.47
		▲ ▼ (RANGE V)	Press to cycle through the DC-voltage range from the lowest to the highest or vice versa. p.50
		ADJUST	Perform a zero adjustment. p.56 Perform a referential adjustment. p.65
		CAL	Press to self-calibrate the resistance measurement capability. p.53 Press to self-calibrate the DC-voltage measurement capability.
3	Start button	Press to switch between hibernation states.	
		Unlit	The instrument has been turned off (without power supplied). p.35
		Lit (in red)	The instrument is in sleep mode. (with power supplied)
		Lit (in green)	The instrument has been turned on.
4	Type-A USB connector	Used to connect the Z4006 USB Drive. Screenshots can be output.	p.173
5	Shield terminal	Used to connect the shield of a self-made test-lead assembly. (For removing noise)	
		With the enclosure potential (Connected to the power-inlet grounded terminal)	p.225
		M4 screw	
6	Measurement terminals	Used to connect a test lead.	p.37

The instrument can be mounted on a rack. Keep the removed parts in a safe place for future use. See “14.12 Rack-Mounting the Instrument” (p.254) and “14.13 External Views” (p.256).

Rear

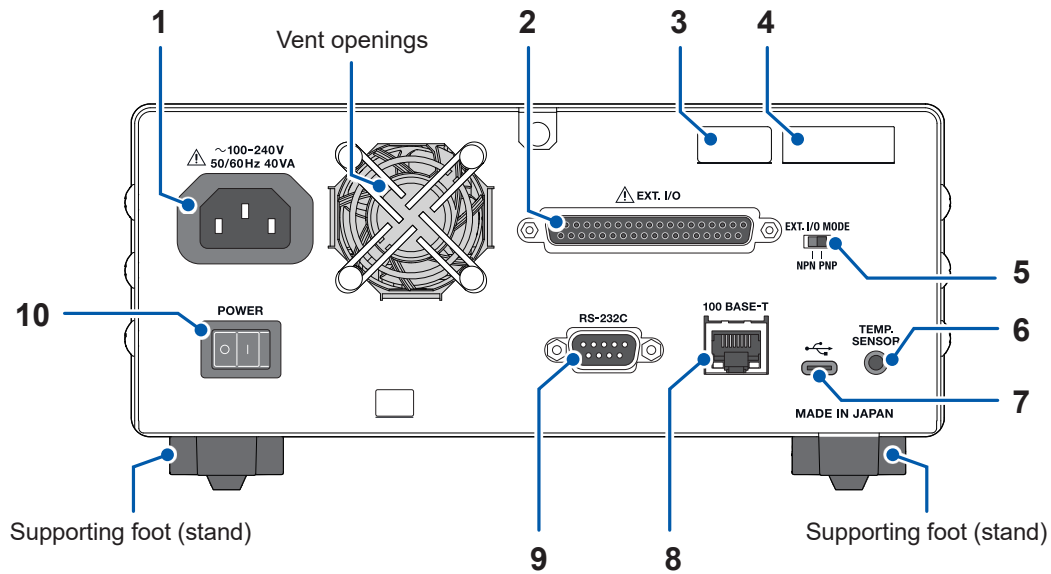

1	Power inlet	Used to connect the power cord.	p.33
2	Ext. I/O connector	Used to control the instrument externally.	p. 127
3	MAC address	MAC address assigned to the instrument Do not remove this sticker because the number is important.	-
4	Serial number	The serial number consists of nine digits. The first two digits indicate the year of manufacture, while the second two digits indicate the month of manufacture. Do not remove this sticker because the number is important.	p. 209
5	Ext. I/O Mode switch	Used to change modes based on the type of programmable logic controller (PLC).	p. 129
6	Temp. Sensor terminal	Used to connect the Z2005 Temperature Sensor.	p. 39
7	Type-C USB connector	Used to connect the L9510 USB Cable. The instrument can be controlled from a computer through USB communications using a virtual COM port. Measured data can be transferred to the computer.	p. 160
8	LAN connector	Used to connect the 9642 LAN Cable (recommended). The instrument can be controlled from a computer or a PLC through LAN communications (socket communications). Measured data can be transferred to a computer or a PLC.	p. 153
9	RS-232C connector	Used to connect the L9637 RS-232C Cable. The instrument can be controlled from a computer or a PLC through RS-232C communications (serial communications). Measured data can be transferred to a computer or a PLC.	p. 158
10	Power switch	Set in the on/off position to turn on/off the instrument.	p.34

Left side

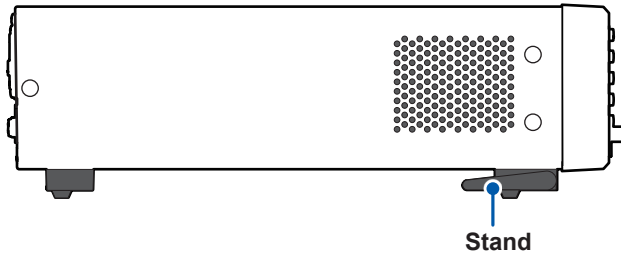

Bottom

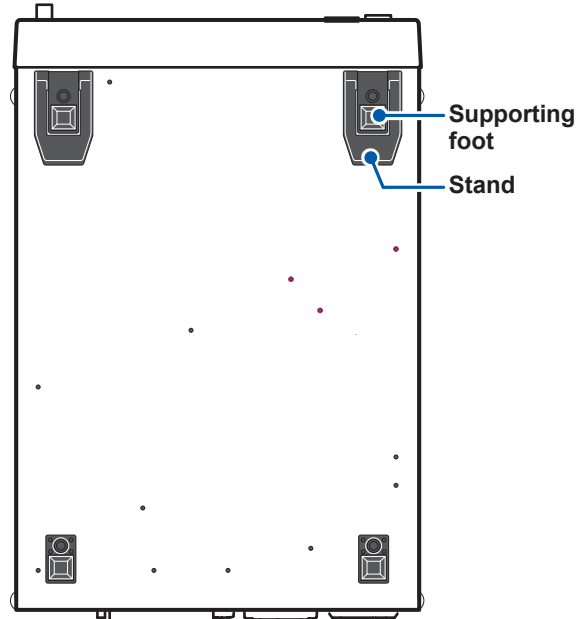

Left side

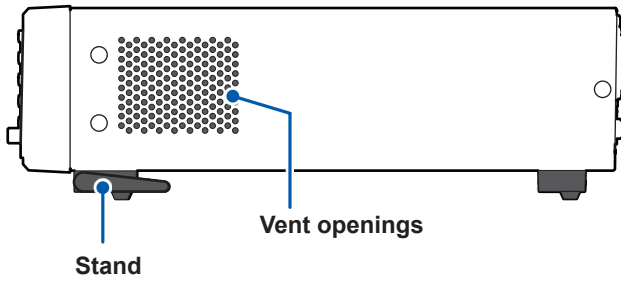

Stand

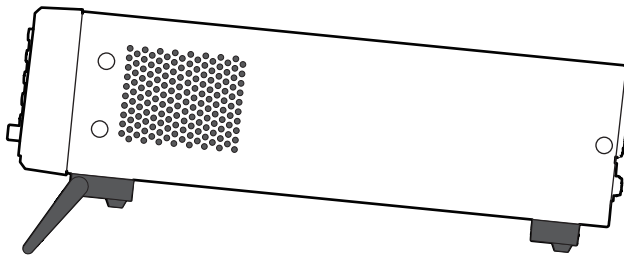

When extending

Extend to the full forward position, not partially away.
Extend both.

When retracting

Move to the fully retracted position, not partially away.

! CAUTION



■ Do not apply excessive downward force to the instrument when the stands are extended.

Doing so could damage the stands.

1.4 Screen Configuration

The screens of the instrument consist of the measurement screen and several settings screens.

Measurement screen

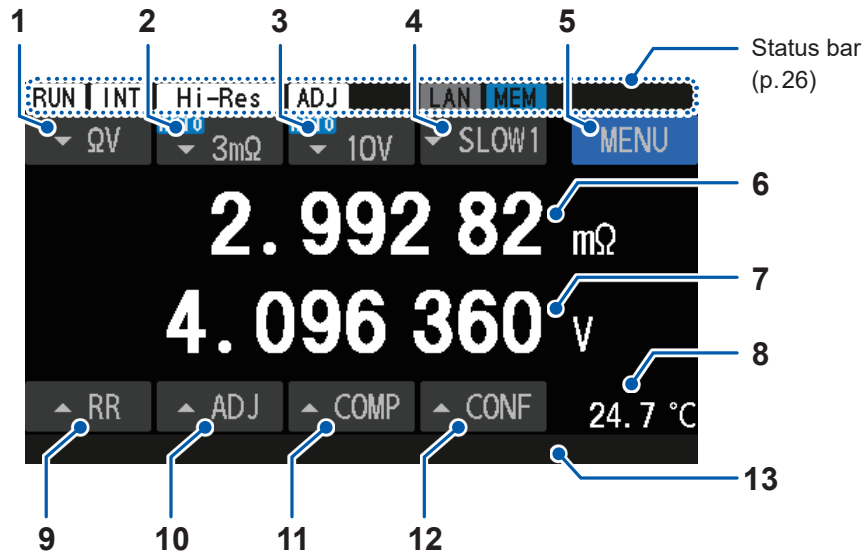

1	Measuring function	"3.1 Selecting a Measuring Function" (p.46)
2	Resistance range	"Configuring the resistance measurement settings" (p.47)
3	DC-voltage range	"Configuring the voltage measurement settings" (p.50)
4	Sampling speed	"3.3 Selecting a Sampling Speed" (p.52)
5	Menu	"Settings screen" (p.24)
6	Measured value of resistance measurement	A resistance measured value is displayed.
7	Measured values of voltage	A voltage measured value is displayed.
8	Temperature	"Checking the temperature" (p.39) "4.8 Switching Between Temperature Scales" (p.98)
9	Route-resistance monitor	"3.9 Route-Resistance Monitor" (p.79)
10	Adjustment setting	Tap to display the adjustment selection screen, where you can check adjustment settings. "3.5 Performing the Zero Adjustments" (p.56) "3.6 Performing the Referential Adjustments" (p.65)
11	Comparator settings	"5 Comparator Capability" (p.99)
12	Measurement settings	Tap to display the measurement settings list, where you can check principal measurement settings. "Measurement settings screen" (p.29)
13	Message bar	"13.4 On-Screen Errors" (p.218)
	Progress bar	The progress of relatively long measurements or processing is displayed.

Settings screen

[MENU] screen



MEAS	Measurement settings
I/F	Communications settings
External I/O	External-control settings
PANEL	Panel settings
STSTEM	System settings
INFO	Measurement information

[MENU] > [MEAS] screen

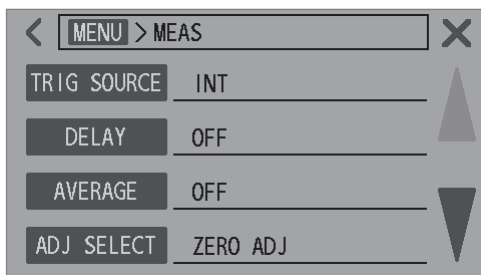

TRIG SOURCE	p.87
DELAY	p.90
AVERAGE	p.91
ADJ SELECT	p.60

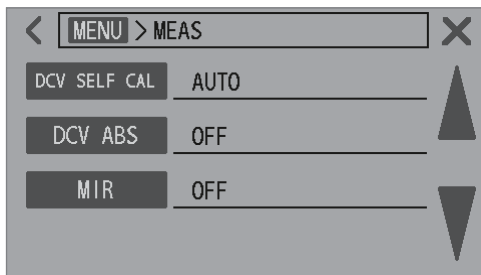

DCV SELF CAL	p.54
DCV ABS	p.96
MIR	p.93

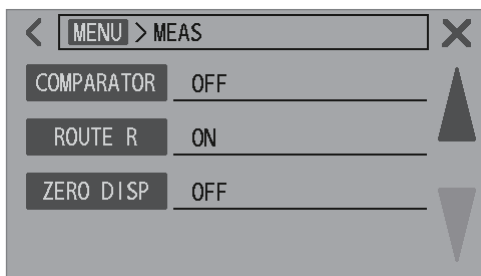

COMPARATOR	p.100
ROUTE R	p.103
ZERO DISP	p.95

[MENU] > [I/F] screen

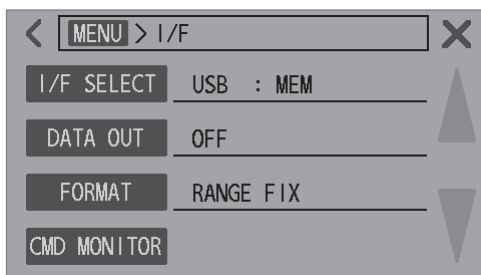

I/F SELECT	p.152
DATA OUT	p.169
FORMAT	p.165
CMD MONITOR	p.164

[MENU] > [EXT I/O] screen

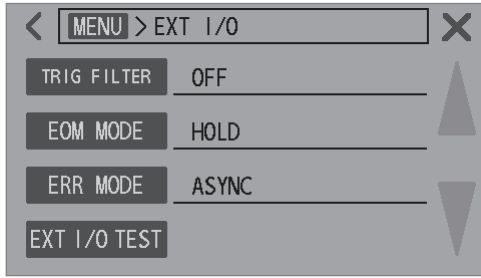

TRIGGER FILTER	p. 147
EOM MODE	p. 148
ERR MODE	p. 149
EXT I/O TEST	p. 150

[MENU] > [PANEL] screen

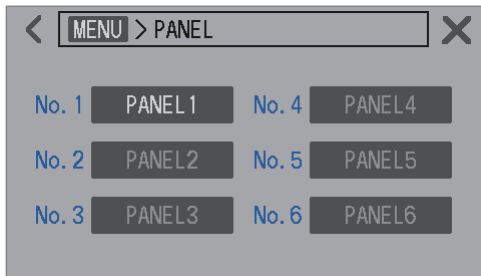

PANEL	p. 121
-------	--------

[MENU] > [SYSTEM] screen

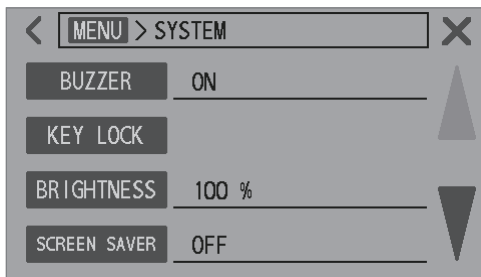

BUZZER	p. 109
KEY LOCK	p. 112
BRIGHTNESS	p. 110
SCREEN SAVER	p. 111

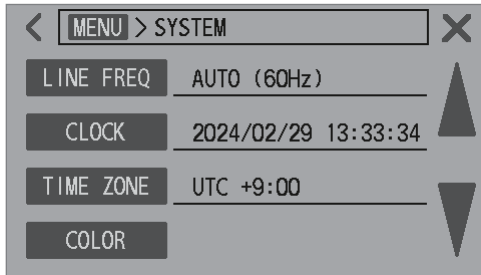

LINE FREQ	p. 43
CLOCK	p. 40
TIME ZONE	p. 41
COLOR	p. 114

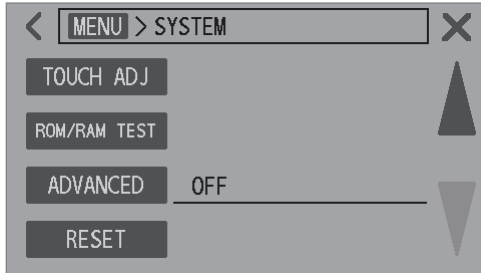

TOUCH ADJ	p. 113
ROM/RAM TEST	p. 115
ADVANCED	p. 116
RESET	p. 117

[MENU] > [INFO] screen

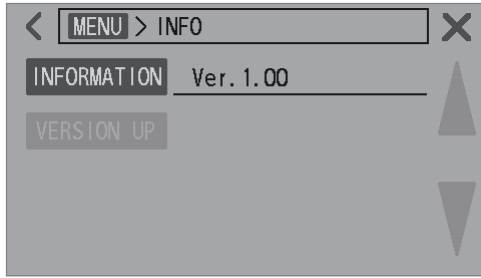

INFORMATION

p.209

Indicators on the measurement screen

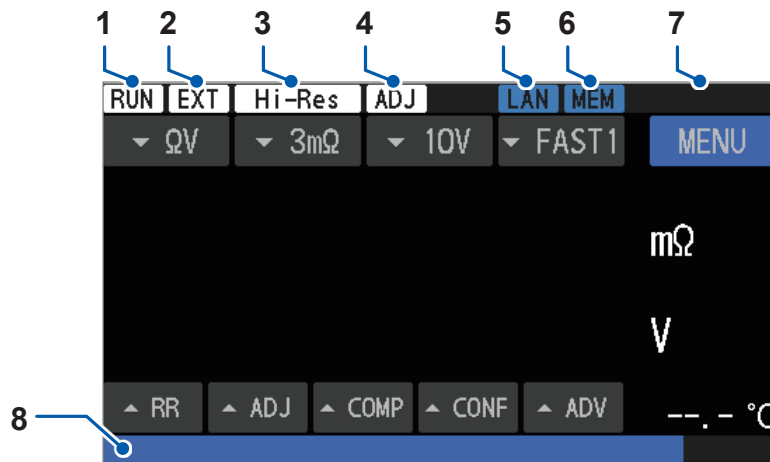

1	Measurement state	RUN	Measurement in progress	-
2	Trigger source	INT	Internal trigger	p.87
		EXT	External trigger	
3	High resolution mode	Hi-Res	Effective	p.48
		Hi-Res	Ineffective	
4	Adjustment	ADJ	Effective	p.63 p.74
		ADJ	Ineffective	
5	Communications interface	LAN	LAN communications (ineffective)	p.153 p.158 p.160
		LAN	LAN communications (linking)	
		LAN	LAN communications (effective)	
		RS	RS-232C communications	
		USB-COM	USB communications (connected)	
6	USB flash drive	MEM	Mounted	p.173
		MEM	Unmounted	
		MEM	Ineffective	
7	Key-locked state, communications state	KEYLOCK	Key lock activated	p.112 p.153
		KEYLOCK	Local state	
		REMOTE	Remote state	
8	Message bar	Message bar	Messages, such as errors are displayed.	p.218
	Progress bar	Progress bar	Progress percentage	-

1.5 Basic Operations

You can operate the instrument by pressing the physical keys, tapping the touchscreen, or sending commands.

For details about command operations, see Communications Command Instruction Manual.

Changing various settings (on the MENU screen)

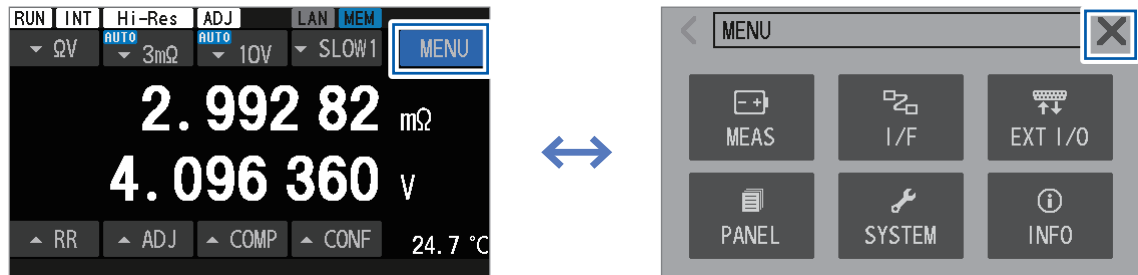

On the [MENU] screen, tap each setting item; on the subsequent screen that appears, change settings.

Switching between measuring functions.

See “3.1 Selecting a Measuring Function” (p.46).

By pressing a physical key

ΩV/Ω/V

Press the **ΩV/Ω/V** key to switch between measuring functions.

Switching order

[ΩV] → [Ω] → [V]



By tapping the touchscreen

Select a measuring function on the touchscreen.

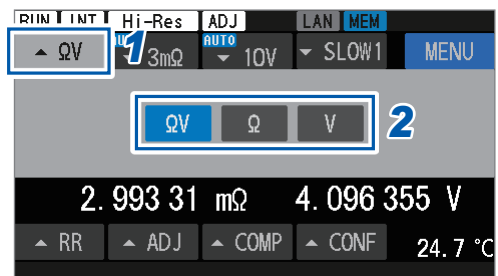

Switching between ranges

See “3.2 Configuring the Measurement Range Settings” (p.47).

By pressing a physical key



1 Switch between measuring functions.



2 Select a range.



By tapping the touchscreen

Select a range on the touchscreen.

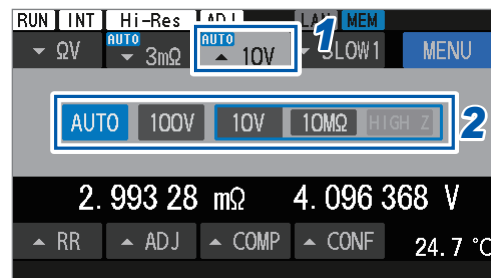
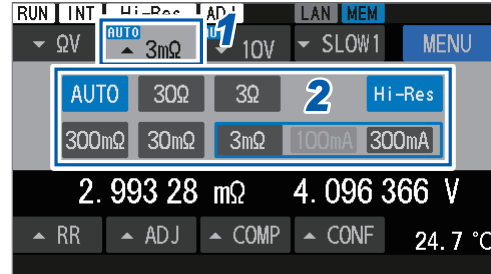

Changing the sampling speed

See “3.3 Selecting a Sampling Speed” (p.52).

By pressing a physical key



Press the **SPEED** key to switch between sampling speeds.

Switching order

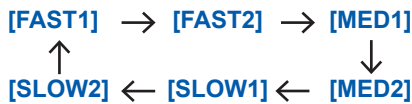

By tapping the touchscreen

Select a sampling speed on the touchscreen.

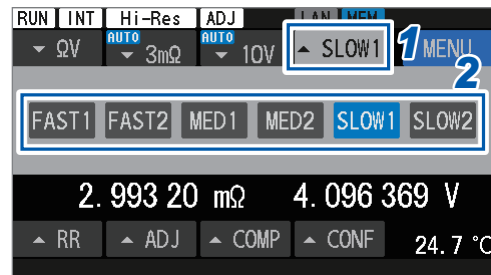

Starting/stopping a measurement

See “4.1 Starting Measurements With Triggers” (p.87).

Conducting measurements continuously

When the [TRIG SOURCE] is set to [INT], the instrument continuously makes measurements. See “4.1 Starting Measurements With Triggers” (p.87).

Making measurements according to preferred timing

When the [TRIG SOURCE] is set to [EXT], the instrument continuously makes measurements. See “4.1 Starting Measurements With Triggers” (p.87).

Follow one of these procedures to start a measurement:

By pressing the physical keys	By using external control (External I/O)
-------------------------------	--

TRIGGER

With the measurement stopped, press the **TRIGGER** key.

When the trigger source is set to [EXT], send the TRIG signal from an external device.

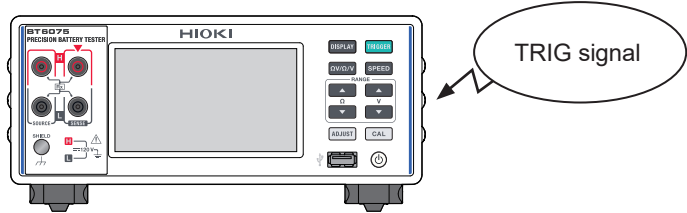

The measurement stops automatically after the predefined number of measurements for averaging (default setting: one measurement).

See “4.3 Averaging Measured Values” (p.91).

Sending a command can input a trigger.

To obtain detailed information, visit our website and download the Communications Commands Instruction Manual.

Switching between screens with the DISPLAY key

DISPLAY

Each time you press the **DISPLAY** key on the measurement screen, the screen changes in the following order:

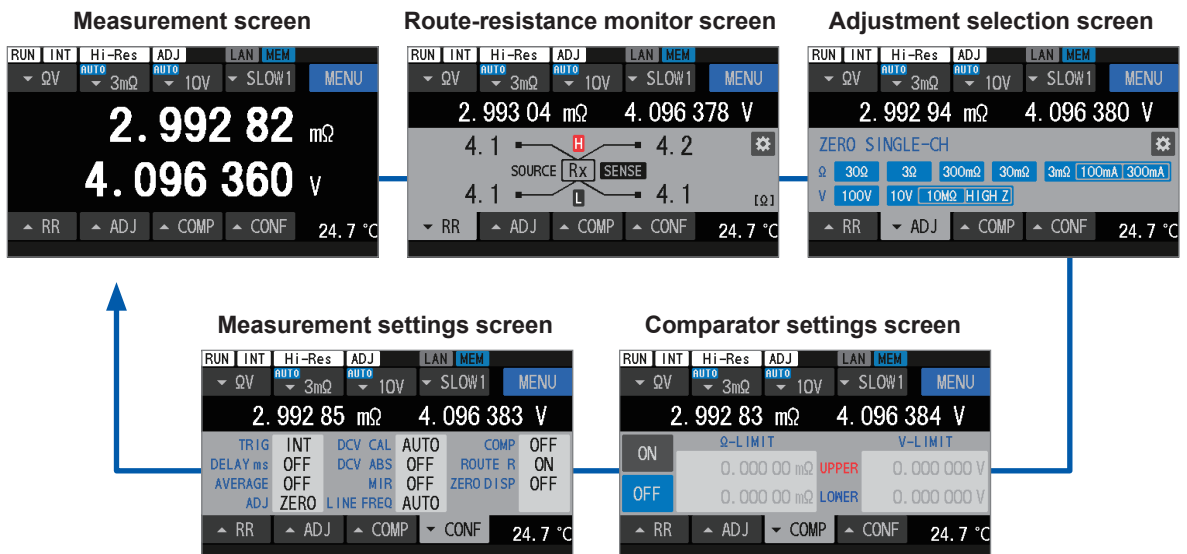

1.6 Measurement Procedure

Before using the instrument, see “Precautions for Use” (p. 13).

1 Check the instrument for abnormalities.

See “2.2 Performing Pre-measurement Inspection” (p.32).

2 Prepare to start tests.

See “2 Preparing for Measurement” (p.31).

3 Define the measurement conditions.

Item	Description	Reference page
Measuring function	Select a measuring function (ΩV , Ω , or V).	p.46
Resistance range	Select a manual range (3 m Ω , 30 m Ω , 300 m Ω , 3 Ω , or 30 Ω) or the auto-ranging. For the 3 m Ω range, select a measurement current of 300 mA or 100 mA.	p.47
DC-voltage range	Select a manual range (10 V or 100 V) or the auto-ranging.	p.50
Sampling speed	Select any sampling-speed setting between Fast1 and Slow2.	p.52
Advanced settings	Configure advanced settings, such as the trigger, trigger delay, and averaging settings.	p.87
Comparator (upper and lower limits)	Define the upper and lower limits for judgment.	p.100
Comparator (buzzer sound)	Define conditions for notifying judgment results with buzzer sounds.	p.102

4 Start a measurement.

5 Stop the measurement.

6 Turn the instrument off.

2.1 Preparation Procedure

This chapter describes the preparation before starting measurements.

1 Check the instrument for any damage that may have occurred during storage or shipping.

- ▼ “2.2 Performing Pre-measurement Inspection” (p. 32)

2 Connect the power cord.

- ▼ “2.3 Connecting the Power Cord” (p. 33)

3 Set the rear-mounted Power switch to the on position.

- ▼ “2.4 Setting the Main Power Switch to the On/Off Position” (p. 34)

4 Connect a test lead to the measurement terminals of the instrument.

- ▼ “2.6 Connecting Test Lead” (p. 37)

5 Connect the Temperature Sensor to the rear-mounted Temp. Sensor terminal.

- ▼ “2.7 Connecting the Temperature Sensor” (p. 39)

6 Connect external devices to the instrument.

- ▼ “8 Externally Controlling the Instrument (External I/O)” (p. 127)
- ▼ “9.2 Working with the LAN Interface” (p. 153)
- ▼ “9.3 Working with the RS-232C Interface” (p. 158)
- ▼ “9.4 Working with the USB Port (COM mode)” (p. 160)

7 Use the start button to turn the instrument on.

- ▼ “2.5 Switching Between Standby and Sleep Modes” (p. 35)

8 Adjust the time and date on the menu screen.

- ▼ “2.8 Adjusting the Date and Time” (p. 40)

9 Select a line frequency on the menu screen.

- ▼ “2.10 Configuring the Line-Frequency Setting” (p. 43)

2.2 Performing Pre-measurement Inspection

⚠ DANGER

- Check the test lead for damaged insulation or exposed metal before use.



- Inspect the instrument and check it for proper operation before use.

Using a damaged test lead or the instrument will cause serious bodily injury. If you find any damage on a product, replace it with a Hioki-specified one.

Inspecting peripheral equipment

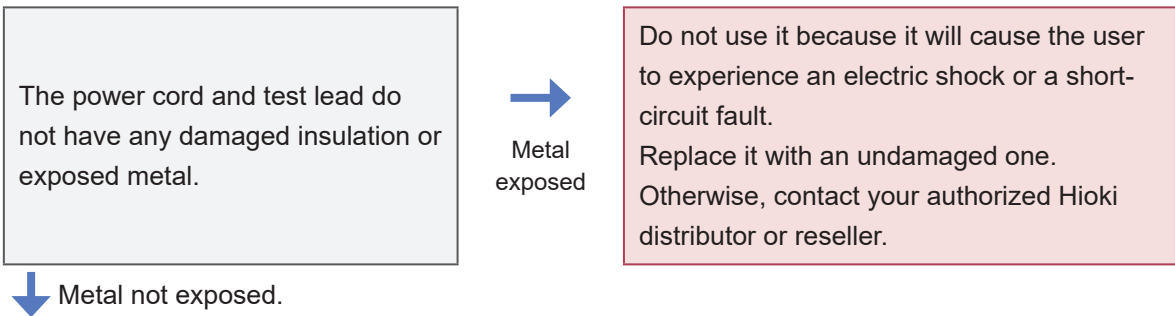

Inspecting the instrument

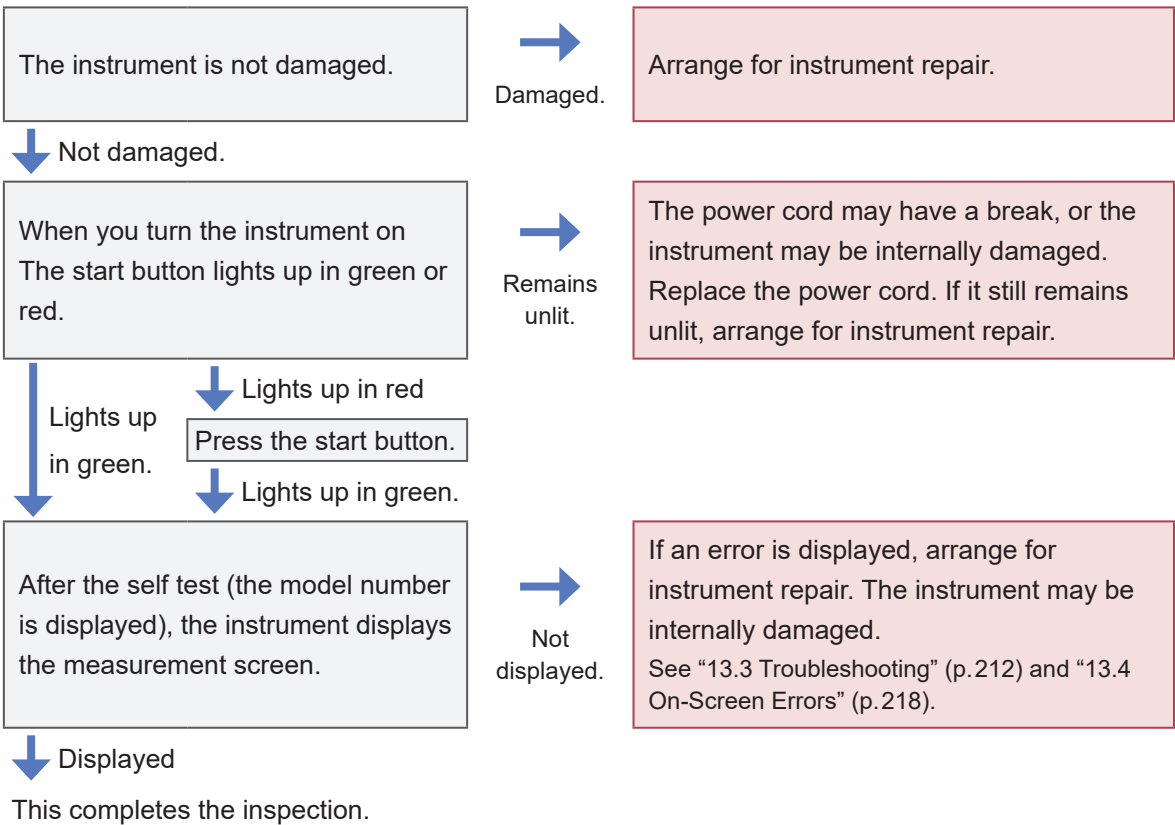

2.3 Connecting the Power Cord

The next step is to plug the accompanying power cord into the power inlet. It is recommended to use an uninterruptible power supply (UPS) with a sine wave output to prevent malfunction of the instrument due to a power failure.

⚠ WARNING



- **Connect the power cord to a grounded, two-prong power outlet.**

Connecting the power cord to an ungrounded power outlet could cause the user to experience an electric shock.

⚠ CAUTION



- **Do not use a power supply that generates rectangular wave or pseudo-sine wave output, such as an uninterruptible power supply and a DC/AC inverter, to power the instrument.**

Doing so could damage the instrument, resulting in bodily injury.

When using an uninterruptible power supply (UPS) for instantaneous power failure countermeasures, use that with sine-wave output.



- **Before plugging the power cord into an outlet, ensure that the supply voltage to be used falls within the supply voltage range indicated close to the power inlet of the instrument.**

Supplying a voltage outside the specified range to the instrument could damage it, causing bodily injury.

- 1 Check that the rear-mounted Power switch of the instrument is set to the off position.
- 2 Check that the power-supply voltage to be used is within the rated power-supply voltage range.
- 3 Connect the power cord to the power inlet of the instrument.
- 4 Connect the plug of the power cord to the outlet.

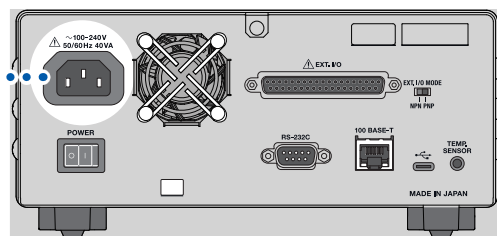
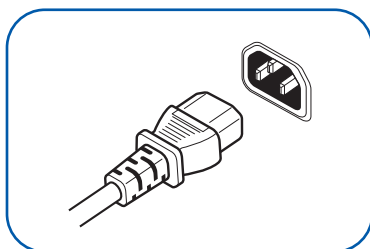

If power is interrupted, such as by a circuit breaker tripping, while the Power switch is set to the on position, the instrument will automatically turn on once power is restored.

2.4 Setting the Main Power Switch to the On/Off Position

The next step is to set the rear-mounted Power switch to the on position. Once this switch is set to the on position, the instrument can be turned on and off using the front-mounted start button. The convenience of using the front-mounted start button remains even after the instrument is embedded in an automated system or a production line.

When setting the rear-mounted Power switch to the off position while the instrument is in sleep mode, you can turn it on in sleep mode by setting the Power switch to the on position again.

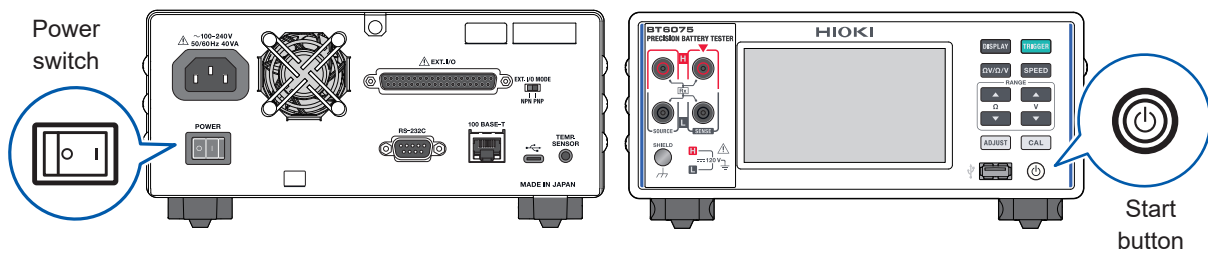

Setting the Power switch to the on position

Set the rear-mounted Power switch to the on position (I).

The instrument starts up in the same state as the last time the Power switch was set to the off position.



The front-mounted start button lights up in either red or green.



or



In sleep mode

In standby mode

See “2.5 Switching Between Standby and Sleep Modes” (p.35).

Setting the Power switch to the off position

Set the rear-mounted Power switch to the off position (O).



The front-mounted start button becomes unlit.



2.5 Switching Between Standby and Sleep Modes

When the rear-mounted Power switch is set to the on position, you can use the front-mounted start button to switch between two modes of the instrument: standby and sleep mode.

IMPORTANT

The instrument requires selecting the line-frequency setting to reject noise caused by the power frequency. Before making measurements, select the line-frequency setting appropriate for the power to be used. The correct line-frequency setting can stabilize measured values. See "2.10 Configuring the Line-Frequency Setting" (p.43).

2

Preparing for Measurement

Standby mode

When the instrument is in sleep mode, press the front-mounted start button.



The front-mounted start button lights up in green, and the instrument enters standby mode.

Red light is on.



After the rear-mounted Power switch is set to the on position or the instrument exits sleep mode, the self-test (self-diagnostics of the instrument) will start automatically.

Sleep mode

When the rear-mounted Power switch is set to the on position, hold the front-mounted start button for about 2 s.



The front-mounted start button lights up in red, and the instrument enters sleep mode.



Hold for about 2s



Tips

What is sleep mode?

In sleep mode, the instrument is turned off. The front-mounted start button lights up in red.

Performing a self-test

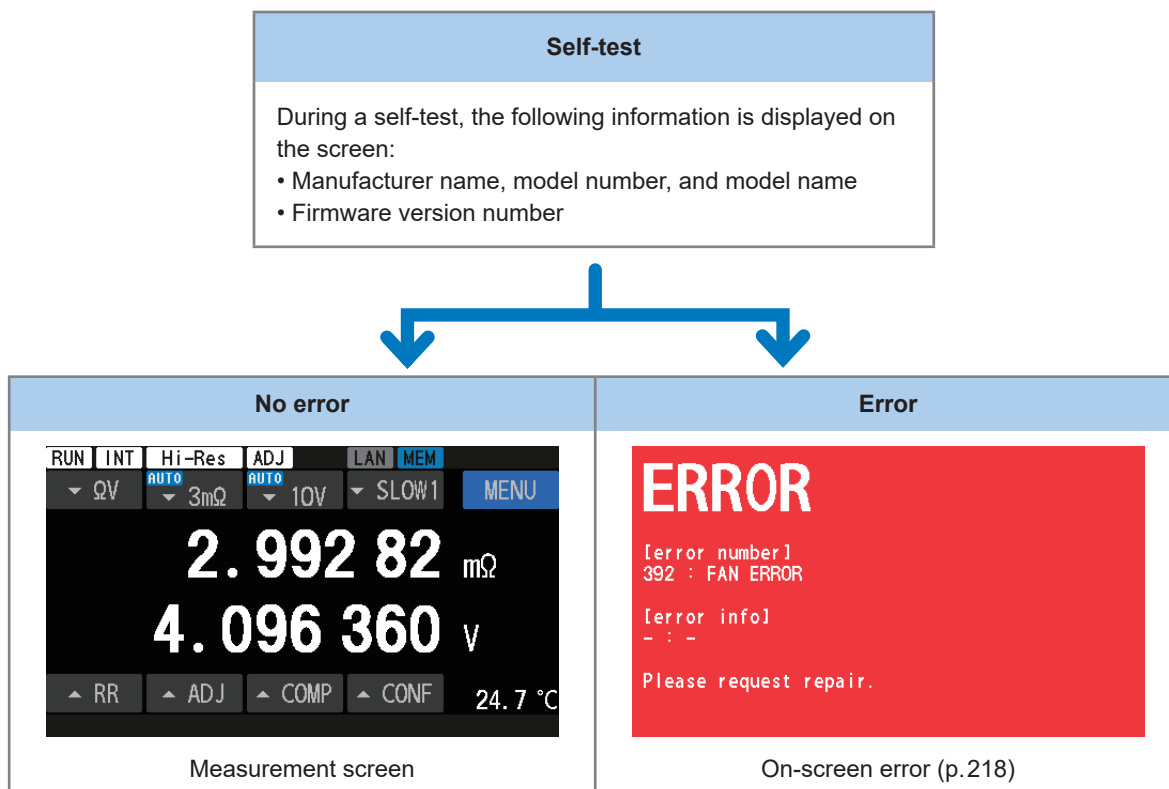

The line frequency is automatically set to the supplied power frequency.

You can also change this setting manually.

See “2.10 Configuring the Line-Frequency Setting” (p.43).

IMPORTANT

- After turning on the instrument, allow it to warm up for at least 60 minutes. Subsequently, perform a resistance self-calibration and a DC-voltage self-calibration processes before starting measurements.
See “Performing a resistance self-calibration process” (p.53) and “Performing a DC-voltage self-calibration process (automatic/manual)” (p.54).
- After setting the rear-mounted Power switch to the off position, the instrument retains the settings through an auto-setting-backup feature.

2.6 Connecting Test Lead

Connecting a test lead

This section describes how to connect a test lead to the instrument.

IMPORTANT

No test lead is supplied with this instrument. Purchase an optional test lead according to the conditions you use, or make a test-lead assembly by yourself.

This instrument is equipped with four separate socket terminals for resistance measurement. See “Optional Equipment” (p.9) and “14.1 When Creating a Test-Lead Assembly by Yourself” (p.225).

- 1** Check that nothing is connected to the ends of the test lead.
- 2** Remove the protective caps from the connectors of the test lead.

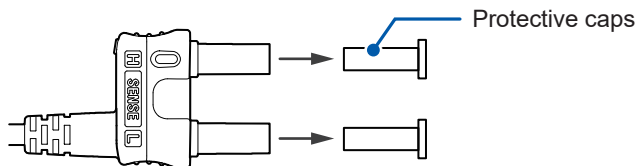

- 3** Connect connectors of the test lead to the measurement terminals of the instrument.

Align the red ▼ mark on the connectors of the test lead with the ▲ mark on the measurement terminals of the instrument to connect.

For the L2120 Pin Type Lead
For the L2121 Clip Type Lead

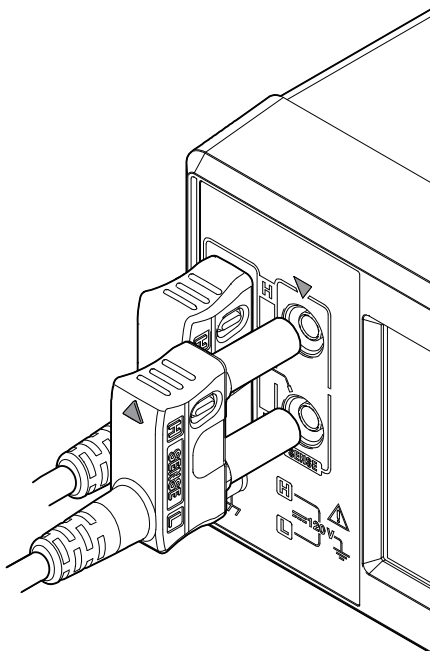

For the L2100 Pin Type Lead

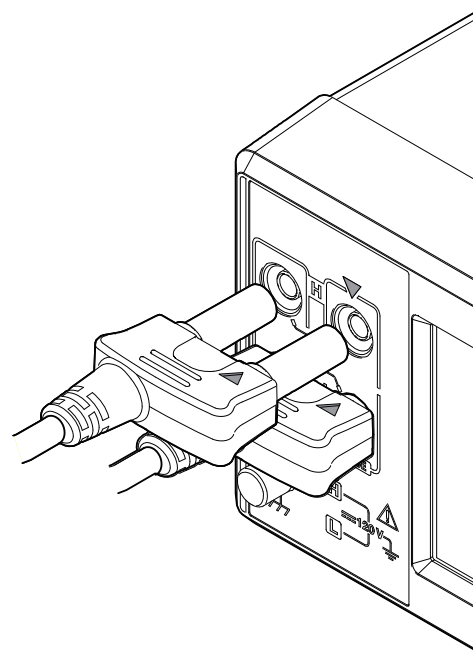

Tips of a test lead

Example: L2121

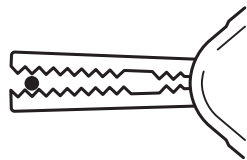
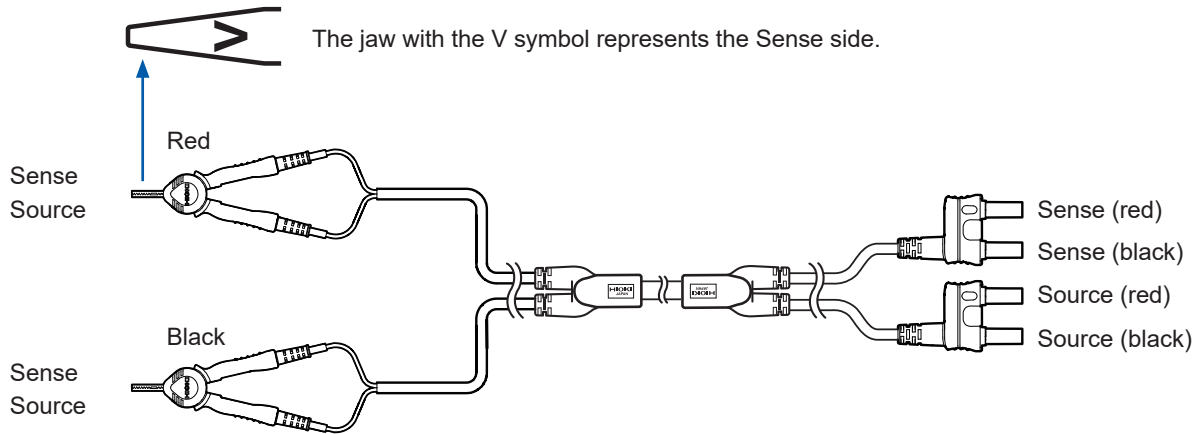

When pinching a thin wire

Use the tips of the clip.

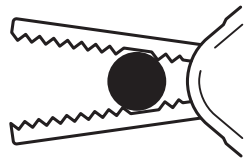

When pinching a thick wire

Use the no teeth areas near the pivot.

2.7 Connecting the Temperature Sensor

If you want to measure temperature, connect the Z2005 Temperature Sensor to the rear-mounted Temp. Sensor terminal of the instrument.

You will need:

Z2005 Temperature Sensor (optional equipment)

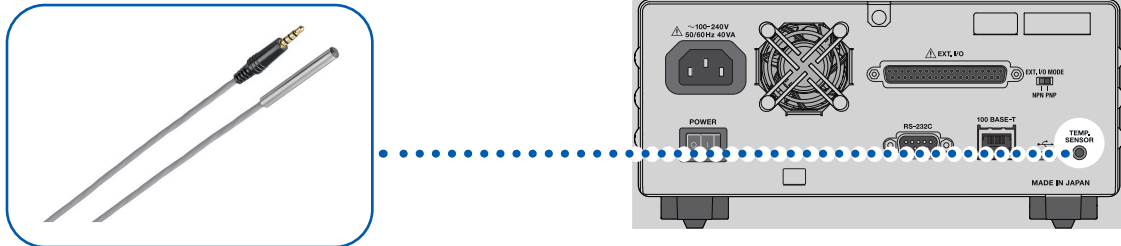

- 1** Check that the rear-mounted Power switch of the instrument is set to the off position.
- 2** Connect the Temperature Sensor to the Temp. Sensor terminal of the instrument.
- 3** Set the rear-mounted Power switch to the on position.
- 4** Position the end of the Temperature Sensor close to the object under measurement (battery).

Checking the temperature

After turning on the instrument, check whether the temperature measured value is correct. The instrument updates the temperature reading every about 2.2 s.

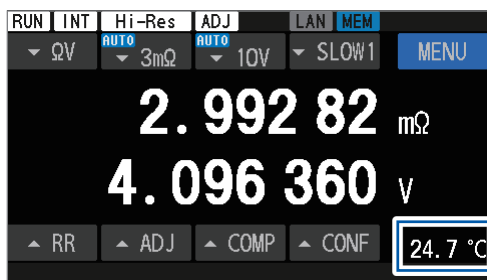

Switching between temperature scales

See “4.8 Switching Between Temperature Scales” (p.98).

2.8 Adjusting the Date and Time

Before making measurements, adjust the date and time.

For more information about the time-zone setting, see “2.9 Selecting a Time Zone” (p.41).

[MENU] > [SYSTEM]

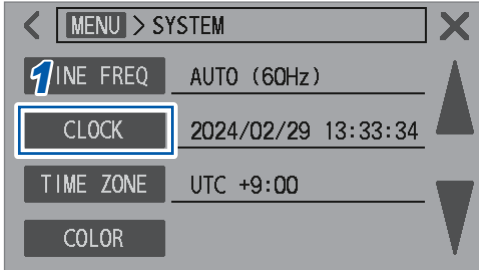

1 Tap [CLOCK].

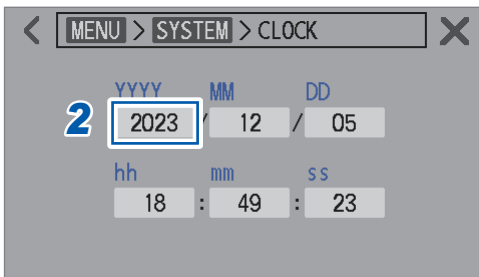

2 Tap a box you want to configure.

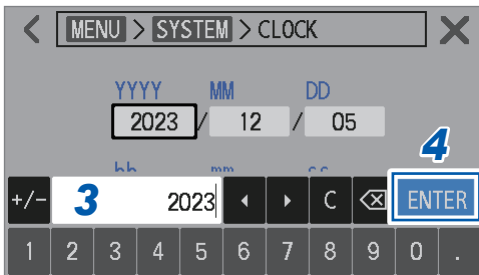

3 Use the numerical keypad to enter the date and time.

4 Tap [ENTER] to confirm.

The built-in lithium battery for backup has a life of about 10 years.

When the battery reaches the end of its life, the date-time setting of the instrument will be reset.

2.9 Selecting a Time Zone

You can select a time zone according to the region where this instrument is used.
For more information about the time zone, see “2.8 Adjusting the Date and Time” (p.40).

[MENU] > [SYSTEM]

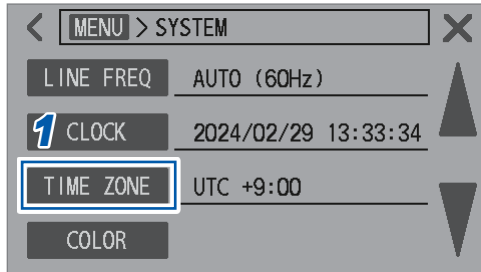

1 Tap [TIME_ZONE].

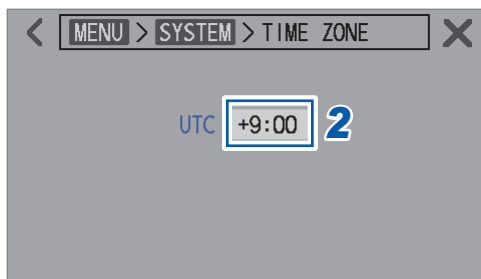

2 Tap the [UTC] box.

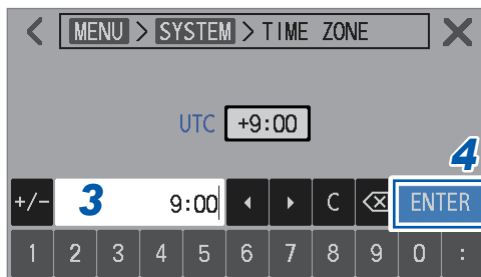

3 Use the numerical keypad to enter the offset from Coordinated Universal Time for your desired time zone.

4 Tap [ENTER] to confirm.

2

Preparing for Measurement



Time zone

Set the instrument to the time zone (offset from UTC) of the area where it is used.
 UTC stands for *Coordinated Universal Time*.

Example locations	Offset from UTC	Example locations	Offset from UTC
Kiritimati Island	UTC+14:00	Tehran	UTC+03:30
Samoa, Nukualofa	UTC+13:00	Moscow, Minsk, Baghdad, Kuwait, Istanbul	UTC+03:00
Chatham Islands	UTC+12:45	Helsinki, Kyiv, Cairo, Athens	UTC+02:00
Fiji, Auckland, Anadyr	UTC+12:00	Paris, Rome, Madrid, Belgrade, Berlin	UTC+01:00
Sakhalin, New Caledonia	UTC+11:00	UTC, London, Sao Tome	UTC+00:00
Lord Howe Island	UTC+10:30	Azores Islands, Cape Verde Islands	UTC-01:00
Guam, Sydney, Vladivostok	UTC+10:00	UTC - 2	UTC-02:00
Darwin, Adelaide	UTC+09:30	Buenos Aires, Brasilia, Greenland	UTC-03:00
Tokyo, Osaka, Sapporo, Seoul, Chita, Yakutsk, Pyongyang	UTC+09:00	Newfoundland	UTC-03:30
Yukon	UTC+08:45	AST in Canada	UTC-04:00
Beijing, Hong Kong, Taipei, Singapore, Irkutsk	UTC+08:00	EST in USA and Canada, Lima, Haiti	UTC-05:00
Bangkok, Jakarta	UTC+07:00	CST in USA and Canada, Mexico City, Easter Island	UTC-06:00
Yangon	UTC+06:30	MST in USA and Canada, Arizona, Chihuahua	UTC-07:00
Dhaka, Omsk, Astana	UTC+06:00	Baja California	UTC-08:00
Kathmandu	UTC+05:45	Alaska	UTC-09:00
New Delhi, Sri Jayawardenepura Kotte	UTC+05:30	Marquesas Islands	UTC-09:30
Islamabad, Tashkent	UTC+05:00	Hawaii, Aleutian Islands	UTC-10:00
Kabul	UTC+04:30	UTC - 11	UTC-11:00
Abu Dhabi, Baku, Port Louis	UTC+04:00	Baker Island, Howland Island, International Date Line West	UTC-12:00

As of December 2023

2.10 Configuring the Line-Frequency Setting

To ensure stable measurements, it is necessary to select the appropriate line-frequency setting to eliminate line frequency noise.

Although the line frequency is automatically detected under the default setting (Auto), you can also select the line-frequency setting manually. Measured values could vary with the incorrect line-frequency setting.

In the following cases, always select a line-frequency setting.

- When using the instrument for the first time
- After resetting the instrument
- After repair or calibration of the instrument

[MENU] > [SYSTEM]

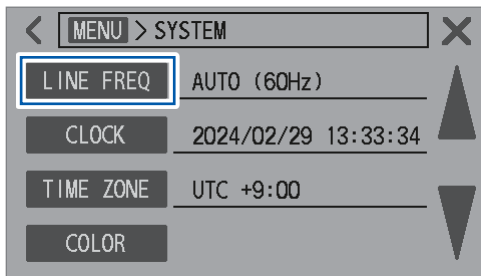

1 Tap [LINE FREQ].

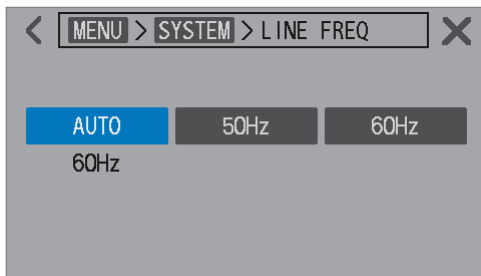

2 Select a line-frequency setting.

AUTO <input checked="" type="checkbox"/>	Sets to 50 Hz/60 Hz automatically. The power-supply frequency is detected when the instrument is turned on and when the instrument is reset.
50Hz	Sets the line frequency to 50 Hz.
60Hz	Sets the line frequency to 60 Hz.

IMPORTANT

Select the correct line frequency to stabilize measured values.

When [AUTO] is selected

- The setting is not changed even if the frequency of the supplied power fluctuates except when the instrument is turned on and when the setting is reset.
- If the frequency varies from 50 Hz or 60 Hz, the closest frequency is automatically set.

Example:

For a line frequency of 50.8 Hz → The line-frequency setting is configured to 50 Hz.

For a line frequency of 59.3 Hz → The line-frequency setting is configured to 60 Hz.

- In the event of a detection error, the setting is forcibly set to 50 Hz.

This chapter describes the basic settings for using the instrument.
Before starting measurements, inspect the instrument.

DANGER



- **Inspect the instrument to verify proper operation before use.**

Use of the instrument while it is malfunctioning will result in serious bodily injury.
If you find any damage, contact your authorized Hioki distributor or reseller.

WARNING



- **Do not use the instrument and a test lead for measurements on circuits that exceed the ratings or specifications of the instrument.**

Doing so could cause damage to the instrument or overheating, resulting in serious bodily injury.

- **After making a measurement on a high-voltage battery, do not touch the metal tips of the test lead.**

Doing so could cause the user to experience an electric shock because electric charge remains inside the instrument. (internal discharge time: about 2 s)

1 Selecting a measuring function.

- ▼ “3.1 Selecting a Measuring Function” (p.46)

2 Set the measurement range.

- ▼ “3.2 Configuring the Measurement Range Settings” (p.47)

3 Select a sampling-speed setting.

- ▼ “3.3 Selecting a Sampling Speed” (p.52)

4 Perform calibration processes.

- ▼ “3.4 Performing the Self-Calibration Processes” (p.53)

5 Perform a zero adjustment.

- ▼ “3.5 Performing the Zero Adjustments” (p.56)

6 Perform a referential adjustment.

- ▼ “3.6 Performing the Referential Adjustments” (p.65)

7 Connect a test lead to an object under measurement (battery).

- ▼ “3.7 Connecting a Test Lead to Objects Under Measurement (Batteries)” (p.75)

8 Check the measurement result.

- ▼ “3.8 Displaying Measurement Results” (p.76)
- ▼ “3.9 Route-Resistance Monitor” (p.79)

3.1 Selecting a Measuring Function

You can use the $\Omega V/\Omega/V$ key and the touchscreen to set the measuring function. The route-resistance monitoring capability becomes inactive when the voltage measuring function is selected.

By pressing a physical key

- 1 Press the $\Omega V/\Omega/V$ key

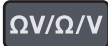

Every time you press the key, a measuring function is switched to another.

ΩV Resistance/voltage measurement

Ω Resistance measurement

V Voltage measurement

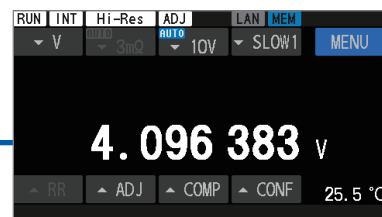
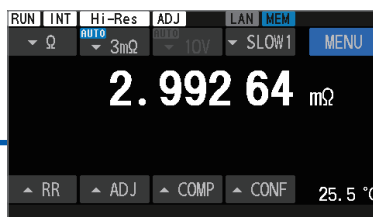
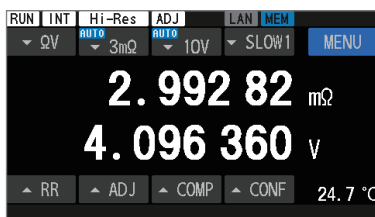

By tapping the touchscreen

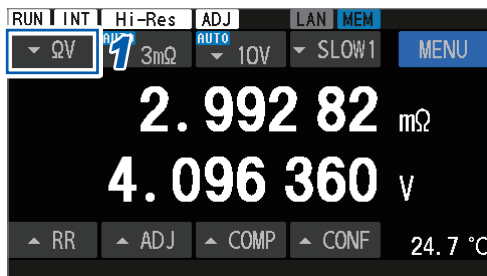

- 1 Tap the measuring function button.

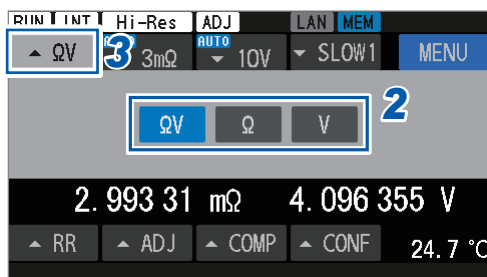

- 2 Select a measuring function.

ΩV	Resistance/voltage measuring function
Ω	Resistance measuring function
V	Voltage-measuring function

- 3 Tap the measuring function button.

The screen returns to the measurement screen.

Temperature measurement

Temperature is always measured regardless of the selected measuring function. (with the Z2005 Temperature Sensor connected)

When the Temperature Sensor is not connected, the contact-check capability provides a break judgment, displaying $[--.°C]$ in the lower right corner of the screen.

See "2.7 Connecting the Temperature Sensor" (p.39).

3.2 Configuring the Measurement Range Settings

This section describes how to configure the measurement range settings for the resistance measurement and voltage measurement.

There is no range setting required for temperature and route-resistance measurements; their ranges are fixed.

Configuring the resistance measurement settings

For the resistance/voltage measuring function (**[ΩV]**), selecting **[AUTO]** sets both the resistance and voltage to auto-ranging.

By pressing physical keys

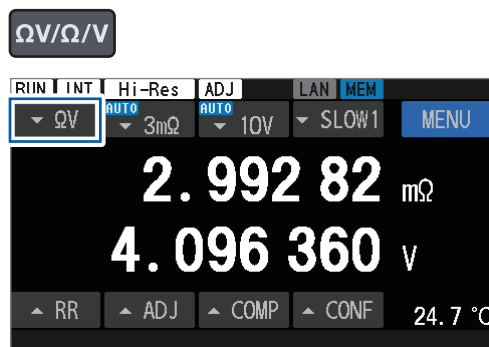

- 1 Press the **ΩV/Ω/V** key to select the resistance/voltage measuring function (**[ΩV]**) or resistance measuring function (**[Ω]**).

- 2 Press the **▲** and **▼** keys to select a range.

AUTO, **30Ω**, **3Ω**, **300mΩ**, **30mΩ**, **3mΩ**

The measurement current of the 3 mΩ range (100 mA or 300 mA) cannot be set with the physical keys. Use the touchscreen to set. (p.49)

By tapping the touchscreen

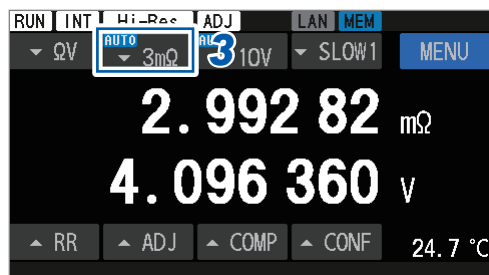
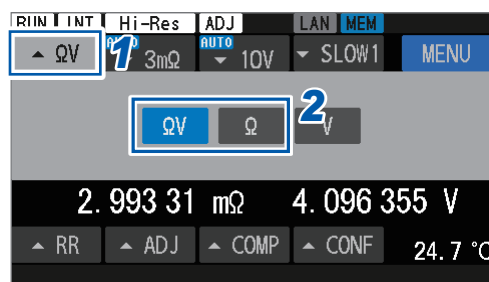

- 1 Tap the measuring function button.
- 2 Select the resistance/voltage measuring function (**[ΩV]**) or the resistance measuring function (**[Ω]**).

- 3 Tap the resistance range button.

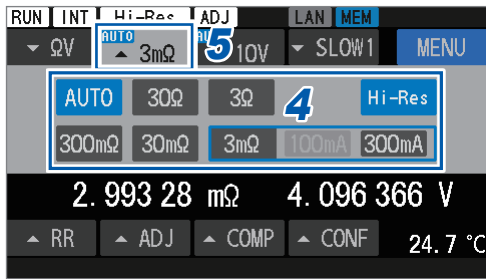

4 Select a range.

AUTO, 30Ω, 3Ω, 300mΩ, 30mΩ, 3mΩ

For the 3 mΩ range, select a measurement current from 100 mA and 300 mA.

5 Tap the resistance range button.

The screen returns to the measurement screen.

Turning high resolution mode on

The resistance measurement resolution is possible to switch to high resolution mode.

When the high resolution mode is enabled, the number of effective digits is one digit larger, allowing higher resolution measurements.

By tapping the touchscreen

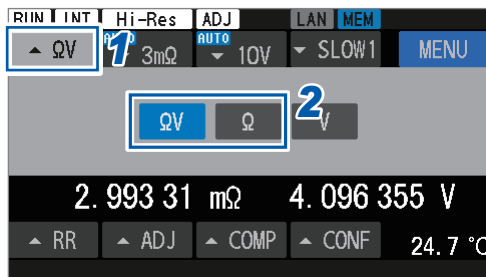

1 Tap the measuring function button.

2 Select the resistance/voltage measuring function ([ΩV]) or the resistance measuring function ([Ω]).

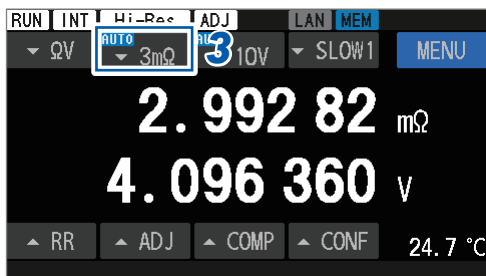

3 Tap the resistance range button.

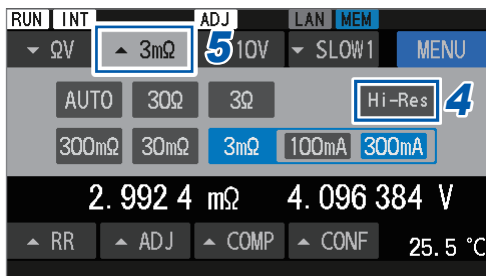

4 Tap [Hi-Res] to enter high resolution mode.

5 Tap the resistance range button.

The screen returns to the measurement screen.

Selecting a measurement current of the 3 mΩ range

You can switch between two measurement current options for resistance measurement. (between 100 mA and 300 mA)

Default setting: 300 mA

Switching the measurement current to 300 mA enables more accurate measurements.

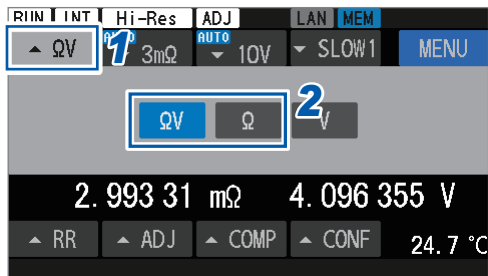

- 1** Tap the measuring function button.
- 2** Select the resistance/voltage measuring function (**[ΩV]**) or the resistance measuring function (**[Ω]**).

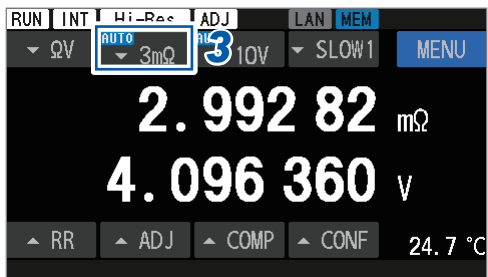

- 3** Tap the resistance range button.

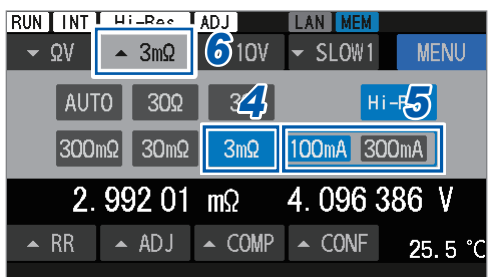

- 4** Select the 3 mΩ range.
- 5** Select a measurement current.

100mA, 300mA

- 6** Tap the resistance range button.

The screen returns to the measurement screen.

Configuring the voltage measurement settings

For the resistance/voltage measuring function ([ΩV]), selecting [AUTO] sets both the resistance and voltage to auto-ranging.

By pressing physical keys

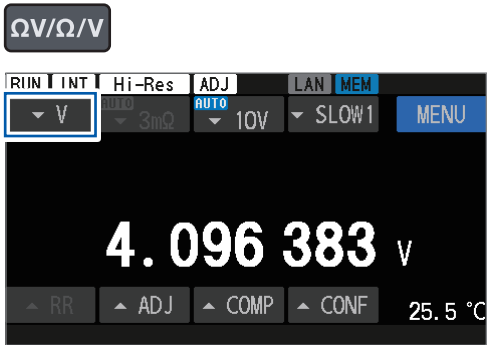

- 1 Press the **ΩV/Ω/V** key to select the resistance/voltage measuring function ([ΩV]) or voltage measuring function ([V]).

- 2 Press the **▲** and **▼** keys to select a range.

AUTO[□], 100V, 10V

The DC input resistance of the 10 V range (10 MΩ or HIGH Z) cannot be set with the physical keys. Use the touchscreen to set.

By tapping the touchscreen

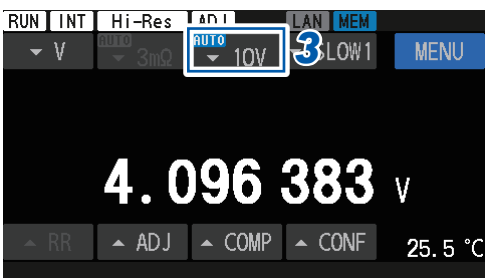
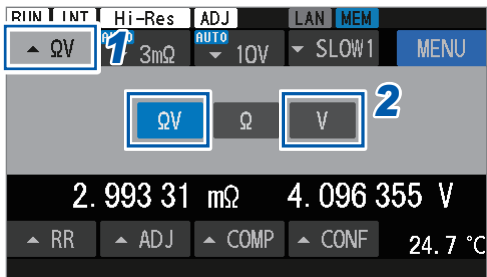

- 1 Tap the measuring function button.
- 2 Select the resistance/voltage measuring function ([ΩV]) or voltage measuring function.

- 3 Tap the DC-voltage range button.

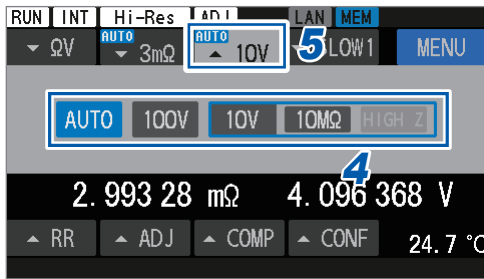

4 Select a range.

AUTO, 100V, 10V

For the 10 V range, select a DC input resistance from 10 MΩ mA and HIGH Z.

5 Tap the DC-voltage range button.

The screen returns to the measurement screen.

Thresholds for the auto-ranging

See “Auto-ranging” (p. 188).



When the range cannot be fixed in the auto-ranging

Depending on the object under measurement (battery), the range may not be fixed if the auto-ranging is set. In this case, set the range manually.

See “12 Specifications” (p. 177) for the accuracy, maximum readings, resolution, and resistance measurement currents.

3.3 Selecting a Sampling Speed

The instrument simultaneously samples resistance, voltage, and route resistance values.

The sampling-speed setting has six levels. Decreasing the sampling speed improves measurement accuracy.

The sampling speed for the temperature measurement cannot be set (fixed at 2 s).

By pressing a physical key

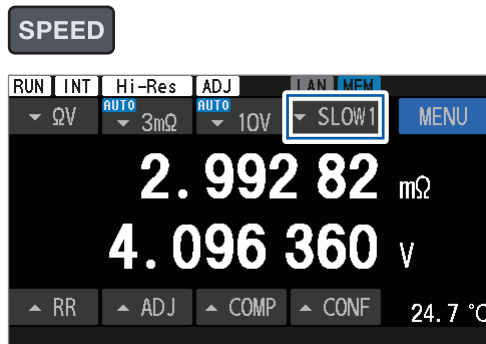

1 Press the **SPEED** key.

Every time you press the key, a speed level is switched to another according to the following order:

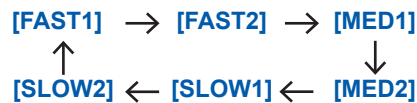

By tapping the touchscreen

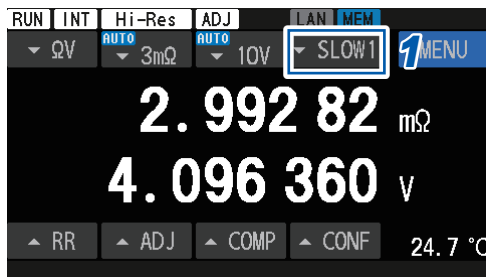

1 Tap the sampling speed button.

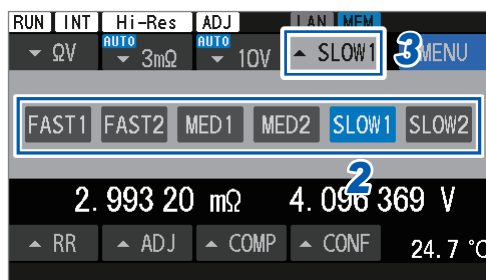

2 Select a sampling speed.

FAST1, FAST2, MED1, MED2, SLOW1,
SLOW2

3 Tap the sampling speed button.

The screen returns to the measurement screen.

IMPORTANT

- When **[FAST1]** or **[FAST2]** is selected, the sampling time is shortened, making the instrument more susceptible to external environmental factors and line-frequency noise. Take countermeasures, such as shielding and twisting around objects under measurement (battery), test leads, and cables.

See "14.1 When Creating a Test-Lead Assembly by Yourself" (p.225).

- For details about the sampling time, see the specifications.

See "Sampling time" (p.181).

3.4 Performing the Self-Calibration Processes

Performing a resistance self-calibration process

By performing a resistance self-calibration process, you can correct fluctuations in the internal circuitry of the instrument, resulting in improved measurement accuracy.

IMPORTANT

The resistance measurement accuracy of the instrument is only guaranteed after the completion of the resistance self-calibration process. Always perform a resistance self-calibration process in the following cases:

- After the instrument is turned on and has completed the warming up process (lasting 60 minutes or more)
- When the ambient temperature has changed by 2°C or more

How to perform a DC-voltage self-calibration

- Press the **CAL** key, and then use the touchscreen.
- Short-circuit the CALIB2 pin to the ISO_COM pin. (CALIB2 input signal of the external I/O)
- Send a communications command

The measurement process stops during a resistance self-calibration process. (about 45 s)

By using the **CAL** key and the touchscreen

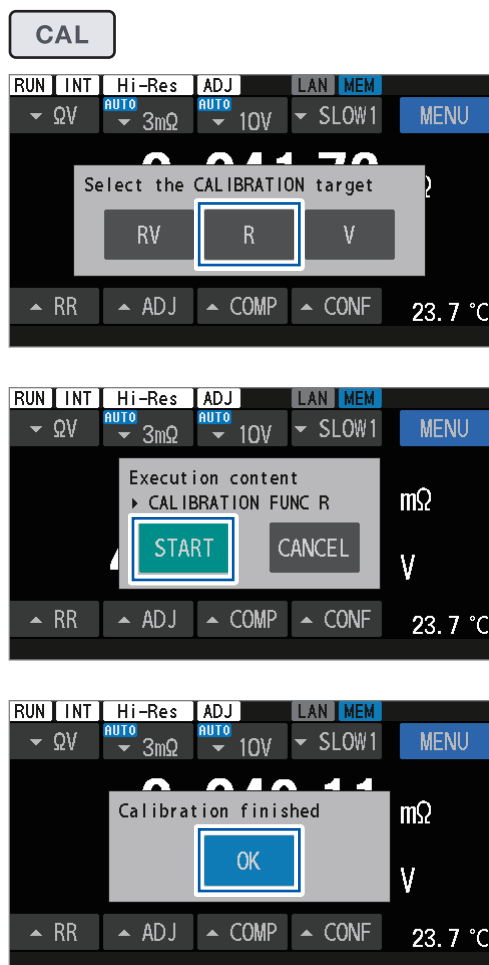

1 Press the **CAL** key.

2 Tap **[R]**.

If you tap **[RV]**, both a resistance and a DC-voltage self-calibration are performed.

3 Tap **[START]**.

A calibration process starts.

4 After the calibration processes are completed, tap **[OK]**.

The screen returns to the measurement screen.

Performing a DC-voltage self-calibration process (automatic/manual)

By performing the DC-voltage self-calibration process, you can correct fluctuations in the internal circuitry of the instrument, resulting in significantly improved accuracy in DC-voltage measurements.

IMPORTANT

The accuracy of voltage measurements with the instrument is guaranteed only after the completion of the DC-voltage self-calibration process. Always perform a DC-voltage self-calibration process in the following cases:

- After the instrument is turned on and has completed the warming up process (lasting 60 minutes or more)
- When the ambient temperature has changed by 0.1°C or more

How to perform a DC-voltage self-calibration

- Allow the instrument to automatically perform it internally.
- Short-circuit the CALIB pin to the ISO_COM pin. (CALIB input signal of the external I/O)
- Send a communications command
- Press the **CAL** key, and then use the touchscreen.

During a DC-voltage self-calibration process, the measurement process stops.

	Auto		Manual
	Automatically performed internally	By sending a command or pressing keys	By sending a command or pressing keys
Time required for the calibration process (duration when the measurement stops)	30 ms (50 Hz) 27 ms (60 Hz)	About 10 s (50 Hz, 60 Hz)	About 10 s (50 Hz, 60 Hz)

Switching between manual and automatic

[MENU] > [MEAS]

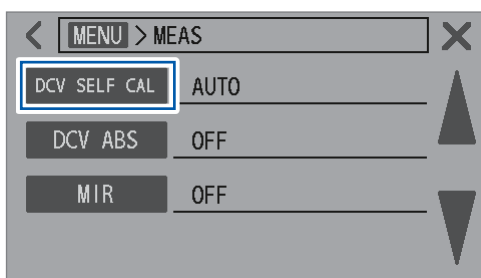

1 Tap **[DCV SELF CAL]**.

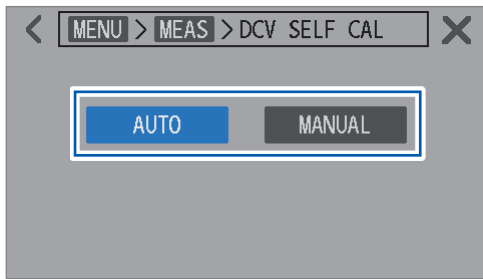

2 Switch between execution ways.

AUTO [☑]	A calibration process is automatically performed internally.
MANUAL	A calibration process is performed by using the CAL key and the touchscreen. It is performed by sending a communications command. A calibration process is performed by inputting the CALIB signal to the Ext. I/O connector.

When **[AUTO]** is selected, it can also be performed by operating the **CAL** key and the touchscreen. When **[AUTO]** is selected, a self-calibration process can be performed using a communications command or the external I/O. After the calibration process is performed, the instrument returns to the automatic internal operation.

3

By using the **CAL** key and the touchscreen

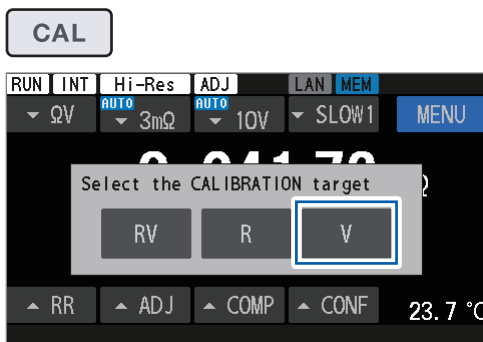

1 Press the **CAL** key.

2 Tap **[V]**.

If you tap **[RV]**, both a resistance and a DC-voltage self-calibration are performed.

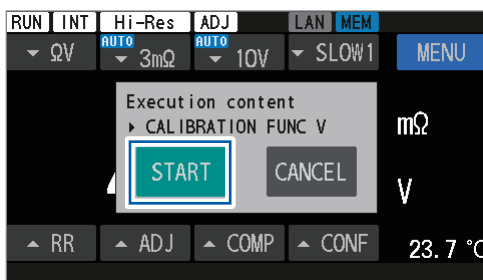

3 Tap **[START]**.

A calibration process starts.



4 After the calibration processes are completed, tap **[OK]**.

The screen returns to the measurement screen.

3.5 Performing the Zero Adjustments

Ensure to perform the zero adjustments before measurements to eliminate offset errors of measured values caused by changes in the offset voltage of the instrument or measurement environments*¹.

The instrument saves zero-adjustment values, which are associated with the measurement environment of the corresponding channel, in its internal memory.

The zero-adjustment values for both the resistance and DC-voltage measurements are saved in the internal memory of the instrument.

Zero-adjustment values are retained even if the instrument is turned off.

Two modes of the zero adjustment are available: single-channel and multi-channel modes. Choose between them.

Single-channel mode saves zero-adjustment values for one channel. Zero-adjustment values for the selected measuring ranges or all measuring ranges can be saved.

Multi-channel mode saves zero-adjustment values for each environment, which can be used for measurements involving switching between multiple objects. Switch to single-channel mode when channel switching is unnecessary due to a constraint*² in multi-channel mode.

*1. Factors included in measurement environment:

Shape and arrangement of the test lead

Presence/absence and arrangement of metal around objects under measurement (batteries)
(presence/absence and arrangement of other batteries existing around the target battery)

*2. Only one selected measuring function and range setting can be saved. When the zero adjustment is repeated after a range is changed, the previous multi-channel adjustment values are discarded. For details, see “Zero-adjustment target map” (p. 57).

Adjustment environment	Channel mode	
	Single-channel	Multi-channel (Ch. 1 to Ch. 528)
Measuring function	Selected function* ³	Selected function
Resistance range	Selected range* ⁴	Selected range
DC-voltage range	Selected range* ⁴	Selected range
Measurement current of the 3 mΩ range	Selected current setting* ⁴	Selected current setting
DC input resistance	Selected resistance setting* ⁴	Selected resistance setting

*3. Adjustment values are shared by the ΩV, Ω, and V functions.

Example: When a zero adjustment is performed with the ΩV function, the adjustment values are applied to the Ω and V functions.

*4. With the auto-ranging setting, zero-adjustments are performed for all ranges.

Zero-adjustment target map

Example: With the resistance measuring function ($[\Omega]$)

Function	R range	Channel mode										
		Single	Multi									
			Ch. 1	Ch. 2	Ch. 3	Ch. 4	Ch. 5	Ch. 6	...	Ch. 528		
Ω	30 Ω	[Orange Box]										
Ω	3 Ω	↑										
Ω	300 m Ω	In single-channel mode, adjustment values can be obtained in multiple ranges.										
Ω	30 m Ω	↓										
Ω	3 m Ω 100 mA	[Orange Box]										
Ω	3 m Ω 300 mA	[Orange Box]										

[Grey Box] : Adjustment target
[Green Box] : Adjustment target

[Green Box] : When the auto-ranging is selected, adjustment values are obtained for all ranges. In multi-channel mode, a range is moved to the appropriate fixed range, and then adjustment values are obtained.

The measurement accuracy of resistance and DC voltage is specified on the condition that the zero-adjustment is completed.

The zero adjustment in single channel mode can also be performed using the 0ADJ pin of the external I/O.

See "Pin assignment" (p.204).

Connecting a test lead

Before performing a zero adjustment, connect test-lead wires as described below:

- 1** Connect Sense Hi and Sense Lo.
- 2** Connect Source Hi and Source Lo.
- 3** Connect one point of the test-lead wires connected in step 1 to one point of the test-lead wires connected in step 2.

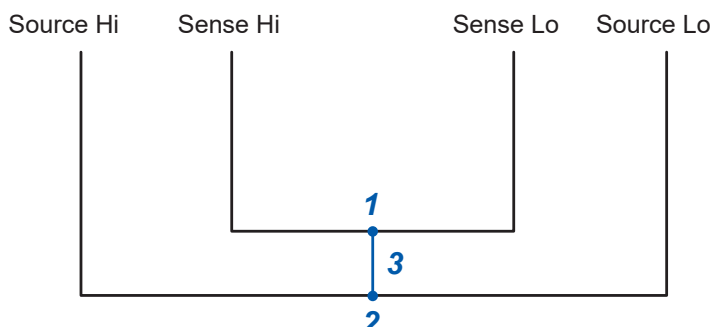

Arranging the test lead in the measurement environment used for the zero adjustment

Arrange the test lead to conform to the conditions of the measurement environment of an actual test system.

Since the zero residual quantities differ depending on the arrangement condition of the test lead (such as length, shape, and arrangement), place the assembly in accordance with the actual measurement condition before performing the zero adjustment.

1 Arrange the test lead to conform to the condition of the actual measurement environment.

The offset errors of measured values vary depending on various factors, such as the length, shape, and arrangement of the test lead, as well as presence/absence and arrangement of metal (other batteries) around objects under measurement (batteries). Before performing a zero adjustment, arrange the test lead according to the actual measurement environment.

During measurements

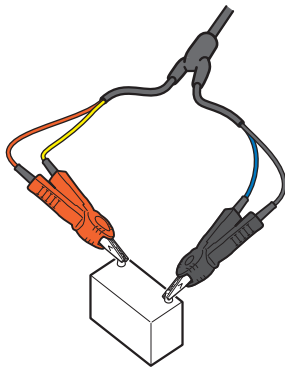

During the zero adjustment

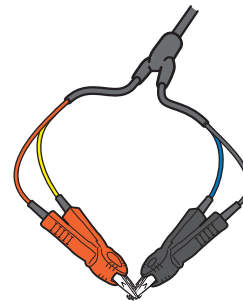

IMPORTANT

With the 3 m Ω and 30 m Ω ranges, particularly, offset errors in measured values may change significantly due to variations in the measurement environments. Ensure that the zero-adjustment environment conforms to the actual measurement environment.

Accuracy guaranteed conditions during measurement are as follows:

- No change in the shape of the test lead during measurement
- Make sure to make measurements in the same measurement environment as when the zero adjustment is performed.

Measurement environment:

Shape and arrangement of the test lead

Presence/absence of metal around objects under measurement (batteries)

(Presence/absence and arrangement of batteries existing around objects under measurement)

2 Short-circuit the test-lead wires correctly.

When a zero adjustment is performed correctly, accurate measured values can be obtained.

Example: When using the L2100/L2100 Pin Type Lead (optional equipment)

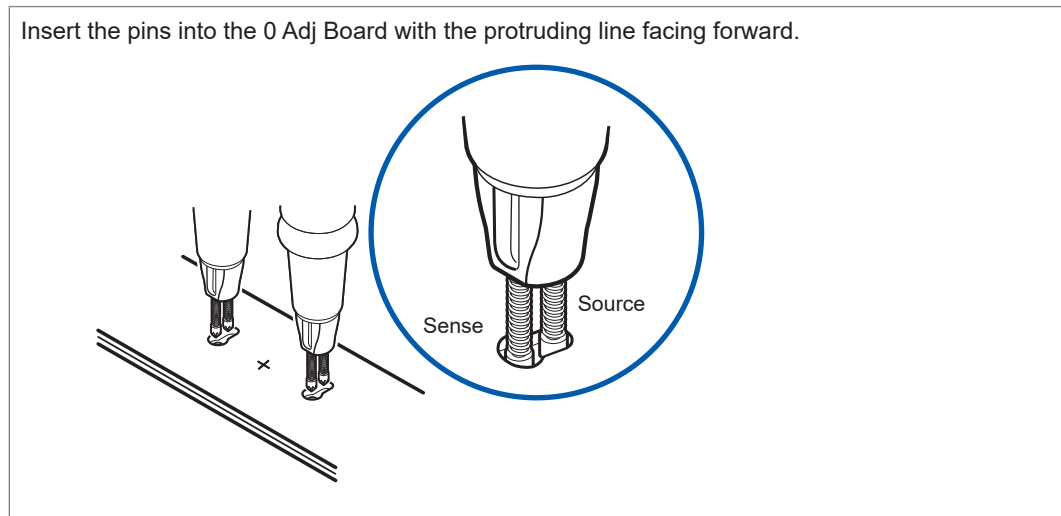

The pin-supporting part has a protruding line on the Sense side. Face these lines in the same direction when performing zero adjustments. Select two holes on the 0 Adj Board arranged symmetrically with respect to the line through the center plus sign, ensuring they are positioned at approximately the same distance as the terminals of the battery under measurement, then press the pins against the bottom of the holes.

Insert the Sense-side pin (where the lines are located) to the larger-diameter side of each oval holes.

Example: When using the L2121 Clip Type Lead (optional equipment)

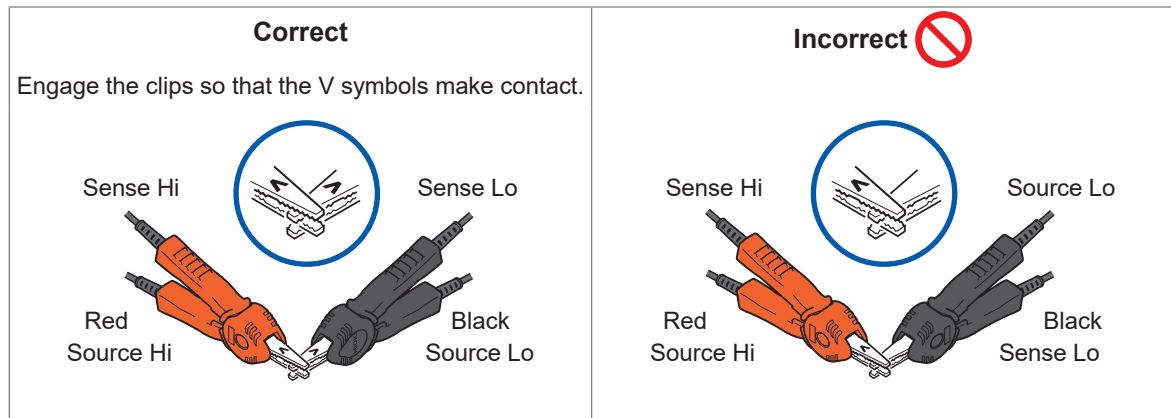

Configuring the zero-adjustment settings

Before performing a zero-adjustment, set the adjustment type to zero and select whether single-channel or multi-channel mode is to be used. Multi-channel mode requires the start and end channels to be specified.

These settings specify the type of zero-adjustment and the channels to which it applies for measured values.

Single-channel mode

[MENU] > [MEAS]

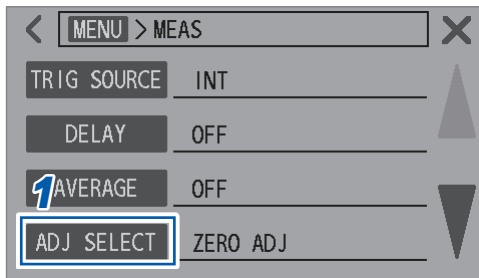

1 Tap [ADJ SELECT].

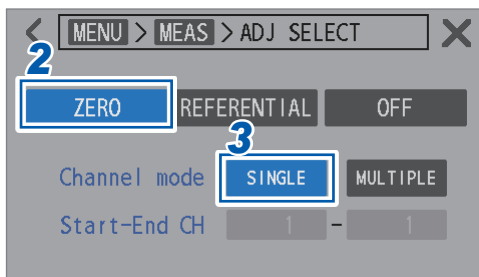

2 Tap [ZERO].

3 Tap [SINGLE].

Multi-channel mode

[MENU] > [MEAS]

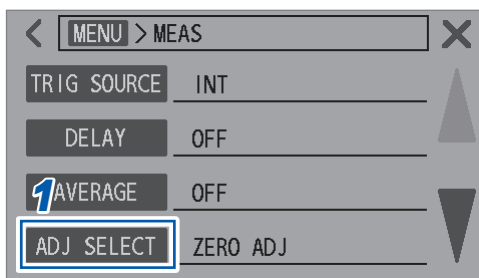

1 Tap [ADJ SELECT].

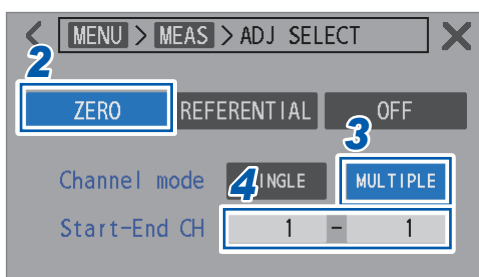

2 Tap [ZERO].

3 Tap [MULTIPLE].

4 Tap the [Start-End CH] box.

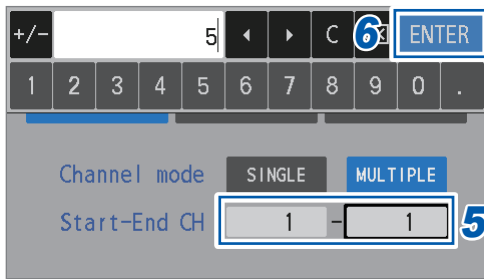

5 Use the numerical keypad to set the channels that start and end the zero adjustment.

1 to 528

6 Tap [ENTER] to confirm.

Performing a referential adjustment

Before performing an adjustment, select an adjustment type.
See “Configuring the zero-adjustment settings” (p.60).

Single-channel mode

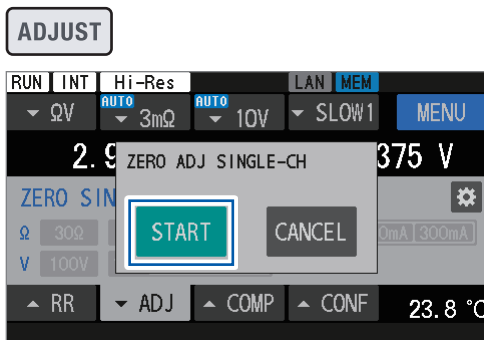

1 Press the **ADJUST** key.

2 Tap [START].

The instrument is now ready to obtain adjustment values.
The [ZERO ADJUST WAITING] message is displayed on the message bar.

3 While the [ZERO ADJUST WAITING] message is displayed on the message bar, short-circuit the test-lead wires.

The adjustment is performed.
See “2 Short-circuit the test-lead wires correctly.” (p.59).
If the test-lead wires are not short-circuited during the waiting state (about 10 s), the adjustment will fail.

If the adjustment fails, the dialog box appears as illustrated on the left.

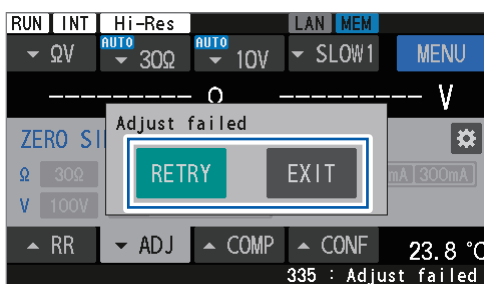

To repeat the adjustment, tap [RETRY].
To quit the adjustment, tap [EXIT].

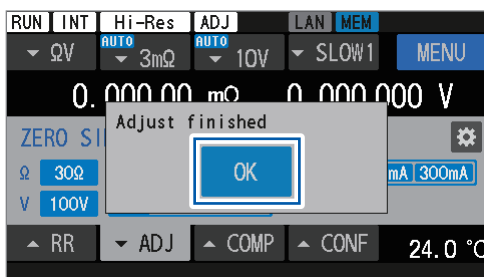

4 Tap [OK] to finish the adjustment.

Multi-channel mode

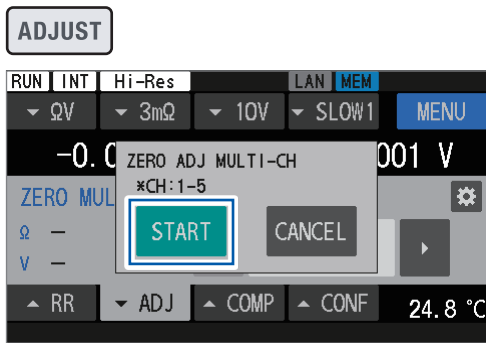

1 Press the **ADJUST** key.

The adjustment type and the channel numbers to be performed are displayed.

2 Tap **[START]**.

The instrument is now ready to obtain adjustment values.

The **[ZERO ADJUST WAITING]** message is displayed on the message bar.

The same applies to the second and subsequent channels.

3 While the **[ZERO ADJUST WAITING]** message is displayed on the message bar, short-circuit the test-lead wires.

The adjustment on the first channel is performed. See "2 Short-circuit the test-lead wires correctly." (p.59).

If the test-lead wires are not short-circuited during the waiting state (about 10 s), the adjustment will fail. The same applies to the second and subsequent channels.

The next channel number and the channels to be adjusted are displayed.

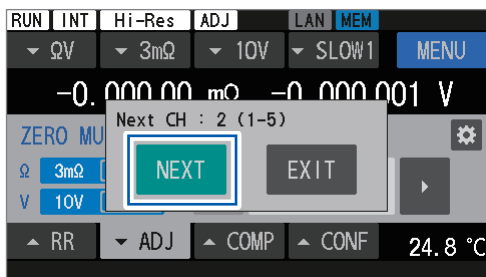

4 Tap **[NEXT]**.

The adjustment is performed.

(To finish the adjustment)

Tap **[EXIT]**.

The adjustment values of the obtained channels are retained.

If the adjustment fails, the dialog box appears as illustrated on the left.

(When repeating the adjustments on failed channels)

Tap **[RETRY]**.

(When quitting the adjustment on a failed channel to proceed to the next channel)

Tap **[SKIP]**.

(To quit the adjustment)

Tap **[EXIT]**.

5 Tap **[NEXT]**.

The zero adjustment on the last channel is performed.



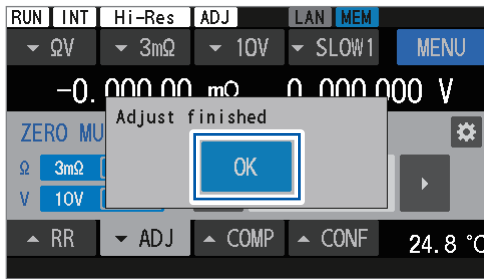

6 Tap [OK] to finish the zero adjustment.



To resume the multi-channel mode zero-adjustment for non-adjusted channels, refer to step 5 in “Configuring the zero-adjustment settings” (p.60) for instructions on specifying a start channel number.

IMPORTANT

If the setting of the measuring function, resistance range, or DC-voltage range has been changed from those used during the previous multi-channel mode zero-adjustment, all the previous multi-channel mode zero-adjustment values will be discarded. Ensure to perform a zero adjustment after checking the adjustment information on the adjustment selection screen.

Applying the adjustment values (How to check the obtained adjustment values)

See “Configuring the zero-adjustment settings” (p.60) for the adjustment type to be applied to measured values.

Single-channel mode

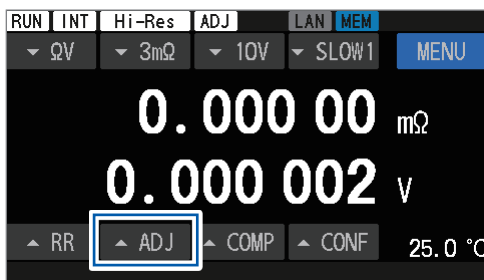

1 Tap [▲ADJ].

The adjustment setting screen is displayed.

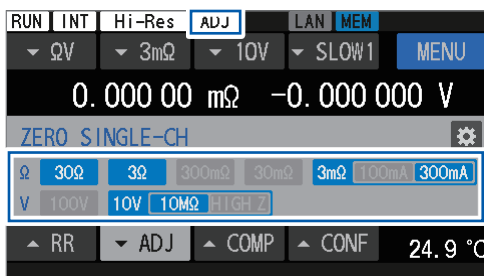

Ranges with obtained adjustment values are displayed in blue, while shaded areas indicate ranges without obtained adjustment values.

When the range setting is adjusted to a range with obtained values, the adjusted value is applied to measured values.

When the adjustment value is applied, the [ADJ] symbol is displayed on the status bar at the top of the screen.

With the ΩV function, if both the Ω and V ranges are set to those adjusted, the adjustment values are applied.

Multi-channel mode

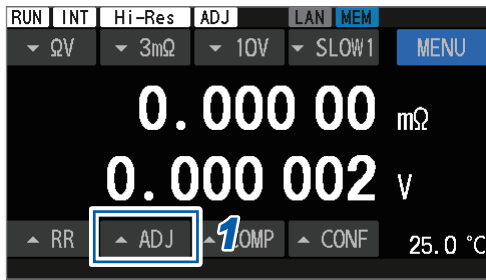

1 Tap [▲ADJ].

The adjustment setting screen is displayed.

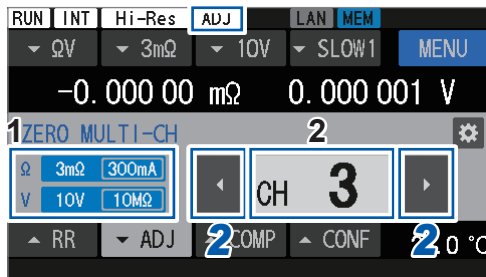

1 Displays the ranges with obtained adjustment values. Multi-channel mode cannot save adjustment values in multiple ranges.

2 **Channel-number box**
Displays the present channel number. If the adjusted values of the displayed channel number have been obtained in the step described in "Performing a referential adjustment" (p.61), the adjusted values are applied to measured values. If the specified channel does not have an adjustment value, the channel number is shaded. When the adjustment value is applied, the [ADJ] symbol is displayed on the status bar at the top of the screen.

2 Tap the Left and Right Arrow buttons ([◀] and [▶]) to change the channel number.

You can also tap the channel-number box and directly enter the channel number to change.

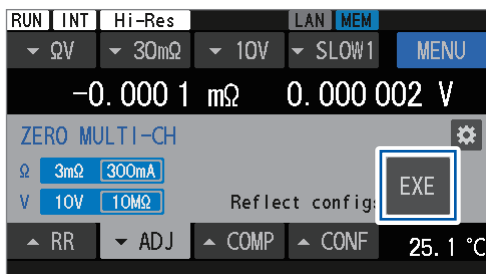
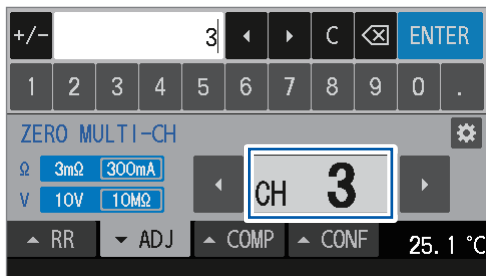

If the presently set measuring function or range differs from when the adjustment values are obtained, the values are not applied. The adjustment setting screen is displayed as illustrated on the left.

(To revert to the settings used when the adjustment values are obtained)

Tap [EXE].

3.6 Performing the Referential Adjustments

Perform a zero adjustment or referential adjustment before measurements to eliminate offset errors from measured values caused by changes in the offset voltage of the instrument or measurement environments*¹.

The referential adjustment capability can cancel offsets in measured values caused by variations in the positions of objects under measurement on an inspection tray. Unlike the zero adjustment, which removes offset errors by measuring a resistance of 0 Ω , the referential adjustment measures the internal resistance of an object under measurement (battery) to remove offset errors. Offsets are determined by comparing the reference value of the battery being inspected (hereafter referred to as the *Base*) with the actual measured values obtained by placing the Base at different positions on an inspection tray and measuring it.

The instrument saves referential-adjustment values, which are associated with the measurement environment of the corresponding channel in its internal memory.

Referential-adjustment values are retained even if the instrument is turned off.

The referential adjustment is available only in multi-channel mode.

Multi-channel mode can save referential-adjustment values for each environment when measurements involves switching between multiple objects.

Only one set of selected measuring function and resistance-range setting can be saved. When the referential adjustment is repeated after the measuring function or the range is changed, the previous referential-adjustment values are discarded. For details, see “Referential-adjustment target map” (p.67).

*1. Factors included in measurement environment:

Shape and arrangement of the test lead

Presence/absence of metal around objects under measurement (batteries) and arrangement (presence/absence and arrangement of other batteries existing around the target battery)

Adjustment environment	Multi-channel mode (Ch. 1 to Ch. 528)
Measuring function	Selected function (ΩV , Ω)* ²
Resistance range	Selected range
Measurement current of the 3 m Ω range	Selected current setting
DC input resistance	Selected resistance setting

*2. When the ΩV function is selected, DC voltage is set with the reference-value zero adjustment.

Basic procedure

1. The resistance of an object under measurement (battery), used as the reference, is singly measured. The instrument saves this value as the reference value (Base value).
2. Measurements are repeated for the object under measurement (battery), used in step 1, at each position on the inspection tray. The instrument saves these values as the actual measured values.
3. The instrument calculates and saves the difference*³ between each reference value and its corresponding actual measured value.

*3. Offsets based on the measurement environments (referential-adjustment values)

Practical battery inspection

1. The resistance of a battery on the inspection tray is measured. The position information (channel) of the object under measurement is indicated by instrument-touchscreen operations or communications commands.
2. The difference saved in *Basic procedure* step 3 is subtracted from the resistance value obtained in step 1 to obtain the final measured values.

Overall procedure of the referential adjustment

STEP1 Obtaining the Base value (including the Base-dedicated zero adjustment)

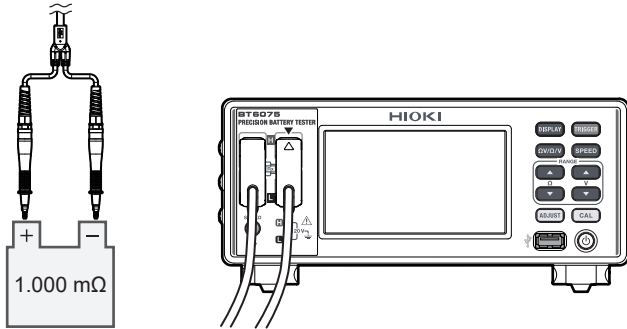

STEP2 Obtaining adjustment values for each channel (position)

Tips STEP1 It is recommended to use the same individual battery.

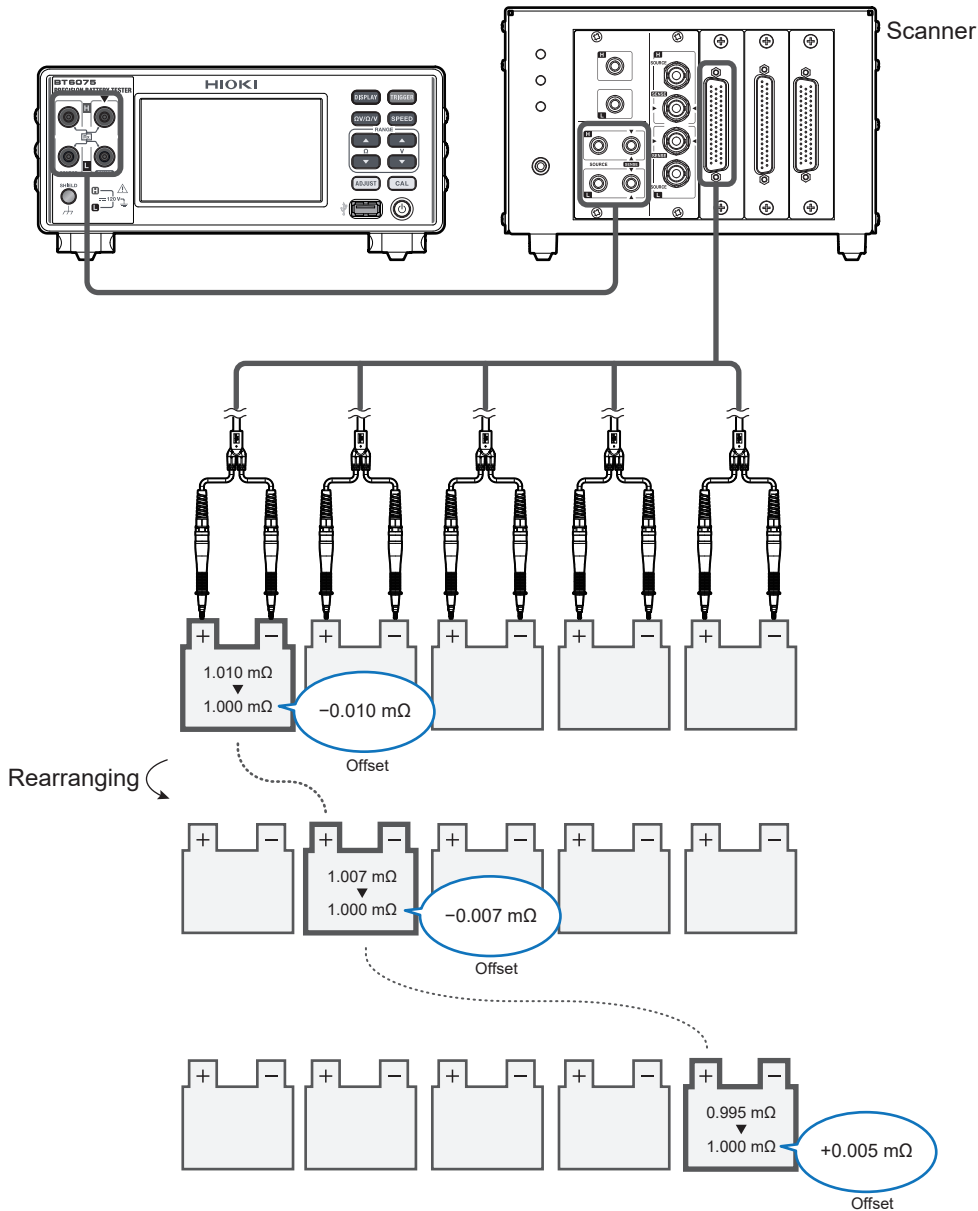

Referential-adjustment target map

Example: With the resistance measuring function (**[Ω]**)

The referential adjustment cannot be performed when the voltage measuring function (**[V]**) is selected.

Function	R range	Base value	Channel mode (multi)							
			Ch. 1	Ch. 2	Ch. 3	Ch. 4	Ch. 5	Ch. 6	...	Ch. 528
Ω	30 Ω									
Ω	3 Ω									
Ω	300 mΩ									
Ω	30 mΩ		<div style="border: 1px solid green; padding: 5px;"> In multi-channel mode, adjustment values cannot be obtained in multiple ranges. Old adjustment values are discarded when the data is obtained again. </div>							
Ω	3 mΩ 100 mA									
Ω	3 mΩ 300 mA									

When the Base value is obtained again, all adjustment data is discarded due to a change in the adjustment criterion.

: Adjustment target

Configuring the reference-adjustment settings

Before performing the referential adjustment, select referential for the adjustment type and specify the start and end channels.

[MENU] > [MEAS]

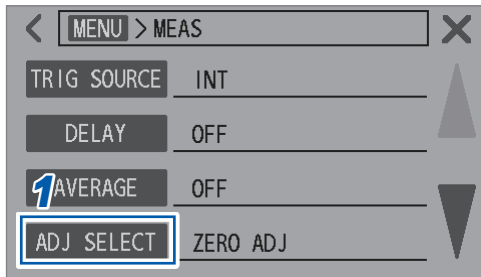

1 Tap [ADJ SELECT].

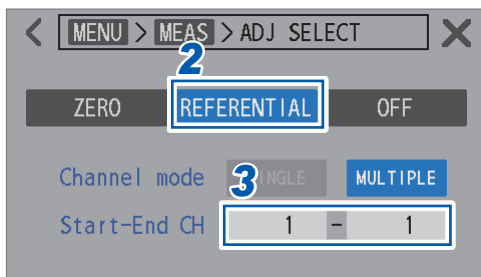

2 Tap [REFERENTIAL].

3 Tap the [Start-End CH] box.

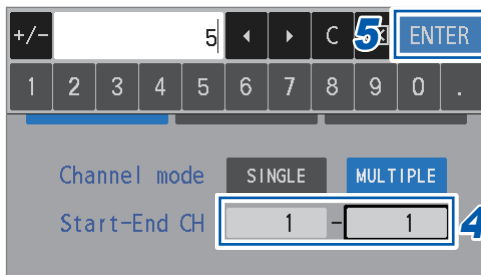

4 Use the numerical keypad to enter the start and end channels for the referential adjustment.

1 to 528

5 Tap [ENTER] to confirm.

Performing a referential adjustment

Before performing an adjustment, select an adjustment type.
See “Configuring the reference-adjustment settings” (p.68).

STEP1 Acquiring the internal resistance value (Base value) of the inspection target battery

STEP1-1 Base-dedicated zero adjustment

Perform a zero adjustment before acquiring the Base value.

Tips Ensure to make a measurement for the Base before a zero adjustment to confirm the appropriate range, and then start the zero adjustment using this range. Otherwise, the Base value may go out of range during measurement for the Base.



1 Press the **ADJUST** key.

2 Tap **[START]**.

The instrument is now configured for the Base-dedicated zero-adjustment.

The **[BASE ZERO ADJUST WAITING]** message is displayed on the message bar.

Tips If the Base value has already been obtained, you can skip this Base-dedicated zero adjustment and the Base-value obtaining steps outlined in **STEP1-2**. To skip, tap **[SKIP]**. You can proceed to **STEP2**. When the Base value has already been obtained, note that if the measuring function or range setting used when pressing the **ADJUST** key differ from those used when the Base value was initially obtained, it becomes necessary to obtain the Base values again. In such cases, skipping this process is not possible.

3 While the **[BASE ZERO ADJUST WAITING]** message is displayed on the message bar, **short-circuit the test-lead wires**.

The Base-dedicated zero-adjustment is performed. *1 See “2 Short-circuit the test-lead wires correctly.” (p.59).

If the test-lead wires are not short-circuited during the waiting state (about 10 s), the adjustment will fail.

*1. When the ΩV function is selected, a DC-voltage zero-adjustment is simultaneously performed.

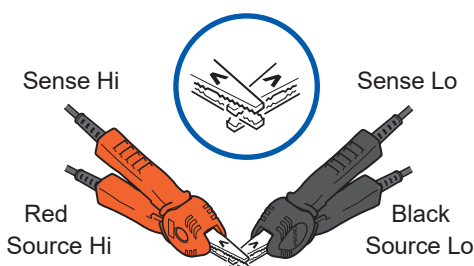
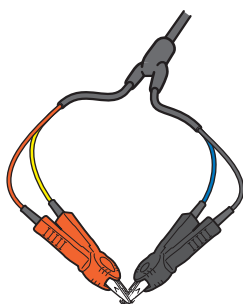

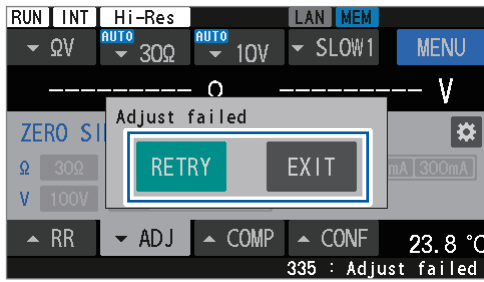

If the adjustment fails, the dialog box appears as illustrated on the left.

(To repeat the adjustment)

Tap **[RETRY]**.

(To quit the adjustment)

Tap **[EXIT]**.

STEP1-2 Acquiring the Base value



4 Tap **[START]**.

The instrument is prepared to obtain Base values. The **[BASE OBTAINMENT WAITING]** message is displayed on the message bar.

Tap **[CANCEL]** to quit obtaining the Base-value. The Base-dedicated zero-adjustment value obtained in **STEP1-1** is discarded.

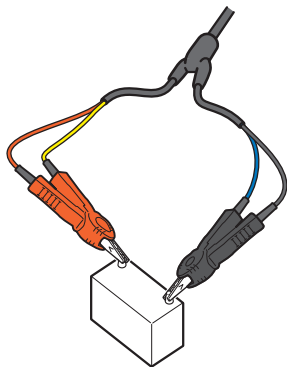

5 While the **[BASE OBTAINMENT WAITING]** message is displayed on the message bar, connect the test-lead wires to the Base.

The instrument starts to obtain the Base value. If the test lead is not connected with the Base during the standby state (about 10 s), the adjustment will fail.

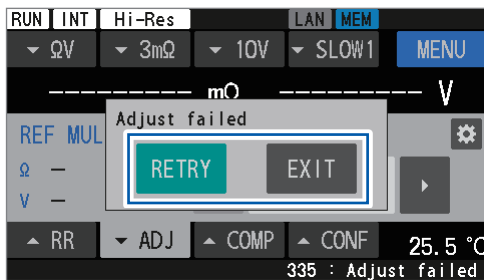

If the instrument fails to obtain the Base value, the dialog box appears as illustrated on the left.

(To repeat obtaining the Base value)

Tap **[RETRY]**.

(To quit obtaining the Base value)

Tap **[EXIT]**.

When you quit obtaining the Base value, the Base-dedicated zero-adjustment values are discarded.

STEP2 Obtaining adjustment values for each channel (position)

6 Prepare the measurement environment.

In the actual measurement environments of an inspection system, place the Base at the first channel to be measured, and place equivalents of the object to be measured at the other channels. Since offset errors of measured values differ depending on the arrangement of the test-lead assembly and the presence/absence of other batteries around the Base, place the Base according to the actual inspection line before performing a reference adjustment.

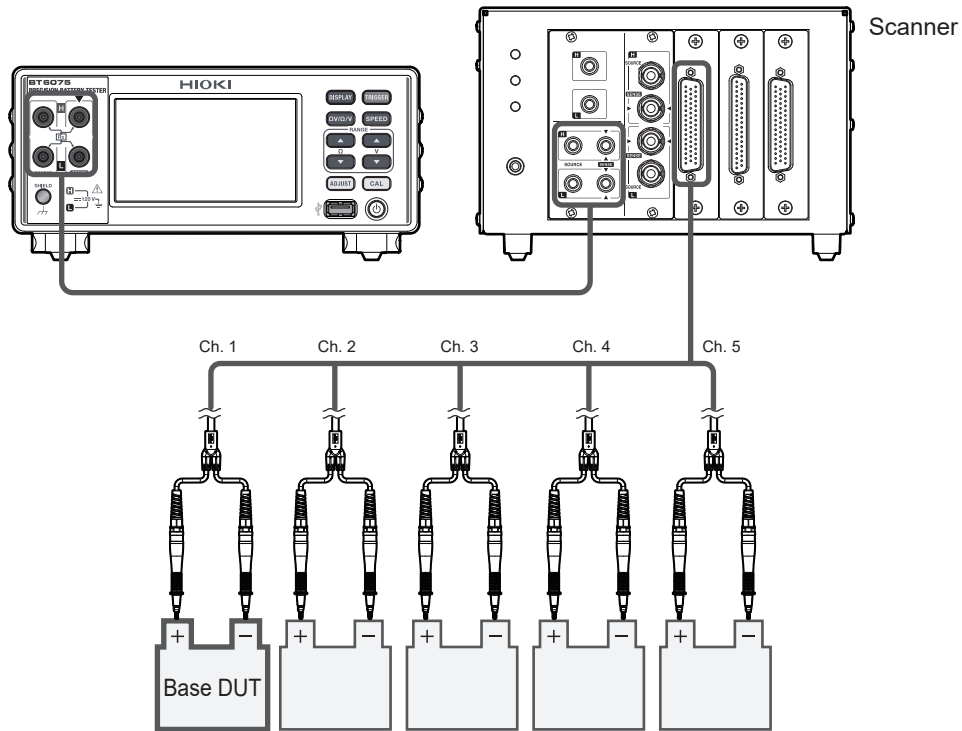

7 Tap [START].

When the test-lead assembly has not connected to the Base yet, the instrument is prepared to obtain adjustment values.

The **[REFERENTIAL ADJUST WAITING]** message is displayed on the message bar.

Similarly for the second and subsequent channels, the instrument is prepared to obtain adjustment values.

(To finish the adjustment)

Tap [EXIT].

The Base values are saved. When repeating the reference adjustment, you can skip acquiring the Base values described in **STEP1**.

8 While the [REFERENTIAL ADJUST WAITING] message is displayed on the message bar, connect the instrument and an object under measurement.

The adjustment on the first channel is performed.

If the instrument are not connected to an object under measurement during the waiting state (about 10 s), the adjustment will fail.

Similarly for the second and subsequent channels, connect the instrument to an object under measurement to perform an adjustment.

9 Prepare the measurement environment.

Position the Base at the next channel and the equivalents to the object under measurement at the other channels.

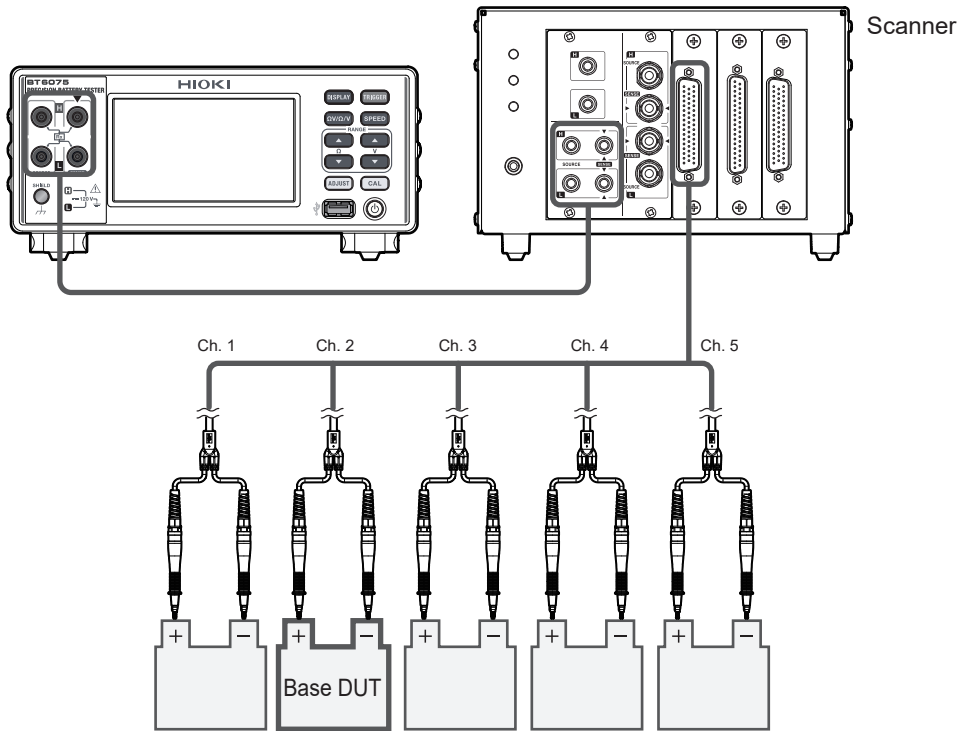



The next channel and the channels to be measured are displayed.

10 Tap [NEXT].

(To finish the adjustment)

Tap [EXIT].

The Base value and the adjustment values of the channels obtained so far are retained.

If the adjustment fails, the dialog box appears as illustrated on the left.

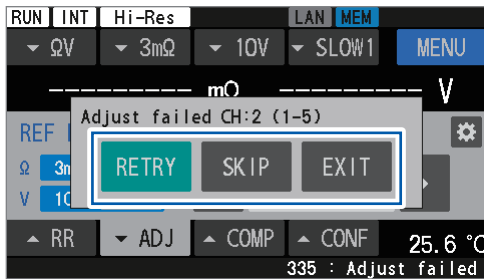

(When repeating the adjustments on failed channels)

Tap [RETRY].

(When quitting the adjustment on a failed channel to proceed to the next channel)

Tap [SKIP].

(To quit the adjustment)

Tap [EXIT].

The adjustment values of the obtained channels are retained.

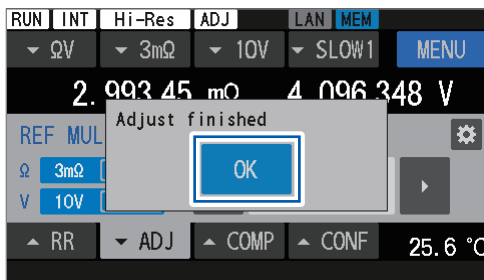

11 Perform the adjustment on the final channel.

12 Tap [OK] to finish the zero adjustment.



To resume the referential adjustment for non-adjusted channels, refer to step 4 in “Configuring the reference-adjustment settings” (p.68) for instruction on specifying a start channel number.

IMPORTANT

If the setting of the measuring function, resistance range, or DC-voltage range has been changed from those used during the previous referential adjustment, all the previous referential adjustment values will be discarded. Ensure to perform the referential adjustment after checking the adjustment information on the adjustment selection screen.

Applying the adjustment values (How to check the obtained adjustment values)

See the “Configuring the reference-adjustment settings” (p.68) to set the type of zero adjustment to be applied.

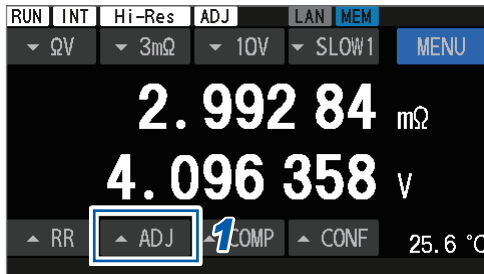

1 Tap [▲ADJ].

The adjustment setting screen is displayed.

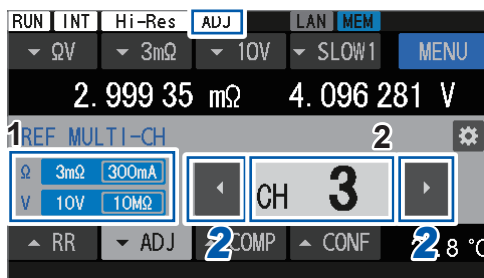

- | | |
|----------|--|
| 1 | Displays the ranges with obtained adjustment values. The adjustment values cannot be retained in multiple ranges. |
| 2 | <p>Channel-number box</p> <p>Displays the present channel number. If the adjusted values of the displayed channel number have been obtained in the step described in “Performing a referential adjustment” (p.69), the adjusted values are applied to measured values. If the specified channel does not have an adjustment value, the channel number is shaded.</p> <p>When the adjustment value is applied, the [ADJ] symbol is displayed on the status bar at the top of the screen.</p> |

2 Tap the Left and Right Arrow buttons ([◀] and [▶]) to change the channel number.

You can also tap the channel-number box and directly enter the channel number to change.

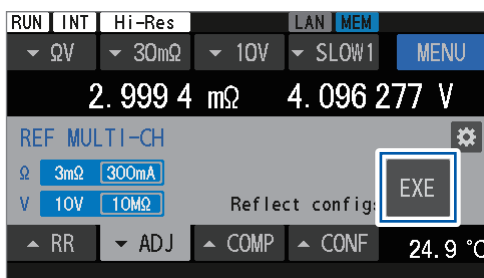
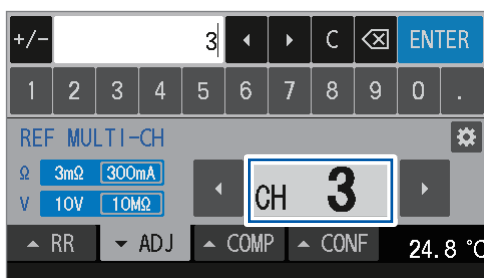

If the presently set measuring function or range differs from when the adjustment values are obtained, the values are not applied. The adjustment setting screen is displayed as illustrated on the left.

(To change the settings to those used when the adjustment values are obtained)

Tap [EXE].

3.7 Connecting a Test Lead to Objects Under Measurement (Batteries)

If the contact positions of the test-lead wires with an object under measurement varies, measurements may be easily influenced by potential gradients. To reduce this effect, it is recommended to use a parallel-two-pin test lead. The use of clip-type or coaxial-type test lead could lead to a deterioration in repeatability of measured values due to inaccuracies in contact positions.

Example illustrations of the test-lead wires contacting batteries

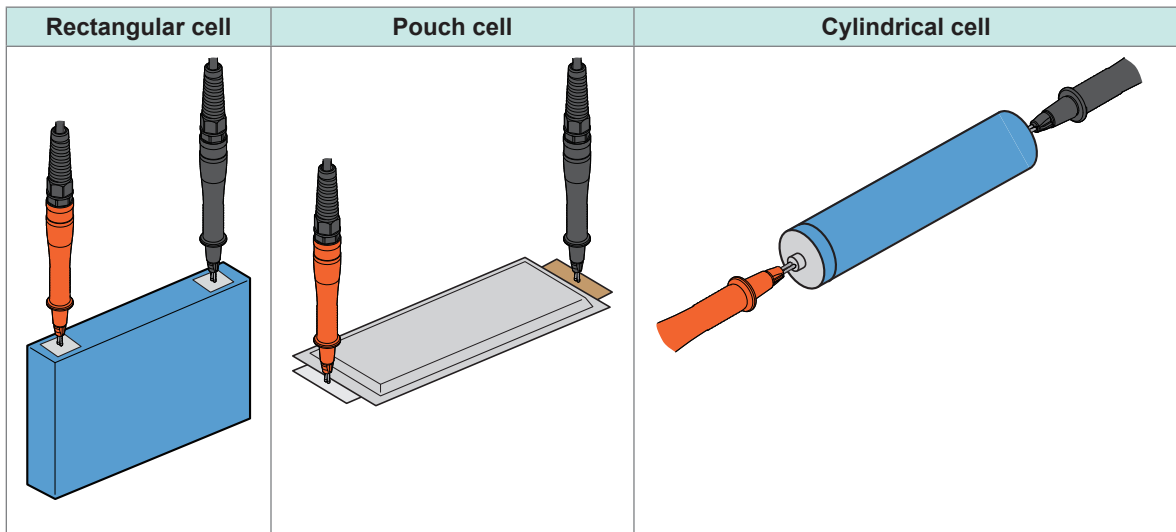

3.8 Displaying Measurement Results

The measurement results of selected functions are displayed on the screen.

When the Z2005 Temperature Sensor is connected, the instrument displays measured temperature value in the lower right corner of the screen regardless of the function. If you change settings related to measured values, such as ranges and functions, the on-screen readings disappear.

When the ΩV function is selected

The measured resistance value is displayed at the upper row of the screen, and the measured voltage value is displayed at the lower row.

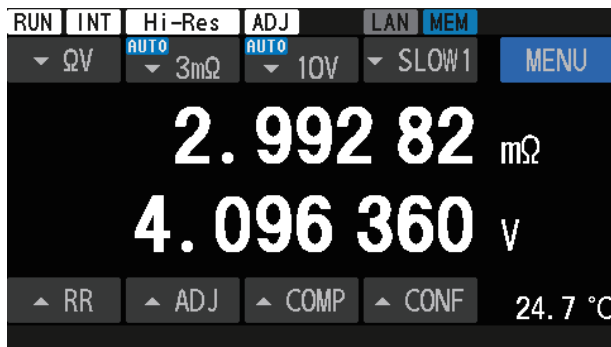

When the Ω function is selected

The measured resistance value is displayed in the upper row of the screen.

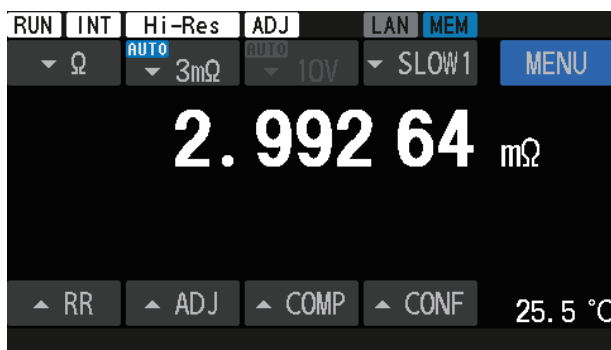

When the V function is selected

The measured voltage value is displayed in the lower row of the screen.

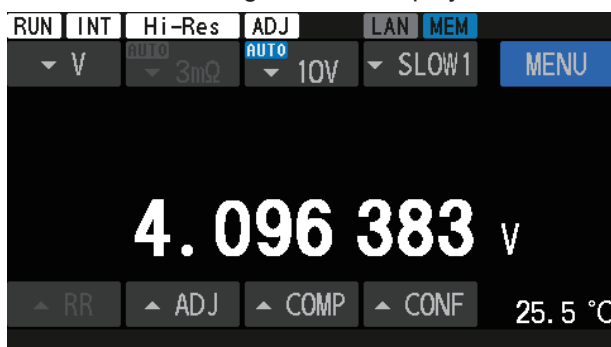

IMPORTANT

If measured values vary, see “Measured values do not stabilize.” (p.214) in “13.3 Troubleshooting” (p.212).

Features of the contact check (wire-break detection)

The contact check capability can determine whether the test lead is properly in contact with objects under measurement (batteries).

(1) Detecting a wire break between Source Hi and Source Lo to indicate

Supported measuring functions: ΩV and Ω (V not supported)

(2) Detecting a wire break between Sense Hi and Sense Lo to indicate

Supported measuring functions: ΩV , Ω , and V

If a Source-side break is detected, Sense-side breaks cannot be detected.

When a break judgment is provided, the measurement error signal (ERR) is output from the external I/O pin.

See “ERR” (p. 132).

For example, a break judgment is provided in the following cases:

- The test-lead wires are not connected with an object under measurement (battery).
- The test lead has a break.
- The contact resistance is high due to worn or dirty test lead.
- The test lead has a high wiring resistance.
See “Wire-break thresholds” (p. 77).
- The circuit-protection fuse is brown.
See “13.3 Troubleshooting” (p. 212).
- The object under measurement has a high resistance compared to the range.
Example: When measuring a resistance of 100 Ω using the 300 m Ω range

Wire-break thresholds

Resistance range	Resistance measurement current	Between Source Hi and Source Lo	Between Sense Hi and Sense Lo
3 m Ω	300 mA	11 Ω or more	110 Ω or more
	100 mA	52 Ω or more	110 Ω or more
30 m Ω	100 mA	52 Ω or more	110 Ω or more
300 m Ω	10 mA	600 Ω or more	110 Ω or more
3 Ω	1 mA	6 k Ω or more	110 Ω or more
30 Ω	100 μA	60 k Ω or more	1100 Ω or more

Measuring function	DC-voltage range	Between Sense Hi and Sense Lo
V	10 V	110 Ω or more
	100 V	110 Ω or more

If a test lead has a capacitance of 1 nF or more, the instrument may not detect measurement errors.

Temperature measurement

Detecting a connection error with the Z2005 Temperature Sensor to indicate

On-screen information: [---.°C]

Overrange indication

If **[+OVER]** or **[-OVER]** is displayed on the screen, it indicates the measured value is outside the displayable counts range.

Select the appropriate measurement range.



DANGER



- **Do not allow a test-lead tip to short-circuit any two wires carrying voltage.**

Doing so will cause a short-circuit fault, resulting in serious bodily injury.

3.9 Route-Resistance Monitor

With the resistance measuring function ($[ΩV]$ or $[Ω]$), the route-resistance monitor enables you to verify the route resistance value of each terminal during four-terminal measurement. The route-resistance monitoring capability cannot be used with the voltage measuring function ($[V]$).

The route resistance is the resistance between the measurement terminals of the instrument and the contact points of the test-lead wires with the object under measurement (battery).

See “1.3 Part Names and Functions” (p.20).

As shown in the figure, route resistance comprises wiring resistance, relay-contact resistance, and contact resistance between test-lead wires and the object under measurement.

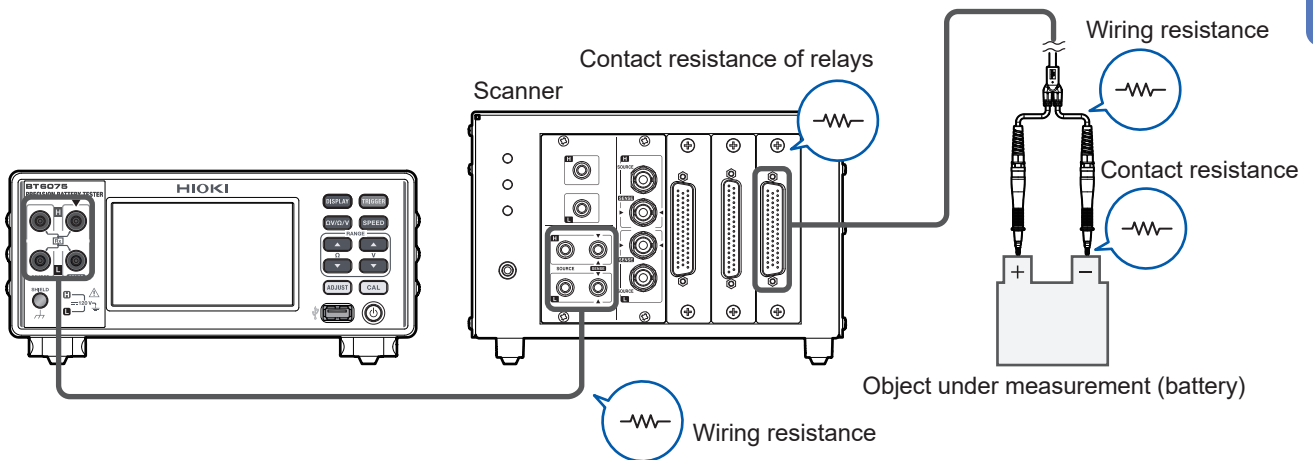

3

Making Measurements

The four-terminal route resistances ($R_{Source\ Hi}$, $R_{Source\ Lo}$, $R_{Sense\ Hi}$, and $R_{Sense\ Lo}$) are defined as follows:

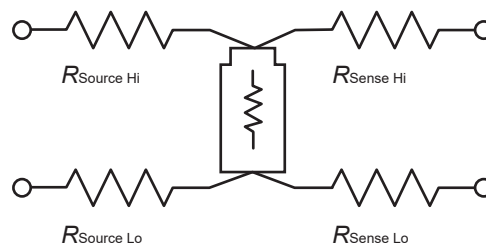

$R_{Source\ Hi}$	Resistance between Source Hi terminal and an object under measurement (battery)
$R_{Source\ Lo}$	Resistance between Source Lo terminal and an object under measurement (battery)
$R_{Sense\ Hi}$	Resistance between Sense Hi terminal and an object under measurement (battery)
$R_{Sense\ Lo}$	Resistance between Sense Lo terminal and an object under measurement (battery)

These resistance values do not include the internal resistance of objects under measurement (batteries).

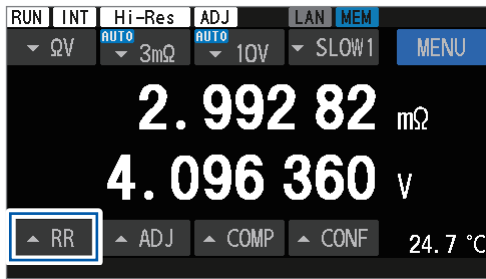

- 1 While making measurement with the resistance measuring function ([ΩV] or [Ω]), tap [RR] or press the DISPLAY key.

The route-resistance monitor is displayed.

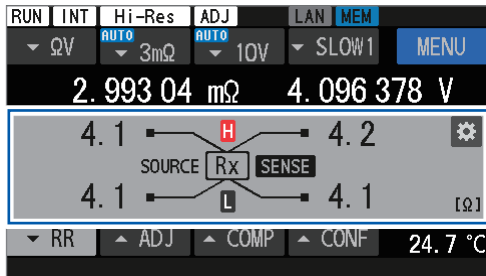

Display example

1	Indicates the measurement result of $R_{\text{Source Hi}}$.
2	Indicates the measurement result of $R_{\text{Source Lo}}$.
3	Indicates the measurement result of $R_{\text{Sense Hi}}$.
4	Indicates the measurement result of $R_{\text{Sense Lo}}$.

If any other symbol is displayed, see “Information on the measured route-resistance value display area” (p.82).

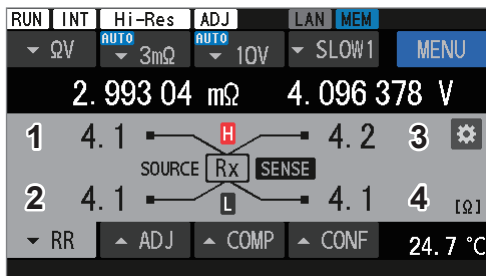

When configuring the comparator for route resistance

- 2 Tap the setting button.

See “5.4 Configuring the Comparator Settings for the Route-Resistance Monitor” (p.103) for the rest of the procedure.

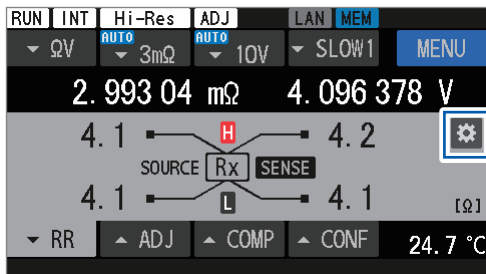

Route-resistance measurement error

Error message on the message bar

(1) Sense-terminal route-resistance error

An error was detected in the route resistance of the Sense Hi or Sense Lo terminal.

On-screen message: **SENSE ROUTE RESISTANCE ERROR**

- The route resistance of the Source Hi or Source Lo terminal exceeds the display range*¹.
- The sum of the route resistances for both the Source Hi and Source Lo terminals exceeds the accuracy guarantee range*².

Measured values are displayed for reference purposes. For details, see “Information on the measured route-resistance value display area” (p.82).

- The route resistance of the Sense Hi or Sense Lo terminal exceeds the predefined fail threshold.

(2) Source-terminal route-resistance error

An error was detected in the route resistance of the Source Hi or Source Lo terminal.

On-screen message: **SOURCE ROUTE RESISTANCE ERROR**

- The route resistance of the Source Hi or Source Lo terminal exceeds the display range*¹.
- The sum of the route resistances for both the Source Hi and Source Lo terminals exceeds the accuracy guarantee range*².

Measured values are displayed for reference purposes. For details, see “Information on the measured route-resistance value display area” (p.82).

- The route resistance of the Source Hi or Source Lo terminal exceeds the predefined fail threshold.



Error judgments are performed on each of the four terminals.

If errors occur on multiple terminals, only one terminal error is displayed with the following priority.

1. Sense Hi
2. Sense Lo
3. Source Hi
4. Source Lo

Display range and accuracy assurance range for route resistance

Resistance range	*1. Display range (Ω)	*2. Maximum guaranteed accuracy (Ω)
3 m Ω (300 mA)	-1.0 to 10.0	10.0
3 m Ω (100 mA)	-1.0 to 50.0	50.0
30 m Ω		
300 m Ω		
3 Ω		
30 Ω	-10 to 500	

Information on the measured route-resistance value display area

Display type

Numbers are examples.

[- - - - -]	An contact check error (SENSE CONTACT ERROR, SOURCE CONTACT ERROR) or overflow (SENSE OVER FLOW) occurred.
[+OVER], [-OVER]	The measured value exceeded the display range of the corresponding terminal
! 1.2	The measured value is displayed for reference purposes.
1.2	The measured value exceeded the user-defined fail threshold.
1.2	The measured value exceeded the user-defined warning threshold.
1.2	The route resistance is correctly measured.

Display of measured values for reference purposes

If any of the following conditions are not met, measured values, the accuracy of which cannot be guaranteed, may still be displayed for reference purposes.

- A sense contact-check error occurred.
- A source contact-check error occurred.
- A sense overflow occurred.
- The measured value exceeded the display range of the corresponding terminal

The conditions for displaying reference values for each terminal are outlined below.

Sense Hi

- **A** The sum of the route resistances for the Sense Hi and Sense Lo terminals exceeds the accuracy guarantee range.
- **B** The route resistance of the Source Hi terminal exceeds the display range.
- **C** The sum of the route resistances for the Source Hi and Source Lo terminals exceeds the accuracy guarantee range.

Sense Lo

- **D** The sum of the route resistances for the Sense Hi and Sense Lo terminals exceeds the accuracy guarantee range.
- **E** The route resistance of the Source Lo terminal exceeds the display range.
- **F** The sum of the route resistances for the Source Hi and Source Lo terminals exceeds the accuracy guarantee range.

Source Hi

- **G** The sum of the route resistances for the Source Hi and Source Lo terminals exceeds the accuracy guarantee range.

Source Lo

- **H** The sum of the route resistances for the Source Hi and Source Lo terminals exceeds the accuracy guarantee range.

On-screen readings for reference purpose (concrete example)

⋮ Cause



⚠ On-screen reading for reference purpose

Sense Hi

- **A** The sum of the route resistances for the Sense Hi and Sense Lo terminals exceeds the accuracy guarantee range.

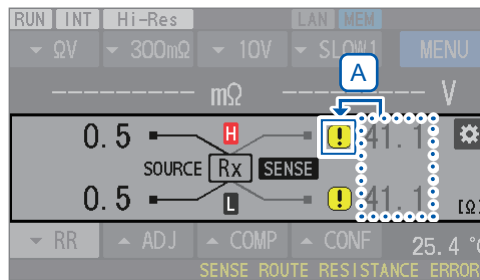

- **B** The route resistance of the Source Hi terminal exceeds the display range.

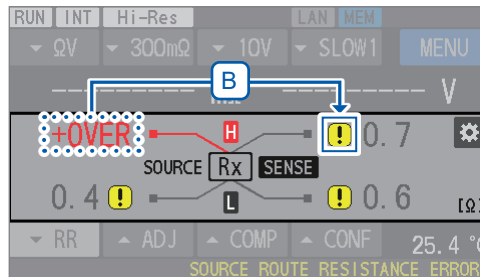

- **C** The sum of the route resistances for the Source Hi and Source Lo terminals exceeds the accuracy guarantee range.

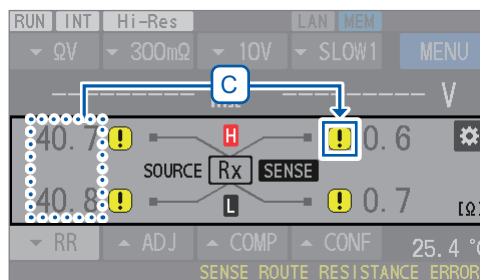

Sense Lo

- **D** The sum of the route resistances for the Sense Hi and Sense Lo terminals exceeds the accuracy guarantee range.

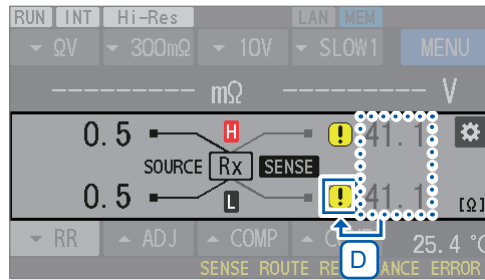

- **E** The route resistance of the Source Lo terminal exceeds the display range.

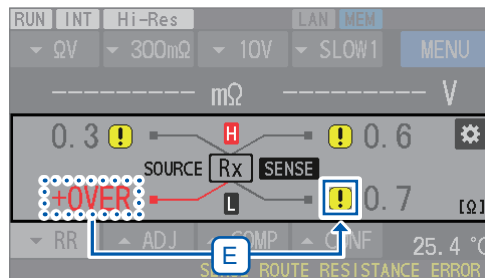

- **F** The sum of the route resistances for the Source Hi and Source Lo terminals exceeds the accuracy guarantee range.

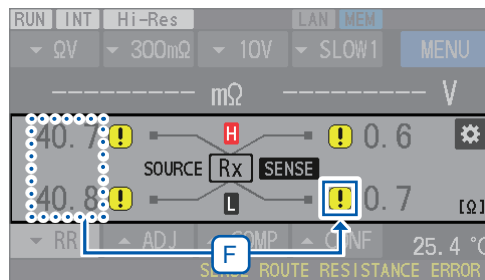

Source Hi

- **G** The sum of the route resistances for the Source Hi and Source Lo terminals exceeds the accuracy guarantee range.

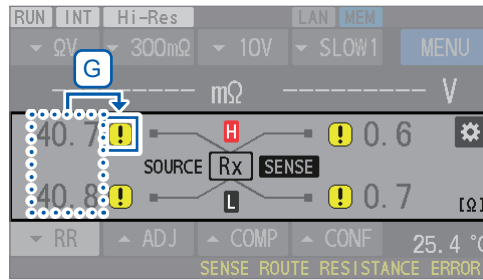

Source Lo

- **H** The sum of the route resistances for the Source Hi and Source Lo terminals exceeds the accuracy guarantee range.

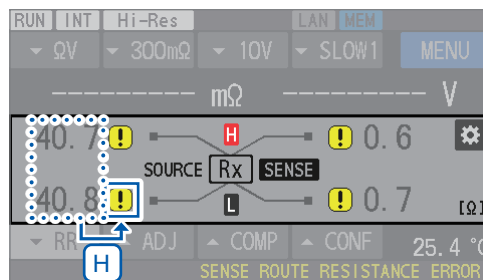

Tips Tap the **!** symbol to view the reason why the reference value is displayed for the corresponding terminal.

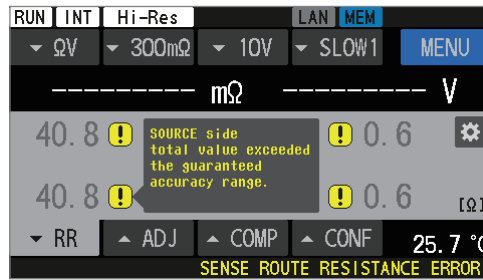

4.1 Starting Measurements With Triggers

The instrument starts a measurement each time a trigger is input.

This section describes how to configure the trigger-source settings.

The two trigger-source settings are available: the internal trigger and the external trigger.

By default, trigger-reception continuation mode is turned on. It cannot be turned off through the operation of this instrument. It can only be turned off through operation via a communications command. See Communications Command Instruction Manual.

When returning to a local state*¹ or being turned off then on again, the instrument resets the trigger-reception continuation mode to on.

*1. The status when remote status is canceled, indicating that communications control is activated
See “Switching between the remote and local states” (p. 153).

Trigger source	Trigger-reception continuation mode	
	On [☑]	Off
INT (internal) [☑]	Making measurements continuously (<i>free run</i>)	<ol style="list-style-type: none"> 1. Entering a trigger-reception state with the dedicated command. 2. Making a single measurement. 3. Leaving the trigger-reception state.
EXT (external)	Making a single measurement with a trigger input.	<ol style="list-style-type: none"> 1. Entering a ready-for-trigger state with the dedicated command. 2. Making a single measurement with a trigger input. 3. Leaving the trigger-reception state.

Selecting a trigger source.

[MENU] > [MEAS]

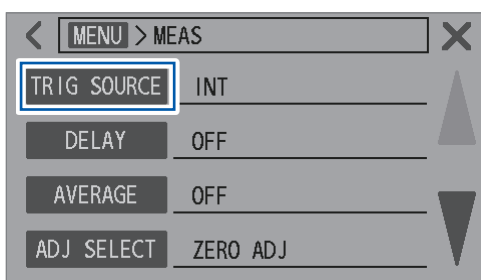

1 Tap [TRIG SOURCE].

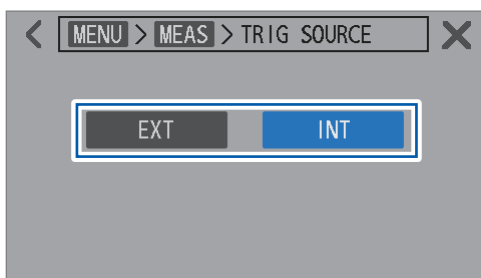

2 Selecting a trigger-source setting.

EXT, INT[☑]

Making measurements by internal triggers

The instrument internally generates triggers continuously and enters the continuous measurement (free run) state.

See “Trigger system” (p.89).

Making a measurement by an external trigger

There are three ways to input external triggers. The instrument makes a measurement each time an external trigger is input.

By pressing a physical key	When the TRIGGER key is pressed, the instrument makes a single measurement. When the TRIGGER key is pressed during a measurement, the instrument stops the measurement.
External I/O	When the TRIG and ISO_COM pins in the rear-mounted Ext. I/O connector are short-circuited, the instrument makes a single measurement. See “Input signals” (p. 130) and “From starting the measurement to acquiring judgment results” (p. 135).
By sending a communications command	The instrument makes a single measurement upon receiving the *TRG command via LAN, RS-232C, or USB.

With the internal-trigger setting, the above three methods are invalid.

See “Trigger system” (p.89).

Trigger system

Measurement procedure

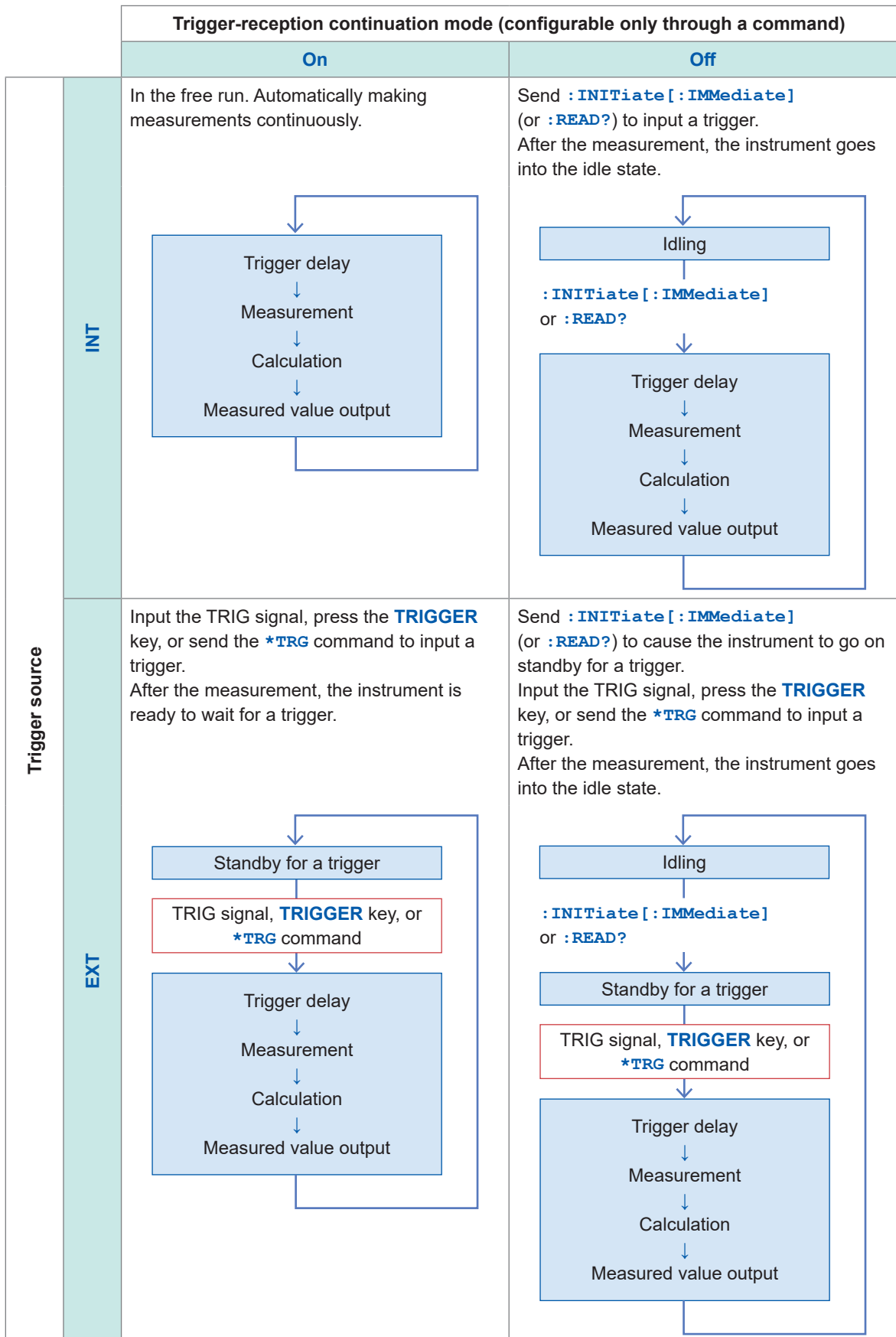

4.2 Starting Sampling After Measurement Signals Stabilize (Trigger Delay)

In this section, we will explore how to specify the delay time, which is the period between the input of a trigger and the start of sampling. With this capability, even if a trigger is input immediately after an object under measurement (battery) is connected, the instrument can start sampling after measurement signals are stabilized.

It is recommended to specify a time longer than the response time, the period required for measurement signals to stabilize.

The response time varies depending on the object under measurement (battery).

IMPORTANT

Ensure that the delay time is set to 5 ms or more.

The instrument requires a delay time of 5 ms or less for the internal circuitry to switch from the DC-voltage self-calibration operation to the measurement operation. Under the following conditions, an internal delay of 10 ms or more is required. Ensure that the delay time is set to 10 ms or more.

Trigger source: Internal

Trigger-reception continuation mode: Off

DC-voltage self-calibration: Auto

[MENU] > [MEAS]

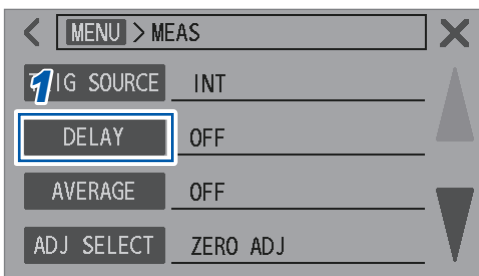

1 Tap [DELAY].

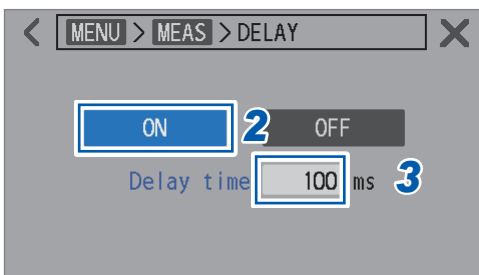

2 Tap [ON].

3 Tap the [Delay time] box.

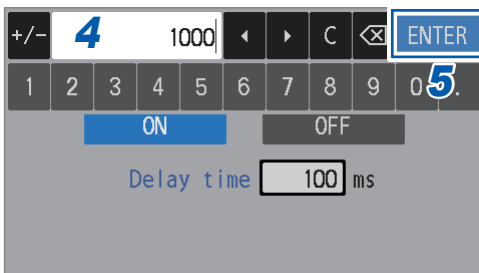

4 Use the numerical keypad to enter the trigger delay time.

You can enter in increments of 1 ms.

0 to 10000

5 Tap [ENTER] to confirm.

4.3 Averaging Measured Values

The instrument averages measured values obtained from a predefined number of measurements and then displays the result. It can average measured values of resistance, DC voltage, and route-resistance measurements. This capability can be used to reduce the variation in measured values. The number of measurements can be defined between 1 and 256.

With the internal trigger setting, the moving average is employed if the trigger-reception continuation mode is on, while the simple average is employed if the mode is off. The moving average is employed with the external trigger setting.

[MENU] > [MEAS]

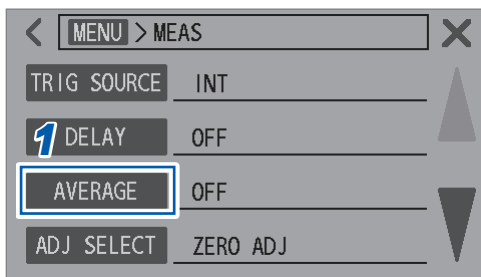

1 Tap [AVERAGE].

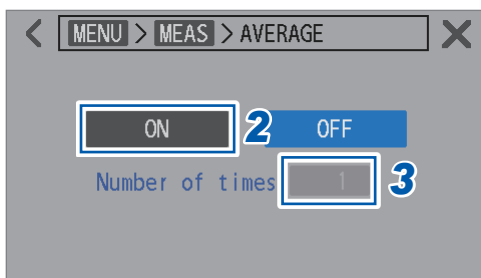

2 Tap [ON].

3 Tap the [Number of times] box.

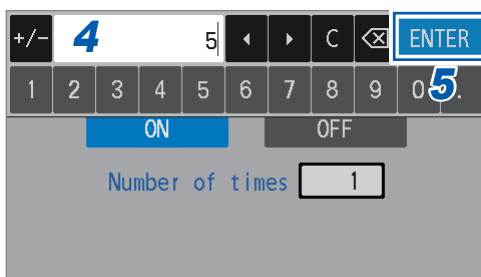

4 Use the numerical keypad to enter the number of averaging.

1 to 256

5 Tap [ENTER] to confirm.

4

Advanced Measurement

Timing at which averaging operation is initialized

- Initialized when measurement conditions are changed.
For instance, when an overrange occurs or when ranges are switched between.
- Initialized after the instrument returns to normal in case of measurement error.
For instance, when an wire break is detected.
With the ΩV measuring function, the average operation is initialized after both the Ω and V measurements return to normal.
See “Features of the contact check (wire-break detection)” (p.77).

On-screen readings

For internally triggered measurements, if the trigger-reception continuation mode is on, measured values are displayed even before the measurement counts reach the predefined number. If the trigger-reception continuation mode is off, measured values are displayed when the measurement counts reach the predefined number.

For externally triggered measurements, measured values are displayed when the measurement counts reach the predefined number.

See “4.1 Starting Measurements With Triggers” (p.87).

4.4 Reducing Mutual Interference During Resistance Measurement (Working in MIR Mode)

Mutual interference reduction (MIR) mode can be used to reduce the effect of mutual interference when two instruments are used simultaneously at close distances.

MIR stands for *mutual interference reduction*.

See “14.7 Effect of Mutual Interference” (p.238).

In MIR mode, the first (primary) instrument and the second (secondary) instrument are distinguished according to the setting. In order to cancel the effect of mutual interference, the secondary instrument reverses the phase of measurement currents on the way. The sampling speed, DC-voltage self-calibration, and line-frequency settings are required to match between two instruments.

While an instrument is making measurements in MIR mode, ensure that the contact condition of the other instrument does not change, such as through channel switching of a scanner. Failure to do so can lead to incomplete cancellation of mutual interference.

Configuration by tapping the touchscreen

[MENU] > [MEAS]

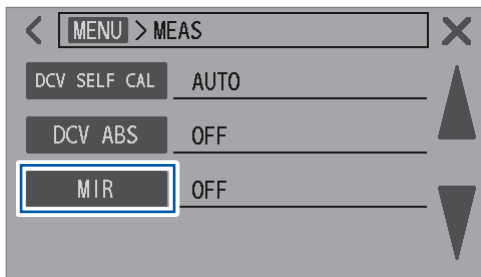

1 Tap [MIR].

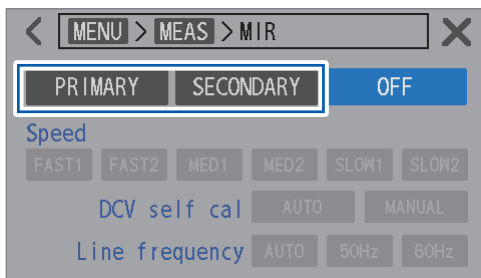

2 Use the primary instrument to tap [PRIMARY].
Use the secondary instrument to tap [SECONDARY].

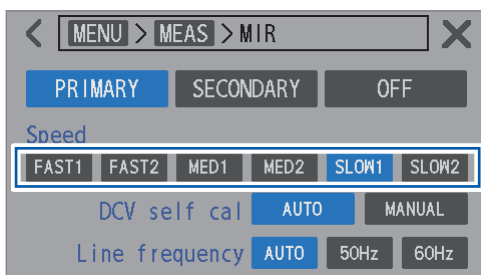

3 Select a sampling-speed setting.

FAST1, FAST2, MED1, MED2, SLOW1[□], SLOW2

Configure the same setting for the primary and secondary instruments.

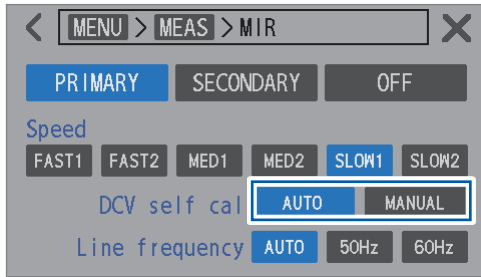

4 Select a DC-voltage self-calibration setting.

AUTO[☑], MANUAL

Configure the same setting for the primary and secondary instruments.

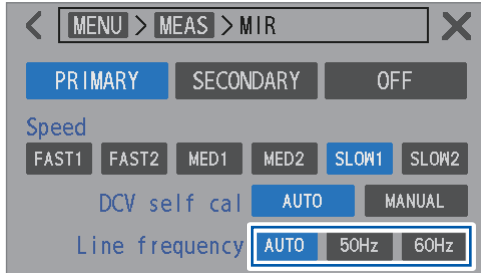

5 Select a line-frequency setting.

AUTO[☑], 50Hz, 60Hz

Configure the same setting for the primary and secondary instruments.

4.5 Displaying Measured Values as Zero

When measured values of resistance and DC voltage fall within the zero-display range, they can be forcibly treated as zero.

Zero-display range

Resistance

Range	High resolution	
	Off	On
3 mΩ (300 mA)	±0.1 μΩ	±0.08 μΩ
3 mΩ (100 mA)	±0.5 μΩ	±0.50 μΩ
30 mΩ	±1 μΩ	±0.5 μΩ
300 mΩ	±10 μΩ	±5 μΩ
3 Ω	±100 μΩ	±50 μΩ
30 Ω	±1 mΩ	±0.5 mΩ

DC voltage

Range	BT6065	BT6075
10 V	±20 μV	±11 μV
100 V	±0.6 mV	±0.60 mV

The zero-display range cannot be changed.

[MENU] > [MEAS]

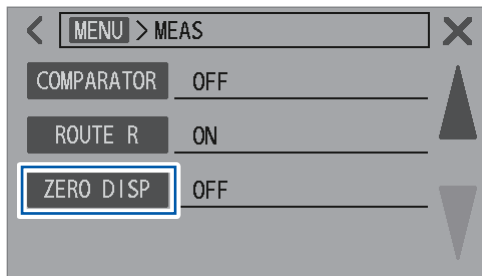

1 Tap [ZERO DISP].

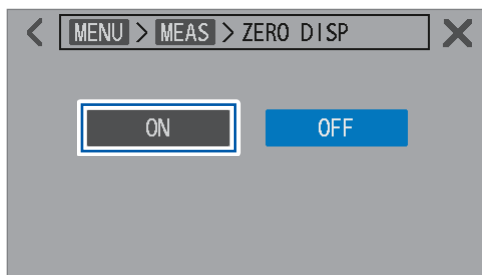

2 Tap [ON].

When measured values fall within the zero-display range, the instrument displays zero as the readings.

4.6 Converting Negative DC-Voltage Values Into Positive Values

The DC voltage absolute-value conversion capability converts negative measured values of the DC-voltage measurement by removing the negative sign.

Example: Converting -4.00000 V into 4.00000 V

By using this capability, a negative measured value obtained from an object under measurement (battery), when reversely connected to the test-lead wires, can be treated as a positive value.

[MENU] > [MEAS]

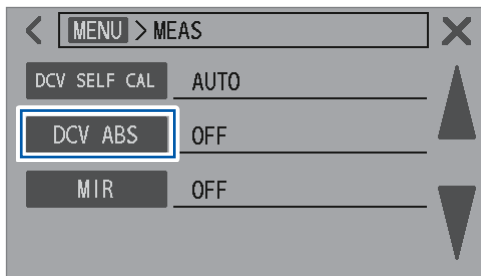

1 Tap [DCV ABS].

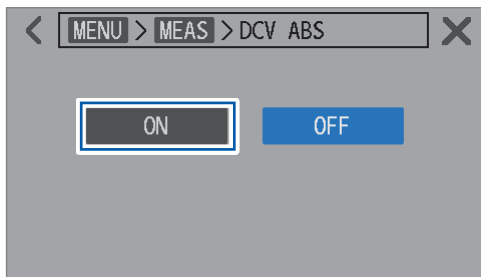

2 Tap [ON].

When measured values of the DC-voltage measurement are negative, the instrument displays the readings with the negative sign removed.

4.7 Switching Between Input Resistances

The DC input resistance*¹ of the 10 V range can be switched to high-impedance. To set the DC input resistance to high impedance, set the range to the 10 V range and the input resistance to **[HIGH Z]**. The input-resistance setting cannot be switched when the 100 V range is selected; it is fixed at the 10 MΩ setting.

*1. The internal resistance between the condition where Source Hi is connected to Sense Hi and that where Source Lo is connected to Sense Lo

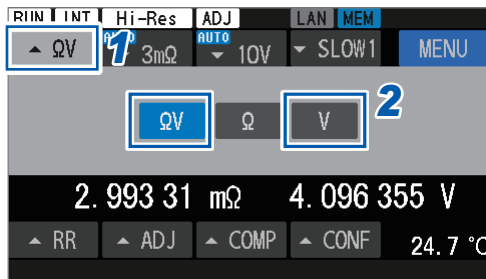

- 1 Tap the measuring function button.
- 2 Select the resistance/voltage measuring function (**[ΩV]**) or voltage measuring function.

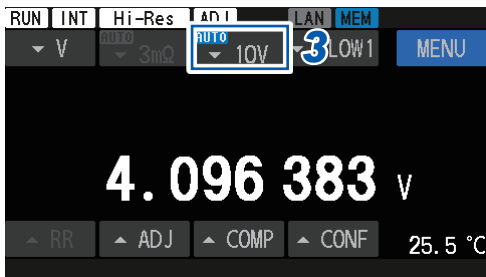

- 3 Tap the DC-voltage range button.

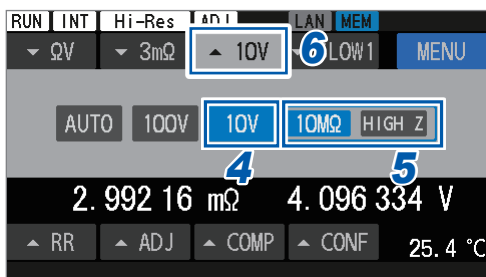

- 4 Select the 10 V range.
- 5 Select an input-resistance setting.

10MΩ[□], HIGH Z

- 6 Tap the DC-voltage range button.

The screen returns to the measurement screen.

Measuring function	10 MΩ [□]	HIGH Z
ΩV, Ω	10 MΩ ±10%	1 GΩ or more
V	10 MΩ ±10%	10 GΩ or more

When the input resistance is set to 10 MΩ, the DC-voltage measurement can be affected by the output resistance (signal-source resistance) of objects under measurement (batteries).

Example: Measurement with the 10 MΩ input-resistance setting of a coin-shaped battery with an output resistance of 1 kΩ and an open voltage of 3 V

$$\frac{10 \text{ M}\Omega}{10 \text{ M}\Omega + 1 \text{ k}\Omega} \times 3 = 2.9997 \text{ V}$$

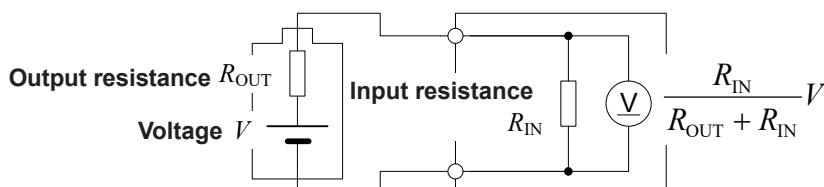

4.8 Switching Between Temperature Scales

Temperature scales can be switched between.

- 1** Tap the on-screen temperature and press the **DISPLAY** key at the same time.
- 2** Within 5 s, press the keys in the following order:
▲(Ω range) key → ▲ (Ω range) key → ▼ (Ω range) key → ▼ (Ω range) key → **DISPLAY** key
- 3** Make sure that a temperature scale is switched to another.

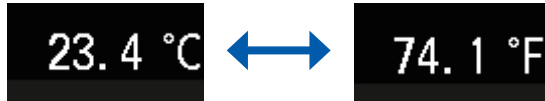

5

Comparator Capability

5.1 Judging Measured Values of Resistance and DC Voltage

The instrument employs its comparator capability to provide one of the three judgments to each measured value based on predefined upper and lower limits:
 Hi judgment (Upper limit < Measured value),
 In judgment (Lower limit ≤ Measured value ≤ Upper limit), or
 Lo judgment (Measured value < Lower limit).

Two setting methods are available: one based on upper and lower limits and the other on absolute values.

Based on upper and lower limits

The comparator capability can judge each measured value based on predefined upper and lower limits, providing a Hi, In, or Lo judgment.

Example: When the upper and lower limits are set to 4.5 V 3 V, respectively, and the measured value is 2 V

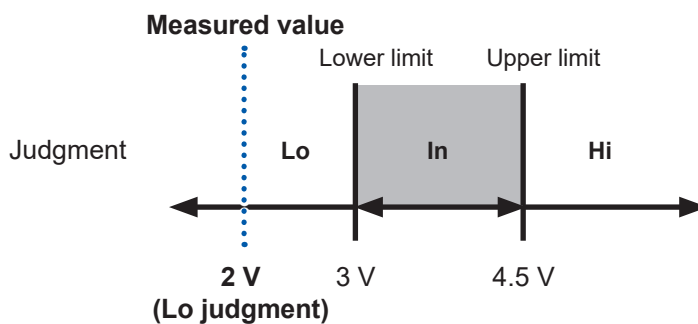

Based on absolute values (available for the DC voltage function [V] only)

The comparator capability can judge the absolute value of each measured value based on predefined upper and lower limits, providing a Hi, In, or Lo judgment.

When objects under measurement are connected to the test-lead wires in reverse polarity (positive and negative reversed), the comparator can provide a correct judgment.

Example: When the upper and lower limits are set to 4.2 V and 2.7 V, respectively, and the measured value is -3.7 V

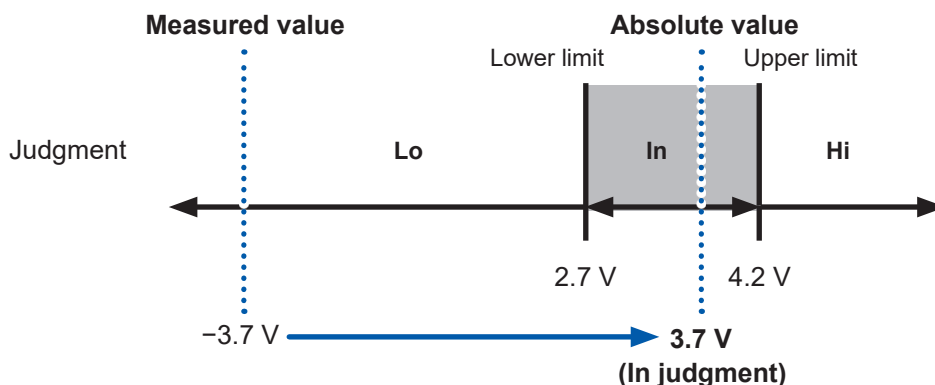

5.2 Defining the Upper and Lower Limits of the Comparator Capability

In advance, ensure to select a measuring function (p.46), resistance range (p.47), and DC-voltage range (p.50).

Turn the comparator capability on and define the upper and lower limits.

IMPORTANT

If you attempt to define the upper limit smaller than the lower limit, or the lower limit larger than the upper limit, the setting is not accepted, and the presently defined values are retained.

(Example settings)

Ω	Upper limit:	1 m Ω	Lower limit:	0.1 m Ω
V	Upper limit:	4.2 V	Lower limit:	2.7 V

[MENU] > [MEAS]

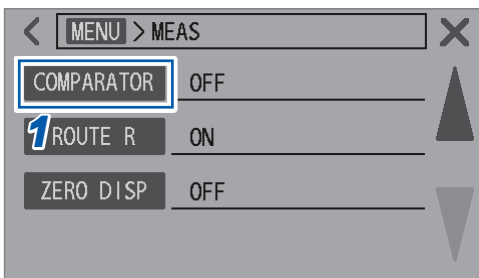

1 Tap [COMPARATOR].

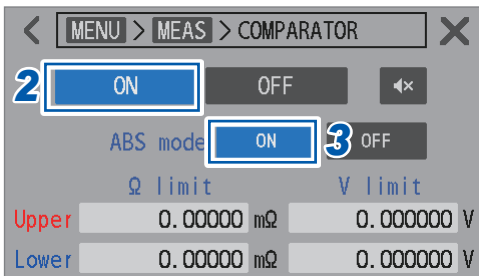

2 Tap [ON].

3 (When assessing the absolute values of measured DC voltage readings) Under [ABS mode], select [ON].

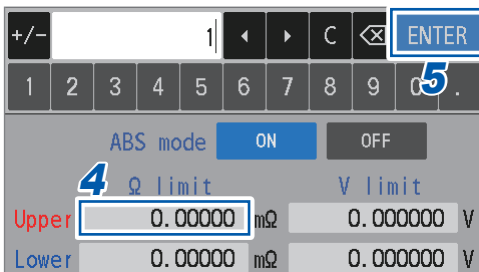

4 Under [Ω limit], tap the [Upper] box and use the numerical keypad to enter the resistance upper-limit value.

5 Tap [ENTER] to confirm.

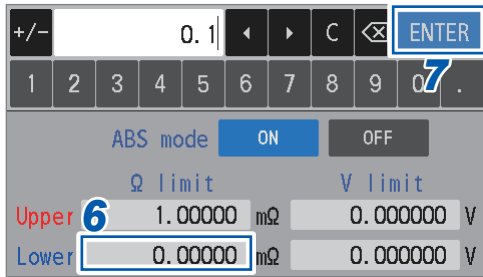

6 Under [Ω limit], tap the [Lower] box and use the numerical keypad to enter the resistance upper-limit value.

7 Tap [ENTER] to confirm.

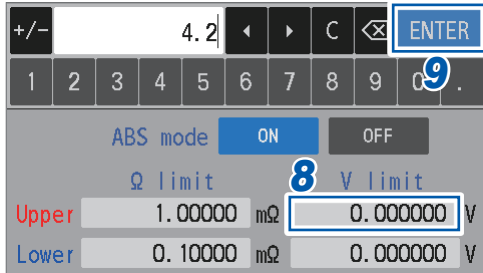

8 Under [V limit], tap the [Upper] box and with the numerical keypad to enter the voltage upper-limit value.

9 Tap [ENTER] to confirm.

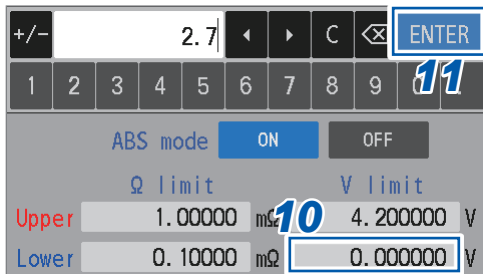

10 Under [V limit], tap the [Lower] box and use the numerical keypad to enter the resistance upper-limit value.

11 Tap [ENTER] to confirm.

Valid setting range

R	-1000.00000 m Ω to 51000.00000 m Ω
V	BT6065: -120.00000 V to 120.00000 V BT6075: -120.00000 V to 120.00000 V
Common to all ranges	

5.3 Configuring the Sound Settings

You can select whether or not the measurement-result judgment sound is generated.

See “Buzzer settings” (p. 197).

See “6.1 Configuring the Operation-Feedback Sound Setting” (p. 109) for details about the key-press sound setting.

[MENU] > [MEAS]

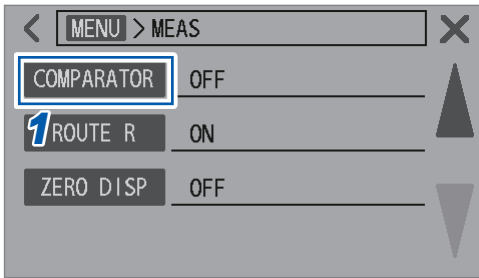

1 Tap [COMPARATOR].

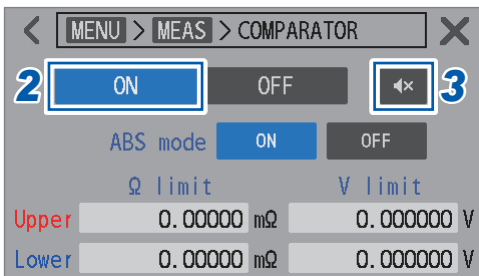

2 Tap [ON].

3 Tap the buzzer icon.

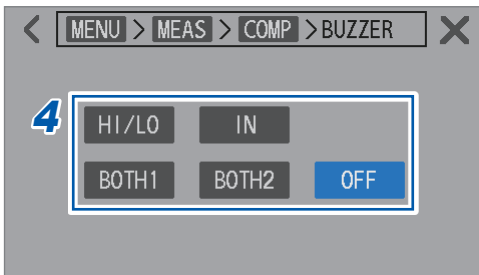

4 Configure the sound settings.

HI/LO	Intermittent tones sound when a [Hi], [Lo], or [--] (impossible to judge, such as break detection) judgment is provided for either resistance or DC-voltage measurement.
IN	A continuous tone sounds when [In] judgments are provided for both resistance and DC-voltage measurements.
BOTH1	A continuous tone sounds when [In] judgments are provided for both resistance and DC-voltage measurements. Intermittent tones sound when a [Hi], [Lo], or [--] judgment is provided for either resistance or DC-voltage measurements.
BOTH2	A short single tone sounds when [In] judgments are provided for both resistance and DC-voltage measurements. Intermittent tones sound when a [Hi], [Lo], or [--] judgment is provided for either resistance or DC-voltage measurement.
OFF 	No sound is generated.

5.4 Configuring the Comparator Settings for the Route-Resistance Monitor

You can configure the comparator for route-resistance measurement results. To configure the comparator, turn the route-resistance judgment capability on and enter the judgment thresholds. There are two types of thresholds to define: warning and fail. If measured values of the route resistance exceeds the warning threshold, the measured resistance and voltage values are displayed as normal. If measured values of the route resistance exceeds the fail threshold, the comparator issues a measurement error, and resistance and voltage readings are not displayed. See “13.4 On-Screen Errors” (p.218) for measurement errors. Judgments are performed on each of the four terminals.

Display when the threshold is exceeded

Type	Route resistance	Resistance	Voltage (with the ΩV function)
Warning	Orange	Normal	Normal
Fail	Red	Error (-----)	Error (-----)

When the measured value exceeds the warning threshold

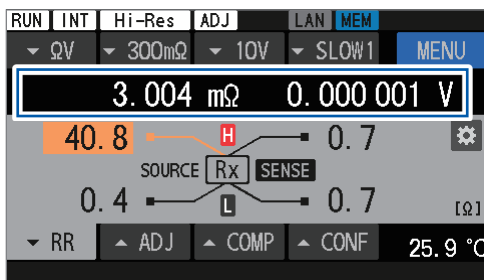

When the measured value exceeds the fail threshold

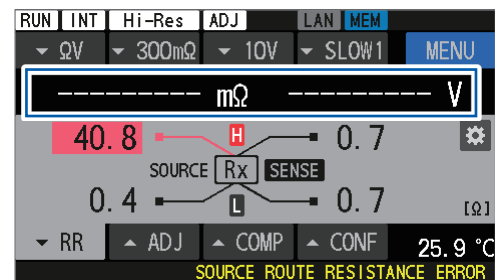

5

Comparator Capability

Defining judgment thresholds

[MENU] > [MEAS]

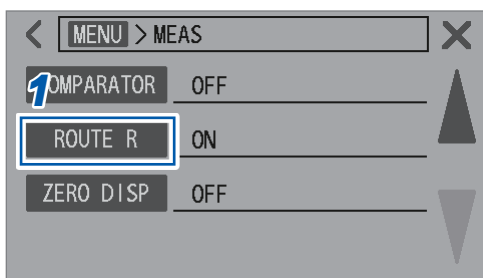

1 Tap [ROUTE R].

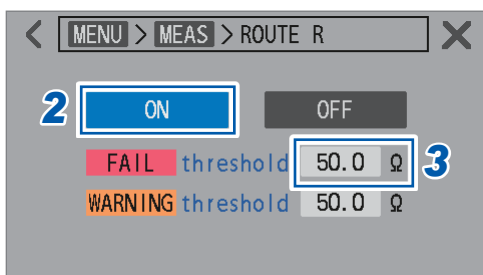

2 Tap [ON] to turn the route-resistance judgment capability on.

3 Tap the [FAIL threshold] box.

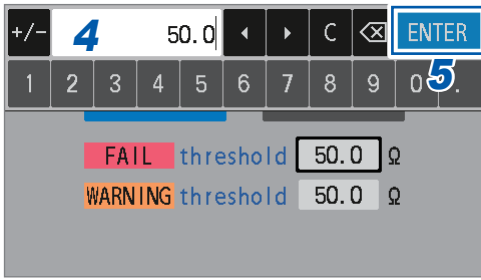

4 Use the numerical keypad to enter the fail threshold.

See “Threshold setting range” (p.104).

5 Tap [ENTER] to confirm.

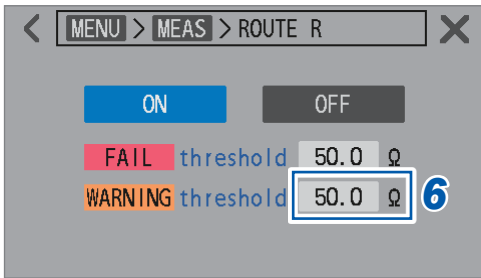

6 Tap the [WARNING threshold] box.

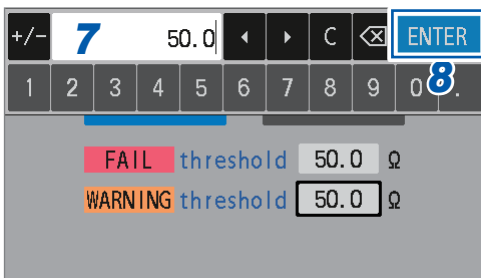

7 Use the numerical keypad to enter the warning threshold.

See “Threshold setting range” (p.104).

Define the value so that the warning threshold is less than or equal to the fail threshold.

8 Tap [ENTER] to confirm.

Threshold setting range

Resistance range	Resistance measurement current	Between Source Hi and the object under measurement (battery)	Between Sense Hi and the object under measurement (battery)
		Between Source Lo and the object under measurement (battery)	Between Sense Lo and the object under measurement (battery)
3 mΩ	300 mA	-10.0 Ω to 50.0 Ω [□] (Measurement is limited up to 10.0 Ω)	
	100 mA		
30 mΩ	100 mA		
300 mΩ	10 mA	-10.0 Ω to 50.0 Ω [□]	
3 Ω	1 mA		
30 Ω	100 μA		

5.5 Checking Judgment Results

Measured values of resistance measurement, voltage measurement, and route-resistance measurement are judged independently. The results of each judgment are displayed on the screen. However, depending on the route resistance value, the instrument may display [-----] instead of readings of the resistance and voltage measurements, indicating a measurement error.

Judgment operation (on measured resistance and voltage values)

The comparator compares each measured value with the predefined upper and lower limits to determine its range. Values of the resistance and voltage measurements are judged independently. For DC-voltage measurement with the absolute-value judgment capability on, the comparator compares the absolute values of DC voltage measured values with the upper and lower limits. See "5.2 Defining the Upper and Lower Limits of the Comparator Capability" (p.100)to configure this capability.

Hi	When the measured value is more than the predefined upper limit
In	When the measured value is less than or equal to the predefined upper limit but more than or equal to the predefined lower limit
Lo	When the measured value is less than the predefined lower limit

When the absolute-value judgment capability is on (example: when both the upper and lower limits are positive)

Upper and lower limits

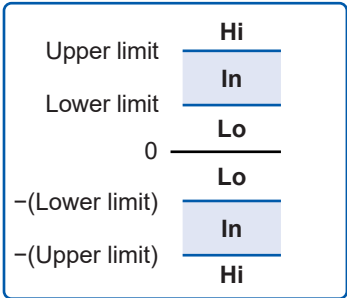

When the following condition is met, an In judgment is provided.
Lower limit ≤ |Measured value| ≤ Upper limit

Example of on-display judgment results

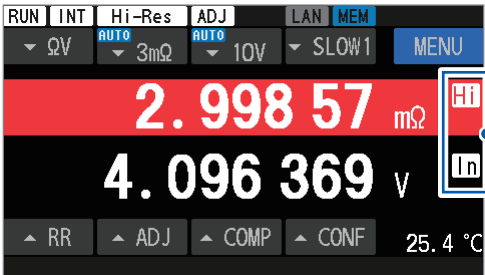

Judgment result
The background turns red for a Hi judgment and blue for a Lo judgment.

Measurement abnormal values are judged as follows: No judgment is made when the comparator function is off.

Message	Judgment
-----	No judgment is made.
+OVER	Hi (Exceeds the measurement range)
-OVER	Lo (Less than the measurement range)

Judgment operation (on measured route-resistance value)

The comparator compares each measured value with the predefined fail and warning thresholds to determine its range.

However, Pass judgments are not displayed.

Fail	When the measured value is more than the predefined fail threshold.
Warning	When the measured value is less than or equal to the predefined fail threshold but more than or equal to the warning threshold
Pass	When the measured value is less than the predefined warning threshold

Example of on-display judgment results

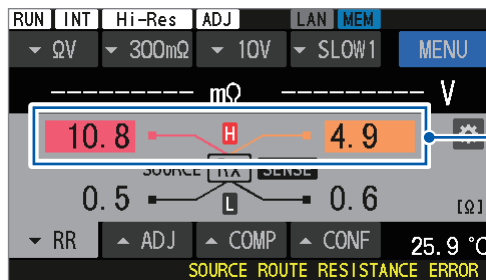

Judgment result

The background turns red for a Fail judgment and blue for a Warning judgment.

No judgment is made under the following conditions:

- When [-----] is displayed
- When [+OVER] or [- OVER] is displayed
- When the route-resistance judgment capability is off

Externally outputting Pass/Fail judgments

The following judgment results can be output from the external I/O connector.

- Judgment on resistance values (Hi, In, or Lo)
- Judgment on voltage values (Hi, In, or Lo)
- Judgment on route resistance (Pass, Warning, or Fail)
- Overall Judgment 1 (Pass or Fail)
- Overall Judgment 2 (Pass or Fail)

Overall Judgment 1 is output when the comparator capability is on. When In judgments are provided for resistance and voltage, a Pass judgment is provided to the corresponding object under measurement (battery) as Overall Judgment 1. Otherwise, a Fail judgment is provided.

Overall Judgment 2 is output when both the comparator and route-resistance judgment capabilities are on.

When a Pass judgment is provided as Overall Judgment 1, and a Pass or Warning judgment is provided for route-resistance measurement, a Pass judgment is provided to the corresponding object under measurement (battery) as Overall Judgment 2. Otherwise, a Fail judgment is provided.

See "Output signals" (p.132).

Overall Judgment 1 (resistance and voltage)

ΩV function		Voltage value judgment			
		No judgment	Hi	In	Lo
Resistance value judgment	No judgment	Fail	Fail	Fail	Fail
	Hi	Fail	Fail	Fail	Fail
	In	Fail	Fail	Pass	Fail
	Lo	Fail	Fail	Fail	Fail

Ω function		Judgment result
Resistance value judgment	No judgment	Fail
	Hi	Fail
	In	Pass
	Lo	Fail

V function		Judgment result
Voltage value judgment	No judgment	Fail
	Hi	Fail
	In	Pass
	Lo	Fail

Overall Judgment 2 (resistance, voltage, and route resistance)

ΩV and Ω functions		Route resistance judgment			
		No judgment	Pass	Warning	Fail
Overall Judgment 1	Fail	Fail	Fail	Fail	Fail
	Pass	Fail	Pass	Pass	Fail

V function		Judgment result
Overall Judgment 1	Fail	Fail
	Pass	Pass

6

Configuring System Settings

The instrument can automatically retain various settings (automatic setting backup). When turned on again, the instrument loads retained settings.

6.1 Configuring the Operation-Feedback Sound Setting

You can customize the sound preference for operating the instrument.

For more information about how to set the comparator judgment tone, see “5.3 Configuring the Sound Settings” (p. 102).

[MENU] > [SYSTEM]

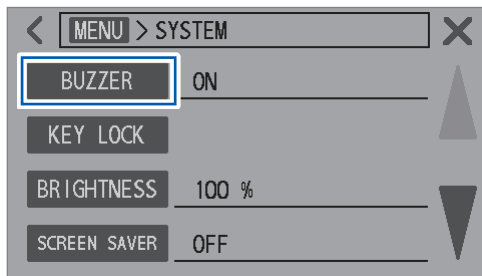

1 Tap [BUZZER].

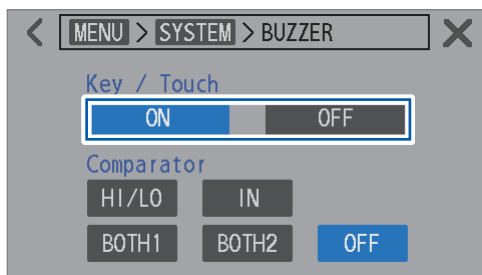

2 Select an operation-feedback sound preference.

ON , OFF

6

6.2 Adjusting the Backlight Brightness

You can adjust the screen brightness to conform to your environment.

[MENU] > [SYSTEM]

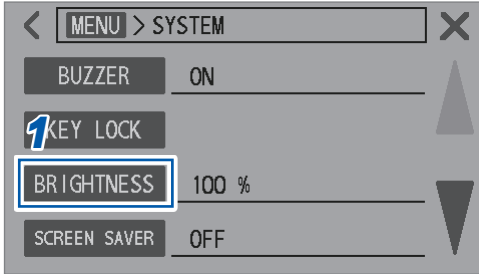

1 Tap [BRIGHTNESS].

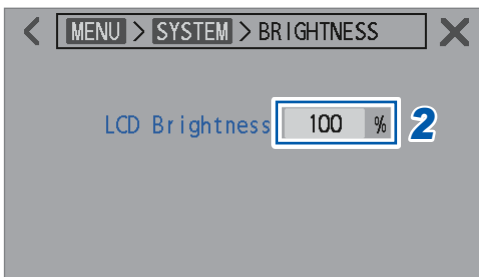

2 Tap the [LCD Brightness] box.

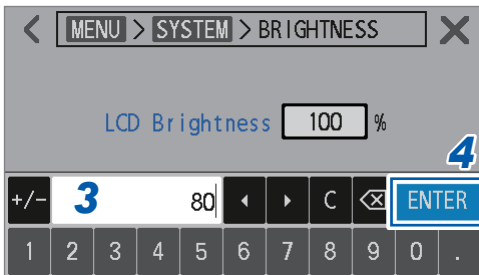

3 Use the numerical keypad to enter the backlight-brightness level.

0 to 100%

4 Tap [ENTER] to confirm.

6.3 Configuring the Screen Saver Settings

This capability allows the instrument screen to automatically dim after a certain period of inactivity.

[MENU] > [SYSTEM]

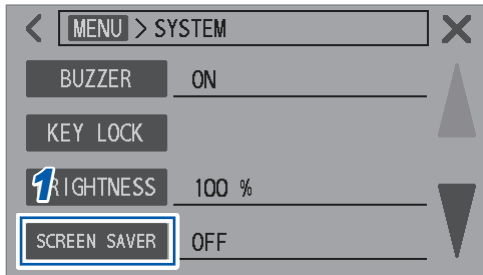

1 Tap [SCREEN SAVER].

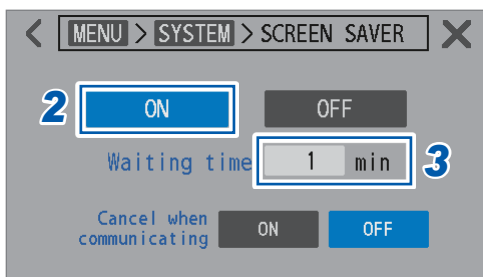

2 Tap [ON] to turn the screen saver on.



3 Tap the [Waiting time] box.

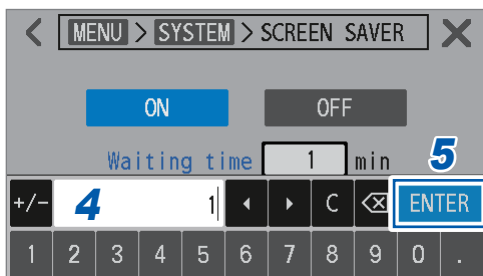

4 Set the time until the screen dims.

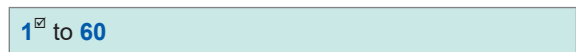

5 Tap [ENTER] to confirm.

The screen dims after the predefined time of inactivity. To recover, press any key or tap the touchscreen.

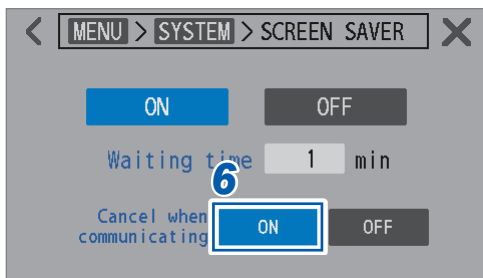

6 (To configure communication-triggered deactivation for screen saver)

Select [ON] of [Cancel when communicating].

6

6.4 Configuring the Key Lock Setting

This section describes how to deactivate the physical-key and touchscreen operation of the instrument.

The **TRIGGER** key functions even during key lock activation.

[MENU] > [SYSTEM]

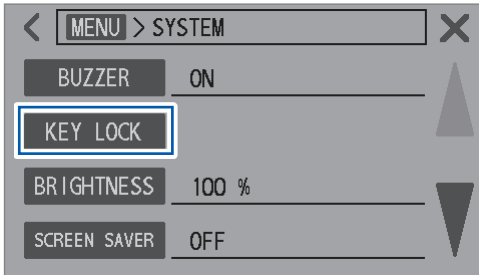

1 Tap [KEY LOCK].

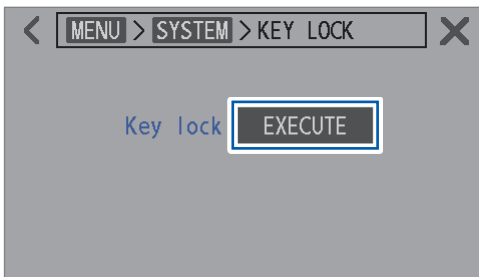

2 Tap [EXECUTE].

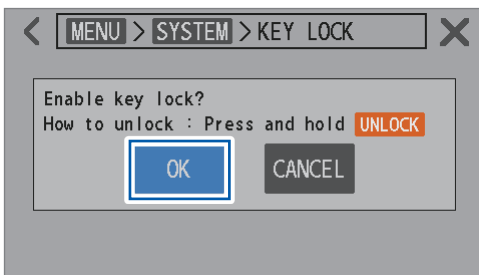

3 Tap [OK].

Tapping [CANCEL] allows the screen to revert to the prior display without activating the key lock.

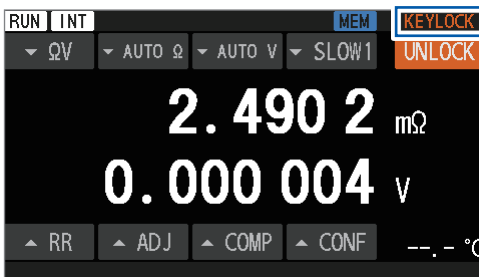

During key lock activation, [KEYLOCK] is displayed in the top right corner of the screen.

To deactivate the key lock

Touch and hold [UNLOCK] in the top right corner of the screen for at least 1 s.

Turning on the KEY_LOCK signal of the external I/O (short-circuiting the KEY_LOCK and ISO_COM pins) can activate the key lock. The key lock cannot be deactivate by tapping [UNLOCK] on the touchscreen. Open-circuiting the KEY_LOCK and ISO_COM pins can deactivate the key lock.

6.5 Calibrating the Touchscreen

This section describes how to calibrate the touchscreen, adjusting and optimizing accuracy of its interface.

[MENU] > [SYSTEM]

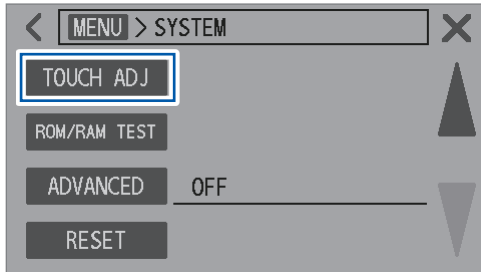

1 Tap [TOUCH ADJ].

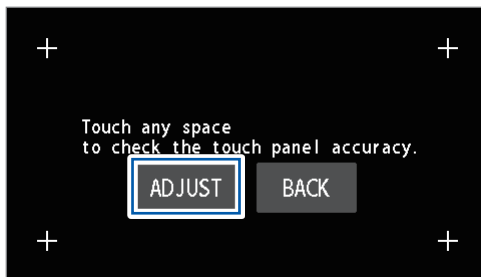

On this screen, yellow cross appear where the screen identifies your touch input. Use these crosses to check the discrepancy of the touched positions.

(To calibrate the touchscreen)

2 Tap [ADJUST].

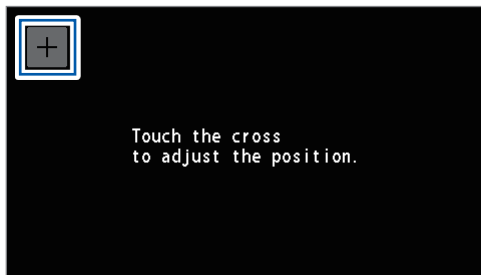

3 Tap the intersection of the upper-left cross mark.



4 Tap the intersection of the bottom-right cross mark.

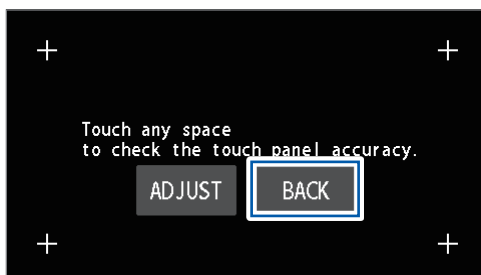

5 Tap any point to check for inaccuracies in the tapped position.

6 Tap [BACK].

The screen reverts to the prior display.

6.6 Selecting On-Screen Colors for Measured Values and the Background

This section describes how to change the colors of on-screen resistance and voltage readings. You can also change the screen background color.

[MENU] > [SYSTEM]

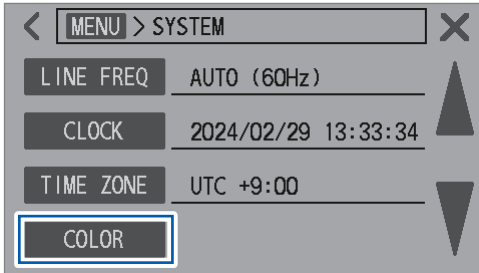

1 Tap [COLOR].

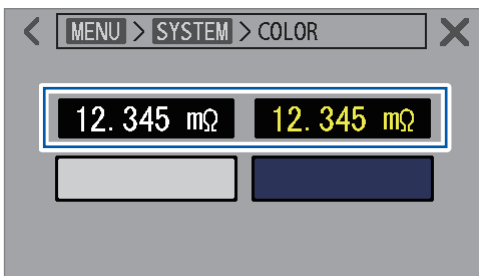

2 Tap the reading-color button you want to choose.

The color of readings displayed on the screen changes.

White[□], yellow

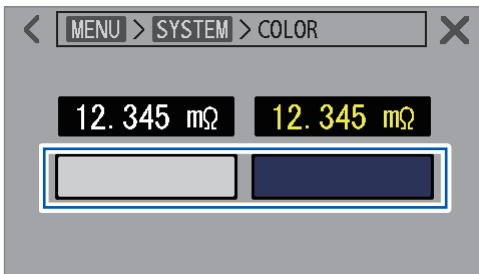

3 Tap the background-color button you want to choose.

The background color of the screen changes.

6.7 Checking the ROM and RAM for Proper Operation

This section describes how to check the internal ROM and RAM for proper operation. The screen may flicker during testing. This is not a malfunction. Perform a full test when the instrument operation becomes unstable (a full test is not usually required).

[MENU] > [SYSTEM]

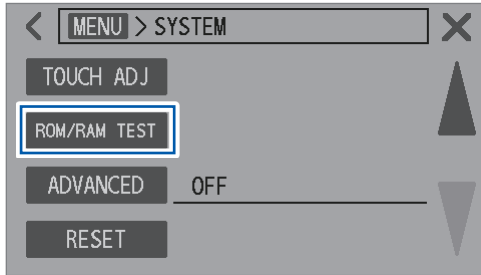

1 Tap [ROM/RAM TEST].

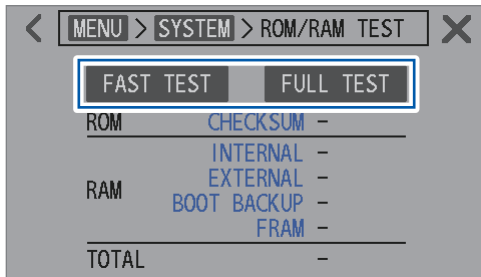

2 Tap [FAST TEST] or [FULL TEST].

FAST TEST	Required time: About 30 s
FULL TEST	Required time: About 10 minutes

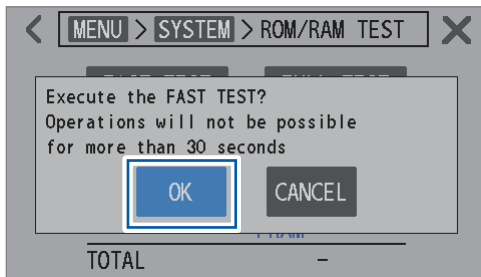

3 Tap [OK].

Tap [CANCEL] to revert to the prior display without resetting the instrument.

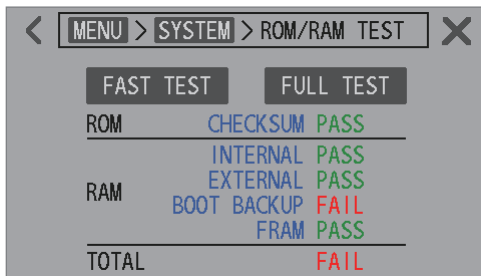

Once the test is completed, the test result is displayed.

PASS	ROM and RAM operate properly.
FAIL	ROM or RAM does not operate properly.

IMPORTANT

- The instrument cannot be operated during the ROM/RAM test.
- If [FAIL] is displayed as the test result, the instrument requires repair. Contact your authorized Hioki distributor or reseller.
- When upgrading the version of the firmware, turn the instrument off and on again, and then perform a ROM/RAM test.

6.8 Checking Reactance (X) of Objects Under Measurement and Wiring Layout

In advanced mode, the instrument allows you to observe the reactance (X) and impedance (Z) at each resistance measuring range. These measured values comprise components attributable to both objects under measurement (batteries) and the wiring layout of a test lead.

The value of the reactance (X) indicates the size of loop areas formed by test-lead branch wires. Large loop areas formed by these wires make the instrument more susceptible to the effects of electromagnetic induction and noise. Excessively large loop areas formed by these wires can result in an overflow error, rendering measurements impossible.

Arrange the test lead to minimize the value of the reactance (X), thereby preventing unmeasurable problems and ensuring a stable inspection system.

See “14.6 Effects of Electromagnetic Induction and Eddy Currents” (p.234).

[MENU] > [SYSTEM]

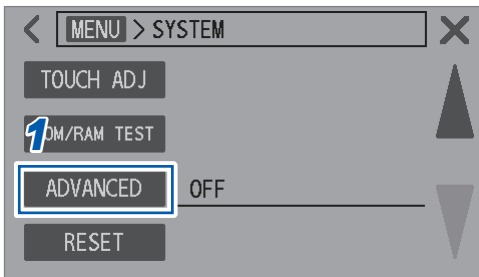

1 Tap [ADVANCED].

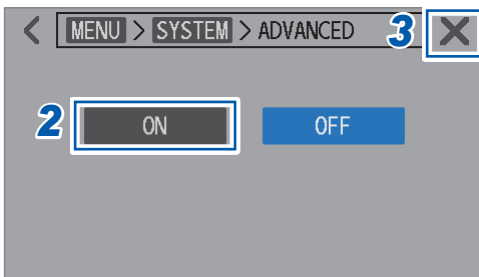

2 Tap [ON].

3 Tap [X] in the upper right corner of the screen.

The [▲ADV] tab is displayed on the measurement screen.

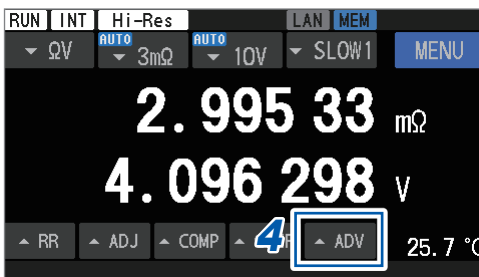

4 Tap [▲ADV].

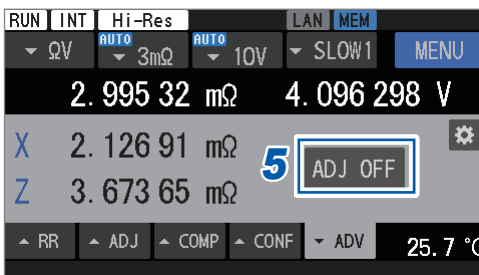

The reactance (X) and impedance (Z) of the object under measurement are displayed.

5 Tap [ADJ OFF] to turn the adjustment off.

Ensure that no adjustment is applied to check the reactance (X) and impedance (Z) values resulting from the test lead arrangement.

6.9 Resetting the Instrument

Two ways are available to reset the instrument.

<p>Normal reset</p>	<p>The settings, except the following, are reverted to their factory default: Date and time; time zone; LAN, RS-232C, and USB function settings; saved panel data; adjustment values; calibration values; and temperature scale</p> <p>The following ways are available:</p> <ul style="list-style-type: none"> • Using the [SYSTEM] screen to perform a normal reset • Using a communications command to perform a normal reset
<p>System reset</p>	<p>The settings, except the following, are reverted to their factory default: Date and time, time zone, calibration values, and temperature scale However, the LAN, RS-232C, and USB settings are retained when a system reset is performed by sending a command.</p> <p>The following way is available.</p> <ul style="list-style-type: none"> • Using the [SYSTEM] screen to perform a system reset

To reset the instrument using a communications command, see Communications Command Instruction Manual.

This section describes how to reset the instrument using the **[SYSTEM]** screen.

[MENU] > [SYSTEM]

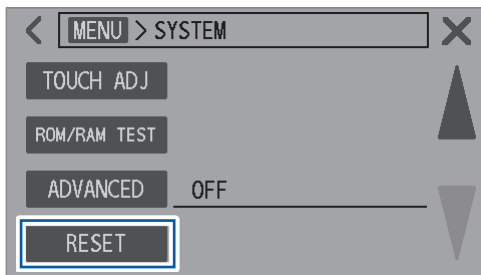

1 Tap **[RESET]**.

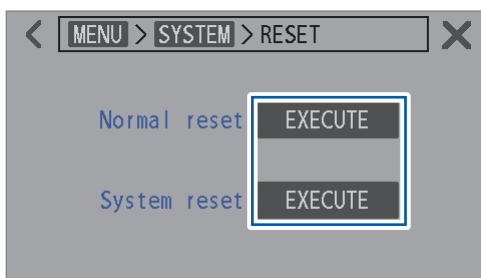

2 Choose between **[Normal reset]** and **[System reset]**, then tap **[EXECUTE]**.

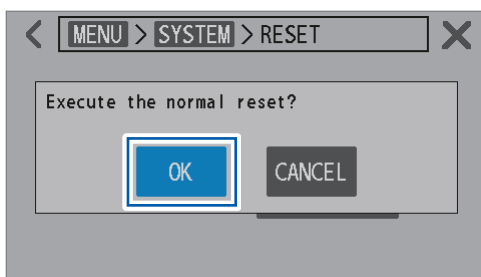

3 Tap **[OK]**.

The instrument is reset.

Once the reset is completed, the measurement screen is displayed.

Tap **[CANCEL]** to revert to the prior display without resetting the instrument.

Default settings and settings to be reverted to the default

The following table reflects the factory default settings.

✓: Reverted, –: Non-reverted

Setting item		Default setting	Normal reset	System reset
Measuring function		Ω V	✓	✓
Range switching		Auto	✓	✓
Measurement current (3 m Ω range)		300 mA	✓	✓
DC input resistance (10 V range setting)		10 M Ω	✓	✓
Temperature scale		Celsius ($^{\circ}$ C)	–	–
High resolution mode setting		On	✓	✓
Sampling speed		Slow1	✓	✓
Trigger	Source	Internal	✓	✓
	Reception continuation mode	On (When returning to the local state or being turned off then on again, the instrument resets the trigger-reception continuation mode to <i>On</i> .)		
	Delay setting	Off		
	Delay time	0 ms		
Averaging	Setting	Off	✓	✓
	Number of times	1		
DC-voltage self-calibration		Auto	✓	✓
Zero-display		Off	✓	✓
DC voltage-to-absolute value conversion		Off	✓	✓
Adjustment	Type	Zero adjustment	–	✓
Zero adjustment	Channel mode	Single-channel	–	✓
	Target channel setting (Start)	1		
	Target channel setting (End)	1		
Referential adjustment	Channel mode	Multi-channel	–	✓
	Target channel setting (Start)	1		
	Target channel setting (End)	1		
Route-resistance monitor	Judgment	On	✓	✓
	Fail-judgment threshold	50.0 Ω		
	Warning-judgment threshold	50.0 Ω		
Resistance-measurement MIR mode	Setting	Off	✓	✓
	Type	Primary		
Line-frequency setting		Auto	✓	✓

Setting item		Default setting	Normal reset	System reset
Batch transmission of measured values (memory)		Off	✓	✓
Measured-value output		Off	–	✓*1
Measured-value format		Range fix	✓	✓
Operation-feedback sound		On	✓	✓
Date and time		2022/1/1 00:00:00 (YYYY/MM/DD hh:mm:ss)	–	–
Time zone		UTC+00:00	–	–
Key lock		Off	✓	✓
External I/O lock		Off	✓	✓
Comparator	Setting	Off	✓	✓
	Upper and lower limits of resistance	0 Ω		
	Upper and lower limits of DC voltage	0 V		
	DC voltage absolute-value judgment	Off		
	Buzzer setting	Off See “Buzzer settings” (p.197).		
Panel	Data	None	–	✓
	Panel name	PANEL1, PANEL2, PANEL3, PANEL4, PANEL5, PANEL6		
Backlight-brightness adjustment		100%	✓	✓
Screen saver	Setting	Off	✓	✓
	Time	1 min.		
	Communication-triggered deactivation	Off		
Measured-value color change		White	✓	✓
External I/O TRIG-signal input filter	Setting	Off	✓	✓
	Time	50 ms		
External I/O EOM-signal output format	Setting	Hold	✓	✓
	Pulse width	5 ms		
External I/O ERR-signal output timing		Asynchronous (Async)	✓	✓

Resetting the Instrument

Setting item		Default setting	Normal reset	System reset
Interface		LAN	–	✓*1
USB	Mode	COM mode	–	✓*1
LAN	IP address	192.168.1.1	–	✓*1
	Subnet mask	255.255.255.0		
	Default gateway	0.0.0.0		
	Port number	23		
RS-232C	Baud rate	9600 bps	–	✓*1
BT3562A command compatibility mode		Off (non-upward compatible)	–	✓*1
Advanced mode		Off	✓	✓

*1. Non-reverted settings after system reset via communications command

Saving/Loading Measurement Conditions (Panel Saving/Loading Capability)

The instrument can save the present measurement conditions in its internal memory and load them as required.

Panel saving capability	<p>The panel saving capability can be used to save the present measurement conditions.</p> <p>The instrument can save up to six sets of measurement conditions (panel number 01 to 06) and retains even after being turned off.</p> <p>Information that can be saved with the panel saving capability (p. 121)</p>
Panel loading capability	<p>The panel loading capability allows you to load measurement conditions saved through the panel saving capability, and they can be loaded using the following methods:</p> <ul style="list-style-type: none"> • By using the touchscreen • By sending a communications command from an external device • By sending a signal from an external device (using the external I/O)

Information that can be saved with the panel saving capability

Panel name (up to 10 characters, entered using the touchscreen)	DC voltage-to-absolute value conversion
Save time and date	Resistance-measurement MIR mode
Measuring function	Comparator
Auto/Manual ranging	Key lock
Measurement current setting	Measured-value batch transmission
High resolution mode	Measured-value output
Sampling speed	Measured-value format
DC-voltage self-calibration	Backlight-brightness adjustment
DC input resistance	Screen saver
Trigger	Measured-value color change
Trigger delay	Operation-feedback sound
Averaging	Command compatibility
Zero adjustment	External I/O signal settings (TRIG, EOM, and ERR)
Referential adjustment	Measurement screen configuration
Route-resistance monitor	Line-frequency setting
Zero display	Advanced mode

7.1 Saving Measurement Conditions (Panel Saving Capability)

The instrument utilizes the panel saving capability to save up to six sets of the present measurement conditions in its internal memory.

[MENU] > [PANEL]

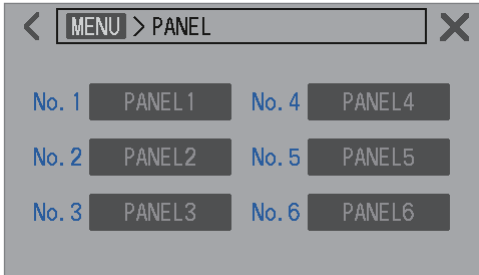

1 Select a panel number.

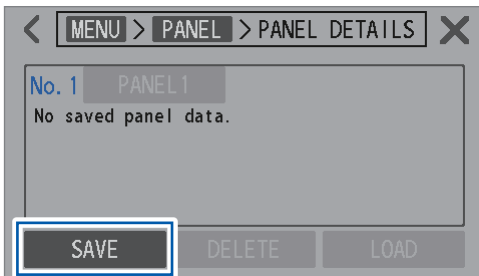

2 Tap [SAVE].

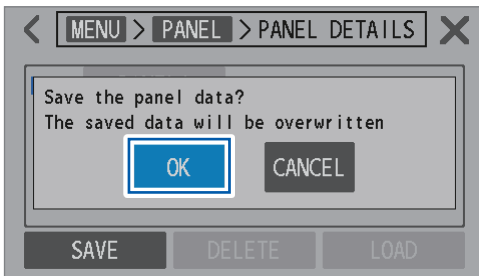

3 To overwrite the existing measurement conditions with the present ones, tap [OK].

The existing conditions are overwritten with the present ones.
Tapping [CANCEL] quits the saving process and allows the screen to revert to the prior display.

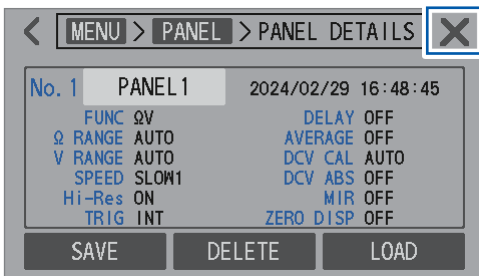

4 Tap [X] in the upper right corner of the screen.

The screen returns to the measurement screen.

7.2 Loading Measurement Conditions (Panel Loading Capability)

The instrument utilizes the panel loading capability to load panel data saved in its internal memory.

You can load panel data by following means:

- By using the touchscreen
- By sending a communications command from an external device
See “9 Controlling the Instrument via Communications” (p. 151) and Communications Command Instruction Manual.
- Sending a signal from an external device (using the external I/O)
See “8 Externally Controlling the Instrument (External I/O)” (p. 127).

This section describes how to load panel data using the touchscreen.

[MENU] > [PANEL]

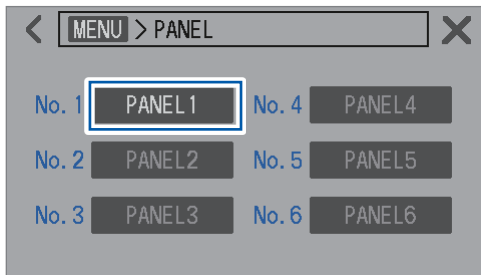

1 Select the panel data to load.

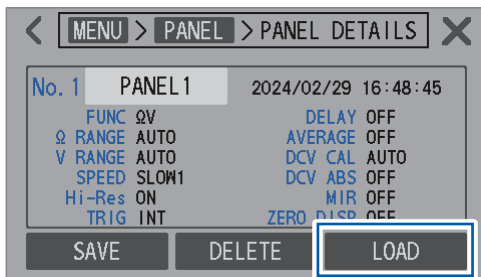

2 Tap [LOAD].

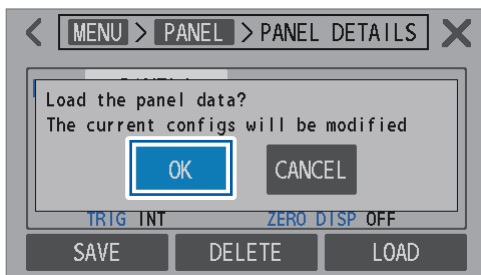

3 Tap [OK].

The settings of the loaded panel data are replaced and the screen reverts to the measurement screen. Tapping [CANCEL] allows the screen to revert to the prior display.

7.3 Changing Panel Names

You can change names of saved panels.

[MENU] > [PANEL]

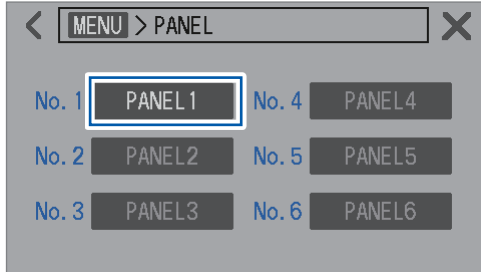

- 1 Select the panel data whose name you want to change.

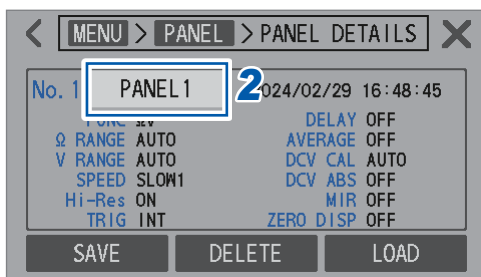

- 2 Tap the panel name.



- 3 Enter a new panel name.
The panel name should be up to 10 characters.
- 4 Tap [ENTER] to confirm.

7.4 Deleting Saved Measurement Conditions

You can delete measurement conditions saved using the panel saving capability.

IMPORTANT
Deletion of panels cannot be undone.

[MENU] > [PANEL]

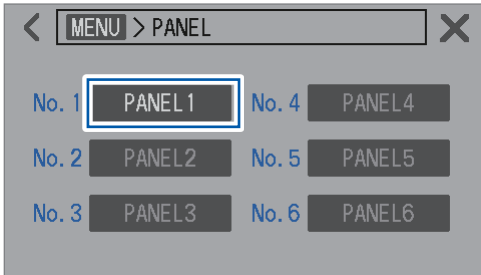

1 Select the panel data you want to delete.

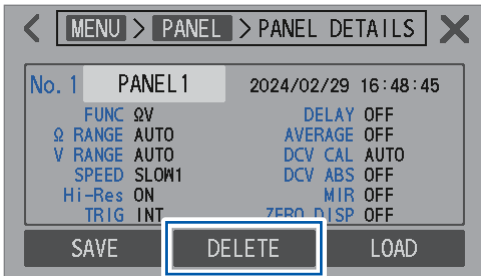

2 Tap [DELETE].

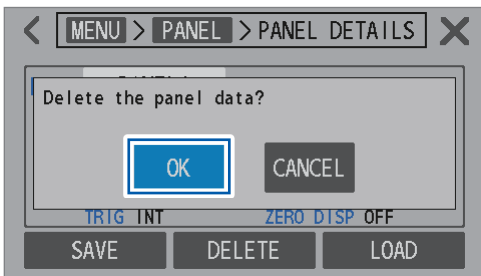

3 Tap [OK].

The selected panel data is deleted and the screen reverts to the prior display.

Tapping [CANCEL] quits deletion and allows the screen to revert to the prior display.

8

Externally Controlling the Instrument (External I/O)

You can control the instrument through the rear-mounted Ext. I/O connector. This includes outputting various signals, such as the end-of-measurement signal (EOM signal) and judgment result signals, as well as inputting various signals, like the start-of-measurement signal (TRIG signal).

All signals are isolated from the measuring circuitry and the ground (however, the input and output common pins share the same potential).

The instrument's input circuits can be switched to support programmable logic controllers with either current-sink outputs (NPN) or current-source outputs (PNP). (p. 129)

After reviewing the I/O ratings, internal circuitry, and safety precautions, connect the instrument to a control system for proper usage.

⚠ DANGER



- **Do not apply a voltage in excess of the maximum input voltage to the Ext. I/O connector.**

Doing so could damage the instrument, resulting in serious bodily injury.

⚠ WARNING



- **Do not apply externally a voltage to the Ext. I/O connector.**

The Ext. I/O connector of the instrument cannot withstand external power input. Doing so could damage the instrument.

- **When connecting devices to the Ext. I/O connector of the instrument, make sure to securely fasten the connector with screws.**

If the connector comes off and touches other conductive parts during operation, the user could experience an electric shock.



- **Before connecting cables to the Ext. I/O connector, follow the procedure below:**

1. Turn the instrument and devices to be connected off.
2. Eliminate static electricity from your body.
3. Make sure that the signals do not exceed the external input/output ratings.
4. Appropriately isolate devices to be connected from the instrument.

Failure to do so could cause the user to experience an electric shock or damage to the instrument.

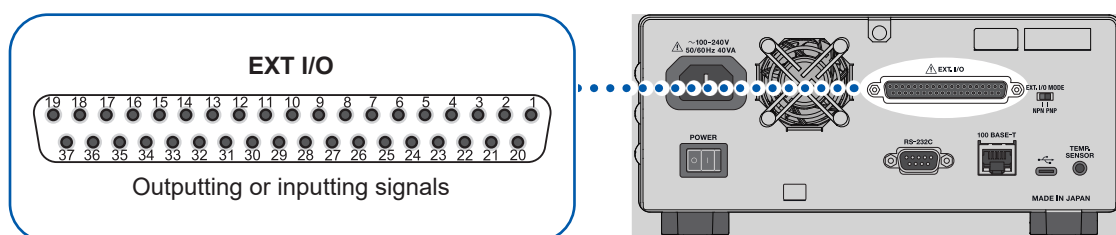

Preparations

1 Confirm the input/output specifications of controllers to be used.



2 Configure the Ext. I/O Mode switch (NPN/PNP).
(Turn the instrument off before operating)

p. 129



3 Connect the Ext. I/O connector and controllers.

p. 145



4 Configure the instrument settings.

p. 147



5 Test the inputs and outputs.

p. 150



Measurement

Connect the instrument to objects under measurement to make measurements.

8.1 External Input/Output Terminals and Signals

Switching between two I/O modes: current sinks (NPN) and current sources (PNP)

The Ext. Mode switch (NPN/PNP) can be used to switch between types of the PLC output signals the instrument supports. The instrument ships with the switch in the NPN position.

⚠ CAUTION



- After turning the instrument off, adjust the Ext. I/O Mode switch (NPN/PNP).
- Configure the NPN/PNP setting based on devices to be externally connected.
Failure to do so could damage devices connected to the Ext. I/O connector.

	Adjusting the Ext. I/O Mode switch (NPN/PNP)	
	NPN	PNP
Input circuitry	Support for PLC with sink outputs	Support for PLC with source outputs
Output circuitry	Non-polar	Non-polar
ISO_5 power output	+5 V output	-5 V output

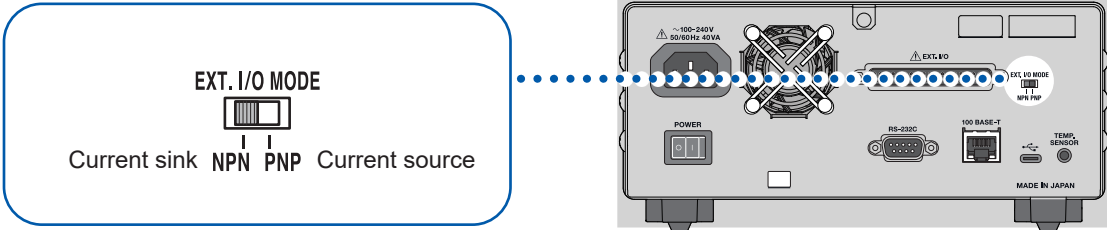

Externally Controlling the Instrument (External I/O)

Mounted connector and pin assignment

The external I/O interface can be used to control the instrument externally.

IMPORTANT
The connector shell is connected (conducts) to the metallic rear panel and the protective ground terminal of the power inlet. It is not isolated from the ground.

Mounted connector	D-sub 37-pin, socket contacts (female) Rectangular nut #4-40 screw
Compatible connectors	DC-37P-ULR (solder type) DCSP-JB37PR (crimp type) Manufactured by Japan Aviation Electronics or equivalent

See “12.4 Interface Specifications” (p.202) and “Pin assignment” (p.204).

Signal functions

Isolated power

Pin number	Signal name	Ext. I/O Mode switch (NPN/PNP) setting	
		NPN	PNP
8	ISO_5V	+5 V isolated power	-5 V isolated power
9, 27	ISO_COM	Isolated-power common	

Input signals

Pin number	Signal name	Description
1	TRIG	<p>When the TRIG signal is switched from off to on, its edge triggers the instrument to make a measurement.</p> <p>Setting [TRIG SOURCE] to [EXT] enables TRIG-signal reception. When the following capabilities are used, an input TRIG signal is accepted even when the [TRIG SOURCE] is set to [INT].</p> <ul style="list-style-type: none"> • Measured-value outputting capability • Batch transmission of measured values (memory) capability
20	0ADJ	<p>When the 0ADJ signal is switched from off to on, its edge triggers the instrument to perform a single-channel mode zero adjustment. If this signal is input during a measurement, the instrument suspends the measurement, starting a zero adjustment.</p>
21	CALIB	<p>When the CALIB signal is switched from off to on, its edge triggers the instrument to start a DC-voltage self-calibration process. If the DC-voltage self-calibration is set to [AUTO], the process is performed.</p> <p>A DC-voltage self-calibration process takes about 10 s. If this signal is input during a measurement, the instrument suspends the measurement, starting a DC-voltage self-calibration process.</p>
2	CALIB2	<p>When the CALIB2 is switched from off to on, its edge triggers the instrument to start a resistance self-calibration process.</p> <p>A resistance self-calibration process takes about 45 s. If this signal is input during a measurement, the instrument suspends the measurement, starting a resistance self-calibration process.</p>
3	KEY_LOCK	<p>When the KEY_LOCK signal is on, all physical-key operations and touchscreen operations (except the TRIGGER-key operation) are ignored.</p> <p>When the key lock has been activated through the external I/O, turn the KEY_LOCK signal off to deactivate it.</p>

Pin number	Signal name	Description																																				
22 4 23	LOAD0 LOAD1 LOAD2	<p>Selecting the desired panel number and inputting a TRIG signal cause the instrument to load the measurement conditions associated with the selected panel number and start measurements. The LOAD0 signal corresponds to the least significant bit (LSB), while the LOAD4 signal corresponds to the most significant bit (MSB). When the TRIG signal is input, no panel data is loaded if the on/off states of the LOAD0 to LOAD2 signals remain the same as the previous. In this case, the instrument with the external trigger setting treats the TRIG signal as a typical external trigger, performing a single measurement.</p> <table border="1"> <thead> <tr> <th>Panel number</th> <th>LOAD2</th> <th>LOAD1</th> <th>LOAD0</th> </tr> </thead> <tbody> <tr> <td>*1</td> <td>Off</td> <td>Off</td> <td>Off</td> </tr> <tr> <td>1</td> <td>Off</td> <td>Off</td> <td>On</td> </tr> <tr> <td>2</td> <td>Off</td> <td>On</td> <td>Off</td> </tr> <tr> <td>3</td> <td>Off</td> <td>On</td> <td>On</td> </tr> <tr> <td>4</td> <td>On</td> <td>Off</td> <td>Off</td> </tr> <tr> <td>5</td> <td>On</td> <td>Off</td> <td>On</td> </tr> <tr> <td>6</td> <td>On</td> <td>On</td> <td>Off</td> </tr> <tr> <td>*1</td> <td>On</td> <td>On</td> <td>On</td> </tr> </tbody> </table> <p>*1. When the TRIG signal is turned on and all the LOAD0 through LOAD2 signals are either turned on or off, no panel data is loaded.</p> <ul style="list-style-type: none"> • With the external trigger setting, a single measurement is made once after panel loading is completed. • With the external trigger setting, measurements are performed once after panel loading is completed. 	Panel number	LOAD2	LOAD1	LOAD0	*1	Off	Off	Off	1	Off	Off	On	2	Off	On	Off	3	Off	On	On	4	On	Off	Off	5	On	Off	On	6	On	On	Off	*1	On	On	On
Panel number	LOAD2	LOAD1	LOAD0																																			
*1	Off	Off	Off																																			
1	Off	Off	On																																			
2	Off	On	Off																																			
3	Off	On	On																																			
4	On	Off	Off																																			
5	On	Off	On																																			
6	On	On	Off																																			
*1	On	On	On																																			
5, 6, 7, 24, 25, 26	(Reserved)	Do not connect anything.																																				

Output signals

Pin number	Signal name	Description
10	ERR	<p>Turns on when a measurement error (p.77 or p.103) occurs. Choose between the following ERR-signal output timings:</p> <ul style="list-style-type: none"> • Synchronous output: Outputs this signal in sync with the EOM signal If a contact-check error or a route-resistance-monitor judgment error is detected during sampling, the ERR signal is output in sync with the EOM signal. When the ERR signal is on, all outputs of comparator judgment results for each resistance and voltage are turned off. • Synchronous output: Outputs this signal asynchronously in response to the EOM signal When a contact-check error is detected, the ERR signal is output in real time. <p>Measurement error examples (with the synchronous setting):</p> <ul style="list-style-type: none"> • A contact-check error occurs. • The route-resistance monitor provides a fail judgment. • Route resistance falls outside the measurement range of the route-resistance monitor (overrange). <p>Measurement completion example:</p> <ul style="list-style-type: none"> • Resistance or DC voltage measured value falls outside the measurement ranges(overrange).
18	PASS_1	<p>When the comparator capability is active, this signal turns on when the comparator provides In judgments for both the resistance and voltage (ΩV function). For the Ω and V functions, the same signals as the R-IN and V-IN signals are output, respectively.</p>
17	PASS_2	<p>When both the comparator capability and the route-resistance-monitor judgment capability are active, this signal turns on when the PASS_1 signal is on and the route-resistance monitor provides a Pass or Warning judgment (ΩV and Ω functions). For the V function, the route-resistance monitor does not make a judgment; thus, the same signal as the PASS_1 signal is output.</p>
37	FAIL_1	<p>When the comparator capability is active, this signal turns on when the PASS_1 signal is off.</p>
36	FAIL_2	<p>When both the comparator capability and the route-resistance-monitor judgment capability are active, this signal turns on when the PASS_2 signal is off.</p>
28	EOM	<p>Turns on once measurement is completed. When this signal turns on, the comparator judgment result and the ERR-signal output (with the synchronous output setting) have been fixed.</p>
29	INDEX	<p>Turns on when the sampling (A/D conversion) of the measurement is completed. When this signal switches from off to on, the test lead can be removed from the object under measurement (battery).</p>
30 11 12	R_IN R_HI R_LO	<p>Each signal turns on depending on the comparator judgment result for resistance. When the comparator capability is inactive, no signal is output.</p> <p>In judgment for resistance Hi judgment for resistance Lo judgment for resistance</p>

Pin number	Signal name	Description
13 31 32	V_IN V_HI V_LO	Each signal turns on depending on the comparator judgment result for voltage. When the comparator capability is inactive, no signal is output. In judgment for voltage Hi judgment for voltage Lo judgment for voltage
33 15 34	R_R_PASS R_R_WARNING R_R_FAIL	Each signal turns on depending on the route-resistance-monitor judgment result. When the route-resistance-monitor judgment capability is inactive, no signal is output. Pass judgment for route resistance Warning judgment for route resistance Fail judgment for route resistance
14, 16, 19, 35,	(Reserved)	Do not connect anything.

IMPORTANT

- The external I/O signals cannot be used during calibration processes or adjustments of the instrument.
- Turning the instrument on sets the INDEX signal back to on. The EOM signal is set back to on for the Hold setting and to off for the Pulse setting.
- When it is not necessary to switch between measurement conditions, fix all the LOAD0 through LOAD2 signals to either on or off.
- To avoid false judgments, verify the comparator judgments with signals indicating both Pass and Fail.

8.2 Timing Charts

The levels of each signal indicate the on/off status of the corresponding contact.

With the current source (PNP) setting, the voltage levels of the external pins will correspond to the signal levels illustrated in the timing charts.

With the current sink (NPN) setting, the voltage levels of the external pins will reverse from the signal levels illustrated in the timing charts, swapping high and low.

When the ERR-signal output is set to asynchronous



From starting the measurement to acquiring judgment results

(1) When the trigger source is set to [EXT], the EOM output is set to [HOLD], and the DC-voltage self-calibration is set to [AUTO]

Inputting the TRIG signal turns the EOM signal off, starting a measurement. When the measurement completes, the EOM signal turns on and remains active until the next TRIG signal is input.

See “Configuring the EOM-signal output type settings” (p. 148).

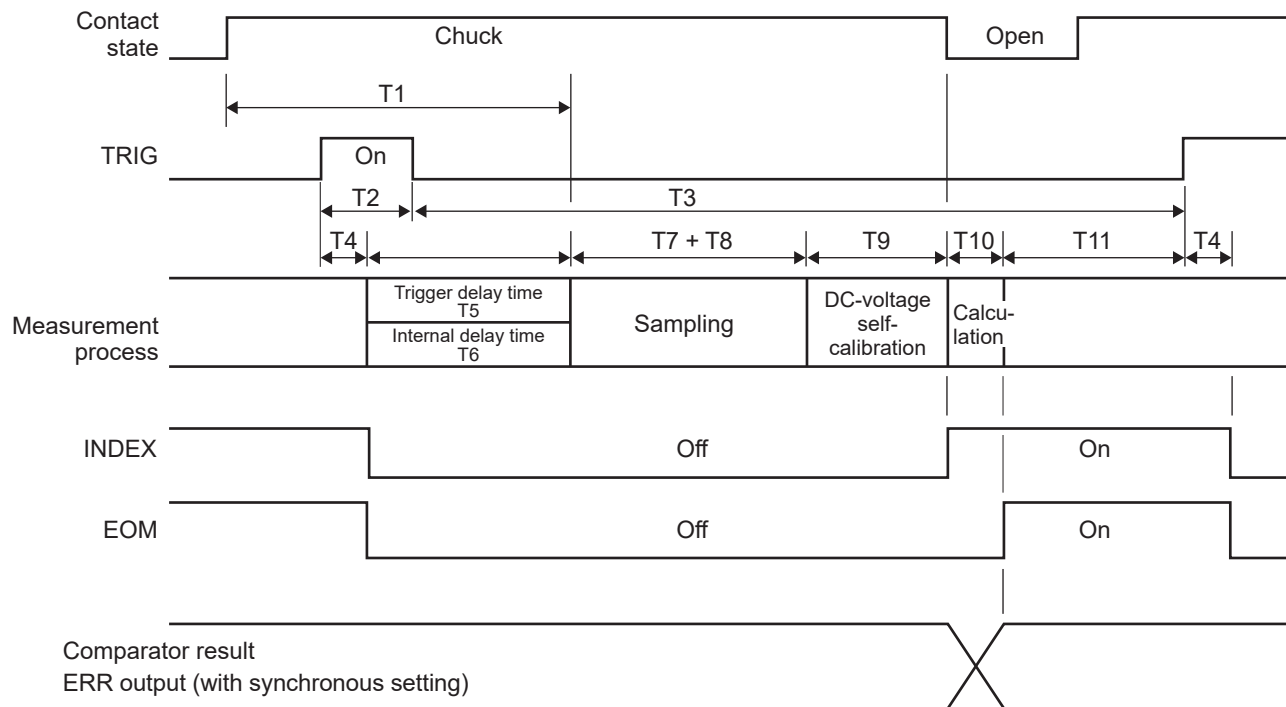

IMPORTANT

- Adjust the delay time to ensure the measurement starts approx. 8 ms or more after contacting the object under measurement (battery). Wait until measured values stabilize before starting the measurement. The delay time varies depending on the object under measurement (battery).
- TRIG signals are ignored while the EOM signal is off.
- After modifying settings, such as switching between ranges, wait for a processing time of 100 ms to elapse before inputting the TRIG signal.
- The instrument outputs the EOM signal immediately after the comparator capability provides a judgment result (Hi, In, Lo, Pass, or Fail). If the input circuitry of externally connected devices is characterized by a slow response, there may be a waiting time in accepting the judgment result after detecting the turning on of the EOM signal.
See “Obtaining judgment results with the external trigger setting” (p. 142).
- When the DC-voltage self-calibration is set to [MANUAL], T9 becomes 0 ms.

(2) When the trigger source is set to [EXT], the EOM output is set to [PULSE], and the DC-voltage self-calibration is set to [AUTO]

The EOM signal turns on when a measurement completes. After the duration of the EOM-output pulse width (T12) has elapsed, the EOM signal reverts to the off state. Inputting the TRIG signal while the EOM signal is on causes the EOM signal to turn off and a measurement to start. See “Configuring the EOM-signal output type settings” (p.148).

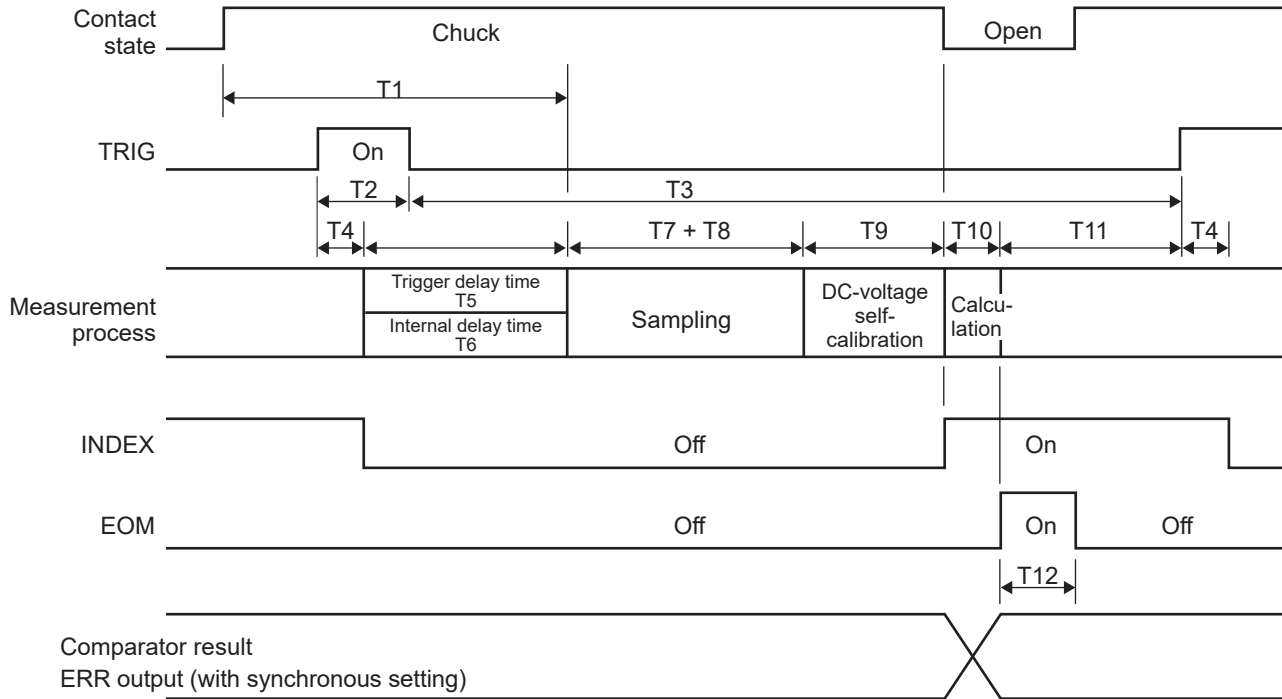

(3) When the trigger source is set to [INT], the trigger-reception continuation mode is set to [ON], and the DC-voltage self-calibration is set to [AUTO]

The EOM signal turns on after a measurement completes. The internal trigger is applied immediately after the EOM signal turns on, causing the signal to turn off.

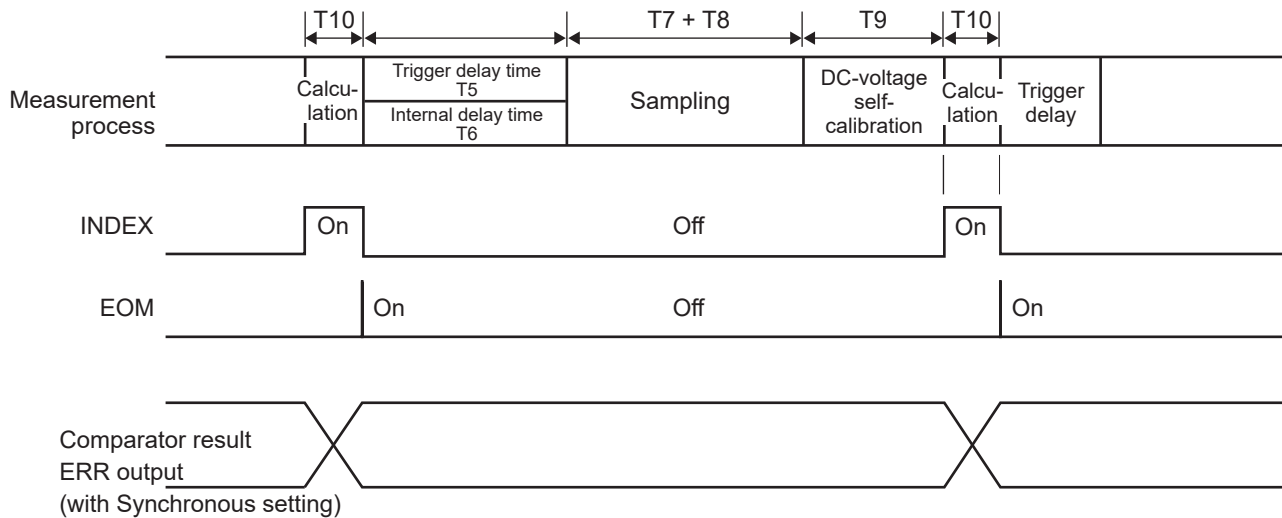

Explanations of times in the timing charts

Item	Description	Length of time (approx.)	Remarks																												
T0	ERR-output response time	2 ms or less	-																												
T1	Response time	8 ms or more	The duration (analog response time) required for electrical signals of the internal measuring circuitry to stabilize within the measurement accuracy specifications																												
T2	Duration of the TRIG signal active	1 ms or more	-																												
T3	Duration of the TRIG signal inactive	4 ms or more	-																												
T4	Trigger detection duration	0.2 ms or less	-																												
T5	Trigger delay time	0 ms to 10000 ms	Duration between the detection of a trigger and the start of sampling Predefined trigger delay time or internal delay time, whichever is longer																												
T6	Internal delay time	An internal delay time of 5 ms or less for the internal circuitry to switch from the DC-voltage self-calibration operation to the measurement operation. With the following settings for which a DC-voltage self-calibration is not performed, there is no need for an internal delay time (0 ms). Trigger source: Internal Trigger-reception continuation mode: On DC-voltage self-calibration: Manual																													
T7	Sampling time	<table border="1"> <thead> <tr> <th>Measuring function</th> <th>Fast1</th> <th>Fast2</th> <th>Medium1 (Med1)</th> <th>Medium2 (Med2)</th> <th>Slow1</th> <th>Slow2</th> </tr> </thead> <tbody> <tr> <td>ΩV (50 Hz) (60 Hz)</td> <td>4 ms</td> <td>10 ms</td> <td>20 ms 17 ms</td> <td>40 ms 33 ms</td> <td>100 ms</td> <td>200 ms</td> </tr> <tr> <td>Ω (50 Hz) (60 Hz)</td> <td>4 ms</td> <td>10 ms</td> <td>20 ms 17 ms</td> <td>40 ms 33 ms</td> <td>100 ms</td> <td>200 ms</td> </tr> <tr> <td>V (50 Hz) (60 Hz)</td> <td>4 ms</td> <td>10 ms</td> <td>20 ms 17 ms</td> <td>40 ms 33 ms</td> <td>100 ms</td> <td>200 ms</td> </tr> </tbody> </table> <p>Route resistance can be measured during the same periods. The line-frequency setting is indicated by values enclosed in parentheses.</p>	Measuring function	Fast1	Fast2	Medium1 (Med1)	Medium2 (Med2)	Slow1	Slow2	Ω V (50 Hz) (60 Hz)	4 ms	10 ms	20 ms 17 ms	40 ms 33 ms	100 ms	200 ms	Ω (50 Hz) (60 Hz)	4 ms	10 ms	20 ms 17 ms	40 ms 33 ms	100 ms	200 ms	V (50 Hz) (60 Hz)	4 ms	10 ms	20 ms 17 ms	40 ms 33 ms	100 ms	200 ms	
Measuring function	Fast1	Fast2	Medium1 (Med1)	Medium2 (Med2)	Slow1	Slow2																									
Ω V (50 Hz) (60 Hz)	4 ms	10 ms	20 ms 17 ms	40 ms 33 ms	100 ms	200 ms																									
Ω (50 Hz) (60 Hz)	4 ms	10 ms	20 ms 17 ms	40 ms 33 ms	100 ms	200 ms																									
V (50 Hz) (60 Hz)	4 ms	10 ms	20 ms 17 ms	40 ms 33 ms	100 ms	200 ms																									
T8	Additional time for resistance-measurement MIR mode	When it is set to on: 6 ms to 12 ms	Time inserted during sampling in resistance-measurement MIR mode operation.																												
T9	DC-voltage self-calibration processing time	With the Auto setting: 30 ms (50 Hz), 27 ms (60 Hz)	Self-calibration processing time to maintain the accuracy of DC voltage measurement.																												
T10	Calculation time	0.5 ms	-																												
T11	From the EOM-signal output to the TRIG-signal input	With the external trigger setting: 1 ms or more With the internal trigger setting: N/A (After the EOM signal is output, an internal trigger is detected)	-																												
T12	EOM pulse width (external trigger)	Hold setting: The signal remains on until the next external trigger is detected. Pulse setting: The signal remains on during the period of the predefined pulse width. When an internal trigger is detected, it turns off.																													

Zero adjustment timing

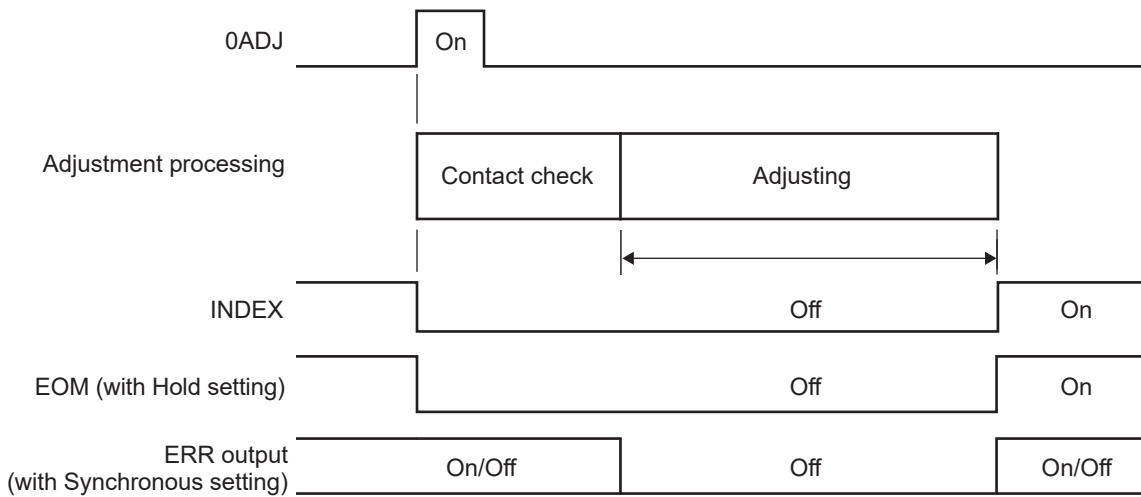

The ERR signal turns off upon successful zero adjustment and turns on if the adjustment fails. If the 0ADJ signal is input during a measurement, the instrument suspends the measurement, starting single-mode zero-adjustment.

IMPORTANT

When inputting the 0ADJ signal, make sure that the instrument is not measuring a battery.

Self-calibration timing

For the DC-voltage self-calibration is set to **[AUTO]**, the instrument always performs a DC-voltage self-calibration process after measuring voltage.

The DC-voltage self-calibration process is not automatically performed in the resistance measuring function (R), which does not involve voltage measurement.

Operation when the self-calibration is set to **[MANUAL]**

Choose between the two DC-voltage self-calibration settings: **[AUTO]** and **[MANUAL]**. Resistance self-calibration, which has no option, is fixed to manual operation.

When the CALIB or CALIB2 signal is input, the instrument starts a self-calibration process immediately.

If the TRIG signals are input during a self-calibration process, the instrument continues the process, ignoring the signals. If the CALIB or CALIB2 signal is input during a measurement, the instrument suspends the measurement, starting a self-calibration process.

The CALIB signal starts a DC-voltage self-calibration process, while the CALIB2 signal starts a resistance self-calibration process.

The DC voltage and resistance can be individually self-calibrated. When both the CALIB and CALIB2 signals are input, the instrument can perform self-calibration processes simultaneously for two measurement types. The following timing charts show simultaneous self-calibration processes.

Normal usage

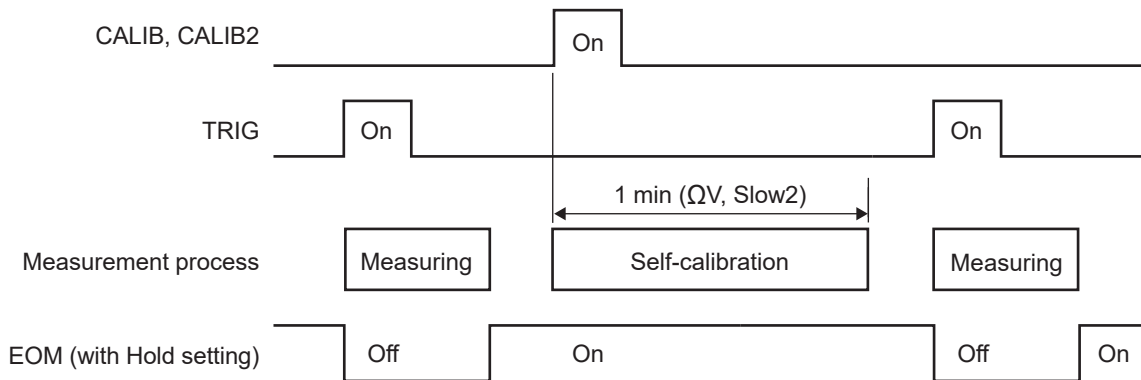

When a CAL signal is input during measurement

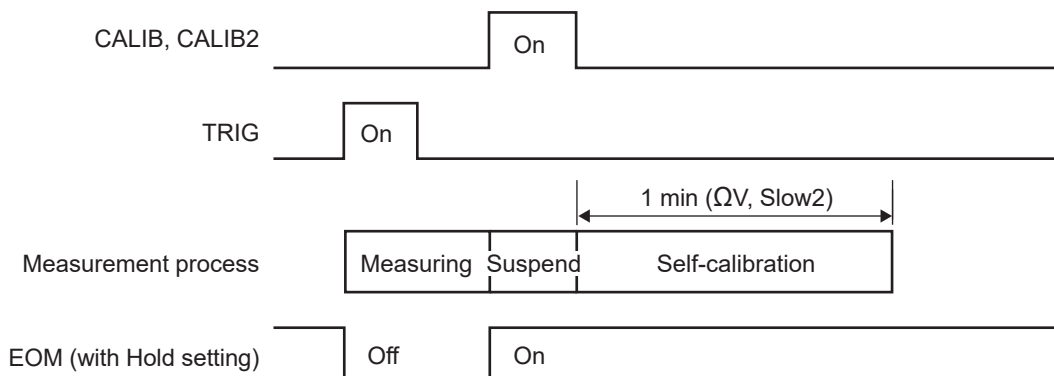

Panel loading timing

When using the TRIG signal

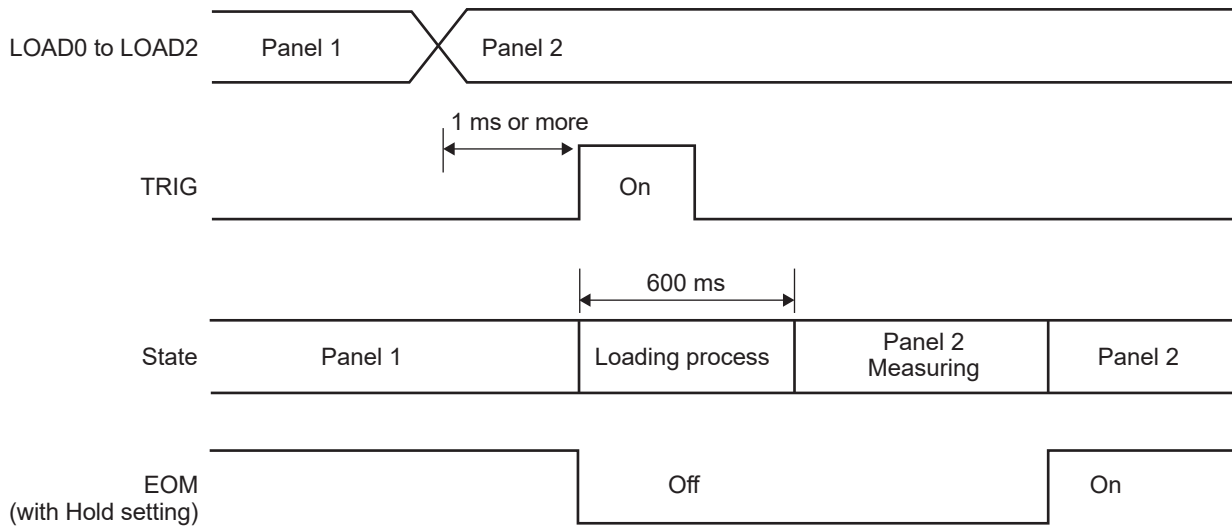

IMPORTANT

The panel to be loaded is that with the number selected by the load signals at the time of a trigger input (when the TRIG signal is turned on). Confirm the load signals by the time of a trigger input (before turning the TRIG signal on).

Output signal states when the instrument is turned on

Once the display switches from the startup screen to the measurement screen after the instrument is turned on, the INDEX signal turns on. The EOM signal turns on with the Hold setting, and turns off with the Pulse setting.

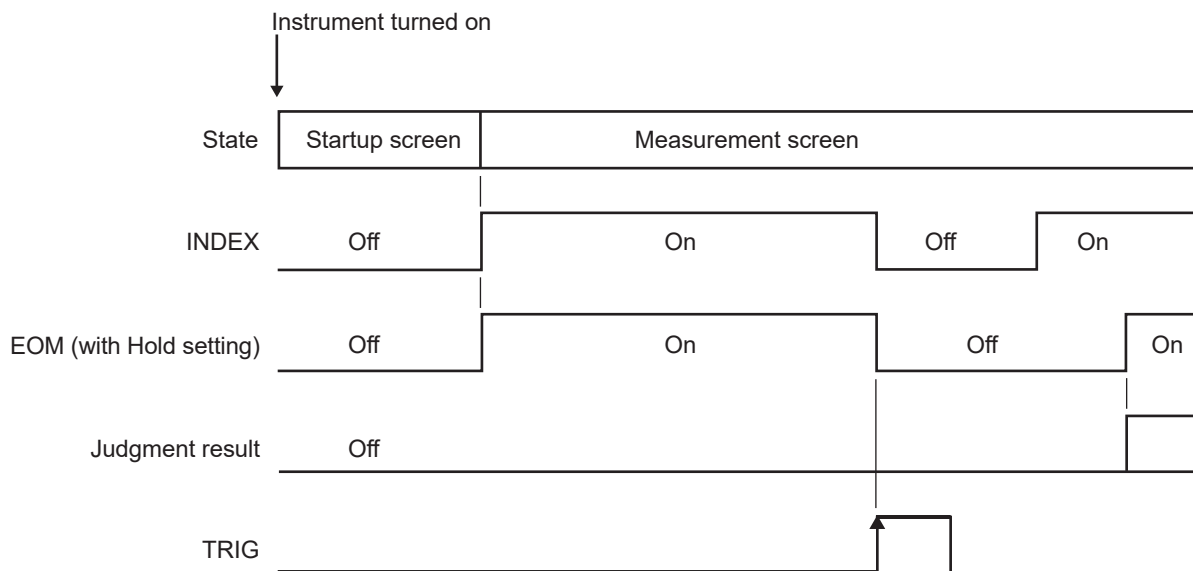

Judgment results: R_HI, R_IN, R_LO, V_HI, V_IN, V_LO, R_R_PASS, R_R_WARNING, R_R_FAIL, PASS1, FAIL1, PASS2, and FAIL2, including ERR

This timing cart indicates the operation when the trigger source is set to external.

Obtaining judgment results with the external trigger setting

This section describes the externally triggered measurement process, from the start of a measurement to the obtainment of judgment results or measured values. The instrument outputs the EOM signal as soon as it determines a judgment result*¹. If the input circuitry of the controller is characterized by a slow response, there may be a delay in accepting the judgment result after detecting the turning on of the EOM signal.

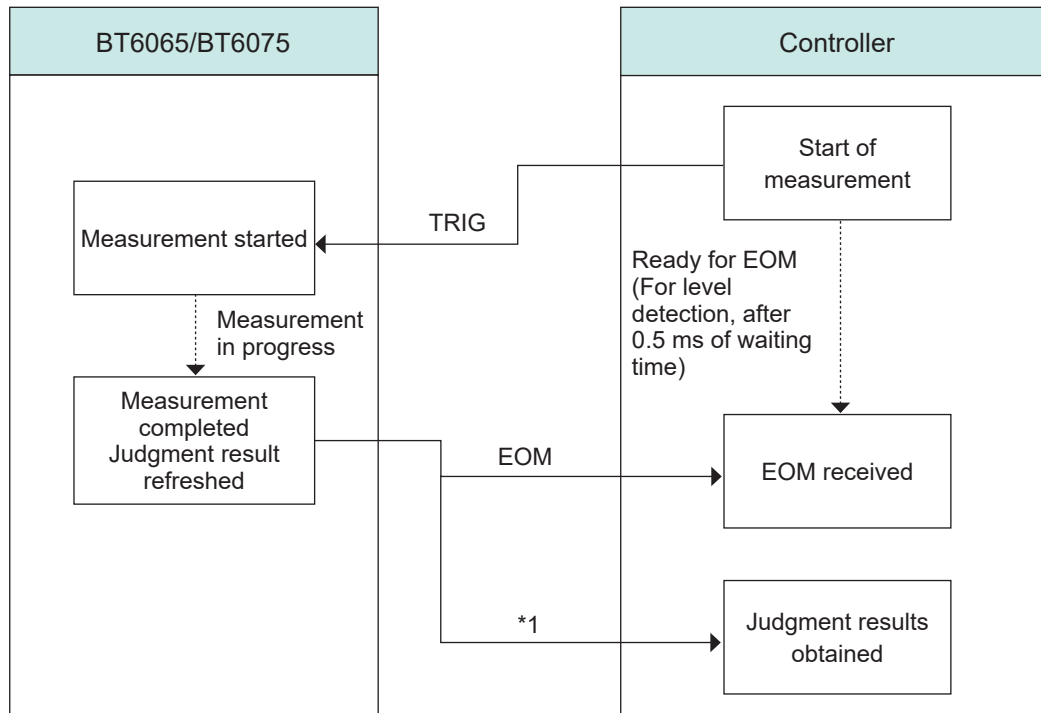

* 1. R_HI, R_IN, R_LO, V_HI, V_IN, V_LO, R_R_PASS, R_R_WARNING, R_R_FAIL, PASS1, FAIL1, PASS2, FAIL2, and ERR

8.3 Internal Circuitry

NPN setting

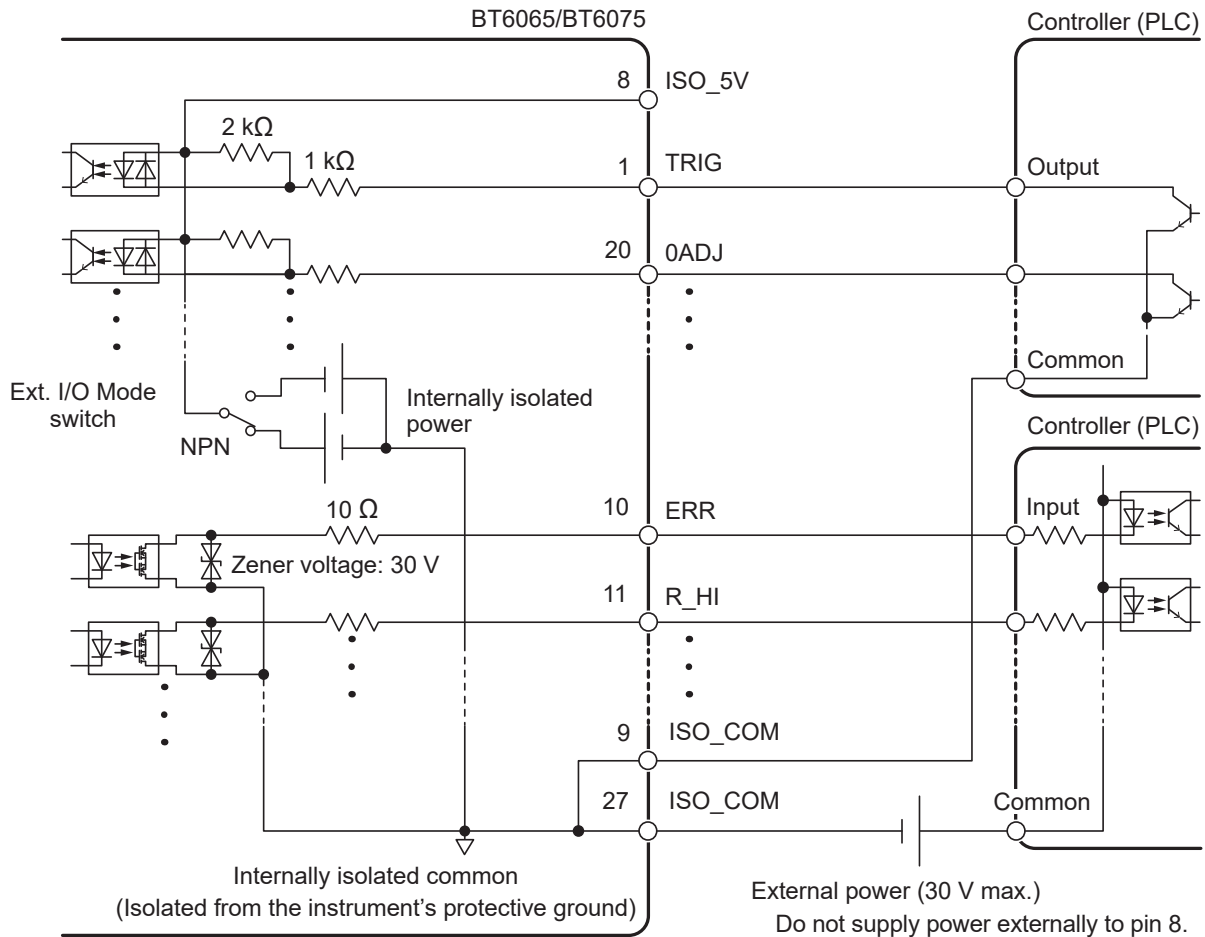

- Use the ISO_COM pins as the shared common pin for both input and output signals.
- If a large current will flow to the common wire, branch it into the output-signal common wire and input-signal common wire close to the ISO_COM pins.
- When supplying power from an external device, use the external power point, indicated by the battery symbol, shown in the figure above.

PNP setting

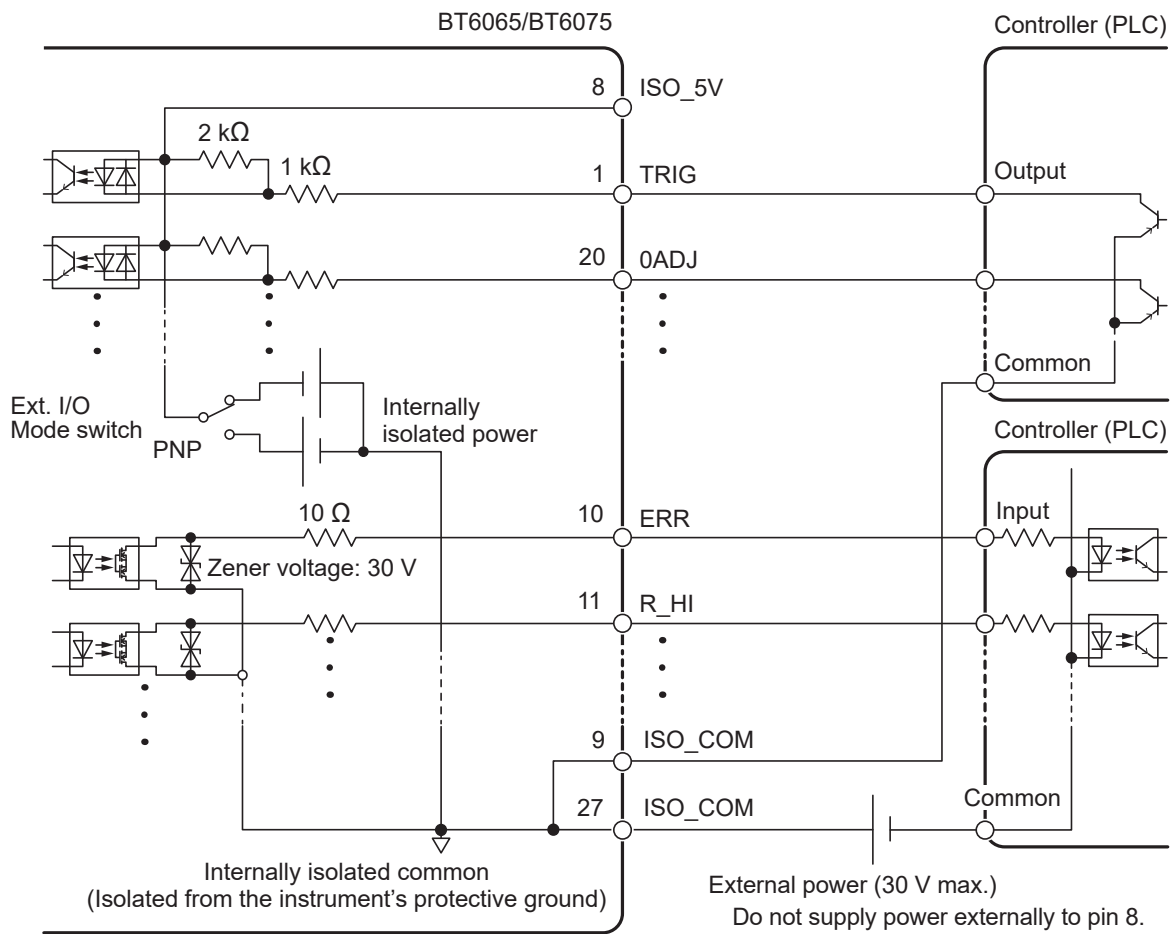

- Use the ISO_COM pins as the shared common pin for both input and output signals.
- When supplying power from an external device, use the external power point, indicated by the battery symbol, shown in the figure above.

Electrical specifications

Input signal	Input type	Photocoupler-isolated no-voltage contact input (with support for current sink and source output)
	Input-on condition	Residual voltage: 1 V or less Input-on current: 4 mA/channel (reference value)
	Input-off condition	Open-circuited (breaking current: 100 μ A/channel or less)
Output signal	Output type	Photocoupler-isolated open-drain output (non-polar)
	Maximum load voltage	30 V DC
	Maximum output current	50 mA/channel
	Residual voltage	1 V or less (with a load current of 50 mA) or 0.5 V or less (with a load current of 10 mA)
Service power	Output voltage	Sink-output compatible: +5.0 V \pm 0.5 V Source-output compatible: -5.0 V \pm 0.5 V
	Maximum output current	100 mA
	Isolation	Floating from the protective ground potential and measuring circuitry
	Insulation rating	Line-to-earth voltage: 50 V DC, 30 V AC rms, 42.4 V AC peak or less

Example connections

Example input connection

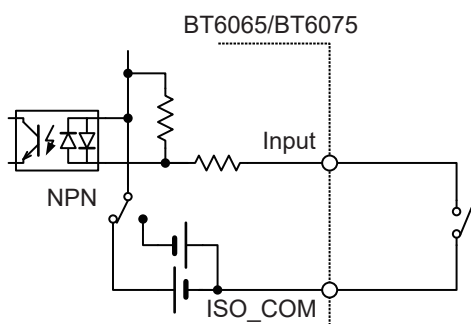

Connection with switch

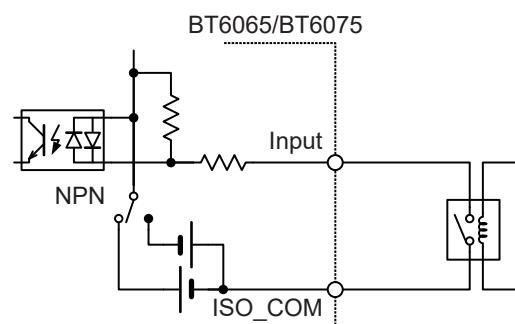

Connection with relay

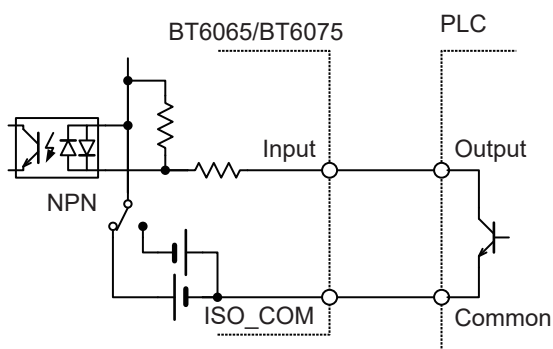

Connection with PLC output (NPN)

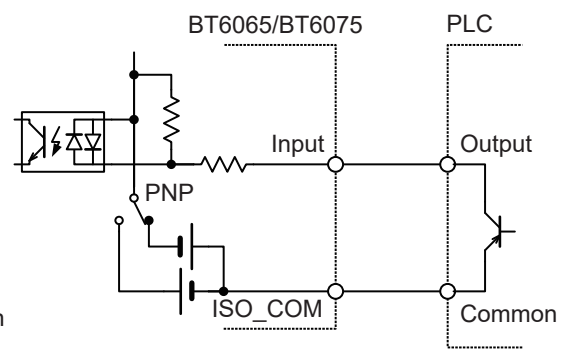

Connection with PLC output (PNP)

Example output connection

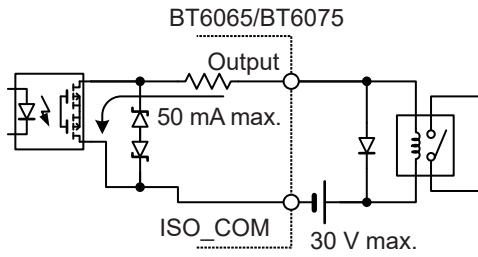

Connection with relay

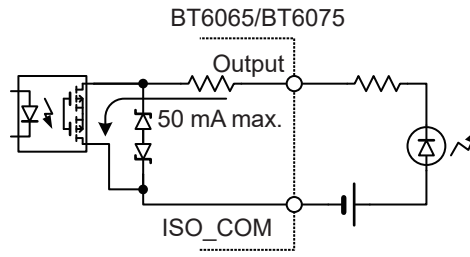

Connection with LED

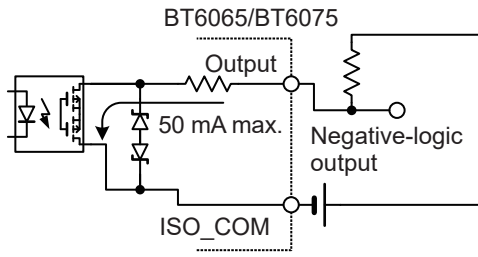

Negative-logic output

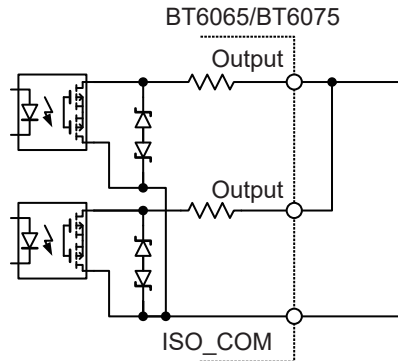

Wired OR

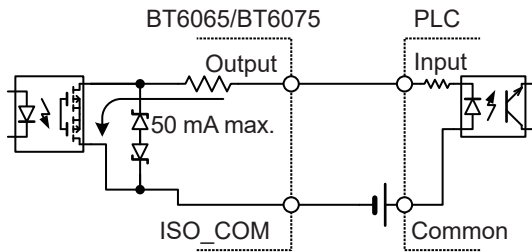

Connection with PLC input (positive-common)

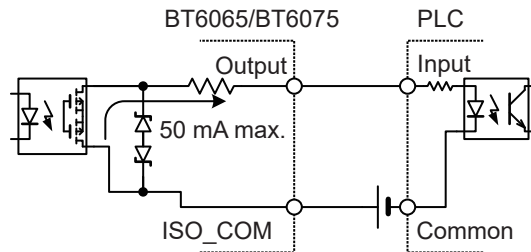

Connection with PLC input (negative-common)

8.4 Configuring the External Input and Output Settings

This section describes how to configure the external input and output settings.

<p>Input settings</p>	<p>Trigger source: EXT (external) See “4.1 Starting Measurements With Triggers” (p.87). TRIG-signal input filter See “Configuring the TRIG-signal input filter settings” (p. 147).</p>
<p>Output setting</p>	<p>See the following pages:</p> <ul style="list-style-type: none"> • “5.2 Defining the Upper and Lower Limits of the Comparator Capability” (p. 100) • “5.4 Configuring the Comparator Settings for the Route-Resistance Monitor” (p. 103) • “Configuring the EOM-signal output type settings” (p. 148) • “Selecting an ERR-signal output timing” (p. 149)

Configuring the TRIG-signal input filter settings

When a foot switch or other device is connected to the TRIG-signal pin, the filter capability provides an effective way to eliminate chatter.

[MENU] > [EXT I/O]



1 Tap [TRIG FILTER].



2 Tap [ON] to turn the filter capability on.

ON, OFF

3 Tap the [Filter time] box.

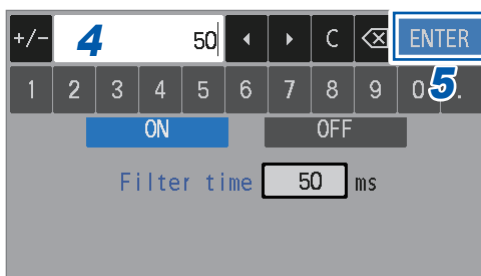

4 Use the numerical keypad to enter the response time.

50 ms to 500 ms

5 Tap [ENTER] to confirm.

Measurement start timing when the input filter is set to on

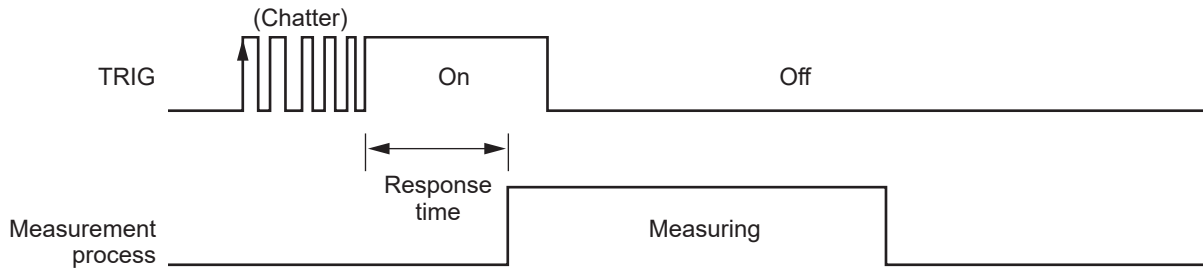

Configuring the EOM-signal output type settings

After a measurement is completed, the instrument outputs the EOM signal. Choose between two types of EOM-signal output: one that holds until the following trigger input and another that has a predefined-width pulse.

[MENU] > [EXT I/O]

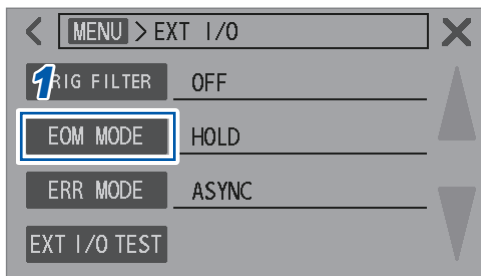

1 Tap [EOM MODE].

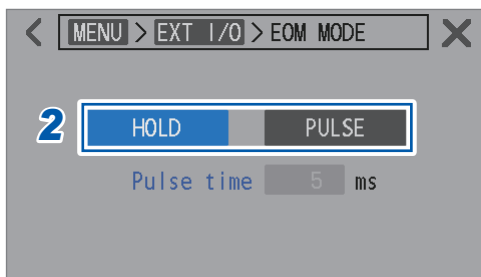

2 Select the output type.

HOLD <input checked="" type="checkbox"/>	After a measurement is completed, the EOM signal is held.
PULSE <input type="checkbox"/>	After a measurement is completed, a predefined-width pulse is output. If a trigger is input before the predefined period has elapsed, the EOM signal turns off.

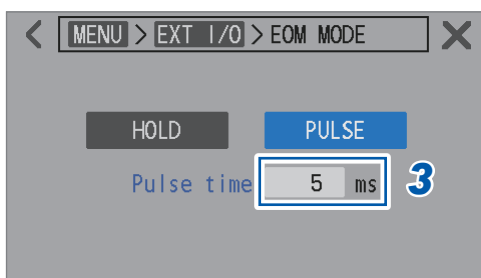

(When [PULSE] is selected)

3 Tap the [Pulse time] box.

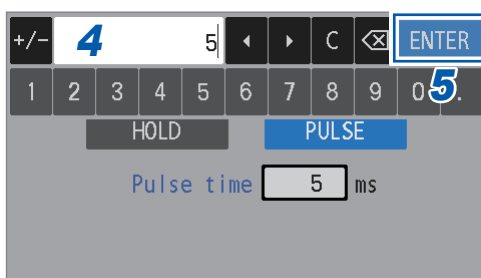

4 Use the numerical keypad to enter the pulse width.

1 ms to 100 ms (5 ms²)

5 Tap [ENTER] to confirm.

Selecting an ERR-signal output timing

The ERR signal is output when abnormal measurement conditions (such as measurement-lead open, imperfect contact, fail judgment for route resistance) occur. Two timings are available for outputting the ERR signal.

<p>Outputting the ERR signal in sync with the EOM signal output (SYNC)</p>	<p>When a contact-check error or a route-resistance-monitor judgment error is detected during sampling interval, this signal is output in sync with the EOM signal. When the ERR signal is on, all outputs of comparator judgment results for each resistance and voltage are turned off.</p> <p>Measurement error examples:</p> <ul style="list-style-type: none"> • A contact-check error occurs. • The route-resistance monitor provides a fail judgment. • Route resistance falls outside the measurement range of the route-resistance monitor (overrange). <p>Measurement completion example:</p> <ul style="list-style-type: none"> • Resistance or DC voltage measured value falls outside the measurement ranges (overrange).
<p>Outputting the ERR signal asynchronously concerning the EOM signal output (ASYNC)</p>	<p>When a contact-check error is detected, this signal is output in real time.</p> <p>Measurement error examples:</p> <ul style="list-style-type: none"> • A contact-check error occurs. <p>Measurement completion example:</p> <ul style="list-style-type: none"> • Resistance or DC voltage measured value falls outside the measurement ranges(overrange).

[MENU] > [EXT I/O]

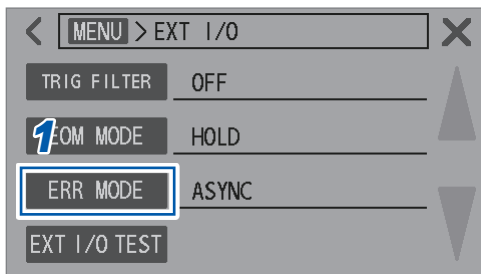

1 Tap [ERR MODE].

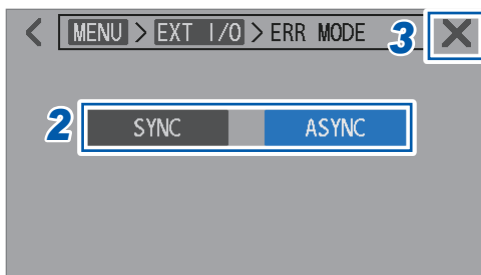

2 Select an output type.

SYNC, ASYNC

3 Tap [X] in the upper-right corner of the screen.

The screen returns to the measurement screen.

8.5 Testing the External Input/Output Capability (External I/O Testing Capability)

You can manually toggle between the on and off states of output signals and monitor the states of input signals on the screen.

[MENU] > [EXT I/O]



1 Tap [EXT I/O TEST].

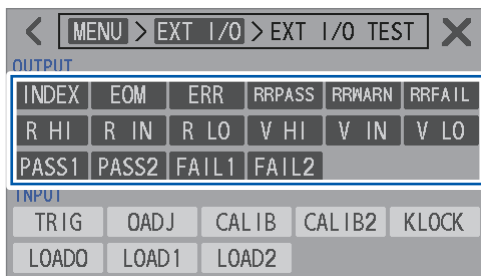

2 Tap the signal you want to output.

The instrument outputs the corresponding signal. Use the connected device to verify the signal output.

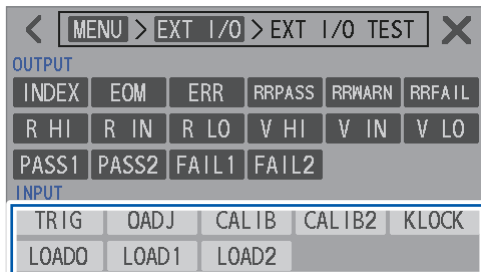

3 Input a signal from a connected device.

The signals input to the instrument activate corresponding blue indicators.

Controlling the Instrument via Communications

CAUTION



- **Do not disconnect the communication cable while the instrument is sending or receiving data.**

Doing so could damage the instrument or computer.

- **Connect the instrument and computer at the common ground.**

Connecting a communication cable when there is a difference in ground potentials between them could cause damage or malfunction.



- **Turn the instrument and computer off before connecting or disconnecting the communications cable.**

Failure to do so could cause damage or malfunction in the instrument and computer.

- **Once you have connected the cables, tighten the screws on the connectors.**

Failure to do so could prevent data from being properly transferred.

9.1 Overview and Features of Interfaces

You can control the instrument and acquire data using the LAN or RS-232C interface, or the USB port (COM mode).

This chapter describes the preparations and configuration of associated settings.

For more information about how to control the instrument and acquire data, see the sections that best suite your application or intended use.

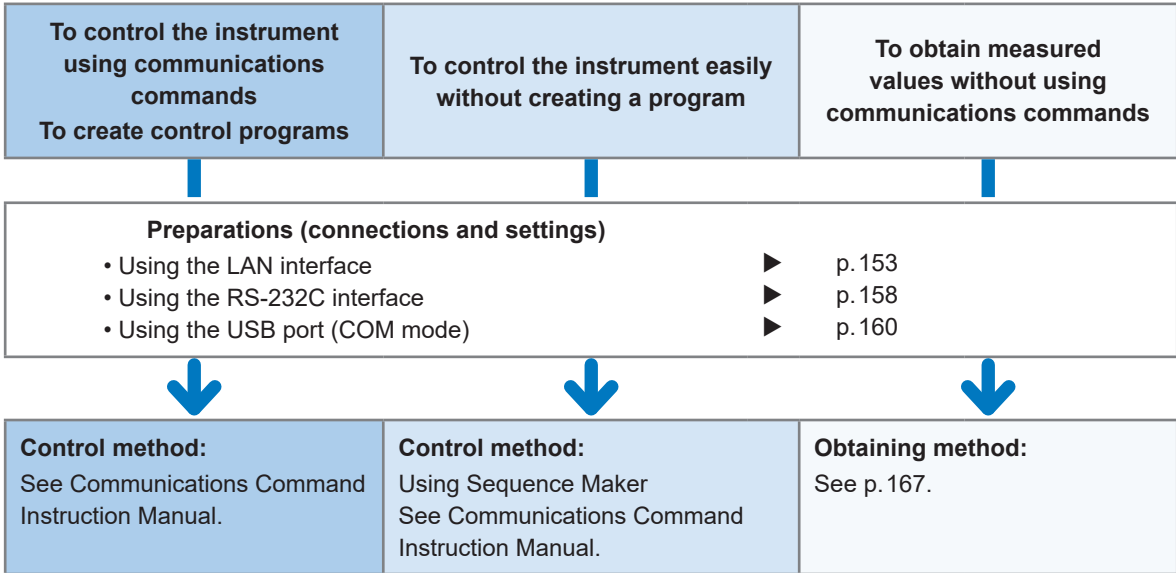

You can download Sequence Maker from Hioki's website.

<https://sequencemaker.hioki.com/>

IMPORTANT

You can choose from three options: the LAN interface, the RS-232C interface, and the USB port (COM mode). Multiple communication control methods cannot be used simultaneously.

You can control the instrument and obtain data using the LAN or RS-232C interface in combination with USB (MEM mode). The USB port (COM mode) cannot be used with USB (MEM mode) simultaneously.

See "12.4 Interface Specifications" (p.202).

Communications time

- Display processing may lag based on the frequency or contents of communication processing.
- Consider the data transfer time when communicating with connected external devices.

1. USB and LAN transfer times vary with the connected external devices.
2. USB and LAN transfer times vary with communications quality.
3. When a total of 10 bits, one start bit, eight data bits, no parity, and one stop bit, is used, and a transfer speed (baud rate) is set to N (bps), the RS-232C transfer time per character T (s/character) is roughly calculated as follows:

$$T = 10/N$$
 Transmitting time per character $T = 10 \text{ (bits)} / \text{Baud rate } N \text{ (bps)}$
 Example: For the string **ABCDE12345**
 The two characters, CR+LF, are added as a message terminator (delimiter), bringing the total of characters transferred to 12. When the baud rate is 9600 bps, the total transmission time T_T is

$$T_T = 12 \times T = 12 \times 10/9600 = 12.5 \text{ (ms)}$$

- See Communications Command Instruction Manual.

Switching between the remote and local states

During communications, the instrument enters the remote state and displays the **[REMOTE]** symbol on the measurement screen, and key operations, as well as touchscreen operations, are disabled. However, the **TRIGGER** key operation is enabled.

Tapping **[LOCAL]** or disconnecting LAN or USB communications cancels the remote state, allowing key operations and touchscreen functionality.

When entering the remote state while displaying the setting screen, the instrument automatically displays the measurement screen.

9.2 Working with the LAN Interface

The instrument comes standard with Fast Ethernet 100BASE-TX compatible interface. You can control the instruments with computers or other devices by using 10BASE-T or 100BASE-TX compatible LAN cables (up to 100 m) to connect the instruments to a network.

⚠ CAUTION

- If routing a LAN cable outdoors or over 30 m, attach a LAN surge protector or another suitable protective device.



Such signal wiring is susceptible to induced lighting, which can cause damage to the instruments.

Connecting the multiple units of the BT6065/BT6075 and computers to a network

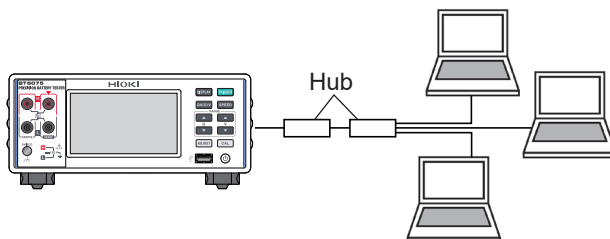

Connecting the BT6065/BT6075 to a computer one-to-one

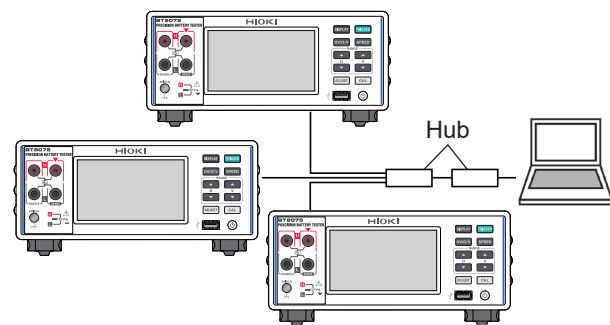
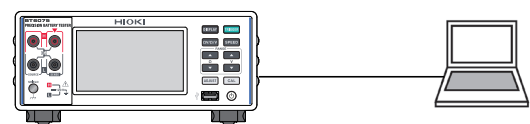

In addition, after creating a program, connecting external equipment, such as a computer to the communications command port using TCP allows you to control the instruments through communications commands. See Communications Command Instruction Manual for details.

Preparation procedure

Set the communications conditions of the instrument. (p.154)



Connect a LAN cable to the instrument. (p.157)

(1) Setting the communications conditions

Check the settings before configuring them.

The settings for the instrument and external devices vary based on whether you are connecting the instrument to your existing network or creating a new network that includes the instruments and a single computer.

Connecting the BT6065/BT6075 to your existing network

The following settings must be assigned in advance by your network system administrator. Make sure that the settings for the instruments differ from those for the others.

- Address settings for the instrument
IP address: ____ . ____ . ____ . ____
Subnet mask: ____ . ____ . ____ . ____
- Gateway
Whether to use a gateway: Use/Not use
IP address (if using): ____ . ____ . ____ . ____ (If not using, assign 0.0.0.0.)
- Port number used by communications commands: ____ (Default: 23)

Creating a new network consisting of the instruments and a single computer

(Using the instruments on a local network without any outside connection)

If no administrator is present or if settings are discretionary, it is recommended to assign the following addresses:

Example settings
IP address
Computer: 192.168.1.1
First instrument: 192.168.1.2
Second instrument: 192.168.1.3
Third instrument: Addresses should be assigned in order, for example:
↓ ↓
Subnet mask..... 255.255.255.0
Gateway Off (0.0.0.0)
Communications command port number..... 23

Setting items

IP address (IP Address)	This address is used to recognize individual devices connected to a network. Assign a unique address to the instrument.
Subnet mask (Subnet mask)	This setting is used to divide the IP address into components: one indicating the network and another indicating the device. Use the same subnet mask setting as other devices on the same network.
Gateway IP address (Default gateway)	<p>When connecting the instrument to a network</p> <p>When the computer to be used (communications-partner device) is on another network from the one the instrument is connected to, specify a device to serve as the gateway by setting its IP address.</p> <p>If the instrument is connected to the same network as the computer, you should generally use the same default gateway setting as the computer.</p> <p>When connecting the instrument to a single computer or when not using a gateway</p> <p>Set the IP address to [0.0.0.0].</p>
Port number (Port)	Specify the TCP/IP port number to use for communications-command connections.

[MENU] > [I/F]

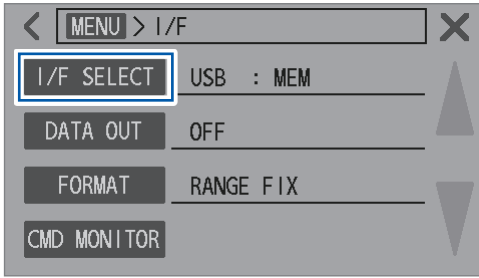

1 Tap [I/F SELECT].

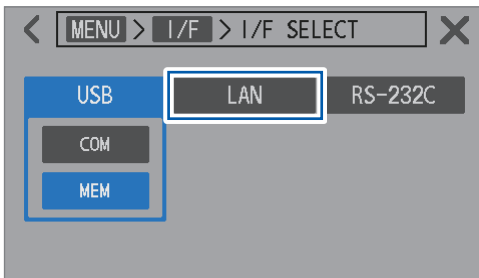

2 Tap [LAN].

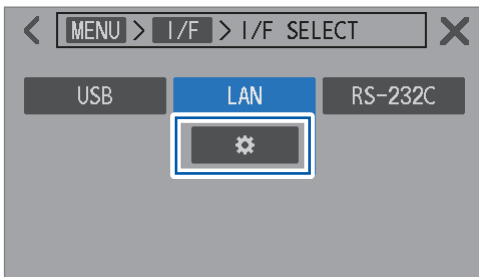

3 Tap the setting button.

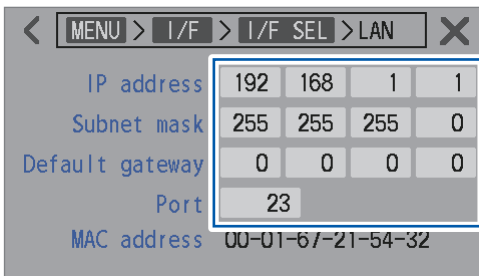

4 Tap the [IP Address], [Subnet mask], [Default gateway], or [Port] box.

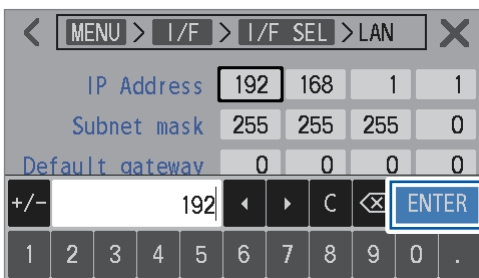

5 Use the numerical keypad to enter each setting.

IP address	Four numbers, each ranging from 0 to 255 192.168.1.1 [□]
Subnet mask	Four numbers, each ranging from 0 to 255 255.255.255.0 [□]
Default gateway	Four numbers, each ranging from 0 to 255 0.0.0.0 [□]
Port number	1 to 65535 (except 80) 23 [□]

6 Tap [ENTER] to confirm.

(2) Connecting a LAN cable

Before connecting a LAN cable, read the precautions (p. 151) carefully.
Connect a LAN cable to the LAN connector of the instrument.

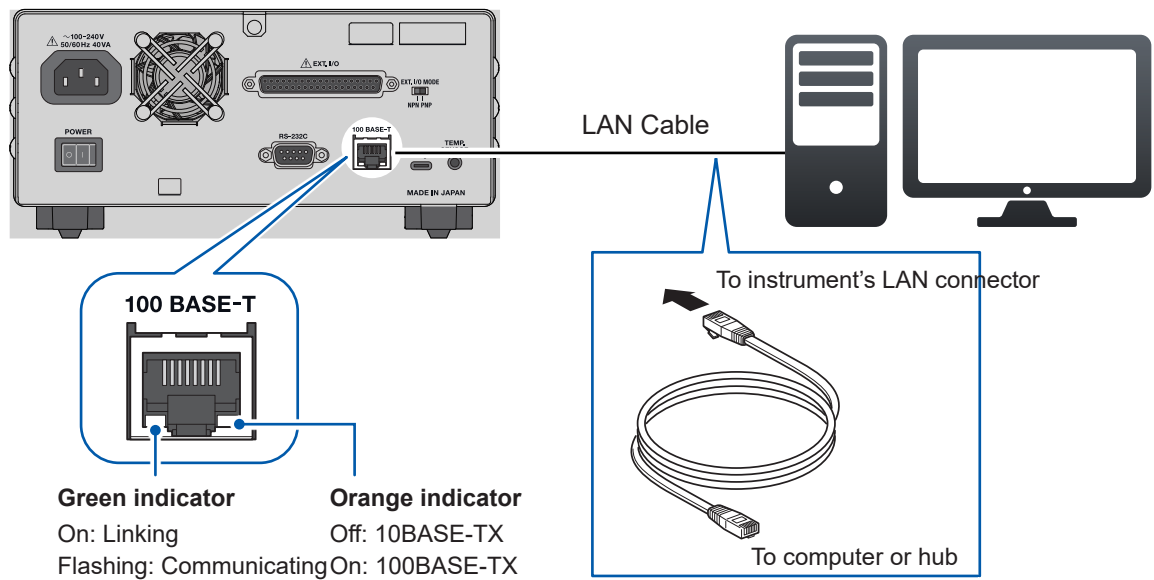

If the green indicator fails to light up after connecting the instrument to the LAN, there may be a malfunction in the instrument or connected devices, or the LAN cable may have a break or a poor contact.

Recommended cable

9642 LAN Cable (optional equipment)

9.3 Working with the RS-232C Interface

Preparation procedure

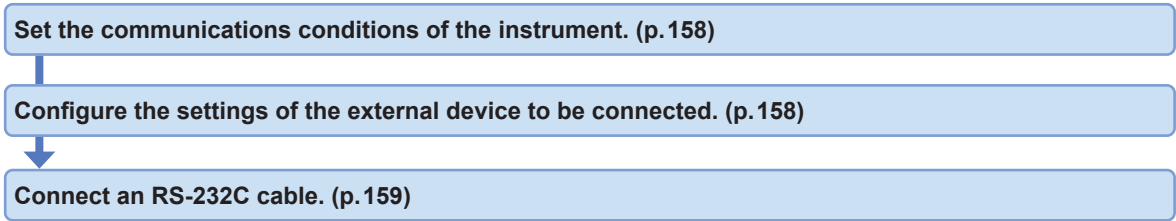

(1) Setting the communications conditions

[MENU] > [I/F]



1 Tap [I/F SELECT].



2 Tap [RS-232C].

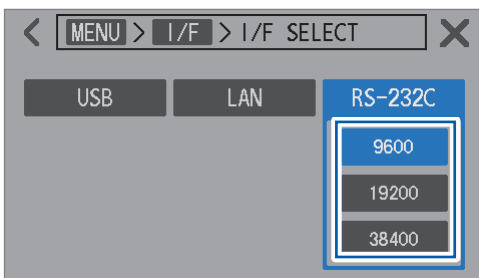

3 Select a baud rate.

9600[□], 19200, 38400

(2) Configuring the settings for the external device to be connected to the instrument (such as computer and programmable controller)

Configure the settings for the external device as follows:

Method	Asynchronous
Baud rate	9600 bps, 19200 bps, 38400 bps (based on the instrument setting)
Stop bit	1
Data bits	8
Parity check	None
Flow control	None

(3) Connecting an RS-232C cable.

Before connecting an RS-232C cable, read the precautions (p. 151) carefully.

Connect an RS-232C cable to the RS-232C connector. After connecting the cable, ensure to tighten the fastening screws.

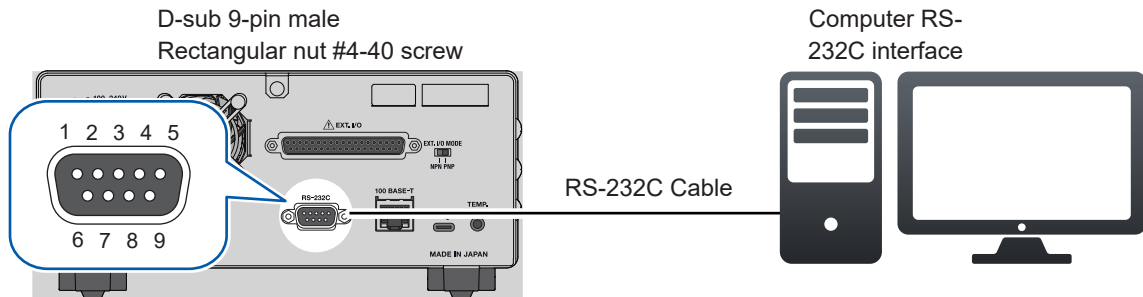

- When connecting the instrument to an external device (digital terminal equipment, DTE), use a crossover cable that satisfies the connectors specifications of the instrument and external device.
- The instrument is equipped with an I/O connector compliant with data terminal equipment (DTE) standards.
- This instrument uses pins 2, 3, and 5. Other pins are unused.

Pin number	Signal name			Signal	Remarks
	Common name	EIA	JIS		
1	DCD	CF	CD	Data carrier detect	Not connected
2	RxD	BB	RD	Receive data	
3	TxD	BA	SD	Transmit data	
4	DTR	CD	ER	Data terminal ready	Fixed at on level (+5 to +9 V)
5	Ground	AB	SG	Signal ground	
6	DSR	CC	DR	Data set ready	Not connected
7	RTS	CA	RS	Request to send	Fixed at on level (+5 to +9 V)
8	CTS	CB	CS	Clear to send	Not connected
9	RI	CE	CI	Ring indicator	Not connected

When connecting the instrument to a computer

Use a cross cable with D-sub 9-pin female connectors at both ends.

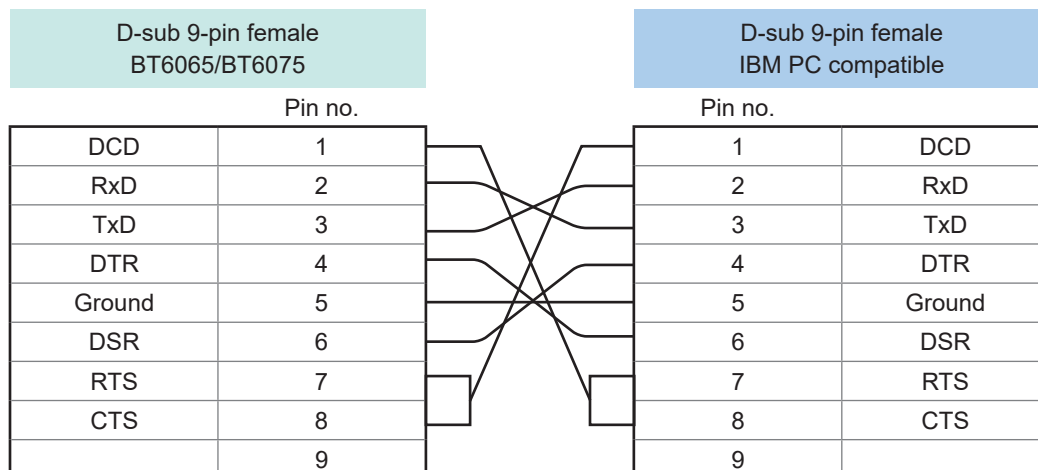

Recommended cable: Hioki 9637 RS-232C Cable (3 m)

9.4 Working with the USB Port (COM mode)

Preparation procedure

Set the communications conditions of the instrument. (p. 160)

Install the USB driver on your computer. (p. 161)
(With [USB COM] setting only)

Connect a USB cable. (p. 163)

Before connecting the instrument to a computer, download a USB driver to install.

When the instrument without a pre-installed USB driver is connected to a computer, the computer may automatically install the Microsoft-provided USB driver into the instrument. The instrument, equipped with the Microsoft-provided USB driver, can establish proper communication with the computer.

(1) Setting the communications conditions

[MENU] > [I/F]

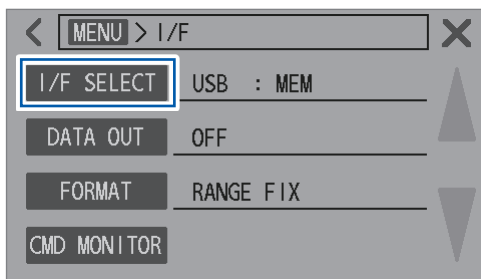

1 Tap [I/F SELECT].

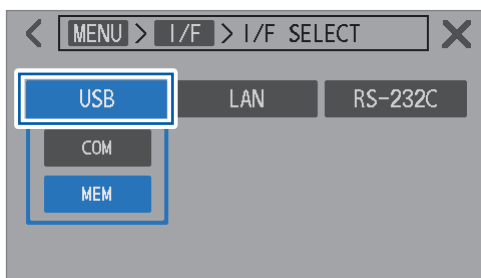

2 Tap [USB].

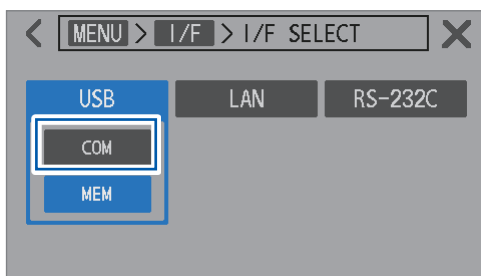

3 Tap [COM].

COM (rear)	Select to connect the instrument to the computer using a USB cable for communications through a virtual COM port (the instrument outputs data using a terminal emulator or a user-created program).
MEM (front)	Select to have the instrument to output data onto a USB flash drive. (p. 173)

(2) Installing the USB driver (with the **[USB COM]** setting only)

Before connecting the instrument to a computer for the first time, download and install the dedicated USB driver.

When the driver has already been installed, connect the instrument as usual.

You can download the latest edition of the USB driver from Hioki's website.

Search the software download page for *BT6065*.

Installing the driver

- 1** Log on to your computer with administrator or supervisor privileges.
- 2** Exit all applications running on your computer.
- 3** Expand the downloaded ZIP format file and open the **[driver]** folder.
- 4** Double-click **[DPInst64.exe]** or **[DPInst32.exe]** to execute.

When using the 64-bit Windows, execute **[DPInst64.exe]**.

When using the 32-bit Windows, execute **[DPInst32.exe]**.

After running the executable file, follow the on-screen instructions to install the driver.

In certain environments, it may take some time for the dialog box to appear. Please be patient and wait for the dialog box.

Once the driver installation is completed, the instrument is recognized automatically when connected to your computer using a USB cable.

To determine the COM port to which the instrument is connected, check Device Manager on your computer.

- If the **[Found New Hardware Wizard]** dialog box appears, you will be asked, **[Can Windows connect to Windows Update to search for software?]**. Select **[No, not this time]** and then select **[Install the software automatically]**.
- If connecting an instrument with a different serial number, you may be alerted that the computer has detected a new device. Follow the on-screen instructions to install the device driver.



When the Microsoft-provided USB driver is installed, you cannot confirm the model number of the instrument on the Device Manager.

When the Hioki-dedicated USB driver is installed, the COM number can be confirmed with the model name; thus, it is recommended to install the Hioki-dedicated USB driver.

Example:

When the Hioki-dedicated USB driver is installed

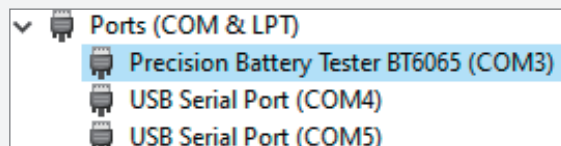

When Microsoft-provided USB driver is installed

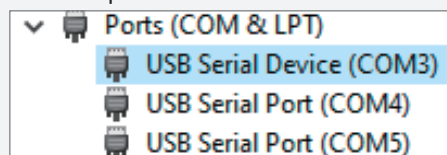

Uninstalling the driver (When the driver becomes unnecessary)

- 1 Open Device Manager.
- 2 Extend the sub-entries of [Ports (COM & LPT)], right-click [Precision Battery Tester BT6065], and then, from the shortcut menu, click [Uninstall Device].

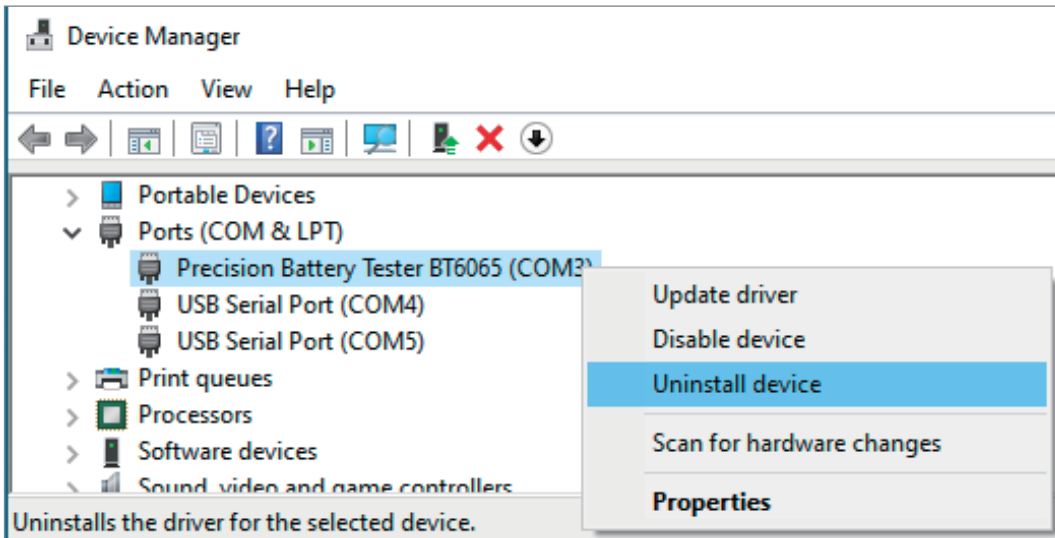

- 3 Select the [Delete the driver software for this device] check box, and then click [Uninstall].

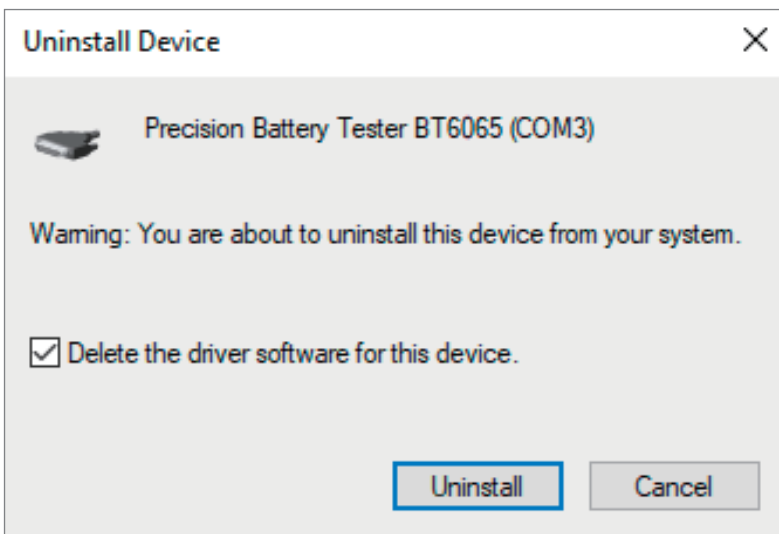

(3) Connecting a USB cable

Before connecting a USB cable, read the precautions (p. 151) carefully.
Connect the USB cable to the USB connector of the instrument.

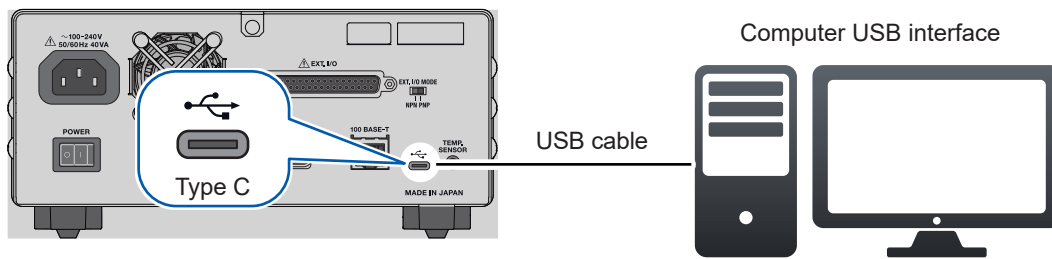

9.5 Configuring the Communications Settings

Displaying the communications monitor (displaying communications commands)

The communications monitor can display communications commands and query responses, enabling you to observe them on the screen.

[MENU] > [I/F]

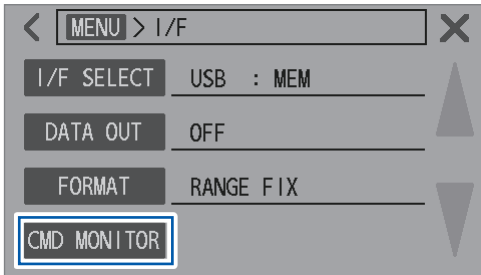

1 Tap [CMD MONITOR].

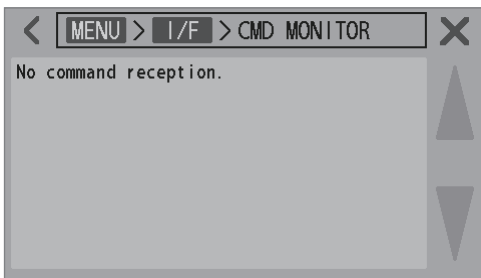

The communications-monitor screen appears. Received communication commands or query responses are displayed.

Messages shown on the communications monitor and their meanings

If a command-based error occurs, you can obtain error information by sending the `:SYSTem:ERRor?` query.

<p>If a command error occurs (e.g., an illegal command and an illegal argument number)</p>	<pre>> :SYST:ERR? < 100,"Command error"</pre>
<p>If a parameter error occurs (e.g., an illegal argument range and an illegal argument format)</p>	<pre>> :SYST:ERR? < 220,"Parameter error"</pre>
<p>If an execution error occurs (not possible under certain measurement conditions)</p>	<pre>> :SYST:ERR? < 200,"Execution error"</pre>

When the handshake response is enabled by sending the `:SYSTem:COMMunicate:RESPonse ON` command, the response indicates the position where the error occurred.

<p>If an illegal argument is specified (300 is out of range)</p>	<pre>> :RES:RANG 300 < PARAM ERR</pre>
<p>If a command contains an error in spelling (RANG misspelled as RENG)</p>	<pre>> :RES:RENG 30 < CMD ERR</pre>

- If an RS-232C interface error occurs, you can obtain information by sending the `:SYSTem:ERRor?` query.

When an overrun error occurred (received data lost)	> <code>:SYST:ERR?</code> < 363, "Rs232c Overrun error"
If a break signal is received	> <code>:SYST:ERR?</code> < 360, "Communication error"
If a parity error occurs	> <code>:SYST:ERR?</code> < 361, "Rs232c Parity error"
If a framing error occurs	> <code>:SYST:ERR?</code> < 362, "Rs232c Framing error"

- When commands are sent continuously, the monitor display may not catch up due to a delay in updating.
When using the RS-232C interface, if only hexadecimal characters are displayed or any of the above messages appear, check the communications conditions or reduce the communications speed, and then try again.

Selecting a measured-value format

You have the options to set the format of responses to measured-value queries (such as `:FETCh?` and `:READ?`).
The measured-value format is also applied to batch transmission of measured values (memory) and measured-value output.

[MENU] > [COMM]

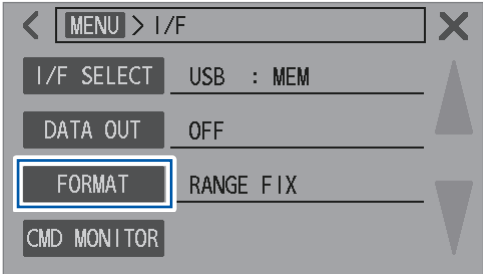

1 Tap [FORMAT].

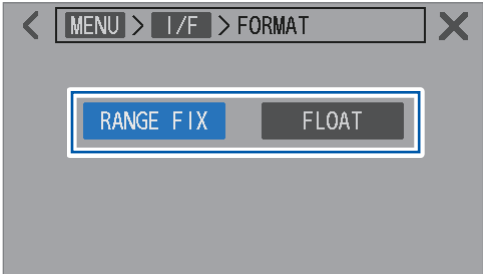

2 Select a measured-value format.

RANGE FIX [☑]	Fixes the exponent part based on the measurement range.
FLOAT	Uses the floating-point notation.

Turning the command compatibility mode on

Command compatibility mode can be turned on by sending a communications command only. Commands of the BT3562A Battery HiTester can be used as they are (upward compatible).

1 Select an interface to use.

See “9.2 Working with the LAN Interface” (p. 153).

See “9.3 Working with the RS-232C Interface” (p. 158).

See “9.4 Working with the USB Port (COM mode)” (p. 160).

2 Send the command for turning command compatibility mode on.

`:SYSTem:COMMunicate:BT3562A ON`

The response format of queries and measured-value format become the same as those of BT3562A.

10

Outputting Measured Values (via LAN, RS-232C, and USB)

When the measured-value output setting is enabled, measured values are automatically output to the selected communications interface. You can use this capability to automatically output measured values to a PLC or a computer.

You can also select the output type.

10.1 Selecting an Interface

[MENU] > [I/F]

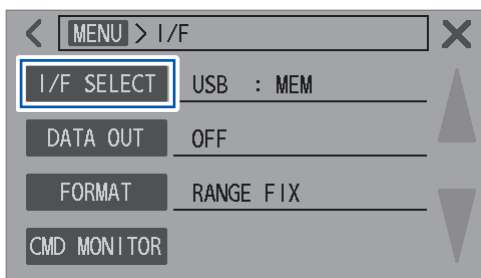

1 Tap [I/F SELECT].

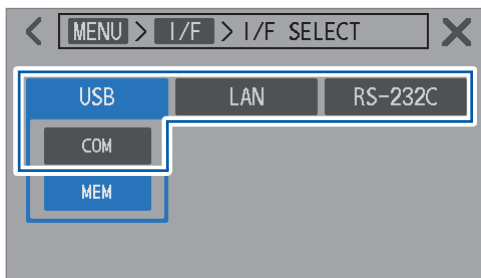

2 Select an interface to use.

USB COM, LAN[□], RS-232C

Select [COM] to use [USB].

Setting	Overview
LAN	Connect the instrument to your computer or PLC with a LAN cable. Data can be obtained with a terminal emulator or a user-created program.
RS-232C	Connect the instrument to the COM port of your computer or PLC with an RS-232C cable. Data can be obtained with a terminal emulator or a user-created program.
USB COM	Connect the instrument to your computer with a USB cable. Data can be obtained with a terminal emulator or a user-created program.

10.2 Outputting Data

1 Select an interface to use.

- LAN See “9.2 Working with the LAN Interface” (p. 153).
- RS-232C See “9.3 Working with the RS-232C Interface” (p. 158).
- USB COM See “9.4 Working with the USB Port (COM mode)” (p. 160).
- External I/O See “8 Externally Controlling the Instrument (when inputting the TRIG signal) (External I/O)” (p. 127).

2 Set the measured-value output setting (**[DATA OUT]**) to **[ON]**. (p. 169)

3 Put the connected device into the receive standby state.

If the instrument is connected to your computer, start the application and put the computer into the receive standby state.

4 Press the **TRIGGER** key, turn on the TRIG signal of the external I/O, or send the ***TRG** command.

An input trigger starts a measurement, and the measured values are output once the measurement is completed.

When the trigger source of this instrument is set to external, a single measurement is performed and the measured values are output.

When the trigger source of this instrument is set to internal, the instrument outputs a set of measured values obtained first after the trigger input.

10.3 Configuring the Measured-Value Output Settings

[MENU] > [I/F]



1 Tap [DATA OUT].

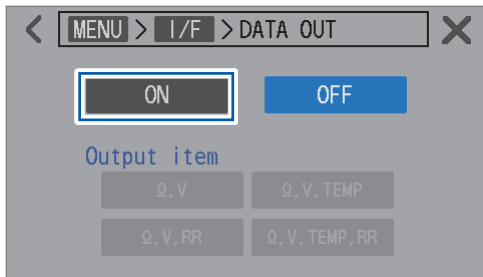

2 Tap [ON].



Auto-output is turned on.

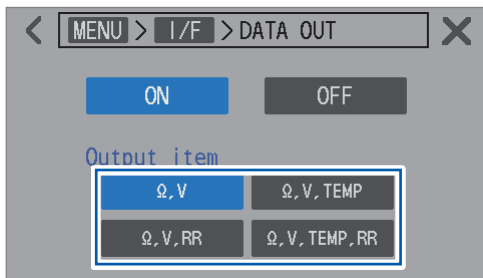

3 Select a measured-value type.

Ω	Resistance measured values
V	Voltage measured values
TEMP	Temperature measured values
RR	Route resistance measured values

To acquire measured values using the `:READ?` query, turn the measured-value output to off. Failure to do so may cause measured-value data to be sent twice.

10.4 Transmitting Measured Values in Batches (Memory)

Measured-value batch transmission capability can be turned on by sending a communications command only.

When the measured-value batch transmission is enabled through the communications command, the instrument saves the measured values in its internal memory upon receiving an external trigger input. Saved contents consist of the memory number and measured values of resistance and DC voltage. (up to 528 data sets)

Saved data can be read at once later through communications command.

When multiple objects (batteries) are measured one by one by switching between them using the Switch Mainframe, sending measured values for each channel to a device such as a sequencer and a computer after each measurement increases the switching time. The inspection cycle time can be shortened by saving the data in the internal memory and transferring the saved data during the free time after all channels are measured.

1 Select an interface to use.

See “9.2 Working with the LAN Interface” (p. 153), “9.3 Working with the RS-232C Interface” (p. 158), and “9.4 Working with the USB Port (COM mode)” (p. 160).

2 Send the command to turn the internal-memory data-saving capability on.

:MEMory:STATe ON

3 Save the measured values in the internal memory.

Press the **TRIGGER** key, turn on the TRIG signal of the external I/O, or send the ***TRG** command. The measured values are saved on the internal memory.

When the trigger source is set to external, a triggered measurement is performed once and the measured values are saved after the measurement is completed.

When the trigger source is set to internal and trigger-reception continuation mode is off, a triggered measurement is performed once and the measured values are saved after the measurement is completed. When trigger-reception continuation mode is on, the set of measured values obtained first after the trigger input is saved.

Input triggers as many times as needed.

4 Send the command to read the saved data.

:MEMory:DATA?

The saved measured values are returned as a response.

5 To clear measures values saved inside the instrument, send the following command.

:MEMory:CLEAr

Measured values are additionally saved with every trigger input until this command is sent.

Example response (:SYSTEM:COMMunicate:FORMat FLOAT)

```

:MEM:DATA?
1,+9.15600E-04,+6.0000000E-06
2,+9.15600E-04,+7.0000000E-06
3,+9.15500E04,+3.0000000E-06
4,+9.15600E-04,+1.0000000E-06
5,+9.15600E-04,+1.0000000E-05
END

```

The **END** string is added to the last line to be sent.

To receive the saved measured-value set individually, send the **:MEMory:DATA? STEP** command.

The instrument transmits one saved measured-value set and enters standby mode.

When the **N** command is sent from an external device including your computer, the instrument sends the subsequently saved measured-value set.

Repeat sending the **N** command and receiving a measured-value set to the last set.

After sending all saved measured-value sets, the instrument concludes by transmitting the **END** string.

Example response (:SYSTEM:COMMunicate:FORMat FLOAT)

```

:MEM:DATA? STEP
1,+9.15600E-04,+6.0000000E-06
N                               (Sent from computer)
2,+9.15600E-04,+7.0000000E-06
N                               (Sent from computer)
3,+9.15500E-04,+3.0000000E-06
N                               (Sent from computer)
4,+9.15600E-04,+1.0000000E-06
N                               (Sent from computer)
5,+9.15600E-04,+1.0000000E-05
N                               (Sent from computer)
END

```

- Up to 528 data sets can be saved. Please note that if you attempt to save additional data (by inputting triggers), further data will not be saved.
- For details on communication methods and command transmission/reception, see LAN (p. 153), RS-232C (p. 158), USB (p. 160), and Communications Command Instruction Manual.

IMPORTANT

The following operations cause measured values saved to be deleted collectively:

- Enabling the measured-value batch transmission capability by switching from off to on.
- Sending the **:MEMory:CLEar** command
- Performing the normal reset or system reset using the menu screen
- Sending the ***RST** command
- Sending the **:SYSTEM:RESet** or **:SYSTEM:PRESet** command
- Turning the instrument off and then on

You can create images in the bitmap format (extension: .bmp) by copying the display on the screen to save in a USB flash drive.

Specifications of USB (MEM mode)

See “USB (MEM mode)” (p.202).

11.1 Saving Screenshots (Onto a USB Flash Drive)

The USB flash drive can be used with the LAN or RS-232C interface simultaneously. USB (MEM mode) cannot be used with the USB port (COM mode) simultaneously.

CAUTION



- **Do not forcibly insert a USB flash drive upside down.**

Doing so could damage the instrument.

- **Before handling the Z4006 USB Drive, remove static electricity from your body.**

- **Turn the instrument on first, then insert the Z4006 USB Drive.**



Failure to do so could damage the Z4006 USB Drive or cause the instrument to malfunction. In addition, the instrument could fail to turn on.

- **When using a computer to format the Z4006 USB Drive, select the FAT32 file system.**

The Z4006 formatted with NTFS cannot operate properly.

Inserting the USB flash drive

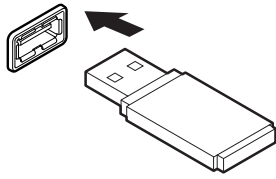

Insert a USB flash drive into the front-mounted USB connector.

- Use Mass Storage Class-compatible USB flash drives.
- The instrument does not support all commercially available USB flash drives.
- If the instrument does not recognize a USB flash drive, try to use a different one.

Removing the USB flash drive

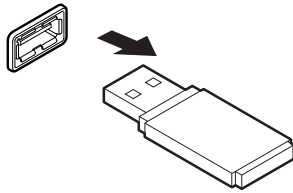

Confirm that the instrument is not accessing the USB flash drive (to output or load data) and then pull it out of the connector.

How to save screenshots

When using a USB flash drive, the USB port (COM mode), the rear-mounted USB connector, cannot be used.

[MENU] > [I/F]

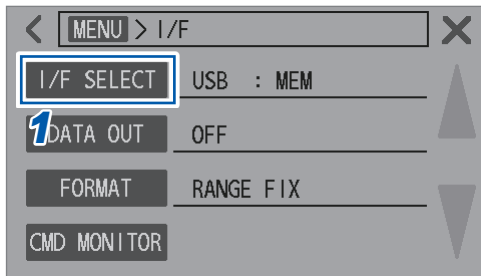

1 Tap [I/F SELECT].

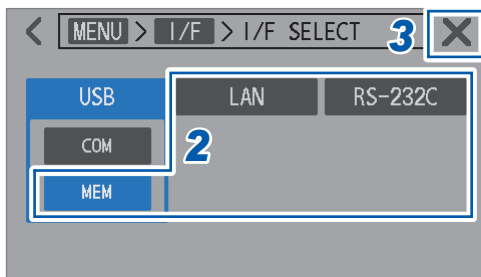

2 Select an interface other than [USB MEM].

If [USB COM] is selected, screenshots cannot be saved onto the USB flash drive.

3 Tap [X] in the upper right corner of the screen.

The screen returns to the measurement screen.

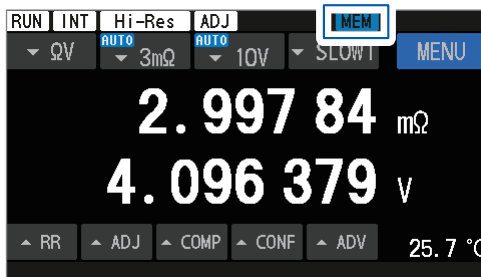

The [MEM] symbol appears in the upper right corner of the screen.

4 Insert a USB flash drive into the front-mounted USB connector.

The dimmed [MEM] symbol turns blue.

5 Hold the DISPLAY key for 2 s.

The screenshot is saved onto the USB flash drive.

Checking the saved screenshots

You can check screenshots saved on the USB flash drive only using computers, not the instrument.

When a screenshot is saved onto the USB flash drive for the first time, the **[HIOKI_BT]** folder is automatically created.

Screenshots are saved in the following folder/file structure:

[HIOKI_BT] > [SCRN_XXX.BMP]

XXX: Sequence number between 000 and 199

Extension: .BMP

If you delete the **[HIOKI_BT]** folder, another folder is created automatically next time you save a screenshot.

12 Specifications

12.1 General Specifications

Operating environment	Indoor use, pollution degree 2, altitude up to 2000 m (6562 ft.)	
Operating temperature and humidity range	0°C to 40°C (32°F to 104°F), 80% RH or less (non-condensing)	
Storage temperature and humidity range	-10°C to 50°C (14°F to 122°F), 80% RH or less (non-condensing)	
Standards	Safety	EN 61010
	EMC	EN 61326 Class A
Power supply	Commercial power	
	Rated supply voltage	100 V to 240 V AC (Assuming voltage fluctuation of ±10%)
	Rated power-supply frequency	50 Hz, 60 Hz
	Anticipated transient overvoltage	2500 V
	Maximum rated power	40 VA (BT6065, BT6075)
	Ordinary consumption power (reference value)	14 W (BT6065, BT6075) Conditions: A power voltage of 220 V, a power frequency of 50 Hz, 3 mΩ range is used (a measurement current of 300 mA)
Backup battery life	About 10 years (reference value at 23°C) The date and time can be backed up.	
Interface	LAN RS-232C USB (COM mode) USB (MEM mode, the Z4006 USB Drive is used) External I/O	
Display	4.3" color TFT LCD (IPS type), with a resistive membrane touchscreen	
Shield terminal	With the enclosure potential (connected to the power-inlet grounded terminal)	
Dimensions	Approx. 215W × 88H × 313D mm (8.5W × 3.5H × 12.3D in.)	
Weight	Approx. 3.1 kg (6.8 lbs)	
Product warranty duration	3 years	
Fuse	250V/1A, fast-blow fuse, embedded in Source Hi and Sense Hi terminals (not user-replaceable)	
Included accessories	See p.8.	
Optional equipment	See p.9.	
Supported product	SW1001/SW1002 Switch Mainframe Connectable via RS-232C or the external I/O	

12.2 Input, Output, and Measurement Specifications

Basic specifications

: Default setting

Measurement items	<ul style="list-style-type: none"> • Resistance (assuming internal resistance of batteries) • DC voltage (assuming open-terminal voltage of batteries) • Temperature (assuming ambient temperature) • Route resistance (assuming resistance of a test lead) Route resistance = Wiring resistance + Contact resistance Resistance of the following four paths is defined as route resistance. These resistance values do not include the internal resistance of an object under measurement (battery). <ul style="list-style-type: none"> $R_{Source\ Hi}$: Route resistance between Source Hi and an object under measurement (battery) $R_{Source\ Lo}$: Route resistance between Source Lo and an object under measurement (battery) $R_{Sense\ Hi}$: Route resistance between Sense Hi and an object under measurement (battery) $R_{Sense\ Lo}$: Route resistance between Sense Lo and an object under measurement (battery)
Measurable range	<ul style="list-style-type: none"> • Resistance: 0 Ω to 51 Ω <ul style="list-style-type: none"> Range configuration: 5 ranges 3 mΩ, 30 mΩ, 300 mΩ, 3 Ω, and 30 Ω High Resolution mode setting: <input checked="" type="checkbox"/>On, Off Applicable to all ranges Displayable counts range: With high resolution mode set to off -1000 to 51000 With high resolution mode set to on -10000 to 510000 On-screen counts for a range-value input: <ul style="list-style-type: none"> With high resolution mode set to off 30000 With high resolution mode set to on 300000 • DC voltage: 0 V to ± 120 V <ul style="list-style-type: none"> Range configuration: 2 ranges 10 V and 100 V Displayable counts range: <ul style="list-style-type: none"> 10 V range and 100 V range -1200000 to 1200000 (BT6065) -12000000 to 12000000 (BT6075) On-screen counts for a range-value input: <ul style="list-style-type: none"> 1000000 (BT6065) 10000000 (BT6075)

Measurable range (cont.)	<ul style="list-style-type: none"> Temperature: -10°C to 60°C (Celsius scale) 14°F to 140°F (Fahrenheit scale) <p>Range configuration: 1 range</p> <p>Displayable counts range: -100 to 600 (Celsius scale) 140 to 1400 (Fahrenheit scale)</p> <p>Celsius-to-Fahrenheit conversion formula: $T_F (°F) = (9/5) \times T_C (°C) + 32$</p> <hr/> <ul style="list-style-type: none"> Route resistance: 0 Ω to 500 Ω <p>Range configuration: The range is automatically fixed by selecting a resistance range. (See the <i>Accuracy Specifications</i> section)</p> <p>Display range:</p> <table border="0"> <tr> <td>-1.0 Ω to 10.0 Ω</td> <td>(3 mΩ resistance range with a measurement current of 300 mA)</td> </tr> <tr> <td>-1.0 Ω to 50.0 Ω</td> <td>(3 mΩ resistance range with a measurement current of 100 mA, 30 mΩ resistance range, 300 mΩ resistance range, and 3 Ω resistance range)</td> </tr> <tr> <td>-10 Ω to 500 Ω</td> <td>(30 Ω resistance range) (However, a resistance of 51 Ω to 500 Ω is not accuracy-guaranteed)</td> </tr> </table> <p>On-screen reading for a range-value input:</p> <table border="0"> <tr> <td>10.0 Ω</td> <td>(3 mΩ resistance range with a measurement current of 300 mA)</td> </tr> <tr> <td>50 Ω</td> <td>(30 Ω resistance range)</td> </tr> </table>	-1.0 Ω to 10.0 Ω	(3 mΩ resistance range with a measurement current of 300 mA)	-1.0 Ω to 50.0 Ω	(3 mΩ resistance range with a measurement current of 100 mA, 30 mΩ resistance range, 300 mΩ resistance range, and 3 Ω resistance range)	-10 Ω to 500 Ω	(30 Ω resistance range) (However, a resistance of 51 Ω to 500 Ω is not accuracy-guaranteed)	10.0 Ω	(3 mΩ resistance range with a measurement current of 300 mA)	50 Ω	(30 Ω resistance range)
-1.0 Ω to 10.0 Ω	(3 mΩ resistance range with a measurement current of 300 mA)										
-1.0 Ω to 50.0 Ω	(3 mΩ resistance range with a measurement current of 100 mA, 30 mΩ resistance range, 300 mΩ resistance range, and 3 Ω resistance range)										
-10 Ω to 500 Ω	(30 Ω resistance range) (However, a resistance of 51 Ω to 500 Ω is not accuracy-guaranteed)										
10.0 Ω	(3 mΩ resistance range with a measurement current of 300 mA)										
50 Ω	(30 Ω resistance range)										
Measurement methods	<ul style="list-style-type: none"> Resistance: AC four-terminal method Temperature: The Z2005 Temperature Sensor is used. 										
Measurement terminals	<ul style="list-style-type: none"> Resistance: Banana jacks (front-mounted) Measurement current flows from Source Hi to Source Lo. Voltage between Sense Hi and Sense Lo is detected. DC voltage: Banana jacks (front-mounted) Voltage between Sense Hi and Sense Lo is detected. Shield terminal: M4 screw (front-mounted) The following shield wires of a self-made test-lead assembly can be connected (connection recommended): Shield wire of Sense Hi and Sense Lo Shield wire of Source Hi and Source Lo Temperature: For the Z2005 Temperature Sensor (rear-mounted Temp. Sensor terminal) Four-terminal earphone jack (3.5 mm in diameter) 										
Number of channels	1 channel each for resistance, DC voltage, and temperature										
Measuring function	<p><input checked="" type="checkbox"/> Ω V: Resistance and DC voltage are measured simultaneously.</p> <p>Ω: Only resistance is measured.</p> <p>V: Only DC voltage is measured. (route-resistance monitor canceled)</p> <p>Temperature is always measured (when the Z2005 Temperature Sensor is connected).</p>										
3 mΩ range Measurement current setting	100 mA, <input checked="" type="checkbox"/> 300 mA										
DC input resistance (with 10 V range setting)	<p>Between the connection of Source Hi with Sense Hi and that of Source Lo with Sense Lo</p> <ul style="list-style-type: none"> Setting: <input checked="" type="checkbox"/>10 MΩ, HIGH Z <table border="1" data-bbox="520 1962 1241 2078"> <thead> <tr> <th>Measuring function</th> <th><input checked="" type="checkbox"/>10 MΩ</th> <th>HIGH Z</th> </tr> </thead> <tbody> <tr> <td>ΩV, Ω</td> <td>10 MΩ ±10%</td> <td>1 GΩ or more</td> </tr> <tr> <td>V</td> <td>10 MΩ ±10%</td> <td>10 GΩ or more</td> </tr> </tbody> </table> <p>With the 100 V range setting, the input resistance is fixed at the 10 MΩ setting.</p>	Measuring function	<input checked="" type="checkbox"/> 10 MΩ	HIGH Z	ΩV, Ω	10 MΩ ±10%	1 GΩ or more	V	10 MΩ ±10%	10 GΩ or more	
Measuring function	<input checked="" type="checkbox"/> 10 MΩ	HIGH Z									
ΩV, Ω	10 MΩ ±10%	1 GΩ or more									
V	10 MΩ ±10%	10 GΩ or more									

Open-circuit terminal voltage	Between Source Hi and Source Lo: ± 15 V max. (under normal operating conditions, for all resistance ranges) Between Sense Hi and Sense Lo: ± 2 V max. (under normal operating conditions)											
Maximum input voltage	Between the connection of Source Hi with Sense Hi and that of Source Lo with Sense Lo ± 120 V DC (AC voltage cannot be input) Protection against improper connections <table border="0" style="margin-left: 40px;"> <tr> <td>Between Source Hi and Sense Hi</td> <td>± 120 V DC (AC voltage cannot be input)</td> </tr> <tr> <td>Between Source Lo and Sense Lo</td> <td>± 120 V DC (AC voltage cannot be input)</td> </tr> </table>	Between Source Hi and Sense Hi	± 120 V DC (AC voltage cannot be input)	Between Source Lo and Sense Lo	± 120 V DC (AC voltage cannot be input)							
Between Source Hi and Sense Hi	± 120 V DC (AC voltage cannot be input)											
Between Source Lo and Sense Lo	± 120 V DC (AC voltage cannot be input)											
Maximum rated line-to-ground voltage	± 120 V DC Without a measurement category rating Anticipated transient overvoltage: 380 V											
Measurement time	Measurement items: Resistance, DC voltage, and route resistance <table border="1" style="margin-left: 40px; width: 100%;"> <thead> <tr> <th>Trigger source</th> <th>Trigger-reception continuation mode</th> <th>Measurement time</th> </tr> </thead> <tbody> <tr> <td rowspan="2">Internal</td> <td>On</td> <td rowspan="2">Measurement cycle</td> </tr> <tr> <td>Off</td> </tr> <tr> <td rowspan="2">External</td> <td>On</td> <td rowspan="2">Time from trigger input to EOM-signal activation</td> </tr> <tr> <td>Off</td> </tr> </tbody> </table> <p>The measurement time is defined as the following expression (The expression is common to internally triggered and externally triggered measurements). $T1 + T2 + T3 + T4 + T5 \pm 2$ ms</p> <p>T1: Delay time T2: Sampling time T3: Additional time for resistance-measurement MIR mode (only with the on setting) T4: DC-voltage self-calibration execution time (only with the Auto setting) T5: Operation time</p> <p>On-screen indication: [RUN] during measurement</p> <p>Measurement item: Temperature Approx. 2.2 s</p>	Trigger source	Trigger-reception continuation mode	Measurement time	Internal	On	Measurement cycle	Off	External	On	Time from trigger input to EOM-signal activation	Off
Trigger source	Trigger-reception continuation mode	Measurement time										
Internal	On	Measurement cycle										
	Off											
External	On	Time from trigger input to EOM-signal activation										
	Off											
Delay time	Time from trigger detection to sampling start Time predefined using the trigger-delay capability An internal delay time of 5 ms or less occurs for the internal circuitry to switch from the DC-voltage self-calibration operation to the measurement operation. When all of the following conditions are met, an internal delay of 10 ms or less occurs: Trigger source: Internal Trigger-reception continuation mode: Off DC-voltage self-calibration: Auto											

Sampling time

- Speed settings: 6 levels
Fast1, Fast2, Medium1, Medium2, Slow1, Slow2
- Sampling time:

Measuring function	Fast1	Fast2	Medium1 (Med1)	Medium2 (Med2)	Slow1	Slow2
ΩV (50 Hz) (60 Hz)	4 ms	10 ms	20 ms 17 ms	40 ms 33 ms	100 ms	200 ms
Ω (50 Hz) (60 Hz)	4 ms	10 ms	20 ms 17 ms	40 ms 33 ms	100 ms	200 ms
V (50 Hz) (60 Hz)	4 ms	10 ms	20 ms 17 ms	40 ms 33 ms	100 ms	200 ms

Route resistance measurement takes the same amount of time.
The line-frequency setting is indicated by values enclosed in parentheses.
Temperature: Fixed at approx. 2 s

Additional time for resistance-measurement MIR mode

Stabilizing time inserted during sampling in resistance-measurement MIR mode
With the resistance-measurement MIR mode set on: 6 ms to 12 ms

DC-voltage self-calibrating execution time

With Auto setting: 30 ms (50 Hz), 27 ms (60 Hz)
With Manual setting: Approx. 10 s (50 Hz, 60 Hz)
Measurement processing is stopped during a self-calibration process.

Calculation time

Approx. 0.5 ms

Response time

Measurement items: resistance, DC voltage, and route resistance
The analog response time refers to the duration it takes for the electrical signals of the internal measuring circuitry to stabilize within the specified measurement accuracy after the user transitions the test lead from being disconnected to being connected to an object under measurement (battery).
The response time varies with the object under measurement (battery).
 ΩV , Ω , and V functions
Approx. 8 ms when measuring a 4 V battery with a pure resistance

Accuracy Specifications

Accuracy guarantee conditions	Accuracy guarantee duration	1 year
	Accuracy guarantee temperature and humidity range	23°C ±5°C (73°F ±9°F), 80% RH or less
	Warm-up time	60 min. or more
	Resistance self-calibration	Always perform a process after warm-up.
	DC-voltage self-calibration	Always perform a process after warm-up.
	Conditions for resistance self-calibration and DC-voltage self-calibration	
	• Allowable change in temperature after a calibration process	
	Resistance	Within ±2°C Repeat the process if the temperature changes by more than ±2°C.
	DC voltage	Within ±0.1°C Repeat the process if the temperature changes by more than ±0.1°C.
	• Repeat the process within a 10-day interval for continuous operation.	
• If performing a calibration process outside the accuracy guarantee temperature range, add additional errors (temperature coefficient).		
Adjustment processing		
• Resistance measurement	Always perform a zero adjustment or configure the reference adjustment settings.	
• DC-voltage measurement	Always perform a zero adjustment.	
Measurement state	No change in the shape of the test lead during measurement Measurement must be conducted in the same measurement environments as during zero adjustment or when actual measurement data for reference adjustment is obtained.	
Measurement environments	Shape and arrangement of the test lead Presence/absence and arrangement of metal around the objects under measurement (battery) (Presence/absence and arrangement of other batteries around the battery under measurement)	

(1) Resistance measurement

Accuracy

Sampling speed	Range (Measurement current*1)					
	3 mΩ (300 mA)	3 mΩ (100 mA)	30 mΩ (100 mA)	300 mΩ (10 mA)	3 Ω (1 mA)	30 Ω (100 μA)
Fast1 High resolution Off	±0.12% rdg				±0.18% rdg	±0.24% rdg
	±0.4 μΩ	±2.0 μΩ	±2 μΩ	±20 μΩ	±400 μΩ	±6 mΩ
Fast2 High resolution Off	±0.11% rdg				±0.16% rdg	±0.20% rdg
	±0.3 μΩ	±1.4 μΩ	±2 μΩ	±20 μΩ	±300 μΩ	±5 mΩ
Medium1 High resolution Off	±0.10% rdg				±0.14% rdg	±0.18% rdg
	±0.2 μΩ	±0.9 μΩ	±1 μΩ	±10 μΩ	±200 μΩ	±4 mΩ
Medium2 High resolution Off	±0.09% rdg				±0.12% rdg	±0.16% rdg
	±0.2 μΩ	±0.7 μΩ	±1 μΩ	±10 μΩ	±100 μΩ	±2 mΩ
Slow1 High resolution Off	±0.08% rdg				±0.10% rdg	±0.15% rdg
	±0.1 μΩ	±0.6 μΩ	±1 μΩ	±10 μΩ	±100 μΩ	±1 mΩ
Slow2 High resolution Off	±0.08% rdg				±0.10% rdg	±0.15% rdg
	±0.1 μΩ	±0.5 μΩ	±1 μΩ	±10 μΩ	±100 μΩ	±1 mΩ

Maximum display value High resolution Off	5.1000 mΩ	5.1000 mΩ	51.000 mΩ	510.00 mΩ	5.1000 Ω	51.000 Ω
	5.10000 mΩ	5.10000 mΩ	51.00000 mΩ	510.000 mΩ	5.10000 Ω	51.00000 Ω
Resolution High resolution Off	0.1 μΩ	0.1 μΩ	1 μΩ	10 μΩ	100 μΩ	1 mΩ
	0.01 μΩ	0.01 μΩ	0.1 μΩ	1 μΩ	10 μΩ	100 μΩ
Measurement-current frequency	1 kHz ±0.2 Hz					

*1. RMS value, with a measurement-current error of within ±10 %

Additional accuracy deterioration	Description
Temperature coefficient	In the temperature range of 0°C to 18°C and 28°C to 40°C, add the following values to the measurement accuracy. (Measurement accuracy × 0.1)/°C
Addition for resistance-measurement MIR mode	For both primary and secondary instruments, add ±0.01 percent points of reading to the resistant measurement.

Effects of radiative radio-frequency magnetic field	10% of a corresponding range value at a strength of 10 V/m (80 MHz to 1 GHz) or 3 V/m (1 GHz to 6 GHz)
Effects of conductive radio-frequency magnetic field	10% of a corresponding range value at a strength of 10 V

(2) DC-voltage measurement

a. BT6065

Accuracy

Sampling speed	Range			
	10 V		100 V	
Fast1	±0.002% of reading	±50 µV	±0.004% of reading	±0.9 mV
Fast2	±0.002% of reading	±40 µV	±0.004% of reading	±0.8 mV
Medium1	±0.002% of reading	±30 µV	±0.004% of reading	±0.8 mV
Medium2	±0.002% of reading	±30 µV	±0.004% of reading	±0.8 mV
Slow1	±0.002% of reading	±20 µV	±0.004% of reading	±0.7 mV
Slow2	±0.002% of reading	±20 µV	±0.004% of reading	±0.6 mV

Maximum display value	±12.00000 V	±120.0000 V
Resolution	10 µV	100 µV

Additional accuracy deterioration	Description
Temperature coefficient	In the temperature range of 0°C to 18°C and 28°C to 40°C, add the following values to the measurement accuracy. (Measurement accuracy × 0.1)/°C

Effects of radiative radio-frequency magnetic field	1% of a corresponding range value at a strength of 10 V/m (80 MHz to 1 GHz) or 3 V/m (1 GHz to 6 GHz)
Effects of conductive radio-frequency magnetic field	1% of a corresponding range value at a strength of 10 V

b. BT6075

Accuracy

Sampling speed	Range			
	10 V		100 V	
Fast1	±0.0012% of reading	±41 µV	±0.003% of reading	±0.90 mV
Fast2	±0.0012% of reading	±31 µV	±0.003% of reading	±0.80 mV
Medium1	±0.0012% of reading	±26 µV	±0.003% of reading	±0.75 mV
Medium2	±0.0012% of reading	±26 µV	±0.003% of reading	±0.75 mV
Slow1	±0.0012% of reading	±16 µV	±0.003% of reading	±0.65 mV
Slow2	±0.0012% of reading	±11 µV	±0.003% of reading	±0.60 mV

Maximum display value	±12.000000 V	±120.00000 V
Resolution	1 µV	10 µV

Additional accuracy deterioration	Description
Temperature coefficient	In the temperature range of 0°C to 18°C and 28°C to 40°C, add the following values to the measurement accuracy. (Measurement accuracy × 0.1)/°C

Effects of radiative radio-frequency magnetic field	1% of a corresponding range value at a strength of 10 V/m (80 MHz to 1 GHz) or 3 V/m (1 GHz to 6 GHz)
Effects of conductive radio-frequency magnetic field	1% of a corresponding range value at a strength of 10 V

(3) Temperature measurement

Temperature scale	Celsius scale	Fahrenheit scale
Range	-10.0°C to 60.0°C	14.0°F to 140.0°F
Maximum display value	60.0°C	140.0°F
Resolution	0.1°C	0.1°F
Accuracy (BT6065/ BT6075 only)	±0.1°C	±0.2°F
Temperature coefficient (BT6065/BT6075 only)	±0.01°C/°C	±0.018°F/°C
Accuracy (Combination of BT6065/BT6075 and Z2005)	±0.5°C (Measurement temperature range: 10.0°C to 40.0°C) ±1.0°C (Measurement temperature range: -10.0°C to 9.9°C, 40.1°C to 60.0°C)	±0.9°F (Measurement temperature range: 50.0°F to 104.0°F) ±1.8°F (Measurement temperature range: 14.0°F to 49.8°F, 104.2°F to 140.0°F)

Effects of conductive radio-frequency magnetic field	±1°C of a corresponding range value at a strength of 10 V
--	---

(4) Route resistance measurement

Resistance range	3 mΩ		30 mΩ	300 mΩ	3 Ω	30 Ω
Resistance measurement current	300 mA	100 mA	100 mA	10 mA	1 mA	100 μA
Maximum display value	10.0 Ω	50.0 Ω	50.0 Ω	50.0 Ω	50.0 Ω	500 Ω
Guaranteed accuracy upper limit	10.0 Ω	50.0 Ω	50.0 Ω	50.0 Ω	50.0 Ω	50 Ω
Route-resistance resolution	0.1 Ω	0.1 Ω	0.1 Ω	0.1 Ω	0.1 Ω	1 Ω
Accuracy*1	The accuracy is defined within the operating temperature and humidity range. 3 mΩ, 30 mΩ, 300 mΩ, and 3 Ω resistance ranges: 3.0% of reading ±0.5 Ω 30 Ω resistance ranges: 3.0% of reading ±3 Ω					

*1. Source Hi/Lo: The sum of $R_{Source\ Hi}$ and $R_{Source\ Lo}$ is not allowed to exceed the guaranteed accuracy upper limit.
Sense Hi/Lo: Each of the sum of $R_{Source\ Hi}$ and $R_{Source\ Lo}$ and that of $R_{Sense\ Hi}$ and $R_{Sense\ Lo}$ is not allowed to exceed the upper accuracy guarantee limit.

Additional accuracy deterioration	Description
Temperature coefficient	In the temperature range of 0°C to 18°C and 28°C to 40°C, add the following values to the measurement accuracy. (Measurement accuracy × 0.1)/°C

Effects of conductive radio-frequency magnetic field ±5 Ω at a strength of 10 V

12.3 Functional Specifications

☑: Default setting

Trigger	Operation	Starting a measurement												
	Settings	Trigger source	☑Internal, External											
		Trigger-reception continuation mode	☑On, Off											
<table border="1"> <thead> <tr> <th rowspan="2">Trigger source</th> <th colspan="2">Trigger-reception continuation mode</th> </tr> <tr> <th>On</th> <th>Off</th> </tr> </thead> <tbody> <tr> <td>Internal</td> <td>Continuous measurements (Free run)</td> <td> <ol style="list-style-type: none"> Entering a trigger-reception state with the dedicated command. Making a single measurement. Leaving the trigger-reception state. </td> </tr> <tr> <td>External</td> <td>With a trigger input Single measurement.</td> <td> <ol style="list-style-type: none"> Entering a ready-for-trigger state with the dedicated command. Making a single measurement with a trigger input. Entering a non-trigger-reception state. </td> </tr> </tbody> </table>				Trigger source	Trigger-reception continuation mode		On	Off	Internal	Continuous measurements (Free run)	<ol style="list-style-type: none"> Entering a trigger-reception state with the dedicated command. Making a single measurement. Leaving the trigger-reception state. 	External	With a trigger input Single measurement.	<ol style="list-style-type: none"> Entering a ready-for-trigger state with the dedicated command. Making a single measurement with a trigger input. Entering a non-trigger-reception state.
Trigger source	Trigger-reception continuation mode													
	On	Off												
Internal	Continuous measurements (Free run)	<ol style="list-style-type: none"> Entering a trigger-reception state with the dedicated command. Making a single measurement. Leaving the trigger-reception state. 												
External	With a trigger input Single measurement.	<ol style="list-style-type: none"> Entering a ready-for-trigger state with the dedicated command. Making a single measurement with a trigger input. Entering a non-trigger-reception state. 												
How to set														
Trigger source		By tapping the touchscreen or sending a command												
Trigger-reception continuation mode		Can be turned off by a command only. When returning to the local state or being turned off then on again, the instrument reverts the trigger-reception continuation mode to on.												
External trigger		Triggered by pressing a physical key, using the external I/O, or sending a command												
Trigger delay	Operation	Starting sampling after waiting for a predefined time following a trigger input												
	Settings	On (☑0 ms to 10000 ms), ☑Off												
	How to set	By tapping the touchscreen or sending a command												
	Note	Setting a time exceeding the response time is recommended.												

Averaging	Operation	Averaging measured values For internally triggered measurement: Moving average when trigger-reception continuation mode is on Simple average when trigger-reception continuation mode is off Externally triggered measurement: Simple average			
	Measurement items	Resistance, DC voltage, and route resistance			
	Settings	On (<input checked="" type="checkbox"/> 1 to 256 times), <input checked="" type="checkbox"/> Off			
	On-screen readings	Internally triggered measurement: When trigger-reception continuation mode is on, readings are displayed even before the measurement count reaches the predefined number. When trigger-reception continuation mode is off, readings are displayed when the measurement count reaches the predefined number. Externally triggered measurement: Readings are displayed when the measurement count reaches the predefined number.			
	How to set	By tapping the touchscreen or sending a command			
	Note	Initialized when the measurement condition is changed. Initialized after the instrument reverts to normal in case of a measurement error. With the Ω V measuring function, initialized after both the Ω and V measurements revert to normal.			
Manual range	Operation	Defining a resistance measurement range Defining a DC-voltage measurement range			
	How to set	By pressing physical keys, tapping the touchscreen, or sending a command Switching the manual ranging to the auto-ranging is applied to both resistance and DC-voltage measurements.			
Auto-ranging	Operation	Automatically defining a resistance measurement range Automatically defining a DC-voltage measurement range			
		Measurement items	Range	Switching to the upper range	Switching to the lower range
		Resistance	3 m Ω	Over 5.1 m Ω	–
			30 m Ω	Over 51 m Ω	3 m Ω or less
			300 m Ω	Over 510 m Ω	30 m Ω or less
			3 Ω	Over 5.1 Ω	300 m Ω or less
			30 Ω	–	3 Ω or less
		DC voltage	10 V	Over 12 V or less than –12 V	–
			100 V	–	10 V or less but –10 V or more
	Settings	<input checked="" type="checkbox"/> On, Off (Off setting: Manual ranging) Resistance-and-DC voltage simultaneous setting			
	How to set	By pressing physical keys, tapping the touchscreen, or sending a command			

Overrange indication	Operation	Indicating that measured values are outside the displayable counts ranges or display ranges
	• Resistance/DC voltage On-screen information	+OVER, -OVER, and unit of measure
	• Temperature On-screen information	+OVER, -OVER, and unit of measure
	• Route resistance On-screen information	+OVER, -OVER Route (Source Hi, Source Lo, Sense Hi, and Sense Lo)

Contact check (Wire-break detection)	• Resistance, DC voltage, and route resistance	
	Operation	<ol style="list-style-type: none"> 1. Detecting a wire break between Source Hi and Source Lo to indicate it Supported measuring functions: ΩV and Ω (V not supported) 2. Detecting a wire break between Sense Hi and Sense Lo to indicate it Supported measuring functions: ΩV, Ω, and V If a Source-side break is detected, Sense-side breaks cannot be detected.

Wire-break thresholds

Resistance range	Resistance measurement current	Between Source Hi and Source Lo	Between Sense Hi and Sense Lo
3 mΩ	300 mA	11 Ω or more	110 Ω or more
	100 mA	52 Ω or more	110 Ω or more
30 mΩ	100 mA	52 Ω or more	110 Ω or more
300 mΩ	10 mA	600 Ω or more	110 Ω or more
3 Ω	1 mA	6 kΩ or more	110 Ω or more
30 Ω	100 μA	60 kΩ or more	1100 Ω or more

Measuring function	DC-voltage range	Between Sense Hi and Sense Lo
V	10 V	110 Ω or more
	100 V	110 Ω or more

On-screen information	Resistance	[-----] [Unit of measure]
	Voltage	[-----] [Unit of measure]
	Route resistance	[-----]
		[SOURCE CONTACT ERROR] [SENSE CONTACT ERROR]

• Temperature	Operation	Detecting a connection error with the Z2005 Temperature Sensor to indicate it
	On-screen information	[-- . -°C], [-- . -°F]

Route-resistance check	• Resistance, DC voltage, and route resistance
	<p>Operation</p> <p>Detecting abnormal route-resistance values to indicate it Supported measuring functions: ΩV and Ω (V not supported)</p>
	<p>Judgment criteria</p> <p>When one of the following conditions is satisfied:</p> <ul style="list-style-type: none"> • Either one of $R_{Source\ Hi}$, $R_{Source\ Lo}$, $R_{Sense\ Hi}$, and $R_{Sense\ Lo}$ exits the accuracy guarantee range or does not meet the accuracy guarantee conditions. • The sum of $R_{Source\ Hi}$ and $R_{Source\ Lo}$ exceeds the guaranteed accuracy upper limit. • The sum of $R_{Sense\ Hi}$ and $R_{Sense\ Lo}$ exceeds the guaranteed accuracy upper limit. • Either one of $R_{Source\ Hi}$, $R_{Source\ Lo}$, $R_{Sense\ Hi}$ and $R_{Sense\ Lo}$ exceeds the fail judgment threshold of the route-resistance monitor.
On-screen information	<p>Resistance</p> <p>[-----] [Unit of measure]</p> <hr/> <p>Voltage</p> <p>[-----] [Unit of measure]</p> <hr/> <p>Route resistance</p> <p>Alert symbol (⚠) near a reading corresponding to an error</p> <hr/> <p>[SOURCE CONTACT ERROR] [SENSE CONTACT ERROR]</p>
Resistance self-calibration	<p>Operation</p> <p>Correcting fluctuations in the resistance measuring circuitry</p>
	<p>How to perform</p> <p>By pressing a physical key and then tapping the touchscreen, sending a command, or using the external I/O</p>
	<p>Note</p> <p>Always perform a process without inputting any signals into the measurement terminals. Calibration error judgment and indication (with or without voltage input, adjustment range exceeded)</p>
DC-voltage self-calibration	<p>Operation</p> <p>Correcting fluctuations in the DC voltage measuring circuitry</p>
	<p>Settings</p> <p><input checked="" type="checkbox"/>Auto, Manual</p> <p>Auto: Automatically performed internally and can also be performed manually.</p> <p>Manual: Can be performed by pressing a physical key and then tapping the touchscreen, sending a command, or using the external I/O.</p>
	<p>How to set</p> <p>By pressing a physical key and then tapping the touchscreen, sending a command, or using the external I/O</p>
	<p>Note</p> <p>With the manual setting, when the instrument is configured with the external trigger setting and is on standby for a trigger, it performs a DC-voltage self-calibration process.</p>
	<p>Operation</p> <p>Converting negative measured values into absolute values With the assumption that an object under measurement (battery) is connected in reverse polarity</p>
DC voltage-to-absolute value conversion	<p>Settings</p> <p>On, <input checked="" type="checkbox"/>Off</p>
	<p>How to set</p> <p>By tapping the touchscreen or sending a command</p>

Zero-display	Operation	Displaying zero as readings for measured values that fall within the zero-display range		
	Settings	On, <input checked="" type="checkbox"/> Off		
Zero-display range				
Resistance				
	Range	High resolution		
		Off	On	
	3 mΩ (300 mA)	±0.1 μΩ	±0.08 μΩ	
	3 mΩ (100 mA)	±0.5 μΩ	±0.50 μΩ	
	30 mΩ	±1 μΩ	±0.5 μΩ	
	300 mΩ	±10 μΩ	±5 μΩ	
	3 Ω	±100 μΩ	±50 μΩ	
	30 Ω	±1 mΩ	±0.5 mΩ	
DC voltage				
	Range	BT6065	BT6075	
	10 V	±20 μV	±11 μV	
	100 V	±0.6 mV	±0.60 mV	
	How to set	By tapping the touchscreen or sending a command		
Adjustment	Operation	Selecting a type of adjustment and activating the adjustment capability. See the following pages: “Zero adjustment” (p. 191) “Referential adjustment” (p. 192)		
	Settings	<input checked="" type="checkbox"/> Zero adjustment, Reference adjustment, Off Zero-adjustment values are applied to resistance and DC-voltage measurement simultaneously.		
	How to set	By tapping the touchscreen or sending a command		
Zero adjustment	Operation	Canceling offsets caused by measurement environments Saving offset values in the internal memory of the instrument as zero-adjustment values in association with the corresponding channel measurement environment.		
	Number of measurement environments (channels)	Ch. 1 to Ch. 528 Ch. 2 to Ch. 528 are assumed for use with the Switch Mainframe.		
	Input	Inputting a resistance of 0 Ω and a voltage of 0 V (such as connecting a zero-adjustment board) is assumed. Adjustment values are applied to resistance and DC-voltage measurement simultaneously.		
	Measurement items	Resistance and DC voltage		
	Settings	Channel mode setting	<input checked="" type="checkbox"/> Single-channel, Multi-channel	
		Target channel setting (start)	Ch. 1 to Ch. 528	
		Target channel setting (end)	Start channel to Ch. 528	
The target channels can be set only in multi-channel mode.				

Zero adjustment (cont.)	How to set	Executing an adjustment-value obtainment By pressing a physical key and then tapping the touchscreen, sending a command, or using the external I/O																				
	Adjustment target	Using/selecting adjustment values By tapping the touchscreen or sending a command																				
		<table border="1"> <thead> <tr> <th rowspan="2">Adjustment condition</th> <th colspan="2">Channel mode</th> </tr> <tr> <th>Single-channel</th> <th>Multi-channel (Ch. 1 to Ch. 528)</th> </tr> </thead> <tbody> <tr> <td>Measuring function</td> <td>Selected function*¹</td> <td>Selected function</td> </tr> <tr> <td>Resistance range</td> <td>Selected range*²</td> <td>Selected range</td> </tr> <tr> <td>DC-voltage range</td> <td>Selected range*²</td> <td>Selected range</td> </tr> <tr> <td>Measurement current of the 3 mΩ range</td> <td>Selected current setting*²</td> <td>Selected current setting</td> </tr> <tr> <td>DC input resistance setting</td> <td>Selected resistance setting*²</td> <td>Selected resistance setting</td> </tr> </tbody> </table>	Adjustment condition	Channel mode		Single-channel	Multi-channel (Ch. 1 to Ch. 528)	Measuring function	Selected function* ¹	Selected function	Resistance range	Selected range* ²	Selected range	DC-voltage range	Selected range* ²	Selected range	Measurement current of the 3 mΩ range	Selected current setting* ²	Selected current setting	DC input resistance setting	Selected resistance setting* ²	Selected resistance setting
Adjustment condition	Channel mode																					
	Single-channel	Multi-channel (Ch. 1 to Ch. 528)																				
Measuring function	Selected function* ¹	Selected function																				
Resistance range	Selected range* ²	Selected range																				
DC-voltage range	Selected range* ²	Selected range																				
Measurement current of the 3 mΩ range	Selected current setting* ²	Selected current setting																				
DC input resistance setting	Selected resistance setting* ²	Selected resistance setting																				
		<p>Adjustment values can be saved for single-channel and multi-channel modes separately.</p> <p>Each single-channel adjustment value is saved by overwriting for each range.</p> <p>*1. Adjustment values are shared by the ΩV, Ω, and V functions. Example: When a zero adjustment is performed with the ΩV function, the adjustment values are also applied to the Ω and V functions.</p> <p>*2. With the Auto-ranging setting, a zero adjustment is performed for all ranges.</p>																				
	Adjustment range (counts value)	<p>Resistance 3 mΩ range: -30000 to 30000 (with high resolution mode set to off) -300000 to 300000 (with high resolution set to on) 30 mΩ range, 300 mΩ range, 3 Ω range, and 30 Ω range: -3000 to 3000 (with high resolution mode set to off) -30000 to 30000 (with high resolution mode set to on)</p> <p>DC voltage -3000 to 3000 (BT6065) -30000 to 30000 (BT6075)</p>																				
	On-screen information	<p>During the zero adjustment [ZERO ADJUSTING] (on the message bar)</p> <p>During use of the zero adjustment [ADJ] (on the status bar)</p>																				
Referential adjustment	Operation	Canceling offsets caused by measurement environments The offset values are saved in the internal memory of the instrument as referential-adjustment values in association with the corresponding channel measurement environment.																				
	Number of measurement environments (channels)	Ch. 1 to Ch. 528 Ch. 2 to Ch. 528 are assumed for use with the Switch Mainframe.																				
	Measurement items	Resistance																				

Referential adjustment (cont.)	Execution items for adjustment	Reference-value zero adjustment (Always perform before obtaining reference values) Reference value (internal resistance value of the reference battery; the on-screen information is [BASE]) Actual measured values (internal resistance values of the reference battery measured in each measurement environment; it is recommended to use the same object for both reference-value obtainment and measurements)	
	Referential-adjustment values	Differences between the reference value and actual measured values	
Settings	Target channel setting (start)	Ch. 1 to Ch. 528	
	Target channel setting (end)	Start channel to Ch. 528	
How to obtain reference values	By pressing a physical key and then tapping the touchscreen, or sending a command		
How to obtain actual measured values	By pressing a physical key and then tapping the touchscreen, or sending a command		
Assigning measurement environments (channels) at application of zero-adjustment values	By tapping the touchscreen or sending a command		
Adjustment target			
Adjustment condition		Multi-channel mode (Ch. 1 to Ch. 528)	
Measuring function		Selected function (ΩV , Ω)* ¹	
Resistance range		Selected range	
Measurement current of the 3 m Ω range		Selected current setting	
DC input resistance		Selected resistance setting	
Each adjustment value is saved by overwriting. The selection of adjustment targets is common for Ch. 1 to Ch. 528.			
*1. When the ΩV function is selected, DC voltage is set with the reference-value zero adjustment.			
Adjustment range (set of digits)			
Resistance	3 m Ω range: -30000 to 30000 (with high resolution mode set to off) -300000 to 300000 (with high resolution mode set to on) 30 m Ω range, 300 m Ω range, 3 Ω range, and 30 Ω range: -3000 to 3000 (with high resolution mode set to off) -30000 to 30000 (with high resolution mode set to on)		
On-screen information	During the reference-value zero adjustment [BASE ZERO ADJUSTING] (on the message bar)		
	During the reference-value obtainment [BASE OBTAINING] on the message bar)		
	During the referential adjustment [REFERENTIAL ADJUSTING] (on the message bar)		
	During use of the referential adjustment [ADJ] (on the status bar)		

Route-resistance monitor	Operation	Displaying measured route-resistance values (Source Hi, Source Lo, Sense Hi, and Sense Lo) Judgment output (display, external I/O)
	How to display	By pressing a physical key or tapping the touchscreen
	Judgment output	Pass, Warning, Fail When providing a Fail judgment (measurement error), the instrument displays no resistance and DC voltage readings.
	Settings	Judgment: <input checked="" type="checkbox"/> On, Off Fail judgment threshold Warning judgment threshold
	How to set	By tapping the touchscreen
	Judgment thresholds	The warning and fail thresholds can be defined within the ranges specified in the table. The following inequality must be true: Warning threshold \leq Fail threshold

Resistance range	Resistance measurement current	Between Source Hi and an object under measurement (battery) Between Source Lo and an object under measurement (battery)	Between Sense Hi and an object under measurement (battery) Between Sense Lo and an object under measurement (battery)
3 m Ω	300 mA	-10.0 Ω to \sphericalangle 50.0 Ω (Measurement is limited up to 10.0 Ω)	
	100 mA		
30 m Ω	100 mA		
300 m Ω	10 mA	-10.0 Ω to \sphericalangle 50.0 Ω	
3 Ω	1 mA		
30 Ω	100 μ A		

Supported measuring functions: Ω V and Ω (V not supported)

Resistance-measurement MIR mode (Mutual interference reduction mode)	Operation	Surpassing drifts of resistance measured values caused by the interference of the resistance measurement signals
	Number of target instruments	Up to two instrument can be closely placed; three or more are not allowed.
	Settings	On (<input checked="" type="checkbox"/> Primary, Secondary), <input checked="" type="checkbox"/> Off The primary and secondary instruments are considered a set. The settings for the sampling speed, DC-voltage self-calibration (Auto/Manual), and line-frequency setting are sheared by the two.
	How to set	By tapping the touchscreen or sending a command
	Note	Additional accuracy deterioration is present for resistance measurement.
Line-frequency setting	Operation	Stabilizing measured values by setting the line frequency
	Settings	<input checked="" type="checkbox"/> Auto, 50 Hz, 60 Hz (With the Auto setting, the line-frequency setting is automatically adjusted to 50 Hz or 60 Hz upon detection during instrument startup and reset)
	How to set	By tapping the touchscreen or sending a command

Measured-value batch transmission (memory)	Operation	Saving measured values in the internal memory of the instrument in response to an external trigger input Transmitting and deleting saved measured values in batches in response to a command input With the external trigger source setting: Making a single measurement to save measured values With the internal trigger source setting: When trigger-reception continuation mode is off, making a single measurement to save measured values When trigger-reception continuation mode is on, saving measured values obtained first after a trigger input
	Settings	On, <input checked="" type="checkbox"/> Off (saving operation)
	How to set	By sending a command
	Maximum number of data sets to be saved	528
	Saved contents	Memory number, and measured values of resistance and DC voltage
	Memory	Volatile, no backup
Measured-value output	Operation	Outputting measured values in response to an external-trigger input With the external trigger source setting: Making a single measurement to output measured values With the internal trigger source setting: When trigger-reception continuation mode is off, making a single measurement to output measured values When trigger-reception continuation mode is on, outputting measured values obtained first after a trigger input
	Output destination	LAN, RS-232C, or USB (COM mode) Outputting data via a selected interface
	Output contents	Measured values of resistance, DC voltage, temperature, and route resistance
	Settings	On, <input checked="" type="checkbox"/> Off
	How to set	By tapping the touchscreen or sending a command
	Measured-value format	Operation
Settings		<input checked="" type="checkbox"/> Range fix, Float Range fix: Fixes the exponent part based on the measurement range. Float: Uses the floating-point notation.
How to set		By tapping the touchscreen or sending a command
Operation-feedback sound	Operation	Generating sounds when physical keys are pressed or the touchscreen is tapped.
	Settings	<input checked="" type="checkbox"/> On, Off
	How to set	By tapping the touchscreen or sending a command

Date and time	Operation	24-hour clock, leap-year auto-correction
	Clock accuracy	±4 min./month
	Settings	Year, month, date, hour, minute, and second
	How to set	By tapping the touchscreen or sending a command
	Note	The built-in lithium battery for backup has a life of about 10 years. If the battery is depleted, the date and time revert to 2022/1/1 (January 1, 2022) 00:00:00.
Time zone setting	How to set	By tapping the touchscreen or sending a command
Start button	Operation	Sleep mode setting (when the main power switch is set to the on position)
	Button color and settings	Unlit: Turned off (no power supplied) Lights up in red: In sleep mode (with power supplied) <input checked="" type="checkbox"/> Lights up in green: Out of sleep mode, turned on Lights up in orange: Out of sleep mode, turned on, an error found
Key lock	Operation	Locking the physical keys and touchscreen Only the TRIGGER key operation is enabled.
	Settings	On, <input checked="" type="checkbox"/> Off
	How to set	By tapping the touchscreen, sending a command, or using the external I/O With the physical keys and touchscreen locked, hold [UNLOCK] (for 1 s) on the touchscreen to unlock them. When the physical keys and touchscreen are locked by using the external I/O, the instrument does not display [UNLOCK] and they can be unlocked through the external I/O.
	On-screen information	KEYLOCK, UNLOCK
Local/Remote	Operation	Defining operational mode of LAN, RS-232C, and USB (COM mode) Local state: The physical keys and touchscreen are not locked. Remote state: The physical keys and touchscreen are locked. However, the TRIGGER key operation is enabled. Communications are available.
	Settings	<input checked="" type="checkbox"/> Local, Remote Transition from local to remote: When a command is received Transition from remote to local: When a dedicated command is received, the instrument is turned off then on again, or the touchscreen is tapped With LAN and USB (COM mode) settings, the instrument also switches to local when communications is disrupted.
	On-screen information	The [REMOTE] symbol appears in the remote state.

Comparator	Operation	Outputting judgments on measured values of resistance and DC voltage																		
	Settings	Judgment: On, <input checked="" type="checkbox"/> Off Upper and lower thresholds for resistance Upper and lower thresholds for DC voltage DC voltage absolute-value judgment: On, <input checked="" type="checkbox"/> Off																		
	How to set	By tapping the touchscreen or sending a command																		
	Judgment output	Resistance judgment and DC voltage judgment Hi: Over the upper threshold In: Within the threshold range Lo: Less than the lower threshold --: Judgment unavailable (such as break detection)																		
	Buzzer settings																			
	<table border="1"> <thead> <tr> <th>Settings</th> <th>In judgment is provided for both resistance and DC voltage.</th> <th>Hi or Lo judgment is provided, or the judgment is marked as unavailable (--) for either resistance or DC voltage.</th> </tr> </thead> <tbody> <tr> <td><input checked="" type="checkbox"/>Off</td> <td>-</td> <td>-</td> </tr> <tr> <td>HI/LO</td> <td>-</td> <td>Intermittent short sounds</td> </tr> <tr> <td>IN</td> <td>Continuous sound</td> <td>-</td> </tr> <tr> <td>BOTH1</td> <td>Continuous sound</td> <td>Intermittent short sounds</td> </tr> <tr> <td>BOTH2</td> <td>One short sound</td> <td>Intermittent short sounds</td> </tr> </tbody> </table>	Settings	In judgment is provided for both resistance and DC voltage.	Hi or Lo judgment is provided, or the judgment is marked as unavailable (--) for either resistance or DC voltage.	<input checked="" type="checkbox"/> Off	-	-	HI/LO	-	Intermittent short sounds	IN	Continuous sound	-	BOTH1	Continuous sound	Intermittent short sounds	BOTH2	One short sound	Intermittent short sounds	
Settings	In judgment is provided for both resistance and DC voltage.	Hi or Lo judgment is provided, or the judgment is marked as unavailable (--) for either resistance or DC voltage.																		
<input checked="" type="checkbox"/> Off	-	-																		
HI/LO	-	Intermittent short sounds																		
IN	Continuous sound	-																		
BOTH1	Continuous sound	Intermittent short sounds																		
BOTH2	One short sound	Intermittent short sounds																		
	PASS signal of the external I/O	With the ΩV function, the PASS signal is output when In judgments is provided for both resistance and DC voltage.																		
Command compatibility	Operation	Setting the command compatibility Upwardly compatible with the BT3562A Battery HiTester Non-upwardly compatible (normal mode)																		
	Settings	Upwardly compatible, <input checked="" type="checkbox"/> Non-upwardly compatible																		
	How to set	By sending a command																		
Automatic settings backup	Operation	Automatically saving various settings Loading saved settings on instrument startup																		
Resetting capability	Operation	Reverting all settings to the factory-default settings.																		
	• Normal reset Non-reverted settings	Date and time, time zone, temperature scale, LAN setting, RS-232C setting, USB setting, saved panel data, adjustment values, and calibration values																		
	• System reset Non-reverted settings	Date and time, time zone, temperature scale, and calibration values However, the LAN, RS-232C, and USB settings are retained when the system reset is performed by sending a command.																		
	How to set	By tapping the touchscreen or sending a command																		

Measurement-conditions saving (Panel saving) Measurement-conditions loading (Panel loading)	Operation	Saving the present measurement conditions in the internal memory of the instrument Loading saved measurement conditions Deleting saved measurement conditions	
	Number of conditions to be saved	6	
	How to save and delete	By tapping the touchscreen	
	How to load	By tapping the touchscreen, sending a command, or using the external I/O	
Saved contents			
Up to 10-letter panel name (Can be entered with the touchscreen)	DC voltage-to-absolute value conversion	Resistance-measurement MIR mode	
Save date and time	Comparator	Key lock	
Measuring function	Measured-value batch transmission	Measured-value output	
Auto/Manual ranging	Measured-value format	Backlight-brightness adjustment	
Measurement current setting	Screensaver	Measured-value colors	
High resolution	Measured-value colors	Operation-feedback sound	
Sampling speed	Operation-feedback sound	Command compatibility	
DC-voltage self-calibration	Command compatibility	External I/O signal settings (TRIG, EOM, ERR)	
DC input resistance	External I/O signal settings (TRIG, EOM, ERR)	Measurement screen configuration	
Trigger	Measurement screen configuration	Line-frequency setting	
Trigger delay	Line-frequency setting	Advanced mode	
Averaging	Advanced mode		
Zero adjustment			
Referential adjustment			
Route-resistance monitor			
Zero-display			
Measurement information	Operation	Showing various information on the display	
	On-screen information	Model name, firmware version number, FPGA1 version number, FPGA2 version number, and serial number	
	How to display	By tapping the touchscreen	
Error display 1	Operation	Displaying errors that require inspection or repair	
	No.	On-screen message	Description
	390	ROM ERROR	ROM data damaged.
	391	POWER SUPPLY ERROR	Power supply damaged.
	392	FAN ERROR	Fan operation anomaly occurred.
	393	FPGA ERROR	FPGA failed to start (digital/analog)
	394	FRAM ERROR	FRAM not accessible.
	395	NO FACT ADJ ERROR	Adjustment data abnormal. (Not adjusted or damaged)
	396	FACT ADJ ERROR	Adjustment data abnormal. (Including not adjusted items)

Error display 2

Operation Displaying errors in measurement

On-screen reading	Description
----	Measurement error occurred.
+OVER or -OVER	Overrange occurred.

On-screen measurement error message	Description
SENSE CONTACT ERROR	Wire break detected between Sense Hi and Sense Lo.
SOURCE CONTACT ERROR	Wire break detected between Source Hi and Source Lo.
SENSE OVERFLOW	Sense detection voltage overflowed.
SENSE OVERFLOW (Too Large Loop of Wiring)	Sense detection voltage overflowed. (Loop areas formed by the measurement cables is too large.)
SENSE ROUTE RESISTANCE ERROR	Sense route-resistance value abnormal.
SOURCE ROUTE RESISTANCE ERROR	Source route-resistance value abnormal.

Error display 3

Operation Displaying errors in communications interface

No.	On-screen message	Description
100	Command error	Command syntax or spelling incorrect.
200	Execution error	Command failed to perform.
220	Parameter error	Command parameter incorrect.
360	Communication error	RS-232C communications error occurred.
361	Rs232c Parity error	Parity error occurred in RS-232C.
362	Rs232c Framing error	Framing error occurred in RS-232C.
363	Rs232c Overrun error	Overrun error occurred in RS-232C (received data lost).
400	Query error	The instrument failed to send a response (Controller not ready to receive responses).

Error display 4

Operation Displaying errors in other settings/execution

No.	On-screen message	Description
252	Missing media	USB flash drive not recognized.
257	File name error	The file names from 000 to 199 already occupied.
258	File access error	USB flash drive not accessible.
315	Setting backup lost	FRAM data damaged.
330	Self-test failed	Self-test error detected.
335	Adjust failed	Adjustment failed to perform.
339	ACR Calibration failed	Resistance self-calibration process failed to perform.
340	DCV Calibration failed	DC-voltage self-calibration process failed to perform.
341	Panel load failed	Panel loading failed.
342	Panel save failed	Panel saving failed.
373	USB over-current detected	Over-current flowing through USB flash drive detected.

Communications monitor	Operation	Displaying commands contents received/transmitted via LAN, USB (COM mode), and RS-232C
	How to set	By tapping the touchscreen or sending a command
Backlight-brightness adjustment	Operation	Adjusting backlight brightness
	Settings	0% to <input checked="" type="checkbox"/> 100%
Touchscreen calibration	Operation	Adjusting accuracy of touchscreen interface.
Sceensaver	Operation	Dimming the display during inactivity
	Settings	On (<input checked="" type="checkbox"/> 1 to 60 min.), <input checked="" type="checkbox"/> Off Communication-triggered deactivation On, <input checked="" type="checkbox"/> Off
	How to set	By tapping the touchscreen or sending a command
Measured-value color change	Operation	Setting on-screen measured-value colors.
	Measurement items	Resistance, DC voltage
	Settings	<input checked="" type="checkbox"/> White, Yellow
	How to set	By tapping the touchscreen
External I/O TRIG-signal input filter	Operation	Processing signals with the predefined width or more only as input signals
	Settings	On (<input checked="" type="checkbox"/> 50 ms to 500 ms), <input checked="" type="checkbox"/> Off
	How to set	By tapping the touchscreen or sending a command
External I/O EOM-signal output format	Operation	Outputting a pulse with the predefined width upon measurement completion
	Settings	Pulse (1 ms to 100 ms, <input checked="" type="checkbox"/> 5 ms), <input checked="" type="checkbox"/> Hold
	How to set	By tapping the touchscreen or sending a command
External I/O ERR-signal output timing	Operation	Outputting the ERR signal at predefined timing
	Settings	Synchronous, <input checked="" type="checkbox"/> Asynchronous Synchronous: Monitoring contact-check errors and route-resistance monitor judgment errors during sampling to detect any issues (They are ignored while the instrument is on standby for a trigger, and during the delay time and calculation time) Outputting the ERR signal in sync with the end-of-measurement (EOM) signal output Asynchronous: Detecting contact-check errors in real time Outputting the ERR signal asynchronously to the EOM output
	How to set	By tapping the touchscreen or sending a command
External I/O testing	Operation	Displaying the input-signal states on the display. Manually switching between the on and off states of output signals
	How to set	By tapping the touchscreen or sending a command
Screenshot saving	Operation	Saving screenshots on a USB flash drive
	Saving format	Bitmap (.bmp)
	Operation	Hold the DISPLAY key for 2 s.

Advanced mode	Operation	Displaying the reactance (X) and impedance (Z) of an object under measurement.
	Measurement accuracy (typical)	$\pm 3.0\%$ of reading $\pm 0.1\%$ of full scale
	Settings	On, <input checked="" type="checkbox"/> Off
	How to set	By tapping the touchscreen or sending a command
	Note	When an adjusting process is performed for resistance measurement, it is also be performed for reactance (X). When checking reactance (X) a test-lead wiring layout, it is recommended to turn off any adjustments.

12.4 Interface Specifications

☑: Default setting

☑LAN	Standard	IEEE 802.3
	Connector	RJ-45
	Transmission method	10BASE-T/100BASE-T automatic detection, full-duplex communications
	Protocol	TCP/IP
	IP address	Four numbers, each ranging from 0 to 255 ☑192.168.1.1
	Subnet mask	Four numbers, each ranging from 0 to 255 ☑255.255.255.0
	Default gateway	Four numbers, each ranging from 0 to 255 ☑0.0.0.0
	Port number	1 to 65535 (except 80) ☑23
	Delimiter	For reception CR+LF, CR, LF For transmission CR+LF
	Operation	Saving/sending setting values and sending measured values via communications commands Simultaneous operation with USB (COM mode) and RS-232C is not possible.
USB (☑COM mode)	Connector	Type-C receptacle
	Electrical specifications	USB2.0 (Full speed)
	Class	CDC class (COM mode)
	Delimiter	For reception CR+LF, CR, and LF For transmission CR+LF
	Operation	Saving/sending setting values and sending measured values via communications commands Simultaneous operation with LAN, RS-232C, and USB (MEM mode) is not possible.
	Operating environment	Windows 10 or Windows 11
USB (MEM mode)	Connector	Type-A receptacle
	Electrical specifications	USB2.0 (Full speed)
	Compatible USB flash drives	Drives that support the USB Mass Storage Class Only the Z4006 USB Drive is guaranteed to operate.
	File format	FAT32 (VFAT not supported)
	Operation	Saving various data Simultaneous operation with USB (COM mode) is not possible.

RS-232C	Connector	D-sub 9-pin male														
	Communications method	Asynchronous, full duplex														
	Baud rate	<input checked="" type="checkbox"/> 9600 bps, 19200 bps, and 38400 bps														
	Number of data bits	8 bits														
	Stop bit	1 bit														
	Parity bit	None														
	Flow control	None														
	Delimiter	For reception CR+LF, CR, and LF For transmission CR+LF														
	Operation	Saving/sending setting values and sending measured values via communications commands Simultaneous operation with LAN and USB (COM mode) is not possible.														
External I/O	Connector used	D-sub 37-pin, socket contacts (female) Rectangular nut #4-40 screw														
	NPN/PNP (current sink/current source) setting capability The settings are configurable with the rear-mounted switch.															
	<table border="1"> <thead> <tr> <th rowspan="2"></th> <th colspan="2">Ext. I/O Mode switch setting</th> </tr> <tr> <th><input checked="" type="checkbox"/>NPN</th> <th>PNP</th> </tr> </thead> <tbody> <tr> <td>Input circuitry</td> <td>With support for sink output</td> <td>With support for source output</td> </tr> <tr> <td>Output circuitry</td> <td>Non-polar</td> <td>Non-polar</td> </tr> <tr> <td>ISO_5V power output</td> <td>5 V output</td> <td>-5 V output</td> </tr> </tbody> </table>			Ext. I/O Mode switch setting		<input checked="" type="checkbox"/> NPN	PNP	Input circuitry	With support for sink output	With support for source output	Output circuitry	Non-polar	Non-polar	ISO_5V power output	5 V output	-5 V output
		Ext. I/O Mode switch setting														
		<input checked="" type="checkbox"/> NPN	PNP													
	Input circuitry	With support for sink output	With support for source output													
	Output circuitry	Non-polar	Non-polar													
	ISO_5V power output	5 V output	-5 V output													
	Input	Photocoupler-isolated no-voltage contact input (with support for current sink and source output) Input-on condition: 1 V or less of residual voltage (input-on current: 4 mA/channel, reference values) Input-off condition: Open-circuited (breaking current: 100 μ A/channel or less)														
	Output	Photocoupler-isolated open drain output (non-polar) Maximum load voltage: 30 V DC Maximum output current: 50 mA/channel Residual voltage: 1 V or less (with a load current of 50 mA) or 0.5 V or less (with a load current of 10 mA)														
Service power output	Output voltage: Sink-output compatible: 5.0 V \pm 0.5 V Source-output compatible: -5.0 V \pm 0.5 V Maximum output current: 100 mA Isolation: Floating from the protective ground potential and measurement circuitry Insulation rating: Line-to-earth voltage of 50 V DC 30 V AC rms, 42.4 V AC peak or less															
Connector shell	With the enclosure potential (connected to the power-inlet grounded terminal)															
Pin assignment	See p.204.															

Pin assignment

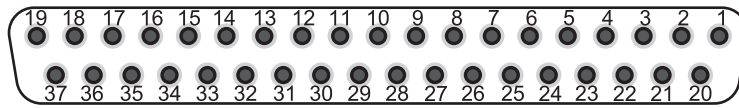

The table below shows pin functions. For details, see “Signal functions” (p. 130).
The external I/O control (input) can be locked by sending a command.

Pin	Signal name	I/O	Function	Operation
1	TRIG	In	Externally triggers the instrument for a measurement.	Edge
2	CALIB2	In	Performs a resistance self-calibration process.	Edge
3	KEY_LOCK	In	Locks the physical keys and touchscreen.	Level
4	LOAD1	In	Sets Bit 1 of the panel number to be loaded.	Level
5	(reserved)	In	-	-
6	(Reserved)	In	-	-
7	(reserved)	In	-	-
8	ISO_5V	-	Isolated power output +5 V (with NPN setting) or -5 V (with PNP setting)	-
9	ISO_COM	-	Common terminal of isolated power	-
10	ERR	Out	Measurement error	-
11	R_HI	Out	Hi judgment on resistance* ¹	-
12	R_LO	Out	Lo judgment on resistance* ¹	-
13	V_IN	Out	In judgment on voltage* ¹	-
14	(reserved)	Out	-	-
15	R_R_WARNING	Out	Warning judgment on route resistance* ³	-
16	(reserved)	Out	-	-
17	PASS_2	Out	Pass2 overall judgment, which meets all of the following conditions* ² : In judgment on voltage, In judgment on resistance, and Pass or Warning judgment on route resistance.	-
18	PASS_1	Out	Pass1 overall judgment, which meets both of the following conditions* ¹ : In judgment on voltage, and In judgment on resistance.	-
19	(reserved)	Out	-	-
20	0ADJ	In	Performs a single zero adjustment.	Edge
21	CALIB	In	Perform a DC-voltage self-calibration process.	Edge
22	LOAD0	In	Sets Bit 0 of the panel number to be loaded.	Level
23	LOAD2	In	Sets Bit 2 of the panel number to be loaded.	Level
24	(reserved)	In	-	-
25	(reserved)	In	-	-
26	(reserved)	In	-	-
27	ISO_COM	-	Common terminal of isolated power	-
28	EOM	Out	End of measurement (including judgments and calculations)	-
29	INDEX	Out	Measurement reference signal	-
30	R_IN	Out	In judgment on resistance* ¹	-
31	V_HI	Out	Hi judgment on voltage* ¹	-
32	V_LO	Out	Lo judgment on voltage* ¹	-
33	R_R_PASS	Out	Pass judgment on route resistance* ³	-
34	R_R_FAIL	Out	Fail judgment on route resistance* ³	-
35	(reserved)	Out	-	-

Pin	Signal name	I/O	Function	Operation
36	FAIL_2	Out	Fail2 overall judgment, which meets one of the following conditions*2: Hi or Lo judgment on voltage, Hi or Lo judgment on resistance, or Fail judgment on route resistance.	–
37	FAIL_1	Out	Fail1 overall judgment, which meets one of the following conditions*1: Hi or Lo judgment on voltage, or Hi or Lo judgment on resistance.	–

*1. When the comparator capability is off, the signal is not output.

*2. When the comparator capability is off or the route-resistance judgment capability is off, the signal is not output.

*3. When the route-resistance monitor capability is off, the signal is not output.

12.5 Key-Input Specifications

See “1.3 Part Names and Functions” (p.20).

Key name	Press	Hold (2 s)
TRIGGER	Starts/stops a measurement (with the external trigger setting).	–
DISPLAY	Switches between display screens.	Saves a screenshot.
ΩV/Ω/V	Switches between measuring functions.	–
SPEED	Switches between sampling speed settings.	–
▲(RANGE Ω)	Cycles through the resistance range from the highest to the lowest (Manual/Auto).	–
▼(RANGE Ω)	Cycles through the resistance range from the highest to the lowest (Manual/Auto).	–
▲(RANGE V)	Cycles through the DC-voltage range from the highest to the lowest (Manual/Auto).	–
▼(RANGE V)	Cycles through the DC-voltage range from the highest to the lowest (Manual/Auto).	–
ADJUST	Performs a zero adjustment. Performs a referential adjustment.	–
CAL	Performs a resistance self-calibration process. Perform a DC-voltage self-calibration process.	–
⏻(Start button)	Returns the instrument from sleep mode.	Goes the instrument into sleep mode.

12.6 Default Settings and Settings to be Reverted to the Default

See “Default settings and settings to be reverted to the default” (p.118).

12.7 Optional Equipment Specifications

L2120 Pin Type Lead (for four-terminal measurement)

General Specifications

Operating environment	Indoor use, pollution degree 2, altitude up to 2000 m (6562 ft.)
Operating temperature and humidity range	0°C to 40°C (32°F to 104°F), 80% RH or less (non-condensing)
Storage temperature and humidity range	-10°C to 50°C (14°F to 122°F), 80% RH or less (non-condensing)
Standard	Safety EN 61010
Dimension (length)	Approx. 1400 mm (45.7 in.)
Weight	Approx. 190 g (6.0 oz.)
Optional equipment	9772-90 Tip Pin

Input, Output, and Measurement Specifications

Basic specifications

Maximum input current	2 A DC, continuously
Maximum input voltage	±1000 V DC
Maximum rated line-to-ground voltage	±1000 V DC Anticipated transient overvoltage: ±1500 V
Measurement terminals	Source Hi, Source Lo, Sense Hi, and Sense Lo No guard terminal equipped
Product cables	Two twisted-pair cables
Pin surface treatment	Gold-plated
Pin arrangement	Parallel two-pin
Pin spacing	2.5 mm
Process of banana plugs	The tip part is made of plastic and equipped with plastic guards.

Pin shape

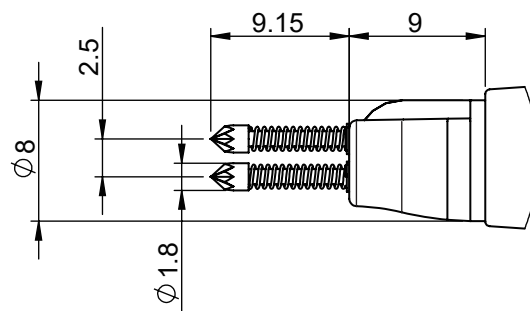

Unit: mm

L2121 Clip Type Lead (for four-terminal measurement)

General Specifications

Operating environment	Indoor use, pollution degree 2, altitude up to 2000 m (6562 ft.)
Operating temperature and humidity range	0°C to 40°C (32°F to 104°F), 80% RH or less (non-condensing)
Storage temperature and humidity range	-10°C to 50°C (14°F to 122°F), 80% RH or less (non-condensing)
Standard	Safety EN 61010
Dimension (length)	Approx. 1160 mm (45.7 in.)
Weight	Approx. 170 g (6.0 oz.)

Input, Output, and Measurement Specifications

Basic specifications

Maximum input current	2 A DC, continuously
Maximum input voltage	±60 V DC
Maximum rated line-to-ground voltage	±60 V DC
Measurement terminals	Source Hi, Source Lo, Sense Hi, and Sense Lo No guard terminal equipped
Product cables	Two twisted-pair cables
Probe surface treatment	Gold-plated
Pinchable diameter	0.3 mm to 5 mm
Process of banana plugs	The tip part is made of plastic and equipped with plastic guards.
Spring life	About 15,000 opening/closing cycles (reference value at 23°C)

13 Maintenance and Service

Precautions when transporting the instrument

CAUTION

Observe the following when shipping the instrument:

- Remove accessories and optional equipment from the instrument.
- When requesting repair, include a description of the malfunction.
- Use the packaging in which the instrument was initially delivered and then pack that in an additional box.



Failure to do so could cause damage the product during shipment.

13

Maintenance and Service

13.1 Showing Various Information on the Display

Various information can be shown on the display.

[MENU] > [INFO]

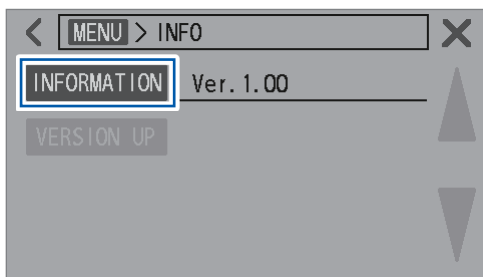

1 Tap [INFORMATION].

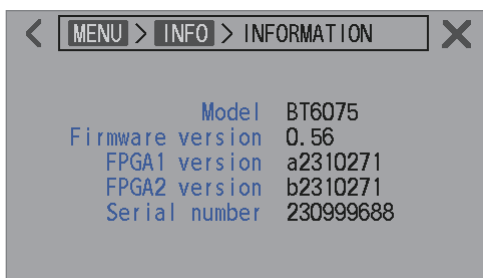

Various information is shown on the display.

Model	Model name
Firmware version	Firmware version number
FPGA1 version	FPGA1 version number
FPGA2 version	FPGA2 version number
Serial number	Serial number* ¹

*1. The serial number consists of nine digits. The first two digits indicate the year of manufacture, while the second two digits indicate the month of manufacture.

13.2 Repair, Inspection, and Cleaning

WARNING



- **Do not attempt to modify, disassemble, or repair the instrument.**
Doing so could cause serious bodily injury or fire.

Calibration

The appropriate schedule for calibration depends on factors such as the operating conditions and environment. Determine the appropriate calibration interval based on your operating conditions and environment and have Hioki calibrate the instrument accordingly.

Backing up your data

When repairing or calibrating the instrument, Hioki will reset it (factory reset) or update it by installing the latest version of the firmware.

It is recommended to record setting conditions.

Replaceable parts and service life

Some parts used in the instrument will deteriorate in characteristics after years of use.

It is recommended to replace these parts regularly to ensure product functionality over the long term.

To order replacements, please contact your authorized Hioki distributor or reseller.

Component service life varies with the operating environment and frequency of use. The recommended replacement intervals do not guarantee these components to operate throughout the period.

Part Name	Recommended replacement cycle	Remarks
Electrolytic capacitors	About 5 years	PCBs with the parts mounted need replacement.
LCD backlight (half-life of brightness)	About 5 years	Based on 24 hours/day usage
Fan motor	About 7 years	Based on 24 hours/day usage
Backup battery (lithium battery)	About 10 years	If the date or time is substantially inaccurate, the battery should be replaced.
Relays	About 5 years	When switched 10 times per hour.

Cleaning

CAUTION

- **Periodically clean the vent openings to avoid blockage.**

When the vent openings get clogged, the internal cooling effect of the instrument is hampered, which could damage the instrument.



- **To clean the instrument, wipe it with a soft cloth moistened with water or a neutral detergent.**

Using solvent-containing detergents, such as benzene, alcohol, acetone, ether, ketone, thinners, and gasoline, or wiping the instrument with excessive force could cause deformation or discoloration.

Wipe the display gently with a soft, dry cloth.

13.3 Troubleshooting

- If damage is suspected, refer to “Before returning for repair” (p.212) to address issues. If further assistance is needed, contact your authorized Hioki distributor or reseller.

Before returning for repair

General problems

No.	Problem	Possible cause → Solution	Reference page
1-1	The instrument cannot be turned on (The display is blank).	Power has not been supplied. → Check the power cord for a break. → Verify that the circuit breaker of the installation has not tripped. → Set the rear-mounted Power switch to the on position.	p.33 p.34
		The supply voltage or frequency is not correct. → Check the power ratings. (100 V to 240 V, 50 Hz/60 Hz)	p.43
		The display is dimmed. → Adjust the backlight brightness. → When the screen saver is set to on, the display will automatically dim after a predefined length of inactivity.	p.111
		The fuse has blown. → The instrument has a built-in fuse in its power block. The blown fuse cannot be repaired or replaced by the user. Contact your authorized Hioki distributor or reseller.	–
1-2	The instrument cannot be operated using key controls.	The key lock is activated. → Deactivate it.	p.112
		The instrument is in the remote state. → Cancel the remote state.	p.153
1-3	No judgment is displayed.	The comparator capability is turned off. → Turn the comparator capability on. If no measured value is displayed, the instrument shows no judgment.	p.100
1-4	The buzzer does not generate beeps.	The operation-feedback sound is set to off. → Set the preference to on.	p.109
		The judgment sound preference is set to off. → Set the preferences to on.	p.102
1-5	The buzzer sound is loud. The buzzer sound is low.	The instrument does not support buzzer volume adjustment.	–

Problems concerning measurement

No.	Problem	Possible cause → Solution	Reference page
2-1	Measured values deviate from the expected values.	<p>The zero-adjustment was performed incorrectly. → Repeat the zero adjustment, considering the following measurement environments:</p> <ul style="list-style-type: none"> • Adjust the shape and arrangement of the test lead to conform to the actual measurement condition. • Adjust the presence/absence and arrangement of metal objects around the object under measurement (battery) to conform to the actual measurement conditions. • Adjust the presence/absence and arrangement of other batteries*¹ around the object under measurement (battery) to conform to the actual measurement conditions. <p>*1. Batteries on the same tray</p>	p.56
		<p>The effect of the measurement environments has not been removed. → Take the same countermeasures as when performing zero adjustments.</p>	
		<p>The actual measured data of the reference adjustment is not correct. → Repeat obtaining the actually measured data for the referential adjustment, considering the following measurement environments:</p> <ul style="list-style-type: none"> • Adjust the shape and arrangement of the test lead to conform to the actual measurement conditions. • Adjust the presence/absence and arrangement of metal objects around the object under measurement (battery) to conform to the actual measurement conditions. • Adjust the presence/absence and arrangement of other batteries*¹ around the object under measurement (battery) to conform to the actual measurement conditions. <p>*1. Batteries on the same tray</p>	p.65
		<p>The effect of the measurement environments has not been removed. → Take the same countermeasures as when obtaining the actual measured data of the reference adjustment.</p>	

No.	Problem	Possible cause → Solution	Reference page
2-2	Measured values do not stabilize.	<p>The effect of the wiring shape and arrangement has not been removed.</p> <p>→ Repeat the zero adjustment. Alternatively, repeat obtaining the actually measured data for the reference adjustment.</p> <p>→ Adjust the shape and arrangement of the test lead to conform to the actual measurement conditions.</p>	p.56 p.65
		<p>Measured values vary due to electromagnetic induction.</p> <p>→ Reduce the loop area formed by the branch wires between Sense Hi and Sense Lo.</p> <p>→ Reduce the loop area formed by the branch wires between Source Hi and Source Lo.</p> <p>→ The value of the reactance (X) indicates the size of loop area formed by test-lead branch wires. Turn on advanced mode and arrange the test lead so that the reactance (X) becomes smaller.</p>	p.236 p.116
		<p>Measured values varies depending on the measurement position.</p> <p>→ Make measurements using identical probing positions.</p> <p>→ Keep the branch wires between Sense and Source as far away as possible.</p> <p>→ When creating a self-made test-lead assembly, ensure that it has tips with single-point contact to make proper contact with the test points. Avoid using crown-type tips; they may result in lower repeatability due to multi-point contact.</p>	p.225
		<p>The wiring shield forms a ground loop.</p> <p>Ground each shield at one end only (Connect to the Shield terminal).</p> <p>Do not ground both ends of each shield.</p>	p.237
		<p>The characteristics of objects under measurement have changed with temperature.</p> <p>→ Make measurement after the temperature change has decreased.</p>	-
		<p>The measurement current causes objects under measurement (batteries) to generate heat.</p> <p>→ Select a range with a smaller measurement current.</p>	p.49
		<p>Object under measurements have a large reactance (X).</p> <p>→ Turn on advanced mode.</p>	p.116
		<p>The temperature sensor is not connected correctly.</p> <p>→ Connect the temperature sensor by inserting the plug all the way in.</p>	p.39
2-3	The zero adjustment cannot be performed.	<p>Measured values before zero adjustment may have fallen outside the allowable ranges due to the influence of wiring shape and arrangement.</p> <p>→ Reduce the loop area formed by the branch wires between Sense Hi and Sense Lo.</p> <p>→ Reduce the loop area formed by the branch wires between Source Hi and Source Lo.</p>	p.56
		<p>The instrument displays a measurement error due to incorrect wiring.</p> <p>→ Repeat the zero adjustment with the correct wiring. If a high-resistance test-lead assembly, which may be a self-made one, is used, the zero adjustment cannot be performed. Maintain a lower wiring resistance.</p>	p.199 p.218

Problems concerning the external I/O

No.	Problem	Possible cause → Solution	Reference page
3-1	The instrument does not work at all.	<p>The instrument displays the external I/O test results, which consist of in and out states, that differ from those of the controller due to incorrect wiring or external I/O settings.</p> <p>→ Check the following on the external I/O again.</p> <ul style="list-style-type: none"> • Connector connection • Pin number • ISO_COM pin wiring • NPN/PNP setting • Contact (or open collector) control (This does not mean voltage control.) • Power supply for the controller (The instrument does not require an external power source.) 	p.127
3-2	The TRIG signal cannot start a measurement.	<p>The trigger source is set to internal.</p> <p>→ Set the trigger source to external. The TRIG signal cannot trigger the instrument with the internal trigger setting.</p>	p.87
		<p>The on-duration of the TRIG signal is short.</p> <p>→ Ensure the TRIG signal has an on-duration of 0.1 ms or more.</p>	-
		<p>The off-duration of the TRIG signal is short.</p> <p>→ Ensure the TRIG signal has an off-duration of 1 ms or more.</p>	-
3-3	No panel can be loaded.	<p>No panel with the desired panel number has been saved.</p> <p>→ Use other signals starting with <i>LOAD</i> or save the panel again in accordance with the signals starting with <i>LOAD</i>.</p>	p.123
3-4	The EOM signal has not been output.	<p>If measured values are not updated, check the item No. 3-2.</p>	p.215
		<p>The measurement is still in progress.</p> <p>The EOM signal turns on upon measurement completion.</p>	p.135
3-5	No signals ending with <i>HI</i> , <i>IN</i> , or <i>LO</i> have not output.	<p>The comparator capability is turned off.</p> <p>→ Check if the comparator capability settings are correct.</p>	p.100

Problems concerning communications

Using the communications monitor (p. 164) allows you to check communications states easily.

No.	Problem	Possible cause → Solution	Reference page
4-1	The instrument does not response at all.	<p>(When [REMOTE] is not displayed) External devices such as a computer and a PLC are not connected correctly. → Check the connector for proper connection. → Check that the interface setting is correct. → When using USB, install the driver to the control device. → When using RS-232C, use a crossover cable. → Check the COM port number of the control device. → Use the same baud rate for the instrument and the control device.</p>	p. 153
		<p>(When [REMOTE] is displayed) The instrument does not accept any commands. → Check the software delimiter.</p>	p. 202
		<p>(When the green indicator in the rear-mounted LAN connector does not light up) The instrument or control device is not turned on. → Turn the instrument or control device on. The LAN cable or its connector has a break. → Use an unbroken cable. LAN is not selected under the communication interface setting. → Select LAN.</p> <p>(When the green indicator in the rear-mounted LAN connector lights up) The LAN settings (IP address, subnet mask, default gateway, port number) are incorrect. → Configure the LAN settings correctly. Check that the instrument and control device use the same LAN settings.</p>	p. 153 p. 157

No.	Problem	Possible cause → Solution	Reference page
4-2	An error has occurred.	(When a command error is displayed) The command does not conform to the command specifications of the instrument. → Check the command spelling. (Space: x20H) → Do not append a question mark (?) to commands that are not intended as queries. → When using RS-232C, ensure that the baud rate of the instrument and control device match. *1	-
		(When an execution error is displayed) Although the command string is correct, the instrument has not been ready. Example: The :READ? query is sent to the instrument in the trigger-reception continuation mode. → Check the specifications of each command. *1	-
		(When a parameter error occurs) The data part of the command does not conform to the command specifications of the instrument. Example: The data part contains a misspelling. :SAMP:SPEED SLOW3 → Check the specifications of each command. *1	-
		*1. The input buffer (with a capacity of 1460 bytes) is full. → Wait until the received character string has been processed. Example: Insert the following dummy communications every several lines of commands. Sending the *OPC? query → Receiving the 1 response	-
4-3	No response to a query is returned.	(When a response is confirmed with the communications monitor) The program contains an error. → The instrument returns a response to the query. Check the reception part of the program.	p.164

13.4 On-Screen Errors

When an error is displayed, the instrument needs repair. Contact your authorized Hioki distributor or reseller.

No.	On-screen message	Cause	Solution
100	Command error	The command does not conform to the command specifications of the instrument.	Check the command specifications.
200	Execution error	The instrument is not ready to execute commands.	
220	Parameter error	The data part of the command does not conform to the command specifications of the instrument.	
252	Missing media	The instrument does not recognize the USB flash drive.	Set the I/F setting to other than USB COM. Otherwise, insert a USB flash drive.
257	File name error	The file names from 000 to 199 have already been occupied.	Create an empty slot for a number.
258	File access error	<ul style="list-style-type: none"> The USB flash drive has been formatted in an unsupported file system. The USB flash drive is damaged. 	<ul style="list-style-type: none"> Format USB flash drives in the FAT32 file system. Insert an undamaged USB flash drive.
315	Setting backup lost	<ul style="list-style-type: none"> The instrument was reset at startup, for instance, immediately after the firmware update. The FRAM data is damaged. 	If this error is displayed continuously, arrange for repair.
330	Self-test failed	An error has occurred as a result of the self-test.	The instrument may be damaged. Arrange for repair.
335	Adjust failed	<ul style="list-style-type: none"> The measured value for resistance or voltage before adjustment exceeds the adjustable ranges. The test lead has a break or has been worn out. 	<ul style="list-style-type: none"> Reconnect the test lead to the instrument correctly. Use an unbroken or unworn test lead.
339	ACR Calibration failed	The correction value for the resistance self-calibration is not correct. Any input is provided into the measurement terminals, an error has occurred in communications with the A/D converter due to external noise, or the instrument is damaged.	Perform a resistance self-calibration process without inputting any signals to the measurement terminals. If this error is displayed continuously, arrange for repair.
340	DCV Calibration failed	Compensation values for the DC-voltage self-calibration are not correct. An error has occurred in communications with the A/D converter due to external noise, or the instrument is damaged.	If this error is displayed continuously, arrange for repair.

No.	On-screen message	Cause	Solution
341	Panel load failed	The instrument cannot load a panel because it has been reset at startup, for instance, immediately after the firmware update.	–
342	Panel save failed	The instrument cannot save the panel because an error has occurred in communications with the internal storage due to external noise or the instrument is damaged.	If this error is displayed continuously, arrange for repair.
360	Communication error	An RS-232C communications error has occurred.	Check the RS-232C communications settings. Select a lower baud rate and try again.
361	Rs232c Parity error	An RS-232C parity error has occurred.	
362	Rs232c Framing error	An RS-232C framing error has occurred.	
363	Rs232c Overrun error	An RS-232C overrun error has occurred.	
373	USB over-current detected	The current consumption of the USB flash drive exceeds the specified value.	Remove the USB flash drive.
390	ROM ERROR	The ROM data is damaged (The instrument is faulty).	Arrange for repair.
391	POWER SUPPLY ERROR	The power circuitry is damaged (The instrument is faulty).	
392	FAN ERROR	The fan does not work (The instrument is faulty).	
393	FPGA ERROR	The FPGA does not work (The instrument is faulty).	
394	FRAM ERROR	The FRAM does not work (The instrument is faulty).	
395	NO FACT ADJ ERROR	The adjustment data is damaged (The instrument is faulty).	
396	FACT ADJ ERROR	The adjustment data is damaged (The instrument is faulty).	
400	Query error	The instrument cannot send a response message because the controller is not ready to receive messages.	Check the controller for its state.

No.	On-screen message	Cause	Solution
-	-----	<p>The instrument cannot flow measurement current for the following reasons:</p> <ul style="list-style-type: none"> • The object under measurement (battery) and the test lead are not connected correctly. • The test lead has a break or has been worn out. • The present measurement range is inappropriate. • Route resistance is excessively high. • The object under measurement (battery) is grounded. 	<ul style="list-style-type: none"> • Connect the object under measurement (battery) and the test lead correctly. • Use an unbroken or unworn test lead. • Select an appropriate measurement range. • When creating a test-lead assembly by yourself, use thicker and shorter cables to reduce wiring resistance. • Do not ground objects under measurement.
-	+OVER or -OVER	<p>The measured values exceed the displayable digits (counts) ranges.</p>	<p>Select an appropriate measurement range.</p> <p>If [+OVER] or [-OVER] is displayed even when the maximum range is used, the instrument cannot be used for measurement on this object.</p> <p>If either one is displayed for temperature measurement, the instrument cannot be used for measurement on this object.</p>
-	SENSE CONTACT ERROR	<ul style="list-style-type: none"> • The wiring between Sense Hi and Sense Lo is not connected correctly. • The test lead has a break or has been worn out. 	<ul style="list-style-type: none"> • Connect the object under measurement (battery) and the test lead correctly.
-	SOURCE CONTACT ERROR	<ul style="list-style-type: none"> • The branch wires between Sense Hi and Sense Lo is not connected correctly. • The test lead has a break or has been worn out. 	<ul style="list-style-type: none"> • Use an unbroken or unworn test lead.
-	SENSE OVERFLOW	<p>The input-signal level in the resistance measuring circuitry exceeds the measurement range.</p>	<p>The instrument cannot be used for measurement on this object.</p>
-	SENSE OVERFLOW (Too Large Loop of Wiring)	<p>The input-signal level in the resistance measuring circuitry exceeds the measurement range. (The loop areas formed by the measurement cables are too large.)</p>	<p>Minimize each of the following areas:</p> <ul style="list-style-type: none"> • Loop formed by the wiring between Source Hi and Source Lo • Loop formed by the wiring between Sense Hi and Sense Lo <p>See "14.6 Effects of Electromagnetic Induction and Eddy Currents" (p.234).</p>

No.	On-screen message	Cause	Solution
-	SENSE ROUTE RESISTANCE ERROR	<ul style="list-style-type: none"> • The wiring between Sense Hi and the object under measurement (battery), or between Sense Lo and the object, is not connected correctly. • The test lead has a break or has been worn out. 	<ul style="list-style-type: none"> • Connect the object under measurement (battery) and the test lead correctly.
-	SOURCE ROUTE RESISTANCE ERROR	<ul style="list-style-type: none"> • The wiring between Source Hi and the object under measurement, or Source Lo and the object, is not connected correctly. • The test lead has a break or has been worn out. 	<ul style="list-style-type: none"> • Use an unbroken or unworn test lead.

13.5 Disposing of the Instrument

Before disposing of the instrument, remove the lithium battery and dispose of it according to local regulations.

WARNING



- **Before removing the lithium battery, set the Power switch to the off position and disconnect the power cord and test lead from the instrument.**

Failure to do so could cause the user to experience an electric shock.

- **Store the removed battery out of reach of young children.**

Failure to do so could lead to accidental ingestion of the battery by young children.

Removing the lithium battery

You will need: Phillips screwdriver (No. 2) and tweezers

- 1** Ensure that the rear-mounted Power switch is set to the off position and unplug the power cord and test lead.
- 2** Remove the six screws from the sides and the one from the rear.
- 3** Remove the cover.
- 4** Insert the tweezers tip between the battery and the battery holder, as shown in the picture, and lift up on the battery to remove it.

IMPORTANT

Exercise care not to short-circuit the positive and negative terminals. Doing so may cause sparks.

CALIFORNIA, USA ONLY

Perchlorate Material - special handling may apply.

See <https://dtsc.ca.gov/perchlorate/>

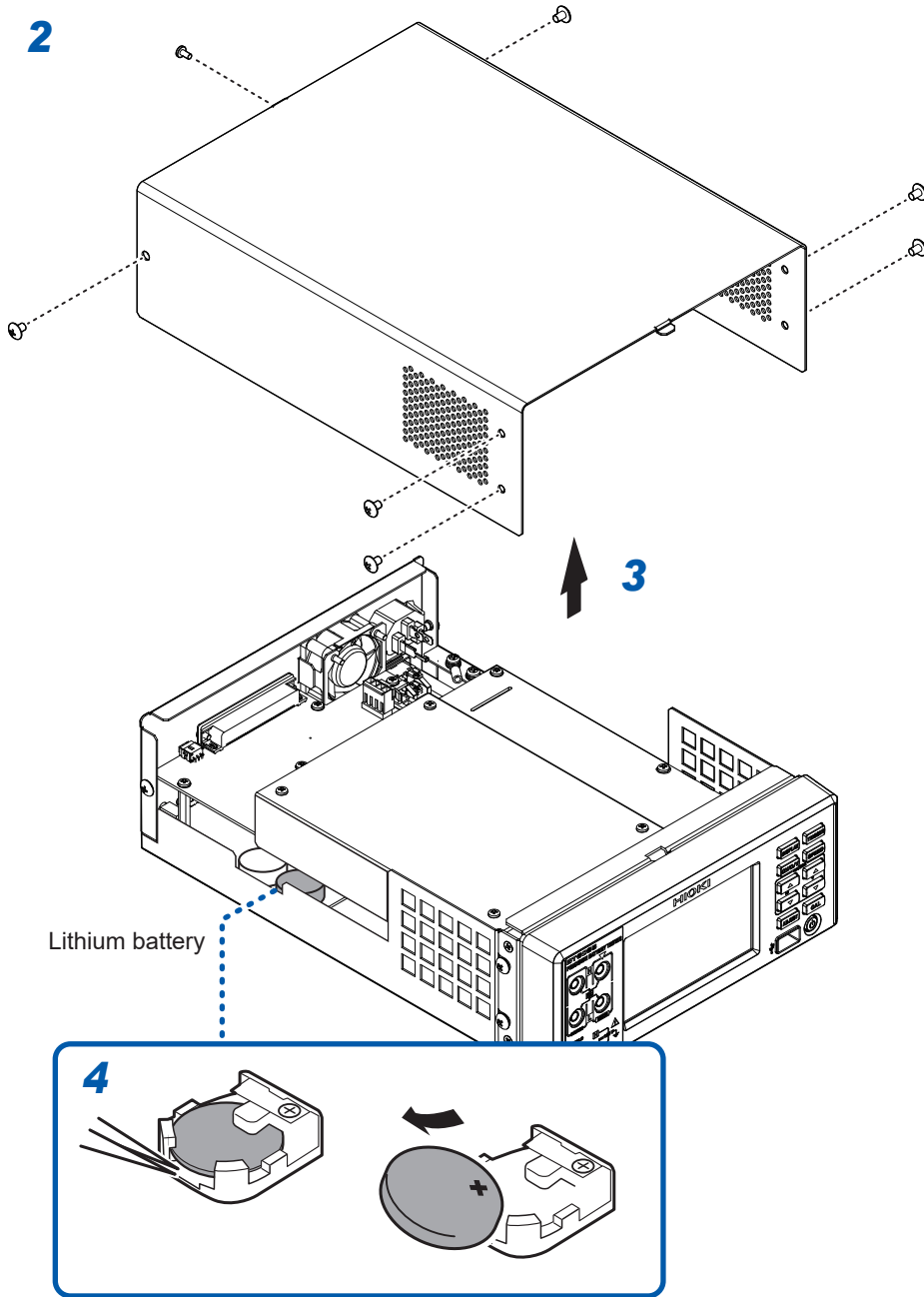

14 Appendix

14.1 When Creating a Test-Lead Assembly by Yourself

Observe the following precautions when creating a test-lead assembly by yourself.

WARNING



- **After making a measurement on a high-voltage battery, do not touch the metal tips of the test-lead assembly.**

Doing so could cause the user to experience an electric shock because electric charge remains inside the instrument. (internal discharge time: about 2 s)

- **Use cables that provide sufficient dielectric strength and current capacity.**

Failure to do so could cause the user to experience an electric shock or a short-circuit fault.



- **Before removing the test-lead assembly from or connecting it to the instrument, ensure that nothing is connected to its ends.**

If the banana plugs come into contact with each other while the test-lead tips are connected to an object under measurement (battery), a short circuit may occur, possibly resulting in serious injury.

- **When using an optional test lead with its ends cut, make sure that the core and shield wires do not come into contact with each other.**

Failure to do so could result in a short-circuit in an object under measurement (battery).

- Always twist the Hi and Lo wires of the Source side, as well as those of the Sense side. Use shielded wires and connect only one end of each shield to the Shield terminal of the instrument.

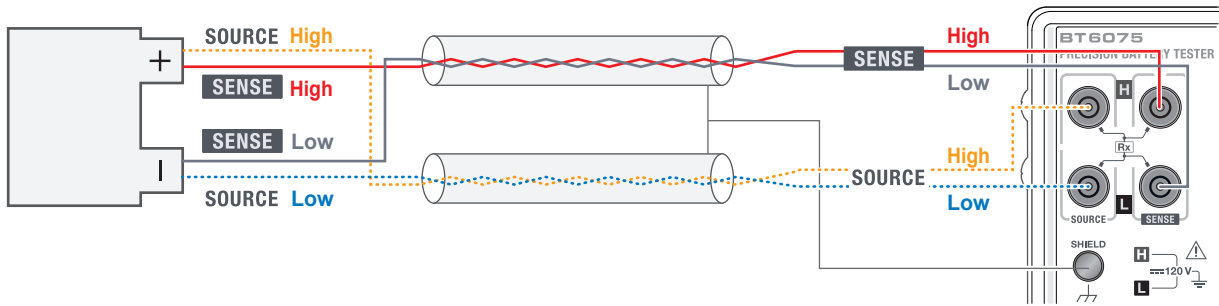

- Use four terminals to make measurement. When making measurements with two terminals (using 4-into-2 interconnected wire pairs), measured resistance values may vary due to various factors, including effect from wire resistance and contact resistance*¹ in the test-lead assembly. Additionally the instrument may display different readings each time with each measurement.

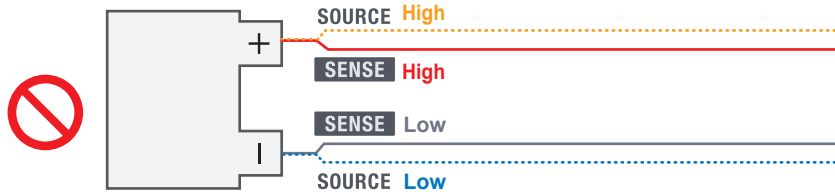

- *1. Wire resistance: Wire resistance of a test-lead assembly, contact resistance of connectors, and on-resistance of relays
 Contact resistance: Contact resistance between the test-lead pins and an object under measurement (battery)

- When connecting a test-lead assembly to an object under measurement (battery), arrange Source Hi and Source Lo to the outer side and Sense Hi and Sense Lo to the inner side.

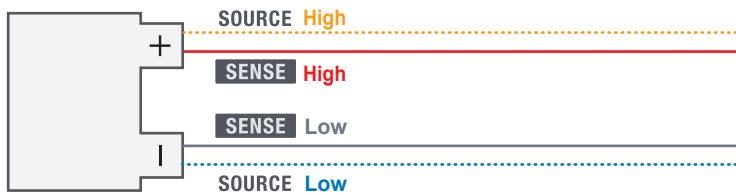

- Keep a test-lead assembly away from metal plates or metal frames. In particular, ensure that untwisted branch wires are away from metal. The effect of eddy currents on metallic objects may cause large errors in measured resistance values. See “14.6 Effects of Electromagnetic Induction and Eddy Currents” (p.234).

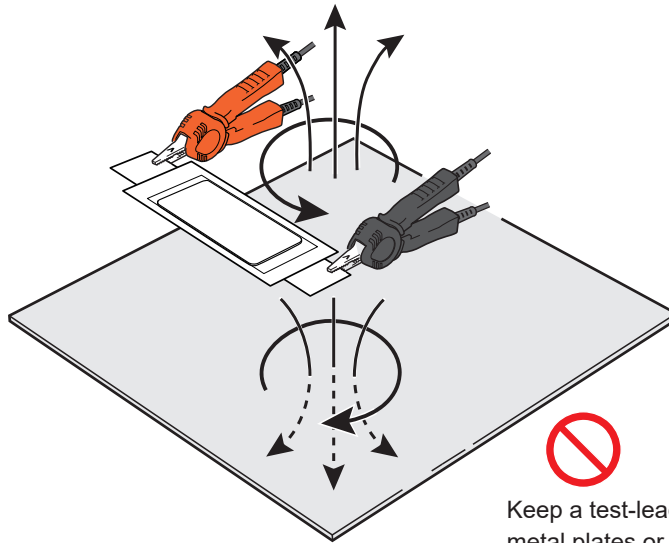

Keep a test-lead assembly away from metal plates or metal frames.

- Pay attention to the following figure for the shape and arrangement of a test-lead assembly. Eddy currents and external induced noise from adjacent metals can cause errors and variations in measured resistance values, and can degrade repeatability. The following countermeasures can reduce the effect.
 - Reduce the loop area formed by the wires between Source Hi and Source Lo, and that between Sense Hi and Sense Lo as much as possible.
 - Always maintain a consistent loop shape and wiring arrangement, (a consistent distance from the metal parts of peripheral equipment).
 - Ensure consistent positioning of the test-lead pins at all times.

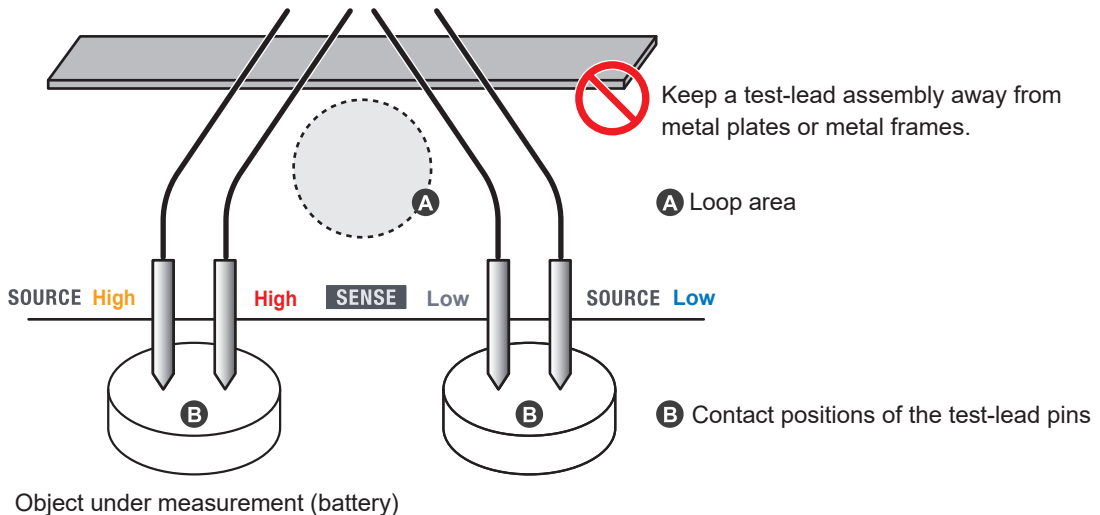

- Keep wiring to the minimum required length (within 5 m). If the wires are long, it is susceptible to noise, and measured values may not be stable for both resistance measurement and DC-voltage measurement. When the route resistance*¹ of the wires increases, accuracy in resistance and DC-voltage measurements decreases.

*1. The route resistance is the sum of the wiring resistance and the contact resistance.

Wiring resistance: Wiring resistance of test-lead wires

Contact resistance: Contact resistance between the test-lead pins and an object under measurement (battery), that between the test-lead banana plugs and the measurement terminals of the instrument, contact resistance of connectors, and on-resistance of relays

- Before starting a measurement, perform adjustment processing.
For resistance measurement: Perform the zero adjustment or configure the reference adjustment settings.

For DC-voltage measurement: Perform the zero adjustment.

- Ensure that adjustment processing is performed in the actual measurement environment. Pay special attention to the following two points:

1. Shape and arrangement of the test-lead assembly
2. Presence/absence and arrangement of metal around objects under measurement (batteries)
(presence/absence and arrangement of other batteries around the target battery)

If the actual measurement environment differs from that during the adjustment process, an error (offset) may occur in the measured value due to the influence of eddy currents caused by the adjacent metal or other factors.

In particular, when measurement is performed with the 3 mΩ or 30 mΩ range, the effect of eddy currents becomes significant.

Performing adjustment processing can eliminate errors.

- To perform zero adjustment, create a device designed specifically for this purpose. Avoid using a metal plate (shorting bar) as a substitute for the specially designed device. The resistance of metal plates causes errors.

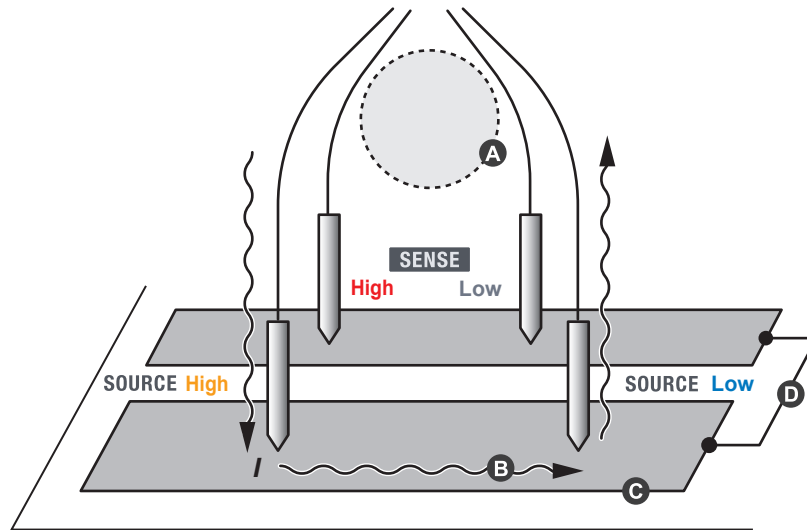

Device specifically designed for zero adjustment

- A** Always maintain a consistent loop shape and wiring arrangement (keep a uniform distance from the metal parts of peripheral equipment).
- B** Avoid current from the Source side flowing into the Sense-side conductors. When the current flows through the Sense-side conductors, voltage due to the conductor resistance is generated, resulting in errors.
- C** Use thick wiring for the Source-side conductor to ensure low resistance.
- D** Connect the conductive parts of the Source side and Sense side at a single point.

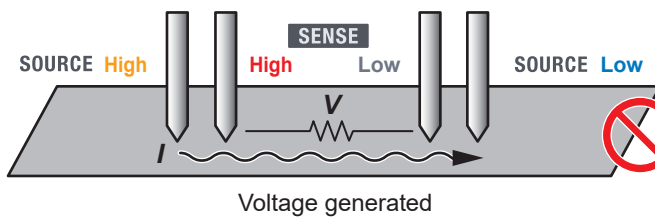

Do not perform zero adjustment on a single steel plate.

14.2 AC Four-Terminal Method

The instrument employs the AC four-terminal method for resistance measurement, which cancels out the wiring resistance of the test-lead wires and the contact resistance between the test-lead pins and an object under measurement (battery). The principle of the AC four-terminal method is described below.

Resistance measuring circuitry

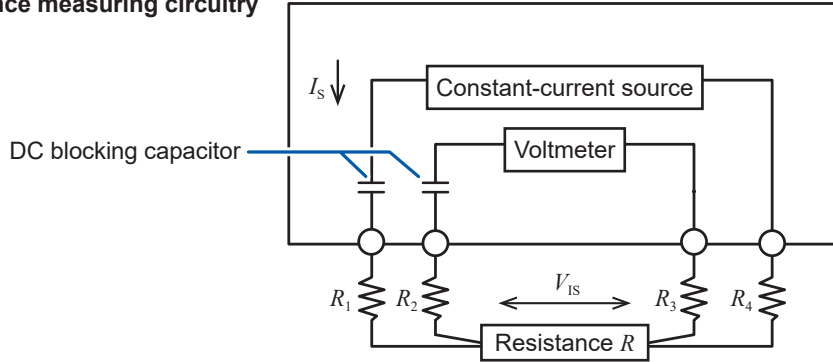

R_1 to R_4 : Resistance of the test-lead wires and contact resistance of contact points

The instrument flows an AC current I_s from the Source terminal to the object under measurement (battery). At this time, the instrument detects the voltage drop V_{is} caused by the internal impedance of the object under measurement (battery) using the Sense terminals. Because the voltmeter inside the Sense terminals has a higher input impedance, there is no current flow through the resistors R_2 and R_3 , which represent the wire resistance and the contact resistance of the test leads, respectively. Thus, the voltage does not drop across the resistors R_2 and R_3 . This way allows the instrument to perform measurements with minimal influence from the wiring resistance and the contact resistance of the test leads. In addition, this instrument separates the internal impedance of the object under measurement (battery) into a resistance value and a reactance value through the synchronous detection method and then displays only the resistance reading.

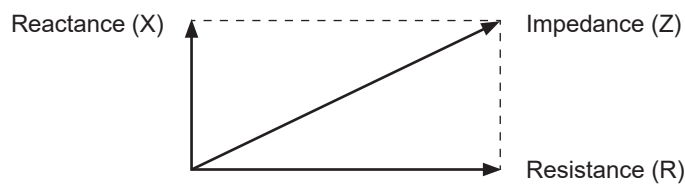

14.3 Synchronous Detection

The figure below illustrates the equivalent circuit of a battery. When components other than pure resistance are present in an object under measurement (battery), synchronous detection determines its effective resistance. This method is also employed to extract minute signals buried in noise.

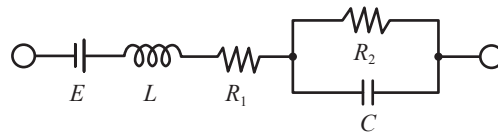

Synchronous detection is a detection method used to extract a signal with the same phase component as the reference signal from a given signal.

If the reference-signal voltage of the AC current generated by the instrument is v_1 and the signal voltage for synchronous detection is v_2 , these relations can be expressed as follows: The variable θ in the equation expressing v_2 represents the difference in phase with respect to v_1 caused by the reactance component.

$$v_1 = A \sin \omega t$$

$$v_2 = B \sin(\omega t + \theta)$$

When synchronous detection is performed on v_1 and v_2 , the following equation holds true.

$$v_1 \times v_2 = \frac{1}{2}AB \cos \theta - \frac{1}{2}AB \cos(2\omega t + \theta)$$

The first term of the right side of the equation represents the voltage drop due to the effective resistance.

This instrument converts the first term into the resistance measured value (R) to display.

14.4 Variation in Measured Values According to the Test Lead

Some objects under measurement (batteries) exhibit varying measured values depending on the test lead used. The tip shape and dimensions of the four-terminal test lead used cause this variation in measured values. Each measured value is correct obtained using the corresponding test lead. When comparing measured values, use the same test lead.

Tips

The variation in the measured values is due to the difference in the distance (dimension) between the current application pins and the voltage detection pins of the test lead used. An increase in the battery-terminal resistance compared to the battery internal resistance results in a greater variation in measured values. The figure below provides an example illustrating how differences in pin spacing result in variations in detected voltage.

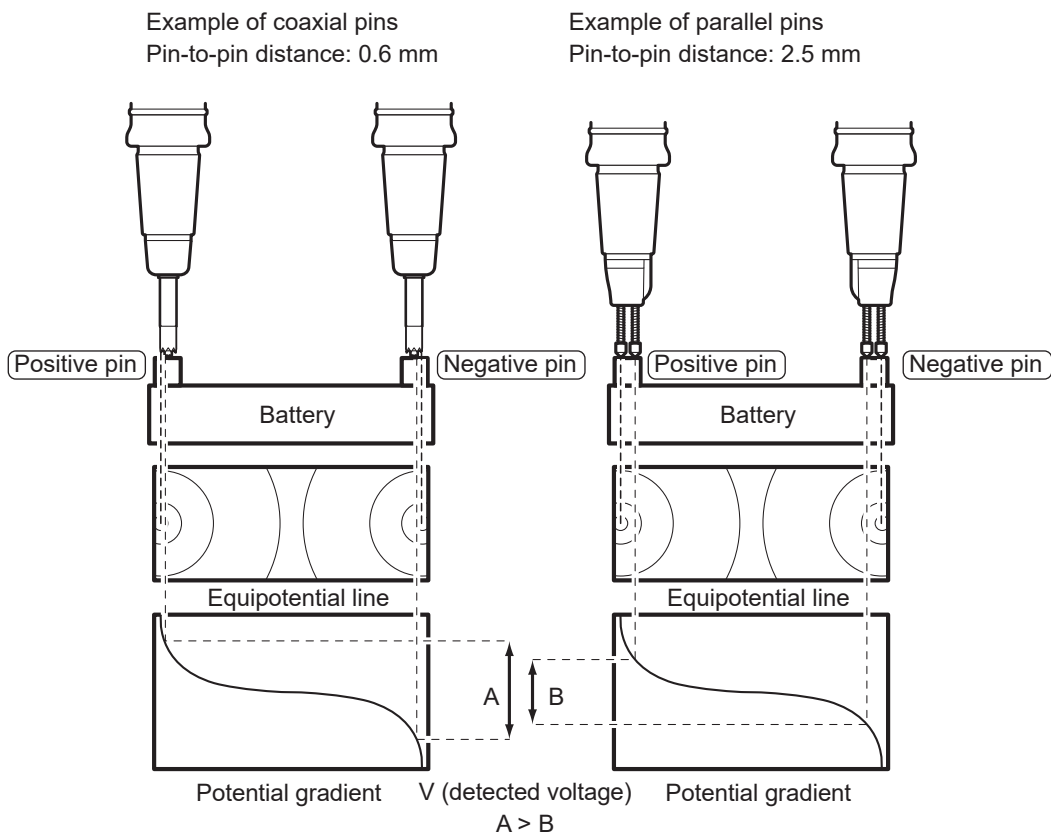

14.5 Extending a Test Lead

Extension of a test lead is available by special order. Contact your authorized Hioki distributor or reseller.

To extend a test lead, pay attention to the following points:

- Use as thick wires for the test lead as possible and minimize the extension.
If a test lead is extended, the path resistance of the extended wiring will increase, possibly deteriorating both resistance and DC voltage measuring accuracy.
- Maintain the AC four-terminal structure as is for extension. If the test lead changes its structure from four-terminal to two-terminal on its way to an object under measurement, its resistance and contact resistance may result in incorrect measurements.
- Ensure to extend the trunk wires, not the branch wires.
See “14.1 When Creating a Test-Lead Assembly by Yourself” (p.225).
- After extending the test lead, check the instrument for proper operation and accuracy.

14.6 Effects of Electromagnetic Induction and Eddy Currents

Effect of electromagnetic induction

This instrument is susceptible to electromagnetic induction because it measures minute resistance using alternating current. The instrument flows an AC measurement current with a frequency of 1 kHz from Source Hi to Source Lo. The loops formed by the test-lead branch wires through which the measurement current flows generate magnetic flux. This magnetic flux intrudes into the loop formed by the test-lead wires between Sense Hi and Sense Lo, creating an induced voltage. If there is no metal in the surroundings, the difference in phase between the induced voltage and the measurement current is 90° . The effect of a phase difference of 90° is expressed as the reactance (X), a component of the impedance of the object under measurement. This instrument extracts only the resistance component (R) by synchronous detection, it is not affected by it. However, if the induced voltage reaches excessive level and exceeds the maximum signal level that its measuring circuitry can process, an overflow error may occur. The instrument in advanced mode allows you to observe the reactance (X). Ensure that the test lead is wired in a way that minimize the reactance (X). See "6.8 Checking Reactance (X) of Objects Under Measurement and Wiring Layout" (p.116).

Effect of Eddy Currents

If the magnetic flux generated from the loops formed by the test-lead branch wires between Source Hi and Source Lo, through which the measurement current flows, enters the surrounding metal, it induces an eddy current in the metal. The magnetic flux produced by this eddy current intrudes into the loops formed by the test-lead branch wires between Sense Hi and Sense Lo, generating an induced voltage. Unlike the case where there is no surrounding metal, the difference in phase between this induced voltage and the measurement current is not 90° ; thus, its effect is also expressed as errors in the resistance component (R) of the impedance of the object under measurement.

In resistance measurement, a larger measurement current is necessary to flow as the resistance decreases to generate a specific level of detection voltage (voltage drop across resistance). Consequently, the magnetic flux generated by the loop increases proportionally. As a result, the effect of the above electromagnetic induction, including the effects of eddy currents, becomes more pronounced in low-resistance measurements.

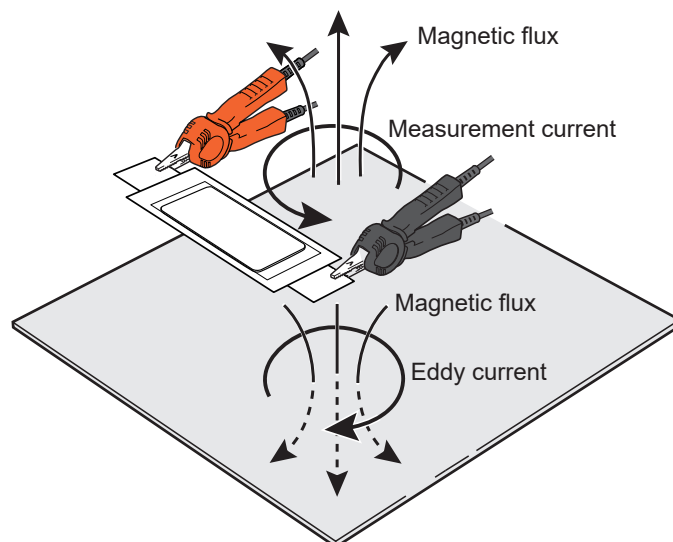

Countermeasures against the effects of electromagnetic induction and eddy currents

Twisting the test-lead wires

The effect of electromagnetic induction (p.234), including the impact of eddy currents, arises from the interaction of the loop on the Source side (current-supplying side) with that on the Sense side (voltage-detecting side) through magnetic flux. The magnitude of the generated magnetic flux is proportional to the loop area on the Source side. The percentage of magnetic flux entering the loop on the Sense side is proportional to the loop area on the Sense side and the distance between adjacent loops.

Thus, it is more important to minimize the area of each loop in order to reduce the effect of electromagnetic induction. Specifically, twist the test-lead wires connected to the Source Hi and Source Lo, as well as those to the Sense Hi and Sense Lo. This facilitates the cancellation of an electromagnetic induction effect because not only the area of each loop is reduced but also the polarities of the small loop formed at each twisted pair alternate. Twist the wires as close as possible to both the object under measurement and instrument. Twisting the test-lead wires is recommended as a countermeasure not only against eddy currents but also external induced noise.

Proper wiring

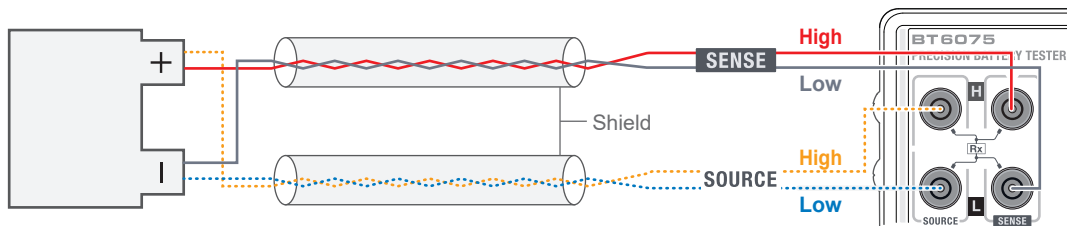

- Twist the Source-Hi wire (yellow) and Source-Lo wire (blue), as well as the Sense-Hi wire (red) and Sense-Lo wire (black).
- Keep twisted pairs as far apart as possible.
- Connect each shield to the ground (Shield terminal) at one end only.
- Maintain the twisted pairs and shields as close as possible to both the object under measurement and instrument.

IMPORTANT

Minimize each of the following areas:

- Loop formed by the wires between Source Hi and Source Lo
- Loop formed by the wires between Sense Hi and Sense Lo

A loop is formed at position **A**.

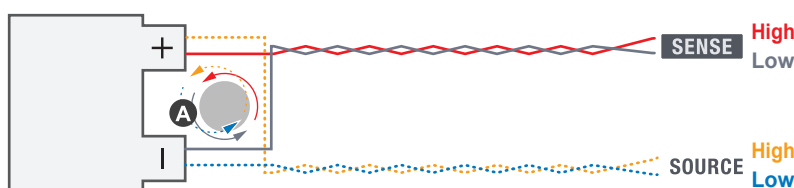

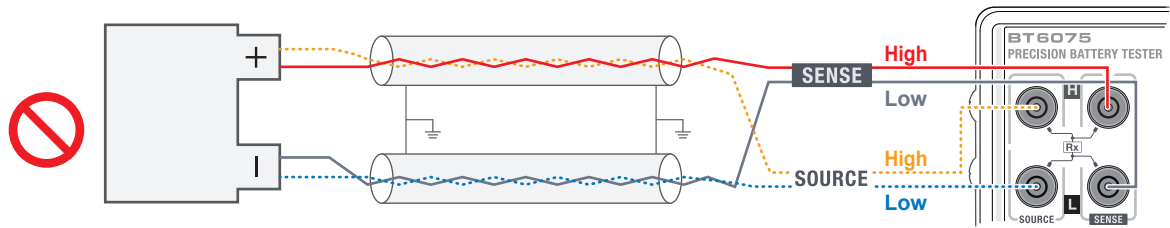
Common mistakes (improper wiring)

- Do not twist the Source-Hi wire (yellow) and Sense-Hi wire (red).
- Do not twist the Source-Lo wire (blue) and Sense-Lo wire (black).
- Do not connect both ends of each shield to the ground. An loop with the shield potential is formed, increasing the influence of eddy currents on resistance measurement values.

The loop area becomes large.

→ The effect of electromagnetic induction increases.

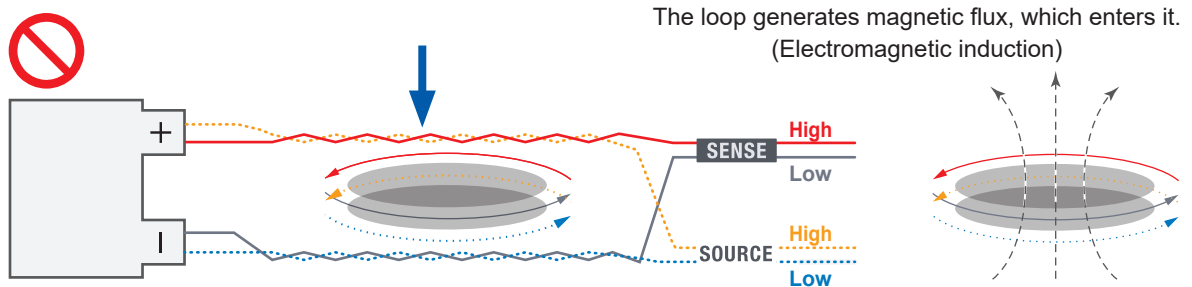
**Keeping the surrounding metal away**

If there is metal around the object under measurement or the test lead, the influence of eddy currents on the resistance measurement value becomes large. In particular, keep the metal as far away as possible from non-twisted parts (where loops are formed).

Securing the test lead to perform the adjustment process

The effect of eddy currents is determined by the arrangement of the test lead, the size of its loops, and the positional relationship between the object under measurement and the surrounding metal. Thus, it can always be regarded as a constant effect level in a fixed situation. Such errors can be eliminated by zero adjustment or reference adjustment. Secure the test lead and surrounding objects as much as possible to maintain the conditions during the adjustment process. Twisting the test-lead wires in advance is crucial to minimize loop areas and reduce the effect on measured values when the test-lead wires are moved.

14.7 Effect of Mutual Interference

When multiple instruments are used in close range, mutual interference may cause errors in measured resistance values. This mutual interference is a type of effect caused by electromagnetic induction.

See “14.6 Effects of Electromagnetic Induction and Eddy Currents” (p.234).

Mutual interference may occur when the magnetic flux generated by the loops on the Source side of one instrument enters the loops on the Sense side of another instrument. The effect of mutual interference is observed as oscillation in resistance measured values. This oscillation is caused by a slight difference in the measurement frequency due to individual differences between the instruments, and the oscillation frequency is equal to the difference in the measurement frequencies of each instrument.

This mutual interference is not unique to this model; it occurs similarly when impedance measuring instruments have measurement frequencies that are close to each other.

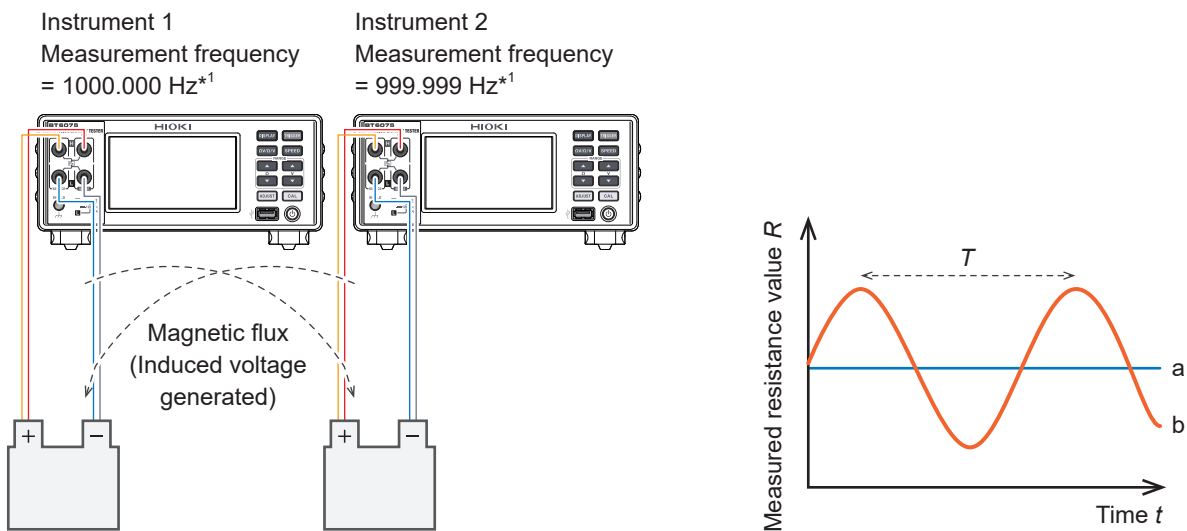

Simultaneous measurement can result in mutual interference due to electromagnetic induction.

Examples of logged resistance measurement data

- T: Period
 $1/(1000.000 \text{ Hz} - 999.999 \text{ Hz}) = 1000 \text{ s}$
- a: Original measured values
- b: Measured values affected by mutual interference

*1. Differences in measurement frequency arise individual differences.

In environments where mutual interference occurs, the oscillation shown in the figure above is observed when measured values are logged for a long time. For single measurements in routine battery inspections, it is not possible to determine which phase during the cycles the effect of mutual interference in measured values corresponds to. In addition, the effect level of mutual interference varies depending on the factors, such as the shape of test-lead branch wires (loop areas), the position of the object under measurement, and whether the other measuring instruments are making measurements. Hence, the problem caused by mutual interference cannot be resolved through zero adjustment or reference adjustment.

Countermeasures against the effect of mutual interference

Twisting the test-lead wires

Since mutual interference is a phenomenon caused by electromagnetic induction, the most fundamental countermeasure is to minimize the loop area by twisting test-lead wires. Additionally, reducing the magnetic coupling between measuring systems, as done to counteract the effect of eddy currents, is advisable.

See “14.6 Effects of Electromagnetic Induction and Eddy Currents” (p.234).

Ensuring as much distance between measuring systems as possible

To reduce magnetic coupling, ensure a sufficient distance between the other measuring system, which comprises a measuring instrument, test leads, and objects under measurement. When measuring aligned batteries, it is also possible to plan the measurement order for each channel to ensure an adequate separation between those being measured simultaneously.

Staggering measurement timings to avoid overlapping between instruments

When the trigger source is set to external and MIR mode is turned off, the instrument flows a measurement current only during measurements. If connected to an object under measurement, the instrument, while on standby for a trigger, does not supply any measurement current. Thus, when making measurements with multiple instruments, staggering timings of triggers input to each instrument to avoid overlapping measurement times, can eliminate mutual interference.

Using mutual interference reduction (MIR) mode

Enabling MIR mode on both instruments allows for simultaneous measurements, significantly reducing the effect of mutual interference. To effectively utilize MIR mode, it is necessary to correctly configure the setting parameters related to the operation of MIR mode on both instruments, ensuring measurements are conducted in an appropriate sequence.

See “14.8 Countermeasures Using MIR Mode Against Mutual Interference” (p.240).

14.8 Countermeasures Using MIR Mode Against Mutual Interference

MIR mode can be used to reduce the effect of mutual interference when two instruments are used for simultaneous measurements at close distance.

Principle of MIR mode

Mutual interference between the two instruments is caused by synchronous detection of noise caused by the measurement current of the other instrument. Its effect level (R_{MI}) is expressed by equation (1).

$$R_{MI} = A \times \cos(2\pi \times \Delta f \times t + \Delta\theta) \dots\dots\dots (1)$$

- A : Factor that depends on the detection level per resistance measured value and the degree of magnetic coupling between the instruments
- Δf : Difference in the measurement-signal frequency between the instruments
- $\Delta\theta$: Difference in the measurement-signal phase between the instruments

When the R_{MI} in equation (1) is considered as a function of $\Delta\theta$, equation (2) holds from the nature of the trigonometric function.

$$R_{MI}(\Delta\theta + 180^\circ) = -R_{MI}(\Delta\theta) \dots\dots\dots (2)$$

In MIR mode, the instrument divides the number of waves included in the measurement current output per a single measurement by half to sample. For half of the sampled points, the secondary instrument inverts the phases (a phase shift of $+180^\circ$) of the measurement current and the synchronous-detection reference signal.

From equation (2) above, when either one of the instrument inverts the phases, the positive and negative effect levels of mutual interference in that output section are inverted. On the other hand, since the difference in phase between the measurement current and the synchronous-detection reference signal does not change, the positive and negative components (R_{DUT}) attributable to the object under measurement are not inverted. This is true for both the primary and secondary instruments.

By averaging the values obtained through synchronous detection within the sampling interval for each measurement, only the effect of mutual interference can be eliminated, resulting in the final measured value.

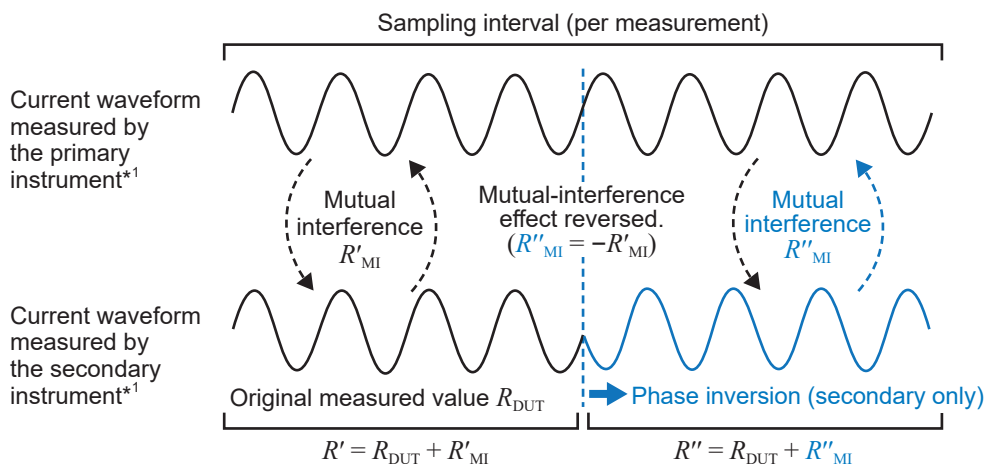

$$\text{Finally obtained measured value: } R = \frac{R' + R''}{2} = \frac{R_{DUT} + R_{DUT} + R'_{MI} + R''_{MI}}{2} = R_{DUT}$$

*1. The waveforms are for illustrative purposes.

Notes on using MIR mode

- Configure the MIR mode setting to **[PRIMARY]** for the first and **[SECONDARY]** for the second instruments.
 - In addition, ensure consistent settings between two instruments for the sampling speed, DC-voltage self-calibration, and line frequency.
- See “4.4 Reducing Mutual Interference During Resistance Measurement (Working in MIR Mode)” (p.93).
- MIR mode required 6 ms to 12 ms for stabilization in addition to the measurement time.
 - In MIR mode, regardless of the trigger timing, the measurement current continues to flow immediately after the Source terminals are connected to an object under measurement. Do not use MIR mode when staggering measurement timings between multiple instruments.
 - Control the other instrument so that connection states (for example, connection/disconnection of objects under measurement, switching of channels in a scanner) are not changed during sampling. This can lead to incomplete cancellation of mutual interference. To satisfy this while ensuring the most efficient measurements, try switching between measurement lines to connect each instrument to its corresponding object under measurement as simultaneously as possible.

Appropriate control

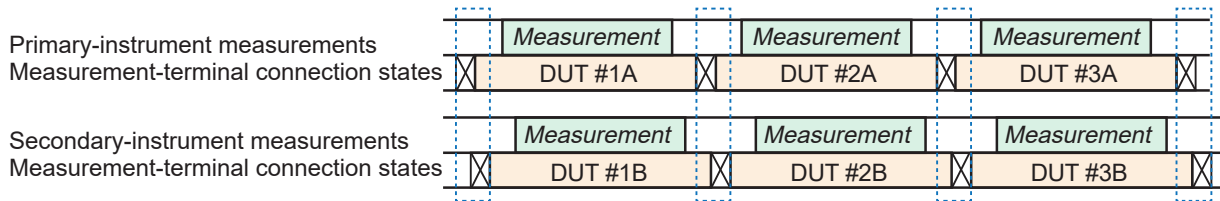

During measurement on either line, the connection state on the other line remains unchanged.

- ⊠: Time from disconnecting a device under test (DUT) to connecting another DUT (including relay bouncing in a scanner)
- Measurement*: Time (sampling time) from a trigger input (after the waiting time) to the INDEX-signal output

Inappropriate control

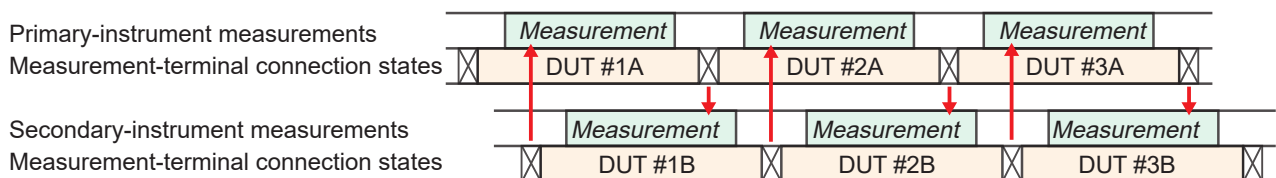

If the connection state on either line changes during a measurement on the other line, the effect of mutual interference cannot be eliminated.

14.9 Calibrating the Instrument

For details about calibration environment, see “Accuracy guarantee conditions” (p. 182).

Calibrating the resistance measuring function

- Use a standard resistor with minimal aging and excellent temperature characteristics.
- Use a resistor (non-inductive type) with a four-terminal structure to avoid the effect from the resistor’s lead wires.
- Ensure to determine the resistance value of the resistor with a measurement frequency of 1 kHz AC. The resistance at a measurement frequency of 1 kHz AC (real part of impedance, on-screen component of the instrument) is not equal to the DC resistance.
- Refer to the figure below for how to connect the instrument to the standard resistor.

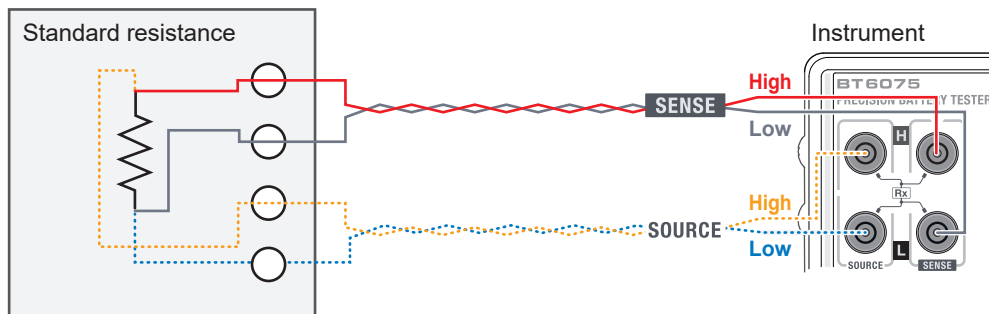

- Of the test-lead wires connecting the standard resistor and the instrument, twist the Source-Hi wire (yellow) and the Source-Lo wire (blue), as well as the Sense-Hi wire (red) and Sense-Lo wire (black).
- Arrange the internal wires of the standard resistor similarly to the twisting method described above, reducing the size of the loops, and secure the wires in place to prevent any movement.

Calibrating the DC-voltage measuring function

⚠ CAUTION



■ **Do not apply AC voltage to the instrument.**

Doing so could damage the instrument.

- Do not flow the measurement current (AC) of the instrument to a generator. Doing so may cause malfunction of the generator.
- Use a generator that meets the following specifications. Some generators may not work properly.
 - With the capability of outputting a voltage of 120 V DC
 - With the smaller output impedance (For some generators, particularly those with a large output impedance, the instrument may detect contact errors or route-resistance errors.)
- Refer to the figure below for how to connect the instrument and the generator.



Short-circuit Source Hi and Source Lo, connecting them to Sense Lo at one point.

Calibrating the route-resistance measuring function

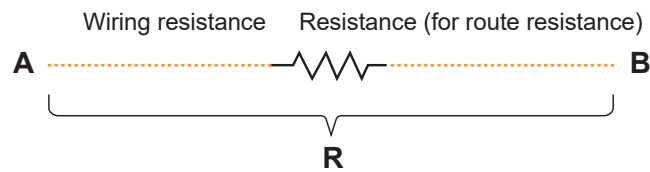

Prepare a calibration cable as shown in the figure above, and use a high-precision resistance meter to determine the resistance value of the resistance R between A and B.

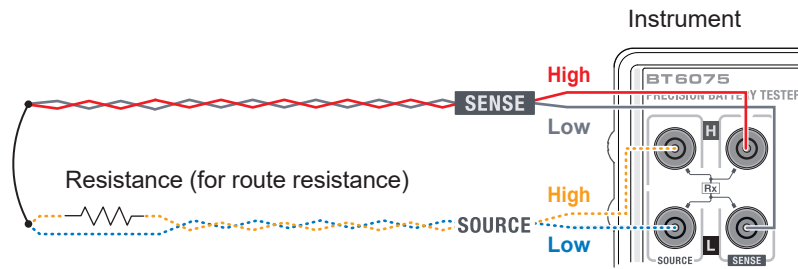

At this time, use the assembled calibration cable for a terminal to be calibrated (in the figure, Source Hi).

Connect the Source Hi and Source Lo at a single point on the cable ends.

Connect the Sense Hi and Sense Lo at a single point on the cable ends.

Connect the Source connection point and the Sense connection point.

Calibrating the temperature measuring function

- Use a Pt100 JIS Class A equivalent resistor as the standard resistor for the calibration.
- Make sure that the round-trip wiring resistance is 10 Ω or less.
- Refer to the figure below for how to connect the instrument to the standard resistor.
- Use a 3.5-millimeter-diameter four-pole plug to connect. (refer to the figure below for the four-pole signal line).

Connecting the standard resistor to the instrument

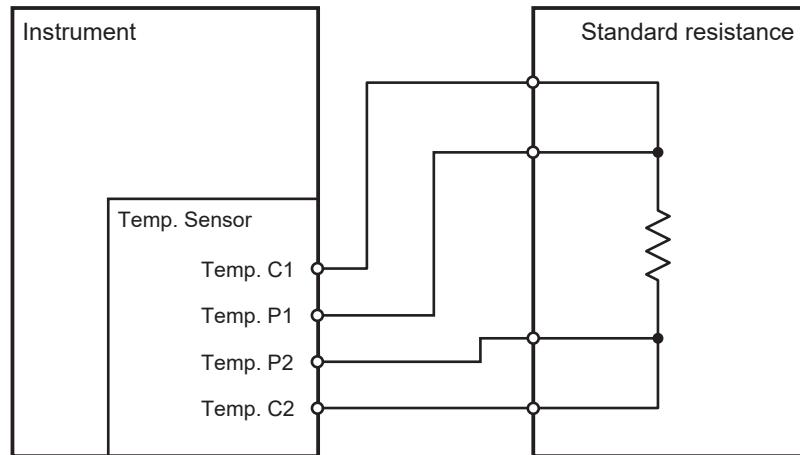

Connection terminal structure



14.10 Zero Adjustment

The zero adjustment can correct the zero point by subtracting the residual value observed even when a resistance of 0Ω is measured due to effect by external factors such as eddy currents. For this reason, it is necessary to perform zero adjustment with a connected 0Ω resistance. However, connecting an object under measurement (battery) with an absolute zero-resistance value is difficult and unrealistic.

Thus, during the actual zero adjustment, the zero point is corrected by simulating a condition in which a 0Ω resistance is connected.

To create a condition in which a 0Ω resistance is connected

When the ideal 0Ω resistance is connected, the voltage between the Sense Hi and Sense Lo will be 0 V from Ohm's law ($E = I \times R$). This implies that by setting the voltage between Sense Hi and Sense Lo to 0 V , a condition is established where a 0Ω resistance is connected.

To perform zero adjustment on the instrument

The contact check and route-resistance check capabilities of this instrument monitor the connection states of the four measurement terminals. For this reason, when performing zero adjustment, it is necessary to connect the terminals properly (figure below).

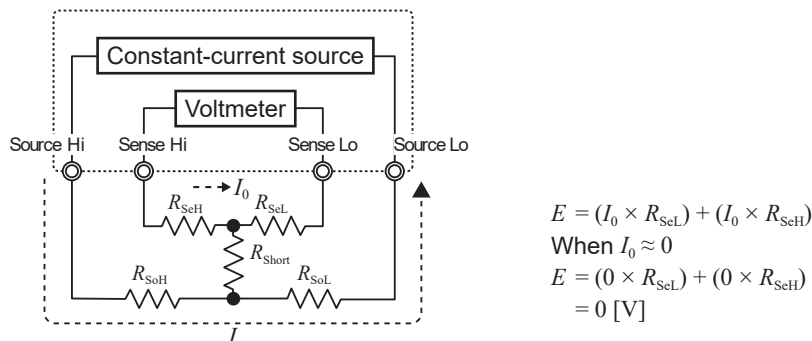

First, short-circuit between Sense Hi and Sense Lo to set the voltage between them to 0 V . The wire resistance of the test-lead wires used ($R_{SeH} + R_{SeL}$) should not exceed several ohms. The current I_0 minimally flows through the Sense terminals, which are the voltage measurement terminals. If the test-lead wires have a resistance of several ohms, the voltage between Sense Hi and Sense Lo will be almost zero.

Next, connect between Source Hi and Source Lo.

This is necessary to prevent an error that may occur when the measurement current I is unable to flow. The test-lead wires to be used cannot have the wire resistance ($R_{SoH} + R_{SoL}$) that prevents the measurement current from flowing.

Additionally, it must also connect the wire between the Sense terminals with that between the Source terminals. There is no problem even if the test-lead wires to be used have a wire resistance R_{Short} of several ohms.

By connecting wires as described above, the measured current I will circulate from Source Hi to Source Lo without flowing into Sense Hi or Sense Lo.

The voltage between Sense Hi and Sense Lo can now be maintained at exactly 0 V , allowing you to perform zero adjustment properly.

To perform zero adjustment properly

Table 1 shows the correct and incorrect connections. The resistance symbols in the figure represent the wiring resistance. Each resistance should not exceed several ohms.

As shown in figure (a), Sense Hi and Sense Lo, as well as Source Hi and Source Lo, are connected, and the wire between the Sense terminals and that between the Source terminals are connected in a single path. In this case, there is no potential difference between the Sense Hi and Sense Lo; thus, a voltage of 0 V is input. This ensures that zero adjustment is correctly performed. On the other hand, as shown in figure (a), Sense Hi and Source Hi, as well as Sense Lo and Source Lo, are connected, and the wire between the Hi terminals and that between the Lo terminals are connected in a single path. In this case, a voltage, calculated from $I \times R_{\text{short}}$ is generated between the Sense Hi and Sense Lo. Thus, it does not simulate a pseudo-zero ohm connection, resulting in an incorrect zero adjustment for the instrument.

Table 1 How to connect

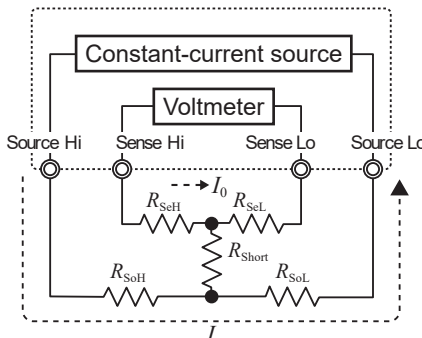
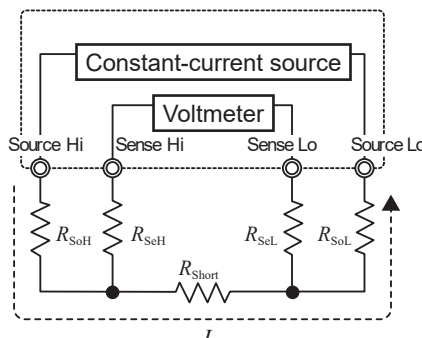
	Correct	Incorrect 
How to connect	<p>(a) The wire between the Sense terminals and that between the Source terminals are connected in a single path</p> 	<p>(b) The wire between the Hi terminals and that between the Lo terminals are connected in a single path</p> 
Resistance between Sense Hi and Sense Lo	$R_{\text{SeH}} + R_{\text{SeL}}$	$R_{\text{SeH}} + R_{\text{Short}} + R_{\text{SeL}}$
Path through which the measured current I flows	$R_{\text{SoH}} \rightarrow R_{\text{SoL}}$	$R_{\text{SoH}} \rightarrow R_{\text{Short}} \rightarrow R_{\text{SoL}}$
Voltage generated between Sense Hi and Sense Lo	0	$I \times R_{\text{Short}}$

Performing zero adjustment using a test lead

When actually performing zero adjustment with a test lead, unexpected connections, as shown in Table 1 (b), may occur. For this reason, when performing zero adjustment, it is necessary to pay attention to the connection states of each terminal.

This section provides an example of how to connect the L2121 Clip Type Lead, as described in “3.5 Performing the Zero Adjustments” (p.56).

Table 2 illustrates the connection states of the test-lead tips and their equivalent circuits for both the correct and incorrect connection methods. The correct connection method is as shown in Table 1 (a), where the voltage between the Sense Hi and Sense Lo is 0 V. Conversely, the wrong connection method, shown in Table 1 (b), results in a non-zero voltage between Sense Hi and Sense Lo.

Table 2: How to connect Clip Type Lead when performing zero adjustment

	Correct	Incorrect
	Engage the clips so that the V marks make contact.	
How to connect		
Tips of the Test Lead		
Equivalent circuit		
Altered equivalent circuit		

Performing zero adjustment using the Z5038 0 Adj Board

When zero adjustment is performed, it is essential to use the Z5038 0 Adj Board; a conductive material, such as a metal plate, cannot be substituted. The 0 Adj Board is used to perform zero adjustment on the L2100 and L2120 Pin Type Lead.

The cross-sectional views and equivalent circuits when the Pin Type Lead is connected to the 0 Adj Board and when it is connected to a conductive material, such as a metal plate, are shown in Table 3. When the Pin Type Lead is connected to the 0 Adj Board in this manner, the connection follows the configuration shown in Table 1 (a), resulting in a voltage of 0 V between Sense Hi and Sense Lo. If the connection is made with a metal plate, however, it follows the configuration shown in Table 1 (b), and the voltage between Sense Hi and Sense Lo does not become 0 V.

Table 3: How to connect the Pin Type Lead for the zero adjustment

	Correct	Incorrect
How to connect	<p>Connection when the Z5038 0 Adj Board is used</p>	<p>Connection When a metal plate is used</p>
Tips of the Test Lead		
Equivalent circuit		
Altered equivalent circuit		

If zero adjustment proves difficult during measurements with a self-made test-lead assembly

To perform zero adjustment in a measurement system using a self-made test-lead assembly, connect the tips of the assembly as shown in Table 1 (a). If the connection as shown in Table 1 (a) is difficult, the following methods are available.

When performing zero adjustment, ensure to arrange a self-made test-lead assembly to resemble the actual measurement environment and then connect it as shown in Table 1 (a). You can reduce the effect of the shape and arrangement of the test-lead assembly.

You can also use an object under measurement (battery) to reduce the effect of the shape and arrangement of a test-lead assembly.

See "3.6 Performing the Referential Adjustments" (p.65).

14.11 Test Lead (Optional Equipment)

WARNING

- Do not use the instrument with an optional test lead connected for measurements that exceed any of the marked ratings on either of them.

Failure to do so could cause the user to experience an electric shock.

It could also cause serious events, such as heat generation, fire, or arc flash due to a short-circuit.



	BT6065	L2100, L2120	L2121
Maximum input voltage	120 V	1000 V	60 V

Voltage inputtable to the instrument when using the L2100 or L2120: Up to 120 V

Voltage inputtable to the instrument when using the L2121: Up to 60 V

L2100 Pin Type Lead (up to 1000 V DC)

The L2100 is a four-terminal pin-type test-lead assembly with a high withstand voltage of up to 1000 V DC. It is ideal for measuring high-voltage battery packs and cells with a high line-to-ground potential. The tips have a parallel two-pin structure, enabling stable contact during measurements.

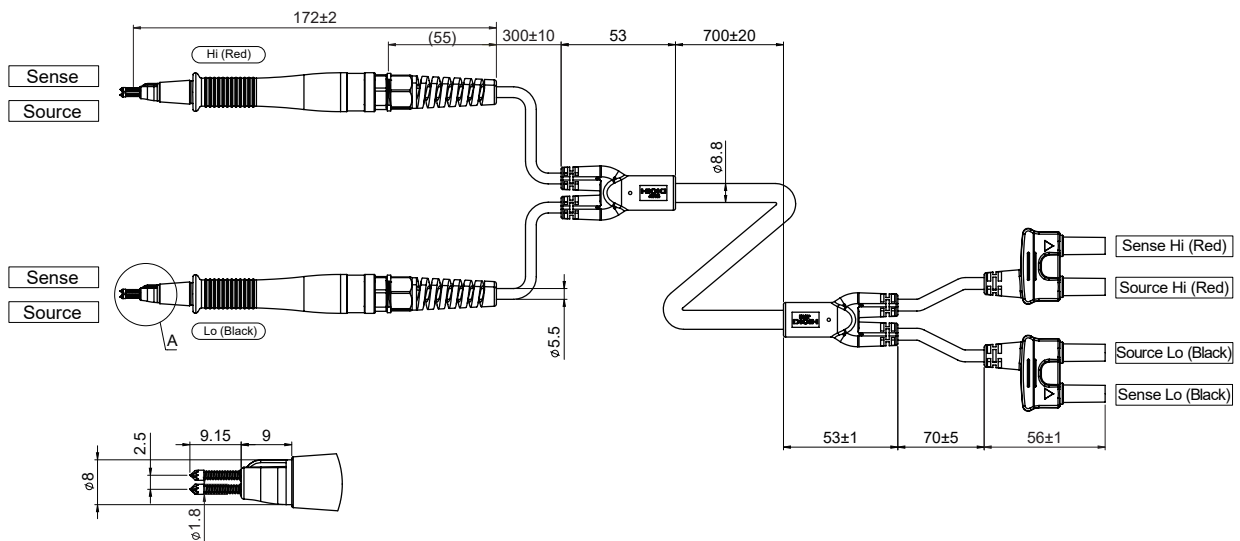

L2120 Pin Type Lead (up to 1000 V DC)

The L2100 is a four-terminal pin-type lead assembly with a high withstand voltage of up to 1000 V DC. It is ideal for measuring high-voltage battery packs and cells with a high line-to-ground potential. The tips have a parallel two-pin structure, enabling stable contact during measurement. The connector to be connected to the instrument has a one-piece design for both Source Hi and Source Lo, as well as for Sense Hi and Sense Lo, with these pieces separated from each other. It is effective in reducing variations in measured resistance values caused by induced voltage.

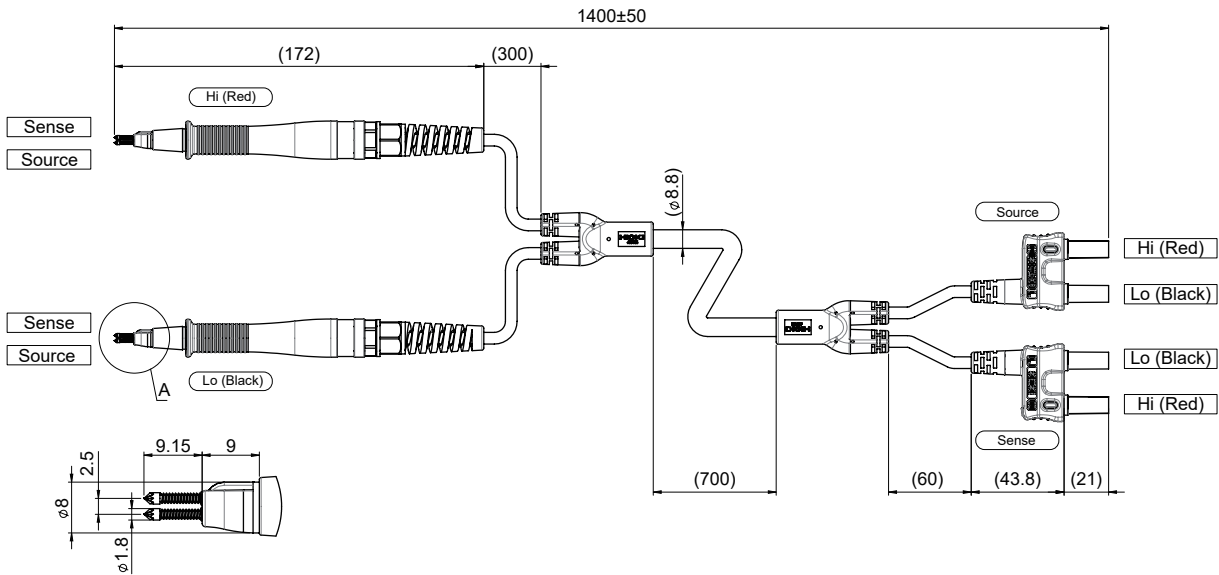

L2121 Clip Type Lead (up to 60 V DC)

The L2121 is a test-lead assembly terminated with clips. By simply pinching battery terminals with the clips, four-terminal measurement is enabled.

The connector to be connected to the instrument has a one-piece design for both Source Hi and Source Lo, as well as for Sense Hi and Sense Lo, with these pieces separated from each other. It is effective in reducing variations in measured resistance values caused by induced voltage.

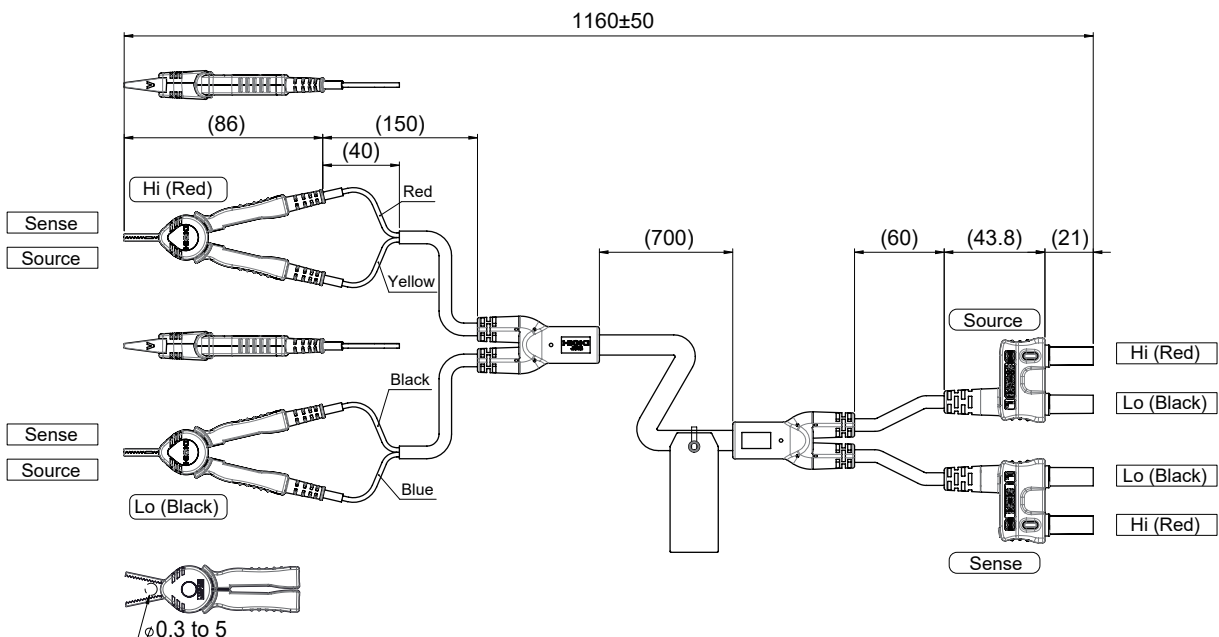

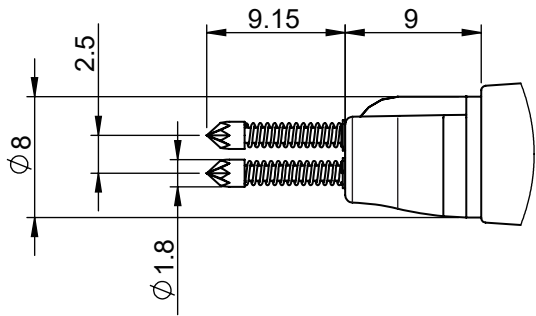
9772-90 Tip Pin (spear pin for L2100/L2120)

Unit: mm

How to replace the tip pin

If the tip pin breaks or becomes worn, you can replace it with a new one. Please place a separate order for the 9772-90 Tip Pin (one pin).

To purchase optional equipment, please contact your authorized Hioki distributor or reseller.

You will need: 9772-90 Tip Pin and pliers

- 1** Turn off the instrument and unplug the test-lead connector.
- 2** Use pliers to gently grasp and pull out the tip pin for replacement.

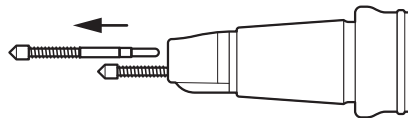

- 3** Insert the new 9772-90 Tip Pin into the socket. To prevent the tip pin from popping out, press it against a hard surface and insert it fully.

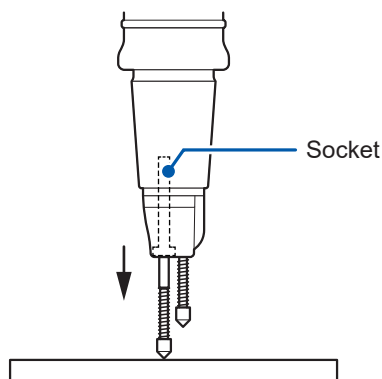

- 4** Check the instrument with the test lead connected for proper operation.

Before use, measure the resistance of a known object (battery) to verify that the instrument displays an accurate resistance reading.

14.12 Rack-Mounting the Instrument

After removing the screws on the sides, rack-mounting components can be attached to the instrument.

⚠ WARNING

- When attaching the rack-mounting components to the instrument, use the specified screws (M4 × 10 mm).



- After removing the rack-mounting components from the instrument to return it to its original state, secure the cover with the factory-installed screws.

Using any other screws could damage the instrument, resulting in bodily injury.

If any screw is lost or damaged, contact your authorized Hioki distributor or reseller.

Reference drawings of rack-mounting components

(Unit: mm)

Rack ears (JIS-compliant)

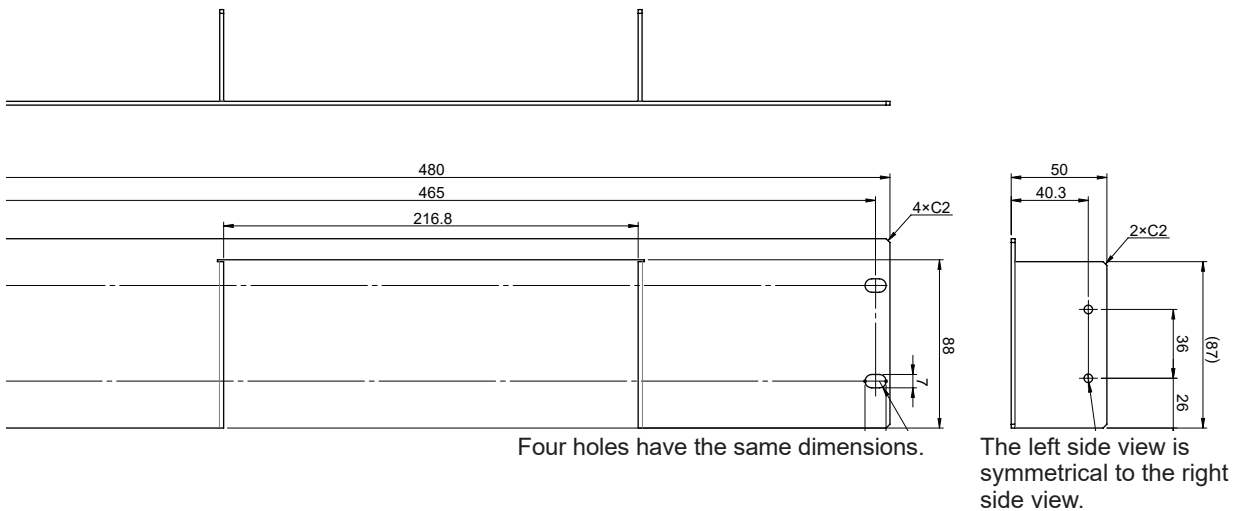

Rack ears (EIA-compliant)

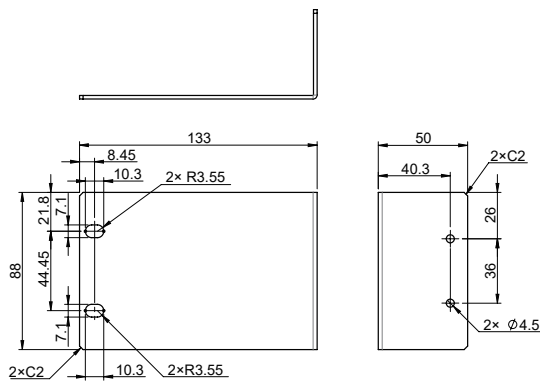

Spacer (×2)

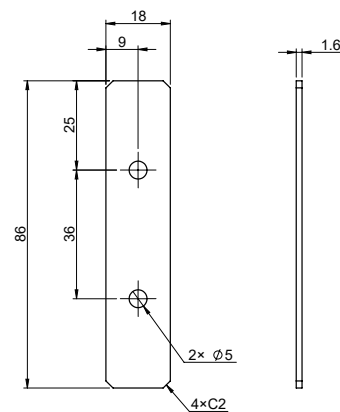

How to attach the rack-mounting components

You will need: Phillips screwdriver (No. 2) and rack-mounting components (JIS-compliant or EIA-compliant)

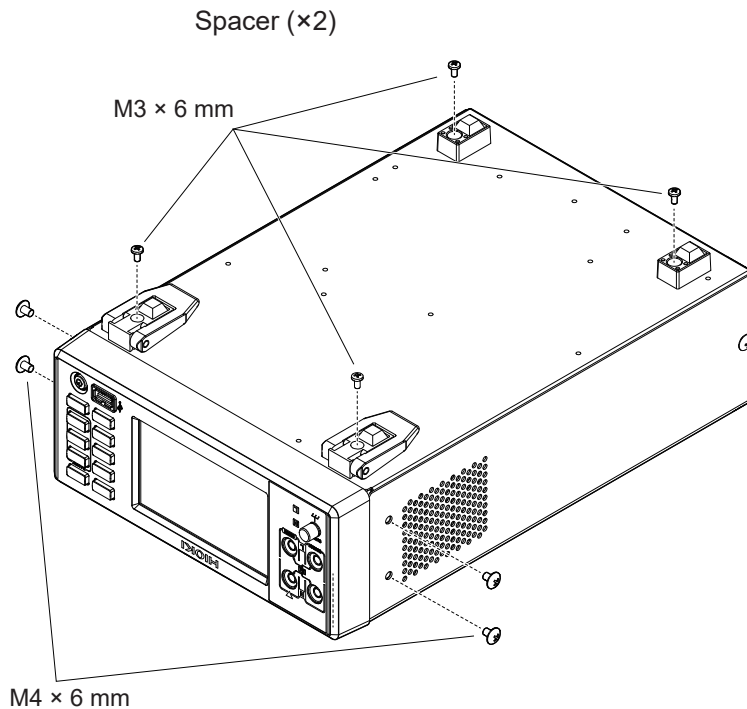

- 1** Place the instrument with its bottom face up and remove the eight screws on the support feet and its sides.
- 2** Remove the support feet from the instrument.

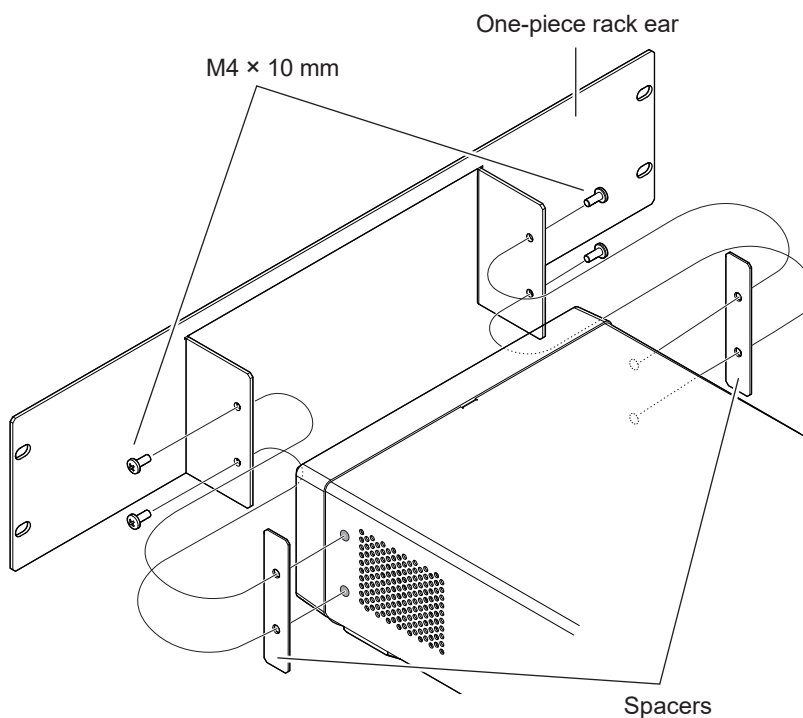

- 3** Insert the spacers between the rack-mounting ear(s) and both sides of the instrument and attach the ear(s) with the specified screws (four in total). Keep the extra four screws.

IMPORTANT

When rack-mounting the instrument, use commercially available shelves or other suitable parts to ensure adequate strength.

14.13 External Views

Front (The figure illustrates BT6075)

(Unit: mm)

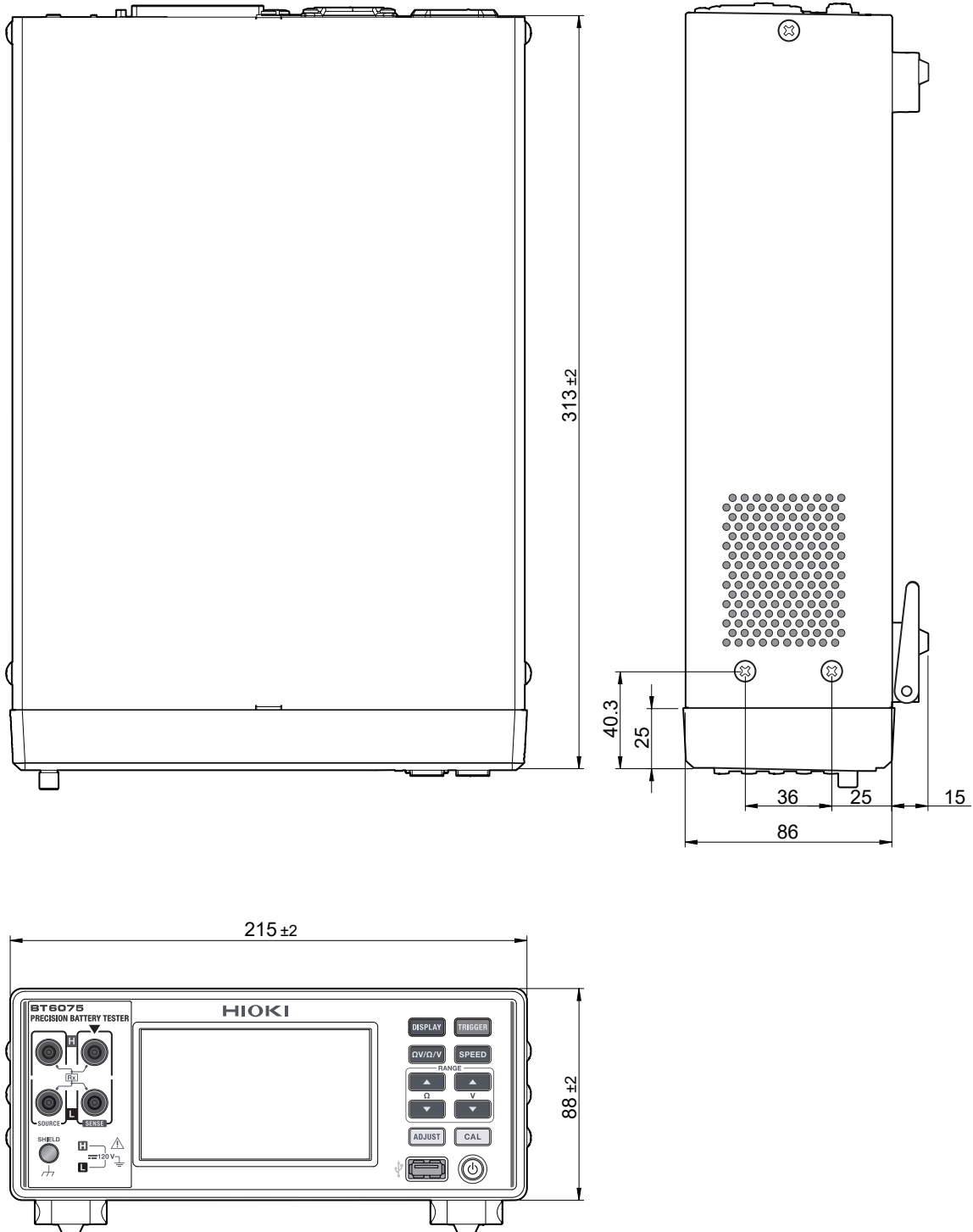

14.14 License Information

This model uses lwIP open-source software.

Amazon FreeRTOS

Copyright (C) 2020 Amazon.com, Inc. or its affiliates. All Rights Reserved.

Permission is hereby granted, free of charge, to any person obtaining a copy of this software and associated documentation files (the "Software"), to deal in the Software without restriction, including without limitation the rights to use, copy, modify, merge, publish, distribute, sublicense, and/or sell copies of the Software, and to permit persons to whom the Software is furnished to do so, subject to the following conditions:

The above copyright notice and this permission notice shall be included in all copies or substantial portions of the Software.

THE SOFTWARE IS PROVIDED "AS IS", WITHOUT WARRANTY OF ANY KIND, EXPRESS OR IMPLIED, INCLUDING BUT NOT LIMITED TO THE WARRANTIES OF MERCHANTABILITY, FITNESS FOR A PARTICULAR PURPOSE AND NONINFRINGEMENT. IN NO EVENT SHALL THE AUTHORS OR COPYRIGHT HOLDERS BE LIABLE FOR ANY CLAIM, DAMAGES OR OTHER LIABILITY, WHETHER IN AN ACTION OF CONTRACT, TORT OR OTHERWISE, ARISING FROM, OUT OF OR IN CONNECTION WITH THE SOFTWARE OR THE USE OR OTHER DEALINGS IN THE SOFTWARE.

lwip

lwIP is licenced under the BSD license:

Copyright (c) 2001-2004 Swedish Institute of Computer Science.
All rights reserved.

Redistribution and use in source and binary forms, with or without modification, are permitted provided that the following conditions are met:

1. Redistributions of source code must retain the above copyright notice, this list of conditions and the following disclaimer.
2. Redistributions in binary form must reproduce the above copyright notice, this list of conditions and the following disclaimer in the documentation and/or other materials provided with the distribution.
3. The name of the author may not be used to endorse or promote products derived from this software without specific prior written permission.

THIS SOFTWARE IS PROVIDED BY THE AUTHOR "AS IS" AND ANY EXPRESS OR IMPLIED WARRANTIES, INCLUDING, BUT NOT LIMITED TO, THE IMPLIED WARRANTIES OF MERCHANTABILITY AND FITNESS FOR A PARTICULAR PURPOSE ARE DISCLAIMED. IN NO EVENT SHALL THE AUTHOR BE LIABLE FOR ANY DIRECT, INDIRECT, INCIDENTAL, SPECIAL, EXEMPLARY, OR CONSEQUENTIAL DAMAGES (INCLUDING, BUT NOT LIMITED TO, PROCUREMENT OF SUBSTITUTE GOODS OR SERVICES; LOSS OF USE, DATA, OR PROFITS; OR BUSINESS INTERRUPTION) HOWEVER CAUSED AND ON ANY THEORY OF LIABILITY, WHETHER IN CONTRACT, STRICT LIABILITY, OR TORT (INCLUDING NEGLIGENCE OR OTHERWISE) ARISING IN ANY WAY OUT OF THE USE OF THIS SOFTWARE, EVEN IF ADVISED OF THE POSSIBILITY OF SUCH DAMAGE.

Index

A

Absolute value	99
AC four-terminal method	230
Auto-ranging	47, 50, 51, 188
Averaging	91

B

Backlight	110
Base	65
Buzzer sound (judgment)	102
Buzzer sound (operation feedback)	109

C

Calibration	53, 242
Communications command	152, 164
Communications time	152
Comparator	99
Contact check	77

D

Date and time	40
DC-voltage self-calibration	54
Default settings list	118
Disposal	222

E

Effect of eddy currents	235
Electromagnetic induction	234
External control	127
External I/O	127
External I/O testing capability	150
External trigger	87, 88, 142
External view	256

F

Function	46
----------------	----

H

High resolution mode	48
----------------------------	----

I

Inspection	32
Internal circuitry	143
Internal trigger	87

K

Key lock	112
----------------	-----

L

LAN connection	157
LAN interface	153
Line frequency	43

M

Manual range	
Resistance measurement	47
Voltage measurement	50
Measured-value batch transmission	170
Measured-value format	165
Measured-value output	167
Measurement range	47
Measurement speed	52
Measuring function	46
Memory	170
MIR	93
Multi-channel mode	60, 62, 64
Mutual interference	238

N

Network	153
Normal reset	117

O

Obtaining measured values	152
On-screen error	218
Optional equipment	9, 251
Overrange indication	78

P

Panel	
Changing the panel name	124
Panel loading	121, 123, 140
Panel saving	121, 122
Power switch	34
Program	152

R

Rack-mounting	254
Range	47
Referential adjustment	65
Resistance self-calibration	53
Route-resistance monitor	79, 103
RS-232C connection	159

RS-232C interface 158

S

Sampling speed..... 52
 Saving screenshots 173
 Screen saver 111
 Screenshot 173
 Self-calibration..... 139
 Self-test 36
 Serial number 21, 209
 Single-channel mode..... 60, 61, 63
 Sleep mode 35
 Specifications 177
 Standby mode 35
 Synchronous detection..... 231
 System reset..... 117

T

Temperature Sensor 39
 Test-lead assembly..... 225
 Time zone..... 41
 Timing chart..... 134
 Trigger 87
 Trigger delay..... 90
 Troubleshooting..... 212

U

USB cable
 Connection..... 163
 USB (COM mode) 160
 USB driver 161
 USB flash drive..... 173
 USB (MEM mode) 173

W

Wire-break detection 77

Z

Zero adjustment..... 56, 138, 246

HIOKI
www.hioki.com/



**All regional
contact
information**

HIOKI E.E. CORPORATION

81 Koizumi, Ueda, Nagano 386-1192 Japan

2402 EN

Edited and published by HIOKI E.E. CORPORATION

Printed in Japan

- Contents subject to change without notice.
- This document contains copyrighted content.
- It is prohibited to copy, reproduce, or modify the content of this document without permission.
- Company names, product names, etc. mentioned in this document are trademarks or registered trademarks of their respective companies.

Europe only

- EU declaration of conformity can be downloaded from our website.
- Contact in Europe: HIOKI EUROPE GmbH
Helfmann-Park 2, 65760 Eschborn, Germany hioki@hioki.eu