

CMP200

Automatic Barrier Gate with Telescopic Boom Arm

The CMP200 series offers brand-new automatic barrier gates equipped with telescopic boom arm that allows direction exchanging according to site application and a silvery housing with built-in LED indicating the state of the parking barrier, providing humanized user experience.

Its appearance and structure are designed based on the feedback and needs of the market and industry. Comparing with other barrier gates, the CMP200 series of automatic barrier gate products with telescopic straight boom might be an economic good fit meeting demands in different parking lots.

Features

- Better experience with auxiliary traffic lights in the main body
- Support anti-smash and automatic closing with an infrared detector, loop detector, radar detector
- Arm direction can be exchanged between leftward and rightward according to site application
- Opening and closing angle of $90^{\circ} \pm 2^{\circ}$
- Over voltage protection
- Support LPR, UHF reader controller and other devices for recognition and other A&C functions

Specifications

| | | | |
|------------------------------|------------------------------|----------------------------|-----------------------|
| Gate Opening/Closing Time | 3s (max. 4.5m), 6s (max. 6m) | Working Temperature Range | -25°C ~ +75°C |
| Supply Voltage | AC110V/220V, 50/60Hz | Working Humidity Range | ≤90% |
| Power Consumption | 100W (max. 120W) | Housing Dimensions (D*W*H) | 350 * 280 * 1010 (mm) |
| Remote Controlling Distance | ≤30m | Packing Dimensions (D*W*H) | 430 * 375 * 1100 (mm) |
| Remote Controlling Frequency | 430MHz | Net Weight | 45kg |
| Cabinet Material | Cold rolled steel | Gross Weight | 47kg |
| Boom Material | Aluminum and wood | | |

Boom information

| | | | |
|----------------------|--|------------------------|--------------|
| Boom Type | Telescopic boom | Straight boom with LED | Folding boom |
| Boom Length | 4.5m(packaging length 2.8m), 6m (packaging length 3.6m) | Max 4.5m | Max 4m |
| Opening/Closing time | 3s(max 4.5m), 6s(max 6m) | 3s | 3s |

Product Details

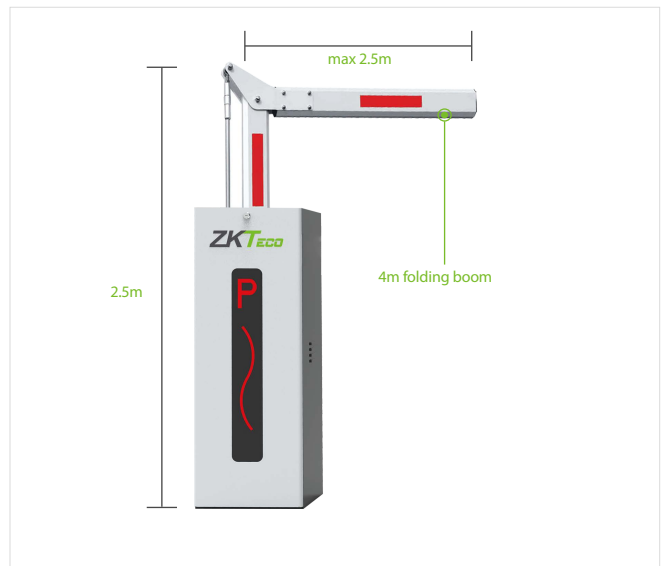
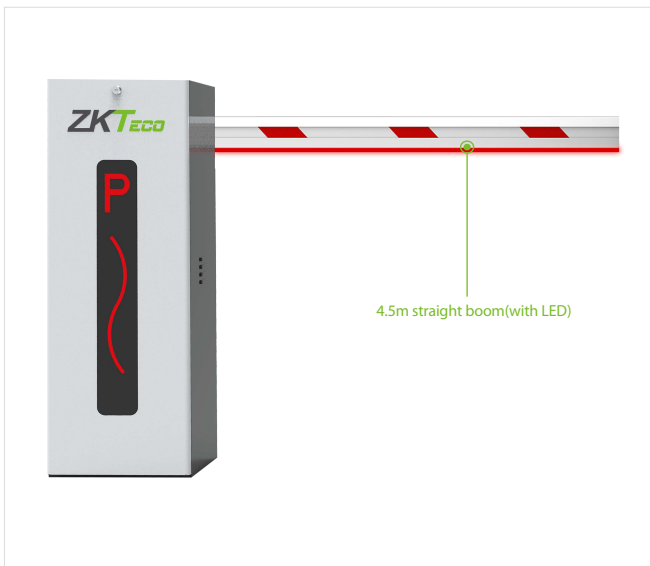
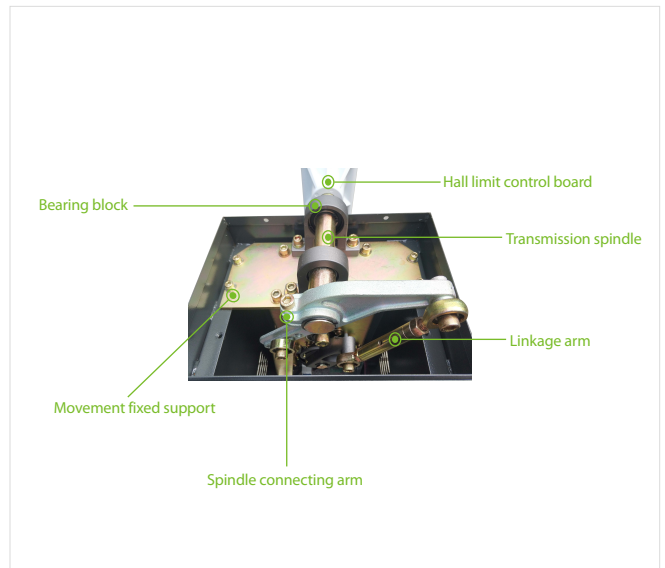
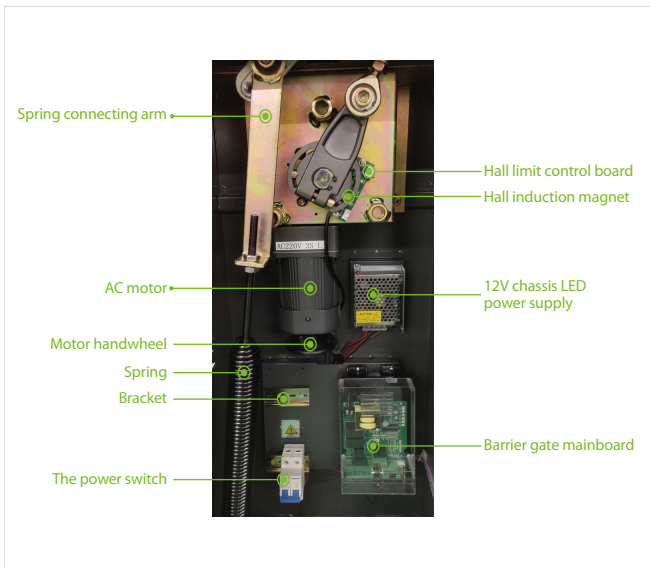
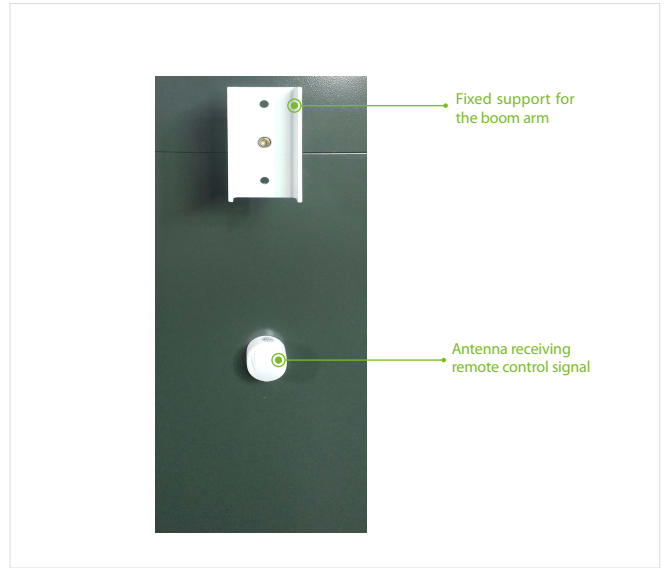

Dimensions (mm)

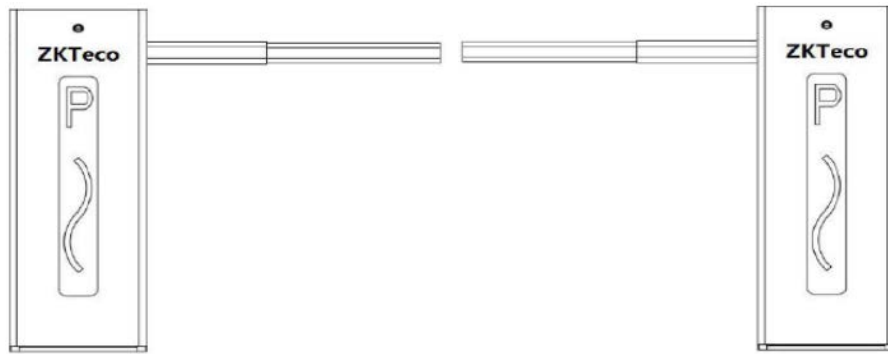
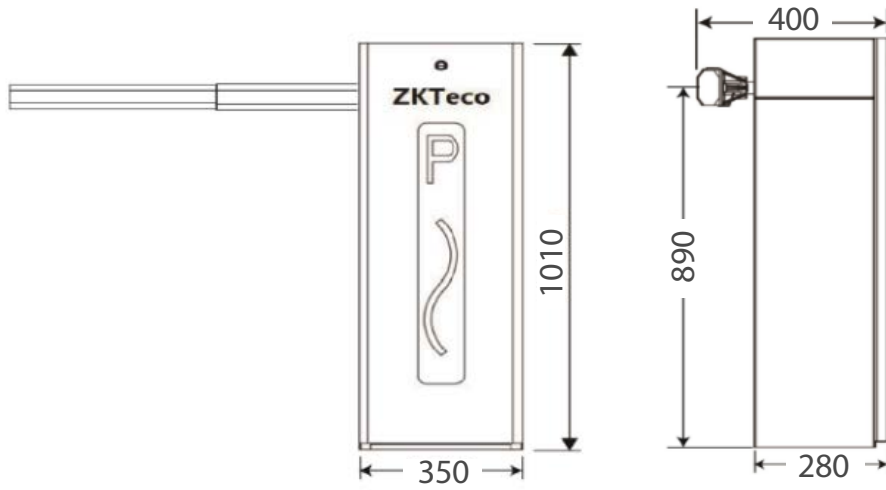

Left fixed: The cabinet on the left

Right fixed: The cabinet on the right

