

vatti

Instruction Manual

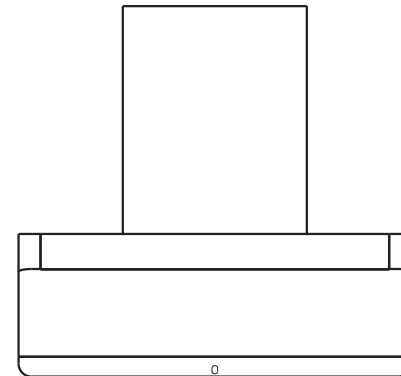

Range hood

V993

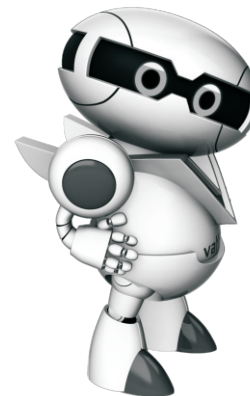

VATTI (M) SDN BHD
202101045273 (1445573-P)
Unit D5-08-01, Pusat Perdagangan Dana 1,
Jalan PJU 1A/46,47301 Petaling Jaya.
enquiry@vattimalaysia.com

Attention:

Important

For safety purpose, you should read the instructions carefully before using the appliance for the first time. Save the instruction for future reference.

The appliance is designed for domestic use and may only be installed and operated in accordance with these instructions for use.

If there is any malfunction arise during the operation, please contact with us timely on service :enquiry@vattimalaysia.com . If you contact unauthorized service agent, we will not responsible for your lost.

Table of Content

User Environmental Announcement ----- 1

Installation requirements ----- 2

Safety Precautions ----- 3

Safety Instruction ----- 5

Technical Parameter ----- 6

Product Image ----- 7

Spare Part List ----- 8

Packing List ----- 9

Installation Method ----- 10

How To Use ----- 12

Maintenance ----- 16

Disassembly And Clean ----- 17

Trouble Shooting ----- 19

Hot Wash Trouble Shooting ----- 20

After Sales Service ----- 21

User Environmental Announcement

"To protect the environment, benefit people, prevent pollution, and continuously improvement" The purpose and direction is our environmental management. In accordance with the Standards system of GB/T 24001-2016 / IDT ISO 14001:2015, we establish and implement the principles to protect the environmental management systems.

There are two environmental Announcements during use and after use:

1, Waste cartons and plastic bags are recyclable wastes, and waste foam plastics are non-recyclable wastes.

Please throw it into the designated classified trash bin after unpacking.

2, Any of the product has a service life, we recommended the service life of the range hood is 8 years. For the wasted products, please handle it properly so as not to pollute the environment.

After-sales Service

Warranty for VATTI Products

Warranty effective only for original buyers, and it is necessary for VATTI products buy only from authorized dealers;

For warranty claim, it is necessary to fill up warranty card properly and completely time of purchase;

Any kind of VATTI product warranty claim based on manufacture defect or poor workmanship under the normal use;

Product warranty period and maintenance are as per VATTI malaysia policy;

In case of providing home service, visit charges will be applicable as per policy;

Those who fall into one of the following situations are not covered by the free maintenance:

- a. Damage caused by improper use;
- b. Damage caused by non-VATTI service outlet installation, disassembly and maintenance;
- c. Cannot provide warranty card or valid purchase certificate, or the warranty card and valid certificate have been altered.
- d. The product model and product serial number on the warranty card or valid purchase certificate do not match the product model and serial number being repaired.
- e. Electric short circuit, voltage fluctuation, poor wiring, wrong use, miss parts, accidental damage and force majeure;
- f. Products that exceed the warranty period;

If the product fails out of the warranty period, VATTI after-sales outlets will also provide you with warm, thoughtful and timely paid services as per policy.

• Aftersales Process

1. If the product is in fault, contact VATTI malaysia servie:

enquiry@vattimalaysia.com

If users take product to unauthorized service network for maintenance, all consequences arising therefrom shall be borne by the user.

2. VATTI service network will response as soon as possible when getting the service information. According to users' feedback, service staff will judge the fault reasons and prepare the spare parts.

Installation Requirements

Caution

The installation process must be completed by appointed professional, and non-professionals are strictly prohibited from operating.

- Range hood should be installed directly above hob, the minimum distance between the bearing surface of hob and the lowest part of the range hood should be 65cm, if the installation instructions for hob specify a larger distance, which should be considered.
- The stretching distance of the flow pipe should be as short as possible, with less turning, and the angle of turning should be as large as possible to avoid excessive resistance and affecting the smoke exhausting effect.
- Range hood should be placed horizontally when installing to avoid the oil flowing out from the lower side during use.
- Flexible ductcan be extended outdoors and discharged into the atmosphere directly, or discharged into the cold air public flue should be sealed. If the exhaust gas is discharged outdoors directly, the air outlet of the flexible ductshould be placed in a sheltered place to prevent the exhaust fumes from flowing back.
- This machine is a Class I appliance. When the basic insulation protection is damaged, it relies on ground wire to the protection of electric shock, Therefore, the connection between the power socket and the ground wire must be ensured.
- The telescopic length of flow pipe is 1.8m, kindly please pay attention to the installation environment of the kitchen.
- The exposed length of power cord is about 1.5m, kindly please pay attention to the installation position of the socket.

Safety Precautions



Attention

1. Please operate the range hood in accordance with the instruction to avoid the property loss and personal injury.
2. In order to protect personal and property safety, Only qualified allowed to install, adjust and maintained the range hood, if any operator who was designated by the user, the user would take the risk of person injury and property loss.
3. If any provision of this specification is in conflict with the mandatory provisions of national law, the legal provisions shall prevail
4. This appliance can be used by children aged from 8 years and above and persons with reduced physical, sensory or mental capabilities or lack of experience and knowledge if they have been given supervision or instruction concerning use of the appliance in a safe way and understand the hazards involved. Children shall not play with the appliance. Cleaning and user maintenance shall not be made by children without supervision.
5. This appliance is not intended for use by persons (including children) with reduced physical, sensory or mental capabilities, or lack of experience and knowledge, unless they have been given supervision or instruction concerning use of the appliance by a person responsible for their safety. Children should be supervised to ensure that they do not play with the appliance.

Symptoms	Reasons	Solutions
Oil leak	Range hood install with angle	Install in horizontal position
	Duct set sealing broke	Replace sealing coil
	Oil occupied on hood	Clean the hood
Hot Wash Function Fault	Water pump error	Replace water pump
	Heating element error	Replace heating element
	Controller error	Replace controller
Lights no work	No connect to power	Check the cord and plug connect to power
	Lights broken up	Replace lights
Gesture Sensing Function Fault	Gesture Sensing window is dirty	Clean the Gesture Sensing window

Trouble Shooting

Error Code	Reasons	Solutions
E0	Control loop for heating element fault	Shut off power, cool off the range hood for 10mins, If not work, shut off the range hood and wait for the maintenance staff.
E2	Heating element open circuit or water pump and waterway broke	
E3	Temperature sensor broke	shut off the range hood and wait for the maintenance staff
E5	Communication failure	
E6	Frequency conversion failure	



Attention

1. When use the range hood, in case of range hood broken, you should contact the maintenance staff if the heating element is broke.
2. When using the hot wash function, it is normal occasion for water spray sound, steam rustle sound and slight steam leak

Trouble Shooting

If the range hood is in abnormal status, cut off the power and contact maintenance staff. The table below is used for maintenance staff only. Non-specialized person cannot disassemble and repair the range hood.

Symptoms	Reasons	Solutions
Range hood no working	Do not connect to power	Check the cord and plug connect to power
	Fan block	Dismiss fan block
	Motor block	Lube or replace motor
	Motor broke	Replace motor
	Switch broke	Fix or replace switch
	Capacitor broke	Replace capacitor
	PCB broke	Replace PCB
Range hood abnormal knocking or shaking	Foreign object in hood cabinet	Dismiss foreign object
	Fan is not stable	Adjust or replace fan
	Bolt loose	Check and tighten the bolt
	Range hood is not in stable position	Install in stable position
	Fan broke	Replace fan
	Fan is not in good position	Fan installed in good position
	Motor is not in good position	Motor installed in good position
Range hood is not good suction performance	Range hood installed in too high position	Install the range hood in good height
	Too large negative pressure in kitchen	Open door or windows
	Withdrawal wind in duct	Change the duct exit to wind-proof place or put the duct exit downward
	Greasy duct pipe	Replace duct pipe
	Anti-backward cover block	Clean or replace anti-backward cover
	Motor speed decrease	Replace motor or capacitor

6. There shall be adequate ventilation of the room when the range hood is used at the same time as appliances burning gas or other fuels;

7. There is a fire risk if cleaning is not carried out in accordance with the instructions;

8. Do not flambé under the range hood;

9. **CAUTION:** Accessible parts may become hot when used with cooking appliances.

10. The air must not be discharged into a flue that is used for exhausting fumes from appliances burning gas or other fuels;









11. Regulations concerning the discharge of air have to be fulfilled.

12. **Warning:** Failure to install the screws or fixing device in accordance with these instructions may result in electrical hazards.

13. Range hoods and other cooking fume extractors may adversely affect the safe operation of appliances burning gas or other fuels (including those in other rooms) due to back flow of combustion gases. These gases can potentially result in carbon monoxide poisoning. After installation of a range hood or other cooking fume extractor, the operation of flued gas appliances should be tested by a competent person to ensure that back flow of combustion gases does not occur.

Safety Instruction

Dangerous

-  The gas discharged by the smoke absorber should not be discharged into the hot flue used to discharge the smoke of combustion gas or other fuel to prevent the occurrence of fire.
-  Do not bake directly to the range hood to prevent fire and damage.
-  The room must be well ventilated when the hood is used in conjunction with a stove burning gas or other fuel. In case of incomplete combustion of gas poisoning
-  The machine needs to use special single-phase two-pole with ground socket, and the ground wire of the socket must ensure reliable connection. Please ensure that electrical outlets are installed by a professional electrician and comply with the national and local regulations.
-  If the power cord is damaged, it must be replaced by the manufacturer Or the professional engineer
-  To avoid the electric shock hazard. Do not use wet hand to touch the power plug when electrical components and power switch were operating
-  The range hood must be removed and cleaned in accordance with the instruction manual, otherwise fire and other dangerous accidents may occur.
-  Packing plastic bags, foam and packing boxes are not toys. It is a high risk of suffocation on the head, please handle it properly. Keep packing materials away from children.
-  Please unplug the power plug before cleaning and repairing to avoid electric shock.

- Oil filter disassembly and clean

Step 1: Press “” button, make the slide air inlet assembly open, cut off power connection for safety;

Step 2: Use both hands to pull corner oil filter, a little distance between, remove the oil filter upward;

Step 3: Use screwdriver unscrewed the oil on the surface and bottom 6 screws;

Step 4: Open oil filter, cleaning and drying;

Step 5: Assemble the oil filter vise versa and connect to the power.

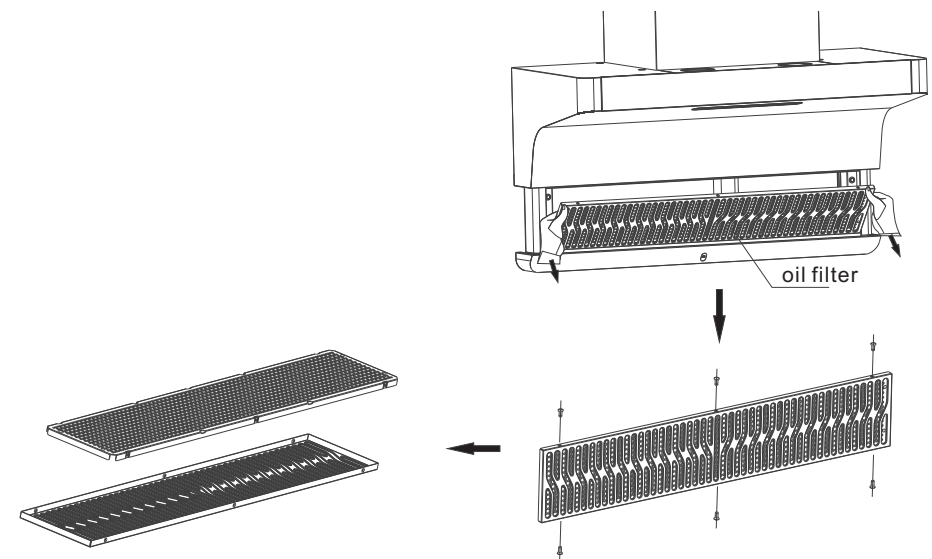

- Deep clean the hood surface and oil filter net 1-3 months each time according to your use frequency.
- Do not use water to clean the range hood directly in case water damaging the electric parts. Any abnormal phenomenon happened, cut off the power connection.

Disassembly And Clean

Attention





1. This part must be conducted by maintenance staff;
2. The disassembled part should not be crushed or dropped in case of transformation or damage. It will influence the good performance of range hood;
3. The disassembly pictures are for reference only.

• Fan disassembly and clean

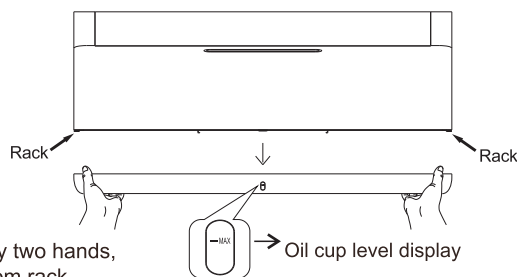
1. Cut off power connection for safety;
2. Discharge the chimneys, unfold the bolts on hood cabinet, unfold the bolts on air inlet part to discharge the air inlet part;
3. Unfold the fan tighten screw clockwise;
4. Put the discharged parts in to the neutral detergent water, use towel or brush to clean;
5. Assemble the clean parts vise versa;

• Oil cup disassembly and clean



	Forbid to modify the structure and inner line layout, it may course dangers like electrical shock and fire.
	Turn off the range hood once the wok/pan is on fire, distinguish the Strict implement fire by closing the gas regulator, covering the wok/pan by metal lid.
	Disconnect the electricity power source to avoid electrical shock once the range hood fault, or need installation and repair.
	Never operate the range hood once there was gas leakage but no fair. The operation may light the gas, and explosion may occur.

Technical Parameter

Model Number	V993
Power	220-240V~ 50 Hz
Maximum Static Pressure	850 Pa
Motor Power	220 W
Product Input Power	223 W
Lamp	1×Max.3 W
Cleaning Pump Voltage/Power	DC12 V /12 W
Heater Power	700 W
Air Flow (European Standard)	1200 m³/h
Turbo Air Flow (European Standard)	1320 m³/h
Unrestricted Airflow	2500 m³/h
Size of External Diameter	Φ185 mm

Attention

The Variance data of the Actual and explicit values of the air flow, air pressure, and the maximum static pressure shall be not exceed -10 % of the stated value;

Product Image

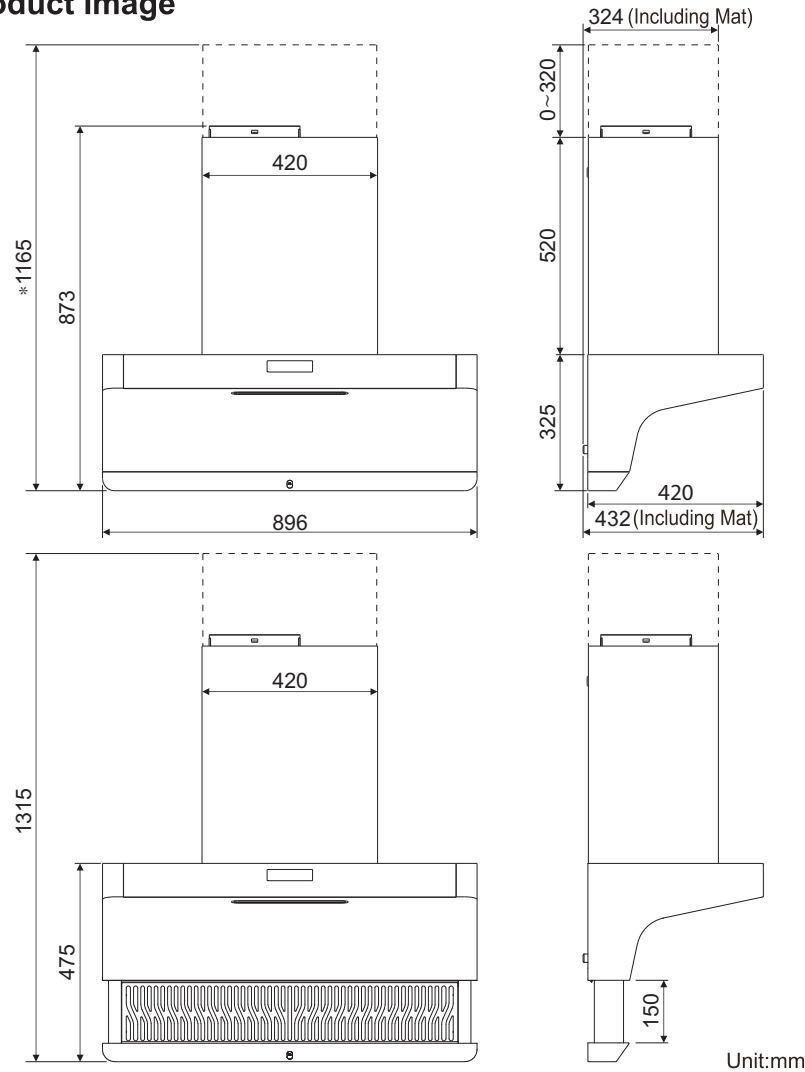

⚠ Attention

- Total Height of 1165 mm: With the second chimney hood.
- Diagram size is only for reference, if there is some deviation after the installation, it is recommended to reserve the unilateral not less than 5mm gap for the peripheral cabinets.

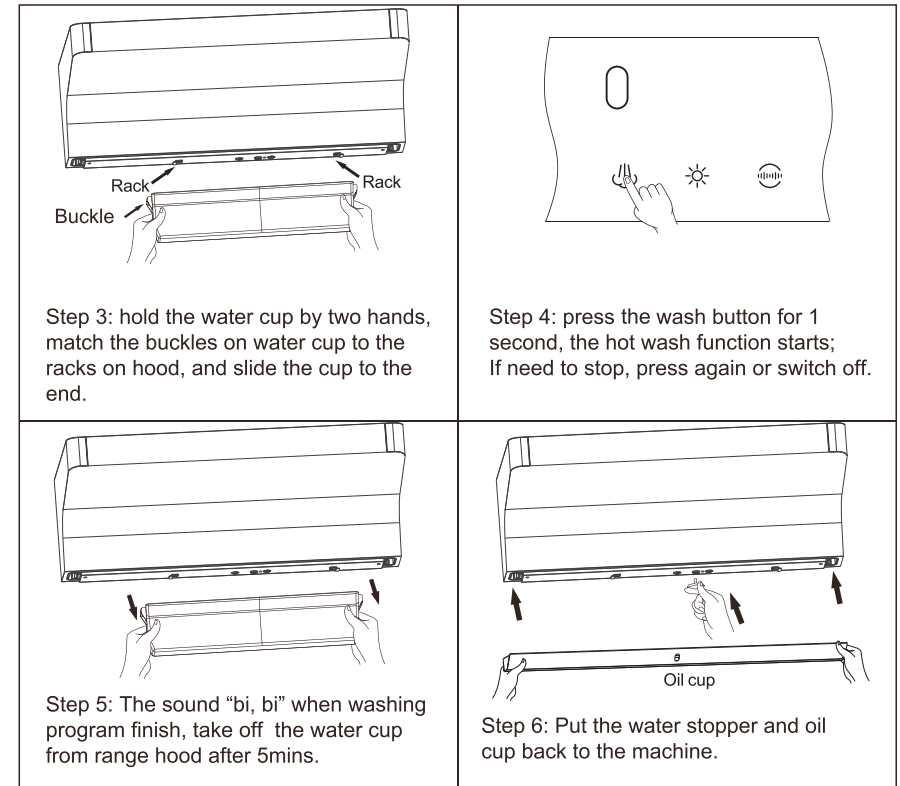

Maintenance

In order to keep good performance and prolong the lives of range hood, good maintenance is very important. Discharge the power connection when doing maintenance in case of safety.

- Keep the hood surface clean, use clean towel and neutral detergent only
- When the oil level is close to max line, pull away the oil in case of oil leak to pollute the kitchen and influence oil cup performance. Use strong acid or strong base detergent to clean oil cup.

9. Wash Function

Tips: Switch off the air button when use hot wash function

! Attention

- Detergent will damage the wash system. Do not use detergent for washing;
- Washing cup must install in right position, or it will damage the range hood;
- Clean the washing cup after finish wash function;
- When use wash function, keep no food, flame under the hood in case of contamination or danger;
- Water used for washing must not higher then 40 °C;
- Use stopper to block water suction mouth in case of oil block
- Wash steps are as follows, for reference only.

Before using cleaning function, press “  ” button, make the slide air inlet assembly open, and shut off air stage function.

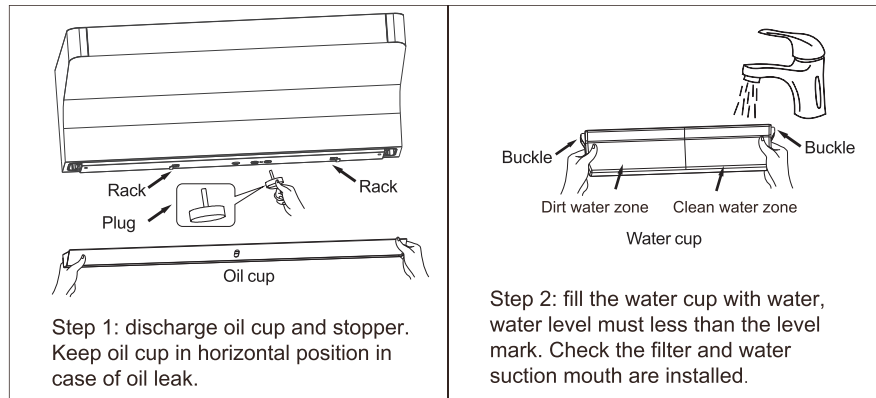

Spare Part List

The following product model structure diagram is a general simple structure diagram, only for users to identify the location of parts, if the graphics and the physical objects are inconsistent, please take the physical objects as the subject, Thanks for your attention!

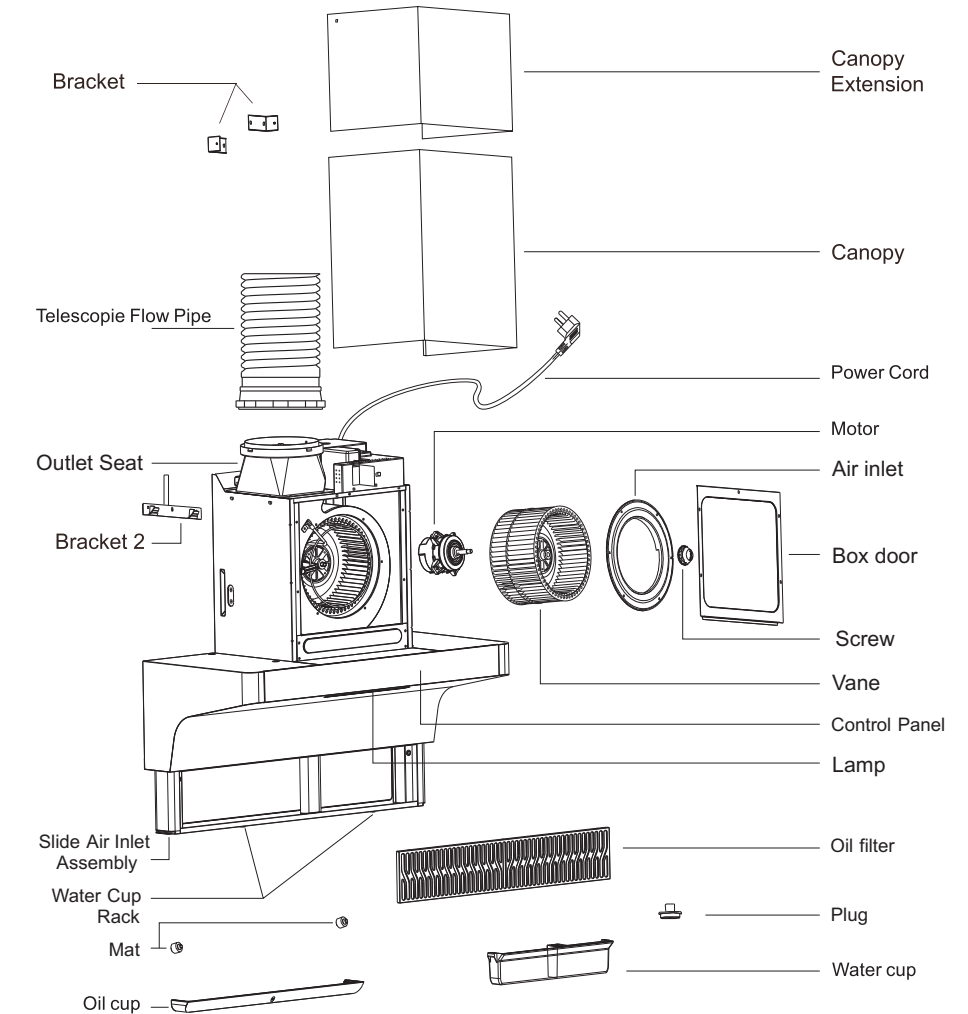

Packing List

Caution: Please check the products and accessories whether is complete according to below packing list.

No.	Item	Qty	Unit	Remarking
1	Range hood	1	pc	
2	Telescopic flow pipe	2	set	Install on the air outlet of the range hood
3	Hanger	1	pc	Fix the range hood on the wall
4	Oil cup	1	pc	Collect the dropping oils
5	Hanger	2	pc	Mount on the wall and fix the air duct cover
6	Screw M4x25	1	pc	Mount on the hanger to prevent the range hood from slipping off
7	Screw M4x8	2	pc	Fix air duct cover
8	Screw 5x80	3	pc	Screw into the plastic expansion tube, fix hanger
9	Self-tapping screw ST4.8x25	4	pc	Screw into the plastic expansion tube, fix hanger
10	Φ 8plastic expansion tube	4	pc	Insert into the wall
11	Φ10 plastic expansion tube	3	pc	Insert into the wall
12	Mat	2	pc	Assemble back of the range hood
13	Duct and cap	1	pc	Installed on the wall, to prevent rain, wind, birds to enter
14	Oil filter	1	pc	Installed on the sliding air inlet assembly
15	Water cup	1	set	Containing clearing fluid and wastewater
16	Cushion	2	pc	Assemble back of the range hood
17	Manual	1	pc	Please keep it safe
18	Serial number	2	pc	Please keep it safe
19	Aluminum tape	2	pc	Connect the tape and adaptor
20	Warranty card	1	pc	Please keep it safe

⚠ Caution

Kindly please contact with dealer or our customer service center, if the product and accessories are missing or damaged

- On the time-delayed working mode, wave “ ” left to right quickly through the gesture sensing Windows at both ends (as shown in figure 5) to exit the time-delayed state, and the air volume will respond according to the above instructions;

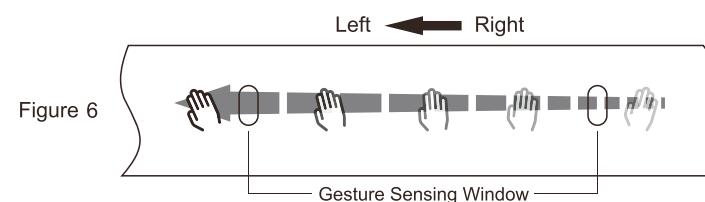
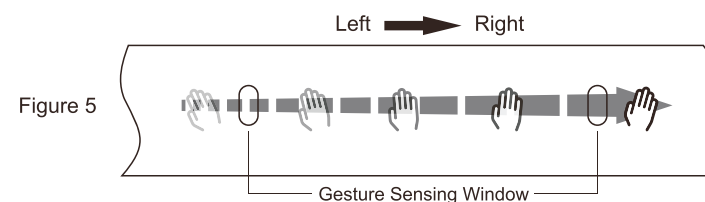

8. Auto-speed

Press “ ”, the range hood will go into auto-speed mode, The hood will adjust automatically according to the smog. Press again , the function will shut off.



(2) Timer Delay Setting

When range hood is under Air mode or lighting mode, press “” button will switch on the timer delay function, for “3mins delay off” The range hood will shut off air and light after timer delay function. when in delay mode, press any button will shut off delay mode.





5. Stir fry

Press “” button, the 3mins stir fryfunction will switch on. When the stir fryfunction is on, press again will shut off the function and switch to Air stage function.

6. Cleaning Lock Function

This function is used for buttons mistakenly switching on when cleaning. Press “” button 3 seconds, cleaning lock function will switch on, “” symbol flashing, and all buttons are locked. Press again “” button for 3 second will switch off the cleaning lock function or wait half hour for automatically shut off.

7. Gesture sensing function

- On the ready mode, Please wave “” left to right quickly through the gesture sensing Windows at both ends (as shown in figure 5), open the range hood (including the light);
- On the working mode, wave “” quickly passes through the gesture sensing Windows at both ends from right to left (as shown in figure 6), and close the range hood (including the light);
- Under the working mode of 1 speed, 2 speed, 3 speed, wave “” left to right through the gesture sensing Windows at both ends (as shown in figure 5), and the 3-minute stir-frying function is enabled;
- On the working mode of stir-frying, wave “” left to right quickly through the gesture sensing Windows at both ends (as shown in figure 5), and auto-speed function is enabled;

Installation Method

- As figure (1), drill three holes of $\Phi 10\text{mm}$ horizontally on the wall, hole depth 90mm, and hole spacing 109mm;
- Insert a $\Phi 10\text{mm}$ plastic expansion tube into the drilled hole and tighten it with 5x80mm wood screw through the hanger hole to secure the hanger to the wall;
- Drilling air outlet, open the air outlet at a distance of 200mm – 300mm above the air outlet of range hood, and the exhaust outlet should be placed in a sheltered place as much as possible;
- Insert the long end of the duct into the outlet, then connect the air outlet and the duct by 2 pieces of aluminum tape to ensure that there is no air leakage between the duct and outlet seat;
- Then tighten two pieces of cushions to the corresponding position on the rear of the range hood, hang the range hood horizontally, and then screw an M4x14 screw into the hanger hole to prevent the range hood from slipping off.
- Install the air duct cover (if needed): If the kitchen room has suspended ceiling and flexible duct through the ceiling (the opening size as Figure 2);

Duct cover installation method as Figure 1;

1. Drill four $\Phi 8$ mm holes horizontally on the wall , below the ceiling 20mm, with a hole depth of 40mm and a hole spacing of 60mm,252mm,60;
2. Insert a $\Phi 8$ mm plastic expansion tube into the drilled hole, and then fix the hanger withST4.8x25 self-tapping screw through the hanger on the wall;

3. Pull the air duct cover to the required height, and then attach it to the hanger with two pieces of M4x8 screws;

- Extend the flexible duct into the opened air outlet. The flow pipe should be freely bent, and the pipe wall has no concave and convex deformation, the connection is tight and the rotation pieces is smooth and natural;(As figure 3)

- Install oil cup, put the oil cup on the hook at the bottom of the range hood;

- Debugging after installation, After installation, the product should be tested according to the operation instructions in “How To Use” , make sure all the functions work properly during testing.

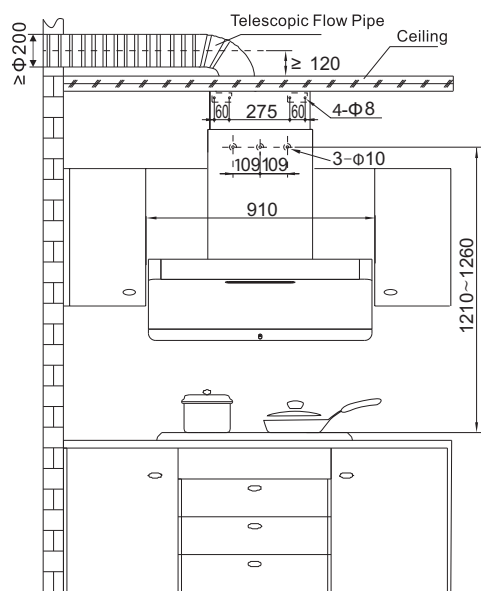

Figure 1

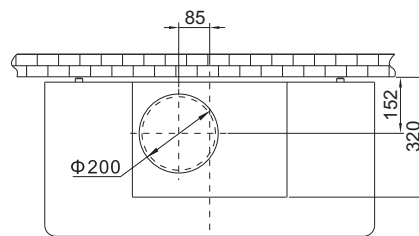

Figure 2

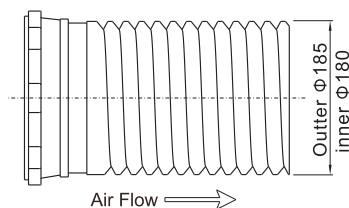

Figure 3

Unit:mm

⚠ Caution

This installation height is only applicable to electric cooker, if installed in gas cooker upper part, installation height in accordance with the requirements of gas cooker installation height.

How To Use

- Control Panel(If the panel symbols are updated, please refer to the actual ones)

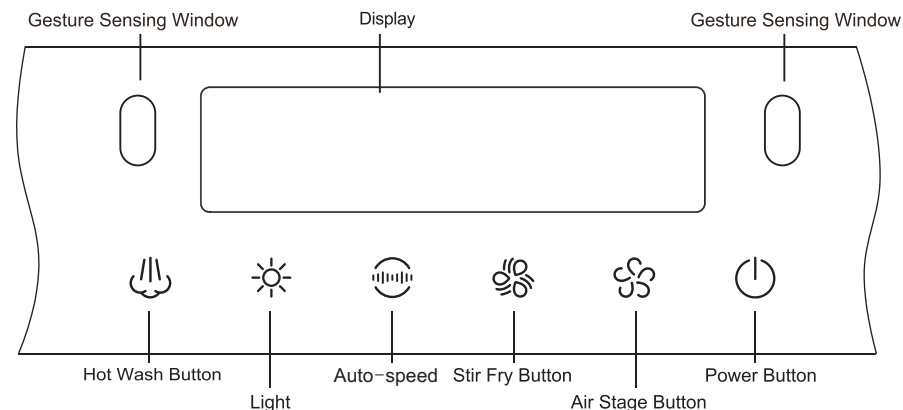

Figure 4

- Function Instruction

1. First connect to power

When connect to power, the range hood will beep in 1 second.

2. Air Stage Adjustment

Press “☪” button, switch on the range hood, continue to press “☪” will switch among “higher speed/medium speed/lower speed”; Press “⏻” button, the range hood will shut off.

3. Light Switch

Press “☀” button will illuminate the light; Press “☀” button again will shut off the light.

4. Clock Setting/Timer Delay Setting

(1) Clock Setting

Under standby mode, press “⌚” button, 3S to set the time,First is hour setting, Press again is minute setting. Press “☺” for “-” adjustment, while “☻” for “+” adjustment. Press “⌚” again, the time is sure to set.