



User Manual

VWM122SAA-X
VWM155SAA-X

Warning

As the appliance contains a flammable refrigerant, it is essential to ensure that the refrigerant pipes are not damaged.

The quantity and type of the refrigerant used in your appliance is indicated on the rating plate.

Standard EN378 specifies that the room in which you install your appliance must have a volume of 1m³ per 8 g of hydro-carbon refrigerant used in the appliances. This is to avoid the formation of flammable gas/air mixtures in the room where the appliance is located in the event of a leak in the refrigerant circuit.

WARNING:

Keep ventilation openings in the appliance's cabinet or in the built-in structure clear of obstruction.

WARNING:

Do not use other **mechanical devices** or other means to accelerate the defrosting process than those recommended by the manufacturer.

WARNING:

Do not damage the refrigerant system.

WARNING:

Do not use **electrical appliances** inside the refrigerated storage compartment, unless they are of a type recommended by the manufacturer.

WARNING:

Do not expose the appliance to rain.

WARNING:

This appliance may be used by children over the age of 8 years old and by persons with reduced physical, sensory or mental capabilities or by persons with a lack of experience or knowledge if they are supervised or are instructed by a person responsible for their safety how to use the appliance safely and have understood the associated hazards.

WARNING:

Children must not play with, on, or around the appliance.

WARNING:

Children must not clean the appliance or carry out general maintenance unless they are at least 8 years old and are being supervised.

WARNING:

Do not store explosives, such as aerosol cans with flammable propellants in the unit.

**WARNING:**

Danger risk of fire or explosion if flammable refrigerant are used. To be repaired only by trained personnel.

WARNING:

When positioning the appliance, ensure the power cord is not trapped or damaged.

WARNING:

Do not locate multiple portable socket-outlets or portable power supplies at the rear of the appliance.

- Always keep the keys in a separate place and out of reach of children.
- Before servicing or cleaning the appliance, unplug the appliance from the mains or disconnect the electrical power supply.
- **Relevant for Australia:** Supply cord fitted with a plug complies with AS/NZS 3112.
- Frost formation on the interior evaporator wall and upper parts is a natural phenomenon. Therefore, the appliance should be defrosted during normal cleaning or maintenance.
- Please note that changes to the appliance construction will cancel all warranty and product liability.
- If the supply cord is damaged, it must be replaced by the manufacturer, its service agent, or similarly qualified persons in order to avoid a hazard.
- Do not use extension cords.
- This appliance is intended to be used exclusively for the storage of wine

CLASS 1 LED PRODUCT

Contents

Warning	2
Savings in energy consumption in the use ..	4
Before use	4
Get to know your wine cooler	5
Technical data.....	6
Installation and start-up	6
Operation and function	9
Defrosting, cleaning and maintenance	11
Reversible door	12
Fault finding.....	14
Warranty, spare parts and service	15
Disposal.....	16
Safety instructions	17

Before use

On receipt, check to ensure that the appliance has not been damaged during transport. Transport damage should be reported to the local distributor before the wine cooler is put to use.

Remove the packaging. Clean the inside of the cabinet using warm water with a mild detergent. Rinse with clean water and dry thoroughly (see cleaning instructions). Use a soft cloth.

If during transport the appliance has been laid down, or if it has been stored in cold surroundings (colder than + 5°C), it must be allowed to stabilise in an upright position for at least an hour before being switched on.

Savings in energy consumption in the use

The energy consumption reduces ..

- 1)..the lower the ambient temperature is.
- 2)..the warmer thermostat set point is.
- 3)..the lower the number and the shorter the length of the door openings is.

Get to know your wine cooler

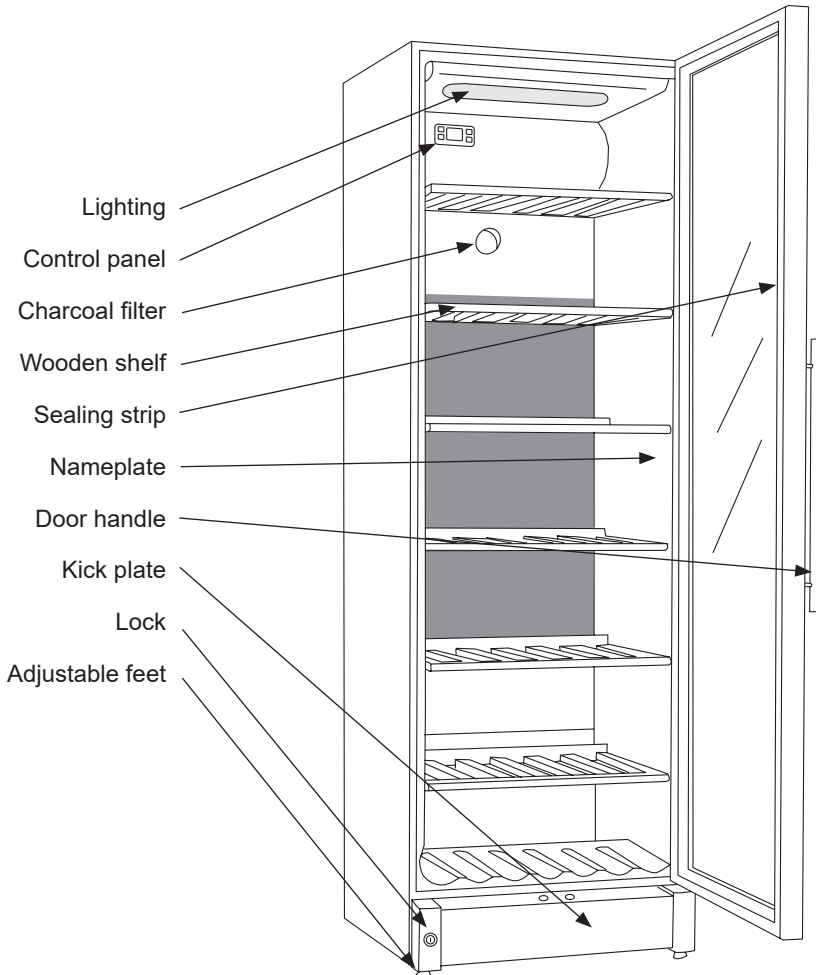

fig. 1

Technical data

Wiring and connections in power supply systems must be in accordance with all applicable (local and national) electrical codes. Consult these codes lengths and sizes prior to cabinet installation.

This device complies with relevant EU directives including Low Voltage Directive 2014/35 LVD. and Electromagnetic Compatibility Directive 2014/30/ Electromagnetic Compatibility Directive.

The socket should be freely accessible.

Connect the appliance only to 220/240 V / 50Hz alternating current via a correctly installed earthed socket.

The socket must be fused with a 10-13 A fuse.

If the appliance is to be operated in a non-European country, check on the rating plate whether the indicated voltage and current type correspond to the values of your mains supply.

Information regarding voltage, current or power are given on the rating plate

The power cord may be replaced by a technician only.

The rating plate provides various technical information as well as type and serial number.

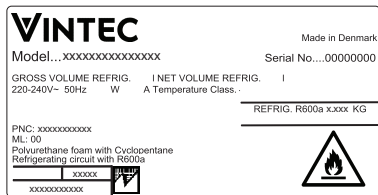

fig. 2

Installation and start-up

Placement

For safety and operational reasons, the appliance must not be installed outdoors.

The appliance should be placed on a level surface in a dry, well ventilated room (max. 75% relative air humidity). Never place the appliance close to sources of heat such as cookers or radiators, and avoid placing it in direct sunlight.

Ambient temperature

The climate class is stated on the nameplate (see page 7 and page 14). This specifies the optimum ambient temperature. Wine coolers with winter position, however, function at ambient temperatures as low as 5°C.

Climate class	Optimum room temperature
SN	+10 °C to +32 °C
N	+16 °C to +32 °C
ST	+16 °C to +38 °C
T	+16 °C to +43 °C

Installation

The surface on which the appliance is to be placed must be level. Do not use a frame or similar.

The appliance can be installed as a free-standing unit against a wall, built into a kitchen element, or lined up with other appliances (figs 3-4).

Installing the Wine Cooler

Your Electrolux wine cooler has been designed for either free-standing installation. The front grille must NOT be obstructed.

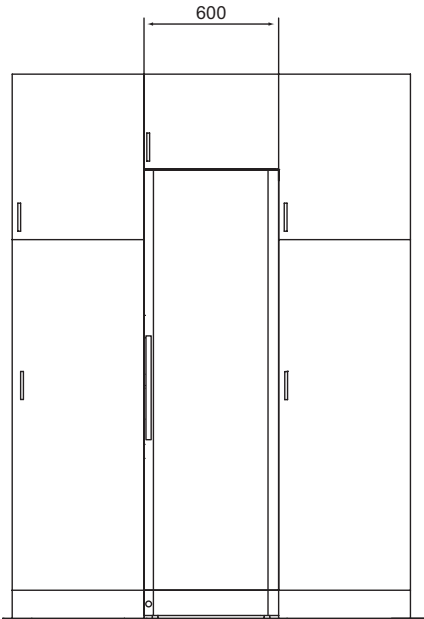

fig. 3

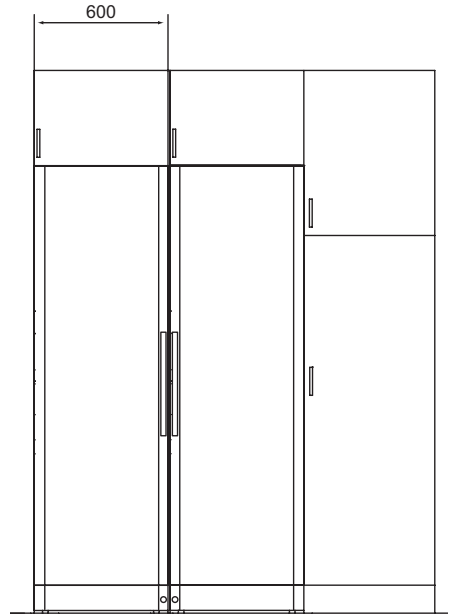

fig. 4

The appliance viewed from above

If the appliance is placed beside a wall, there must be sufficient room for its door to be opened wide enough to allow the shelves to be pulled out.

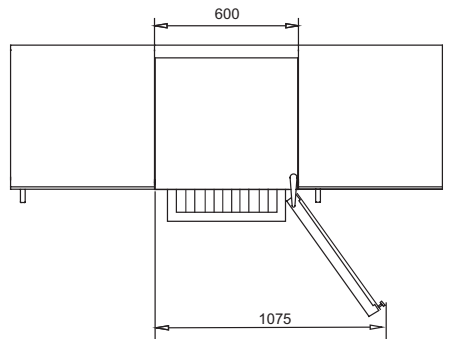

fig. 5

Ventilation

It is important that the appliance be well ventilated and that air can circulate unhindered above, below and around it.

The figures below illustrate how the necessary air circulation around the appliance can be ensured (fig 6).

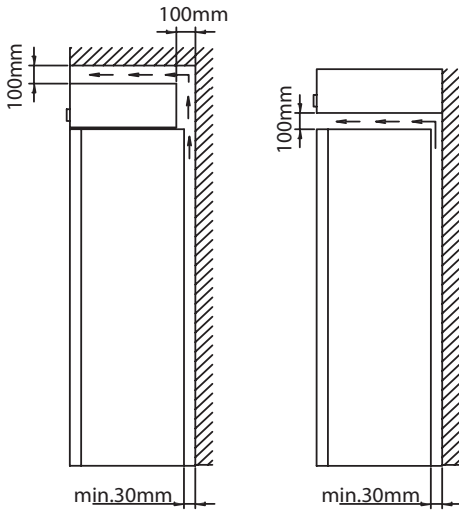

fig. 6

The distance pieces on the rear of the appliance ensure sufficient air circulation. Fit the two caps supplied with the appliance as shown in fig. 7.

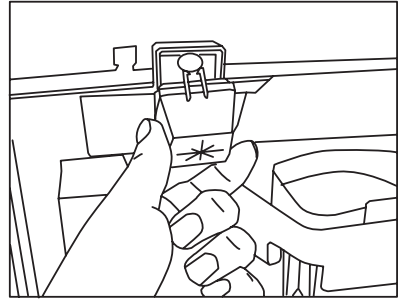

fig. 7

Proper Storage

Stocking Recommendations.

The wine racks allow for the proper horizontal storage of wine. The bottles are properly positioned so that the wine remains in contact with the cork to assure that the cork does not become dry. White and sparkling wines should be maintained on the bottom to middle racks and red wine on the top racks.

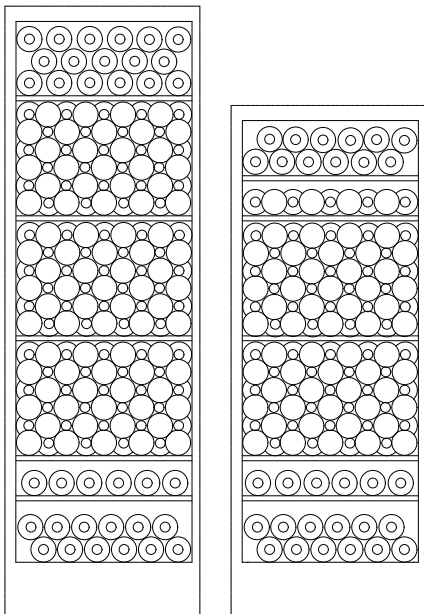

fig. 8

Shelf load

The wooden shelf can be loaded with 85 kg. If the wooden shelf loaded with 85 kg, a deflection of up to 5 mm is expected.

Max. 85 kg.

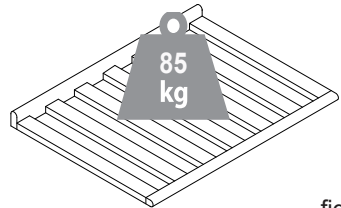

fig. 9

Shelf Removal

Open the door completely and pull out the shelf to the end. Lift up on the front of the shelf, pull slightly forward and lift up to remove the shelf from the wine cooler.

Operation and function

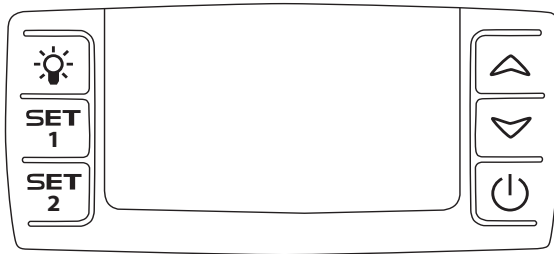

fig. 10

Electronic control

The electronic control ensures that the temperatures set at the top and at the bottom of the appliance are maintained. This is achieved by means of an advanced control of the refrigeration system, the heating element, and the fan. The set temperature will be stored in the event of power failure.

The electronic control has the following functions:

- On/off switch
- Light switch*
- Temperature setting
- Temperature indication
- Alarm for too high and too low temperatures
- Door alarm

* The light may either be turned on constantly or only when the door is open.

Temperature indication

The display shows the actual temperature. The upper digits of the display indicate the temperature at the top of the appliance, and the lower digits of the display indicate the temperature at the bottom of the appliance.

The temperature indicator is equipped with a built-in filter which simulates the actual temperature in the bottles. Consequently, the indicator does not react on short-term fluctuations of the air temperature

Temperature setting

The thermostat is equipped with a child lock device. This device is activated by pushing the “up and down” buttons simultaneously. After approx. 3 seconds “Pof” flashes in the display. Then the actual temperatures are shown as usual. In addition, the set temperatures can be shown by pushing SET1 and SET2, respectively.

The child lock device is cancelled by pushing the “up and down” buttons simultaneously. After approx. 3 seconds “Pon” flashes in the display, and the temperature can be set.

Temperature setting at the top of the appliance

Push SET1. Then the temperature at the top of the appliance can be adjusted up and down by means of the “up and down” buttons. The temperature can be adjusted from 8 to 22°C, however so that the temperature cannot be set at a lower temperature than the actual set point for the bottom temperature sensor.

Temperature setting at the bottom of the appliance

Push SET2. Then the temperature at the bottom of the appliance can be adjusted up and down by means of the “up and down” buttons. The temperature can be adjusted from 5 to 22°C, however so that the temperature cannot be set at a higher temperature than the actual set point for the upper temperature sensor.

Alarm devices

There is a sub-alarm for the low-temperature sensor and an excess-alarm for the high-temperature sensor.

The alarm consists of a beeper and a warning on the display. (🔔)

Alarm for high temperature: beep sound + alternating display of “**HtA**” and actual temperature

Alarm for low temperature: beep sound + alternating display of “**LtA**” and actual temperature



The alarm temperature depends on the set points.

The beep sound can be cancelled by pushing a random thermostat button. Push the on/off button to erase the display alarm, first for cancelling the alarm, then again for restarting the compressor.

Door alarm

When the door has been open for more than 2 minutes the door alarm is activated.

Permanent lighting

For presentation purposes of your wine, you can turn the lights permanently. Please press the light switch image  twice. To switch off the lights press on  again.

The light will always be on when the door is open.

Two-zone setting for serving temperature

Typical serving temperature settings for the top and bottom sections are 16°C and 6°C respectively. With these settings, a suitable temperature gradient will be achieved in the cabinet for the storage of various types of wine distributed from top to bottom as follows:

- heavy red wines +16 to +19°C
- rosé and light red wines +12 to +16°C
- white wines +10 to +12°C
- champagne and sparkling wines +6 to +8°C

It is recommended that wine be served at a temperature which is a couple of degrees lower than the desired drinking temperature as the wine will be warmed slightly when it is poured into the glass.

Single-zone setting for long-term storage

For long-term wine storage, the top and bottom sections should both be set at 12°C. With identical settings for the top and bottom sections, the controls will maintain an even temperature throughout the cabinet. However, the temperature in the room will gradually affect the temperature in the cabinet through its door and sides, creating a slight temperature gradient from top to bottom. The controls will maintain the set temperature at the bottom of the cabinet, and any deviation from the setting will therefore occur at the top. The difference will vary from 0 to 3°C, depending on the ambient temperature.

Defrosting, cleaning and maintenance

Automatic defrosting

The wine cooler is defrosted automatically. Defrost water runs through a pipe and is collected in a tray above the compressor where the heat generated by the compressor causes it to evaporate. The defrost water tray should be cleaned at intervals.

Cleaning

Before cleaning the appliance, unplug it from the main supply. The cabinet is best cleaned using warm water (max. 65°C) with a little mild detergent. Never use cleaning agents that scour. Use a soft cloth. Rinse with clean water and dry thoroughly. The defrost water channel, in which condensation from the evaporator runs, is located at the bottom of the rear inside wall of the cabinet and must be kept clean. Add a few drops of disinfectant, e.g. Rodalon, to the defrost water drain a couple of times a year, and clean the drain using a pipe cleaner or similar. Never use sharp or pointed implements.

The sealing strip around the door must be cleaned regularly to prevent discolouration and prolong service life. Use clean water. After cleaning the sealing strip, check that it continues to provide a tight seal.

Dust collecting on the condenser on the rear of the cabinet, the compressor and in the compressor compartment is best removed using a vacuum cleaner.

Reversible door

The door can be changed from right-hinged to left-hinged and vice versa as follows:

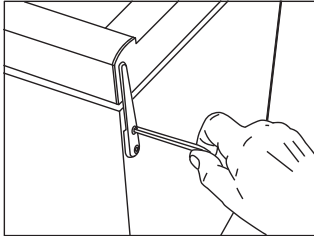

1. Lay the appliance on its back and loosen the upper hinge.

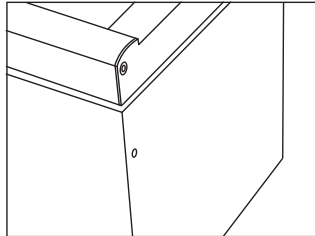

2. Remove the upper hinge.

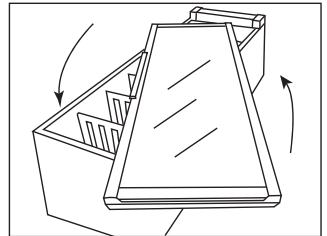

3. Rotate the glass door 180° (On the smaller cabinets (1500mm) desmount the handle. The screws are on the inside of the sealing strip. Move the handle 400mm up and mount it again so it is in the same height as before.)

4. You will need to remove the magnet on the underside of the door by unscrewing the two screws, pulling the magnet away from the door. Also with a small Philips head screwdriver remove the Vintec logo badge and swap the magnet where the badge was and vice versa.

5. Remove the top and bottom bushes on the door frame (the bushes are the black, round plastic pieces which fit into the top and bottom hinges) and swap them så that the bush which was on top is now on bottom and vice versa.

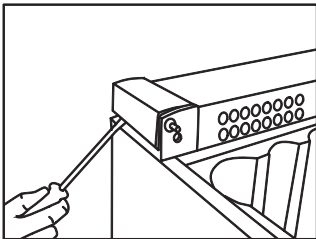

6. Carefully remove the covers on the side of the plinth using a flat-headed screwdriver.

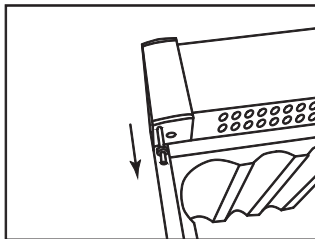

7. Pull up the hinge pin...
...and fit it on the opposite side.

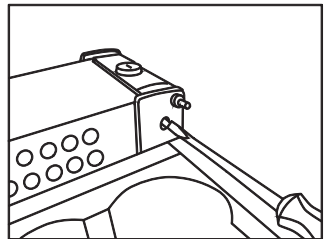

8. Unscrew the lock pin using a flat-headed screwdriver.

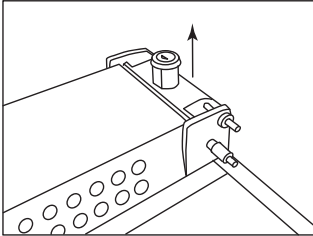

9. When the lock pin has been loosened completely, pull it up together with the lock cylinder and refit on opposite side.

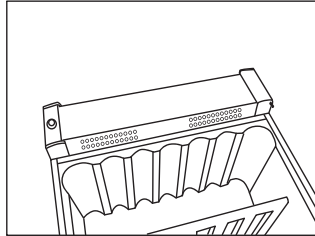

10. Click the covers into place on the plinth sides on the opposite side.

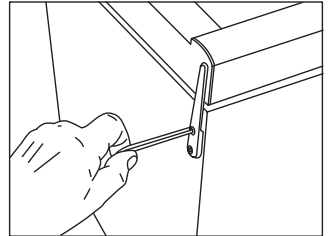

11. Fit the door onto the bottom pin, fit the top hinge and tighten securely.

12. After reversing the door, it is important to check that the sealing strip provides a tight seal all the way round. If it does not, carefully heat the strip all the way round using a hair dryer. Then ease the strip outwards slightly so that it forms a tight seal against the cabinet. Be careful not to heat the strip so much that it melts!

Fault finding

Fault	Possible cause	Remedy
The appliance is not working.	<p>The appliance is switched off.</p> <p>Power failure; the fuse is blown; the appliance is not plugged in correctly.</p>	<p>Press the on/off switch.</p> <p>Check that power is connected. Reset the fuse.</p>
Water collects in the bottom of the cabinet.	The defrost water pipe is blocked.	Clean the defrost water channel and the drain hole on the rear wall of the cabinet.
Vibration or bothersome noise.	<p>The appliance is not level. The appliance is resting against other kitchen elements.</p> <p>Containers or bottles inside the cabinet are rattling against one another.</p>	<p>Level the appliance using a spirit level.</p> <p>Move the appliance away from the kitchen elements or appliances it is in contact with. Move containers and/or bottles apart.</p>
Compressor runs continuously.	High room temperature.	Ensure adequate ventilation.
P1 is shown on the display.	The upper sensor is disconnected or short-circuited.	Call for service. The temperature within the entire cabinet is maintained at the higher of the two setpoints until the fault has been corrected.
P2 is shown on the display.	The lower sensor is disconnected or short-circuited.	Call for service. The temperature within the entire cabinet is maintained at the higher of the two setpoints until the fault has been corrected.

Warranty, spare parts and service

Warranty disclaimer

Faults and damage caused directly or indirectly by incorrect operation, misuse, insufficient maintenance, incorrect building, installation or mains connection. Fire, accident, lightning, voltage variation or other electrical interference, including defective fuses or faults in mains installations.

Repairs performed by others than approved service centres and any other faults and damage that the manufacturer can substantiate are caused by reasons other than manufacturing or material faults are not covered by the warranty.

Please note that changes to the construction of the appliance or changes to the component equipment of the appliance will invalidate warranty and product liability, and the appliance cannot be used lawfully. The approval stated on rating plate will also be invalidated.

Transport damage discovered by the buyer is primarily a matter to be settled between the buyer and the distributor, i.e. the distributor must ensure that such complaints are resolved to the buyer's satisfaction.

Before calling for technical assistance, please check whether you are able to rectify the fault yourself. If your request for assistance is unwarranted, e.g. if the appliance has failed as a result of a blown fuse or incorrect operation, you will be charged the costs incurred by your call for technical assistance.

Spare parts

When ordering spare parts, please state the type, serial and product numbers of your appliance. This information is given on the rating plate. The rating plate contains various technical information, including type and serial numbers.

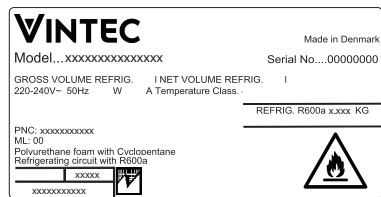

fig. 11

Disposal

Information for Users on Collection and Disposal of Old Equipment and used Batteries



These symbols on the products, packaging, and/or accompanying documents mean that used electrical and electronic products and batteries should not be mixed with general household waste. For proper treatment, recovery and recycling of old products and used batteries, please take them to applicable collection points, in accordance with your national legislation and the Directives 2012/19/EU and 2006/66/EC.

By disposing of these products and batteries correctly, you will help to save valuable resources and prevent any potential negative effects on human health and the environment which could otherwise arise from inappropriate waste handling.

For more information about collection and recycling of old products and batteries, please contact your local municipality, your waste disposal service or the point of sale where you purchased the items.

Penalties may be applicable for incorrect disposal of this waste, in accordance with national legislation.



For business users in the European Union.

If you wish to discard electrical and electronic equipment, please contact your dealer or supplier for further information.

Information on Disposal in other Countries outside the European Union

These symbols are only valid in the European Union. If you wish to discard this product, please contact your local authorities or dealer and ask for the correct method of disposal.

Note for the battery symbol:



This symbol might be used in combination with a chemical symbol. In this case it complies with the requirement set by the Directive for the chemical involved.

RoHS
Compliant

Conformed to the stipulation on permissible content limitation of some hazardous & restricted chemical substances.

(RoHS compliant)

(According to the circular No. 30/2011/TT-BCT, Vietnam, dated 10th August, 2011)

Safety instructions

(See also Warning page 2).

1. There is a name plate inside the cabinet. The name plate provides various technical information and a safety notice with a yellow flame triangle label, name and chemical symbol of the refrigerant.

2. The refrigerator contains flammable refrigerant (R600a: iso-butane). Requirements to ensure gas safety and safe use of refrigerators:

- The refrigeration system behind and inside the refrigerator contains refrigerant. Do not allow any sharp objects to come into contact with the refrigeration system.
- Do not use other electric appliances inside the refrigerator.
- Children should be supervised to ensure that the refrigerator should be used properly.
- Do not use the mechanical devices or other means to accelerate the defrosting process, unless they are of the type recommended by the manufacturer.
- Do not block the openings on the circumstances of the refrigerator.
- In case of having damaged the refrigerant circuit, do not use electric items or fire equipments nearby, and open all windows to provide good ventilation. Please also contact your local maintenance agent to follow up.
- The warning labels mentioned above should be kept throughout the life of the refrigerator. The user manual should be

handed over to any person who would use or handle the refrigerator whenever the refrigerator would be transferred to another location and delivered to a recycling plant.





Service and support

In the rare event that your Vintec cabinet does not perform to your satisfaction, contact our dedicated support team:

Vintec. We are part of the Electrolux Family. To add a touch of professional inspiration to your home, visit electrolux.com

Stay in touch and share your user experience by following us:

