

# Rubine™

I T A L I A

REDEFINE THE WAY OF LIFE

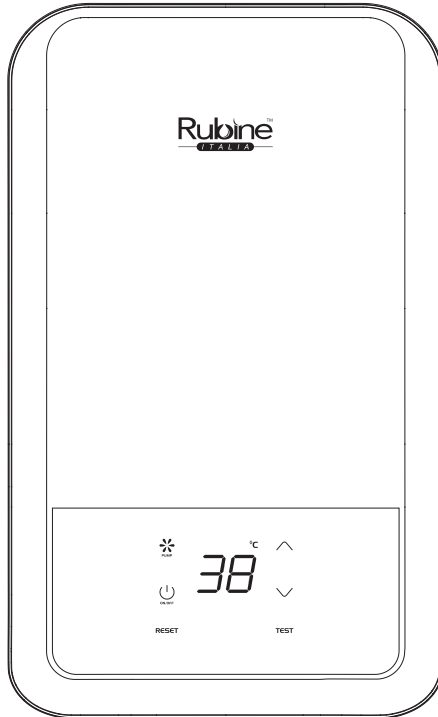

**WATER HEATER / PEMANAS AIR**

**USER MANUAL / PANDUAN PENGGUNA**

MODEL / MODEL

IA DIGITAL SERIES (IAD-931D / IAD-930N)

Please read this manual thoroughly and understand the content before use.  
*Sila baca panduan ini dengan teliti dan memahaminya sebelum penggunaan.*



## **SAFETY PRECAUTION** **LANGKAH-LANGKAH KESELAMATAN**

1. Do not install reverse INLET & OUTLET and Stop Valve of heater.  
*Jangan memasang "INLET & OUTLET" dan Injap Hentian pemanas dalam keadaan Songsang.*
2. Do not install the heater where there is consistent spray directly over the unit.  
*Jangan memasang pemanas air dimana terdapat semburan konsisten terus ke atas unit.*
3. Do not connect the OUTLET to any tap or fitting that is not recommended by the manufacturer.  
*Jangan sambungkan "OUTLET" pada mana-mana paip atau pemasangan yang tidak disyorkan oleh pengeluar.*
4. Do not block the heater OUTLET in any way.  
*Jangan menghalang "OUTLET" pemanas dalam apa jua cara.*
5. Do not attempt to repair the heater without qualified technician.  
*Jangan cuba untuk membaiki pemanas tanpa juruteknik yang berkeelayakan.*
6. This appliance is not intended for use by person (including children) with reduced physical, sensory or mental capabilities, or lack of experience and knowledge, unless they have been supervised or given instruction concerning use of the appliance by a person responsible for their safety.  
*Perkakas ini tidak digalakkan untuk digunakan oleh orang (termasuk kanak-kanak) kurang upaya dari segi fizikal, deria atau mental, atau kurang berpengalaman atau pengetahuan, kecuali mereka diawasi atau diberi arahan mengenai penggunaan perkakas ini oleh orang yang bertanggungjawab keatas keselamatan mereka.*
7. Children should be supervised to ensure that they do not play with the appliance.  
*Kanak-kanak hendaklah diselia untuk memastikan mereka tidak bermain dengan perkakas ini.*
8. Engage qualified electrician for installation.  
*Gunakan juruelektrik yang berkeelayakan untuk pemasangan.*
9. Test water temperature with hand before using the shower.  
*Uji suhu air dengan menggunakan tangan sebelum menggunakan pemanas air.*
10. Check the ELCB once a month (please refer to the Test Run of Heater) and consult professional for repair if there is any malfunction.  
*Pastikan ELCB diperiksa setiap bulan (sila rujuk Pengujian Pemanas) dan hubungi juruteknik untuk sebarang pembaikan.*
11. Metallic / chrome flexible hose and conductive control valve shall not be used.  
*Saluran getah logam / krom dan injap kawalan konduktif tidak boleh digunakan.*

12. Use only new hoses to connect the appliance to the water supply. The old hose-sets should not be reused.  
*Gunakan hos yang baru untuk menyambungkan perkakas kepada bekalan air. Hos yang lama tidak boleh digunakan semula.*
13. This appliance is not to be used for portable water supply.  
*Alat ini tidak boleh digunakan untuk bekalan air mudah alih.*
14. Do not leave the hand shower idle in the pail. (refer below)  
*Jangan meninggalkan alat pancuran terbiar di dalam baldi. (rujuk dibawah)*

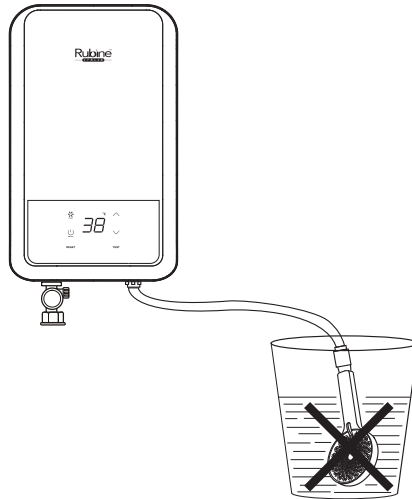

## 1. WATER HEATER PARTS IDENTIFICATION PENGENALAN BAHAGIAN – BAHAGIAN PEMANAS AIR

### EXTERNAL PARTS IDENTIFICATION PENGENALAN BAHAGIAN LUAR

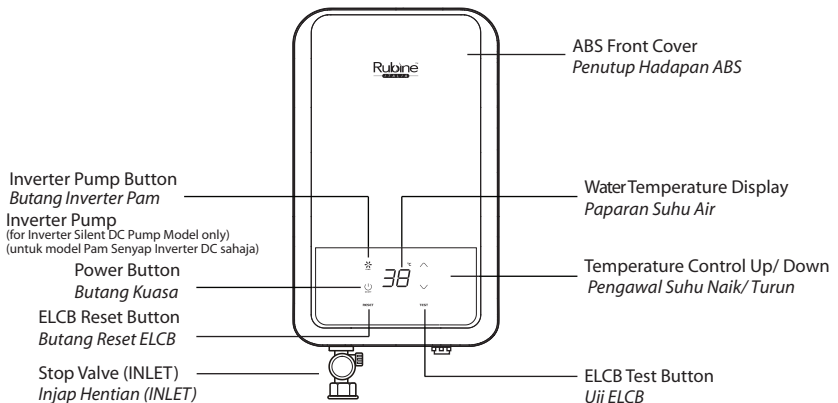

## INTERNAL PARTS IDENTIFICATION PENGENALAN BAGHIAN DALAM

Electrical cable (Recommended conductor size: 4.0mm<sup>2</sup> not included)

Kabel elektrik (saiz konduktor yang disyorkan 4.0mm<sup>2</sup> tidak termasuk)

Terminal Block  
Blok Terminal

Cable Entry  
Kemasukan Kabel

Inverter Pump  
(for Inverter Silent DC Pump Model only)  
Pam Inverter  
(untuk model Pam Senyap Inverter DC sahaja)

Flow Sensor Assembly  
Pemasangan Sensor Aliran

Water INLET Connection  
Penyambungan Air "INLET"

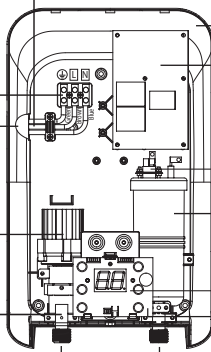

ABS Heater Base  
Tapak Pemanas ABS

ELCB Control Board  
Papan Kawalan ELCB

Thermal Cut Out  
Pemotongan Haba

Heater Tank  
Tangki Pemanas

Triac  
Triac

Digital Touch Sensor PCB  
(Power, Pump, heater, Test & Reset)

PCB "Sensor Sentuh Digital"  
(Kuasa, Pam, Suhu, Uji dan Tetapkan Semula)

Water OUTLET Connection  
Penyambungan Air "OUTLET"

## SHOWER SET ACCESSORIES IDENTIFICATION PENGENALAN AKSESORI PANCURAN

### 1. BLACK ACCESSORIES AKSESORI HITAM

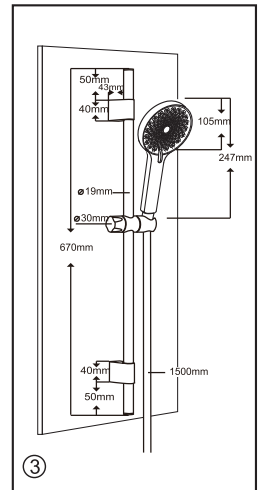
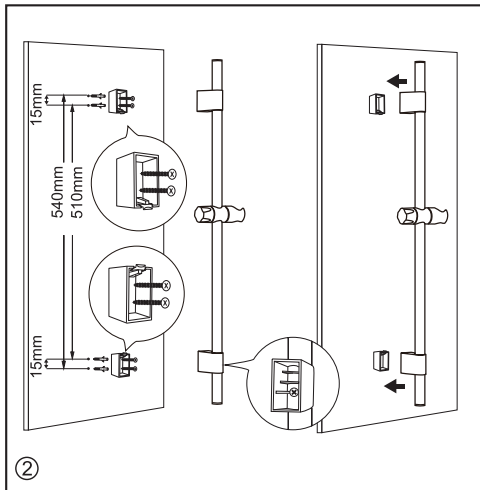
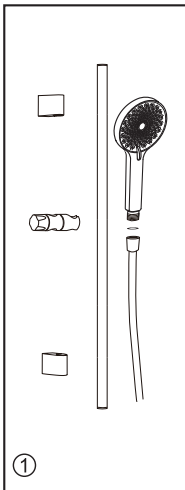

**2. RAIN SHOWER SET - TRI-FLOW DIVERTER** (Optional Features)  
**SET PANCURAN MANDIAN HUJAN** (Ciri-ciri pilihan)

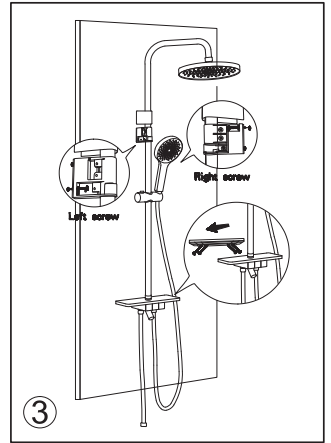
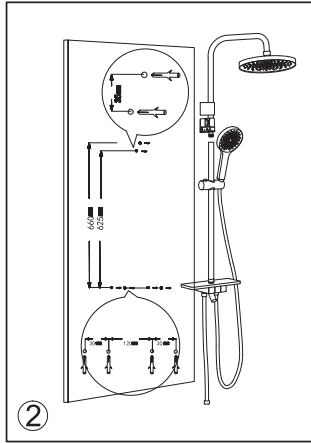
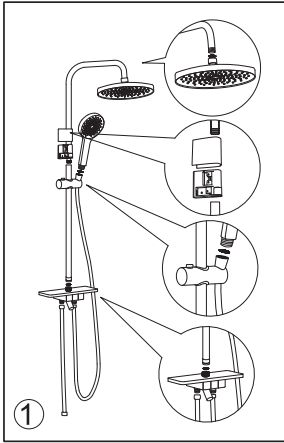

**DIMENSION DIAGRAM**

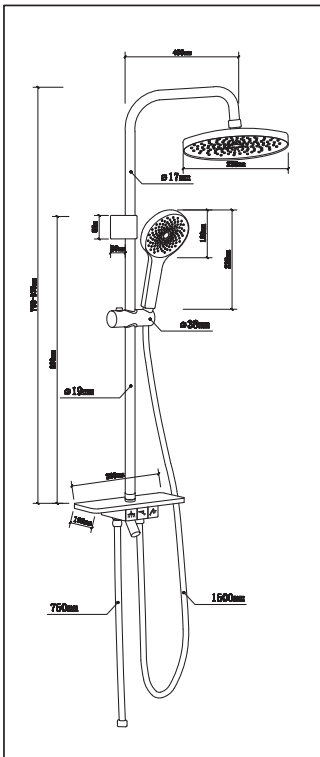

**INSTALLATION DIAGRAM**

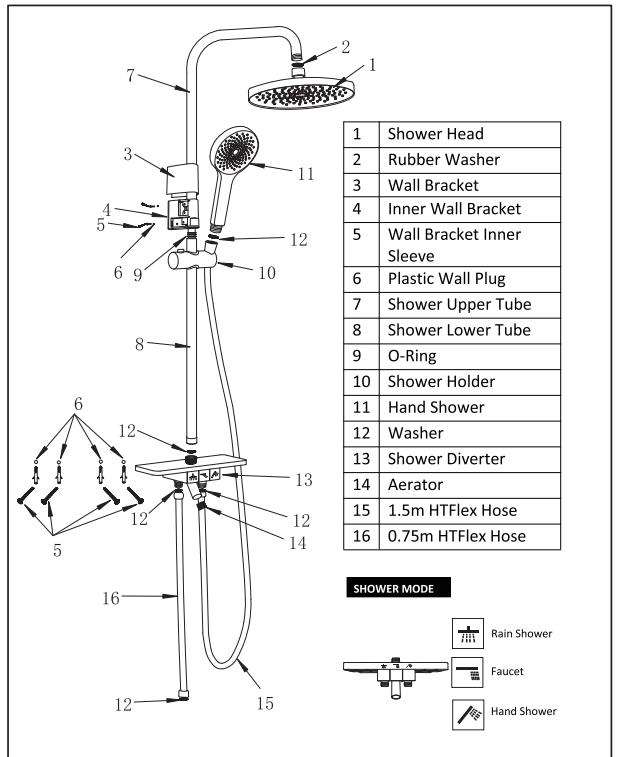

## 2. GENERAL INFORMATION MAKLUMAT UMUM

### INSTALLATION PEMASANGAN



**CAUTION:**  
**AWAS:**  
**THIS APPLIANCE MUST BE EARTHED**  
**PERKAKAS INI MESTI DIBUMIKAN**

1. All the plumbing work should be completed before proceeding to electrical wiring connection. (Table 1)  
*Semua pemasangan paip perlu diselesaikan sebelum memulakan kerja-kerja penyambungan wayar elektrik. (Jadual 1)*
2. Installation must be carried out by qualified electrician with close reference to this manual and in compliance with the local regulations.  
*Pemasangan mestilah dilakukan oleh juruteknik yang berkelayakan dengan merujuk kepada panduan ini dan mengikut akta-akta tempatan.*
3. The unit works at minimum water flow rate of 2 litre/min, which then would trigger the built-in pump (only for pump model), boosting a stronger shower spray.  
*Unit ini berfungsi pada kadar aliran air minima 2 liter/min, yang mengaktifkan pam dan kemudiannya meningkat pancuran semburan.*
4. The built-in electronic Earth Leakage Circuit Breaker (ELCB) would cut-off the power supply to heater in the event of current leakage of as low as 15mA.  
*"Earth Leakage Circuit Breaker (ELCB)" akan memutuskan bekalan kuasa sekiranya berlaku kebocoran arus serendah 15mA.*
5. The Thermal Cut-Off would automatically shut off the power supply shall there is any abnormal rise of showering temperature.  
*Pemotongan haba akan berfungsi secara automatik dengan memutuskan bekalan kuasa jika terdapat kenaikan suhu yang tidak normal.*
6. The unit only operates when there is sufficient water flow to trigger the flow switch.  
*Unit hanya akan beroperasi apabila terdapat aliran air yang cukup untuk mengaktifkan suis aliran.*

7. Electrical loading Table 1:  
*Pendawaian elektrik Jadual 1:*

Voltage (Vac)	Power (kW)	Amperes (A)	Recommended Conductor Size (csa)			Fuse/ MCB(A)	ON/OFF Switch (A)
			mm <sup>2</sup>	Conduit Cable	Flexible Cable		
220 - 50/60Hz	3.5	16.0	2.5	7/0.67mm	50/0.25	20	20
	4.5	20.5	2.5	7/0.67mm	56/0.30	25	25
	5.5	25.0	4.0	7/0.85mm	56/0.30	32	32
	6.0	27.3	4.0	7/0.85mm	56/0.30	32	32
	6.5	29.6	4.0	7/0.85mm	84/0.30	32	32
	7.5	34.1	6.0	7/1.04mm	84/0.30	40	40
	8.0	36.4	6.0	7/1.04mm	84/0.30	40	40
230 - 50/60Hz	3.5	15.2	2.5	7/0.67mm	50/0.25	20	20
	5.5	24.0	4.0	7/0.85mm	56/0.30	32	32
	6.6	28.7	4.0	7/0.85mm	56/0.30	32	32
	8.8	38.3	6.0	7/1.04mm	84/0.30	40	40
240 - 50/60Hz	3.6	15.0	4.0	7/0.85mm	56/0.30	32	32
	3.8	15.8	4.0	7/0.85mm	56/0.30	32	32
	4.25	17.7	4.0	7/0.85mm	56/0.30	32	32
	7.7	32.1	6.0	7/1.04mm	84/0.30	40	40
	9.0	37.5	6.0	7/1.04mm	84/0.30	40	40

8. Instantaneous water heater shall be equipped with a 2-pole control switch and own residual current device.  
*Pemanas air segera hendaklah dilengkapi dengan kawalan suis 2-kutub dan memiliki peranti arus berbaki.*
9. Water heaters exceeding 3kW shall be permanently connected to a 20A/30A rated circuit breaker/fuse with an isolator switch and residual current device.  
*Pemanas air yang melebihi 3kW hendaklah disambung secara tetap pada 20A/30A nilai arus pemutus litar/fius dengan suis pengasing dan peranti arus berbaki.*

### 3. INSTALLATION PROCEDURES **TATACARA PEMASANGAN**

1. INLET and OUTLET connection of the heater unit should not be reversed, with stop valve installed on INLET. (Diagram 1)  
*Sambungan unit pemanas "INLET" dan "OUTLET" tidak boleh songsang dan injap hentian mestilah dipasang pada "INLET".*
2. It is recommended that the unit should be mounted 1.5m above the floor to bottom of the heater. (Diagram 1)  
*Pemasangan unit digalakkan mempunyai jarak 1.5m antara lantai dengan bahagian bawah pemanas. (Rajah 1)*

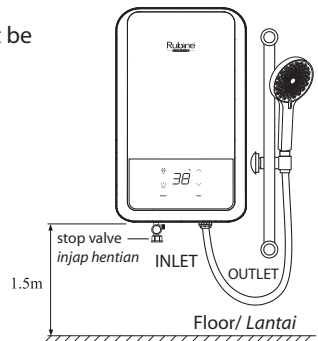

Diagram 1  
Rajah 1

### 3. Mounting position

#### Penetapan tapak pemanas

- Remove screw at the bottom of the heater  
*Keluarkan skru dari bawah pemanas*
- Lift the plastic cover upward (Refer Diagram 2)  
*Buka penutup plastik pemanas dari bahagian bawah. (Rujuk Rajah 2)*
- Mark mounting position on the wall for all 4 screws  
*Tandakan posisi semua 4 skru pada dinding*
- Drill the holes with 5.0mm diameter drill bit (Refer Diagram 3)  
*Gerudi lubang dengan menggunakan bit gerudi berdiameter 5.0mm (Rujuk Rajah 3)*
- Install the unit to the wall with plug  
*Pasang unit pada dinding bersama plug*

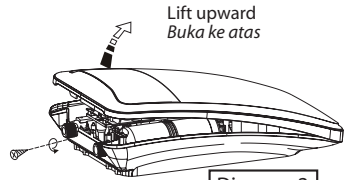

Diagram 2  
Rajah 2

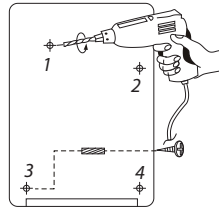

Diagram 3  
Rajah 3

#### WARNING !

To prevent vibration, all 4 screw must be tightened fully.  
*Untuk mengelakkan getaran, semua 4 skru hendaklah diketatkan sepenuhnya.*

### 4. Installation of Heater INLET and OUTLET connection. (Diagram 4)

#### Pemasangan "INLET" dan "OUTLET" pemanas. (Rajah 4)

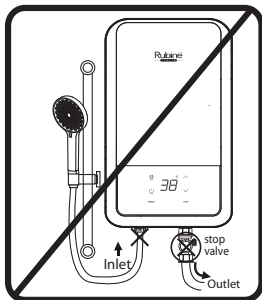
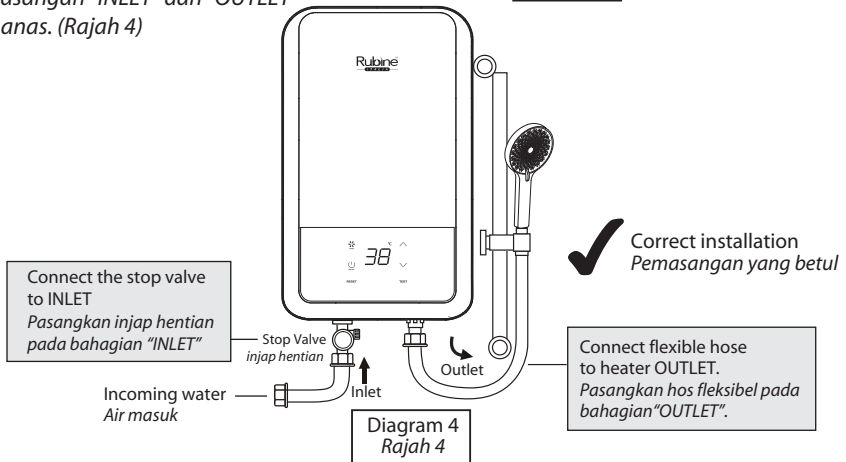

**X** inlet - outlet reverse  
*(wrong installation)*  
inlet - outlet songsang  
*(pemasangan yang salah)*

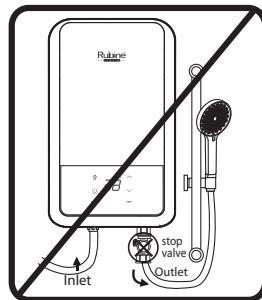

**X** stop valve reverse  
*(wrong installation)*  
inlet - outlet songsang  
*(pemasangan yang salah)*

#### WARNING !

Wrong installation will caused damage to heating element.  
*Pemasangan yang salah boleh mengakibatkan kerosakan pada elemen pemanas.*



5. Electrical Connection  
*Penyambungan elektrik*

**IMPORTANT NOTE !**  
**NOTA PENTING !**

SWITCH OFF THE MAIN SUPPLY BEFORE ELECTRICAL WORK  
*PADAMKAN SUIS UTAMA SEBELUM MELAKUKAN KERJA-KERJA  
PENDAWAIAN ELEKTRIK*

- a) Insert electrical cable through the rubber grommet as (Diagram 5).  
*Masukkan kabel elektrik melalui grommet getah seperti yang ditunjukkan pada (Rajah 5).*
- b) Connect the cable to the terminal block and fully tighten as below :  
*Sambungkan kabel ke blok terminal dan ketatkan sepenuhnya seperti berikut:*

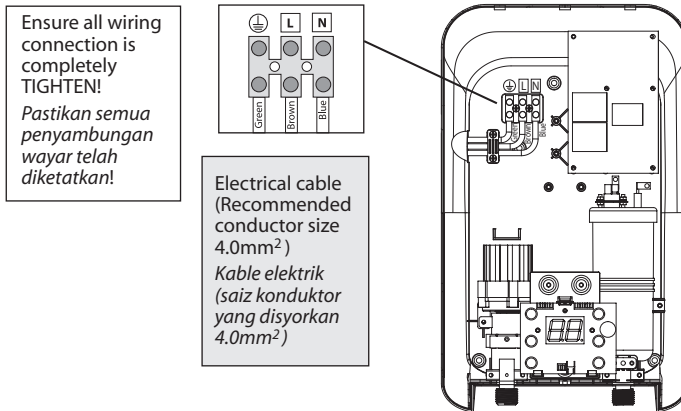

- c) Restore the cover. (Diagram 6)  
*Pasangkan penutup pemanas. (Rajah 6)*

To install cover:  
*Pemasangan penutup:*

- 1) Place bottom part into position & fit in nicely.  
*Posisikan penutup & ketatkan bahagian bawah dahulu.*
- 2) Press firmly the top part until "click" to secure the cover.  
*Tekan bahagian atas penutup sehingga bunyi "klik".*
- 3) Install screw at bottom to lock in position.  
*Selepas penutup dipasang dengan ketat, pasang skru di bahagian bawah.*

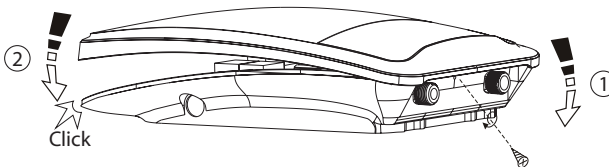

## 4. OPERATION PROCEDURES / TEST RUN OF HEATER TATACARA OPERASI / PENGUJIAN PEMANAS

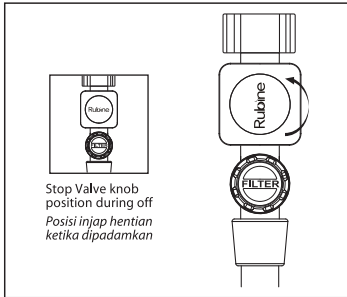

- 1 Turn on stop valve (anti - clockwise).  
*Hidupkan injap hentian (arah lawan jam).*

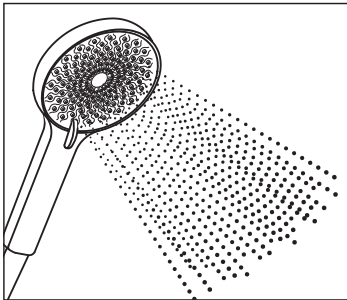

- 2 Make sure water flow starts after stop valve had been turned on.  
*Pastikan pancuran air bermula selepas injap hentian dihidupkan.*

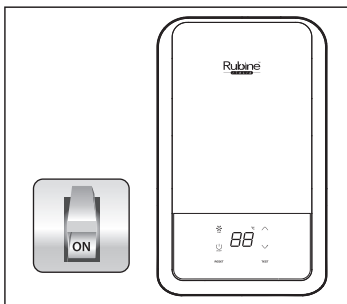

- 3 Switch on the main power supply, the Screen panel "88" would light up. Refer to Table 2 "AUTO INSPECT ALARM INDICATION" for more detail.  
*Hidupkan bekalan kuasa utama, "88" panel skrin akan menyala. Sila rujuk kepada jadual 2 "AUTO INSPECT ALARM INDICATION" untuk maklumat lanjut.*

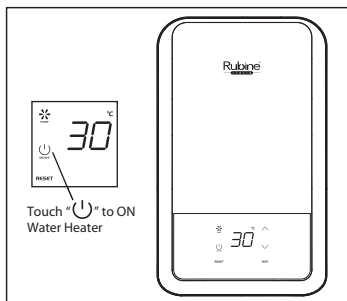

- 4 Touch "U" to ON the POWER and would showing Water Temperature.  
*Sentuh "U" pada kuasa dan menunjukkan suhu air.*

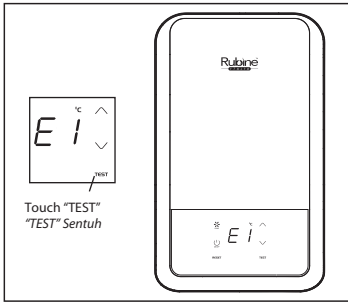

- 5 To initiate the ELCB test, touch the "TEST" icon. The unit should trip, and the "E 1" starts blinking. *Lakukan Ujian ELCB dengan menyentuhkan ikon "TEST". Beklan Kuasa akan di putuskan "E 1" akan mula berkelip-kelip.*

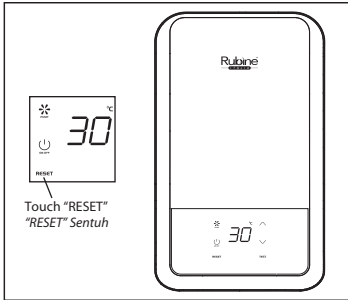

- 6 Touch Icon "RESET" to resume power connection. *Sentuh Ikon "RESET" untuk penyambungan kuasa semula.*

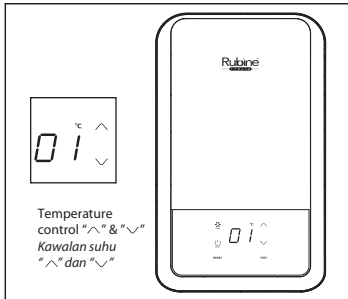

- 7 The heater is now ready for use. Temperature will be increased accordingly by touching the icon " $\wedge$ ", and " $\vee$ " to decrease it. The heater is deactivated at 00, with 01 representing the minimum temperature and 08 indicating the maximum temperature. *Pemanas kini sedia digunakan. Suhu air akan dinaikkan dengan menyentuh ikon " $\wedge$ ", dan " $\vee$ " untuk menurunkannya. Pemanas air dinyahaktifkan pada 00, 01 mewakili suhu minimum dan 08 adalah suhu maksimum.*

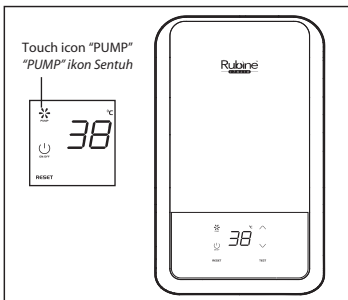



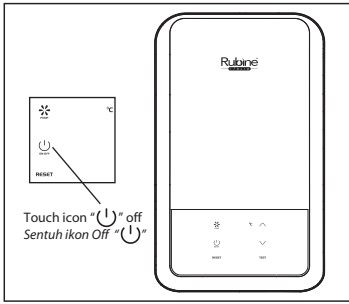









- 8 Touch icon "PUMP" for boosting a stronger shower spray. Pump On would sound bi bi and Pump off would sound bi. (only for DC pump model) *Sentuh ikon "PUMP" untuk meningkat pancuran semburan. Pam On akan berbunyi bi bi dan pam off akan berbunyi bi. (Untuk model pam DC sahaja)*



- 9 Switch off the heater and main power supply when not in use.  
*Padamkan suis pemanas dan bekalan kuasa apabila tidak menggunakannya.*

Table 2  
Jadual 2

## AUTO INSEPT ALARM INDICATION PETUNJUK PENGGERA "AUTO INSPECT"

<p><b>ALARM 1</b></p> <div style="background-color: black; color: white; padding: 5px; text-align: center;">  <p><b>GOOD AND SAFE</b> SELAMAT DIGUNA</p> </div> <p>LIGHT  1st STEP BEEP</p> <div style="display: flex; align-items: center;">  <div style="margin-left: 10px;">  <p>Safe to use without beep continuous <i>Selamat digunakan tanpa bunyi berterusan</i></p> </div> </div>	<p><b>ALARM 2</b></p> <div style="background-color: black; color: white; padding: 5px; text-align: center;">  <p><b>TRIPPED ELCB</b> ELCB BERMASALAH</p> </div> <p>LIGHT  2nd STEP BEEP</p> <div style="display: flex; align-items: center;">  <div style="margin-left: 10px;">  <p>Continuous beeping (provided with water flow &amp; power on) <i>Bunyi berterusan (dengan aliran air &amp; aliran kuasa dipasang)</i></p> <p>Heater auto cut-off <i>Unit pemanas tidak berfungsi</i></p> </div> </div> <div style="border: 1px solid black; padding: 5px; margin-top: 10px;"> <p><b>WARNING!</b> Could be water tank leakage or internal parts malfunction! Contact professional technician immediately. <i>Tangki air berkemungkinan bocor atau komponen bermasalah! Hubungi juruteknik segera.</i></p> </div>	<p><b>ALARM 3</b></p> <div style="background-color: black; color: white; padding: 5px; text-align: center;">  <p><b>EARTH WIRE ERROR</b> WAYAR BUMI BERMASALAH</p> </div> <p>LIGHT  3rd STEP BEEP</p> <div style="display: flex; align-items: center;">  <div style="margin-left: 10px;">  <p>Continuous beeping <i>Bunyi berterusan</i></p> <p>Heater functions well but alarm beeping continuous <i>Unit pemanas berfungsi tetapi penggera berbunyi berterusan</i></p> </div> </div> <div style="border: 1px solid black; padding: 5px; margin-top: 10px;"> <p><b>WARNING!</b> Could be Earth wire connection error! Contact professional technician immediately. <i>Wayar Bumi mungkin bermasalah! Hubungi juruteknik segera.</i></p> </div>
--	--	---

## 5. GENERAL MAINTENANCE

### PENYELENGGARAN AM

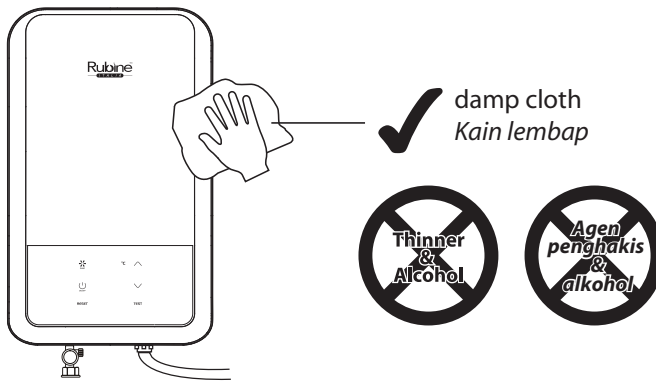

#### CLEAN FILTER REGULARLY (DIAGRAM 7 & 8)

*BERSIHKAN PENAPIS SECARA TERAP (RAJAH 7 & 8)*

- a) Remove the filter mesh from the stop valve (for filter type only) by turning the knob filter anticlockwise and pulling out the knob (Diagram 7). Flush it with water to remove any trapped sediments. Install the knob filter back to its original position.
- a) *Keluarkan penapis daripada injap henti (untuk jenis penapis sahaja) dengan memusingkan tombol penapis lawan arah jam dan menarik keluar tombol (Rajah 7). Cuci dengan air untuk mengeluarkan sebarang mendapan yang terperangkap. Pasangkan penapis tombol kembali ke pada kedudukan asalnya.*
- b) Clear the shower head's holes by using a soft brush from time to time (Diagram 8). Recommended to clean it once a week. Be careful not to damage the holes of the shower head during cleaning.
- b) *Bersihkan lubang kepala pancuran dengan berus lembut dari masa ke masa (Rajah 8). Disyorkan untuk membersihkannya sekali seminggu. Berhati-hati agar tidak merosakkan lubang kepala pancuran mandian semasa pembersihan.*

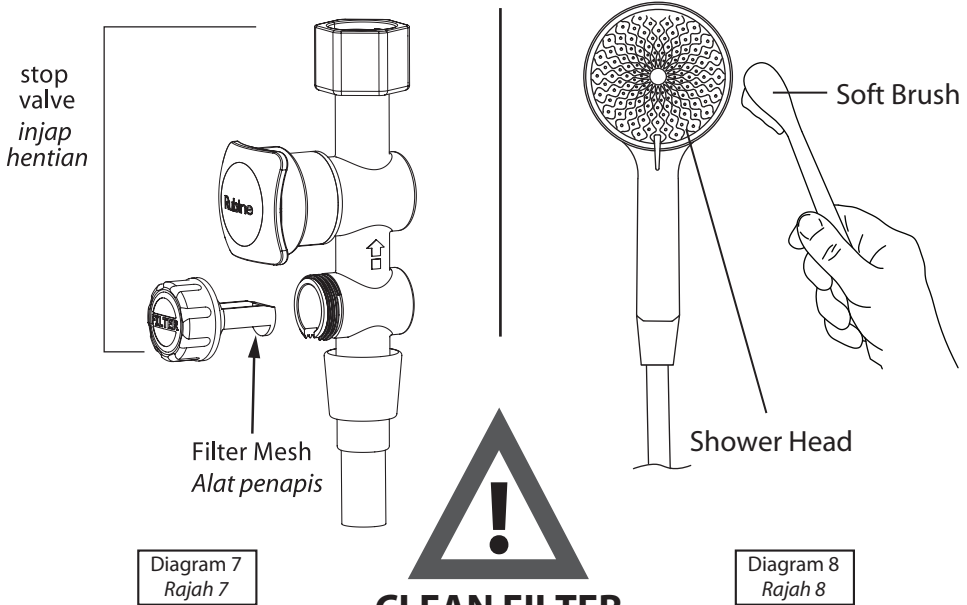

**CLEAN FILTER MESH REGULARLY  
ALAT PENAPIS MESTI KERAP DIBERSIHKAN**

**6. TECHNICAL SPECIFICATIONS  
SPESIFIKASI TEKNIKAL**

Electrical loading / Muatan elektrik	4.25kW 240V 50/60Hz
Other loading / Muatan lain	Please refer Electrical loading table Rujuk jadual pendawaian elektrik
ELCB sensitivity / Sensitiviti ELCB	15 mA
Operating condition / Keadaan berfungsi	Open system (Open outlet) / Sistem terbuka
Water connection / Sambungan air	Ø15mm (1/2" BSP)
Degree of protection / Tahap perlindungan	IP25
Min water flow rate / Kadar aliran air min	2 litre/ min
Min water pressure / Tekanan air min	20kPa ( 0.2 bar / 2.9psi )
Max water pressure / Tekanan air max	4 bar ( 400kPa / 58psi )
Heater dimension (mm) / Ukuran pemanas	377 (H) x 230 (W) x 80 (D)
Heater nett weight / Berat bersih pemanas	Non pump / Tanpa pam : 1.6kg Inverter Silent DC Pump / Pam Senyap Inverter DC : 1.6kg

# 7. SCHEMATIC WIRING DIAGRAM RAJAH PENDAWAIAN SKEMATIK

INVERTER SILENT DC PUMP (IAD-931D)  
PAM SENYAP INVERTER DC

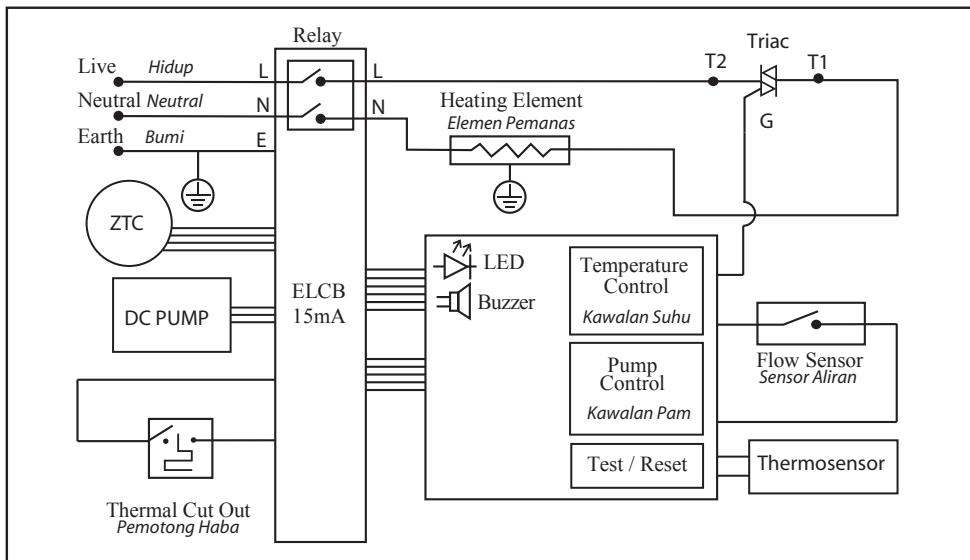

NON-PUMP (IAD-930N)  
TANPA PAM

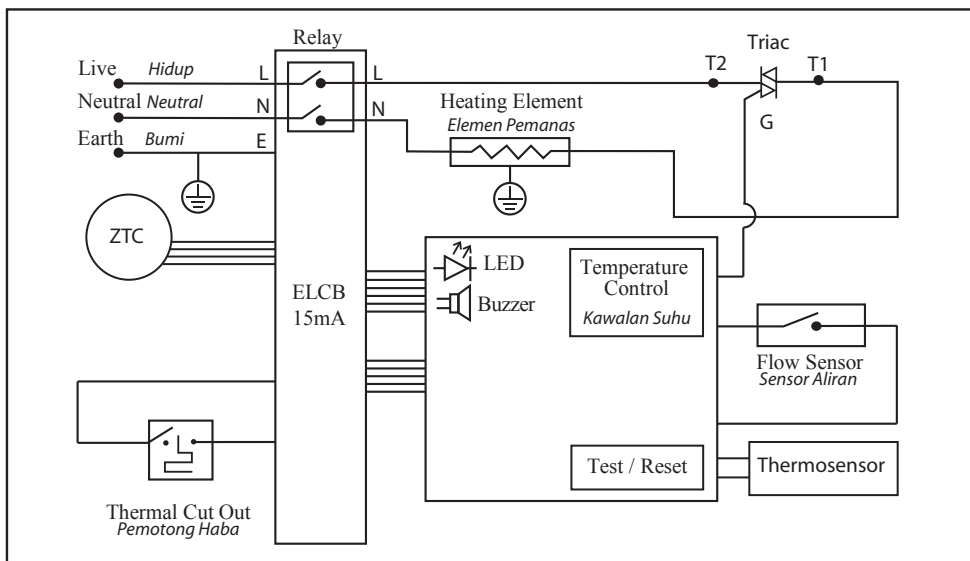

# Our Warranty



on Internal Parts  
*pada Bahagian Dalam*



on Heating Element  
*pada Unsur Pemanas*



on Inverter DC Silent Pump  
*pada pam Senyap Inverter DC*



on Anti-tank Leakage  
*pada Pencegahan Tangki Bocor*

## 6 mths Warranty Extension

### Online Registration

1. Log on to [www.rubine.com.my](http://www.rubine.com.my)
2. Click on 'Support', followed by 'Product Warranty Registration' to proceed. You're required to sign up as a member.
3. You'll receive a notification of warranty registration confirmation via email.
4. Please keep your online warranty certificate for reference / future warranty claim.

### Pendaftaran Di Laman Web

1. Layari [www.rubine.com.my](http://www.rubine.com.my)
2. Klik pada 'Support', diikuti dengan 'Product Warranty Registration'. Anda dikehendaki mendaftar sebagai ahli Rubine.
3. Anda akan menerima e-mel sijil pengesahan dengan data pendaftaran jaminan.
4. Pastikan anda simpan e-mel sijil pengesahan untuk tuntutan jaminan.

# Customer Care

### AFTER - SALES SERVICE:

Tel : **03-6279 8899**

Email : **[ftcrm@fiamma.com.my](mailto:ftcrm@fiamma.com.my)**

### OPERATION HOURS:

**09:00am – 05:00pm**

(Monday – Friday, except public holiday)

This specification is subject to change without prior notice,

FIAMMA TRADING SDN. BHD. will not be held responsible for the use of superseded or voided specification.

**[rubine.com.my](http://rubine.com.my)**



**FIAMMA TRADING SDN BHD** 330476-P (A member of Fiamma Holdings Berhad)

2-1, Wisma Fiamma, No.20, Jalan 7A/62A, Bandar Manjalara, 52200 Kuala Lumpur. Tel: 03-6279 8943