



 Read this manual carefully before operating this vehicle.

OWNER'S MANUAL

EGO

AVANTIZ

B92-F8199-30

EAU46091

 **Read this manual carefully before operating this vehicle. This manual should stay with this vehicle if it is sold.**

EAU46091

 在使用这电单车以前，请充分使用这小手册。这手册须付与电单车一起。

EAU46091

 **Baca buku panduan dengan teliti sebelum mengendalikan motosikal ini. Buku panduan diberi bersama dengan pembelian motosikal.**

Introduction

EAU10114

Welcome to the Yamaha world of motorcycling!

As the owner of the ego avantiz, you are benefiting from Yamaha's vast experience and newest technology regarding the design and manufacture of high-quality products, which have earned Yamaha a reputation for dependability.

Please take the time to read this manual thoroughly, so as to enjoy all advantages of your ego avantiz. The Owner's Manual does not only instruct you in how to operate, inspect and maintain your scooter, but also in how to safeguard yourself and others from trouble and injury.

In addition, the many tips given in this manual will help keep your scooter in the best possible condition. If you have any further questions, do not hesitate to contact your Yamaha dealer.

The Yamaha team wishes you many safe and pleasant rides. So, remember to put safety first!

Yamaha continually seeks advancements in product design and quality. Therefore, while this manual contains the most current product information available at the time of printing, there may be minor discrepancies between your scooter and this manual. If there is any question concerning this manual, please consult a Yamaha dealer.

EWA12412







Please read this manual carefully and completely before operating this scooter.

Important manual information

EAU10134

Particularly important information is distinguished in this manual by the following notations:

	This is the safety alert symbol. It is used to alert you to potential personal injury hazards. Obey all safety messages that follow this symbol to avoid possible injury or death.
	A WARNING indicates a hazardous situation which, if not avoided, could result in death or serious injury.
	A NOTICE indicates special precautions that must be taken to avoid damage to the vehicle or other property.
	A TIP provides key information to make procedures easier or clearer.

*Product and specifications are subject to change without notice.

Important manual information

**Sila dapatkan 2(Dua) kupon servis
percuma dari pengedar/ penjual
motosikal anda.**

***Get your 2 (Two) free service coupon
from your motorcycle dealers***

请向您的电单车代理商领取
2(两)张免费的维修卷

EAJN0430

**B92 -F8199-30
OWNER'S MANUAL**

**©2016 by Yamaha Motor Co. Ltd.
1st edition, March 2016**

All rights reserved.

**Any reprinting or unauthorized use
without the written permission of
Yamaha Motor Co. Ltd.
is expressly prohibited.
Printed in Malaysia.**

Table of contents

Location of important labels.....	1-1	For your safety – pre-operation checks	5-1	Tires.....	7-17
Safety information	2-1			Cast wheels.....	7-19
Further safe-riding points.....	2-5	Operation and important riding points	6-1	Checking the front brake lever free play.....	7-19
Helmets.....	2-6	Starting the engine.....	6-1	Adjusting the rear brake lever free play.....	7-19
Description	3-1	Acceleration and deceleration.....	6-2	Checking the front brake pads and rear brake shoes.....	7-20
Left view.....	3-1	Braking.....	6-2	Checking the brake fluid level.....	7-21
Right view.....	3-2	Engine break-in.....	6-3	Changing the brake fluid.....	7-21
Controls and instruments.....	3-3	Parking.....	6-3	Checking the V-belt.....	7-22
Instrument and control functions ... 4-1		General note.....	6-4	Checking and lubricating the cables.....	7-22
Main switch/steering lock.....	4-1	Periodic maintenance and adjustment	7-1	Checking and lubricating the throttle grip and cable.....	7-22
Keyhole shutter.....	4-2	Owner's tool kit.....	7-1	Lubricating the front and rear brake levers.....	7-23
Indicator lights and warning light ...	4-3	Periodic maintenance chart for the emission control system.....	7-2	Checking and lubricating the centerstand and sidestand.....	7-23
Speedometer unit.....	4-4	General maintenance and lubrication chart.....	7-3	Checking the front fork.....	7-24
Handlebar switches.....	4-4	Removing and installing the cowlings and panels.....	7-8	Checking the steering.....	7-25
Front brake lever.....	4-5	Checking the spark plug.....	7-9	Checking the wheel bearings.....	7-25
Rear brake lever.....	4-5	Engine oil and oil strainer.....	7-11	Battery.....	7-25
Rear brake lever lock.....	4-5	Final transmission oil.....	7-13	Replacing the fuse.....	7-27
Fuel tank cap.....	4-6	Air filter and V-belt case air filter elements.....	7-14	Headlight.....	7-27
Fuel.....	4-7	Checking the engine idling speed.....	7-16	Replacing an auxiliary light bulb.....	7-28
Catalytic converter.....	4-8	Adjusting the throttle grip free play.....	7-16	Replacing a front turn signal light bulb.....	7-28
Kickstarter.....	4-9	Valve clearance.....	7-17	Replacing a tail/brake light bulb or a rear turn signal light bulb ...	7-28
Seat.....	4-9				
Helmet holders.....	4-10				
Convenience hook.....	4-10				
Storage compartment.....	4-11				
Sidestand.....	4-11				
Ignition circuit cut-off system.....	4-12				

Table of contents

Troubleshooting	7-29
Troubleshooting chart	7-31
Scooter care and storage	8-1
Care	8-1
Storage	8-3
Specifications	9-1
Consumer information	10-1
Identification numbers.....	10-1
Index	11-1

Location of important labels

EAU10385

1

Read and understand all of the labels on your vehicle. They contain important information for safe and proper operation of your vehicle. Never remove any labels from your vehicle. If a label becomes difficult to read or comes off, a replacement label is available from your Yamaha dealer.

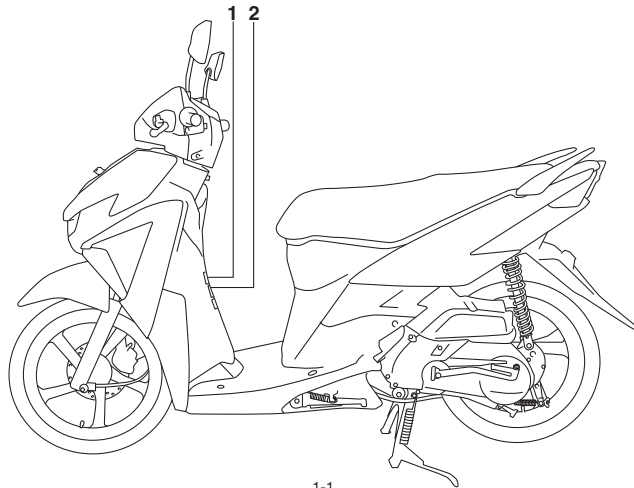



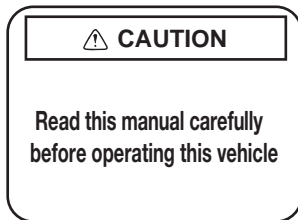

1-1

Location of important labels

1



2

	 100kPa=1bar		
	kPa, psi	kPa, psi	kPa, psi
	225, 33	250, 36	
	225, 33	250, 36	

B92-F8199-30

1

Safety information

EAU1026B

2

Be a Responsible Owner

As the vehicle's owner, you are responsible for the safe and proper operation of your scooter.

Scooters are single-track vehicles.

Their safe use and operation are dependent upon the use of proper riding techniques as well as the expertise of the operator. Every operator should know the following requirements before riding this scooter.

He or she should:

- Obtain thorough instructions from a competent source on all aspects of scooter operation.
- Observe the warnings and maintenance requirements in this Owner's Manual.
- Obtain qualified training in safe and proper riding techniques.
- Obtain professional technical service as indicated in this Owner's Manual and/or when made necessary by mechanical conditions.

- Never operate a scooter without proper training or instruction. Take a training course. Beginners should receive training from a certified instructor. Contact an authorized scooter dealer to find out about the training courses nearest you.

Safe Riding

Perform the pre-operation checks each time you use the vehicle to make sure it is in safe operating condition. Failure to inspect or maintain the vehicle properly increases the possibility of an accident or equipment damage. See page 5-1 for a list of pre-operation checks.

- This scooter is designed to carry the operator and a passenger.
- The failure of motorists to detect and recognize scooters in traffic is the predominating cause of automobile/scooter accidents. Many accidents have been caused by an automobile driver who did not see the scooter. Making yourself

conspicuous appears to be very effective in reducing the chance of this type of accident.

Therefore:

- Wear a brightly colored jacket.
- Use extra caution when you are approaching and passing through intersections, since intersections are the most likely places for scooter accidents to occur.
- Ride where other motorists can see you. Avoid riding in another motorist's blind spot.
- Never maintain a scooter without proper knowledge. Contact an authorized scooter dealer to inform you on basic scooter maintenance. Certain maintenance can only be carried out by certified staff.

- Many accidents involve inexperienced operators. In fact, many operators who have been involved in accidents do not even have a current driver's license.
 - Make sure that you are qualified and that you only lend your scooter to other qualified operators.
 - Know your skills and limits. Staying within your limits may help you to avoid an accident.
 - We recommend that you practice riding your scooter where there is no traffic until you have become thoroughly familiar with the scooter and all of its controls.
- Many accidents have been caused by error of the scooter operator. A typical error made by the operator is veering wide on a turn due to excessive speed or undercornering (insufficient lean angle for the speed).
 - Always obey the speed limit and never travel faster than warranted by road and traffic conditions.
- Always signal before turning or changing lanes. Make sure that other motorists can see you.
- The posture of the operator and passenger is important for proper control.
 - The operator should keep both hands on the handlebar and both feet on the operator footrests during operation to maintain control of the scooter.
 - The passenger should always hold onto the operator, the seat strap or grab bar, if equipped, with both hands and keep both feet on the passenger footrests. Never carry a passenger unless he or she can firmly place both feet on the passenger footrests.
- Never ride under the influence of alcohol or other drugs.
- This scooter is designed for on-road use only. It is not suitable for off-road use.

Protective Apparel

The majority of fatalities from scooter accidents are the result of head injuries. The use of a safety helmet is the single most critical factor in the prevention or reduction of head injuries.

- Always wear an approved helmet.
- Wear a face shield or goggles. Wind in your unprotected eyes could contribute to an impairment of vision that could delay seeing a hazard.
- The use of a jacket, substantial shoes, trousers, gloves, etc., is effective in preventing or reducing abrasions or lacerations.
- Never wear loose-fitting clothes, otherwise they could catch on the control levers or wheels and cause injury or an accident.
- Always wear protective clothing that covers your legs, ankles, and feet. The engine or exhaust system become very hot during or after operation and can cause burns.
- A passenger should also observe the above precautions.

Safety information

Avoid Carbon Monoxide Poisoning

All engine exhaust contains carbon monoxide, a deadly gas. Breathing carbon monoxide can cause headaches, dizziness, drowsiness, nausea, confusion, and eventually death.

Carbon Monoxide is a colorless, odorless, tasteless gas which may be present even if you do not see or smell any engine exhaust. Deadly levels of carbon monoxide can collect rapidly and you can quickly be overcome and unable to save yourself. Also, deadly levels of carbon monoxide can linger for hours or days in enclosed or poorly ventilated areas. If you experience any symptoms of carbon monoxide poisoning, leave the area immediately, get fresh air, and SEEK MEDICAL TREATMENT.

- Do not run engine indoors. Even if you try to ventilate engine exhaust with fans or open windows and doors, carbon monoxide can rapidly reach dangerous levels.
- Do not run engine in poorly ventilated or partially enclosed areas such as barns, garages, or carports.

- Do not run engine outdoors where engine exhaust can be drawn into a building through openings such as windows and doors.

Loading

Adding accessories or cargo to your scooter can adversely affect stability and handling if the weight distribution of the scooter is changed. To avoid the possibility of an accident, use extreme caution when adding cargo or accessories to your scooter. Use extra care when riding a scooter that has added cargo or accessories. Here, along with the information about accessories below, are some general guidelines to follow if loading cargo to your scooter: The total weight of the operator, passenger, accessories and cargo must not exceed the maximum load limit.

Operation of an overloaded vehicle could cause an accident.

<p>Maximum load: 155 kg (342 lb)</p>

When loading within this weight limit, keep the following in mind:

2-3

- Cargo and accessory weight should be kept as low and close to the scooter as possible. Securely pack your heaviest items as close to the center of the vehicle as possible and make sure to distribute the weight as evenly as possible on both sides of the scooter to minimize imbalance or instability.
- Shifting weights can create a sudden imbalance. Make sure that accessories and cargo are securely attached to the scooter before riding. Check accessory mounts and cargo restraints frequently.
- Properly adjust the suspension for your load (suspension-adjustable models only), and check the condition and pressure of your tires.
- Never attach any large or heavy items to the handlebar, front fork, or front fender. Such items can create unstable handling or a slow steering response.
- **This vehicle is not designed to pull a trailer or to be attached to a sidecar.**

Genuine Yamaha Accessories

Choosing accessories for your vehicle is an important decision. Genuine Yamaha accessories, which are available only from a Yamaha dealer, have been designed, tested, and approved by Yamaha for use on your vehicle.

Many companies with no connection to Yamaha manufacture parts and accessories or offer other modifications for Yamaha vehicles. Yamaha is not in a position to test the products that these aftermarket companies produce. Therefore, Yamaha can neither endorse nor recommend the use of accessories not sold by Yamaha or modifications not specifically recommended by Yamaha, even if sold and installed by a Yamaha dealer.

Aftermarket Parts, Accessories, and Modifications

While you may find aftermarket products similar in design and quality to genuine Yamaha accessories, recognize that some aftermarket accessories or modifications are not suitable because of potential safety hazards to you or others. Installing aftermarket

products or having other modifications performed to your vehicle that change any of the vehicle's design or operation characteristics can put you and others at greater risk of serious injury or death. You are responsible for injuries related to changes in the vehicle.

Keep the following guidelines in mind, as well as those provided under "Loading" when mounting accessories.

- Never install accessories or carry cargo that would impair the performance of your scooter. Carefully inspect the accessory before using it to make sure that it does not in any way reduce ground clearance or cornering clearance, limit suspension travel, steering travel or control operation, or obscure lights or reflectors.
- Accessories fitted to the handlebar or the front fork area can create instability due to improper weight distribution or aerodynamic changes. If accessories are added to the handlebar or front fork area, they must be as lightweight as possible and should be kept to a minimum.
- Bulky or large accessories may seriously affect the stability of the scooter due to aerodynamic effects. Wind may attempt to lift the scooter, or the scooter may become unstable in cross winds. These accessories may also cause instability when passing or being passed by large vehicles.
- Certain accessories can displace the operator from his or her normal riding position. This improper position limits the freedom of movement of the operator and may limit control ability, therefore, such accessories are not recommended.
- Use caution when adding electrical accessories. If electrical accessories exceed the capacity of the scooter's electrical system, an electric failure could result, which could cause a dangerous loss of lights or engine power.

Safety information

Aftermarket Tires and Rims

The tires and rims that came with your scooter were designed to match the performance capabilities and to provide the best combination of handling, braking, and comfort. Other tires, rims, sizes, and combinations may not be appropriate. Refer to page 7-17 for tire specifications and more information on replacing your tires.

Transporting the Scooter

Be sure to observe following instructions before transporting the scooter in another vehicle.

- Remove all loose items from the scooter.
- Point the front wheel straight ahead on the trailer or in the truck bed, and choke it in a rail to prevent movement.
- Secure the scooter with tie-downs or suitable straps that are attached to solid parts of the scooter, such as the frame or upper front fork triple clamp (and not, for example, to rubber-mounted handlebars or turn signals, or parts that could break). Choose the lo-

cation for the straps carefully so the straps will not rub against painted surfaces during transport.

- The suspension should be compressed somewhat by the tie-downs, if possible, so that the scooter will not bounce excessively during transport.

Further safe-riding points

EAU57600

- Be sure to signal clearly when making turns.
- Braking can be extremely difficult on a wet road. Avoid hard braking, because the scooter could slide. Apply the brakes slowly when stopping on a wet surface.
- Slow down as you approach a corner or turn. Once you have completed a turn, accelerate slowly.
- Be careful when passing parked cars. A driver might not see you and open a door in your path.
- Railroad crossings, streetcar rails, iron plates on road construction sites, and manhole covers become extremely slippery when wet. Slow down and cross them with caution. Keep the scooter upright, otherwise it could slide out from under you.
- The brake pads or linings could get wet when you wash the scooter. After washing the scooter, check the brakes before riding.

- Always wear a helmet, gloves, trousers (tapered around the cuff and ankle so they do not flap), and a brightly colored jacket.
- Do not carry too much luggage on the scooter. An overloaded scooter is unstable. Use a strong cord to secure any luggage to the carrier (if equipped). A loose load will affect the stability of the scooter and could divert your attention from the road. (See page 2-3.)

Helmets

EAUJ0033

Operating this vehicle without an approved motorcycle helmet increases your chances of a severe head injury or death in the event of an accident. The majority of fatalities from motorcycle or scooter accidents are the result of head injuries. The use of a safety helmet is the single most critical factor in the prevention or reduction of head injuries.

Always select an approved motorcycle helmet

Pay attention to the following when choosing a motorcycle helmet.

- The helmet must meet the safety standard "SIRIM".
- The helmet size must match the size of the rider's head.
- Never subject a helmet to heavy shocks.

Wearing the helmet correctly

Always connect the chin strap. In the case of an accident, the helmet has a much less chance of coming off if the chin strap is connected.

2-6

Correct usage



ZAUU0003

Wrong usage



ZAUU0007

Safety information

2



ZAUU0005

- Full-type: use only for riding at low to mid-range speeds



ZAUU0006

- Full-face-type: use for riding at mid-range to high speeds

Left view

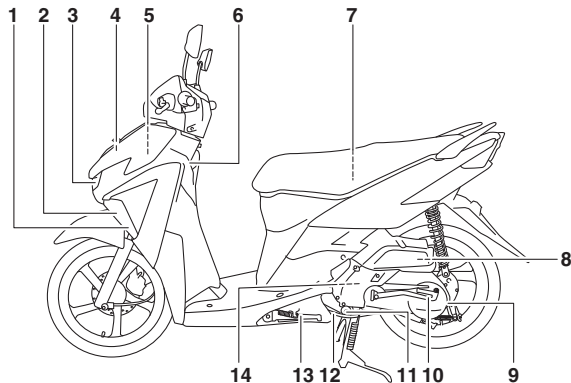

1. Front turn signal light (page 7-28/7-28)
2. Auxiliary light (page 7-28)
3. Headlight (page 7-27)
4. Battery (page 7-25)
5. Fuse (page 7-27)
6. Convenience hook (page 4-10)
7. Owner's tool kit (page 7-1)
8. Air filter element (page 7-14)

9. Final transmission oil drain bolt (page 7-13)
10. Kickstarter (page 4-9)
11. Engine oil drain bolt B (page 7-11)
12. Engine oil drain bolt A (page 7-11)
13. Sidestand (page 4-11)
14. V-belt case air filter element (page 7-14)

Description

EAU10421

Right view

3

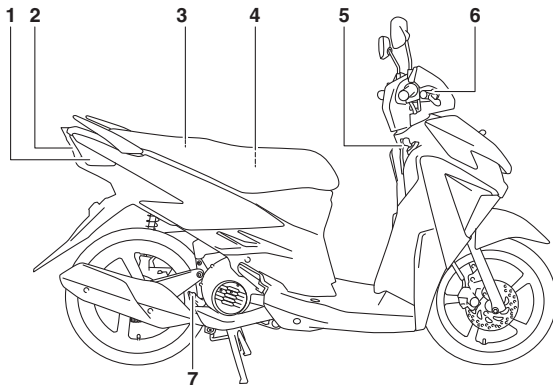

1. Rear turn signal light (page 7-28)
2. Tail/brake light (page 7-28)
3. Fuel tank cap (page 4-6)
4. Storage compartment (page 4-11)
5. Main switch/steering lock (page 4-1)
6. Front brake fluid reservoir (page 7-21)
7. Dipstick (page 7-11)

Controls and instruments

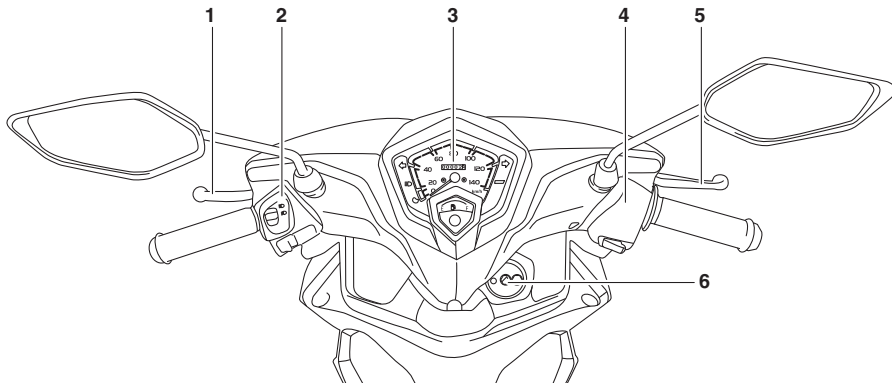
**3**

1. Rear brake lever (page 4-5)
2. Left handlebar switches (page 4-4)
3. Speedometer (page 4-4)
4. Right handlebar switch (page 4-4)
5. Front brake lever (page 4-5)
6. Main switch/steering lock (page 4-1)

Instrument and control functions

4

Main switch/steering lock

EAU68550

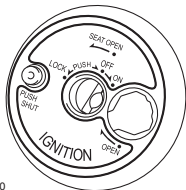

ZAUJ0880

The main switch/steering lock controls the ignition and lighting systems, is used to lock the steering, and is used to open the seat. The main switch positions are described below.

TIP

The main switch is equipped with a keyhole shutter. See page 4-2 for instructions on how to open and shut the keyhole shutter.

EAUJ1055

ON

All electrical circuits are supplied with power, and the engine can be started. The key cannot be removed.

TIP

The meter lighting comes on when the key is turned to "ON". When the engine is started, the headlight, auxiliary light and taillight come on automatically, and will stay on until the key is turned to "OFF" or the sidestand is lowered.

EAU10662

OFF

All electrical systems are off. The key can be removed.

EWA10062

WARNING

Never turn the key to "OFF" or "LOCK" while the vehicle is moving. Otherwise the electrical systems will be switched off, which may result in loss of control or an accident.

EAU10686

LOCK

The steering is locked and all electrical systems are off. The key can be removed.

To lock the steering

1



2



1. Push.
2. Turn.

1. Turn the handlebars all the way to the left.
2. With the key in the "OFF" position, push the key in and turn it to "LOCK".
3. Remove the key.

TIP

If the steering will not lock, try turning the handlebars back to the right slightly.

Instrument and control functions

To unlock the steering

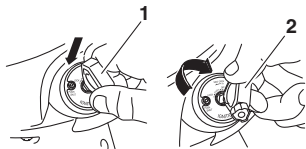

ZAUU0873

1. Push.
2. Turn.

Push the key in, and then turn it to "OFF" while still pushing it.

Keyhole cover

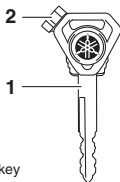

ZAUU0590

1. Ignition key
2. Safety key

To open the keyhole cover

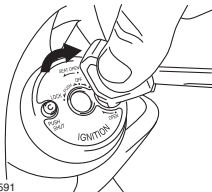

ZAUU0591

Insert the key head into the keyhole cover receptacle as shown, and then turn the key to the right to open the cover.

EAAU0820

To close the keyhole cover

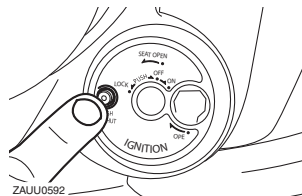

ZAUU0592

Press the "PUSH SHUT" button to close the keyhole cover.

Instrument and control functions

Indicator lights and warning light

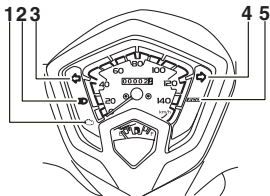

1. Engine trouble warning light “”
2. High beam indicator light “”
3. Left turn signal indicator light “”
4. Right turn signal indicator light “”
5. Eco indicator “ECO”

Turn signal indicator lights “” and “”

Each indicator light will flash when its corresponding turn signal lights are flashing.

High beam indicator light “”

This indicator light comes on when the high beam of the headlight is switched on.

Engine trouble warning light “”

This warning light comes on if a problem is detected in the electrical circuit monitoring the engine. If this occurs, have a Yamaha dealer check the self-diagnosis system.

The electrical circuit of the warning light can be checked by turning the key to “ON”. The warning light should come on for a few seconds, and then go off.

If the warning light does not come on initially when the key is turned to “ON”, or if the warning light remains on, have a Yamaha dealer check the electrical circuit.

Eco indicator light “ECO”

This indicator comes on when the vehicle is being operated in an environmentally friendly, fuel-efficient manner. The indicator goes off when the vehicle is stopped.

TIP

Consider the following tips to reduce fuel consumption:

- Avoid high engine speeds during acceleration.
- Travel at a constant speed.

Instrument and control functions

Speedometer unit

EAU00081

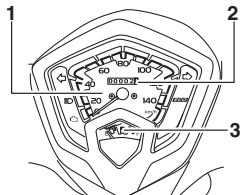

1. Speedometer
2. Odometer
3. Fuel meter



The speedometer unit is equipped with a speedometer, an odometer and a fuel meter. The speedometer shows riding speed. The odometer shows the total distance traveled. The fuel meter indicates the amount of fuel in the fuel tank.

Handlebar switches

EAU1234H

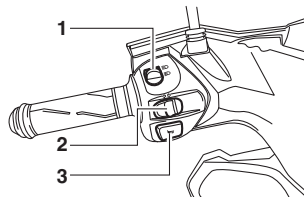
Left



1. Dimmer switch “/”
2. Turn signal switch “/”
3. Horn switch “”

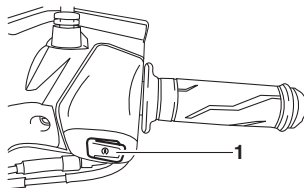

Right



1. Start switch “”



Dimmer switch “/”

EAU12401

Set this switch to “” for the high beam and to “” for the low beam.

Turn signal switch “/”

EAU12461

To signal a right-hand turn, push this switch to “”. To signal a left-hand turn, push this switch to “”. When released, the switch returns to the center position. To cancel the turn signal lights, push the switch in after it has returned to the center position.

Horn switch “”

EAU12501

Press this switch to sound the horn.

Start switch “”

EAU1M133

Push this switch while applying the front or rear brake to crank the engine with the starter. See page 6-1 for starting instructions prior to starting the engine.

Instrument and control functions

4

Front brake lever

EAU12902

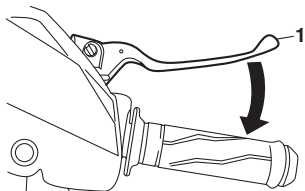

1. Front brake lever

The front brake lever is located on the right side of the handlebar. To apply the front brake, pull this lever toward the throttle grip.

Rear brake lever

EAU12952

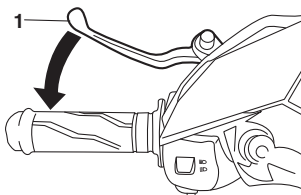

1. Rear brake lever

The rear brake lever is located on the left side of the handlebar. To apply the rear brake, pull this lever toward the handlebar grip.

Rear brake lever lock

EAUN0440

This vehicle is equipped with a rear brake lever lock.

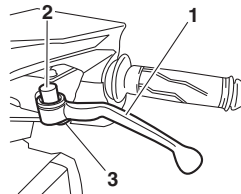

1. Rear brake lever
2. Lever lock pin
3. Lever lock pin stopper

To lock the brake lever

1. Pull the rear brake lever toward the handlebar grip.
2. Push the lever lock pin down until it latches with the lever lock pin stopper.

To unlock the brake lever

1. Pull the brake lever toward the handlebar grip.

Instrument and control functions

2. The lever lock pin should release from the lever lock pin stopper and unlock the rear brake lever.

TIP

Use the rear brake lever lock while seated.

EWA00010

⚠ WARNING

Never apply the rear brake lever lock while the vehicle is moving, otherwise loss of control or an accident may result. Make sure that the vehicle is stopped before applying the rear brake lever lock.

Fuel tank cap

EAU37473

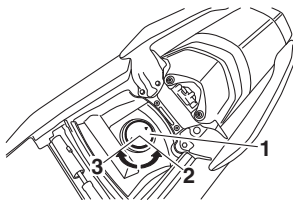

1. Fuel tank cap
2. Open.
3. Close.

To remove the fuel tank cap

1. Open the seat. (See page 4-9.)
2. Turn the fuel tank cap counter-clockwise and pull it off.

To install the fuel tank cap

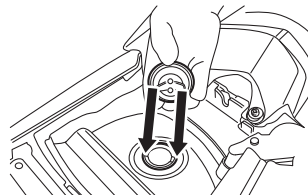

1. Insert the fuel tank cap into the tank opening and turn it clockwise until the “Δ” marks on the cap and tank are aligned.
2. Close the seat.

EWA11092

⚠ WARNING

Make sure that the fuel tank cap is properly closed after filling fuel. Leaking fuel is a fire hazard.

Instrument and control functions

Fuel

Make sure there is sufficient gasoline in the tank.

EAU13213

WARNING

Gasoline and gasoline vapors are extremely flammable. To avoid fires and explosions and to reduce the risk of injury when refueling, follow these instructions.

EWA10882

1. Before refueling, turn off the engine and be sure that no one is sitting on the vehicle. Never refuel while smoking, or while in the vicinity of sparks, open flames, or other sources of ignition such as the pilot lights of water heaters and clothes dryers.
2. Do not overfill the fuel tank. Stop filling when the fuel reaches the bottom of the filler tube. Because fuel expands when it heats up, heat from the engine or the sun can cause fuel to spill out of the fuel tank.

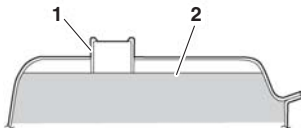

ZAUU0026

1. Fuel tank filler tube
2. Maximum fuel level
3. Wipe up any spilled fuel immediately. **NOTICE:** Immediately wipe off spilled fuel with a clean, dry, soft cloth, since fuel may deteriorate painted surfaces or plastic parts. [ECA10072]
4. Be sure to securely close the fuel tank cap.

EWA15152

WARNING

Gasoline is poisonous and can cause injury or death. Handle gasoline with care. Never siphon gasoline by mouth. If you should swallow some gasoline or inhale a lot of gasoline vapor, or get some gasoline in your eyes, see your doctor immedi-

ately. If gasoline spills on your skin, wash with soap and water. If gasoline spills on your clothing, change your clothes.

EALU0045

Recommended fuel:

Regular unleaded gasoline (Gasohol [E10] acceptable)

Fuel tank capacity:

4.2 L (1.1 US gal, 0.9 Imp.gal)

ECA11401

NOTICE

Use only unleaded gasoline. The use of leaded gasoline will cause severe damage to internal engine parts, such as the valves and piston rings, as well as to the exhaust system.

Gasohol

There are two types of gasohol: gasohol containing ethanol and that containing methanol. Gasohol containing ethanol can be used if the ethanol content does not exceed 10% (E10). Gasohol containing methanol is not

Instrument and control functions

recommended by Yamaha because it can cause damage to the fuel system or vehicle performance problems.

Catalytic converter

EAU13434

ECA10702

This model is equipped with a catalytic converter in the exhaust system.

EWA10863

WARNING

The exhaust system is hot after operation. To prevent a fire hazard or burns:

- Do not park the vehicle near possible fire hazards such as grass or other materials that easily burn.
 - Park the vehicle in a place where pedestrians or children are not likely to touch the hot exhaust system.
 - Make sure that the exhaust system has cooled down before doing any maintenance work.
 - Do not allow the engine to idle more than a few minutes. Long idling can cause a build-up of heat.
-

NOTICE

Use only unleaded gasoline. The use of leaded gasoline will cause unrepairable damage to the catalytic converter.

Instrument and control functions

4

Kickstarter

EAUJ37651

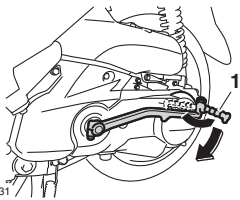

ZAUU0831

1. Kickstarter

If the engine fails to start by pushing the start switch, try to start it by using the kickstarter. To start the engine, fold out the kickstarter lever, move it down lightly with your foot until the gears engage, and then push it down smoothly but forcefully.

Seat

EAUJ13933

To open the seat

1. Place the scooter on the center-stand.
2. Insert the key into the main switch, and then turn it counterclockwise to "OPEN".

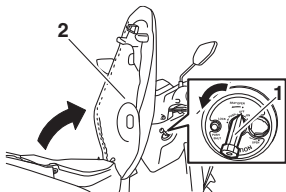

1. Seat lock
2. Seat

TIP

Do not push inward when turning the key.

3. Fold the seat up.

To close the seat

1. Fold the seat down, and then push it down to lock it in place.
2. Remove the key from the main switch if the scooter will be left unattended.

TIP

Make sure that the seat is properly secured before riding.

Helmet holders

EAUJ374B2

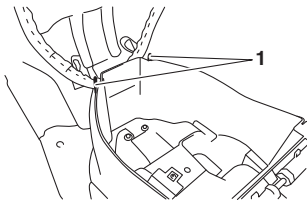

1. Helmet holder

The helmet holders are located under the seat.

To secure a helmet to a helmet holder

1. Open the seat. (See page 4-9.)
2. Attach a helmet to a helmet holder, and then securely close the seat. **WARNING! Never ride with a helmet attached to the helmet holder, since the helmet may hit objects, causing loss of control and possibly an accident.** [EWA10162]

To release a helmet from a helmet holder

Open the seat, remove the helmet from the helmet holder, and then close the seat.

Convenience hook

EALIN1200

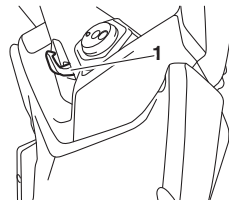

1. Convenience hook

⚠ WARNING

- Do not exceed the load limit of 1 kg (2.2 lb) for the convenience hook.
- Do not exceed the maximum load of 155 kg (342 lb) for the scooter.

EWAN0030

Instrument and control functions

4

Storage compartment

EAU67520

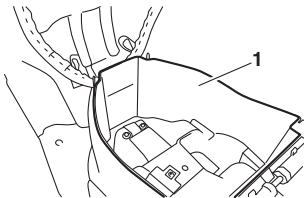

1. Storage compartment

There is a storage compartment under the seat.

EWA10962

WARNING

- Do not exceed the load limit of 3 kg (6.6 lb) for the storage compartment.
- Do not exceed the maximum load of 155 kg (342 lb) for the vehicle.

ECA21150

NOTICE

Keep the following points in mind when using the storage compartment.

- Since the storage compartment accumulates heat when exposed to the sun and/or the engine heat, do not store anything susceptible to heat, consumables or flammable items inside it.
- To avoid humidity from spreading through the storage compartment, wrap wet articles in a plastic bag before storing them in the compartment.
- Since the storage compartment may get wet while the vehicle is being washed, wrap any articles stored in the compartment in a plastic bag.
- Do not keep anything valuable or breakable in the storage compartment.

TIP

Do not leave your vehicle unattended with the seat open.

Sidestand

EAU15306

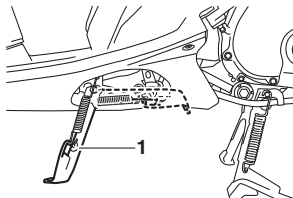

1. Sidestand

The sidestand is located on the left side of the frame. Raise the sidestand or lower it with your foot while holding the vehicle upright.

TIP

The built-in sidestand switch is part of the ignition circuit cut-off system, which cuts the ignition in certain situations. (See the following section for an explanation of the ignition circuit cut-off system.)

WARNING

EWA10242

The vehicle must not be ridden with the sidestand down, or if the sidestand cannot be properly moved up (or does not stay up), otherwise the sidestand could contact the ground and distract the operator, resulting in a possible loss of control. Yamaha's ignition circuit cut-off system has been designed to assist the operator in fulfilling the responsibility of raising the sidestand before starting off. Therefore, check this system regularly and have a Yamaha dealer repair it if it does not function properly.

EAUT1096

Ignition circuit cut-off system

Check the operation of the sidestand switch according to the following procedure.

Instrument and control functions

4

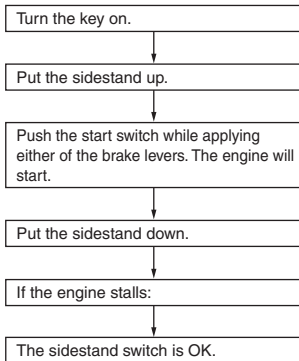

WARNING

- The vehicle must be placed on the centerstand during this inspection.
- If a malfunction is noted, have a Yamaha dealer check the system before riding.

For your safety – pre-operation checks

EAU15599

Inspect your vehicle each time you use it to make sure the vehicle is in safe operating condition. Always follow the inspection and maintenance procedures and schedules described in the Owner's Manual.

EWA11152

WARNING

Failure to inspect or maintain the vehicle properly increases the possibility of an accident or equipment damage. Do not operate the vehicle if you find any problem. If a problem cannot be corrected by the procedures provided in this manual, have the vehicle inspected by a Yamaha dealer.

Before using this vehicle, check the following points:

ITEM	CHECKS	PAGE
Fuel	<ul style="list-style-type: none">• Check fuel level in fuel tank.• Refuel if necessary.• Check fuel line for leakage.	4-7
Engine oil	<ul style="list-style-type: none">• Check oil level in engine.• If necessary, add recommended oil to specified level.• Check vehicle for oil leakage.	7-11
Final transmission oil	<ul style="list-style-type: none">• Check vehicle for oil leakage.	7-13
Front brake	<ul style="list-style-type: none">• Check operation.• If soft or spongy, have Yamaha dealer bleed hydraulic system.• Check brake pads for wear.• Replace if necessary.• Check fluid level in reservoir.• If necessary, add specified brake fluid to specified level.• Check hydraulic system for leakage.	7-20, 7-21
Rear brake	<ul style="list-style-type: none">• Check operation.• Lubricate cable if necessary.• Check lever free play.• Adjust if necessary.	7-19, 7-20

For your safety – pre-operation checks

ITEM	CHECKS	PAGE
Throttle grip	<ul style="list-style-type: none"> • Make sure that operation is smooth. • Check throttle grip free play. • If necessary, have Yamaha dealer adjust throttle grip free play and lubricate cable and grip housing. 	7-16, 7-22
Control cables	<ul style="list-style-type: none"> • Make sure that operation is smooth. • Lubricate if necessary. 	7-22
Wheels and tires	<ul style="list-style-type: none"> • Check for damage. • Check tire condition and tread depth. • Check air pressure. • Correct if necessary. 	7-17, 7-19
Front brake lever	<ul style="list-style-type: none"> • Make sure that operation is smooth. • Lubricate lever pivoting point if necessary. 	7-23
Rear brake lever	<ul style="list-style-type: none"> • Make sure that operation is smooth and rear brake lever lock pin properly latches and releases. • Lubricate lever pivoting point and lever lock pin if necessary. 	4-5, 7-23
Centerstand, sidestand	<ul style="list-style-type: none"> • Make sure that operation is smooth. • Lubricate pivots if necessary. 	7-23
Chassis fasteners	<ul style="list-style-type: none"> • Make sure that all nuts, bolts and screws are properly tightened. • Tighten if necessary. 	—
Instruments, lights, signals and switches	<ul style="list-style-type: none"> • Check operation. • Correct if necessary. 	—
Sidestand switch	<ul style="list-style-type: none"> • Check operation of ignition circuit cut-off system. • If system is not working correctly, have Yamaha dealer check vehicle. 	4-11

Operation and important riding points

EAU15952

Read the Owner's Manual carefully to become familiar with all controls. If there is a control or function you do not understand, ask your Yamaha dealer.

EWA10272

WARNING

Failure to familiarize yourself with the controls can lead to loss of control, which could cause an accident or injury.

EALUV0121

ECAV0031

NOTICE

Do not ride in water that is deep enough to allow engine parts, especially the air filter intake, to become wet or submersed. If the engine is allowed to be submersed in water, be sure to remove the water from the air filter case as soon as possible to prevent extensive engine damage. (See "PERIODIC MAINTENANCE AND ADJUSTMENT" for details.)

EALUN0850

Starting the engine

The sidestand must be up in order for the ignition circuit cut-off system to enable starting (see page 4-12).

EWAN0020

WARNING

Before starting the engine, make sure that the vehicle is placed on the centerstand.

ECA10251

NOTICE

See page 6-3 for engine break-in instructions prior to operating the vehicle for the first time.

To start the engine

1. Place the vehicle on the centerstand.
2. Turn the key to "ON".
3. Apply the front or rear brake.
4. Push the start switch.

Each starting attempt should be as short as possible to preserve the battery. Do not crank the engine more than 5 seconds on any one attempt.

Operation and important riding points

5. When the engine starts, release the start switch.

If the engine does not start, try again with the throttle grip open 1/4 turn (10 mm).

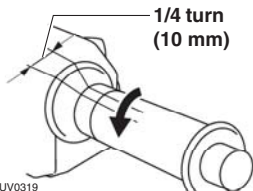

TIP

If the engine will not start by pushing the start switch, try using the kick-starter.

ECA11043

NOTICE

For maximum engine life, never accelerate hard when the engine is cold!

Acceleration and deceleration

EAU16782

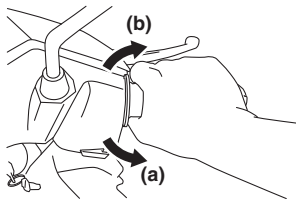

The speed can be adjusted by opening and closing the throttle. To increase the speed, turn the throttle grip in direction (a). To reduce the speed, turn the throttle grip in direction (b).

Braking

EAU67530

EWA17790

⚠ WARNING

- Avoid braking hard or suddenly (especially when leaning over to one side), otherwise the vehicle may skid or overturn.
- Railroad crossings, streetcar rails, iron plates on road construction sites, and manhole covers become extremely slippery when wet. Therefore, slow down when approaching such areas and cross them with caution.
- Keep in mind that braking on a wet road is much more difficult.
- Ride slowly down a hill, as braking downhill can be very difficult.

1. Close the throttle completely.
2. Apply both front and rear brakes simultaneously while gradually increasing the pressure.

Operation and important riding points

Engine break-in

EAU16831

There is never a more important period in the life of your engine than the period between 0 and 1000 km (600 mi). For this reason, you should read the following material carefully.

Since the engine is brand new, do not put an excessive load on it for the first 1000 km (600 mi). The various parts in the engine wear and polish themselves to the correct operating clearances. During this period, prolonged full-throttle operation or any condition that might result in engine overheating must be avoided.

EAUJ37793

0–150 km (0–90 mi)

Avoid prolonged operation above 1/3 throttle.

After every hour of operation, stop the engine, and then let it cool for five to ten minutes.

Vary the engine speed from time to time. Do not operate the engine at one set throttle position.

150–500 km (90–300 mi)

Avoid prolonged operation above 1/2 throttle.

Rev the engine freely through the gears, but do not use full throttle at any time.

500–1000 km (300–600 mi)

Avoid prolonged operation above 3/4 throttle.

1000 km (600 mi) and beyond

Avoid prolonged full-throttle operation. Vary the engine speed occasionally.

NOTICE: After 1000 km (600 mi) of operation, the engine oil must be changed, the oil filter cartridge or element replaced, and the oil strainer cleaned. If any engine trouble should occur during the engine break-in period, immediately have a Yamaha dealer check the vehicle.

[ECA10363]

EAU17214

Parking

When parking, stop the engine, and then remove the key from the main switch.

EWA10312

WARNING

- Since the engine and exhaust system can become very hot, park in a place where pedestrians or children are not likely to touch them and be burned.
- Do not park on a slope or on soft ground, otherwise the vehicle may overturn, increasing the risk of a fuel leak and fire.
- Do not park near grass or other flammable materials which might catch fire.

Operation and important riding points

EAU1241

General note

Much can be gained from the correct use and maintenance of a motorcycle.

1. THE CUSTOMERS CAN USE THE FULLEST POTENTIAL OF YAMAHA MOTORCYCLES

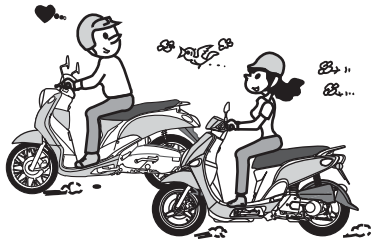

ZAUU0736

2. A MOTORCYCLE CAN KEEP ITS PERFORMANCE CAPABILITY FOR A LONGER TIME

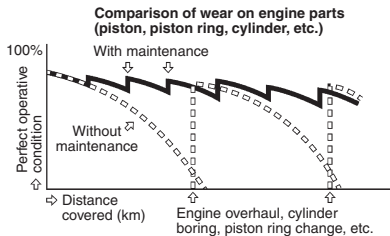

Operation and important riding points

3. FUEL COST AND REPAIR EXPENSES CAN BE KEPT TO A MINIMUM

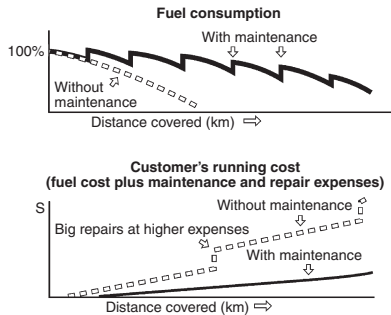

ZAUU0737

4. A MOTORCYCLE CAN DEMAND A HIGH PRICE WHEN IT IS TRADED IN AS A USED PRODUCT

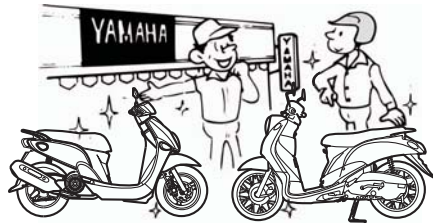

Periodic maintenance and adjustment

EAU17246

Periodic inspection, adjustment, and lubrication will keep your vehicle in the safest and most efficient condition possible. Safety is an obligation of the vehicle owner/operator. The most important points of vehicle inspection, adjustment, and lubrication are explained on the following pages.

The intervals given in the periodic maintenance charts should be simply considered as a general guide under normal riding conditions. However, depending on the weather, terrain, geographical location, and individual use, the maintenance intervals may need to be shortened.

⚠ WARNING

EWA10322

Failure to properly maintain the vehicle or performing maintenance activities incorrectly may increase your risk of injury or death during service or while using the vehicle. If you are not familiar with vehicle service, have a Yamaha dealer perform service.

⚠ WARNING

EWA15123

Turn off the engine when performing maintenance unless otherwise specified.

- **A running engine has moving parts that can catch on body parts or clothing and electrical parts that can cause shocks or fires.**
- **Running the engine while servicing can lead to eye injury, burns, fire, or carbon monoxide poisoning – possibly leading to death. See page 2-3 for more information about carbon monoxide.**

⚠ WARNING

EWA15461

Brake discs, calipers, drums, and linings can become very hot during use. To avoid possible burns, let brake components cool before touching them.

Owner's tool kit

EAU17382

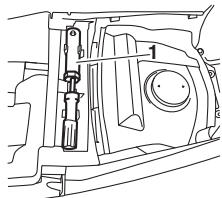

1. Owner's tool kit

The owner's tool kit is located under the seat. (See page 4-9.)

The service information included in this manual and the tools provided in the owner's tool kit are intended to assist you in the performance of preventive maintenance and minor repairs. However, additional tools such as a torque wrench may be necessary to perform certain maintenance work correctly.

TIP

If you do not have the tools or experience required for a particular job, have a Yamaha dealer perform it for you.

Periodic maintenance and adjustment

EALU0621

TIP

- The annual checks must be performed every year, except if a kilometer-based maintenance is performed instead.
- From 20000 km, repeat the maintenance intervals starting from 4000 km.
- Items marked with an asterisk should be performed by a Yamaha dealer as they require special tools, data and technical skills.

EALU1293

Periodic maintenance chart for the emission control system

NO.	ITEM	CHECK OR MAINTENANCE JOB	ODOMETER READING (whichever comes first)					ANNUAL CHECK
			1000 km or 2 months	4000 km or 6 months	8000 km or 10 months	12000 km or 14 months	16000 km or 18 months	
1	* Fuel line	<ul style="list-style-type: none"> • Check fuel hose for cracks or damage. 		√	√	√	√	√
2	* Fuel filter	<ul style="list-style-type: none"> • Check condition. • Replace if necessary. 	Every 12000 km (7500 mi)					
3	Spark plug	<ul style="list-style-type: none"> • Check condition. • Clean and regap. 		√	√	√	√	
		<ul style="list-style-type: none"> • Replace. 	Every 8000 km (5000 mi)					
4	* Valves	<ul style="list-style-type: none"> • Check valve clearance. • Adjust if necessary. 			√		√	
5	* Fuel injection	<ul style="list-style-type: none"> • Check engine idle speed. 	√	√	√	√	√	√
6	* Exhaust system	<ul style="list-style-type: none"> • Check for leakage. • Tighten if necessary. • Replace gasket(s) if necessary. 		√	√	√	√	√

Periodic maintenance and adjustment

EAIJ1286

General maintenance and lubrication chart

NO.	ITEM	CHECK OR MAINTENANCE JOB	ODOMETER READING (whichever comes first)					ANNUAL CHECK
			1000 km or 2 months	4000 km or 6 months	8000 km or 10 months	12000 km or 14 months	16000 km or 18 months	
1	Air filter element	• Replace.	Every 16000 km (10000 mi)					
2	Air filter check hose	• Clean.	√	√	√	√	√	
3	V-belt case air filter element	• Clean. • Replace if necessary.		√	√	√	√	
4	Battery	• Check voltage. • Charge if necessary.	√	√	√	√	√	√
5	Front brake	• Check operation, fluid level and vehicle for fluid leakage. • Replace brake pads.	√	√	√	√	√	√
			Whenever worn to the limit					
6	Rear brake	• Check operation and adjust brake lever free play. • Replace brake shoes.	√	√	√	√	√	√
			Whenever worn to the limit					
7	Brake hose	• Check for cracks or damage. • Check for correct routing and clamping. • Replace.		√	√	√	√	√
			Every 4 years					
8	Brake fluid	• Change.	Every 2 years					
9	Wheels	• Check runout and for damage. • Replace if necessary.		√	√	√	√	√

Periodic maintenance and adjustment

NO.	ITEM	CHECK OR MAINTENANCE JOB	ODOMETER READING (whichever comes first)					ANNUAL CHECK
			1000 km or 2 months	4000 km or 6 months	8000 km or 10 months	12000 km or 14 months	16000 km or 18 months	
10	* Tires	<ul style="list-style-type: none"> • Check tread depth and for damage. • Replace if necessary. • Check air pressure. • Correct if necessary. 		√	√	√	√	√
11	* Wheel bearings	<ul style="list-style-type: none"> • Check bearings for looseness or damage. 		√	√	√	√	
12	* Steering bearings	<ul style="list-style-type: none"> • Check bearing play and steering for roughness. 	√	√	√	√	√	
		<ul style="list-style-type: none"> • Lubricate with lithium-soap-based grease. 	Every 12000 km (7500 mi)					
13	* Chassis fasteners	<ul style="list-style-type: none"> • Make sure that all nuts, bolts and screws are properly tightened. 		√	√	√	√	√
14	Front brake lever pivot shaft	<ul style="list-style-type: none"> • Lubricate with silicone grease. 		√	√	√	√	√
15	Rear brake lever pivot shaft	<ul style="list-style-type: none"> • Lubricate with lithium-soap-based grease. 		√	√	√	√	√
16	Sidestand, center-stand	<ul style="list-style-type: none"> • Check operation. • Lubricate with lithium-soap-based grease. 		√	√	√	√	√
17	* Sidestand switch	<ul style="list-style-type: none"> • Check operation. 	√	√	√	√	√	√
18	* Front fork	<ul style="list-style-type: none"> • Check operation and for oil leakage. 		√	√	√	√	
19	* Shock absorber assembly	<ul style="list-style-type: none"> • Check operation and shock absorber for oil leakage. 		√	√	√	√	

Periodic maintenance and adjustment

NO.	ITEM	CHECK OR MAINTENANCE JOB	ODOMETER READING (whichever comes first)					ANNUAL CHECK
			1000 km or 2 months	4000 km or 6 months	8000 km or 10 months	12000 km or 14 months	16000 km or 18 months	
20	Engine oil	<ul style="list-style-type: none"> Change. Check oil level and vehicle for oil leakage. 	√	√	√	√	√	
21	* Engine oil strainer	<ul style="list-style-type: none"> Clean. 	√					√
22	Final transmission oil	<ul style="list-style-type: none"> Check vehicle for oil leakage. 	√	√	Every 8000 km (5000 mi)			
		<ul style="list-style-type: none"> Change. 	√	Every 12000 km (7500 mi)				
23	* V-belt	<ul style="list-style-type: none"> Check for damage and wear. 			√	√	√	√
		<ul style="list-style-type: none"> Replace. 	Every 25000 km (15500 mi)					
24	* V-belt secondary sheave	<ul style="list-style-type: none"> Lubricate. 	Every 12000 km (7500 mi)					
25	* Front and rear brake switches	<ul style="list-style-type: none"> Check operation. 	√	√	√	√	√	√
26	Moving parts and cables	<ul style="list-style-type: none"> Lubricate. 		√	√	√	√	√
27	* Throttle grip	<ul style="list-style-type: none"> Check operation. Check throttle grip free play, and adjust if necessary. Lubricate cable and grip housing. 		√	√	√	√	√
28	* Lights, signals and switches	<ul style="list-style-type: none"> Check operation. Adjust headlight beam. 	√	√	√	√	√	√

Periodic maintenance and adjustment

EALU1622

TIP

- Air filter
 - This model's air filter is equipped with a disposable oil-coated paper element, which must not be cleaned with compressed air to avoid damaging it.
 - The air filter element needs to be replaced more frequently when riding in unusually wet or dusty areas.
- V-belt case air filter
 - The air filter needs more frequent service if you are riding in unusually wet or dusty areas.
- V-belt
 - The V-belt should be checked at the initial 8000 km (5000 mi) and every 4000 km (2500 mi) thereafter. Replace the V-belt if any damage or wear is found. The V-belt needs to be replaced every 25000 km (16000 mi) even if there is no wear or damage.
- Hydraulic brake service
 - Regularly check and, if necessary, correct the brake fluid level. After disassembling the brake master cylinders and calipers, always change the brake fluid.
 - Every two years replace the internal components of the brake master cylinder and caliper, and change the brake fluid.
 - Replace the brake hose every four years and if cracked or damaged.
- Fuel system service
 - Use only unleaded gasoline. The use of leaded gasoline will cause severe damage to internal engine parts, such as the valves and piston rings, as well as to the exhaust system.
 - Replace the fuel filler cover every two years or if cracked or damaged.
 - Check the fuel filter if clogged or damaged every 12000 km (7500 mi).
- Battery service
 - Check the condition and service every 3 months.
 - Recharge the battery immediately if the voltage is less than 12.4 V.
 - If the battery tends to discharge, replace it immediately.

Periodic maintenance and adjustment

- If the vehicle will not be used for more than one month, remove the battery, fully charge it, and then place it in a cool, dry place.
-

Periodic maintenance and adjustment

Removing and installing the cowling and panels

EAU18724

The cowling and panels shown need to be removed to perform some of the maintenance jobs described in this chapter. Refer to this section each time the cowling or a panel needs to be removed and installed.

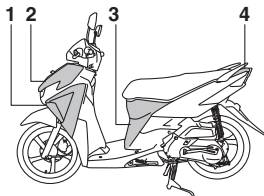

1. Cowling A
2. Panel A
3. Panel B
4. Panel C

Cowling A

EAU58190

To remove the cowling

Remove the screws, and then pull the cowling off as shown.

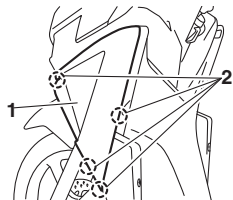

1. Cowling A
2. Screw

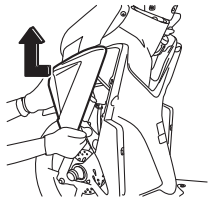

To install the cowling

Place the cowling in the original position, and then install the screws.

EAUN0950

Panel A

To remove the panel

1. Remove the screws from panel A.

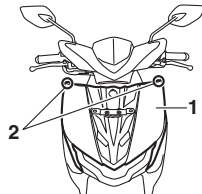

1. Panel A
2. Screw

2. Pull the panel off as shown.

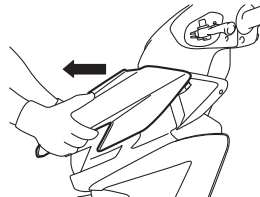

Periodic maintenance and adjustment

To install the panel

Place the panel in the original position, and then install the screws.

Panel B

To remove the panel

1. Open the seat. (See page 4-9.)
2. Remove the screws, and then pull the panel off as shown.

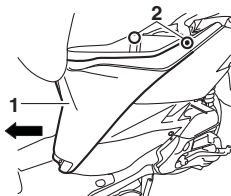

1. Panel B
2. Screw

To install the panel

1. Place the panel in the original position, and then install the screws.
2. Close the seat.

Panel C

To remove the panel

1. Open the seat. (See page 4-9.)
2. Remove the screws, and then pull the panel off as shown.

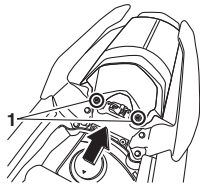

1. Screw

To install the panel

1. Place the panel in the original position, and then install the screws.
2. Close the seat.

EALU1837

Checking the spark plug

The spark plug is an important engine component, which is easy to check. Since heat and deposits will cause any spark plug to slowly erode, the spark plug should be removed and checked in accordance with the periodic maintenance and lubrication chart. In addition, the condition of the spark plug can reveal the condition of the engine.

To remove the spark plug

1. Place the vehicle on the center-stand.
2. Remove panel B. (See page 7-8.)
3. Remove the spark plug cap.

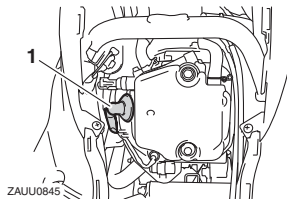

ZAUU0845

1. Spark plug cap

Periodic maintenance and adjustment

- Remove the spark plug as shown, with the spark plug wrench included in the owner's tool kit.

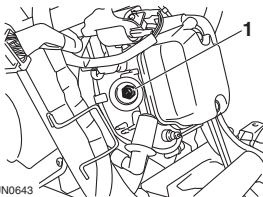

ZAUN0643

- Spark plug

To check the spark plug

- Check that the porcelain insulator around the center electrode of the spark plug is a medium-to-light tan (the ideal color when the vehicle is ridden normally).

TIP

If the spark plug shows a distinctly different color, the engine could be operating improperly. Do not attempt to diagnose such problems yourself. Instead, have a Yamaha dealer check the vehicle.

- Check the spark plug for electrode erosion and excessive carbon or other deposits, and replace it if necessary.

Specified spark plug:
NGK/CR6HSA

- Measure the spark plug gap with a wire thickness gauge and, if necessary, adjust the gap to specification.

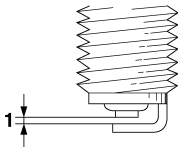

- Spark plug gap

Spark plug gap:
0.6–0.7 mm (0.024–0.028 in)

To install the spark plug

- Clean the surface of the spark plug gasket and its mating surface, and then wipe off any grime from the spark plug threads.
- Install the spark plug with the spark plug wrench, and then tighten it to the specified torque.

Tightening torque:

Spark plug:
12.5 Nm (1.25 m·kgf, 9.0 ft·lbf)

TIP

If a torque wrench is not available when installing a spark plug, a good estimate of the correct torque is 1/4–1/2 turn past finger tight. However, the spark plug should be tightened to the specified torque as soon as possible.

- Install the spark plug cap.
- Install the panel.

Periodic maintenance and adjustment

Engine oil and oil strainer

EAU62843

The engine oil level should be checked before each ride. In addition, the oil must be changed and the oil strainer cleaned at the intervals specified in the periodic maintenance and lubrication chart.

To check the engine oil level

1. Place the vehicle on the center-stand. A slight tilt to the side can result in a false reading.
2. Start the engine, warm it up for several minutes, and then turn it off.
3. Wait a few minutes until the oil settles, remove the oil filler cap, wipe the dipstick clean, insert it back into the oil filler hole (without screwing it in), and then remove it again to check the oil level.

WARNING

EWAL0031

The muffler and muffler protector become very hot during use. To avoid possible burns, let the muffler and protector cool before removing the oil filler cap.

TIP

The engine oil should be between the tip of the dipstick and maximum level mark.

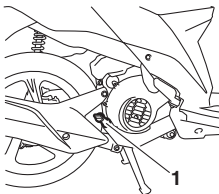

1. Engine oil filler cap

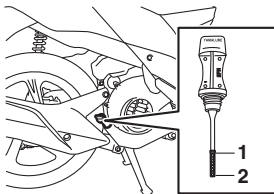

1. Maximum level mark
2. Tip of the engine oil dipstick

4. If the engine oil is at or below the minimum level mark, add sufficient oil of the recommended type to raise it to the correct level.
5. Insert the dipstick into the oil filler hole, and then tighten the oil filler cap.

To change the engine oil and clean the oil strainer

1. Start the engine, warm it up for several minutes, and then turn it off.
2. Place an oil pan under the engine to collect the used oil.
3. Remove the engine oil filler cap and drain bolt B to drain the oil from the crankcase. **NOTICE:** When removing the engine oil drain bolt, the O-ring, compression spring, and oil strainer will fall out. Take care not to lose these parts. [ECA11002]

Periodic maintenance and adjustment

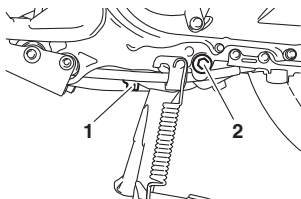

1. Engine oil drain bolt A
2. Engine oil drain bolt B

TIP

When only changing the engine oil, remove drain bolt A. When changing the engine oil and cleaning the engine oil strainer, remove drain bolt B also.

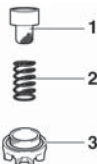

ZAUU0056

1. Oil strainer
 2. Compression spring
 3. O-ring
4. Clean the engine oil strainer with solvent, and then check it for damage and replace it if necessary.
 5. Install the engine oil strainer, compression spring, engine oil drain bolt with new O-ring, and then tighten the drain bolt to the specified torque.

TIP

Make sure that the O-ring is properly seated.

Tightening torque:

- Engine oil drain bolt A:
20 Nm (2.0 m·kgf, 14 ft·lbf)
- Engine oil drain bolt B:
20 Nm (2.0 m·kgf, 14 ft·lbf)

6. Refill with the specified amount of the recommended engine oil, and then install and tighten the oil filler cap.

Recommended engine oil:

See page 9-1.

Oil quantity:

0.80 L (0.85 US qt, 0.70 Imp.qt)

TIP

Be sure to wipe off spilled oil on any parts after the engine and exhaust system have cooled down.

ECA11621

NOTICE

- In order to prevent clutch slippage (since the engine oil also lubricates the clutch), do not mix any chemical additives. Do not use oils with a diesel specification of "CD" or oils of a higher quality than specified. In

Periodic maintenance and adjustment

addition, do not use oils labeled “ENERGY CONSERVING II” or higher.

- **Make sure that no foreign material enters the crankcase.**
7. Start the engine, and then let it idle for several minutes while checking it for oil leakage. If oil is leaking, immediately turn the engine off and check for the cause.
 8. Turn the engine off, and then check the oil level and correct it if necessary.

Final transmission oil

EAU60660

The final transmission case must be checked for oil leakage before each ride. If any leakage is found, have a Yamaha dealer check and repair the vehicle. In addition, the final transmission oil must be changed as follows at the intervals specified in the periodic maintenance and lubrication chart.

1. Start the engine, warm up the final transmission oil by riding the vehicle for several minutes, and then stop the engine.
2. Place the vehicle on the center-stand.
3. Place an oil pan under the final transmission case to collect the used oil.
4. Remove the final transmission oil filler cap and its O-ring from the final transmission case.

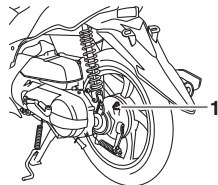

1. Final transmission oil filler cap

5. Remove the final transmission oil drain bolt and its gasket to drain the oil from the final transmission case.

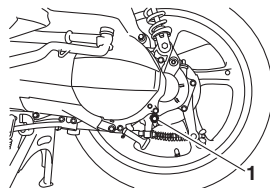

1. Final transmission oil drain bolt

Periodic maintenance and adjustment

6. Install the final transmission oil drain bolt and its new gasket, and then tighten the bolt to the specified torque.

Tightening torque:

Final transmission oil drain bolt:
13 Nm (1.3 m·kgf, 9.4 ft·lbf)

7. Refill with the specified amount of the recommended final transmission oil. **WARNING! Make sure that no foreign material enters the final transmission case. Make sure that no oil gets on the tire or wheel.** [EWA11312]

Recommended final transmission oil:

See page 9-1.

Oil quantity:

0.10 L (0.11 US qt, 0.09 Imp.qt)

8. Install the final transmission oil filler cap and its new O-ring, and then tighten the oil filler cap.
9. Check the final transmission case for oil leakage. If oil is leaking, check for the cause.

Air filter and V-belt case air filter elements

EAU60490

The air filter element should be replaced and the V-belt case air filter element should be cleaned at the intervals specified in the periodic maintenance and lubrication chart. Service the air filter elements more frequently if you are riding in unusually wet or dusty areas.

Checking and replacing the air filter element

1. Place the vehicle on the centerstand.
2. Remove the air filter case cover by removing the screws.

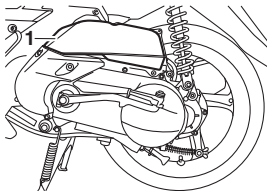

1. Air filter case cover

3. Remove the air filter element by pulling it out.

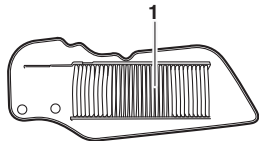

1. Air filter element

4. Check the air filter element for excessive dirt or damage and replace it if necessary.
5. Place the air filter element in its original position.
6. Install the air filter case cover by installing the screws.

Cleaning the V-belt case air filter element

1. Place the vehicle on the centerstand.
2. Remove the V-belt air filter case cover by removing the bolts.

Periodic maintenance and adjustment

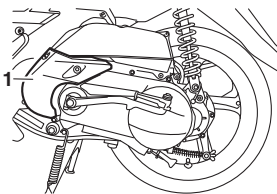

1. V-belt air filter case cover

3. Remove the element by pulling it out.

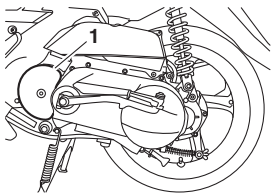

1. Air filter element

4. Clean the element with solvent, and then squeeze the remaining solvent out.
5. Check the element for damage and replace it if necessary.

6. Apply oil of the recommended type to the entire surface of the element, and then squeeze the excess oil out. **WARNING! Use only a dedicated parts cleaning solvent. To avoid the risk of fire or explosion, do not use gasoline or solvents with a low flash point.** [EWA10432] **NOTICE: To avoid damaging the air filter element, handle it gently and carefully, and do not twist it.** [ECA10522]

TIP

The element should be wet but not dripping.

Recommended oil:

Yamaha foam air filter oil or other quality foam air filter oil

7. Install the element into the filter case.
8. Place the air filter case cover in its original position, and then install the bolts. **NOTICE: Make sure that each filter element is properly seated in its case. The engine should never be operated without the filter elements in-**

stalled, otherwise the piston(s) and/or cylinder(s) may become excessively worn. [ECA10532]

Cleaning the air filter caps and check hose

1. Check each cap at the bottom of the air filter case and the hose at the bottom of the V-belt case for accumulated dirt or water.
2. If dirt or water is visible, remove the hose or caps from their clamp.
3. Drain dirt or water into a proper container.
4. Install the air filter check hose or caps to the original position.

TIP

The air filter check hose or caps need more frequent cleaning after riding in the rain, washing the vehicle, or in case of overturn. If the check hose or caps are clogged, have a Yamaha dealer service the vehicle.

Periodic maintenance and adjustment

Checking the engine idling speed

EAU44735

Check the engine idling speed and, if necessary, have it corrected by a Yamaha dealer.

Engine idling speed:
1500–1700 r/min

Adjusting the throttle grip free play

EAUJ0252

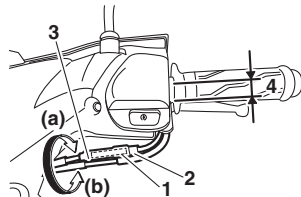

1. Throttle grip free play adjusting nut
2. Locknut
3. Rubber cover
4. Throttle grip free play

The throttle grip free play should measure 3.0–7.0 mm (0.12–0.28 in) at the inner edge of the throttle grip. Periodically check the throttle grip free play and, if necessary, adjust it as follows.

1. Slide the rubber cover back.
2. Loosen the locknut.
3. To increase the throttle grip free play, turn the adjusting nut in direction (a). To decrease the throttle grip free play, turn the adjusting nut in direction (b).

7-16

4. Tighten the locknut and then slide the rubber cover to its original position.

Periodic maintenance and adjustment

Valve clearance

The valve clearance changes with use, resulting in improper air-fuel mixture and/or engine noise. To prevent this from occurring, the valve clearance must be adjusted by a Yamaha dealer at the intervals specified in the periodic maintenance and lubrication chart.

EAU21402

Tires

Tires are the only contact between the vehicle and the road. Safety in all conditions of riding depends on a relatively small area of road contact. Therefore, it is essential to maintain the tires in good condition at all times and replace them at the appropriate time with the specified tires.

Tire air pressure

The tire air pressure should be checked and, if necessary, adjusted before each ride.

EAU70050

EWA10504



WARNING

Operation of this vehicle with improper tire pressure may cause severe injury or death from loss of control.

- The tire air pressure must be checked and adjusted on cold tires (i.e., when the temperature of the tires equals the ambient temperature).
- The tire air pressure must be adjusted in accordance with the riding speed and with the total

weight of rider, passenger, cargo, and accessories approved for this model.

Tire air pressure (measured on cold tires):

Front (1 person):
225kPa(2.25 kgf/cm², 33 psi)

Rear (1 person):
250kPa(2.50 kgf/cm², 36 psi)

Front (2 persons):
225kPa(2.25 kgf/cm², 33 psi)

Rear (2 persons):
250kPa(2.50 kgf/cm², 36 psi)

Maximum load*:

155 kg (342 lb)

* Total weight of rider, passenger, cargo and accessories

EWA10512



WARNING

Never overload your vehicle. Operation of an overloaded vehicle could cause an accident.

Periodic maintenance and adjustment

Tire inspection

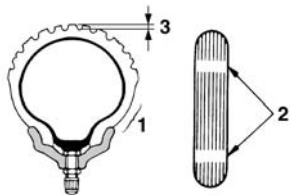

1. Tire sidewall
2. Tire wear indicator
3. Tire tread depth

The tires must be checked before each ride. If the tire shows crosswise lines (minimum tread depth), if the tire has a nail or glass fragments in it, or if the sidewall is cracked, have a Yamaha dealer replace the tire immediately.

Minimum tire tread depth (front and rear):
1.0 mm (0.04 in)

! WARNING

EWA10563

- It is dangerous to ride with a worn-out tire. When a tire tread begins to show crosswise lines, have a Yamaha dealer replace the tire immediately.
- The replacement of all wheel and brake-related parts, including the tires, should be left to a Yamaha dealer, who has the necessary professional knowledge and experience.
- It is not recommended to patch a punctured tube. If unavoidable, however, patch the tube very carefully and replace it as soon as possible with a high-quality product.
- Ride at moderate speeds after changing a tire since the tire surface must first be “broken in” for it to develop its optimal characteristics.

Tire information

This model is equipped with tube tires.

Tires age, even if they have not been used or have only been used occasionally. Cracking of the tread and sidewall rubber, sometimes accompanied by carcass deformation, is an evidence of ageing. Old and aged tires shall be checked by tire specialists to ascertain their suitability for further use.

EWA10462

! WARNING

The front and rear tires should be of the same make and design, otherwise the handling characteristics of the vehicle may be different, which could lead to an accident.

After extensive tests, only the tires listed below have been approved for this model by Yamaha.

Front tire:

Size:
70/90R-14M/C 34P
Manufacturer/model:
KENDA INDUSTRIAL CO. LTD

Rear tire:

Size:
90/80R-14M/C 49P
Manufacturer/model:
KENDA INDUSTRIAL CO. LTD

Periodic maintenance and adjustment

Cast wheels

To maximize the performance, durability, and safe operation of your vehicle, note the following points regarding the specified wheels.

- The wheel rims should be checked for cracks, bends, warpage or other damage before each ride. If any damage is found, have a Yamaha dealer replace the wheel. Do not attempt even the smallest repair to the wheel. A deformed or cracked wheel must be replaced.
- The wheel should be balanced whenever either the tire or wheel has been changed or replaced. An unbalanced wheel can result in poor performance, adverse handling characteristics, and a shortened tire life.

EALU21963

Checking the front brake lever free play

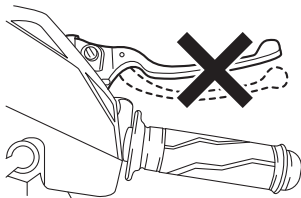

There should be no free play at the brake lever end. If there is free play, have a Yamaha dealer inspect the brake system.

WARNING

A soft or spongy feeling in the brake lever can indicate the presence of air in the hydraulic system. If there is air in the hydraulic system, have a Yamaha dealer bleed the system before operating the vehicle. Air in the hydraulic system will diminish the braking performance, which may result in loss of control and an accident.

EALU49351

EWA14212

Adjusting the rear brake lever free play

Measure the rear brake lever free play as shown.

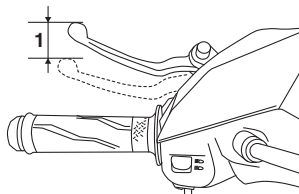

1. Rear brake lever free play

Rear brake lever free play:
15.0–20.0 mm (0.59–0.79 in)

Periodically check the brake lever free play and, if necessary, adjust it as follows.

To increase the brake lever free play, turn the adjusting nut at the brake shoe plate in direction (a). To decrease the brake lever free play, turn the adjusting nut in direction (b).

Periodic maintenance and adjustment

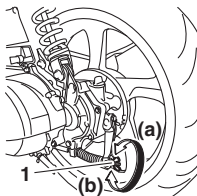

1. Rear brake lever free play adjusting nut

Make sure the rear brake lever lock pin properly latches and releases after the brake lever free play is adjusted.

EWA10651

WARNING

If proper adjustment cannot be obtained as described, have a Yamaha dealer make this adjustment.

Checking the front brake pads and rear brake shoes

EAU22382

The front brake pads and the rear brake shoes must be checked for wear at the intervals specified in the periodic maintenance and lubrication chart.

Front brake pads

EAU22432

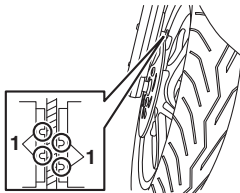

1. Front brake pad wear indicator groove

Each front brake pad is provided with wear indicator grooves, which allow you to check the brake pad wear without having to disassemble the brake. To check the brake pad wear, check the wear indicator grooves. If a brake pad has worn to the point that the wear

indicator grooves have almost disappeared, have a Yamaha dealer replace the brake pads as a set.

Rear brake shoes

EAU22541

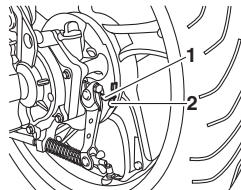

1. Brake shoe wear indicator
2. Brake shoe wear limit line

The rear brake is provided with a wear indicator, which allows you to check the brake shoe wear without having to disassemble the brake. To check the brake shoe wear, check the position of the wear indicator while applying the brake. If a brake shoe has worn to the point that the wear indicator reaches the wear limit line, have a Yamaha dealer replace the brake shoes as a set.

Periodic maintenance and adjustment

Checking the brake fluid level

EALU0831

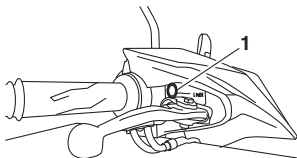

1. Minimum level mark

Insufficient brake fluid may allow air to enter the brake system, possibly causing it to become ineffective.

Before riding, check that the brake fluid is above the minimum level mark and replenish if necessary. A low brake fluid level may indicate worn brake pads and/or brake system leakage. If the brake fluid level is low, be sure to check the brake pads for wear and the brake system for leakage.

Observe these precautions:

- When checking the fluid level, make sure that the top of the master cylinder is level by turning the handlebars.

- Use only the recommended quality brake fluid, otherwise the rubber seals may deteriorate, causing leakage and poor braking performance.

Recommended brake fluid:

YAMAHA GENUINE BRAKE FLUID
or equivalent DOT3 or DOT4

- Refill with the same type of brake fluid. Mixing fluids may result in a harmful chemical reaction and lead to poor braking performance.
- Be careful that water does not enter the master cylinder when refilling. Water will significantly lower the boiling point of the fluid and may result in vapor lock.
- Brake fluid may deteriorate painted surfaces or plastic parts. Always clean up spilled fluid immediately.
- As the brake pads wear, it is normal for the brake fluid level to gradually go down. However, if the brake fluid level goes down suddenly, have a Yamaha dealer check the cause.

7-21

Changing the brake fluid

EALU22724

Have a Yamaha dealer change the brake fluid at the intervals specified in the periodic maintenance and lubrication chart. In addition, have the oil seals of the brake master cylinder and caliper as well as the brake hose replaced at the intervals listed below or whenever they are damaged or leaking.

- Oil seals: Replace every two years.
- Brake hose: Replace every four years.

Periodic maintenance and adjustment

Checking the V-belt

EAUJ0311

The V-belt must be checked and replaced by a Yamaha dealer at the intervals specified in the periodic maintenance and lubrication chart.

Checking and lubricating the cables

EAU23098

The operation of all control cables and the condition of the cables should be checked before each ride, and the cables and cable ends should be lubricated if necessary. If a cable is damaged or does not move smoothly, have a Yamaha dealer check or replace it. **WARNING! Damage to the outer housing of cables may result in internal rusting and cause interference with cable movement. Replace damaged cables as soon as possible to prevent unsafe conditions.**^[EWA10712]

Recommended lubricant:

Yamaha cable lubricant or other suitable cable lubricant

Checking and lubricating the throttle grip and cable

EAU23115

The operation of the throttle grip should be checked before each ride. In addition, the cable should be lubricated by a Yamaha dealer at the intervals specified in the periodic maintenance chart.

The throttle cable is equipped with a rubber cover. Make sure that the cover is securely installed. Even though the cover is installed correctly, it does not completely protect the cable from water entry. Therefore, use care not to pour water directly onto the cover or cable when washing the vehicle. If the cable or cover becomes dirty, wipe clean with a moist cloth.

Periodic maintenance and adjustment

Lubricating the front and rear brake levers

EAUJ43643

The pivoting points of the front and rear brake levers must be lubricated at the intervals specified in the periodic maintenance and lubrication chart.

Front brake lever

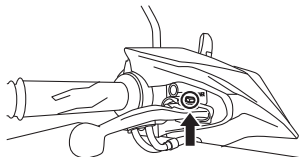

7

Rear brake lever

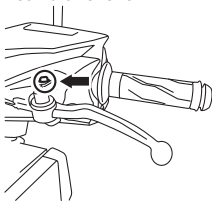

Recommended lubricants:

Front brake lever:

Silicone grease

Rear brake lever:

Lithium-soap-based grease

Checking and lubricating the centerstand and sidestand

EAU23215

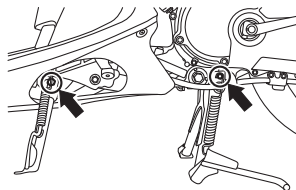

The operation of the centerstand and sidestand should be checked before each ride, and the pivots and metal-to-metal contact surfaces should be lubricated if necessary.

⚠ WARNING

EWA10742

If the centerstand or sidestand does not move up and down smoothly, have a Yamaha dealer check or repair it. Otherwise, the centerstand or sidestand could contact the ground and distract the operator, resulting in a possible loss of control.

Periodic maintenance and adjustment

Recommended lubricant:
Lithium-soap-based grease

EAU23273

Checking the front fork

The condition and operation of the front fork must be checked as follows at the intervals specified in the periodic maintenance and lubrication chart.

To check the condition

Check the inner tubes for scratches, damage and excessive oil leakage.

To check the operation

1. Place the vehicle on a level surface and hold it in an upright position. **WARNING! To avoid injury, securely support the vehicle so there is no danger of it falling over.** [EWA10752]
2. While applying the front brake, push down hard on the handlebars several times to check if the front fork compresses and rebounds smoothly.

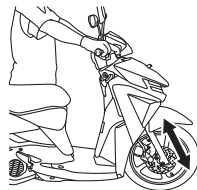

ECA10591

NOTICE

If any damage is found or the front fork does not operate smoothly, have a Yamaha dealer check or repair it.

Periodic maintenance and adjustment

Checking the steering

EAU45512

Worn or loose steering bearings may cause danger. Therefore, the operation of the steering must be checked as follows at the intervals specified in the periodic maintenance and lubrication chart.

1. Place the vehicle on the center-stand. **WARNING! To avoid injury, securely support the vehicle so there is no danger of it falling over.** [EWA10752]
2. Hold the lower ends of the front fork legs and try to move them forward and backward. If any free play can be felt, have a Yamaha dealer check or repair the steering.

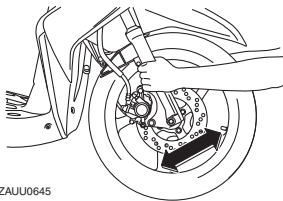

ZAUU0645

Checking the wheel bearings

EAU23292

The front and rear wheel bearings must be checked at the intervals specified in the periodic maintenance and lubrication chart. If there is play in the wheel hub or if the wheel does not turn smoothly, have a Yamaha dealer check the wheel bearings.

Battery

EAUJ0923

This model is equipped with a VRLA (Valve Regulated Lead Acid) battery. There is no need to check the electrolyte or to add distilled water. However, the battery lead connections need to be checked and, if necessary, tightened.

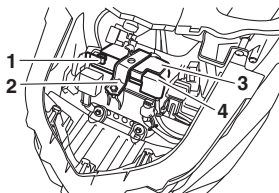

1. Negative battery lead (black)
2. Battery bracket
3. Battery
4. Positive battery lead (red)

EWA10761

WARNING

- **Electrolyte is poisonous and dangerous since it contains sulfuric acid, which causes severe burns. Avoid any contact with**

Periodic maintenance and adjustment

skin, eyes or clothing and always shield your eyes when working near batteries. In case of contact, administer the following FIRST AID.

- **EXTERNAL:** Flush with plenty of water.
- **INTERNAL:** Drink large quantities of water or milk and immediately call a physician.
- **EYES:** Flush with water for 15 minutes and seek prompt medical attention.
- Batteries produce explosive hydrogen gas. Therefore, keep sparks, flames, cigarettes, etc., away from the battery and provide sufficient ventilation when charging it in an enclosed space.
- **KEEP THIS AND ALL BATTERIES OUT OF THE REACH OF CHILDREN.**

To charge the battery

Have a Yamaha dealer charge the battery as soon as possible if it seems to have discharged. Keep in mind that the battery tends to discharge more quickly if the vehicle is equipped with optional electrical accessories.

ECA16522

NOTICE

To charge a VRLA (Valve Regulated Lead Acid) battery, a special (constant-voltage) battery charger is required. Using a conventional battery charger will damage the battery.

To store the battery

1. If the vehicle will not be used for more than one month, remove the battery, fully charge it, and then place it in a cool, dry place. **NOTICE:** When removing the battery, be sure the key is turned to “OFF”, then disconnect the negative lead before disconnecting the positive lead.

[ECA16303]

2. If the battery will be stored for more than two months, check it at least once a month and fully charge it if necessary.
3. Fully charge the battery before installation. **NOTICE:** When installing the battery, be sure the key is turned to “OFF”, then connect the positive lead before connecting the negative lead. [ECA16841]
4. After installation, make sure that the battery leads are properly connected to the battery terminals.

ECA16531

NOTICE

Always keep the battery charged. Storing a discharged battery can cause permanent battery damage.

ECAU0051

NOTICE

Do not ride the vehicle with the battery disconnected or with a low-charged battery. This will cause hard engine starting, decreased headlight life, and the flasher lights may not operate properly.

NOTICE

ECA10821

Never attempt to remove the battery cell seals, as this would permanently damage the battery.

Periodic maintenance and adjustment

Replacing the fuse

EAU23485

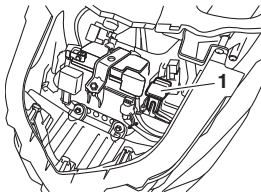

1. Fuse

The fuse holder is located under the seat. (See page 4-9.)

If the fuse is blown, replace it as follows.

1. Turn the key to "OFF" and turn off all electrical circuits.
2. Remove the blown fuse, and then install a new fuse of the specified amperage. **WARNING! Do not use a fuse of a higher amperage rating than recommended to avoid causing extensive damage to the electrical system and possibly a fire.** [EWA15132]

Specified fuse:
15.0 A

3. Turn the key to "ON" and turn on the electrical circuits to check if the devices operate.
4. If the fuse immediately blows again, have a Yamaha dealer check the electrical system.

EAU62850

Headlight

This model is equipped with an LED-type headlight.

If a headlight does not come on, have a Yamaha dealer check its electrical circuit.

ECA16581

NOTICE

Do not affix any type of tinted film or stickers to the headlight lens.

Periodic maintenance and adjustment

EAUW0345

Replacing an auxiliary light bulb

This model is equipped with two auxiliary lights. If an auxiliary light bulb burns out, replace it as follows.

1. Remove cowling A. (See page 7-8.)
2. Remove the auxiliary light socket (together with the bulb) by pulling it out.

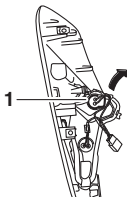

1. Auxiliary light bulb socket

3. Remove the burnt-out bulb by pulling it out.
4. Insert a new bulb into the socket.
5. Install the auxiliary light socket (together with the bulb) by pushing it in.
6. Install the cowling.

EAU4742

Replacing a front turn signal light bulb

1. Remove cowling A. (See page 7-8.)
2. Remove the turn signal light bulb socket (together with the bulb) by turning it counterclockwise.

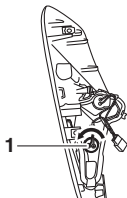

1. Turn signal light bulb socket

3. Remove the burnt-out bulb by pushing it in and turning it counterclockwise.
4. Insert a new bulb into the socket, push it in, and then turn it clockwise until it stops.
5. Install the socket (together with the bulb) by turning it clockwise.
6. Install the cowling.

7-28

EAUN0490

Replacing a tail/brake light bulb or a rear turn signal light bulb

If a tail/brake light bulb or a rear turn signal light bulb burns out, replace it as follows.

Tail/brake light bulb

1. Open the seat. (See page 4-9.)
2. Remove panel C. (See page 7-8)
3. Remove the bulb socket (together with the bulb) by turning it counterclockwise and pulling the tail-light bulb socket up at an angle.

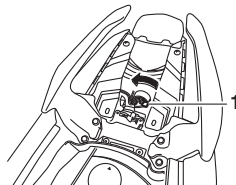

1. Tail/brake light bulb socket

4. Remove the burnt-out bulb by pushing it in and turning it counterclockwise.

Periodic maintenance and adjustment

5. Insert a new bulb into the socket by pushing it in and turn it clockwise until it stops.

ECAU0091

NOTICE

If a taillight bulb of different wattage than recommended is used, it may cause the battery to discharge or affect the taillight lighting.

6. Install the bulb socket (together with the bulb) by turning it clockwise.
7. Install the panel, and then close the seat.

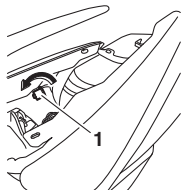

1. Rear turn signal light bulb
4. Remove the burnt-out bulb from the socket by pulling it out.
5. Insert a new bulb into the socket.

ECAU0081

NOTICE

If a turn signal light bulb of different wattage than recommended is used, the turn signal light flashing may be affected.

6. Install the bulb socket (together with the bulb) by turning it clockwise.
7. Install the panel, and then close the seat.

EALU25862

Troubleshooting

Although Yamaha scooters receive a thorough inspection before shipment from the factory, trouble may occur during operation. Any problem in the fuel, compression, or ignition systems, for example, can cause poor starting and loss of power.

The following troubleshooting chart represents a quick and easy procedure for checking these vital systems yourself. However, should your scooter require any repair, take it to a Yamaha dealer, whose skilled technicians have the necessary tools, experience, and know-how to service the scooter properly.

Use only genuine Yamaha replacement parts. Imitation parts may look like Yamaha parts, but they are often inferior, have a shorter service life and can lead to expensive repair bills.

EWA15142

WARNING

When checking the fuel system, do not smoke, and make sure there are no open flames or sparks in the area, including pilot lights from water

Rear turn signal light bulb

1. Open the seat. (See page 4-9.)
2. Remove panel C. (See page 7-8)
3. Remove the bulb socket (together with the bulb) by turning it counterclockwise.

Periodic maintenance and adjustment

heaters or furnaces. Gasoline or gasoline vapors can ignite or explode, causing severe injury or property damage.

Periodic maintenance and adjustment

EAUT1985

Troubleshooting chart

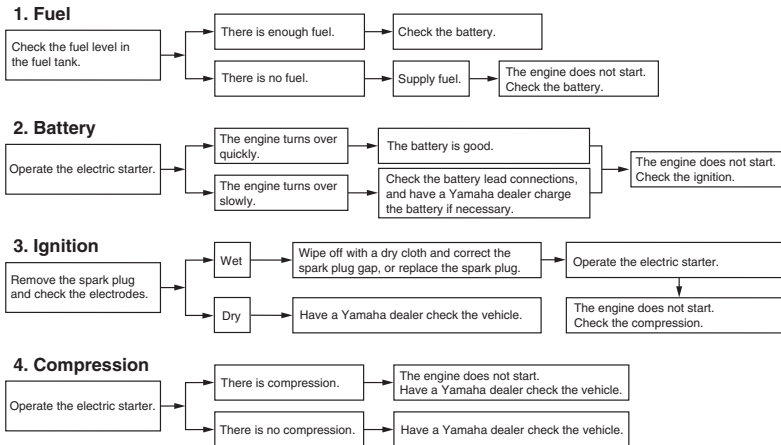

Scooter care and storage

Care

EAU0362

While the open design of a scooter reveals the attractiveness of the technology, it also makes it more vulnerable. Rust and corrosion can develop even if high-quality components are used. A rusty exhaust pipe may go unnoticed on a car, however, it detracts from the overall appearance of a scooter. Frequent and proper care does not only comply with the terms of the warranty, but it will also keep your scooter looking good, extend its life and optimize its performance.

Before cleaning

1. Cover the muffler outlet with a plastic bag after the engine has cooled down.
2. Make sure that all caps and covers as well as all electrical couplers and connectors, including the spark plug cap, are tightly installed.
3. Remove extremely stubborn dirt, like oil burnt onto the crankcase, with a degreasing agent and a brush, but never apply such prod-

ucts onto seals, gaskets and wheel axles. Always rinse the dirt and degreaser off with water.

Cleaning

ECA10784

NOTICE

- **Avoid using strong acidic wheel cleaners, especially on spoked wheels. If such products are used on hard-to-remove dirt, do not leave the cleaner on the affected area any longer than instructed. Also, thoroughly rinse the area off with water, immediately dry it, and then apply a corrosion protection spray.**
- **Improper cleaning can damage plastic parts (such as cowlings, panels, windshields, headlight lenses, meter lenses, etc.) and the mufflers. Use only a soft, clean cloth or sponge with water to clean plastic. However, if the plastic parts cannot be thoroughly cleaned with water, diluted mild detergent with water may be used. Be sure to rinse off any detergent residue using plenty of water, as it is harmful to plastic parts.**
- **Do not use any harsh chemical products on plastic parts. Be sure to avoid using cloths or sponges which have been in contact with strong or abrasive cleaning products, solvent or thinner, fuel (gasoline), rust removers or inhibitors, brake fluid, antifreeze or electrolyte.**
- **Do not use high-pressure washers or steam-jet cleaners since they cause water seepage and deterioration in the following areas: seals (of wheel and swing-arm bearings, fork and brakes), electric components (couplers, connectors, instruments, switches and lights), breather hoses and vents.**
- **For scooters equipped with a windshield: Do not use strong cleaners or hard sponges as they will cause dulling or scratching. Some cleaning compounds for plastic may leave scratches on the wind-**

Scooter care and storage

shield. Test the product on a small hidden part of the windshield to make sure that it does not leave any marks. If the windshield is scratched, use a quality plastic polishing compound after washing.

After normal use

Remove dirt with warm water, a mild detergent, and a soft, clean sponge, and then rinse thoroughly with clean water. Use a toothbrush or bottlebrush for hard-to-reach areas. Stubborn dirt and insects will come off more easily if the area is covered with a wet cloth for a few minutes before cleaning.

After riding in the rain or near the sea
Since sea salt is extremely corrosive carry out the following steps after each ride in the rain or near the sea.

1. Clean the scooter with cold water and a mild detergent after the engine has cooled down. **NOTICE:** Do not use warm water since it increases the corrosive action of the salt. [ECA10792]

2. Apply a corrosion protection spray on all metal, including chrome- and nickel-plated, surfaces to prevent corrosion.

After cleaning

1. Dry the scooter with a chamois or an absorbing cloth.
2. Use a chrome polish to shine chrome, aluminum and stainless-steel parts, including the exhaust system. (Even the thermally induced discoloring of stainless-steel exhaust systems can be removed through polishing.)
3. To prevent corrosion, it is recommended to apply a corrosion protection spray on all metal, including chrome- and nickel-plated, surfaces.
4. Use spray oil as a universal cleaner to remove any remaining dirt.
5. Touch up minor paint damage caused by stones, etc.
6. Wax all painted surfaces.
7. Let the scooter dry completely before storing or covering it.

WARNING

Contaminants on the brakes or tires can cause loss of control.

- Make sure that there is no oil or wax on the brakes or tires. If necessary, clean the brake discs and brake linings with a regular brake disc cleaner or acetone, and wash the tires with warm water and a mild detergent.
- Before operating the scooter test its braking performance and cornering behavior.

NOTICE

- Apply spray oil and wax sparingly and make sure to wipe off any excess.
- Never apply oil or wax to any rubber parts, plastic parts or headlight, taillight and meter lenses, but treat them with a suitable care product.
- Avoid using abrasive polishing compounds as they will wear away the paint.

EWA10943

ECAU0022

TIP

- Consult a Yamaha dealer for advice on what products to use.
- Washing, rainy weather or humid climates can cause the headlight lens to fog. Turning the headlight on for a short period of time will help remove the moisture from the lens.

Storage

EALJ36564

Short-term

Always store your scooter in a cool, dry place and, if necessary, protect it against dust with a porous cover. Be sure the engine and the exhaust system are cool before covering the scooter.

ECA10821

NOTICE

- **Storing the scooter in a poorly ventilated room or covering it with a tarp, while it is still wet, will allow water and humidity to seep in and cause rust.**
- **To prevent corrosion, avoid damp cellars, stables (because of the presence of ammonia) and areas where strong chemicals are stored.**

Long-term

Before storing your scooter for several months:

1. Follow all the instructions in the “Care” section of this chapter.

2. Fill up the fuel tank and add fuel stabilizer (if available) to prevent the fuel tank from rusting and the fuel from deteriorating.
3. Perform the following steps to protect the cylinder, piston rings, etc. from corrosion.
 - a. Remove the spark plug cap and spark plug.
 - b. Pour a teaspoonful of engine oil into the spark plug bore.
 - c. Install the spark plug cap onto the spark plug, and then place the spark plug on the cylinder head so that the electrodes are grounded. (This will limit sparking during the next step.)
 - d. Turn the engine over several times with the starter. (This will coat the cylinder wall with oil.)
 - e. Remove the spark plug cap from the spark plug, and then install the spark plug and the spark plug cap. **WARNING! To prevent damage or injury from sparking, make sure to ground the spark plug electrodes while turning the engine over.** [EWA10952]

Scooter care and storage

4. Lubricate all control cables and the pivoting points of all levers and pedals as well as of the side-stand/centerstand.
5. Check and, if necessary, correct the tire air pressure, and then lift the scooter so that both of its wheels are off the ground. Alternatively, turn the wheels a little every month in order to prevent the tires from becoming degraded in one spot.
6. Cover the muffler outlet with a plastic bag to prevent moisture from entering it.
7. Remove the battery and fully charge it. Store it in a cool, dry place and charge it once a month. Do not store the battery in an excessively cold or warm place [less than 0 °C (30 °F) or more than 30 °C (90 °F)]. For more information on storing the battery, see page 7-25.

TIP

Make any necessary repairs before storing the scooter.

Specifications

Dimensions:

- Overall length:
1870 mm (73.6 in)
- Overall width:
685 mm (27.0 in)
- Overall height:
1070 mm (42.1 in)
- Seat height:
773 mm (30.4 in)
- Wheelbase:
1260 mm (49.6 in)
- Ground clearance:
135 mm (5.31 in)
- Minimum turning radius:
1.9 m (6.23 ft)

Weight:

- Curb weight:
96 kg (212 lb)

Engine:

- Combustion cycle:
4-stroke
- Cooling system:
Air cooled
- Valve train:
SOHC
- Number of cylinders:
Single cylinder
- Displacement:
125 cm³
- Bore × stroke:
52.4 × 57.9 mm (2.06 × 2.28 in)
- Compression ratio:
9.5 : 1

- Starting system:
Electric starter and kickstarter
- Lubrication system:
Wet sump

Engine oil:

- Recommended brand:
YAMALUBE
- SAE viscosity grades:
10W-40
- Recommended engine oil grade:
API service SG type or higher, JASO
standard MA or MB
- Engine oil quantity:
Oil change:
0.80 L (0.85 US qt, 0.70 Imp.qt)

Final transmission oil:

- Type:
Motor oil SAE 10W-40 type SG or higher
- Quantity:
0.10 L (0.11 US qt, 0.09 Imp.qt)

Air filter:

- Air filter element:
Oil-coated paper element

Fuel:

- Recommended fuel:
Regular unleaded gasoline (Gasohol [E10]
acceptable)
- Fuel tank capacity:
4.2 L (1.1 US gal, 0.9 Imp.gal)

Fuel injection:

- Throttle body:
ID mark:
2PH1 00

Spark plug(s):

- Manufacturer/model:
NGK/CR6HSA
- Spark plug gap:
0.6–0.7 mm (0.024–0.028 in)

Clutch:

- Clutch type:
Dry, centrifugal, shoe

Drivetrain:

- Primary reduction ratio:
1.000
- Final drive:
Gear
- Secondary reduction ratio:
10.156 (50/16 × 39/12)
- Transmission type:
V-belt automatic

Chassis:

- Frame type:
Underbone
- Caster angle:
26.5 °
- Trail:
100 mm (3.9 in)

Front tire:

- Type:
Tubeless
- Size:
70/90R-14M/C 34P
- Manufacturer/model:
KENDA INDUSTRIAL CO.LTD

Rear tire:

- Type:
Tubeless

Specifications

Size:

90/80 - 14M/C 49P

Manufacturer/model:

KENDA INDUSTRIAL CO. LTD

Loading:

Maximum load:

155 kg (342 lb)

(Total weight of rider, passenger, cargo and accessories)

Tire air pressure (measured on cold tires):

1 person:

Front:

200 kPa (2.00 kgf/cm², 29 psi)

Rear:

225 kPa (2.25 kgf/cm², 33 psi)

2 persons:

Front:

200 kPa (2.00 kgf/cm², 29 psi)

Rear:

225 kPa (2.25 kgf/cm², 33 psi)

Front wheel:

Wheel type:

Cast wheel

Rim size:

14X1.60

Rear wheel:

Rim size:

14X2.50

Front brake:

Type:

Hydraulic single disc brake

Specified brake fluid:

DOT 3 or 4

Rear brake:

Type:

Mechanical leading trailing drum brake

Front suspension:

Type:

Telescopic fork

Spring:

Coil spring

Shock absorber:

Hydraulic damper

Wheel travel:

90 mm (3.5 in)

Rear suspension:

Type:

Unit swing

Spring:

Coil spring

Shock absorber:

Hydraulic damper

Wheel travel:

80 mm (3.1 in)

Electrical system:

System voltage:

12 V

Ignition system:

TCI

Charging system:

AC magneto

Battery:

Model:

GTZ4V

Model:

YTZ4V

Voltage, capacity:

12 V, 3.0 Ah (10 HR)

Voltage, capacity:

12 V, 3.0 Ah (10 HR)

Bulb wattage x quantity:

Headlight:

LED

Brake/tail light:

21.0 W/5.0 W x 1

Front turn signal light:

10.0 W x 2

Rear turn signal light:

10.0 W x 2

Auxiliary light:

5.0 W x 2

Meter lighting:

1.7 W x 1

Meter lighting (fuel meter):

1.7 W x 1

High beam indicator light:

1.7 W x 1

Turn signal indicator light:

1.7 W x 1

Engine trouble warning light:

1.7 W x 1

Fuse(s):

Main fuse:

15.0 A

Sub fuse:

10.0 A

Consumer information

Identification numbers

EAU26364

Record the vehicle identification number and the engine serial number in the spaces provided below for assistance when ordering spare parts from a Yamaha dealer or for reference in case the vehicle is stolen.

VEHICLE IDENTIFICATION NUMBER:

ENGINE SERIAL NUMBER:

Vehicle identification number

EAU26411

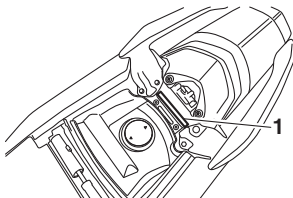

1. Vehicle identification number

The vehicle identification number is stamped into the frame.

TIP

The vehicle identification number is used to identify your vehicle and may be used to register it with the licensing authority in your area.

Engine serial number

EAU26442

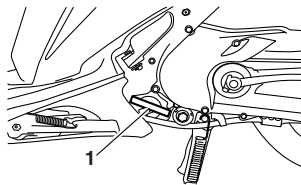

1. Engine serial number

The engine serial number is stamped into the crankcase.

Index

A

- Acceleration and deceleration 6-2
- Air filter and V-belt case air filter elements 7-14
- Auxiliary light bulb, replacing 7-28

B

- Battery 7-25
- Brake fluid, changing 7-21
- Brake fluid level, checking 7-21
- Brake lever, front 4-5
- Brake lever, rear 4-5
- Brake levers, lubricating 7-23
- Brake pads and shoes, checking 7-20
- Braking 6-2

C

- Cables, checking and lubricating 7-22
- Care 8-1
- Catalytic converter 4-8
- Centerstand and sidestand, checking and lubricating 7-23
- Convenience hook 4-10
- Cowling and panels, removing and installing 7-8

D

- Dimmer switch 4-4

E

- Eco indicator light 4-3
- Engine break-in 6-3
- Engine idling speed, checking 7-16
- Engine oil and oil strainer 7-11
- Engine serial number 10-1
- Engine trouble warning light 4-3

F

- Final transmission oil 7-13

- Front brake lever free play, checking ... 7-19
- Front fork, checking 7-24
- Fuel 4-7
- Fuel tank cap 4-6
- Fuse, replacing 7-27

G

- General note 6-4

H

- Handlebar switches 4-4
- Headlight 7-27
- Helmet holders 4-10
- Helmets 2-6
- High beam indicator light 4-3
- Horn switch 4-4

I

- Identification numbers 10-1
- Ignition circuit cut-off system 4-12
- Indicator lights and warning light 4-3

K

- Keyhole shutter 4-2
- Kickstarter 4-9

L

- Labels, location 1-1

M

- Main switch/steering lock 4-1
- Maintenance and lubrication, periodic ... 7-3
- Maintenance, emission control system 7-2

P

- Parking 6-3
- Part locations 3-1

R

- Rear brake lever free play, adjusting 7-19
- Rear brake lever lock 4-5

S

- Safe-riding points 2-5
- Safety information 2-1
- Seat 4-9
- Sidestand 4-11
- Spark plug, checking 7-9
- Specifications 9-1
- Speedometer unit 4-4
- Starting the engine 6-1
- Start switch 4-4
- Steering, checking 7-25
- Storage 8-3
- Storage compartment 4-11

T

- Tail/brake light bulb or rear turn signal light bulb, replacing 7-28
- Throttle grip and cable, checking and lubricating 7-22
- Throttle grip free play, adjusting 7-16
- Tires 7-17
- Tool kit 7-1
- Troubleshooting 7-29
- Troubleshooting chart 7-31
- Turn signal indicator lights 4-3
- Turn signal light bulb (front), replacing 7-28
- Turn signal switch 4-4

V

- Valve clearance 7-17
- V-belt, checking 7-22
- Vehicle identification number 10-1

W

- Wheel bearings, checking 7-25
- Wheels 7-19

www.yamaha-motor.com.my

YAMALUBE®



Pelincir Tulen Yamaha



PELINCIR MOTOSIKAL BERPRESTASI TINGGI

PRINTED IN MALAYSIA