



 Read this manual carefully before operating this vehicle.

OWNER'S MANUAL

R25

YZF250

B4P-F8199-30

EAU46091

 **Read this manual carefully before operating this vehicle. This manual should stay with this vehicle if it is sold.**

EAU46091

 **在使用这电单车以前，请充分使用这小手册。这手册须付与电单车一起。**

EAU46091

 **Baca buku panduan dengan teliti sebelum mengendalikan motosikal ini. Buku panduan diberi bersama dengan pembelian motosikal.**

Welcome to the Yamaha world of motorcycling!

As the owner of the YZF250, you are benefiting from Yamaha's vast experience and newest technology regarding the design and manufacture of high-quality products, which have earned Yamaha a reputation for dependability.

Please take the time to read this manual thoroughly, so as to enjoy all advantages of your YZF250. The Owner's Manual does not only instruct you in how to operate, inspect and maintain your motorcycle, but also in how to safeguard yourself and others from trouble and injury.

In addition, the many tips given in this manual will help keep your motorcycle in the best possible condition. If you have any further questions, do not hesitate to contact your Yamaha dealer.

The Yamaha team wishes you many safe and pleasant rides. So, remember to put safety first!

Yamaha continually seeks advancements in product design and quality. Therefore, while this manual contains the most current product information available at the time of printing, there may be minor discrepancies between your motorcycle and this manual. If there is any question concerning this manual, please consult a Yamaha dealer.







Please read this manual carefully and completely before operating this motorcycle.

Important manual information

EAU10134

Particularly important information is distinguished in this manual by the following notations:

| | |
|---|---|
|  | This is the safety alert symbol. It is used to alert you to potential personal injury hazards. Obey all safety messages that follow this symbol to avoid possible injury or death. |
|  | A WARNING indicates a hazardous situation which, if not avoided, could result in death or serious injury. |
|  | A NOTICE indicates special precautions that must be taken to avoid damage to the vehicle or other property. |
|  | A TIP provides key information to make procedures easier or clearer. |

*Product and specifications are subject to change without notice.



EALJ0012

**YZF250
OWNER'S MANUAL
©2019 by Yamaha Motor Co., Ltd.
1st edition, March 2019
All rights reserved.
Any reprinting or unauthorized use
without the written permission of
Yamaha Motor Co., Ltd.
is expressly prohibited.
Printed in Malaysia**

Table of contents

| | | | | | |
|---|------|--|------|--|------|
| Location of important labels | 1-1 | Luggage strap holders..... | 4-19 | Tires..... | 7-17 |
| Safety information | 2-1 | Sidestand..... | 4-19 | Cast wheels..... | 7-19 |
| Helmets..... | 2-5 | Starting circuit cut-off system..... | 4-20 | Adjusting the clutch lever free play..... | 7-19 |
| Description | 3-1 | For your safety – pre-operation checks | 5-1 | Checking the brake lever free play..... | 7-21 |
| Left view..... | 3-1 | Operation and important riding points | 6-1 | Brake light switches..... | 7-22 |
| Right view..... | 3-2 | Starting the engine..... | 6-2 | Checking the front and rear brake pads..... | 7-22 |
| Controls and instruments..... | 3-3 | Shifting..... | 6-2 | Checking the brake fluid level..... | 7-23 |
| Instrument and control functions ... 4-1 | | Tips for reducing fuel consumption..... | 6-3 | Changing the brake fluid..... | 7-24 |
| Main switch/steering lock..... | 4-1 | Engine break-in..... | 6-3 | Drive chain slack..... | 7-25 |
| Indicator lights and warning lights..... | 4-2 | Parking..... | 6-4 | Cleaning and lubricating the drive chain..... | 7-26 |
| Multi-function meter unit..... | 4-4 | Periodic maintenance and adjustment | 7-1 | Checking and lubricating the cables..... | 7-27 |
| Handlebar switches..... | 4-10 | Owner's tool kit..... | 7-1 | Checking and lubricating the throttle grip and cable..... | 7-27 |
| Clutch lever..... | 4-12 | Periodic maintenance chart for the emission control system..... | 7-3 | Checking and lubricating the brake and shift pedals..... | 7-28 |
| Shift pedal..... | 4-12 | General maintenance and lubrication chart..... | 7-5 | Checking and lubricating the brake and clutch levers..... | 7-28 |
| Brake lever..... | 4-12 | Checking the spark plugs..... | 7-9 | Checking and lubricating the sidestand..... | 7-29 |
| Brake pedal..... | 4-13 | Engine oil and oil filter cartridge... 7-10 | | Lubricating the swingarm pivots..... | 7-29 |
| Fuel tank cap..... | 4-13 | Coolant..... | 7-13 | Checking the front fork..... | 7-30 |
| Fuel..... | 4-14 | Replacing the air filter element and cleaning the check hose..... | 7-15 | Checking the steering..... | 7-30 |
| Fuel tank breather hose and overflow hose..... | 4-15 | Checking the throttle grip free play..... | 7-17 | Checking the wheel bearings..... | 7-31 |
| Catalytic converter..... | 4-15 | Valve clearance..... | 7-17 | Battery..... | 7-31 |
| Seats..... | 4-16 | | | Replacing the fuses..... | 7-32 |
| Helmet holders..... | 4-17 | | | | |
| Storage compartment..... | 4-18 | | | | |
| Rear view mirrors..... | 4-18 | | | | |
| Adjusting the shock absorber assembly..... | 4-18 | | | | |

Table of contents

| | |
|---|-------------|
| Vehicle lights | 7-34 |
| Replacing a turn signal light bulb | 7-34 |
| Replacing the license plate light bulb | 7-35 |
| Supporting the motorcycle..... | 7-36 |
| Front wheel..... | 7-36 |
| Rear wheel..... | 7-37 |
| Troubleshooting | 7-39 |
| Troubleshooting charts | 7-41 |
| Motorcycle care and storage | 8-1 |
| Matte color caution | 8-1 |
| Care..... | 8-1 |
| Storage..... | 8-3 |
| Specifications..... | 9-1 |
| Consumer information | 10-1 |
| Identification numbers..... | 10-1 |
| Vehicle data recording | 10-2 |
| Index | 11-1 |

Location of important labels

EAUN2190

1

Read and understand all of the labels on your vehicle. They contain important information for safe and proper operation of your vehicle. Never remove any labels from your vehicle.

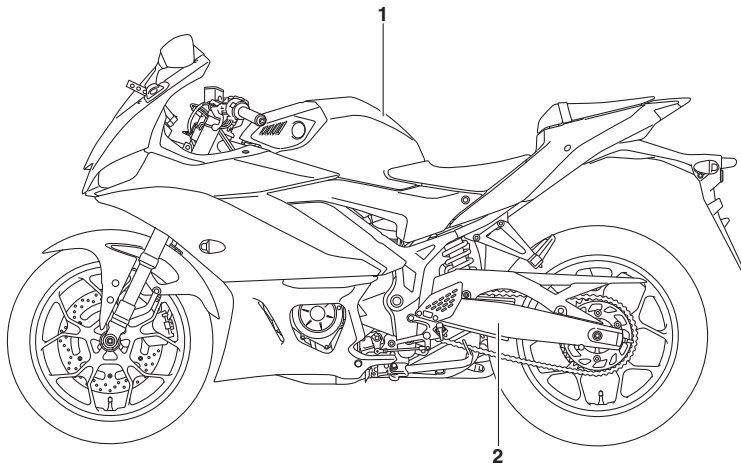

Location of important labels

1

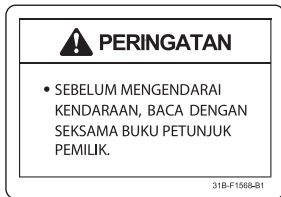

2

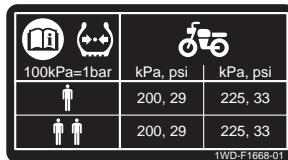

1

Safety information

EALJ1028C

2

Be a Responsible Owner

As the vehicle's owner, you are responsible for the safe and proper operation of your motorcycle.

Motorcycles are single-track vehicles.

Their safe use and operation are dependent upon the use of proper riding techniques as well as the expertise of the operator. Every operator should know the following requirements before riding this motorcycle.

He or she should:

- Obtain thorough instructions from a competent source on all aspects of motorcycle operation.
- Observe the warnings and maintenance requirements in this Owner's Manual.
- Obtain qualified training in safe and proper riding techniques.
- Obtain professional technical service as indicated in this Owner's Manual and/or when made necessary by mechanical conditions.

- Never operate a motorcycle without proper training or instruction. Take a training course. Beginners should receive training from a certified instructor. Contact an authorized motorcycle dealer to find out about the training courses nearest you.

Safe Riding

Perform the pre-operation checks each time you use the vehicle to make sure it is in safe operating condition. Failure to inspect or maintain the vehicle properly increases the possibility of an accident or equipment damage. See page 5-1 for a list of pre-operation checks.

- This motorcycle is designed to carry the operator and a passenger.
- The failure of motorists to detect and recognize motorcycles in traffic is the predominating cause of automobile/motorcycle accidents. Many accidents have been caused by an automobile driver who did not see the motorcycle. Making yourself conspicuous ap-

pears to be very effective in reducing the chance of this type of accident.

Therefore:

- Wear a brightly colored jacket.
- Use extra caution when you are approaching and passing through intersections, since intersections are the most likely places for motorcycle accidents to occur.
- Ride where other motorists can see you. Avoid riding in another motorist's blind spot.
- Never maintain a motorcycle without proper knowledge. Contact an authorized motorcycle dealer to inform you on basic motorcycle maintenance. Certain maintenance can only be carried out by certified staff.

- Many accidents involve inexperienced operators. In fact, many operators who have been involved in accidents do not even have a current motorcycle license.
 - Make sure that you are qualified and that you only lend your motorcycle to other qualified operators.
 - Know your skills and limits. Staying within your limits may help you to avoid an accident.
 - We recommend that you practice riding your motorcycle where there is no traffic until you have become thoroughly familiar with the motorcycle and all of its controls.
- Many accidents have been caused by error of the motorcycle operator. A typical error made by the operator is veering wide on a turn due to excessive speed or undercornering (insufficient lean angle for the speed).
 - Always obey the speed limit and never travel faster than warranted by road and traffic conditions.
 - Always signal before turning or changing lanes. Make sure that other motorists can see you.
- The posture of the operator and passenger is important for proper control.
 - The operator should keep both hands on the handlebar and both feet on the operator footrests during operation to maintain control of the motorcycle.
 - The passenger should always hold onto the operator, the seat strap or grab bar, if equipped, with both hands and keep both feet on the passenger footrests. Never carry a passenger unless he or she can firmly place both feet on the passenger footrests.
- Never ride under the influence of alcohol or other drugs.
- This motorcycle is designed for on-road use only. It is not suitable for off-road use.

Protective Apparel

The majority of fatalities from motorcycle accidents are the result of head injuries. The use of a safety helmet is the single most critical factor in the prevention or reduction of head injuries.

- Always wear an approved helmet.
- Wear a face shield or goggles. Wind in your unprotected eyes could contribute to an impairment of vision that could delay seeing a hazard.
- The use of a jacket, heavy boots, trousers, gloves, etc., is effective in preventing or reducing abrasions or lacerations.
- Never wear loose-fitting clothes, otherwise they could catch on the control levers, footrests, or wheels and cause injury or an accident.
- Always wear protective clothing that covers your legs, ankles, and feet. The engine or exhaust system become very hot during or after operation and can cause burns.
- A passenger should also observe the above precautions.

Safety information

Avoid Carbon Monoxide Poisoning

All engine exhaust contains carbon monoxide, a deadly gas. Breathing carbon monoxide can cause headaches, dizziness, drowsiness, nausea, confusion, and eventually death.

Carbon Monoxide is a colorless, odorless, tasteless gas which may be present even if you do not see or smell any engine exhaust. Deadly levels of carbon monoxide can collect rapidly and you can quickly be overcome and unable to save yourself. Also, deadly levels of carbon monoxide can linger for hours or days in enclosed or poorly ventilated areas. If you experience any symptoms of carbon monoxide poisoning, leave the area immediately, get fresh air, and SEEK MEDICAL TREATMENT.

- Do not run engine indoors. Even if you try to ventilate engine exhaust with fans or open windows and doors, carbon monoxide can rapidly reach dangerous levels.
- Do not run engine in poorly ventilated or partially enclosed areas such as barns, garages, or carports.

- Do not run engine outdoors where engine exhaust can be drawn into a building through openings such as windows and doors.

Loading

Adding accessories or cargo to your motorcycle can adversely affect stability and handling if the weight distribution of the motorcycle is changed. To avoid the possibility of an accident, use extreme caution when adding cargo or accessories to your motorcycle. Use extra care when riding a motorcycle that has added cargo or accessories. Here, along with the information about accessories below, are some general guidelines to follow if loading cargo to your motorcycle:

The total weight of the operator, passenger, accessories and cargo must not exceed the maximum load limit.

Operation of an overloaded vehicle could cause an accident.

| |
|---|
| <p>Maximum load: 160 kg (353 lb)</p> |
|---|

When loading within this weight limit, keep the following in mind:

- Cargo and accessory weight should be kept as low and close to the motorcycle as possible. Securely pack your heaviest items as close to the center of the vehicle as possible and make sure to distribute the weight as evenly as possible on both sides of the motorcycle to minimize imbalance or instability.
- Shifting weights can create a sudden imbalance. Make sure that accessories and cargo are securely attached to the motorcycle before riding. Check accessory mounts and cargo restraints frequently.
- Properly adjust the suspension for your load (suspension-adjustable models only), and check the condition and pressure of your tires.
- Never attach any large or heavy items to the handlebar, front fork, or front fender. These items, including such cargo as sleeping bags, duffel bags, or

tents, can create unstable handling or a slow steering response.

- **This vehicle is not designed to pull a trailer or to be attached to a sidecar.**

Genuine Yamaha Accessories

Choosing accessories for your vehicle is an important decision. Genuine Yamaha accessories, which are available only from a Yamaha dealer, have been designed, tested, and approved by Yamaha for use on your vehicle.

Many companies with no connection to Yamaha manufacture parts and accessories or offer other modifications for Yamaha vehicles. Yamaha is not in a position to test the products that these aftermarket companies produce. Therefore, Yamaha can neither endorse nor recommend the use of accessories not sold by Yamaha or modifications not specifically recommended by Yamaha, even if sold and installed by a Yamaha dealer.

Aftermarket Parts, Accessories, and Modifications

While you may find aftermarket products similar in design and quality to genuine Yamaha accessories, recognize that some aftermarket accessories or modifications are not suitable because of potential safety hazards to you or others. Installing aftermarket products or having other modifications performed to your vehicle that change any of the vehicle's design or operation characteristics can put you and others at greater risk of serious injury or death. You are responsible for injuries related to changes in the vehicle.

Keep the following guidelines in mind, as well as those provided under "Loading" when mounting accessories.

- Never install accessories or carry cargo that would impair the performance of your motorcycle. Carefully inspect the accessory before using it to make sure that it does not in any way reduce ground clearance or cornering clearance, limit suspension travel,

steering travel or control operation, or obscure lights or reflectors.

- Accessories fitted to the handlebar or the front fork area can create instability due to improper weight distribution or aerodynamic changes. If accessories are added to the handlebar or front fork area, they must be as lightweight as possible and should be kept to a minimum.
- Bulky or large accessories may seriously affect the stability of the motorcycle due to aerodynamic effects. Wind may attempt to lift the motorcycle, or the motorcycle may become unstable in cross winds. These accessories may also cause instability when passing or being passed by large vehicles.
- Certain accessories can displace the operator from his or her normal riding position. This improper position limits the freedom of movement of the

Safety information

EALN0213

2

operator and may limit control ability, therefore, such accessories are not recommended.

- Use caution when adding electrical accessories. If electrical accessories exceed the capacity of the motorcycle's electrical system, an electric failure could result, which could cause a dangerous loss of lights or engine power.

Aftermarket Tires and Rims

The tires and rims that came with your motorcycle were designed to match the performance capabilities and to provide the best combination of handling, braking, and comfort. Other tires, rims, sizes, and combinations may not be appropriate. See page 7-17 for tire specifications and for information on servicing and replacing your tires.

Transporting the Motorcycle

Be sure to observe following instructions before transporting the motorcycle in another vehicle.

- Remove all loose items from the motorcycle.
- Check that the fuel cock (if equipped) is in the off position and that there are no fuel leaks.
- Shift the transmission into gear (for models with a manual transmission).
- Secure the motorcycle with tie-downs or suitable straps that are attached to solid parts of the motorcycle, such as the frame or upper front fork triple clamp (and not, for example, to rubber-mounted handlebars or turn signals, or parts that could break). Choose the location for the straps carefully so the straps will not rub against painted surfaces during transport.
- The suspension should be compressed somewhat by the tie-downs, if possible, so that the motorcycle will not bounce excessively during transport.

Helmets

Operating this vehicle without an approved motorcycle helmet increases your chances of a severe head injury or death in the event of an accident. The majority of fatalities from motorcycle or scooter accidents are the result of head injuries. The use of a safety helmet is the single most critical factor in the prevention or reduction of head injuries.

Always select an approved motorcycle helmet

Pay attention to the following when choosing a motorcycle helmet.

- The helmet must meet the safety standard "SNI".
- The helmet size must match the size of the rider's head.
- Never subject a helmet to heavy shocks.

Wearing the helmet correctly

Always connect the chin strap. In the case of an accident, the helmet has a much less chance of coming off if the chin strap is connected.

Correct usage



ZAUU0003



ZAUU0005

Wrong usage



ZAUU0007

- Full-face-type: use for riding at mid-range to high speeds



ZAUU0006

Types of helmets and their usage

- Full-type: use only for riding at low to mid-range speeds

Description

EAU10411

Left view

3

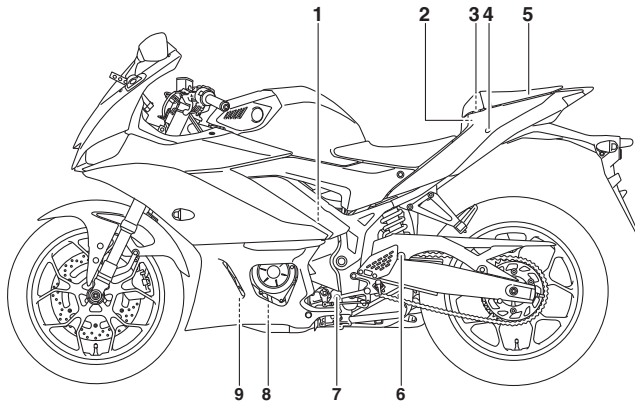

1. Coolant reservoir (page 7-13)

2. Main fuse (page 7-32)

3. Owner's tool kit (page 7-1)

4. Passenger seat lock (page 4-16)

5. Storage compartment (page 4-18)

6. Shock absorber assembly spring preload adjusting ring (page 4-18)

7. Shift pedal (page 4-12)

8. Engine oil drain bolt (page 7-10)

9. Engine oil filter cartridge (page 7-10)

Right view

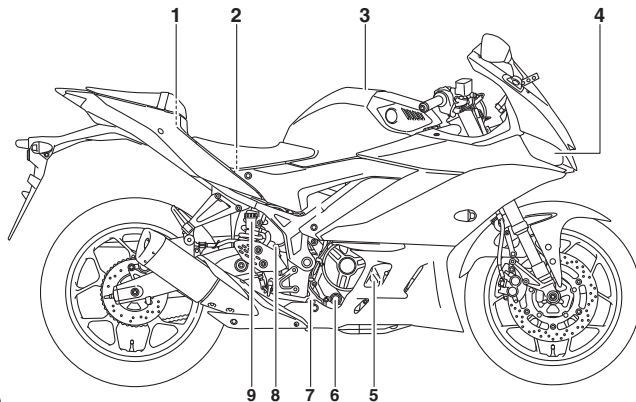

1. Fuse box (page 7-32)
2. Battery (page 7-31)
3. Fuel tank cap (page 4-13)
4. Headlight (page 7-34)
5. Engine oil filler cap (page 7-10)
6. Engine oil level check window (page 7-10)
7. Brake pedal (page 4-13)
8. Rear brake light switch (page 7-22)

9. Rear brake fluid reservoir (page 7-23)

Description

EAU10431

Controls and instruments

3

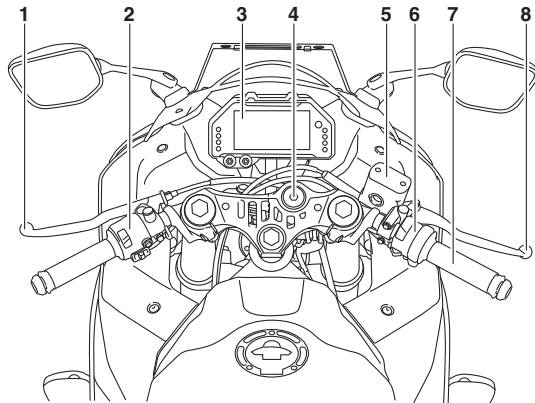

1. Clutch lever (page 4-12)
2. Left handlebar switches (page 4-10)
3. Multi-function meter unit (page 4-4)
4. Main switch/steering lock (page 4-1)
5. Front brake fluid reservoir (page 7-23)
6. Right handlebar switches (page 4-10)
7. Throttle grip (page 7-17)
8. Brake lever (page 4-12)

Main switch/steering lock

EAU10462

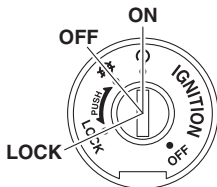

The main switch/steering lock controls the ignition and lighting systems, and is used to lock the steering. The various positions are described below.

○ (on)

EAU62480

All electrical circuits are supplied with power; the meter lighting, taillight, license plate light and auxiliary light come on, and the engine can be started. The key cannot be removed.

TIP

The headlight comes on automatically when the engine is started and stays on until the key is turned to "⊗", even if the engine stalls.

⊗ (off)

All electrical systems are off. The key can be removed.

EAU54301

⚠ WARNING

Never turn the key to "⊗" or "LOCK" while the vehicle is moving. Otherwise the electrical systems will be switched off, which may result in loss of control or an accident.

EWA16371

LOCK

The steering is locked and all electrical systems are off. The key can be removed.

EAU60863

To lock the steering

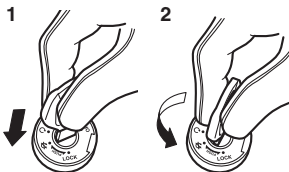

1. Push.
2. Turn.

1. Turn the handlebars all the way to the left.
2. With the key in the "⊗" position, push the key in and turn it to "LOCK".
3. Remove the key.

TIP

If the steering will not lock, try turning the handlebars back to the right slightly.

Instrument and control functions

To unlock the steering

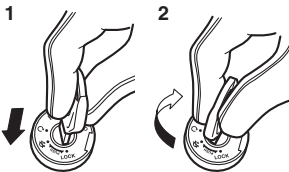

4

1. Push.
2. Turn.

From the “LOCK” position, push the key and turn it to “ON”.

Indicator lights and warning lights

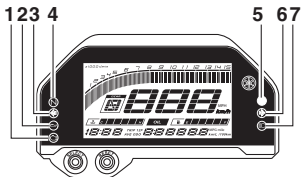

1. Engine trouble warning light “”
2. Oil pressure warning light “”
3. Left turn signal indicator light “”
4. Neutral indicator light “N”
5. Shift timing indicator light
6. Right turn signal indicator light “”
7. High beam indicator light “”

Turn signal indicator lights “” and “”

Each indicator light will flash when its corresponding turn signal lights are flashing.

Neutral indicator light “N”

This indicator light comes on when the transmission is in the neutral position.

High beam indicator light “”

This indicator light comes on when the high beam of the headlight is switched on.

Oil pressure warning light “”

This warning light comes on if the engine oil pressure is low.

The electrical circuit of the warning light can be checked by turning the key to “ON”. The warning light should come on and remain on until the engine is started.

If the warning light does not come on initially when the key is turned to “ON”, have a Yamaha dealer check the electrical circuit.

NOTICE

If the warning light comes on when the engine is running, stop the engine immediately and check oil level. If the oil level is below the minimum

Instrument and control functions

level, add sufficient oil of the recommended type to raise it up to the correct level. If the oil pressure warning light remains on even if the oil level is correct, immediately turn the engine off and have a Yamaha dealer check the vehicle.

TIP

If the warning light does not go off after starting the engine, check the engine oil level and add oil if necessary. (See page 7-10.)

If the warning light remains on after adding engine oil, have a Yamaha dealer check the vehicle.

Engine trouble warning light “”

EAU85140

This warning light comes on or flashes if a problem is detected in the engine. If this occurs, have a Yamaha dealer check the self-diagnosis system. (See page 4-10.)

TIP

- When the vehicle is turned on, this light should come on for a few seconds and then go off. Otherwise, have a Yamaha dealer check the electrical circuit.
- The engine trouble warning light will come on while the start switch is pushed, but this does not indicate a malfunction.

Shift timing indicator light

EAU62470

This indicator light can be set to come on and go off at the desired engine speeds and is used to inform the rider when it is time to shift to the next higher gear. (See page 4-8 for a more detailed explanation of this indicator light and on how to set it.)

The electrical circuit of the indicator light can be checked by turning the key to “○”. The indicator light should come on for a few seconds, and then go off.

If the indicator light does not come on initially when the key is turned to “○”, or if the indicator light remains on, have a Yamaha dealer check the electrical circuit.

Instrument and control functions

Multi-function meter unit

EAUN1431

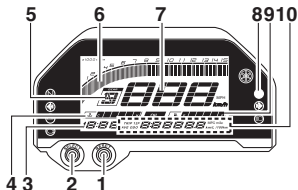

1. "RESET" button
2. "SELECT" button
3. Clock
4. Coolant temperature meter
5. Transmission gear display
6. Tachometer
7. Speedometer
8. Shift timing indicator light
9. Fuel meter
10. Multi-function display

WARNING

Be sure to stop the vehicle before making any setting changes to the multi-function meter unit. Changing

settings while riding can distract the operator and increase the risk of an accident.

The multi-function meter unit is equipped with the following:

- a speedometer
- a tachometer
- a clock
- a fuel meter
- a coolant temperature meter
- a transmission gear display
- a multi-function display
- a shift timing indicator light
- a self-diagnosis device

TIP

- Be sure to turn the key to "O" before using the "SELECT" and "RESET" buttons, except for setting the shift timing indicator light control mode.
- To switch the speedometer and multi-function displays between kilometers and miles, press the "SELECT" button for at least one second.

EWA12423

Speedometer

The speedometer shows the vehicle's traveling speed.

Tachometer

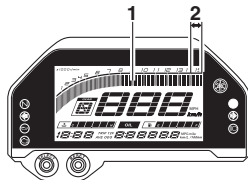

1. Tachometer
2. Tachometer red zone

The tachometer allows the rider to monitor the engine speed and keep it within the ideal power range. When the key is turned to "O", the tachometer will sweep across the r/min range and then return to zero r/min in order to test the electrical circuit.

ECA10032

NOTICE

Do not operate the engine in the tachometer red zone.
Red zone: 14000 r/min and above

Instrument and control functions

Clock

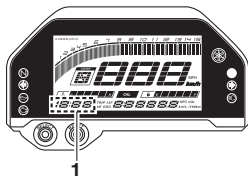

1. Clock

The clock displays when the key is turned to “O”.

To set the clock

1. Turn the key to “O”.
2. Push the “SELECT” button and “RESET” button together for at least two seconds.
3. When the hour digits start flashing, push the “RESET” button to set the hours.
4. Push the “SELECT” button, and the minute digits will start flashing.
5. Push the “RESET” button to set the minutes.
6. Push the “SELECT” button and then release it to start the clock.

Fuel meter

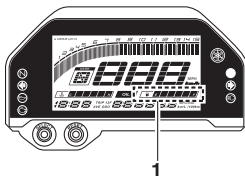

1. Fuel meter

The fuel meter indicates the amount of fuel in the fuel tank.

When the key is turned to “O”, the display segments of the fuel meter will sweep once across the fuel level range and then return to the current amount in order to test the electrical circuit.

The display segments of the fuel meter disappear towards “E” (Empty) as the fuel level decreases. When the last segment starts flashing, refuel as soon as possible.

TIP

This fuel meter is equipped with a self-diagnosis system. If a problem is detected in the electrical circuit, the fol-

lowing cycle is repeated until the malfunction is corrected: fuel level segments flash eight times, then go off for approximately three seconds. If this occurs, have a Yamaha dealer check the electrical circuit.

Coolant temperature meter

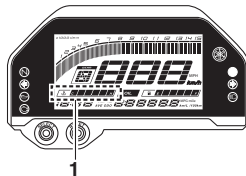

1. Coolant temperature meter

The coolant temperature meter indicates the temperature of the coolant. When the key is turned to “O”, the display segments of the digital coolant temperature gauge will sweep once across the temperature range and then return to “C” in order to test the electrical circuit.

Instrument and control functions

If the last segment on the right flashes, stop the vehicle, then stop the engine, and let the engine cool. (See page 7-42.)

NOTICE

Do not continue to operate the engine if it is overheating.

TIP

The coolant temperature varies with changes in the weather and engine load.

Transmission gear display

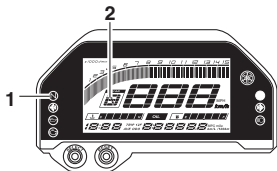

1. Neutral indicator light "N"
2. Transmission gear display

This display shows the selected gear. The neutral position is indicated by "N" and by the neutral indicator light.

Multi-function display

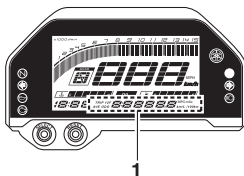

1. Multi-function display

The multi-function display is equipped with the following:

- an odometer
- two tripmeters
- a fuel reserve tripmeter
- an instantaneous fuel consumption display
- an average fuel consumption display
- an oil change tripmeter
- an oil change indicator

4-6

The odometer shows the total distance traveled by the vehicle.

The tripmeters show the distance traveled since they were last set to zero. Push the "SELECT" button to switch the display between the odometer mode "ODO", tripmeter modes "TRIP 1" and "TRIP 2", instantaneous fuel consumption mode "MPG", "km/L" or "L/100 km", average fuel consumption mode "AVE_ _ _ MPG", "AVE_ _ _ km/L" or "AVE_ _ _ L/100 km" and oil change tripmeter mode "OIL TRIP" in the following order:

ODO • TRIP 1 • TRIP 2 • MPG, km/L or L/100 km → AVE_ _ _ MPG, AVE_ _ _ km/L or AVE_ _ _ L/100 km → OIL TRIP → ODO

The fuel reserve tripmeter shows the distance traveled since the fuel level warning light came on.

If the left segment of the fuel meter starts flashing, the display automatically changes to the fuel reserve tripmeter mode "TRIP F" and starts

Instrument and control functions

counting the distance traveled from that point. In that case, push the “SE-LECT” button to switch the display between the various tripmeter, odometer, instantaneous fuel consumption and average fuel consumption modes in the following order:

TRIP F → MPG, km/L or L/100 km → AVE_ _ _ MPG, AVE_ _ _ km/L or AVE_ _ _ L/100 km → OIL TRIP → ODO → TRIP 1 → TRIP 2 → TRIP F

To reset a tripmeter, select it by pushing the “SELECT” button, and then push the “RESET” button for at least one second.

If you do not reset the fuel reserve tripmeter manually, it resets itself automatically and the display returns to the prior mode after refueling and traveling 5 km (3 mi).

TIP

- The odometer will lock at 999999.
- The tripmeters will reset and continue counting after 9999.9 is reached.

Instantaneous fuel consumption display

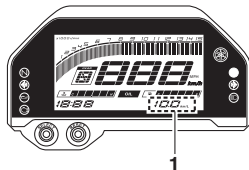

1. Instantaneous fuel consumption display

The instantaneous fuel consumption display can be set to either “MPG”, “km/L” or “L/100 km”.

- “MPG”: The distance that can be traveled on 1.0 US gal of fuel under the current riding conditions is shown.
- “L/100 km”: The amount of fuel necessary to travel 100 km under the current riding conditions is shown.
- “km/L”: The distance that can be traveled on 1.0 L of fuel under the current riding conditions is shown.

To switch between the instantaneous fuel consumption displays, push the “SELECT” button for one second.

TIP

If traveling at speeds under 20 km/h (12 mi/h), “_ _ _” is displayed.

Average fuel consumption display

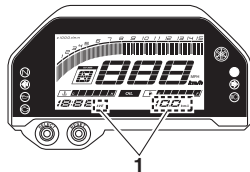

1. Average fuel consumption display

The average fuel consumption display can be set to either “AVE_ _ _ MPG”, “AVE_ _ _ km/L” or “AVE_ _ _ L/100 km”.

This display shows the average fuel consumption since it was last reset.

- “AVE_ _ _ MPG”: The average distance that can be traveled on 1.0 US gal of fuel is shown.

Instrument and control functions

- “AVE_ _ _ km/L”: The average distance that can be traveled on 1.0 L of fuel is shown.
- “AVE_ _ _ L/100 km”: The average amount of fuel necessary to travel 100 km is shown.

To switch between the average fuel consumption displays, push the “SELECT” button for one second.

To reset the average fuel consumption display, push the “RESET” button for at least one second.

TIP

After resetting the average fuel consumption display, “_ _ _” is shown until the vehicle has traveled 1 km (0.6 mi).

Oil change tripmeter

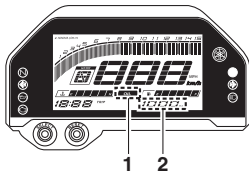

1. Oil change indicator “OIL”
2. Oil change tripmeter

The oil change tripmeter shows the distance traveled since it was last reset (i.e., since the last oil change).

The oil change indicator “OIL” will flash at the initial 1000 km (600 mi), then at 5000 km (3000 mi) and every 5000 km (3000 mi) thereafter to indicate that the engine oil should be changed.

After changing the engine oil, reset the oil change tripmeter and the oil change indicator. To reset them both, select the oil change tripmeter, and then push the “RESET” button for one second. Then, while “OIL” and the oil change tripmeter are flashing, push the “RESET” button for three seconds. The oil change indicator will be reset.

If the engine oil is changed before the oil change indicator comes on (i.e., before the periodic oil change interval has been reached), the oil change tripmeter must be reset for the next periodic oil change to be indicated at the correct time.

Shift timing indicator light

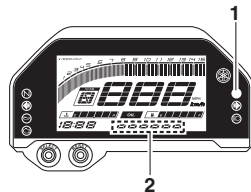

1. Shift timing indicator light
2. Brightness level display

The shift timing indicator light has four settings which can be adjusted.

- Flashing pattern: this function allows you to choose whether or not the indicator light will come on and whether it should flash or stay on when activated.
- Activation point: this function allows you to select the engine speed at which the indicator light is activated.
- Deactivation point: this function allows you to select the engine speed at which the indicator light is deactivated.

Instrument and control functions

- **Brightness:** this function allows you to adjust the brightness of the indicator light.

To adjust the shift timing indicator light

1. Turn the key to “

To set the flashing pattern

1. Push the “RESET” button to select one of the following flashing pattern settings:
 - **On:** the indicator light stays on when activated. (This setting is selected when the indicator light stays on.)
 - **Flash:** the indicator light flashes when activated. (This setting is selected when the indicator light flashes four times per second.)
 - **Off:** the indicator light is deactivated; in other words, it does not come on or flash.

(This setting is selected when the indicator light flashes once every two seconds.)

2. Push the “SELECT” button to confirm the selected flashing pattern. The shift timing indicator light changes to the activation point setting mode.

The tachometer will show the current setting r/min for the activation point and deactivation point setting modes.

To set the shift activation point

TIP

The shift timing indicator light activation point can be set between 7000 r/min and 15000 r/min. From 7000 r/min to 12000 r/min, the indicator light can be set in increments of 500 r/min. From 12000 r/min to 15000 r/min, the indicator light can be set in increments of 200 r/min.

1. Push the “RESET” button to select the desired engine speed for activating the indicator light.

2. Push the “SELECT” button to confirm the selected engine speed. The control mode changes to the deactivation point setting mode.

To set the deactivation point

TIP

- The shift timing indicator light deactivation point can be set between 7000 r/min and 15000 r/min. From 7000 r/min to 12000 r/min, the indicator light can be set in increments of 500 r/min. From 12000 r/min to 15000 r/min, the indicator light can be set in increments of 200 r/min.
- Be sure to set the deactivation point to a higher engine speed than for the activation point, otherwise the shift timing indicator light will not come on.

1. Push the “RESET” button to select the desired engine speed for deactivating the indicator light.
2. Push the “SELECT” button to confirm the selected engine speed. The control mode changes to the brightness setting mode.

Instrument and control functions

To adjust the brightness

1. Push the "RESET" button to select the desired shift indicator light brightness level.
2. Push the "SELECT" button to confirm the selected brightness level. The display exits the shift timing light control mode and returns to the standard multi-function display mode.

Self-diagnosis device

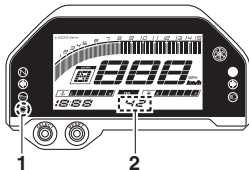

1. Engine trouble warning light "⚠"
2. Error code display

This model is equipped with a self-diagnosis device for various electrical circuits.

If a problem is detected in any of those circuits, the engine trouble warning light will come on and the display will indicate an error code.

NOTICE

If the display indicates an error code, the vehicle should be checked as soon as possible in order to avoid engine damage.

ECA11591

Handlebar switches

EAU1234M

Left

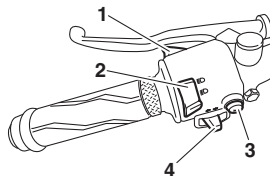

1. Pass switch "PASS"
2. Dimmer switch "☰/☱"
3. Horn switch "📢"
4. Turn signal switch "↔"

Right

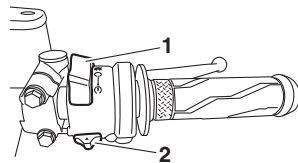

1. Start/Engine stop switch "⊕/⊖/⊗"
2. Hazard switch "▲/OFF"

Pass switch “PASS”

EAU12362

Press this switch to flash the headlight.

TIP

When the dimmer switch is set to “

Dimmer switch “/ EAU85410

Set this switch to “

TIP

When the switch is set to low beam, both headlights for low beam come on. When the switch is set to high beam, both headlights for high beam come on.

Turn signal switch “/ EAU12461

To signal a right-hand turn, push this switch to “

Horn switch “ EAU12501

Press this switch to sound the horn.

Start/Engine stop switch “// EAU68270

To crank the engine with the starter, set this switch to “

Set this switch to “

Hazard lights switch “/OFF”

EAU2210

The hazard lights (simultaneous flashing of all turn signal lights) are used in case of an emergency, such as to warn other drivers when your vehicle is stopped where it might be a traffic hazard.

Set this switch to “

NOTICE

Do not use the hazard lights for an extended length of time with the engine not running, otherwise the battery may discharge.

Instrument and control functions

Clutch lever

EAU31642

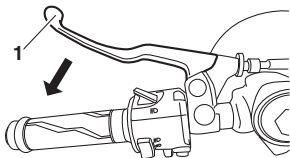

1. Clutch lever

The clutch lever is located on the left side of the handlebar. To disengage the clutch, pull the lever toward the handlebar grip. To engage the clutch, release the lever. The lever should be pulled rapidly and released slowly for smooth clutch operation.

The clutch lever is equipped with a clutch switch, which is part of the starting circuit cut-off system. (See page 4-20.)

Shift pedal

EAU12875

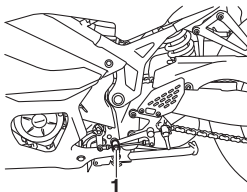

1. Shift pedal

The shift pedal is located on the left side of the motorcycle. To shift the transmission to a higher gear, move the shift pedal up. To shift to the transmission to a lower gear, move the shift pedal down. (See page 6-2.)

Brake lever

EAU12892

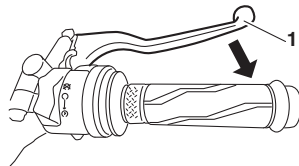

1. Brake lever

The brake lever is located on the right side of the handlebar. To apply the front brake, pull the lever toward the throttle grip.

Brake pedal

EAU12944

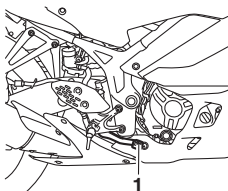

1. Brake pedal

The brake pedal is located on the right side of the motorcycle. To apply the rear brake, press down on the brake pedal.

Fuel tank cap

EAU13076

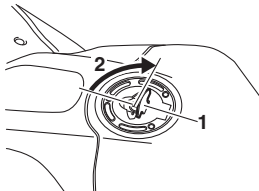

1. Fuel tank cap lock cover
2. Unlock.

To open the fuel tank cap

Open the fuel tank cap lock cover, insert the key into the lock, and then turn it 1/4 turn clockwise. The lock will be released and the fuel tank cap can be opened.

To close the fuel tank cap

With the key still inserted in the lock, push down the fuel tank cap. Turn the key 1/4 turn counterclockwise, remove it, and then close the lock cover.

TIP

The fuel tank cap cannot be closed unless the key is in the lock. In addition, the key cannot be removed if the cap is not properly closed and locked.

EWA11092

WARNING

Make sure that the fuel tank cap is properly closed after filling fuel. Leaking fuel is a fire hazard.

Instrument and control functions

Fuel

Make sure there is sufficient gasoline in the tank.

EAU13222

EWA10882

WARNING

Gasoline and gasoline vapors are extremely flammable. To avoid fires and explosions and to reduce the risk of injury when refueling, follow these instructions.

1. Before refueling, turn off the engine and be sure that no one is sitting on the vehicle. Never refuel while smoking, or while in the vicinity of sparks, open flames, or other sources of ignition such as the pilot lights of water heaters and clothes dryers.
2. Do not overfill the fuel tank. When refueling, be sure to insert the pump nozzle into the fuel tank filler hole. Stop filling when the fuel reaches the bottom of the filler tube. Because fuel expands when it heats up, heat from the engine or the sun can cause fuel to spill out of the fuel tank.

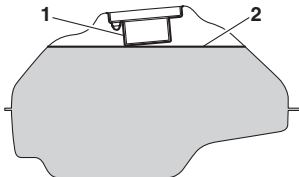

1. Fuel tank filler tube
2. Maximum fuel level
3. Wipe up any spilled fuel immediately. **NOTICE: Immediately wipe off spilled fuel with a clean, dry, soft cloth, since fuel may deteriorate painted surfaces or plastic parts.** [ECA10072]
4. Be sure to securely close the fuel tank cap.

WARNING

Gasoline is poisonous and can cause injury or death. Handle gasoline with care. Never siphon gasoline by mouth. If you should swallow some gasoline or inhale a lot of gasoline vapor, or get some gasoline in your eyes, see your doctor immedi-

EWA15152

ately. If gasoline spills on your skin, wash with soap and water. If gasoline spills on your clothing, change your clothes.

EAU13245

Recommended fuel:

Unleaded gasoline only

Fuel tank capacity:

14 L (3.7 US gal, 3.1 Imp.gal)

Fuel reserve amount:

3.0 L (0.79 US gal, 0.66 Imp.gal)

ECA11401

NOTICE

Use only unleaded gasoline. The use of leaded gasoline will cause severe damage to internal engine parts, such as the valves and piston rings, as well as to the exhaust system.

Fuel tank breather hose and overflow hose

EAUN0790

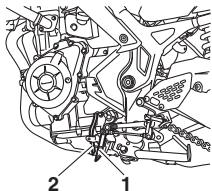

1. Fuel tank overflow hose
2. Fuel tank breather hose

Before operating the motorcycle:

- Check each hose connection.
- Check each hose for cracks or damage, and replace if necessary.
- Make sure that the end of each hose is not blocked, and clean if necessary.
- Make sure that the end of fuel tank breather hose is positioned outside of the cowling.

Catalytic converter

EAU13434

This model is equipped with a catalytic converter in the exhaust system.

EWA10863

WARNING

The exhaust system is hot after operation. To prevent a fire hazard or burns:

- Do not park the vehicle near possible fire hazards such as grass or other materials that easily burn.
- Park the vehicle in a place where pedestrians or children are not likely to touch the hot exhaust system.
- Make sure that the exhaust system has cooled down before doing any maintenance work.
- Do not allow the engine to idle more than a few minutes. Long idling can cause a build-up of heat.

NOTICE

Use only unleaded gasoline. The use of leaded gasoline will cause unreparable damage to the catalytic converter.

Instrument and control functions

Seats

EAU62622

Passenger seat

To remove the passenger seat

1. Insert the key into the seat lock, and then turn it clockwise.

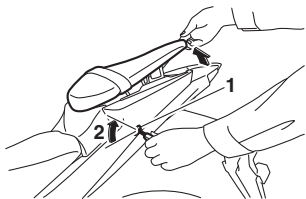

1. Passenger seat lock
2. Unlock.

2. While holding the key in that position, lift the rear of the passenger seat and pull it backward.

To install the passenger seat

1. Insert the projections on the front of the passenger seat into the seat holders as shown, and then push the rear of the seat down to lock it in place.

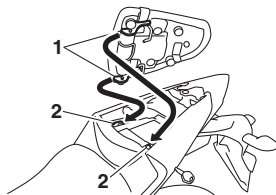

1. Projection
2. Seat holder

2. Remove the key.

Rider seat

To remove the rider seat

1. Remove the passenger seat.
2. Remove the center cover by removing the screws.

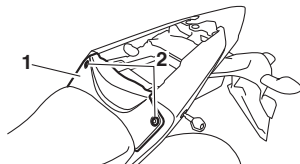

1. Center cover
2. Screw

3. Remove the rider seat by removing the bolts. Lift the rear of the rider seat and pull it backward.

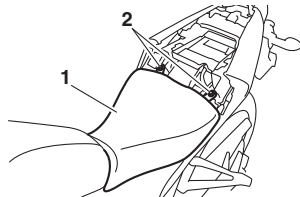

1. Rider seat
2. Bolt

To install the rider seat

1. Insert the projection on the front of the rider seat into the seat holder as shown, and then place the seat in the original position.

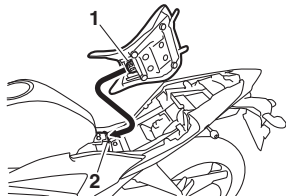

1. Projection
2. Seat holder

2. Install the rider seat bolts.
3. Install the center cover by installing the screws.
4. Install the passenger seat.

TIP

Make sure that the seats are properly secured before riding.

Helmet holders

EAU62930

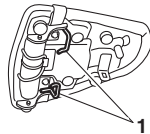

1. Helmet holder

The helmet holders are located on the bottom of the passenger seat.

To secure a helmet to a helmet holder

1. Remove the passenger seat. (See page 4-16.)
2. Attach a helmet to a helmet holder, and then securely install the passenger seat. **WARNING! Never ride with a helmet attached to the helmet holder, since the helmet may hit objects, causing loss of control and possibly an accident.** [EWA10162]

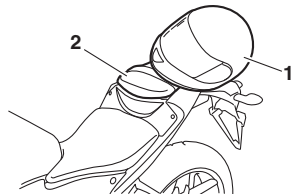

1. Helmet
2. Passenger seat

To release a helmet from a helmet holder

Remove the passenger seat, remove the helmet from the helmet holder, and then install the seat.

Instrument and control functions

Storage compartment

EAU62550

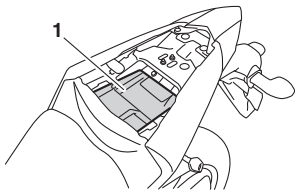

1. Storage compartment

The storage compartment is located under the passenger seat. (See page 4-16.)

When storing documents or other items in the storage compartment, be sure to wrap them in a plastic bag so that they will not get wet. When washing the vehicle, be careful not to let any water enter the storage compartment.

EWA15401



WARNING

Do not exceed the maximum load of 160 kg (353 lb) for the vehicle.

Rear view mirrors

EAU39672

The rear view mirrors of this vehicle can be folded forward or backward for parking in narrow spaces. Fold the mirrors back to their original position before riding.

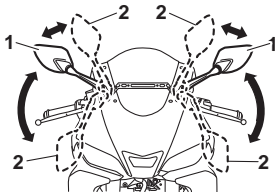

1. Riding position
2. Parking position

EWA14372



WARNING

Be sure to fold the rear view mirrors back to their original position before riding.

Adjusting the shock absorber assembly

EAU62562

This shock absorber assembly is equipped with a spring preload adjusting ring.

ECA10102

NOTICE

To avoid damaging the mechanism, do not attempt to turn beyond the maximum or minimum settings.

Adjust the spring preload as follows.

To increase the spring preload and thereby harden the suspension, turn the adjusting ring in direction (a). To decrease the spring preload and thereby soften the suspension, turn the adjusting ring in direction (b).

- Align the appropriate notch in the adjusting ring with the position indicator on the shock absorber.
- Use the special wrench and the extension bar included in the owner's tool kit to make the adjustment.

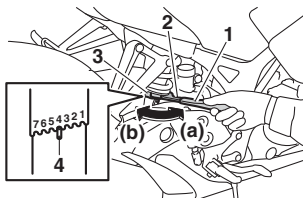

1. Extension bar
2. Special wrench
3. Spring preload adjusting ring
4. Position indicator

Spring preload setting:

Minimum (soft):

1

Standard:

4

Maximum (hard):

7

Luggage strap holders



1. Luggage strap holder

There is a luggage strap holder on each passenger footrest.

Sidestand

The sidestand is located on the left side of the frame. Raise the sidestand or lower it with your foot while holding the vehicle upright.

WARNING

The vehicle must not be ridden with the sidestand down, or if the sidestand cannot be properly moved up (or does not stay up), otherwise the sidestand could contact the ground and distract the operator, resulting in a possible loss of control.

Instrument and control functions

EAU15396

Starting circuit cut-off system

This system prevents in-gear engine starts unless the clutch lever is pulled. Periodically check the system via the following procedure.

TIP

- This check is most reliable if performed with a warmed-up engine.
- See pages 4-1 and 4-10 for switch operation information.

For your safety – pre-operation checks

EAU15599

Inspect your vehicle each time you use it to make sure the vehicle is in safe operating condition. Always follow the inspection and maintenance procedures and schedules described in the Owner's Manual.

EWA11152

WARNING

Failure to inspect or maintain the vehicle properly increases the possibility of an accident or equipment damage. Do not operate the vehicle if you find any problem. If a problem cannot be corrected by the procedures provided in this manual, have the vehicle inspected by a Yamaha dealer.

Before using this vehicle, check the following points:

| ITEM | CHECKS | PAGE |
|-------------|---|------------|
| Fuel | <ul style="list-style-type: none">• Check fuel level in fuel tank.• Refuel if necessary.• Check fuel line for leakage.• Check fuel tank breather hose and overflow hose for obstructions, cracks or damage, and check hose connections. | 4-14, 4-15 |
| Engine oil | <ul style="list-style-type: none">• Check oil level in engine.• If necessary, add recommended oil to specified level.• Check vehicle for oil leakage. | 7-10 |
| Coolant | <ul style="list-style-type: none">• Check coolant level in reservoir.• If necessary, add recommended coolant to specified level.• Check cooling system for leakage. | 7-13 |
| Front brake | <ul style="list-style-type: none">• Check operation.• If soft or spongy, have Yamaha dealer bleed hydraulic system.• Check brake pads for wear.• Replace if necessary.• Check fluid level in reservoir.• If necessary, add specified brake fluid to specified level.• Check hydraulic system for leakage. | 7-22, 7-23 |

For your safety – pre-operation checks

| ITEM | CHECKS | PAGE |
|--------------------------------|---|------------|
| Rear brake | <ul style="list-style-type: none"> • Check operation. • If soft or spongy, have Yamaha dealer bleed hydraulic system. • Check brake pads for wear. • Replace if necessary. • Check fluid level in reservoir. • If necessary, add specified brake fluid to specified level. • Check hydraulic system for leakage. | 7-22, 7-23 |
| Clutch | <ul style="list-style-type: none"> • Check operation. • Lubricate cable if necessary. • Check lever free play. • Adjust if necessary. | 7-19 |
| Throttle grip | <ul style="list-style-type: none"> • Make sure that operation is smooth. • Check throttle grip free play. • If necessary, have Yamaha dealer adjust throttle grip free play and lubricate cable and grip housing. | 7-17, 7-27 |
| Control cables | <ul style="list-style-type: none"> • Make sure that operation is smooth. • Lubricate if necessary. | 7-27 |
| Drive chain | <ul style="list-style-type: none"> • Check chain slack. • Adjust if necessary. • Check chain condition. • Lubricate if necessary. | 7-25, 7-26 |
| Wheels and tires | <ul style="list-style-type: none"> • Check for damage. • Check tire condition and tread depth. • Check air pressure. • Correct if necessary. | 7-17, 7-19 |
| Brake and shift pedals | <ul style="list-style-type: none"> • Make sure that operation is smooth. • Lubricate pedal pivoting points if necessary. | 7-28 |
| Brake and clutch levers | <ul style="list-style-type: none"> • Make sure that operation is smooth. • Lubricate lever pivoting points if necessary. | 7-28 |
| Sidestand | <ul style="list-style-type: none"> • Make sure that operation is smooth. • Lubricate pivot if necessary. | 7-29 |

For your safety – pre-operation checks

| ITEM | CHECKS | PAGE |
|--|---|------|
| Chassis fasteners | <ul style="list-style-type: none">• Make sure that all nuts, bolts and screws are properly tightened.• Tighten if necessary. | – |
| Instruments, lights, signals and switches | <ul style="list-style-type: none">• Check operation.• Correct if necessary. | – |

Operation and important riding points

EAU15952

Read the Owner's Manual carefully to become familiar with all controls. If there is a control or function you do not understand, ask your Yamaha dealer.

EWA10272



WARNING

Failure to familiarize yourself with the controls can lead to loss of control, which could cause an accident or injury.

EAU62513

TIP

This model is equipped with:

- a lean angle sensor to stop the engine in case of a turnover. In this case, the display will indicate error code 30, but this is not a malfunction. Turn the key to “” and then to “” to clear the error code. Failing to do so will prevent the engine from starting even though the engine will crank when pushing the start switch.
- an engine auto-stop system. The engine stops automatically if left idling for 20 minutes. If the engine stops, simply push the start switch to restart the engine.

EAUN0073

ECAN0072

NOTICE

Do not ride through deep water, otherwise the engine may be damaged. Avoid puddles because they may be deeper than expected.

Operation and important riding points

Starting the engine

EAUJN2220

In order for the starting circuit cut-off system to enable starting, one of the following conditions must be met:

- The transmission is in the neutral position.
- The transmission is in gear with the clutch lever pulled.

See page 4-20 for more information.

1. Set the stop/run/start switch to “○”.
2. Turn the key to “○”. The engine trouble warning light should come on for a few seconds, then go off.

NOTICE: If the warning light does not go off, have a Yamaha dealer check its electrical circuit. [ECAT1121]

3. Shift the transmission into the neutral position. The neutral indicator light should come on. If not, ask a Yamaha dealer to check the electrical circuit.
4. Slide the stop/run/start switch toward “⊕” to start the engine. If the engine fails to start, release the switch after 5 seconds.

- Do not crank the engine more than 10 seconds on any one attempt.
- Wait a few seconds before trying again to allow battery voltage to restore.

NOTICE

For maximum engine life, never accelerate hard when the engine is cold!

ECA11043

Shifting

EAU16674

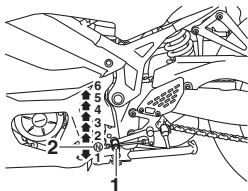

1. Shift pedal
2. Neutral position

Shifting gears lets you control the amount of engine power available for starting off, accelerating, climbing hills, etc.

The gear positions are shown in the illustration.

TIP

To shift the transmission into the neutral position (**N**), press the shift pedal down repeatedly until it reaches the end of its travel, and then slightly raise it.

Operation and important riding points

NOTICE

ECA10261

- Even with the transmission in the neutral position, do not coast for long periods of time with the engine off, and do not tow the motorcycle for long distances. The transmission is properly lubricated only when the engine is running. Inadequate lubrication may damage the transmission.
- Always use the clutch while changing gears to avoid damaging the engine, transmission, and drive train, which are not designed to withstand the shock of forced shifting.

Tips for reducing fuel consumption

EAU16811

Fuel consumption depends largely on your riding style. Consider the following tips to reduce fuel consumption:

- Shift up swiftly, and avoid high engine speeds during acceleration.
- Do not rev the engine while shifting down, and avoid high engine speeds with no load on the engine.
- Turn the engine off instead of letting it idle for an extended length of time (e.g., in traffic jams, at traffic lights or at railroad crossings).

Engine break-in

EAU16842

There is never a more important period in the life of your engine than the period between 0 and 1600 km (1000 mi). For this reason, you should read the following material carefully.

Since the engine is brand new, do not put an excessive load on it for the first 1600 km (1000 mi). The various parts in the engine wear and polish themselves to the correct operating clearances. During this period, prolonged full-throttle operation or any condition that might result in engine overheating must be avoided.

EAU17094

0–1000 km (0–600 mi)

Avoid prolonged operation above 7000 r/min. **NOTICE: After 1000 km (600 mi) of operation, the engine oil must be changed and the oil filter cartridge or element replaced.** [ECA10303]

1000–1600 km (600–1000 mi)

Avoid prolonged operation above 8400 r/min.

Operation and important riding points

1600 km (1000 mi) and beyond

The vehicle can now be operated normally.

ECA10311

NOTICE

- Keep the engine speed out of the tachometer red zone.
- If any engine trouble should occur during the engine break-in period, immediately have a Yamaha dealer check the vehicle.

Parking

EAU17214

When parking, stop the engine, and then remove the key from the main switch.

EWA10312

WARNING

- Since the engine and exhaust system can become very hot, park in a place where pedestrians or children are not likely to touch them and be burned.
- Do not park on a slope or on soft ground, otherwise the vehicle may overturn, increasing the risk of a fuel leak and fire.
- Do not park near grass or other flammable materials which might catch fire.

Periodic maintenance and adjustment

EAU17246

Periodic inspection, adjustment, and lubrication will keep your vehicle in the safest and most efficient condition possible. Safety is an obligation of the vehicle owner/operator. The most important points of vehicle inspection, adjustment, and lubrication are explained on the following pages.

The intervals given in the periodic maintenance charts should be simply considered as a general guide under normal riding conditions. However, depending on the weather, terrain, geographical location, and individual use, the maintenance intervals may need to be shortened.

EWA10322

! WARNING

Failure to properly maintain the vehicle or performing maintenance activities incorrectly may increase your risk of injury or death during service or while using the vehicle. If you are not familiar with vehicle service, have a Yamaha dealer perform service.

! WARNING

Turn off the engine when performing maintenance unless otherwise specified.

- **A running engine has moving parts that can catch on body parts or clothing and electrical parts that can cause shocks or fires.**
- **Running the engine while servicing can lead to eye injury, burns, fire, or carbon monoxide poisoning – possibly leading to death. See page 2-3 for more information about carbon monoxide.**

! WARNING

Brake discs, calipers, drums, and linings can become very hot during use. To avoid possible burns, let brake components cool before touching them.

EWA15123

Owner's tool kit

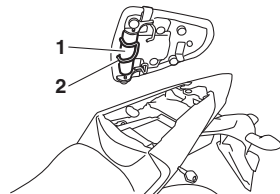

1. Owner's tool kit
2. O-ring

The owner's tool kit is located on the bottom of the passenger seat (see page 4-16) and is held in place with an O-ring.

The service information included in this manual and the tools provided in the owner's tool kit are intended to assist you in the performance of preventive maintenance and minor repairs. However, additional tools such as a torque wrench may be necessary to perform certain maintenance work correctly.

Periodic maintenance and adjustment

TIP

If you do not have the tools or experience required for a particular job, have a Yamaha dealer perform it for you.

Periodic maintenance and adjustment

EAU62940

TIP

- The annual checks must be performed every year, except if a kilometer-based maintenance is performed instead.
- From 25000 km or 25 months, repeat the maintenance intervals starting from 5000 km or 5 months.
- Items marked with an asterisk should be performed by a Yamaha dealer as they require special tools, data and technical skills.

EAUN0411

Periodic maintenance chart for the emission control system

| NO. | ITEM | CHECK OR MAINTENANCE JOB | ODOMETER READING (whichever comes first) | | | | | ANNUAL CHECK |
|-----|------------------|--|--|---------------------------|-----------------------------|-----------------------------|-----------------------------|--------------|
| | | | 1000 km or 1 month | 5000 km or 5 months | 10000 km or 10 months | 15000 km or 15 months | 20000 km or 20 months | |
| 1 | * Fuel line | • Check fuel hoses for cracks or damage. | | √ | √ | √ | √ | √ |
| 2 | * Fuel filter | • Check condition. • Replace if necessary. | | | √ | | √ | |
| 3 | * Spark plugs | • Check condition. • Clean and regap. | | √ | | √ | | |
| | | • Replace. | | | √ | | √ | |
| 4 | * Valves | • Check valve clearance. • Adjust if necessary. | | | √ | | √ | |
| 5 | * Fuel injection | • Adjust synchronization. | | √ | √ | √ | √ | √ |
| 6 | * Exhaust system | • Check for leakage. • Tighten if necessary. • Replace gasket(s) if necessary. | | √ | √ | √ | √ | √ |

Periodic maintenance and adjustment

| NO. | ITEM | CHECK OR MAINTENANCE JOB | ODOMETER READING (whichever comes first) | | | | | ANNUAL CHECK |
|-----|----------------------|--|--|---------------------------|-----------------------------|-----------------------------|-----------------------------|--------------|
| | | | 1000 km or 1 month | 5000 km or 5 months | 10000 km or 10 months | 15000 km or 15 months | 20000 km or 20 months | |
| 7 | Air induction system | <ul style="list-style-type: none"> • Check the air cut-off valve, reed valve, and hose for damage. • Replace the entire air induction system if necessary. | | √ | √ | √ | √ | √ |

Periodic maintenance and adjustment

EALIND423

General maintenance and lubrication chart

| NO. | ITEM | CHECK OR MAINTENANCE JOB | ODOMETER READING (whichever comes first) | | | | | ANNUAL CHECK |
|-----|---------------------------|--|--|---------------------------|-----------------------------|-----------------------------|-----------------------------|--------------|
| | | | 1000 km or 1 month | 5000 km or 5 months | 10000 km or 10 months | 15000 km or 15 months | 20000 km or 20 months | |
| 1 | * Diagnostic system check | <ul style="list-style-type: none"> Perform dynamic inspection using Yamaha diagnostic tool. Check the error codes. | √ | √ | √ | √ | √ | √ |
| 2 | Air filter element | <ul style="list-style-type: none"> Replace. | Every 15000 km (9000 mi) | | | | | |
| 3 | Air filter check hose | <ul style="list-style-type: none"> Clean. | √ | √ | √ | √ | √ | |
| 4 | * Battery | <ul style="list-style-type: none"> Check voltage. Charge if necessary. | √ | √ | √ | √ | √ | √ |
| 5 | Clutch | <ul style="list-style-type: none"> Check operation. Adjust. | √ | √ | √ | √ | √ | |
| 6 | * Front brake | <ul style="list-style-type: none"> Check operation, fluid level and vehicle for fluid leakage. | √ | √ | √ | √ | √ | √ |
| | | <ul style="list-style-type: none"> Replace brake pads. | Whenever worn to the limit | | | | | |
| 7 | * Rear brake | <ul style="list-style-type: none"> Check operation, fluid level and vehicle for fluid leakage. | √ | √ | √ | √ | √ | √ |
| | | <ul style="list-style-type: none"> Replace brake pads. | Whenever worn to the limit | | | | | |
| 8 | * Brake hoses | <ul style="list-style-type: none"> Check for cracks or damage. Check for correct routing and clamping. | | √ | √ | √ | √ | √ |
| | | <ul style="list-style-type: none"> Replace. | Every 4 years | | | | | |
| 9 | * Brake fluid | <ul style="list-style-type: none"> Change. | Every 2 years | | | | | |
| 10 | * Wheels | <ul style="list-style-type: none"> Check runout and for damage. | | √ | √ | √ | √ | |

Periodic maintenance and adjustment

| NO. | ITEM | CHECK OR MAINTENANCE JOB | ODOMETER READING (whichever comes first) | | | | | ANNUAL CHECK |
|-----|-------------------------|---|--|---------------------------|-----------------------------|-----------------------------|-----------------------------|--------------|
| | | | 1000 km or 1 month | 5000 km or 5 months | 10000 km or 10 months | 15000 km or 15 months | 20000 km or 20 months | |
| 11 | * Tires | <ul style="list-style-type: none"> • Check tread depth and for damage. • Replace if necessary. • Check air pressure. • Correct if necessary. | | √ | √ | √ | √ | √ |
| 12 | * Wheel bearings | <ul style="list-style-type: none"> • Check bearings for looseness or damage. | | √ | √ | √ | √ | |
| 13 | * Swingarm | <ul style="list-style-type: none"> • Check operation and for excessive play. | | √ | √ | √ | √ | |
| | | <ul style="list-style-type: none"> • Lubricate with lithium-soap-based grease. | Every 20000 km (12000 mi) | | | | | |
| 14 | Drive chain | <ul style="list-style-type: none"> • Check chain slack, alignment and condition. • Adjust and lubricate chain with a special O-ring chain lubricant thoroughly. | Every 1000 km (600 mi) and after washing the motorcycle, riding in the rain or riding in wet areas | | | | | |
| 15 | * Steering bearings | <ul style="list-style-type: none"> • Check bearing play and steering for roughness. | √ | √ | √ | √ | √ | |
| | | <ul style="list-style-type: none"> • Lubricate with lithium-soap-based grease. | Every 20000 km (12000 mi) | | | | | |
| 16 | * Chassis fasteners | <ul style="list-style-type: none"> • Make sure that all nuts, bolts and screws are properly tightened. | | √ | √ | √ | √ | √ |
| 17 | Brake lever pivot shaft | <ul style="list-style-type: none"> • Lubricate with silicone grease. | | √ | √ | √ | √ | √ |
| 18 | Brake pedal pivot shaft | <ul style="list-style-type: none"> • Lubricate with lithium-soap-based grease. | | √ | √ | √ | √ | √ |

Periodic maintenance and adjustment

| NO. | ITEM | CHECK OR MAINTENANCE JOB | ODOMETER READING (whichever comes first) | | | | | ANNUAL CHECK |
|-----|---------------------------------|---|--|---------------------------|-----------------------------|-----------------------------|-----------------------------|--------------|
| | | | 1000 km or 1 month | 5000 km or 5 months | 10000 km or 10 months | 15000 km or 15 months | 20000 km or 20 months | |
| 19 | Clutch lever pivot shaft | <ul style="list-style-type: none"> Lubricate with lithium-soap-based grease. | | √ | √ | √ | √ | √ |
| 20 | Shift pedal pivot shaft | <ul style="list-style-type: none"> Lubricate with lithium-soap-based grease. | | √ | √ | √ | √ | √ |
| 21 | Sidestand | <ul style="list-style-type: none"> Check operation. Lubricate with lithium-soap-based grease. | | √ | √ | √ | √ | √ |
| 22 | * Front fork | <ul style="list-style-type: none"> Check operation and for oil leakage. | | √ | √ | √ | √ | |
| 23 | * Shock absorber assembly | <ul style="list-style-type: none"> Check operation and shock absorber for oil leakage. | | √ | √ | √ | √ | |
| 24 | Engine oil | <ul style="list-style-type: none"> Change. Check oil level and vehicle for oil leakage. | √ | √ | √ | √ | √ | |
| 25 | Engine oil filter cartridge | <ul style="list-style-type: none"> Replace. | √ | | | | √ | |
| 26 | * Cooling system | <ul style="list-style-type: none"> Check coolant level and vehicle for coolant leakage. | | √ | √ | √ | √ | √ |
| | | <ul style="list-style-type: none"> Change with Yamaha genuine coolant. | Every 3 years | | | | | |
| 27 | * Front and rear brake switches | <ul style="list-style-type: none"> Check operation. | √ | √ | √ | √ | √ | √ |
| 28 | Moving parts and cables | <ul style="list-style-type: none"> Lubricate. | | √ | √ | √ | √ | √ |

Periodic maintenance and adjustment

| NO. | ITEM | CHECK OR MAINTENANCE JOB | ODOMETER READING (whichever comes first) | | | | | ANNUAL CHECK |
|-----|------------------------------|--|--|---------------------------|-----------------------------|-----------------------------|-----------------------------|--------------|
| | | | 1000 km or 1 month | 5000 km or 5 months | 10000 km or 10 months | 15000 km or 15 months | 20000 km or 20 months | |
| 29 | Throttle grip | <ul style="list-style-type: none"> • Check operation. • Check throttle grip free play, and adjust if necessary. • Lubricate cable and grip housing. | | √ | √ | √ | √ | √ |
| 30 | Lights, signals and switches | <ul style="list-style-type: none"> • Check operation. • Adjust headlight beam. | √ | √ | √ | √ | √ | √ |

EAU18671

TIP

- The air filter needs more frequent service if you are riding in unusually wet or dusty areas.
- Hydraulic brake service
 - Regularly check and, if necessary, correct the brake fluid level.
 - Every two years replace the internal components of the brake master cylinders and calipers, and change the brake fluid.
 - Replace the brake hoses every four years and if cracked or damaged.

Periodic maintenance and adjustment

Checking the spark plugs

EAU19643

The spark plugs are important engine components, which should be checked periodically, preferably by a Yamaha dealer. Since heat and deposits will cause any spark plug to slowly erode, they should be removed and checked in accordance with the periodic maintenance and lubrication chart. In addition, the condition of the spark plugs can reveal the condition of the engine.

The porcelain insulator around the center electrode of each spark plug should be a medium-to-light tan (the ideal color when the vehicle is ridden normally), and all spark plugs installed in the engine should have the same color. If any spark plug shows a distinctly different color, the engine could be operating improperly. Do not attempt to diagnose such problems yourself. Instead, have a Yamaha dealer check the vehicle.

If a spark plug shows signs of electrode erosion and excessive carbon or other deposits, it should be replaced.

Specified spark plug:
NGK/CR9E

Before installing a spark plug, the spark plug gap should be measured with a wire thickness gauge and, if necessary, adjusted to specification.

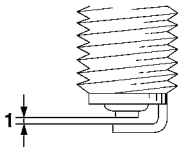

Spark plug gap:
0.7–0.8 mm (0.028–0.031 in)

Clean the surface of the spark plug gasket and its mating surface, and then wipe off any grime from the spark plug threads.

Tightening torque:
Spark plug:
13 N·m (1.3 kgf·m, 9.6 lb·ft)

TIP

If a torque wrench is not available when installing a spark plug, a good estimate of the correct torque is 1/4–1/2 turn past finger tight. However, the spark plug should be tightened to the specified torque as soon as possible.

Periodic maintenance and adjustment

EJU62632

Engine oil and oil filter cartridge

The engine oil level should be checked before each ride. In addition, the oil must be changed and the oil filter cartridge replaced at the intervals specified in the periodic maintenance and lubrication chart.

To check the engine oil level

1. Place the vehicle on a level surface and hold it in an upright position. A slight tilt to the side can result in a false reading.
2. Start the engine, warm it up for several minutes, and then turn it off.
3. Wait a few minutes until the oil settles, and then check the oil level through the engine oil level check window located at the bottom-right side of the crankcase.

TIP

The engine oil should be between the minimum and maximum level marks.

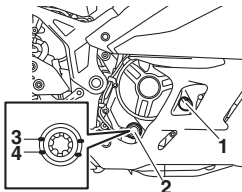

1. Engine oil filler cap
2. Engine oil level check window
3. Maximum level mark
4. Minimum level mark

4. If the engine oil is below the minimum level mark, add sufficient oil of the recommended type to raise it to the correct level.

To change the engine oil (with or without oil filter cartridge replacement)

1. Place the vehicle on a level surface.
2. Start the engine, warm it up for several minutes, and then turn it off.
3. Place an oil pan under the engine to collect the used oil.

4. Remove the engine oil filler cap, the engine oil drain bolt and its gasket to drain the oil from the crankcase.

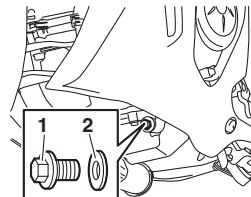

1. Engine oil drain bolt
2. Gasket

TIP

Skip steps 5–7 if the oil filter cartridge is not being replaced.

5. Remove the oil filter cartridge with an oil filter wrench.

Periodic maintenance and adjustment

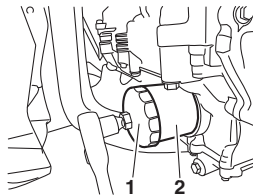

1. Oil filter wrench
2. Oil filter cartridge

TIP

An oil filter wrench is available at a Yamaha dealer.

6. Apply a thin coat of clean engine oil to the O-ring of the new oil filter cartridge.

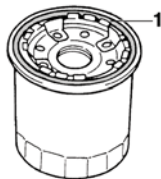

1. O-ring

TIP

Make sure that the O-ring is properly seated.

7. Install the new oil filter cartridge with an oil filter wrench, and then tighten it to the specified torque with a torque wrench.

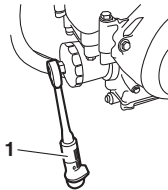

1. Torque wrench

Tightening torque:

Oil filter cartridge:
17 N·m (1.7 kgf·m, 13 lb·ft)

8. Install the engine oil drain bolt and its new gasket, and then tighten the bolt to the specified torque.

TIP

Install the new gasket as shown.

Periodic maintenance and adjustment

ECA20860

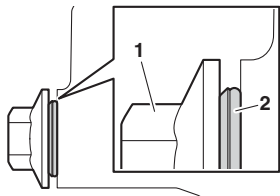

1. Engine oil drain bolt
2. Gasket

Tightening torque:

Engine oil drain bolt:
20 N·m (2.0 kgf·m, 15 lb·ft)

9. Refill with the specified amount of the recommended engine oil, and then install and tighten the oil filler cap.

Recommended engine oil:

See page 9-1.

Oil quantity:

Oil change:

1.80 L (1.90 US qt, 1.58 Imp.qt)

With oil filter removal:

2.10 L (2.22 US qt, 1.85 Imp.qt)

TIP

Be sure to wipe off spilled oil on any parts after the engine and exhaust system have cooled down.

NOTICE

ECA11621

- In order to prevent clutch slippage (since the engine oil also lubricates the clutch), do not mix any chemical additives. Do not use oils with a diesel specification of "CD" or oils of a higher quality than specified. In addition, do not use oils labeled "ENERGY CONSERVING II" or higher.
- Make sure that no foreign material enters the crankcase.

10. Start the engine, and then let it idle for several minutes while checking it for oil leakage. If oil is leaking, immediately turn the engine off and check for the cause.

TIP

After the engine is started, the engine oil pressure warning light should go off.

NOTICE

If the oil pressure warning light flickers or remains on even if the oil level is correct, immediately turn the engine off and have a Yamaha dealer check the vehicle.

11. Turn the engine off, wait a few minutes until the oil settles, and then check the oil level and correct it if necessary.

Periodic maintenance and adjustment

Coolant

The coolant level should be checked before each ride. In addition, the coolant must be changed at the intervals specified in the periodic maintenance and lubrication chart.

EAU20071

To check the coolant level

EAUN2231

1. Place the vehicle on a level surface and hold it in an upright position.

TIP

- The coolant level must be checked on a cold engine since the level varies with engine temperature.
- Make sure that the vehicle is positioned straight up when checking the coolant level. A slight tilt to the side can result in a false reading.

2. Remove the left side panel by removing the bolts.

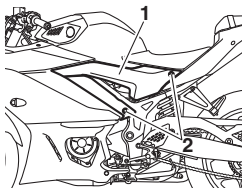

1. Left side panel
2. Bolt

3. Check the coolant level in the coolant reservoir.

TIP

The coolant should be between the minimum and maximum level marks.

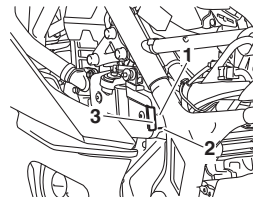

1. Maximum level mark
2. Minimum level mark
3. Coolant reservoir

4. If the coolant is at or below the minimum level mark, remove the upper panel, left side cowling and coolant reservoir cover to access the coolant reservoir.

Periodic maintenance and adjustment

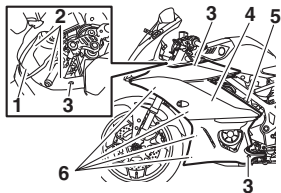

1. Upper panel
2. Quick fastener
3. Bolt
4. Left side cowling
5. Nut and washer
6. Screw

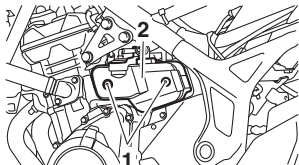

1. Bolt
2. Coolant reservoir cover

5. Remove the coolant reservoir cap, add coolant to the maximum level mark, and then install the reservoir cap. **WARNING! Remove only the coolant reservoir cap. Never attempt to remove the radiator cap when the engine is hot.**

[EWA15162] **NOTICE:** If coolant is not available, use distilled water or soft tap water instead. Do not use hard water or salt water since it is harmful to the engine. If water has been used instead of coolant, replace it with coolant as soon as possible, otherwise the cooling system will not be protected against frost and corrosion. If water has been added to the coolant, have a Yamaha dealer check the anti-freeze content of the coolant as soon as possible, otherwise the effectiveness of the coolant will be reduced. [ECA10473]

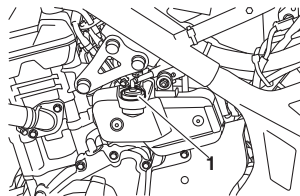

1. Coolant reservoir cap

Coolant reservoir capacity (up to the maximum level mark):
0.25 L (0.26 US qt, 0.22 Imp.qt)

6. Install the coolant reservoir cover.
7. Install the left side cowling and then install the upper panel.

TIP

Fit the projections on the cowling into the holes as shown.

Periodic maintenance and adjustment

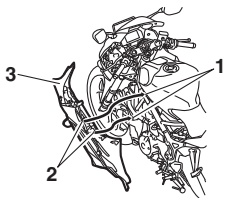

1. Hole
2. Projection
3. Left side cowling

8. Install the left side panel.

Changing the coolant

EAU33032

The coolant must be changed at the intervals specified in the periodic maintenance and lubrication chart. Have a Yamaha dealer change the coolant. **WARNING! Never attempt to remove the radiator cap when the engine is hot.** [EWA10382]

Replacing the air filter element and cleaning the check hose

EAU2240

The air filter element should be replaced at the intervals specified in the periodic maintenance and lubrication chart. Replace the air filter element more frequently if you are riding in unusually wet or dusty areas. In addition, the air filter check hose must be frequently checked and cleaned if necessary.

To replace the air filter element

1. Remove the rider seat. (See page 4-16.)
2. Remove the left side panel by removing the bolts.

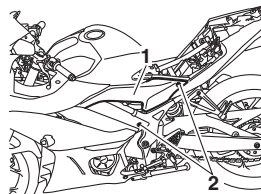

1. Left side panel
2. Bolt

3. Remove the fuel tank cover by removing the bolts and quick fasteners.

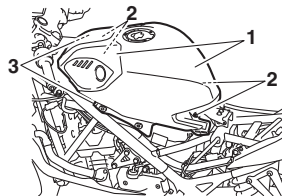

1. Fuel tank cover
2. Bolt
3. Quick fastener

Periodic maintenance and adjustment

4. Remove the air filter case cover by removing the screws.

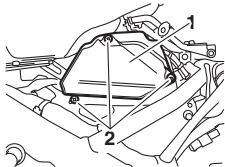

1. Air filter case cover
2. Screw

5. Pull the air filter element out.

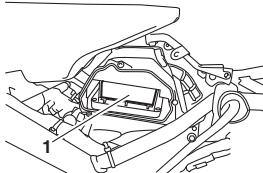

1. Air filter element

6. Insert a new air filter element into the air filter case. **NOTICE: Make sure that the air filter element is**

properly seated in the air filter case. The engine should never be operated without the air filter element installed, otherwise the piston(s) and/or cylinder(s) may become excessively worn.

[ECA10482]

7. Install the air filter case cover by installing the screws.
8. Install the fuel tank cover by installing the bolts and quick fasteners.
9. Install the left side panel by installing the bolts.
10. Install the rider seat.

To clean the air filter check hose

1. Check the hose on the front of the air filter case for accumulated dirt or water.

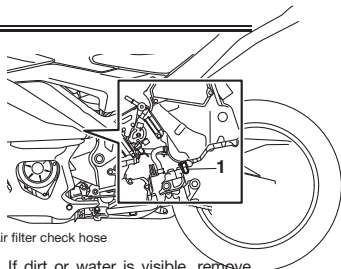

1. Air filter check hose
2. If dirt or water is visible, remove the hose, clean it, and then install it.

Periodic maintenance and adjustment

EAU21386

Checking the throttle grip free play

Measure the throttle grip free play as shown.

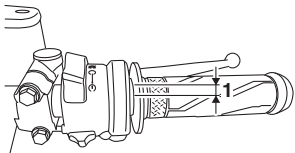

1. Throttle grip free play

Throttle grip free play:
3.0–5.0 mm (0.12–0.20 in)

Periodically check the throttle grip free play and, if necessary, have a Yamaha dealer adjust it.

Valve clearance

The valves are an important engine component, and since valve clearance changes with use, they must be checked and adjusted at the intervals specified in the periodic maintenance chart. Unadjusted valves can result in improper air-fuel mixture, engine noise, and eventually engine damage. To prevent this from occurring, have your Yamaha dealer check and adjust the valve clearance at regular intervals.

TIP

This service must be performed when the engine is cold.

EAU21403

Tires

Tires are the only contact between the vehicle and the road. Safety in all conditions of riding depends on a relatively small area of road contact. Therefore, it is essential to maintain the tires in good condition at all times and replace them at the appropriate time with the specified tires.

Tire air pressure

The tire air pressure should be checked and, if necessary, adjusted before each ride.

EWA10504



WARNING

Operation of this vehicle with improper tire pressure may cause severe injury or death from loss of control.

- The tire air pressure must be checked and adjusted on cold tires (i.e., when the temperature of the tires equals the ambient temperature).
- The tire air pressure must be adjusted in accordance with the riding speed and with the total

Periodic maintenance and adjustment

weight of rider, passenger, cargo, and accessories approved for this model.

Tire air pressure (measured on cold tires):

1 person:

Front:

200 kPa (2.00 kgf/cm², 29 psi)

Rear:

225 kPa (2.25 kgf/cm², 33 psi)

2 persons:

Front:

200 kPa (2.00 kgf/cm², 29 psi)

Rear:

225 kPa (2.25 kgf/cm², 33 psi)

Maximum load*:

160 kg (353 lb)

* Total weight of rider, passenger, cargo and accessories

EWA10512

WARNING

Never overload your vehicle. Operation of an overloaded vehicle could cause an accident.

Tire inspection

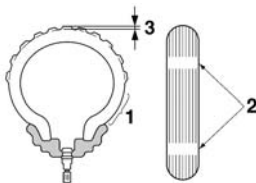

1. Tire sidewall
2. Tire wear indicator
3. Tire tread depth

The tires must be checked before each ride. If a tire tread shows crosswise lines (minimum tread depth), if the tire has a nail or glass fragments in it, or if the sidewall is cracked, contact a Yamaha dealer immediately and have the tire replaced.

Minimum tire tread depth (front and rear):

1.0 mm (0.04 in)

EWA10583

WARNING

- It is dangerous to ride with a worn-out tire. When a tire tread begins to show crosswise lines, have a Yamaha dealer replace the tire immediately.
- The replacement of all wheel and brake-related parts, including the tires, should be left to a Yamaha dealer, who has the necessary professional knowledge and experience to do so.
- Ride at moderate speeds after changing a tire since the tire surface must first be “broken in” for it to develop its optimal characteristics.

Tire information

This model is equipped with tubeless tires and tire air valves.

Tires age, even if they have not been used or have only been used occasionally. Cracking of the tread and sidewall rubber, sometimes accompanied by carcass deformation, is an evidence of

Periodic maintenance and adjustment

ageing. Old and aged tires shall be checked by tire specialists to ascertain their suitability for further use.

EWA10462

⚠ WARNING

The front and rear tires should be of the same make and design, otherwise the handling characteristics of the vehicle may be different, which could lead to an accident.

After extensive tests, only the tires listed below have been approved for this model by Yamaha.

Front tire:

Size:

110/70-17M/C (54S)

Manufacturer/model:

IRC/RX-01F

Rear tire:

Size:

140/70-17M/C (66S)

Manufacturer/model:

IRC/RX-01R

Cast wheels

To maximize the performance, durability, and safe operation of your vehicle, note the following points regarding the specified wheels.

- The wheel rims should be checked for cracks, bends, warpage or other damage before each ride. If any damage is found, have a Yamaha dealer replace the wheel. Do not attempt even the smallest repair to the wheel. A deformed or cracked wheel must be replaced.
- The wheel should be balanced whenever either the tire or wheel has been changed or replaced. An unbalanced wheel can result in poor performance, adverse handling characteristics, and a shortened tire life.

EAU21963

Adjusting the clutch lever free play

Measure the clutch lever free play as shown.

EJUN2251

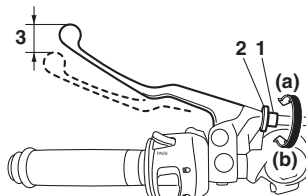

1. Clutch lever free play adjusting bolt
2. Locknut
3. Clutch lever free play

Clutch lever free play:

10.0–15.0 mm (0.39–0.59 in)

Periodically check the clutch lever free play and, if necessary, adjust it as follows.

1. Loosen the locknut at the clutch lever.
2. To increase the clutch lever free play, turn the clutch lever free play adjusting bolt in direction (a). To

Periodic maintenance and adjustment

decrease the clutch lever free play, turn the adjusting bolt in direction (b).

TIP

If the specified clutch lever free play could be obtained as described above, skip steps 3–8.

3. Fully turn the adjusting bolt at the clutch lever in direction (a) to loosen the clutch cable.
4. Remove the right side panel by removing the bolts.

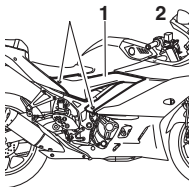

1. Right side panel
2. Bolt

5. Remove the upper panel and the right side cowling.

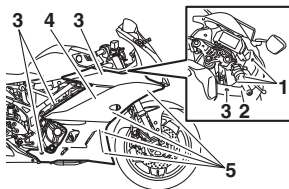

1. Quick fastener
2. Upper panel
3. Bolt
4. Right side cowling
5. Screw

6. Loosen the locknut at the crankcase.
7. To increase the clutch lever free play, turn the clutch lever free play adjusting nut in direction (a). To decrease the clutch lever free play, turn the adjusting nut in direction (b).

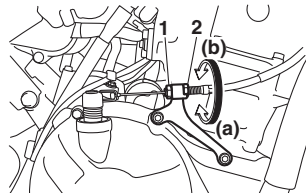

1. Locknut
2. Clutch lever free play adjusting nut

8. Tighten the locknut at the crankcase.
9. Install the right side cowling and then install the upper panel.

TIP

Fit the projections on the cowling into the holes as shown.

Periodic maintenance and adjustment

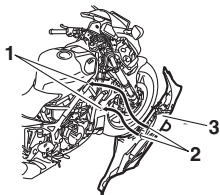

1. Hole
2. Projection
3. Right side cowling

10. Install the right side panel.
11. Tighten the locknut at the clutch lever.

Checking the brake lever free play

EAU37914

braking performance, which may result in loss of control and an accident.

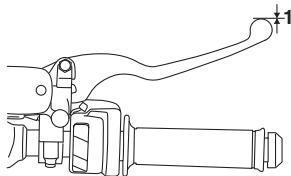

1. No brake lever free play

There should be no free play at the brake lever end. If there is free play, have a Yamaha dealer inspect the brake system.

EWA14212

WARNING

A soft or spongy feeling in the brake lever can indicate the presence of air in the hydraulic system. If there is air in the hydraulic system, have a Yamaha dealer bleed the system before operating the vehicle. Air in the hydraulic system will diminish the

Periodic maintenance and adjustment

Brake light switches

EAUJ22275

The brake light is activated by switches connected to the brake lever and brake pedal. Check that the brake light comes on just before braking takes effect. If necessary, adjust the rear brake light switch as follows.

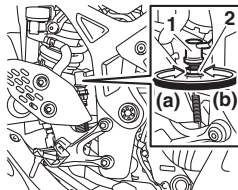

1. Rear brake light switch
2. Rear brake light switch adjusting nut

Turn the rear brake light switch adjusting nut while holding the rear brake light switch in place. To make the brake light come on earlier, turn the adjusting nut in direction (a). To make the brake light come on later, turn the adjusting nut in direction (b).

TIP

The front brake light switch should be serviced by a Yamaha dealer.

Checking the front and rear brake pads

EAUJ22393

The front and rear brake pads must be checked for wear at the intervals specified in the periodic maintenance and lubrication chart.

Front brake pads

EAUJ22433

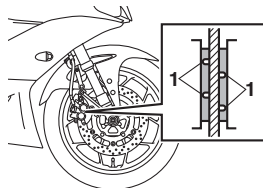

1. Brake pad wear indicator groove

Each front brake pad is provided with wear indicator grooves, which allow you to check the brake pad wear without having to disassemble the brake. To check the brake pad wear, check the wear indicator grooves. If a brake pad has worn to the point that the wear

Periodic maintenance and adjustment

indicator grooves have almost disappeared, have a Yamaha dealer replace the brake pads as a set.

Rear brake pads

EAU36721

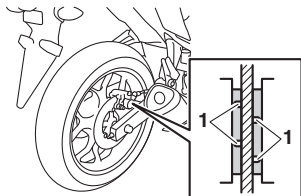

1. Brake pad wear indicator groove

Each rear brake pad is provided with wear indicator grooves, which allow you to check the brake pad wear without having to disassemble the brake. To check the brake pad wear, check the wear indicator grooves. If a brake pad has worn to the point that the wear indicator grooves have almost disappeared, have a Yamaha dealer replace the brake pads as a set.

Checking the brake fluid level

EAU60680

Before riding, check that the brake fluid is above the minimum level mark. Check the brake fluid level with the top of the reservoir level. Replenish the brake fluid if necessary.

Front brake

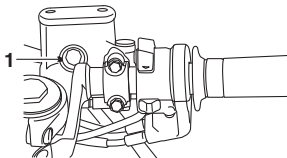

1. Minimum level mark

Rear brake

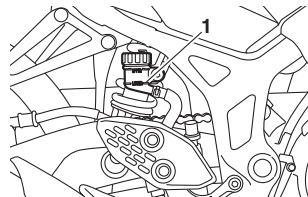

1. Minimum level mark

Specified brake fluid:
DOT 4

⚠ WARNING

Improper maintenance can result in loss of braking ability. Observe these precautions:

- Insufficient brake fluid may allow air to enter the brake system, reducing braking performance.
- Clean the filler cap before removing. Use only DOT 4 brake fluid from a sealed container.

EWA15991

Periodic maintenance and adjustment

- Use only the specified brake fluid; otherwise, the rubber seals may deteriorate, causing leakage.
- Refill with the same type of brake fluid. Adding a brake fluid other than DOT 4 may result in a harmful chemical reaction.
- Be careful that water does not enter the brake fluid reservoir when refilling. Water will significantly lower the boiling point of the fluid and may result in vapor lock.

fluid level goes down suddenly, have a Yamaha dealer check the cause before further riding.

Changing the brake fluid

EAUJ22734

Have a Yamaha dealer change the brake fluid every 2 years. In addition, have the seals of the master cylinders and brake calipers, as well as the brake hoses replaced at the intervals listed below or sooner if they are damaged or leaking.

- Brake seals: every 2 years
- Brake hoses: every 4 years

7

NOTICE

ECA17641

Brake fluid may damage painted surfaces or plastic parts. Always clean up spilled fluid immediately.

As the brake pads wear, it is normal for the brake fluid level to gradually go down. A low brake fluid level may indicate worn brake pads and/or brake system leakage; therefore, be sure to check the brake pads for wear and the brake system for leakage. If the brake

Periodic maintenance and adjustment

Drive chain slack

The drive chain slack should be checked before each ride and adjusted if necessary.

EAU22762

To check the drive chain slack

EAU2277G

1. Place the motorcycle on the side-stand.

TIP

When checking and adjusting the drive chain slack, there should be no weight on the motorcycle.

2. Shift the transmission into the neutral position.
3. Measure the drive chain slack as shown.

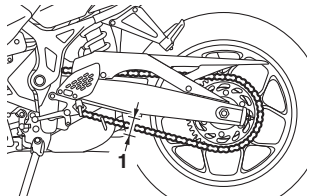

1. Drive chain slack

Drive chain slack:

35.0–45.0 mm (1.38–1.77 in)

4. If the drive chain slack is incorrect, adjust it as follows. **NOTICE: Improper drive chain slack will overload the engine as well as other vital parts of the motorcycle and can lead to chain slippage or breakage. If the drive chain slack is more than , the chain can damage the frame, swingarm, and other parts. To prevent this from occurring, keep the drive chain slack within the specified limits.** [ECA17791]

EAU62983

To adjust the drive chain slack

Consult a Yamaha dealer before adjusting the drive chain slack.

1. Remove the drive chain puller cap, and then loosen the axle nut and the locknut on each side of the swingarm.

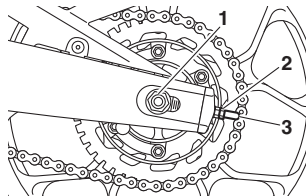

1. Axle nut

2. Locknut

3. Drive chain puller cap

2. To tighten the drive chain, turn the drive chain slack adjusting nut on each side of the swingarm in direction (a). To loosen the drive chain, turn the adjusting nut on each side of the swingarm in direction (b), and then push the rear wheel forward.

Periodic maintenance and adjustment

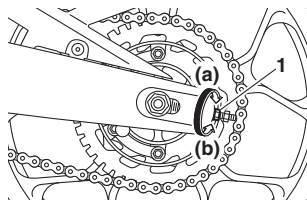

1. Drive chain slack adjusting nut

TIP

Using the alignment marks on each side of the swingarm, make sure that both drive chain pullers are in the same position for proper wheel alignment.

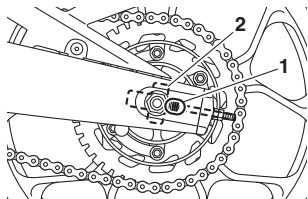

1. Alignment marks
2. Drive chain puller

3. Tighten the axle nut, then the locknuts to their specified torques.

Tightening torques:

| | |
|-----------|------------------------------|
| Axle nut: | 57 N·m (5.7 kgf·m, 42 lb·ft) |
| Locknut: | 16 N·m (1.6 kgf·m, 12 lb·ft) |

4. Make sure that the drive chain pullers are in the same position, the drive chain slack is correct, and the drive chain moves smoothly.
5. Install the drive chain puller caps.

EAU23026

Cleaning and lubricating the drive chain

The drive chain must be cleaned and lubricated at the intervals specified in the periodic maintenance and lubrication chart, otherwise it will quickly wear out, especially when riding in dusty or wet areas. Service the drive chain as follows.

ECA10584

NOTICE

The drive chain must be lubricated after washing the motorcycle, riding in the rain or riding in wet areas.

1. Clean the drive chain with kerosene and a small soft brush. **NOTICE: To prevent damaging the O-rings, do not clean the drive chain with steam cleaners, high-pressure washers or inappropriate solvents.** [ECA11122]
2. Wipe the drive chain dry.
3. Thoroughly lubricate the drive chain with a special O-ring chain lubricant. **NOTICE: Do not use engine oil or any other lubricants for the drive chain, as they**

Periodic maintenance and adjustment

may contain substances that could damage the O-rings.

[ECA11112]

Checking and lubricating the cables

EALU23098

The operation of all control cables and the condition of the cables should be checked before each ride, and the cables and cable ends should be lubricated if necessary. If a cable is damaged or does not move smoothly, have a Yamaha dealer check or replace it. **WARNING! Damage to the outer housing of cables may result in internal rusting and cause interference with cable movement. Replace damaged cables as soon as possible to prevent unsafe conditions.** [EWA10712]

Recommended lubricant:

Yamaha cable lubricant or other suitable cable lubricant

Checking and lubricating the throttle grip and cable

EALU49921

The operation of the throttle grip should be checked before each ride. In addition, the cable should be lubricated by a Yamaha dealer at the intervals specified in the periodic maintenance chart.

Periodic maintenance and adjustment

Checking and lubricating the brake and shift pedals

EALJ44276

The operation of the brake and shift pedals should be checked before each ride, and the pedal pivots should be lubricated if necessary.

Brake pedal

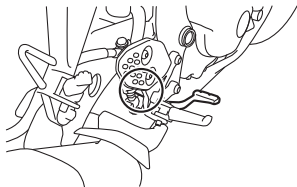

Shift pedal

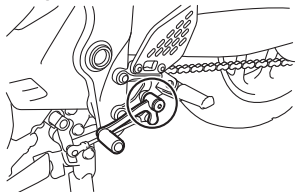

Recommended lubricant:
Lithium-soap-based grease

Checking and lubricating the brake and clutch levers

EALJ23144

The operation of the brake and clutch levers should be checked before each ride, and the lever pivots should be lubricated if necessary.

Brake lever

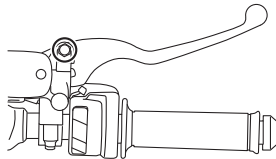

Clutch lever

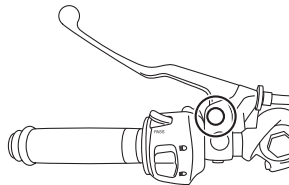

Periodic maintenance and adjustment

Recommended lubricants:

- Brake lever:
 - Silicone grease
- Clutch lever:
 - Lithium-soap-based grease

Checking and lubricating the sidestand

EAU23203

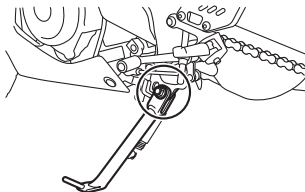

The operation of the sidestand should be checked before each ride, and the sidestand pivot and metal-to-metal contact surfaces should be lubricated if necessary.

EWA10732

⚠ WARNING

If the sidestand does not move up and down smoothly, have a Yamaha dealer check or repair it. Otherwise, the sidestand could contact the ground and distract the operator, resulting in a possible loss of control.

Recommended lubricant:
Lithium-soap-based grease

Lubricating the swingarm pivots

EAUM1653

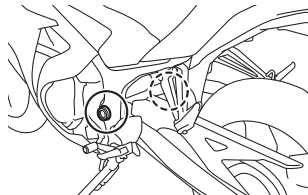

The swingarm pivots must be lubricated by a Yamaha dealer at the intervals specified in the periodic maintenance and lubrication chart.

Recommended lubricant:
Lithium-soap-based grease

Periodic maintenance and adjustment

Checking the front fork

EAU23273

The condition and operation of the front fork must be checked as follows at the intervals specified in the periodic maintenance and lubrication chart.

To check the condition

Check the inner tubes for scratches, damage and excessive oil leakage.

To check the operation

1. Place the vehicle on a level surface and hold it in an upright position. **WARNING! To avoid injury, securely support the vehicle so there is no danger of it falling over.** [EWA10752]
2. While applying the front brake, push down hard on the handlebars several times to check if the front fork compresses and rebounds smoothly.

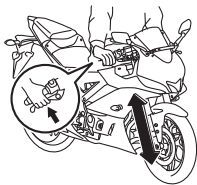

ECA10591

NOTICE

If any damage is found or the front fork does not operate smoothly, have a Yamaha dealer check or repair it.

Checking the steering

EAU23285

Worn or loose steering bearings may cause danger. Therefore, the operation of the steering must be checked as follows at the intervals specified in the periodic maintenance and lubrication chart.

1. Raise the front wheel off the ground. (See page 7-36.) **WARNING! To avoid injury, securely support the vehicle so there is no danger of it falling over.** [EWA10752]
2. Hold the lower ends of the front fork legs and try to move them forward and backward. If any free play can be felt, have a Yamaha dealer check or repair the steering.

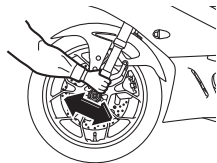

Periodic maintenance and adjustment

Checking the wheel bearings

EAU23292

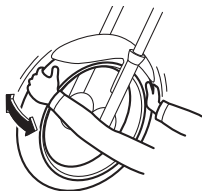

The front and rear wheel bearings must be checked at the intervals specified in the periodic maintenance and lubrication chart. If there is play in the wheel hub or if the wheel does not turn smoothly, have a Yamaha dealer check the wheel bearings.

Battery

EAU62521

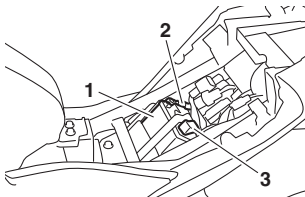

1. Battery
2. Negative battery lead (black)
3. Positive battery lead (red)

The battery is located under the rider seat. (See page 4-16.)

This model is equipped with a VRLA (Valve Regulated Lead Acid) battery. There is no need to check the electrolyte or to add distilled water. However, the battery lead connections need to be checked and, if necessary, tightened.

EWA10761

⚠ WARNING

- **Electrolyte is poisonous and dangerous since it contains sulfuric acid, which causes severe**

burns. Avoid any contact with skin, eyes or clothing and always shield your eyes when working near batteries. In case of contact, administer the following **FIRST AID**.

- **EXTERNAL:** Flush with plenty of water.
- **INTERNAL:** Drink large quantities of water or milk and immediately call a physician.
- **EYES:** Flush with water for 15 minutes and seek prompt medical attention.
- Batteries produce explosive hydrogen gas. Therefore, keep sparks, flames, cigarettes, etc., away from the battery and provide sufficient ventilation when charging it in an enclosed space.
- **KEEP THIS AND ALL BATTERIES OUT OF THE REACH OF CHILDREN.**

Periodic maintenance and adjustment

ECA10621

NOTICE

Never attempt to remove the battery cell seals, as this would permanently damage the battery.

To charge the battery

Have a Yamaha dealer charge the battery as soon as possible if it seems to have discharged. Keep in mind that the battery tends to discharge more quickly if the vehicle is equipped with optional electrical accessories.

ECA16522

NOTICE

To charge a VRLA (Valve Regulated Lead Acid) battery, a special (constant-voltage) battery charger is required. Using a conventional battery charger will damage the battery.

To store the battery

1. If the vehicle will not be used for more than one month, remove the battery, fully charge it, and then place it in a cool, dry place.
NOTICE: When removing the battery, be sure the key is

turned to "OFF", then disconnect the negative lead before disconnecting the positive lead. [ECA17712]

2. If the battery will be stored for more than two months, check it at least once a month and fully charge it if necessary.
3. Fully charge the battery before installation. **NOTICE:** When installing the battery, be sure the key is turned to "OFF", then connect the positive lead before connecting the negative lead. [ECA17722]
4. After installation, make sure that the battery leads are properly connected to the battery terminals.

ECA16531

NOTICE

Always keep the battery charged. Storing a discharged battery can cause permanent battery damage.

EAU62773

Replacing the fuses

The main fuse is located under the passenger seat. The fuse box, which contains the fuses for the individual circuits, is located behind the center panel. (See page 4-16.)

To access the main fuse, proceed as follows.

1. Remove the passenger seat. (See page 4-16.)
2. Remove the tray by removing the quick fasteners.

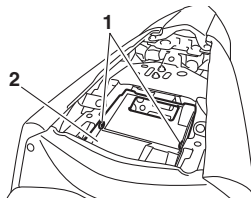

1. Quick fastener

2. Tray

3. Pull back the starter relay cover.

Periodic maintenance and adjustment

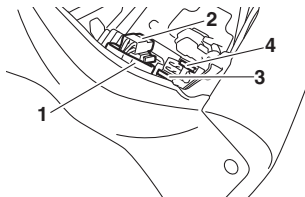

1. Starter relay cover
2. Starter relay coupler
3. Main fuse
4. Spare main fuse

4. Disconnect the starter relay coupler by pressing from both sides.
5. Connect the starter relay coupler, and then slide the cover to its original position.
6. Place the tray in its original position, and then install the quick fasteners.
7. Install the passenger seat.

TIP

To access the fuse box, remove the center cover. (See page 4-16.)

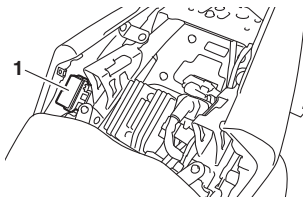

1. Fuse box

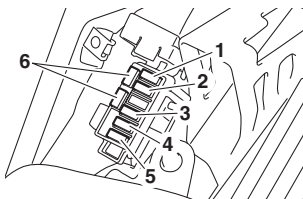

1. Ignition fuse
2. Signaling system fuse
3. Headlight fuse
4. Backup fuse (for clock)
5. Radiator fan motor fuse
6. Spare fuse

If a fuse is blown, replace it as follows.

1. Turn the key to “ \times ” and turn off the electrical circuit in question.
2. Remove the blown fuse, and then install a new fuse of the specified amperage. **WARNING! Do not use a fuse of a higher amperage rating than recommended to avoid causing extensive damage to the electrical system and possibly a fire.** [EWA15132]

Specified fuses:

- Main fuse:
30.0 A
- Headlight fuse:
7.5 A
- Signaling system fuse:
15.0 A
- Ignition fuse:
15.0 A
- Radiator fan motor fuse:
7.5 A
- Backup fuse:
7.5 A

3. Turn the key to “O” and turn on the electrical circuit in question to check if the device operates.
4. If the fuse immediately blows again, have a Yamaha dealer check the electrical system.

Periodic maintenance and adjustment

Vehicle lights

This model is equipped with LED lights for headlights, auxiliary lights and brake/tail light. If a light does not come on, check the fuse and then have a Yamaha dealer check the vehicle.

EAUJ2261

ECA16581

NOTICE

Do not affix any type of tinted film or stickers to the headlight lens.

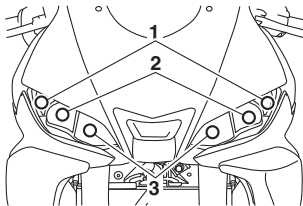

1. Auxiliary light
2. Headlight (low beam)
3. Headlight (high beam)

Replacing a turn signal light bulb

EAUJ62590

1. Remove the turn signal light lens by removing the screw.

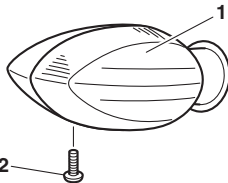

1. Turn signal light lens
2. Screw

2. Remove the turn signal light bulb socket (together with the bulb) by turning it counterclockwise.

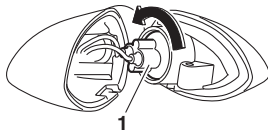

1. Turn signal light bulb socket
3. Remove the burnt-out bulb by pulling it out.
4. Insert a new bulb into the socket.
5. Install the socket (together with the bulb) by turning it clockwise.
6. Install the turn signal light lens by installing the screw. **NOTICE: Do not overtighten the screw, otherwise the lens may break.**

[ECA11192]

Periodic maintenance and adjustment

Replacing the license plate light bulb

EAL62670

1. Remove the mudguard by removing the quick fasteners.

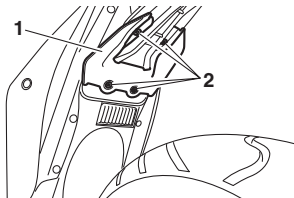

1. Mudguard
2. Quick fastener

2. Remove the rear fender lower panel by removing the bolts and screws.

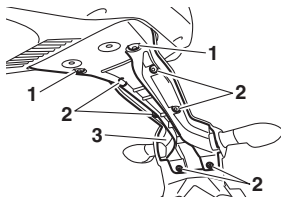

1. Bolt
2. Screw
3. Rear fender lower panel

3. Remove the license plate light bulb socket (together with the bulb) by pulling it out.
4. Remove the burnt-out bulb by pulling it out.

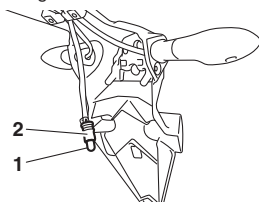

1. License plate light bulb
2. License plate light bulb socket

5. Insert a new bulb into the socket.
6. Install the socket (together with the bulb) by pushing it in.
7. Install the rear fender lower panel by installing the bolts and screws.
8. Install the mudguard by installing the quick fasteners.

Periodic maintenance and adjustment

Supporting the motorcycle

EAU24351

Since this model is not equipped with a centerstand, follow these precautions when removing the front and rear wheel or performing other maintenance requiring the motorcycle to stand upright. Check that the motorcycle is in a stable and level position before starting any maintenance. A strong wooden box can be placed under the engine for added stability.

To service the front wheel

1. Stabilize the rear of the motorcycle by using a motorcycle stand or, if an additional motorcycle stand is not available, by placing a jack under the frame in front of the rear wheel.
2. Raise the front wheel off the ground by using a motorcycle stand.

To service the rear wheel

Raise the rear wheel off the ground by using a motorcycle stand or, if a motorcycle stand is not available, by placing

a jack either under each side of the frame in front of the rear wheel or under each side of the swingarm.

Front wheel

EAU24361

EAU62605

To remove the front wheel

EWA10822

⚠ WARNING

To avoid injury, securely support the vehicle so there is no danger of it falling over.

1. Loosen the axle nut and the brake caliper bolts.

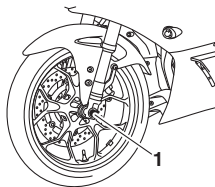

1. Axle nut

Periodic maintenance and adjustment

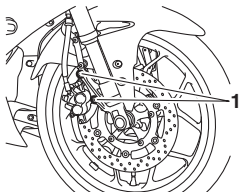

1. Brake caliper bolt
2. Lift the front wheel off the ground according to the procedure in the previous section "Supporting the motorcycle".
3. Remove the brake caliper by removing the bolts. **NOTICE: Do not apply the brake after the brake caliper has been removed, otherwise the brake pads will be forced shut.** [ECA22240]
4. Remove the axle nut.
5. Pull the wheel axle out, and then remove the wheel.

To install the front wheel

1. Lift the wheel up between the fork legs.

2. Insert the wheel axle from the right side and then install the axle nut.
3. Install the brake caliper by installing the bolts.

TIP

Make sure that there is enough space between the brake pads before installing the brake caliper onto the brake disc.

4. Lower the front wheel so that it is on the ground, and then put the sidestand down.
5. Tighten the axle nut and the brake caliper bolts to the specified torques.

Tightening torques:

Axle nut:

60 N·m (6.0 kgf·m, 44 lb·ft)

Brake caliper bolt:

35 N·m (3.5 kgf·m, 26 lb·ft)

6. Push down hard on the handlebar several times to check for proper fork operation.

Rear wheel

EAU25081

EAU62612

To remove the rear wheel

EWA10822

WARNING

To avoid injury, securely support the vehicle so there is no danger of it falling over.

1. Remove the drive chain puller cap, and then loosen the locknut and drive chain slack adjusting nut on each side of the swingarm.
2. Loosen the axle nut.

Periodic maintenance and adjustment

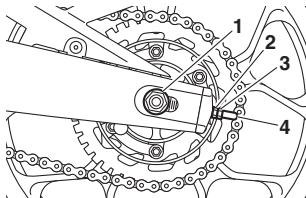

1. Axle nut
2. Drive chain slack adjusting nut
3. Locknut
4. Drive chain puller cap

3. Lift the rear wheel off the ground according to the procedure on page 7-36.
4. Remove the axle nut.
5. Push the wheel forward, and then remove the drive chain from the rear sprocket.

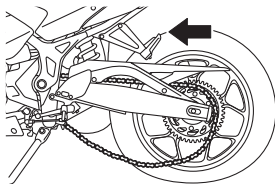

TIP

The drive chain does not need to be disassembled in order to remove and install the rear wheel.

6. While supporting the brake caliper and slightly lifting the wheel, pull the wheel axle out.

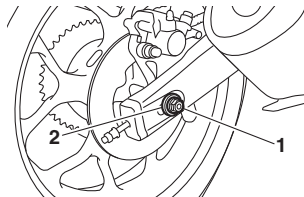

1. Wheel axle
2. Washer

TIP

A rubber mallet may be useful to tap the wheel axle out.

7. Remove the wheel. **NOTICE: Do not apply the brake after the wheel and brake disc have been removed, otherwise the brake pads will be forced shut.** [ECA11073]

To install the rear wheel

1. Install the wheel and the brake caliper bracket by inserting the wheel axle from the left-hand side.

TIP

1. Make sure that the slot in the brake caliper bracket is fit over the retainer on the swingarm.
2. Make sure that there is enough space between the brake pads before installing the wheel.

Periodic maintenance and adjustment

EAU25872

7. Install the drive chain puller caps.

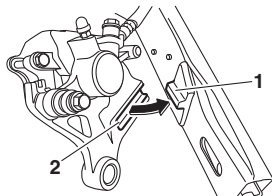

1. Retainer
2. Slot

2. Install the drive chain onto the rear sprocket.
3. Install the axle nut.
4. Lower the rear wheel so that it is on the ground, and then put the sidestand down.
5. Adjust the drive chain slack. (See page 7-25.)
6. Tighten the axle nut, and then tighten the locknuts to the specified torques.

Tightening torques:

Axle nut:

57 N·m (5.7 kgf·m, 42 lb·ft)

Locknut:

16 N·m (1.6 kgf·m, 12 lb·ft)

Troubleshooting

Although Yamaha motorcycles receive a thorough inspection before shipment from the factory, trouble may occur during operation. Any problem in the fuel, compression, or ignition systems, for example, can cause poor starting and loss of power.

The following troubleshooting charts represent quick and easy procedures for checking these vital systems yourself. However, should your motorcycle require any repair, take it to a Yamaha dealer, whose skilled technicians have the necessary tools, experience, and know-how to service the motorcycle properly.

Use only genuine Yamaha replacement parts. Imitation parts may look like Yamaha parts, but they are often inferior, have a shorter service life and can lead to expensive repair bills.

EWA15142



WARNING

When checking the fuel system, do not smoke, and make sure there are no open flames or sparks in the area, including pilot lights from water

Periodic maintenance and adjustment

heaters or furnaces. Gasoline or gasoline vapors can ignite or explode, causing severe injury or property damage.

Troubleshooting charts

Starting problems or poor engine performance

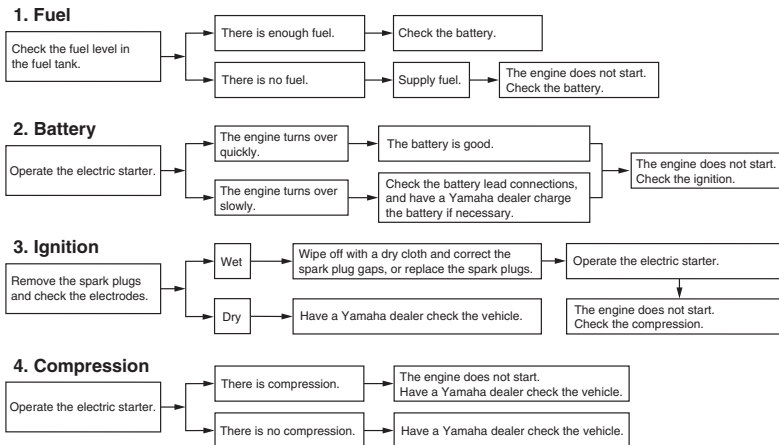

Periodic maintenance and adjustment

Engine overheating

EWAT1041

WARNING

- Do not remove the radiator cap when the engine and radiator are hot. Scalding hot fluid and steam may be blown out under pressure, which could cause serious injury. Be sure to wait until the engine has cooled.
- Place a thick rag, like a towel, over the radiator cap, and then slowly rotate the cap counterclockwise to the detent to allow any residual pressure to escape. When the hissing sound has stopped, press down on the cap while turning it counterclockwise, and then remove the cap.

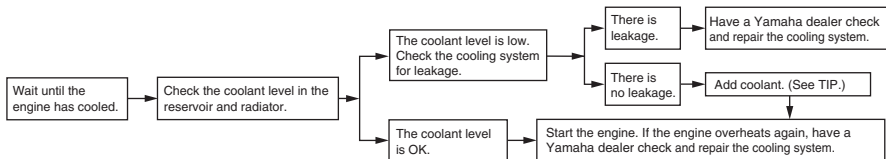

TIP

If coolant is not available, tap water can be temporarily used instead, provided that it is changed to the recommended coolant as soon as possible.

Matte color caution

EJU37834

ECA15193

NOTICE

Some models are equipped with matte colored finished parts. Be sure to consult a Yamaha dealer for advice on what products to use before cleaning the vehicle. Using a brush, harsh chemical products or cleaning compounds when cleaning these parts will scratch or damage their surface. Wax also should not be applied to any matte colored finished parts.

Care

While the open design of a motorcycle reveals the attractiveness of the technology, it also makes it more vulnerable. Rust and corrosion can develop even if high-quality components are used. A rusty exhaust pipe may go unnoticed on a car, however, it detracts from the overall appearance of a motorcycle. Frequent and proper care does not only comply with the terms of the warranty, but it will also keep your motorcycle looking good, extend its life and optimize its performance.

Before cleaning

1. Cover the muffler outlet with a plastic bag after the engine has cooled down.
2. Make sure that all caps and covers as well as all electrical couplers and connectors, including the spark plug cap, are tightly installed.
3. Remove extremely stubborn dirt, like oil burnt onto the crankcase, with a degreasing agent and a brush, but never apply such prod-

ucts onto seals, gaskets, sprockets, the drive chain and wheel axles. Always rinse the dirt and degreaser off with water.

Cleaning

ECA10773

NOTICE

- Avoid using strong acidic wheel cleaners, especially on spoked wheels. If such products are used on hard-to-remove dirt, do not leave the cleaner on the affected area any longer than instructed. Also, thoroughly rinse the area off with water, immediately dry it, and then apply a corrosion protection spray.
- Improper cleaning can damage plastic parts (such as cowlings, panels, windshields, headlight lenses, meter lenses, etc.) and the mufflers. Use only a soft, clean cloth or sponge with water to clean plastic. However, if the plastic parts cannot be thoroughly cleaned with water, diluted mild detergent with water may be used. Be sure to rinse

Motorcycle care and storage

off any detergent residue using plenty of water, as it is harmful to plastic parts.

- Do not use any harsh chemical products on plastic parts. Be sure to avoid using cloths or sponges which have been in contact with strong or abrasive cleaning products, solvent or thinner, fuel (gasoline), rust removers or inhibitors, brake fluid, antifreeze or electrolyte.
- Do not use high-pressure washers or steam-jet cleaners since they cause water seepage and deterioration in the following areas: seals (of wheel and swing-arm bearings, fork and brakes), electric components (couplers, connectors, instruments, switches and lights), breather hoses and vents.
- For motorcycles equipped with a windshield: Do not use strong cleaners or hard sponges as they will cause dulling or scratching. Some cleaning compounds for plastic may leave scratches on the wind-

shield. Test the product on a small hidden part of the windshield to make sure that it does not leave any marks. If the windshield is scratched, use a quality plastic polishing compound after washing.

After normal use

Remove dirt with warm water, a mild detergent, and a soft, clean sponge, and then rinse thoroughly with clean water. Use a toothbrush or bottlebrush for hard-to-reach areas. Stubborn dirt and insects will come off more easily if the area is covered with a wet cloth for a few minutes before cleaning.

After riding in the rain or near the sea

Since sea salt is extremely corrosive carry out the following steps after each ride in the rain or near the sea.

1. Clean the motorcycle with cold water and a mild detergent, after the engine has cooled down.
NOTICE: Do not use warm water since it increases the corrosive action of the salt. [ECA10792]

8-2

2. Apply a corrosion protection spray on all metal, including chrome- and nickel-plated, surfaces to prevent corrosion.

After cleaning

1. Dry the motorcycle with a chamois or an absorbing cloth.
2. Immediately dry the drive chain and lubricate it to prevent it from rusting.
3. Use a chrome polish to shine chrome, aluminum and stainless-steel parts, including the exhaust system. (Even the thermally induced discoloring of stainless-steel exhaust systems can be removed through polishing.)
4. To prevent corrosion, it is recommended to apply a corrosion protection spray on all metal, including chrome- and nickel-plated, surfaces.
5. Use spray oil as a universal cleaner to remove any remaining dirt.
6. Touch up minor paint damage caused by stones, etc.
7. Wax all painted surfaces.

Motorcycle care and storage

EAU26183

- Let the motorcycle dry completely before storing or covering it.

EWA11132

! WARNING

Contaminants on the brakes or tires can cause loss of control.

- Make sure that there is no oil or wax on the brakes or tires.
- If necessary, clean the brake discs and brake linings with a regular brake disc cleaner or acetone, and wash the tires with warm water and a mild detergent. Before riding at higher speeds, test the motorcycle's braking performance and cornering behavior.

ECA10801

NOTICE

- Apply spray oil and wax sparingly and make sure to wipe off any excess.
- Never apply oil or wax to any rubber and plastic parts, but treat them with a suitable care product.

- Avoid using abrasive polishing compounds as they will wear away the paint.**

TIP

- Consult a Yamaha dealer for advice on what products to use.
- Washing, rainy weather or humid climates can cause the headlight lens to fog. Turning the headlight on for a short period of time will help remove the moisture from the lens.

Storage

Short-term

Always store your motorcycle in a cool, dry place and, if necessary, protect it against dust with a porous cover. Be sure the engine and the exhaust system are cool before covering the motorcycle.

ECA10811

NOTICE

- Storing the motorcycle in a poorly ventilated room or covering it with a tarp, while it is still wet, will allow water and humidity to seep in and cause rust.
- To prevent corrosion, avoid damp cellars, stables (because of the presence of ammonia) and areas where strong chemicals are stored.

Long-term

Before storing your motorcycle for several months:

- Follow all the instructions in the "Care" section of this chapter.

Motorcycle care and storage

2. Fill up the fuel tank and add fuel stabilizer (if available) to prevent the fuel tank from rusting and the fuel from deteriorating.
3. Perform the following steps to protect the cylinders, piston rings, etc. from corrosion.
 - a. Remove the spark plug caps and spark plugs.
 - b. Pour a teaspoonful of engine oil into each spark plug bore.
 - c. Install the spark plug caps onto the spark plugs, and then place the spark plugs on the cylinder head so that the electrodes are grounded. (This will limit sparking during the next step.)
 - d. Turn the engine over several times with the starter. (This will coat the cylinder walls with oil.)
WARNING! To prevent damage or injury from sparking, make sure to ground the spark plug electrodes while turning the engine over.
 - e. Remove the spark plug caps from the spark plugs, and then install the spark plugs and the spark plug caps.
4. Lubricate all control cables and the pivoting points of all levers and pedals as well as of the side-stand/centerstand.
5. Check and, if necessary, correct the tire air pressure, and then lift the motorcycle so that both of its wheels are off the ground. Alternatively, turn the wheels a little every month in order to prevent the tires from becoming degraded in one spot.
6. Cover the muffler outlet with a plastic bag to prevent moisture from entering it.
7. Remove the battery and fully charge it. Store it in a cool, dry place and charge it once a month. Do not store the battery in an excessively cold or warm place [less than 0 °C (30 °F) or more than 30 °C (90 °F)]. For more information on storing the battery, see page 7-31.

TIP

Make any necessary repairs before storing the motorcycle.

Dimensions:

- Overall length:
2090 mm (82.3 in)
 - Overall width:
730 mm (28.7 in)
 - Overall height:
1140 mm (44.9 in)
 - Seat height:
780 mm (30.7 in)
 - Wheelbase:
1380 mm (54.3 in)
 - Ground clearance:
160 mm (6.30 in)
 - Minimum turning radius:
2.9 m (9.51 ft)
- ## Weight:
- Curb weight:
166 kg (368 lb)
- ## Engine:
- Combustion cycle:
4-stroke
 - Cooling system:
Liquid cooled
 - Valve train:
DOHC
 - Cylinder arrangement:
Inline
 - Number of cylinders:
2-cylinder
 - Displacement:
249.6 cm³
 - Bore x stroke:
60.0 x 44.1 mm (2.36 x 1.74 in)

Starting system:

- Electric starter

Engine oil:

- SAE viscosity grades:
10W-40
- Recommended engine oil grade:
API service SG type or higher, JASO standard MA
- Engine oil quantity:
Oil change:
1.80 L (1.90 US qt, 1.58 Imp.qt)
- With oil filter removal:
2.10 L (2.22 US qt, 1.85 Imp.qt)

Coolant quantity:

- Coolant reservoir (up to the maximum level mark):
0.25 L (0.26 US qt, 0.22 Imp.qt)
- Radiator (including all routes):
0.84 L (0.89 US qt, 0.74 Imp.qt)

Fuel:

- Recommended fuel:
Unleaded gasoline only
- Fuel tank capacity:
14 L (3.7 US gal, 3.1 Imp.gal)
- Fuel reserve amount:
3.0 L (0.79 US gal, 0.66 Imp.gal)

Fuel injection:

- Throttle body:
ID mark:
1WD1 00

Drivetrain:

- Gear ratio:
1st:
2.667 (40/15)

2nd:

- 1.882 (32/17)

3rd:

- 1.455 (32/22)

4th:

- 1.200 (30/25)

5th:

- 1.037 (28/27)

6th:

- 0.920 (23/25)

Front tire:

- Type:
Tubeless
- Size:
110/70-17M/C (54S)
- Manufacturer/model:
IRC/RX-01F

Rear tire:

- Type:
Tubeless
- Size:
140/70-17M/C (66S)
- Manufacturer/model:
IRC/RX-01R

Loading:

- Maximum load:
160 kg (353 lb)
(Total weight of rider, passenger, cargo and accessories)

Front brake:

- Type:
Hydraulic single disc brake

Specifications

Rear brake:

Type:

Hydraulic single disc brake

Front suspension:

Type:

Telescopic fork

Rear suspension:

Type:

Swingarm

Electrical system:

System voltage:

12 V

Battery:

Model:

GTZ8V

Voltage, capacity:

12 V, 7.0 Ah (10 HR)

Bulb wattage:

Headlight:

LED

Brake/tail light:

LED

Front turn signal light:

10.0 W

Rear turn signal light:

10.0 W

Auxiliary light:

LED

License plate light:

5.0 W

Identification numbers

EAU26365

Record the vehicle identification number and the engine serial number in the spaces provided below for assistance when ordering spare parts from a Yamaha dealer or for reference in case the vehicle is stolen.

VEHICLE IDENTIFICATION NUMBER:

ENGINE SERIAL NUMBER:

Vehicle identification number

EAU62971

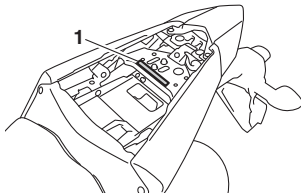

1. Vehicle identification number

The vehicle identification number is stamped into the frame under the passenger seat. (See page 4-16.)

TIP

The vehicle identification number is used to identify your vehicle and may be used to register it with the licensing authority in your area.

Engine serial number

EAU26442

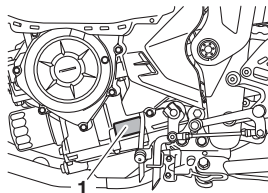

1. Engine serial number

The engine serial number is stamped into the crankcase.

Consumer information

EAU74702

Vehicle data recording

This model's ECU stores certain vehicle data to assist in the diagnosis of malfunctions and for research and development purposes. This data will be uploaded only when a special Yamaha diagnostic tool is attached to the vehicle, such as when maintenance checks or service procedures are performed. Although the sensors and recorded data will vary by model, the main data points are:

- Vehicle status and engine performance data
- Fuel-injection and emission-related data

Yamaha will not disclose this data to a third party except:

- With the consent of the vehicle owner
- Where obligated by law
- For use by Yamaha in litigation
- For general Yamaha-conducted research purposes when the data is not related to an individual vehicle nor owner

- A**
 Air filter element and check hose,
 replacing and cleaning 7-15
- B**
 Battery 7-31
 Brake and clutch levers,
 checking and lubricating 7-28
 Brake and shift pedals,
 checking and lubricating 7-28
 Brake fluid, changing 7-24
 Brake fluid level, checking 7-23
 Brake lever 4-12
 Brake lever free play, checking 7-21
 Brake light switches 7-22
 Brake pedal 4-13
- C**
 Cables, checking and lubricating 7-27
 Care 8-1
 Catalytic converter 4-15
 Clutch lever 4-12
 Clutch lever free play, adjusting 7-19
 Coolant 7-13
- D**
 Data recording, vehicle 10-2
 Dimmer switch 4-11
 Drive chain, cleaning and lubricating ... 7-26
 Drive chain slack 7-25
- E**
 Engine break-in 6-3
 Engine oil and oil filter cartridge 7-10
 Engine serial number 10-1
 Engine trouble warning light 4-3
- F**
 Front and rear brake pads, checking ... 7-22
- Front fork, checking 7-30
 Fuel 4-14
 Fuel consumption, tips for reducing 6-3
 Fuel tank breather hose and
 overflow hose 4-15
 Fuel tank cap 4-13
 Fuses, replacing 7-32
- H**
 Handlebar switches 4-10
 Hazard lights switch 4-11
 Helmet holders 4-17
 Helmets 2-5
 High beam indicator light 4-2
 Horn switch 4-11
- I**
 Identification numbers 10-1
 Indicator lights and warning lights 4-2
- L**
 Labels, location 1-1
 License plate light bulb, replacing 7-35
 Luggage strap holders 4-19
- M**
 Main switch/steering lock 4-1
 Maintenance and lubrication, periodic... 7-5
 Maintenance, emission control
 system 7-3
 Matte color, caution 8-1
 Multi-function meter unit 4-4
- N**
 Neutral indicator light 4-2
- O**
 Oil pressure warning light 4-2
- P**
 Parking 6-4
- Part locations 3-1
 Pass switch 4-11
- R**
 Rear view mirrors 4-18
- S**
 Safety information 2-1
 Seats 4-16
 Shifting 6-2
 Shift pedal 4-12
 Shift timing indicator light 4-3
 Shock absorber assembly, adjusting ... 4-18
 Sidestand 4-19
 Sidestand, checking and lubricating ... 7-29
 Spark plugs, checking 7-9
 Specifications 9-1
 Start/Engine stop switch 4-11
 Starting circuit cut-off system 4-20
 Starting the engine 6-2
 Steering, checking 7-30
 Storage 8-3
 Storage compartment 4-18
 Supporting the motorcycle 7-36
 Swingarm pivots, lubricating 7-29
- T**
 Throttle grip and cable,
 checking and lubricating 7-27
 Throttle grip free play, checking 7-17
 Tires 7-17
 Tool kit 7-1
 Troubleshooting 7-39
 Troubleshooting charts 7-41
 Turn signal indicator lights 4-2
 Turn signal light bulb, replacing 7-34
 Turn signal switch 4-11

Index

V

- Valve clearance..... 7-17
- Vehicle identification number 10-1
- Vehicle lights..... 7-34

W

- Wheel bearings, checking..... 7-31
- Wheel (front)..... 7-36
- Wheel (rear)..... 7-37
- Wheels 7-19

www.yamaha-motor.com.my

YAMALUBE®



Pelincir Tulen Yamaha



PELINCIR MOTOSIKAL BERPRESTASI TINGGI

PRINTED IN MALAYSIA