

Infrared thermometer CellaTemp[®] PK / PKF / PKL

for non-contact temperature measurements
from -30 °C to +2500 °C

Range of models

Compact infrared thermometer



Type	Measuring range	Application
Single-colour infrared thermometer		
PK 11	0 - 1000 °C	Non metals
PK 12	-30 - 300 °C	Non metals at low temperatures
PK 14	0 - 500 °C	Non metals large objects
PK 18	0 - 500 °C	Non-metals in aggressive measuring environment
PK 21	250 - 1600 °C	Metals, ceramics, molten glass
PK 24	250 - 1600 °C	Metals, ceramics large objects
PK 29	150 - 800 °C	Aluminum, bright metal surfaces, laser applications
PK 31	500 - 2500 °C	Metal, ceramics at high temperatures
PK 41	300 - 1300 °C	Glass surfaces
PK 42	500 - 2500 °C	
PK 51	400 - 1400 °C	Flame-heated furnaces

Two-colour infrared thermometer		
PK 68	550 - 1400 °C	Metals, ceramics, molten glass at difficult measuring conditions like dust, steam, smoke

Infrared thermometer with optical fibre and optical sensor head



Type	Measuring range	Application
Single-colour infrared thermometer with fibre optic and sensor head		
PKF 26	300 - 1600 °C	Metals, ceramics, molten glass
PKF 36	550 - 2500 °C	Metals, ceramics large objects

Compact infrared thermometer with LED spot light



Type	Measuring range	Application
Single-colour infrared thermometer		
PKL 11	0 - 1000 °C	Non metals, coated metals
PKL 28	250 - 1600 °C	Metals (small measuring objects), induction heating
PKL 29	180 - 1200 °C	Metals (small measuring objects), induction heating at low temperatures
PKL 38	500 - 2500 °C	Metals (small measuring objects), induction heating at high temperatures

Two-colour infrared thermometer		
PKL 68	650 - 1600 °C	Metals (small measuring objects), induction heating at difficult measuring conditions like dust, steam, smoke

Infrared thermometer CellaTemp® PK/PKF/PKL

Special features

- Compact infrared thermometer with large, bright LED display and control panel
- All parameters adjustable with control keys on the sensor head
- High optical resolution and accuracy due to wide band anti-reflective precision lenses
- Target sizes from Ø 1.2 mm
- High temperature resolution over large measuring ranges
- Analogue output 0 / 4 – 20 mA
- Universally configurable switching output
- Test function triggered by push-button or control signal
- Easy mounting thanks to the M30 screw thread
- Optionally with patented LED spot light to display focal distance with the exact size and position of the target
- Optionally as fibre optic version with separate sensor head
- Optionally as two-colour infrared thermometer (difficult measuring conditions due to dust, vapour, smoke)
- SCM function for pollution monitoring (with two-colour infrared thermometer)

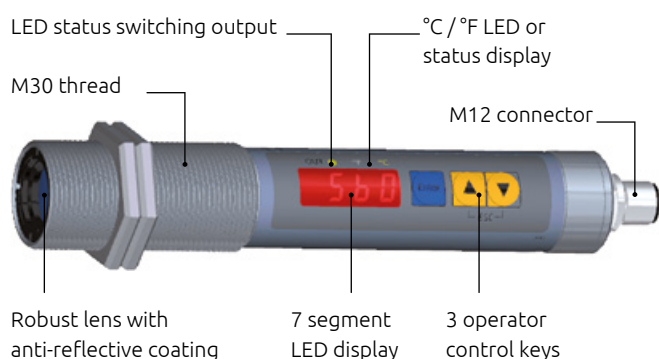

asphalt and concrete mixing plants, preventing the lens from damage by aggressive vapours and dust.

CellaTemp® PK 29

The CellaTemp® PK 29 is equipped with a special blocking filter, thus avoiding that the measurement is affected by daylight. This infrared thermometer also responds substantially less sensitive to reflective external radiation than conventional devices measuring in the short-wave range. Therefore, the CellaTemp® PK 29 can be used for a variety of applications in the metal-working industry and in particular for temperature measurements of aluminium and bright metals at low temperatures.

Thanks to the blocking filter it is also suitable to measure processes where diodes, Nd:YAG or CO₂ lasers are used for heating. The high-energy laser radiation does not affect the measurement.

CellaTemp® PK series

The infrared thermometer CellaTemp® PK records the infrared radiation emitted by an object and converts it into an electrical signal. The detected temperature is displayed and transmitted to the analogue output for further processing.

A unique combination of analogue and digital linearisation features provides the CellaTemp® PK with a high-resolution signal processing unit. Therefore, even with wide measuring ranges, the infrared thermometer has a very high temperature resolution while its noise equivalent temperature difference (NETD) is extremely low. The pyrometer thus supplies stable measurement readings even when the response times are extremely short and the measured temperatures are very low.

A modern microprocessor with high clock speed allows for short response times starting at 2 ms.

The bright display unit is based on state-of-the-art LED technology. Even from a great distance it is easy to read and it is energy-efficient at the same time.

CellaTemp® PK 18

The CellaTemp® PK 18 comes with an especially resilient lens, allowing its use even in extreme environmental conditions, such as in

CellaTemp® PK 41/42

In the range of 4.5 - 8 µm glass has an emissivity of almost 100%. Above 5 µm, atmospheric influences, such as humidity or water vapour, affect the measurement. The CellaTemp® PK 41/42 is provided with a blocking filter with a spectral sensitivity of 4.5-4.8 µm, thus measuring the temperature from the near surface area of the glass. Owing to the wavelength used, changes in thickness, different types of glass or varying moisture contents in the atmosphere do not affect the measurement reading.

CellaTemp® PK 51

The CellaTemp® PK 51 was especially developed for temperature measurements in flame heated furnaces. Thanks to the selective spectral range of 3.9 µm, water vapour and CO₂ existing in the pyrometer's field of vision have no effect on the measuring results, even when measuring from large distances. This allows precise measurements through flames and combustion gases.

Infrared thermometer CellaTemp® PKF with optical fibre and optical sensor head



CellaTemp® PKF 26/36

The electronic elements of the CellaTemp® PKF 26/36 version are separated from the measuring head. A fibre optics system transmits the infrared radiation to the electronic unit where it is transformed into an electric signal. The measuring head is entirely composed of mechanical and optical components, enabling its use at ambient temperatures up to 250 °C without auxiliary cooling systems. The fibre optics version is also used in confined spaces or in powerful electromagnetic fields. The fibre optics cable is detachable both from the measuring head and the electronic unit using a screw-in FSMA connector which makes the cable easy to install. The length of the fibre optics cable can be up to 50 m.

Laser module



The laser module PS 01/P has to be attached to the end of the optical fibre to set the focal distance and to check the alignment during setup of the CellaTemp® PKF 26/36.

Infrared Thermometer CellaTemp® PKL with LED pilot light



Special features of the LED spot light

- lights up permanently
- shows the exact size and position of the target at the focal point
- is absolutely safe
- is based on innovative LED technology, that means a high luminosity at low power consumption
- Parallax-free – identical geometric and optical axis to exclude squinting of the device
- green pilot light is bright and clearly visible to the eye

CellaTemp® PKL 11/28/29/38/68

The CellaTemp® PKL comes with an integrated LED spot light. The spot light is particularly indispensable for small measuring objects from Ø 1.2 mm as it helps to align the infrared thermometer to view the hot zone and to adjust the correct focal distance. The LED spot light is continuously illuminated and due to its permanent control function it offers a high degree of operational safety.

The special feature of the patented spot light is that it shows both the focal point and the exact position and true size of the measuring point. Thanks to the high-precision mechanical and optical design the geometric and optical axes are identical, thus providing a parallax-free CellaTemp® PKL. This excludes squinting of the device when, for example, measuring through a narrow furnace or kiln wall.

The LED light is technically safe and there is no risk of injury to the human eye as with a laser device. Unlike a laser, it is not subject to aging and, regardless of the ambient temperature, it always works with a constant luminous intensity. Without cooling, the maximum permissible ambient temperature is 65 °C. The innovative LED technology ensures a very intense light spot with low power consumption. As the human eye has the highest sensitivity in the wavelength range of green light, green light appears brighter and sharper to the viewer than red light.

Two-colour infrared thermometer CellaTemp® PK(L) 68

The two-colour infrared thermometer CellaTemp® PK(L) 68 captures the infrared radiation of the object with a dual photodiode (sandwich design) at two wavelengths at the same time and spot. The temperature is then defined by the ratio of these two signals.

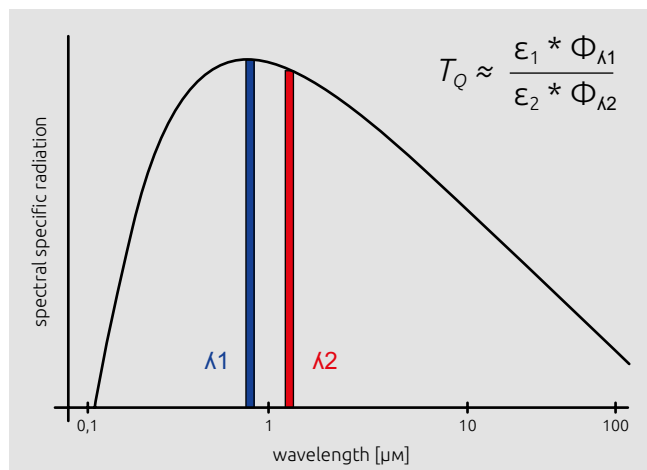

The particular advantage of a two-colour measuring procedure is that it produces a correct reading even when the infrared radiation picked up by the sensor is weakened by up to 90%. The two-colour infrared thermometer reacts substantially less sensitive than a single-colour pyrometer to visual obstructions in the target area caused by steam, dust and smoke. The same applies if the optical system of the device or the inspection glass of the furnace is dirty or inspection openings are clogged. Therefore, two-colour pyrometers are preferably used for industrial applications in harsh ambient environments and under difficult measuring conditions, such as rotating kilns in the cement industry or rolling mills in the steel industry.

The ratio principle also compensates for changes in the radiation characteristics of the measuring object. The emissivity, i.e. the radiation characteristics of the object to be measured may change due to the nature of the surface or in relation to the temperature, but with simultaneous changes over both wavelengths there is no influence on the measurement.

Another advantage of the CellaTemp® PK(L) 68 is that the measuring object may even be smaller than the target field of the device. Therefore, with smaller measuring objects, such as in inductive heating installations, a two-colour infrared thermometer is less sensitive to an imperfect alignment than a single-colour thermometer.

Analogue output

The analogue output supplies a signal linear to the temperature; 0/4 – 20 mA are optionally available. The range setting can be configured with the control keys according to the needs of the user. The outputs deactivate and a warning appears on the display when the internal temperature reaches > 75 °C.

Switching outputs

With a hot object in the sensor's field of vision, a switching contact is triggered when a pre-defined temperature threshold is exceeded. An LED indicates this switching status.

Optionally, the switch can operate as a normally closed or normally open contact.

This configurable switch on/switch off delay permits a suppression of short interference pulses and for the adaptation of the switching output to the response time of a PLC.

The two-colour infrared thermometer CellaTemp® PK(L) 68 has two independent switching outputs for the configuration of the measuring values, the internal temperature, the contamination monitoring or the DTD function.

A variety of possible applications includes:

- Monitoring of limit temperatures or temperature ranges
- Signalisation of status information of the DTD function
- Determination of the measurement time
- Synchronisation of the measurement value transmission to a PLC

Optical system

An infrared thermometer uses an optical measuring method for non-contact temperature measurements. The quality of the optical system has a great influence on the measurement accuracy of the device as a whole.

This influence is defined as "size of source effect". Light scattered into the optical path will result in false temperature data. When the distance to the target or the size of the object change, the temperature reading may change as well depending on the quality of the optical system.

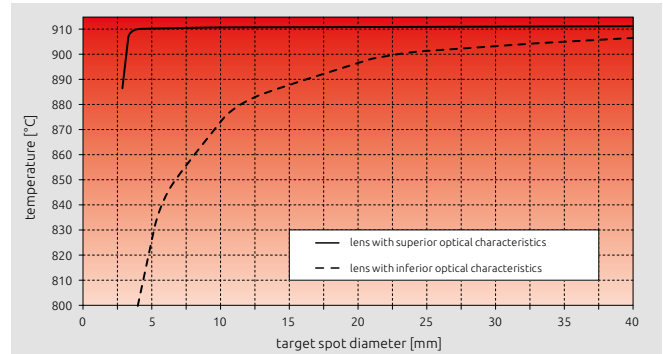

The optical system of the CellaTemp® PK features a high-quality glass lens optimised for the visible and infrared range. This ensures that within the focal range both the infrared radiation on the sensor and the spot light are reproduced in an equally sharp way.

The excellent imaging characteristics of the precision lenses provide a high optical resolution and a minimum sensitivity to stray light. The measured value is thus not affected by changing object sizes or varying distances to the target.

The anti-reflective coated lenses are extremely durable, easy to clean and therefore suitable for rough industrial applications.

Contamination monitoring

The CellaTemp PK(L) 68 is equipped with a SCM (Smart Contamination Monitoring) function that continuously monitors the signal power. If the infrared radiation decreases to a critical value due to a contamination of the lens or the protective window, this condition is recorded, visually displayed on the device and transmitted via a switching contact. Visual obstructions in the target area or deposits in the furnace opening are also detected. The sensitivity to detect the contamination level is adjustable.

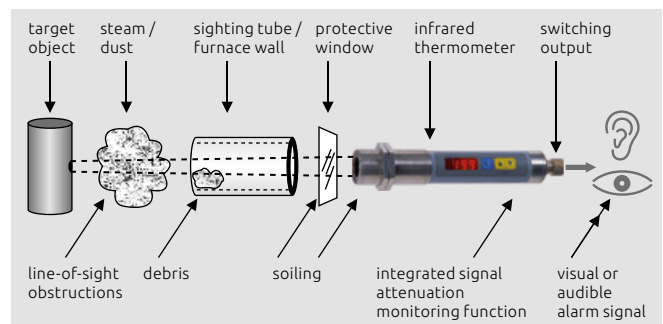

DTD function

The CellaTemp® PK(L) 68 is equipped with a DTD (Discontinuous Temperature Detection) function. In discontinuous processes it is used for the automatic detection of the temperature. This function is ideal, for example, to measure the slab temperature in a rolling mill or of bolts during induction heating that move past the pyrometer at irregular times.

The measurement starts automatically when this function detects a hot object. It ends when the temperature is below the threshold and the maximum value is displayed.

A switching contact may be activated during the measurement for synchronisation with a PLC. The duration of measurement can thus also be recorded.

Diagnostic function

The diagnostic function ensures a high operational reliability. Incorrect supply voltages, reverse polarities of connections, overloads at the switching output, unacceptable ambient temperatures or out-of-range object temperatures appear on the display as error messages.

Test function (in the single-colour thermometer)

A functional test of the device and the signal processing unit can be performed at any time via an external control signal or via the operating menu. The analogue output generates an electric current of 20.5 mA and the switching function is triggered.

Service function

The service function is used during setup or running operation to key in a simulated temperature value that is displayed and transmitted via the analogue output. This feature checks the correct functioning and range setting for the downstream signal processing units (display, controller, PLC) quickly and safely even without a hot object.

Outputs

Analogue output

- 0/4 - 20 mA linear according to NAMUR 43, scalable
- max. burden 500 Ω

Switching output

- PNP open collector active from positive supply voltage (2 independent switching contacts at the PK(L) 68)
- NC or NO
- current-carrying capacity 150 mA
- clocked overload safety shut-off ≥ 250 mA

Reverse polarity protection

- for the power supply voltage
- for the analogue output
- for the switching output

Test input (in the single-colour thermometer)

Digital input (IEC 61131-2, Typ 3)

- Low level ≤ 5 V DC, High level ≥ 11 V DC
- Load current $\leq 11,6$ mA at 30 V DC

Technical data

Resolution of power output

- 0.2 K + 0.03 % of the set span

Resolution of display

- 0.1 K for $T < 200$ °C
- 1 K for $T \geq 200$ °C

Power supply

- 18 - 32 V DC

Power consumption

- ≤ 50 mA (≤ 75 mA with spot light) at 24 V DC without load current

Ambient temperature

- 0 - 65 °C

Storage temperature

- -20 - +80 °C

Housing material

- Stainless steel V2A (1.4305)

Permissible humidity

- 95 % r.H. max. (non-condensing)

Protection

- IP65 acc. to DIN 40050 protection class III

Connection

- M12 connector, 5-pole A coding (DIN EN 61076-2-101)

Weight

- approx. 0.4 kg

Shock resistance

- (EN60068-2-27)
- 30 g (11 mg)

Vibration resistance

- (EN60068-2-6)
- 5 g (10 - 2000 Hz)

Display

LED display

- 4 x 7 segment red, character height 8 mm

LED

- indicating the operating state, overload and incorrect connection of the supply voltage
- for display of unit (°C or °F) in single-colour infrared thermometer
- for display the signal power in two-colour infrared thermometer

Operating elements

- 3 buttons

Troubleshooting

- Output overload
- Excess temperature in the sensor
- Measuring range too high/too low
- Incorrect supply voltage connection
- incorrect supply voltage

Approvals

EMV

- EN 61000-6-4
- EN 61000-6-2

Fibre optic cable for CellaTemp® PKF

Type	Length	Weight
LWL-2HT	2 m	0.08 kg
LWL-5HT	5 m	0.19 kg
LWL-10HT	10 m	0.38 kg

other lengths up to 50 m on request

Ambient temperature

- -40 - +250 °C

Material

- brass, nickel-plated

Scope of delivery

- Infrared thermometer
- Operating manual
- 2 fastening nuts

Additionally for CellaTemp® PKF

- Measuring head, depending on model
- Laser module PS 01/P
- Fibre optic cable (please specify length)

- i** The connecting cable VK 02/L (length as required) must be ordered separately.

Adjustable parameters

Analogue output

- Analogue output 0 / 4 – 20 mA
- Scaling of the analogue output

Switching output

- ON and reset
- Switching function: NC and NO contacts
- Switch-on and switch-off delay

General parameters

- Emissivity (quick set) with temperature display
- Smoothing function
- Hold time for peak value
- Reset to factory setting
- Key lock
- Temperature display
- Temperature unit °C / °F
- Temperature simulation
- Test function (single-colour thermometer)

Additionally for the two-colour thermometer

- Shut down and alarm threshold for contamination monitoring
- Source of the second switching contact
- Transmission factor
- Threshold for the DTD function
- Measuring method single-colour / two-colour

Connector pin assignment

CellaTemp® PK

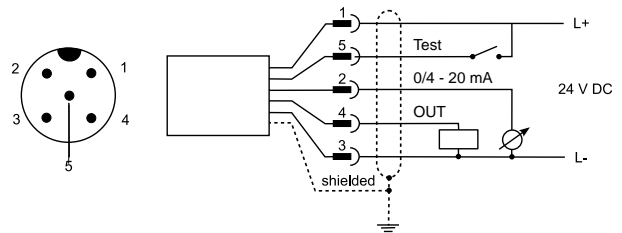

CellaTemp® PK(L) 68

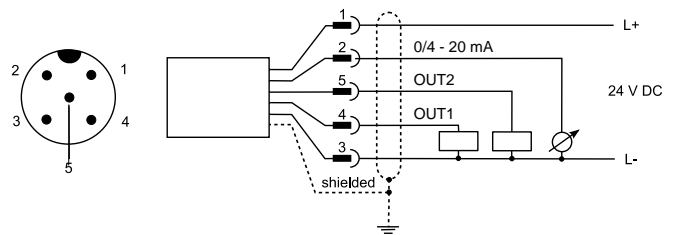

- i** It is imperative to use a cable with shielding.

Supplementary lenses

A lens can be screw-mounted on the sensor of the infrared thermometer CellaTemp® PK for the measurement of very small objects.

Infrared thermometer	Supplementary lens	Distance to target	Target Ø
PK 11 AF 1	PK 11/E AF 1	30 mm	1.5 mm
PK 11 AF 2		33 mm	1.6 mm
PK 12		30 mm	2.3 mm
PK 21/31	PK 21/E AF 1	520 mm	5 mm
PK 41/42	PS 41/E AF 1	20 mm	1.3 mm
	PS 42/E AF 1	43 mm	2.5 mm
PKL 28/38/68 AF 1	PS 27/E AF 1	125 mm	1.5 mm
PKL 28/38/68 AF 2		440 mm	4.5 mm
PKL 29		150 mm	3.5 mm

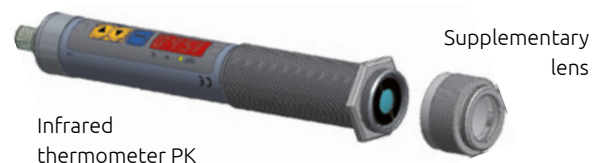

Technical data - Compact infrared thermometer

Type	Measuring range	Spectral sensitivity	Focal distance	Target size	Measurement uncertainty* ¹	Response time t ₉₈	Repeatability	Temperature coefficient* ²
Single-colour infrared thermometer								
PK 11 AF 1	0 - 1000 °C 32 - 1832 °F	8 - 14 µm	0.3 m	Ø 11 mm	0.75 % of measured value [°C] plus 2.0 K	≤ 60 ms	1 K	0.1 K/K (for T < 250 °C) 0.04 %/K (for T > 250 °C)
PK 11 AF 2			0.9 m	Ø 33 mm				
PK 12 AF 1	-30 - 300 °C -22 - 572 °F		0.3 m	Ø 18 mm		≤ 90 ms		
PK 14 AF 1	0 - 500 °C 32 - 932 °F		1.0 m	Ø 0.43 m		≤ 60 ms		
PK 18 AF 1			0.3 m	Ø 11 mm				
PK 21 AF 1	250 - 1600 °C 482 - 2912 °F	1.0 - 1.7 µm	1.5 m	Ø 10 mm	0.3 % of measured value [°C] plus 2.5 K	≤ 2 ms for T > 600 °C	0.07 %/K	
PK 24 AF 1			1.0 m	Ø 0.2 m				
PK 29 AF 1	150 - 800 °C 302 - 1472 °F	1.8 - 2.2 µm	0.3 m	Ø 7 mm	0.3 % of measured value [°C] plus 4.0 K	≤ 2 ms for T > 300 °C ≤ 15 ms for T > 200 °C ≤ 45 ms for T > 150 °C	0.25 K/K (for T < 500 °C) 0.05 %/K (for T > 500 °C)	
PK 31 AF 1	500 - 2500 °C 932 - 4532 °F	0.78 - 1.06 µm	1.5 m	Ø 8 mm	0.2 % of measured value [°C] plus 2.5 K	≤ 2 ms for T > 900 °C	0.07 %/K	
PK 41 AF 1	300 - 1300 °C 572 - 2372 °F	4.6 - 4.9 µm	0.4 m	Ø 11 mm	0.5 % of measured value [°C] plus 2.5 K	≤ 100 ms	2 K	0.04 %/K
PK 42 AF 1	500 - 2500 °C 932 - 4532 °F		0.4 m	Ø 7 mm	1.0 % of measured value [°C]		4 K	
PK 51 AF 1	400 - 1400 °C 752 - 2552 °F		3.8 - 4.0 µm	0.4 m			Ø 11 mm	
Two-colour infrared thermometer								
PK 68 AF 1	500 - 1400 °C 932 - 2552 °F	0.95/1.05 µm	1.5 m	Ø 21 mm	1.0 % of measured value [°C]	≤ 10 ms for T > 650 °C	2 K	0.05 %/K

Technical data - Infrared thermometer with fibre optic

Type	Measuring range	Spectral sensitivity	Measuring head	Focal distance	Target size	Measurement uncertainty* ¹	Response time t ₉₈	Repeatability	Temperature coefficient* ²
Single-colour infrared thermometer with fibre optic and sensor head									
PKF 26 AF 1	300 - 1600 °C 572 - 2912 °F	1.0 - 1.7 µm	PA 41.01	0.2 m - ∞	180 : 1	0.3 % of measured value [°C] plus 2.5 K	≤ 2 ms for T > 600 °C	2 K	0.07 %/K
PKF 26 AF 2			PKS 21.01	1.5 m	Ø 7.2 mm				
PKF 26 AF 3			PZ 41.28	0.12 m - ∞	70 : 1				
PKF 36 AF 1	550 - 2500 °C 1022 - 4532 °F	0.78 - 1.06 µm	PA 41.01	0.2 m - ∞	190 : 1		≤ 2 ms for T > 900 °C		
PKF 36 AF 2			PKS 21.01	1.08 m	Ø 5.6 mm				
PKF 36 AF 3			PZ 41.28	0.12 m - ∞	85 : 1				

*¹ at ε = 1 and Ta = +23 °C

*² deviation to Ta = +23 °C

Technical data - Compact infrared thermometer with LED spot light

Type	Measuring range	Spectral sensitivity	Focal distance	Target size	Measurement uncertainty* ¹	Response time t_{98}	Repeatability	Temperature coefficient* ²
Single-colour infrared thermometer								
PKL 11 AF 1	0 - 1000 °C 32 - 1832 °F	8 - 14 µm	0.295 m	Ø 11 mm	0.75 % of measured value [°C], at least 2.0 K	≤ 60 ms	1 K	0.1 K/K (for T < 250 °C) 0.04 %/K (for T > 250 °C)
PKL 11 AF 2			0.089 m	Ø 5.2 mm				
PKL 28 AF 1	250 - 1600 °C 482 - 2912 °F	1.0 - 1.7 µm	0.21 m	Ø 1.4 mm	0.3 % of measured value [°C] plus 2.5 K	≤ 2 ms for T > 600 °C		0.07 %/K
PKL 28 AF 2			1.0 m	Ø 6.7 mm				
PKL 29 AF 1	180 - 1200 °C 356 - 2192 °F	1.8 - 2.2 µm	0.29 m	Ø 6.2 mm	0.3 % of measured value [°C] plus 4.0 K	≤ 2 ms for T > 300 °C ≤ 10 ms for T > 250 °C ≤ 25 ms for T > 180 °C		0.25 K/K (for T < 500 °C) 0.05 %/K (for T > 500 °C)
PKL 38 AF 1	500 - 2500 °C 932 - 4532 °F	0.78 - 1.06 µm	0.21 m	Ø 1.2 mm	0.2 % of measured value [°C] plus 2.5 K	≤ 2 ms for T > 900 °C		0.07 %/K
PKL 38 AF 2			1.0 m	Ø 5.6 mm				
Two-colour infrared thermometer								
PKL 68 AF 1	650 - 1600 °C 1202 - 2912 °F	0.95/1.05 µm	0.21 m	Ø 1.2 mm	1.0 % of measured value [°C]	≤ 10 ms for T > 750 °C	2 K	0.05 %/K
PKL 68 AF 2			1.0 m	Ø 5.6 mm				

*¹ at $\epsilon = 1$ and $T_a = +23$ °C

*² deviation to $T_a = +23$ °C

Dimensions

Compact infrared thermometer

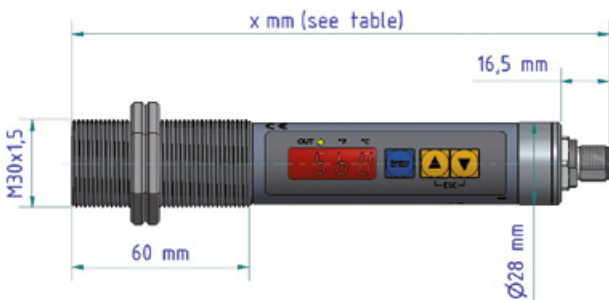

Length of the compact infrared thermometer	
Type	Length
PK 11, 12 PK, PK 14, PK 18	183 mm
PK 21, 24 PK, PK 29, PK 31	208 mm
PK 41, 42 PK, PK 51	200 mm
PK 68	209 mm
PKL 28, PKL 29, PKL 38, PKL 68	233 mm

Infrared thermometer with fibre optic PKF 26, PKF 36

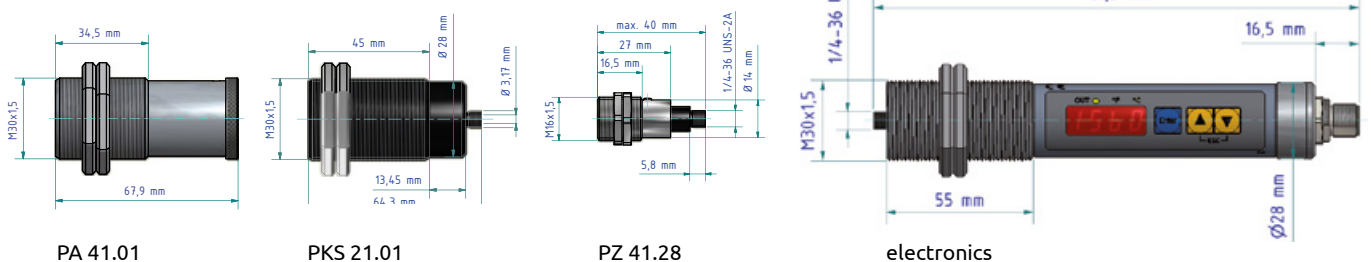

Definition of the measurement field size

The data of the measurement field diameter refers to a percentage of the radiant energy received by the pyrometer. It is necessary to use the same energy reference parameters when comparing the size specification of pyrometer measurement fields.

The higher the quality and the image sharpness of the optical system, the lower are the differences at 90% and at 95% of the received energy when stating the diameter and the smaller is the "size-of-source effect".

As shown in the graph, the values of a received energy of 90% either with a high-quality optical system or with a simple optical system can be comparable. However, with a simple optical system the amount of energy received increases considerably when the target is enlarged. In practice, this is demonstrated by a more or less strong temperature change when measuring different object sizes.

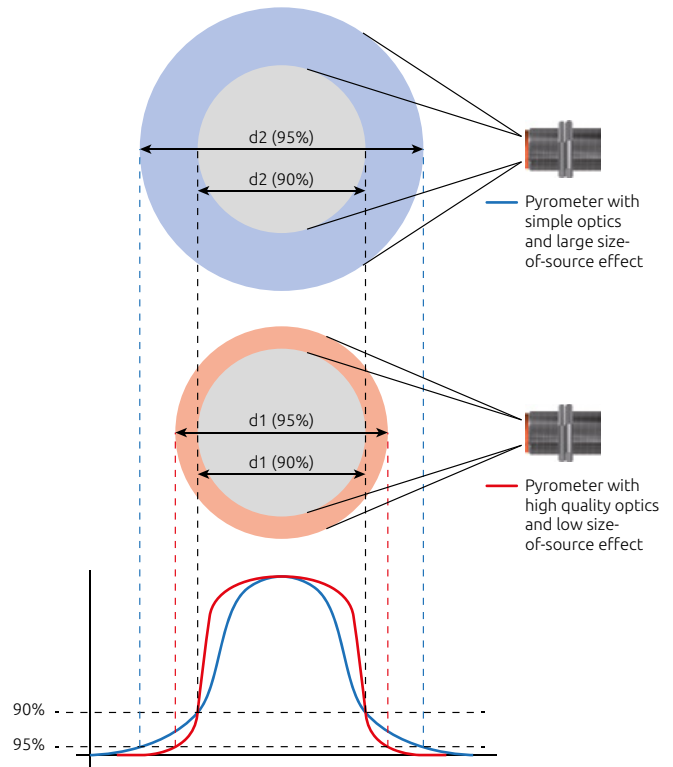

Target diagrams of the compact infrared thermometer

CellaTemp® PK 11 AF 1/18 AF 1

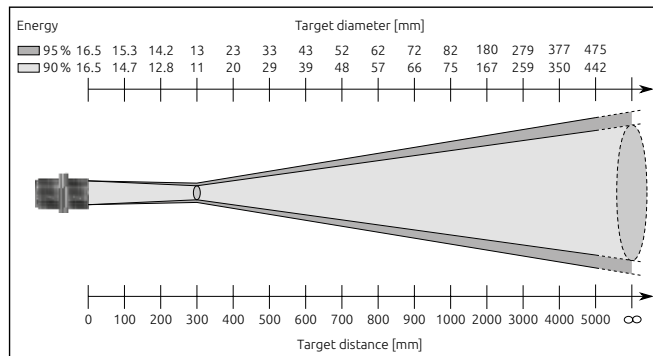

CellaTemp® PK 12 AF 1

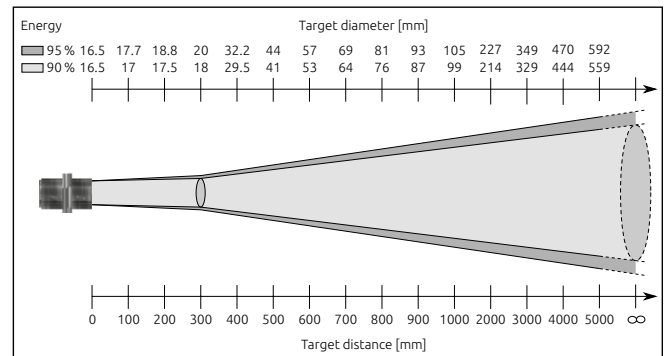

CellaTemp® PK 11 AF 2

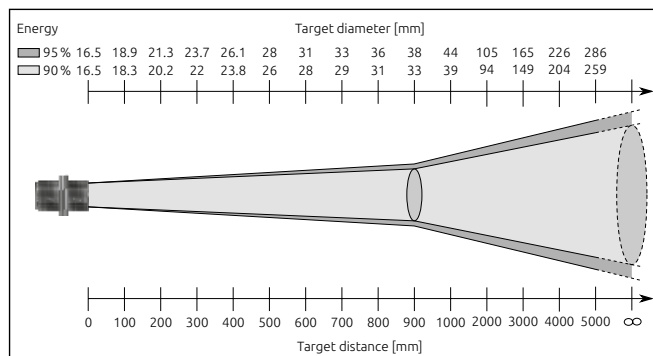

CellaTemp® PK 14 AF 1

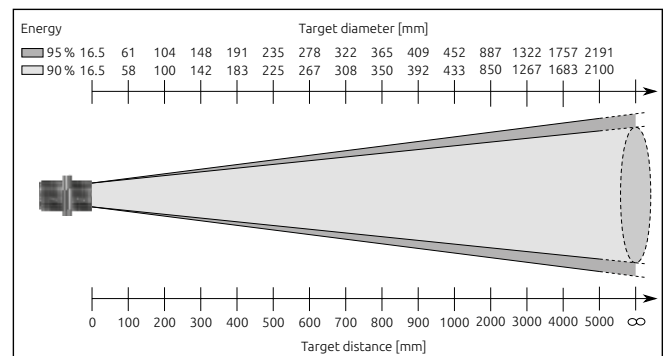

Target diagrams of the compact infrared thermometer

CellaTemp® PK 21 AF 1

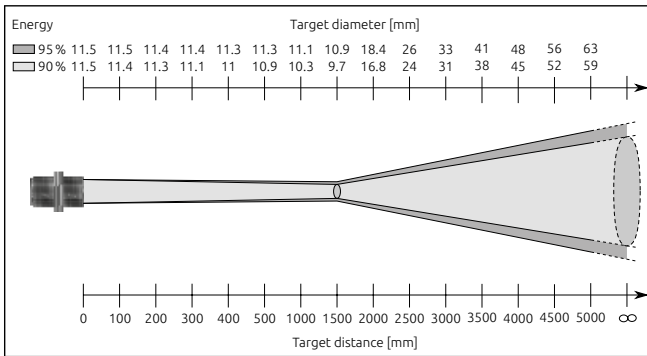

CellaTemp® PK 41 AF 1/51 AF 1

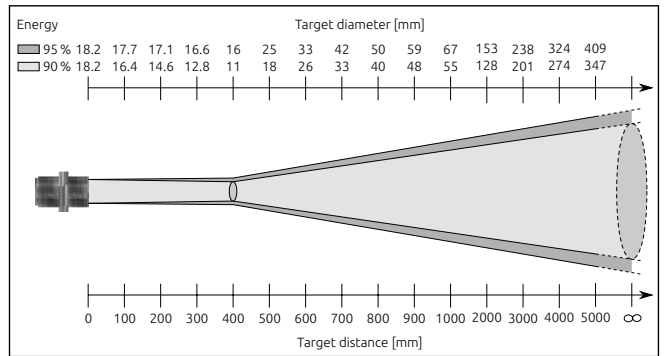

CellaTemp® PK 24 AF 1

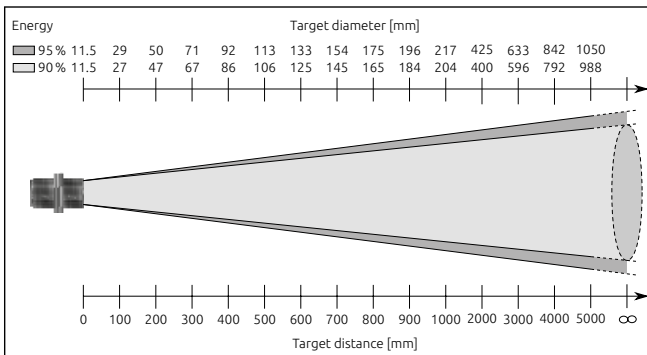

CellaTemp® PK 42 AF 1

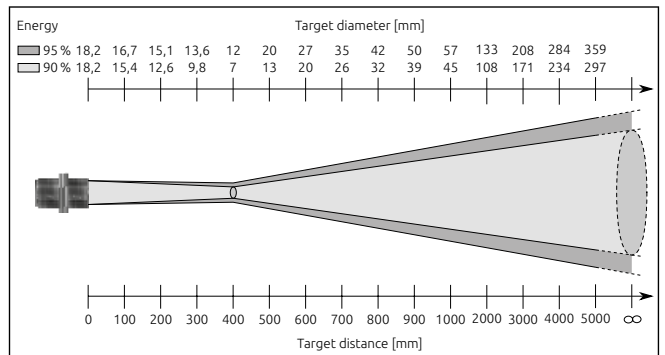

CellaTemp® PK 29 AF 1

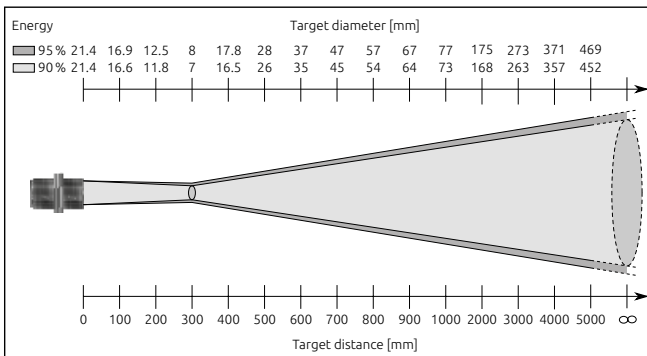

CellaTemp® PK 68 AF 1

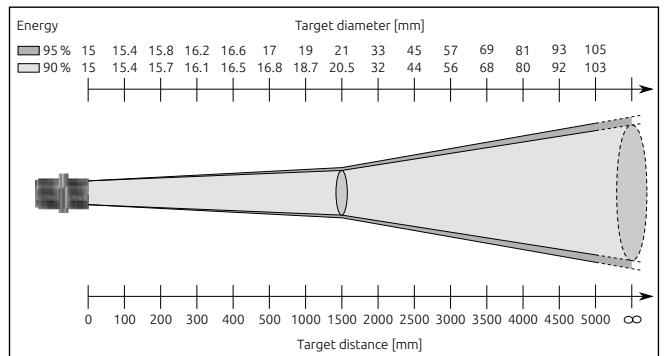

CellaTemp® PK 31 AF 1

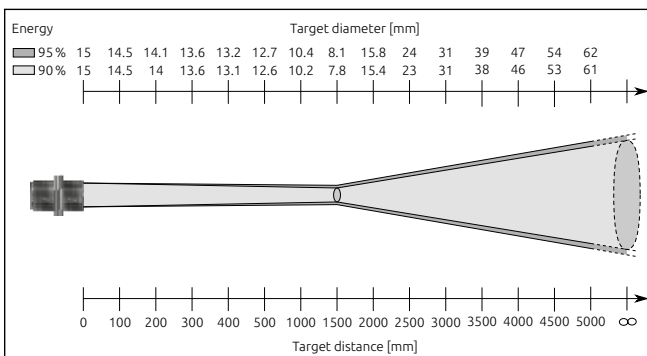

Target diagrams of the infrared thermometer with fibre optic

CellaTemp® PKF 26 AF 1¹

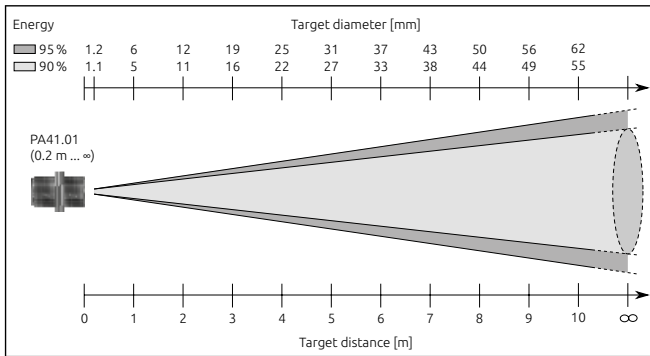

CellaTemp® PKF 36 AF 1¹

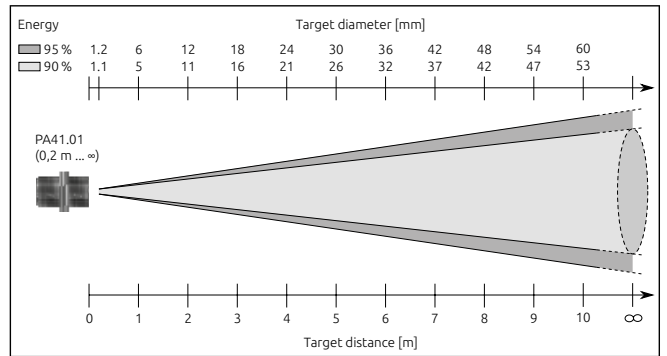

CellaTemp® PKF 26 AF 2¹

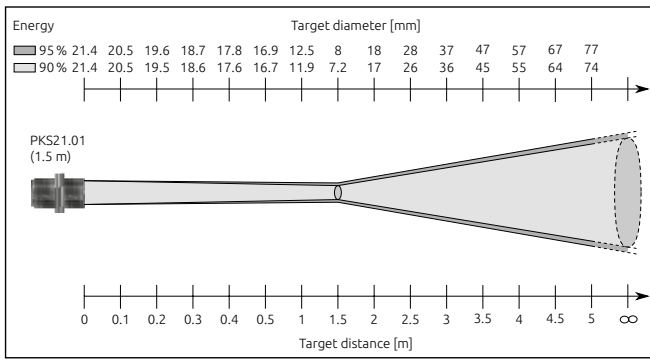

CellaTemp® PKF 36 AF 2¹

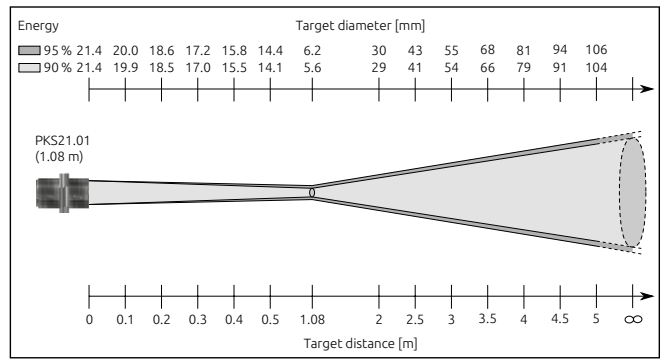

CellaTemp® PKF 26 AF 3¹

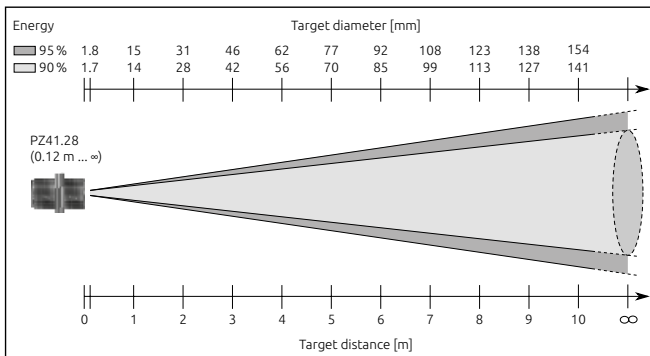

CellaTemp® PKF 36 AF 3¹

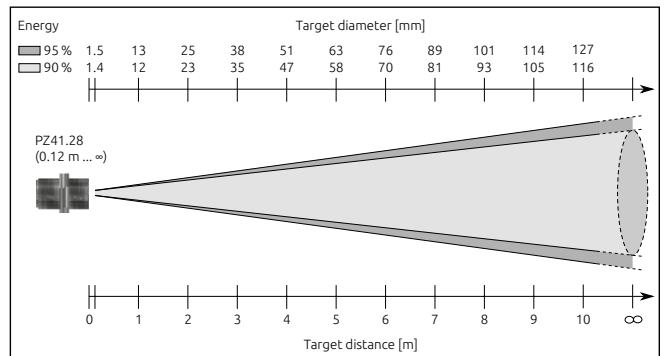

¹ The target diameter is valid for the respective adjusted measuring distance.

Target diagrams of the compact infrared thermometer with LED spot light

CellaTemp® PKL 11 AF 1

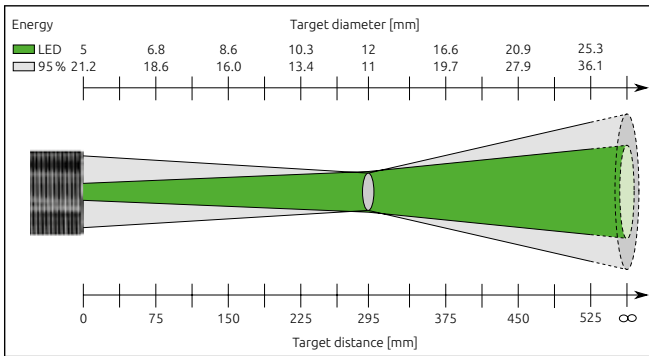

CellaTemp® PKL 29 AF 1

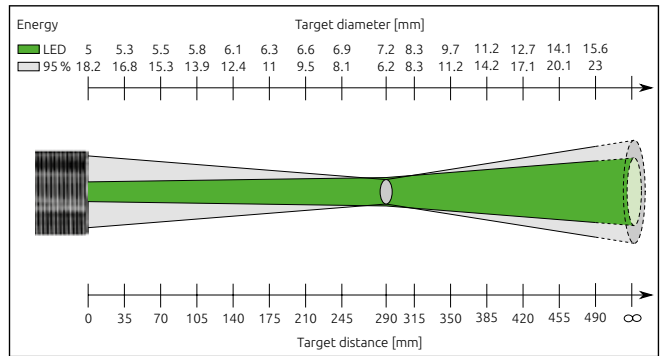

CellaTemp® PKL 11 AF 2

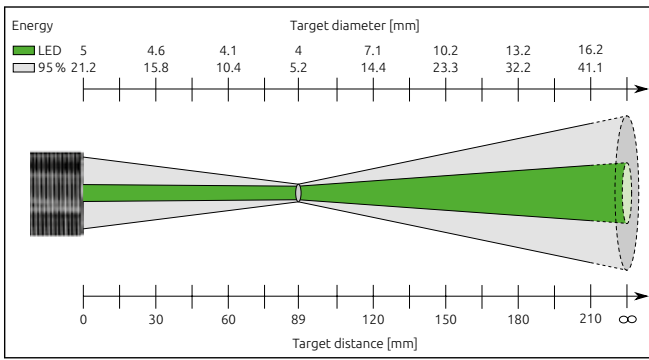

CellaTemp® PKL 38 AF 1/PKL 68 AF 1

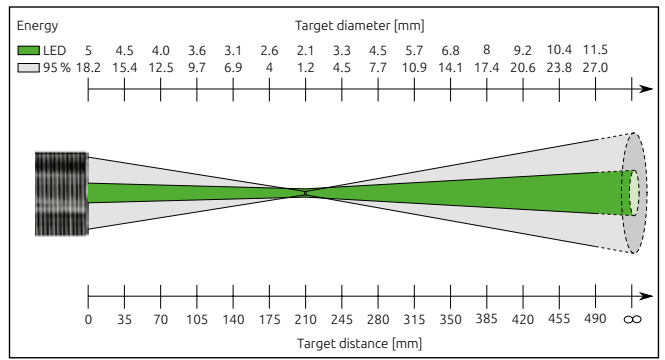

CellaTemp® PKL 28 AF 1

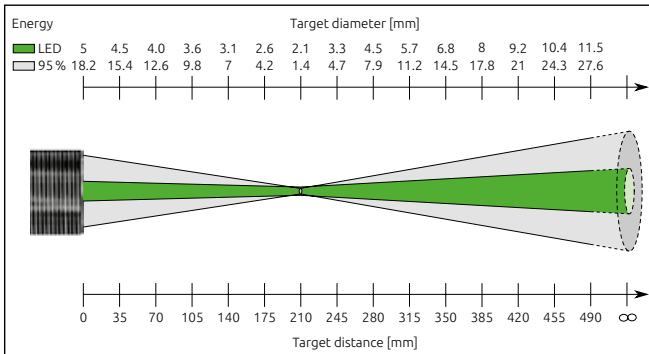

CellaTemp® PKL 38 AF 2/PKL 68 AF 2

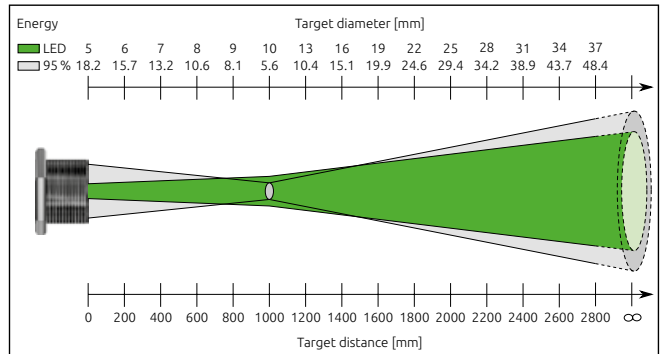

CellaTemp® PKL 28 AF 2

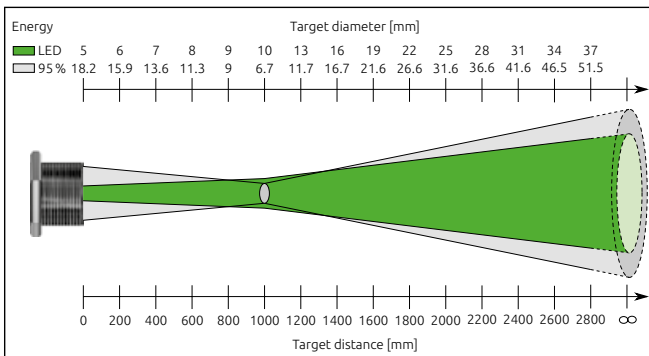

Accessories



Shielded cable
VK 02 / L AF 1: 5 m
VK 02 / L AF 2: 10 m

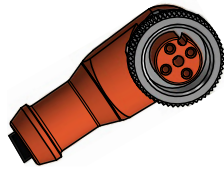

Shielded cable
VK 02/R AF 1: 5 m

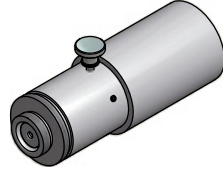

Laser pointer
PS 01/M AF 3



Laser pointer
PS-01/P



Axial air nozzle
PS 01/A AF 1 (M30)
PS 01/A AF 2 (1 1/4")

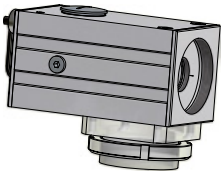

Oscillating mirror
PZ 20 / X AF 5 ($\pm 14.4^\circ$)
PZ 20 / X AF 6 ($\pm 28^\circ$)



Thermal insulating tube
PS 01/K

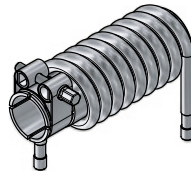

Cooling jacket
PK 01/B AF 1

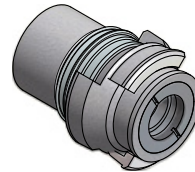

Bayonet coupling
PS 11/N AF 5



90° deflection mirror
PS 11/W



Supplementary tube
Ø 35 mm
ZA 01/Q-35



Intermediate tube
Ø 45 mm
ZA 01/M



Intermediate tube
Ø 45 mm
ZA 01/B



Intermediate tube
Ø 35 mm
ZA 01/Q AF 2

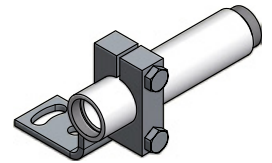

Clamping collar
with angle
PS 11/k-35 AF 2



Set of mounting brackets
PS 11/U



Flange
PS 01/N

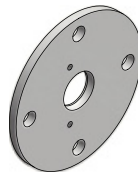

Flange
ZA 01/I

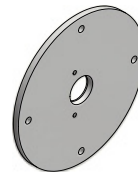

Flange
ZA 01/W



Flange
DN 50

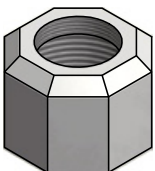

Tube cap
ZA 01/A



Mounting bracket
PS 11/P



Ball flange
ZA 01/D



Supplementary lens
PK 11/E (for PK 11)
PK 21/E (for PK 21/31)
PS 41/E (for PK 41/42)
PS 42/E (for PK 41/42)
PS 27/E AF 1
(for PKL 28/38/68)



Quartz window
PS 01/I AF 2
Sapphire window
PS 15/I
ZnS window adapter
PS 11/D AF 2

Further details on accessories at www.keller-msr.com

Installation examples

Assembly combination PK 01-006 consisting of:

- Thermal insulation tube PS 01/K
- Air purge PS 01/A
- Tube cap ZA 01/A
- Intermediate tube ZA 01/M
- Dust stop ZA 01/C
- Ball flange ZA 01/D
- Clamp ZA 01/E
- Flange ZA 01/I

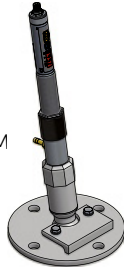

Assembly combination PK 01-007 consisting of:

- Air purge PS 01/A
- Supplementary tube ZA 01/Q-35
- Clamping collar with angle PS 11/K-35 AF2

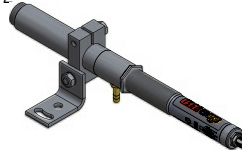

Assembly combination PK 01-011 consisting of:

- Air purge PS 01/A
- Reduction 1 1/4" to M30x1, 5
- DN 50 Flange



Assembly combination PK 21-001 consisting of:

- Thermal insulation tube PS 01/K
- Quartz window PS 01/I AF2
- Air purge PS 01/A
- tube cap ZA 01/A
- Intermediate tube ZA 01/M
- Dust stop ZA 01/C
- Ball flange ZA 01/D
- Clamp ZA 01/E
- Flange ZA 01/I

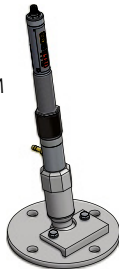

Assembly combination PK 21-002 consisting of:

- Thermal insulating tube PS 01/K
- Bayonet coupling PS 11/N AF4
- Quartz window PS 01/I AF2
- Air purge PS 01/A AF2
- Dust stop ZA 01/C
- Intermediate tube ZA 01/M
- Ball flange ZA 01/D
- Clamp ZA 01/E
- Flange ZA 01/W

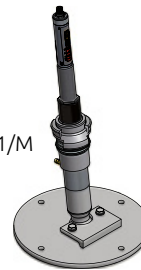

Assembly combination PK 21-004 consisting of:

- Quartz window PS 01/I AF2
- Bayonet coupling PS 11/N AF5
- Air purge PS 01/A AF1
- Washer Ø 35 mm
- Flange PK 20/F-70

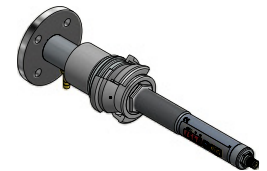

Oscillating mirror PZ 20/X

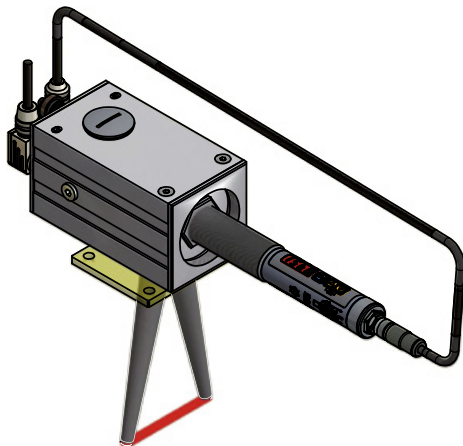

An oscillating mirror can be mounted in front of the infrared thermometer for periodic diversion of the target area.

The temperature is transmitted via the analogue output or the RS-422 interface of the mirror. The measuring position is additionally transmitted via the interface.

The CellaScan PC software which is supplied with the thermometer shows an online temperature profile.

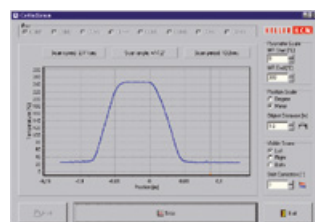

Since 1968, the Division of MSR Infrared Thermometer Solutions of KELLER HCW GmbH develops and produces precision instruments and systems solutions for non-contact temperature measurement. Thanks to our continuous development KELLER MSR ITS today is one of the leading providers worldwide.

With its very large product range of more than 200 models and systems KELLER MSR ITS offers solutions for all standard applications and a variety of special measuring tasks.

A worldwide network of distributors and service centres provides professional expertise and services.





- Headquarters
- Sales and Service Center
- Sales abroad



Keller HCW GmbH · Division MSR
Carl-Keller-Straße 2-10
49479 Ibbenbüren-Laggenbeck
Germany

www.keller-msr.com
Tel. +49 (0) 5451 850
Fax +49 (0) 5451 897392
info@keller-msr.de

Sales and Service Center

China
www.keller-msr.cn
Tel. +86 (10) 82867920
keller@germantech.com.cn

India
www.earthtekniks.com
Tel. +91 (44) 27463747
info@keller-msr-asia.com

France
www.keller-msr.fr
Tel. +33 (0) 951 453050
france@keller-msr.de

Russia
www.keller-msr.ru
Tel. +7 (495) 6642784
info@keller-msr.ru

