

aerospace
climate control
electromechanical
filtration
fluid & gas handling
hydraulics
pneumatics
process control
sealing & shielding

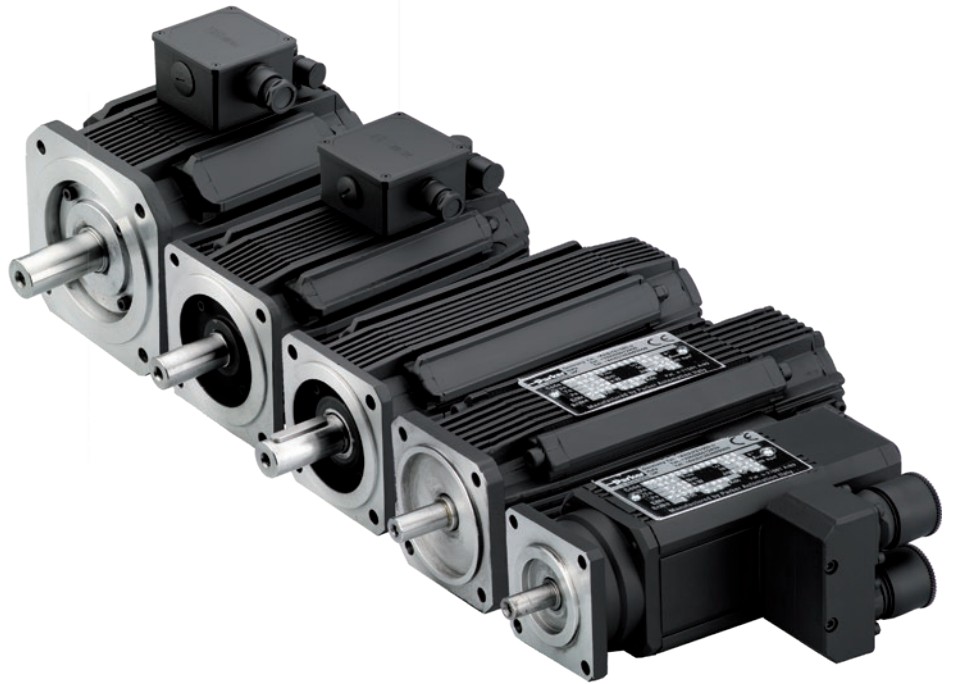

MH / MB Series

Servo Motors from 0.5 to 285 Nm

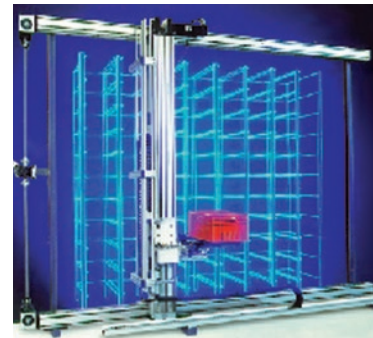

ENGINEERING YOUR SUCCESS.



WARNING – USER RESPONSIBILITY

FAILURE OR IMPROPER SELECTION OR IMPROPER USE OF THE PRODUCTS DESCRIBED HEREIN OR RELATED ITEMS CAN CAUSE DEATH, PERSONAL INJURY AND PROPERTY DAMAGE.

- This document and other information from Parker-Hannifin Corporation, its subsidiaries and authorized distributors provide product or system options for further investigation by users having technical expertise.
- The user, through its own analysis and testing, is solely responsible for making the final selection of the system and components and assuring that all performance, endurance, maintenance, safety and warning requirements of the application are met. The user must analyze all aspects of the application, follow applicable industry standards, and follow the information concerning the product in the current product catalog and in any other materials provided from Parker or its subsidiaries or authorized distributors.
- To the extent that Parker or its subsidiaries or authorized distributors provide component or system options based upon data or specifications provided by the user, the user is responsible for determining that such data and specifications are suitable and sufficient for all applications and reasonably foreseeable uses of the components or systems.

Overview	5
Technical Characteristics.....	6
MH / MB Motors, Size 70 - 0.5...2.5 Nm.....	6
MH / MB Motors, Size 105 - 2.2...8 Nm.....	8
MH / MB Motors, Size 145 - 4.5...28 Nm.....	10
MH / MB Motors, Size 205 - 15...90 Nm.....	12
MH / MB Motors, Size 265 - 75...270 Nm.....	14
Dimensions	15
Options.....	16
Holding brake.....	16
Fan cooling	16
Feedback options	17
Technical specification for high inertia	18
Layout and connectors.....	19
Shaft	19
Increased safety.....	19
Custom options	19
Order Code.....	20
MH / MB Motors	20
Motor power cable for MH/MB motors.....	22
Feedback cable for MH/MB motors.....	23

Parker Hannifin

The global leader in motion and control technologies

A world class player on a local stage

Global Product Design

Parker Hannifin has more than 40 years experience in the design and manufacturing of drives, controls, motors and mechanical products. With dedicated global product development teams, Parker draws on industry-leading technological leadership and experience from engineering teams in Europe, North America and Asia.

Local Application Expertise

Parker has local engineering resources committed to adapting and applying our current products and technologies to best fit our customers' needs.

Manufacturing to Meet Our Customers' Needs

Parker is committed to meeting the increasing service demands that our customers require to succeed in the global industrial market. Parker's manufacturing teams seek continuous improvement through the implementation of lean manufacturing methods throughout the process. We measure ourselves on meeting our customers' expectations of quality and delivery, not just our own. In order to meet these expectations, Parker operates and continues to invest in our manufacturing facilities in Europe, North America and Asia.

Electromechanical Worldwide Manufacturing Locations

Europe

Littlehampton, United Kingdom
Dijon, France
Offenburg, Germany
Filderstadt, Germany
Milan, Italy

Asia

Wuxi, China
Jangan, Korea
Chennai, India

North America

Rohnert Park, California
Irwin, Pennsylvania
Charlotte, North Carolina
New Ulm, Minnesota



Offenburg, Germany

Local Manufacturing and Support in Europe

Parker provides sales assistance and local technical support through a network of dedicated sales teams and authorized technical distributors throughout Europe.

For contact information, please refer to the Sales Offices on the back cover of this document or visit www.parker.com



Milan, Italy



Littlehampton, UK



Filderstadt, Germany



Dijon, France

Servo Motor - MH / MB

Overview

Description

The MH / MB series caters for torques in the range of 0.5 to 285 Nm, speeds up to 10 000 min⁻¹ and includes a total of 50 models available across 5 frame sizes. Thanks to the high quality and performance of the Neodymium-Iron-Boron magnets, and also the encapsulation method used to fasten them to the shaft, the MH / MB series of motors can achieve very high accelerations and withstand high overload without the risk of demagnetisation or detachment of the magnets. Furthermore, shaft and flange size flexibility on all models provides the user with the possibility to optimise their motor selection for any given application. Adequate mechanical over-sizing, low inertia in an extra-strong mechanism and a broad range of models permits the application of the MH / MB series in all fields where high dynamic performance and utmost reliability are crucial features.

Typical applications include any type of automatic machinery, especially in the product packaging and handling industry, and wherever the demand exists for axis speed and position synchronisation.

Features

- Large set of feedback option
- Customization
- Increase inertia option
- ATEX certification for MB105/145
- Options
 - Flying cables
 - Terminal box (power and resolver)
 - External encoder
 - Increased inertia
 - Brake
 - Feedback - resolver/incremental/ SinCos/absolute encoder
 - Thermal protection (PTC for MB and KTY compatible for MH)
 - Second shaft

Application

- Food, Pharma & Beverage
- Packaging Machines
- Material Forming
- Material Handling
- Factory Automation
- Life Science Diagnostic
- Automotive Industry / In-Plant
- Printing Industry
- Textile Machines
- Robotics
- Servo Hydraulic Pumps

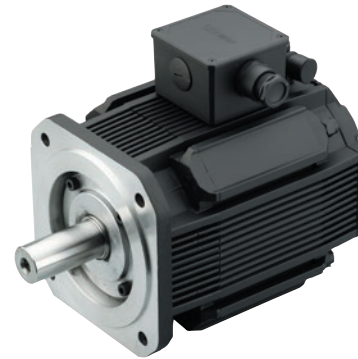

Technical Characteristics - Overview

Motor Type	Permanent magnets synchronous servo motor
Rotor Design	Rotor with surface rare earth magnets
Power supply	230 VAC or 400 VAC
Operating temperature	-10/+40 °C
Number of poles	4 for M_ 70 8 for M_ 105-145-205-265
Power Range	0.05...67 kW
Torque Range	0.2...285 Nm
Speed Range	0...10 000 min ⁻¹
Mounting	Flange with smooth holes B14, B3 option
Shaft End	Plain keyed shaft Plain smooth shaft (option)
Cooling	Natural ventilation Self-ventilation (option for size 105-145-205) Forced ventilation (option for size 105-145-205) Water cooled (option for size 145)
Protection Level (IEC60034-5)	IP64 IP65 (option)
Feedback sensor	Resolver Absolute EnDat or Hiperface Incremental Encoder
Voltage Supply	230 / 400 VAC
Temperature Class	Class F
Connections	Connectors Flying cables Terminal Box (see table option for combination)
Marking	CE / UL (size 145/205 under preparation)
Standards In compliance with:	73/23/CEE and 93/68/CEE EN60034-1 EN60034-5 EN60034-5/A1 EN60034-9 EN60034-14

Technical Characteristics

MH / MB Motors, Size 70 - 0.5...2.5 Nm

230 VAC

Model	Size	Stall		Nominal			Peak Torque ⁽¹⁾	Inertia		Ke ⁽²⁾⁽³⁾	Kt ⁽²⁾⁽³⁾
		Torque ⁽¹⁾	Current	Torque ⁽¹⁾	Speed	Current		No brake	With brake		
		T ₀₆₅ (T ₁₀₅) [Nm]	I ₀₆₅ [A]	T _{n065} [Nm]	n [min ⁻¹]	I _{n065} [A]	T _{max} [Nm]	J [kgmm ²]	J [kgmm ²]	Ke [Vs]	Kt [Nm/A _{rms}]
M_70 20 0,5	70	0.5 (0.9)	0.44	0.5	2000	0.43	2.8	26	55	0.67	1.17
M_70 38 0,5			0.72	0.4	3800	0.66				0.41	0.71
M_70 75 0,5			1.37	0.4	7500	1.00				0.22	0.38
M_70 20 01		1.0 (1.6)	0.84	1.0	2000	0.80	5.1	40	69	0.72	1.25
M_70 38 01			1.39	0.8	3800	1.23				0.42	0.72
M_70 75 01			2.65	0.5	7500	1.43				0.23	0.39
M_70 20 1,5		1.5 (2.2)	1.23	1.5	2000	1.18	6.8	54	83	0.73	1.27
M_70 38 1,5			2.25	1.4	3800	1.96				0.42	0.72
M_70 75 1,5			4.07	0.7	7500	1.85				0.23	0.39
M_70 20 02		2.0 (2.7)	1.55	1.9	2000	1.47	8.4	68	97	0.78	1.36
M_70 38 02			2.82	1.7	3800	2.40				0.43	0.75
M_70 75 02			5.36	0.6	7500	1.74				0.23	0.39
M_70 20 2,5		2.5 (3.1)	1.90	2.4	2000	1.82	9.8	81	11	0.79	1.36
M_70 38 2,5			3.56	2.1	3800	3.01				0.42	0.73
M_70 75 2,5			6.77	0.6	7500	1.77				0.22	0.38

400 VAC

Model	Size	Stall		Nominal			Peak Torque ⁽¹⁾	Inertia		Ke ⁽²⁾⁽³⁾	Kt ⁽²⁾⁽³⁾
		Torque ⁽¹⁾	Current	Torque ⁽¹⁾	Speed	Current		No brake	With brake		
		T ₀₆₅ (T ₁₀₅) [Nm]	I ₀₆₅ [A]	T _{n065} [Nm]	n [min ⁻¹]	I _{n065} [A]	T _{max} [Nm]	J [kgmm ²]	J [kgmm ²]	Ke [Vs]	Kt [Nm/A _{rms}]
M_70 37 0,5	70	0.5 (0.9)	0.44	0.5	3700	0.41	2.8	26	55	0.67	1.17
M_70 70 0,5			0.72	0.4	7000	0.55				0.41	0.71
M_70 37 01		1.0 (1.6)	0.84	0.9	3700	0.74	5.1	40	69	0.72	1.25
M_70 70 01			1.39	0.6	7000	0.85				0.42	0.72
M_70 37 1,5		1.5 (2.2)	1.23	1.3	3700	1.07	6.8	54	83	0.73	1.27
M_70 70 1,5			2.25	0.8	7000	1.27				0.42	0.72
M_70 37 2,0		2.0 (2.7)	1.55	1.7	3700	1.32	8.4	68	97	0.78	1.36
M_70 70 2,0			2.82	0.9	7000	1.35				0.43	0.75
M_70 37 2,5		2.5 (3.1)	1.90	2.1	3700	1.60	9.8	81	110	0.79	1.36
M_70 70 2,5			3.56	1.2	7000	1.73				0.42	0.73

⁽¹⁾ Data referred to motor suspend in horizontal position in free still air, 20 °C ambient temperature

⁽²⁾ Data measured at 20 °C. When "hot" consider 5 % derating

⁽³⁾ Tolerance data ±10 %

Speed Torque Curves

MH/MB70

3800 min⁻¹ 230 V - 7000 min⁻¹ 400 V

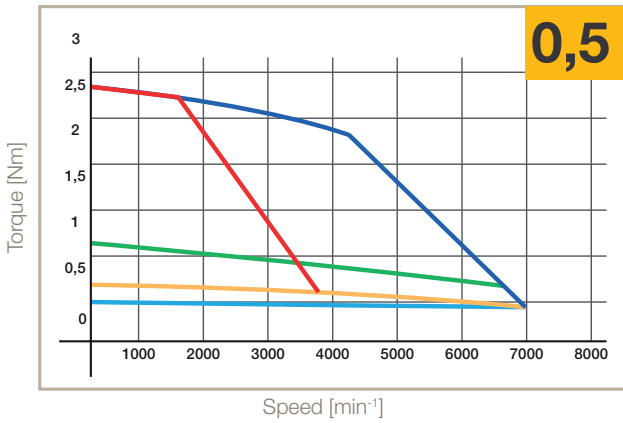

3800 min⁻¹ 230 V - 7000 min⁻¹ 400 V

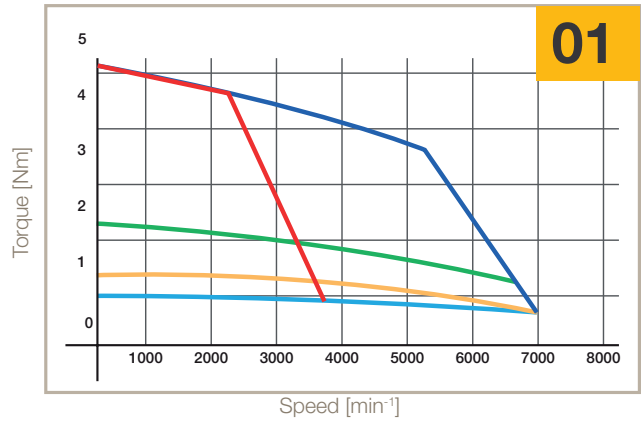

3800 min⁻¹ 230 V - 7000 min⁻¹ 400 V

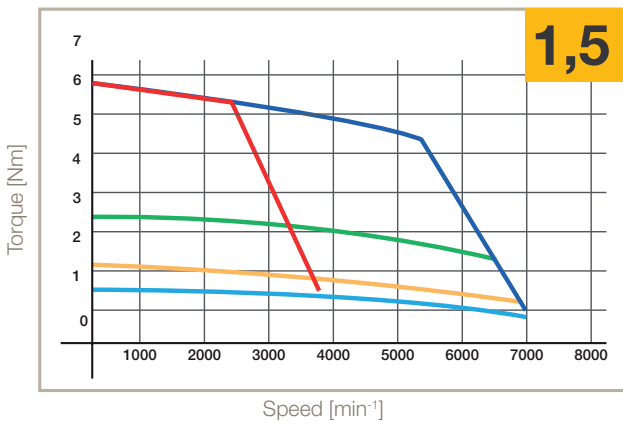

3800 min⁻¹ 230 V - 7000 min⁻¹ 400 V

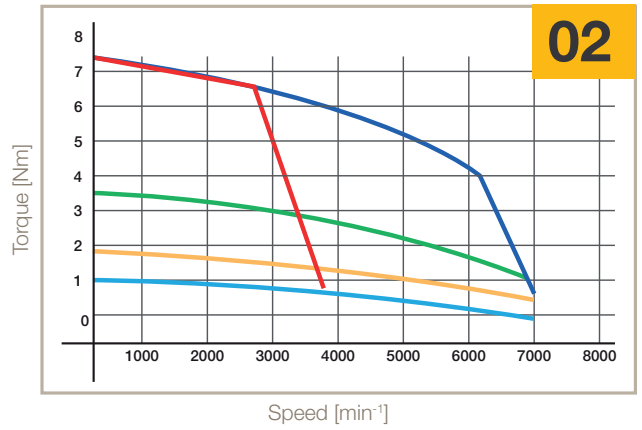

3800 min⁻¹ 230 V - 7000 min⁻¹ 400 V

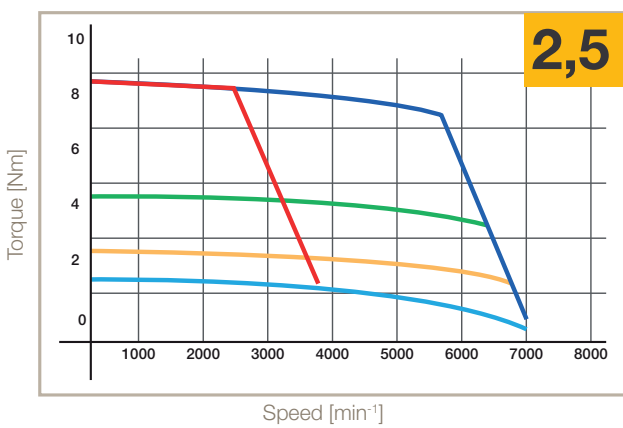

- S1 65 K, ΔT
- S3 10 %, 5 min, 400 V
- S3 10 %, 5 min, 230 V
- S3 50 %, 5 min
- S3 20 %, 5 min

MH / MB Motors, Size 105 - 2.2...8 Nm

230 VAC

Model	Size	Stall		Nominal			Peak Torque ⁽¹⁾	Inertia		Ke ⁽²⁾⁽³⁾	Kt ⁽²⁾⁽³⁾
		Torque ⁽¹⁾	Current	Torque ⁽¹⁾	Speed	Current		No brake	With brake		
		T ₀₆₅ (T ₁₀₅) [Nm]	I ₀₆₅ [A]	T _{n065} [Nm]	n [min ⁻¹]	I _{n065} [A]	T _{max} [Nm]	J [kgmm ²]	J [kgmm ²]	Ke [Vs]	Kt [Nm/A _{rms}]
M_105 16 02	105	2.2 (3.5)	1.5	2.2	1600	1.4	11.0	190	253	0.9	1.63
M_105 25 02			2.1	2.1	2500	2.0				0.6	1.11
M_105 30 02			2.8	2.1	3000	2.6				0.5	0.83
M_105 50 02			4.3	1.8	5000	3.5				0.3	0.55
M_105 16 04		4.0 (6.1)	2.6	4.0	1600	2.5	19.5	340	403	1.0	1.65
M_105 25 04			3.8	3.7	2500	3.5				0.7	1.13
M_105 30 04			5.0	3.6	3000	4.4				0.5	0.85
M_105 50 04			7.4	2.7	5000	5.0				0.3	0.58
M_105 16 06		6.0 (8.3)	3.9	5.9	1600	3.7	26.2	480	543	1.0	1.65
M_105 25 06			5.6	5.5	2500	5.0				0.7	1.15
M_105 30 06			7.4	5.2	3000	6.4				0.5	0.87
M_105 50 06			11.2	3.6	5000	6.7				0.3	0.58
M_105 16 08		8.0 (10.0)	5.2	7.8	1600	5.0	31.7	620	683	1.0	1.65
M_105 25 08			7.5	7.2	2500	6.6				0.7	1.15
M_105 30 08			9.7	6.8	3000	8.2				0.5	0.88
M_105 50 08			14.2	4.4	5000	7.9				0.4	0.61

400 VAC

Model	Size	Stall		Nominal			Peak Torque ⁽¹⁾	Inertia		Ke ⁽²⁾⁽³⁾	Kt ⁽²⁾⁽³⁾
		Torque ⁽¹⁾	Current	Torque ⁽¹⁾	Speed	Current		No brake	With brake		
		T ₀₆₅ (T ₁₀₅) [Nm]	I ₀₆₅ [A]	T _{n065} [Nm]	n [min ⁻¹]	I _{n065} [A]	T _{max} [Nm]	J [kgmm ²]	J [kgmm ²]	Ke [Vs]	Kt [Nm/A _{rms}]
M_105 30 02	105	2.2 (3.5)	1.5	2.1	3000	1.4	11.0	190	253	0.9	1.63
M_105 45 02			2.1	1.9	4500	1.8				0.6	1.11
M_105 60 02			2.8	1.7	6000	2.2				0.5	0.83
M_105 30 04		4.0 (6.1)	2.6	3.6	3000	2.3	19.5	340	403	1.0	1.65
M_105 45 04			3.8	3.0	4500	2.8				0.7	1.13
M_105 60 04			5.0	2.4	6000	3.0				0.5	0.85
M_105 30 06		6.0 (8.3)	3.9	5.3	3000	3.4	26.2	480	543	1.0	1.65
M_105 45 06			5.6	4.1	4500	3.8				0.7	1.15
M_105 60 06			7.4	3.0	6000	3.7				0.5	0.87
M_105 30 08		8.0 (10.0)	5.2	6.9	3000	4.4	31.7	620	683	1.0	1.65
M_105 45 08			7.5	5.2	4500	4.9				0.7	1.15
M_105 60 08			9.7	3.6	6000	4.4				0.5	0.88

⁽¹⁾ Data referred to motor suspend in horizontal position in free still air, 20 °C ambient temperature

⁽²⁾ Data measured at 20 °C. When "hot" consider 5 % derating

⁽³⁾ Tolerance data ±10 %

Speed Torque Curves

MH/MB105

3000 min⁻¹ 230 V - 6000 min⁻¹ 400 V

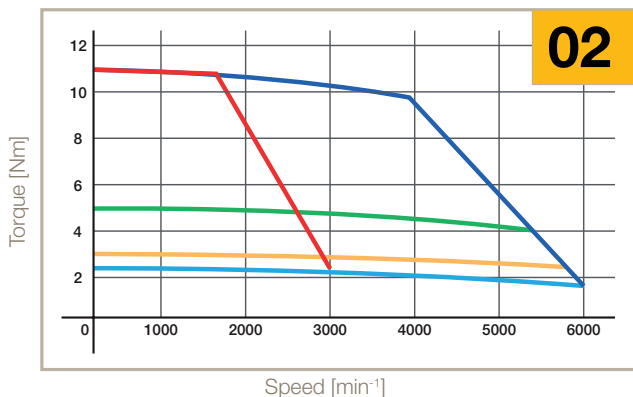

3000 min⁻¹ 230 V - 6000 min⁻¹ 400 V

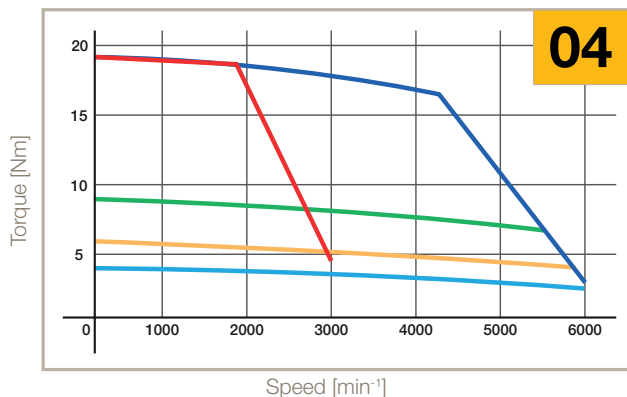

3000 min⁻¹ 230 V - 6000 min⁻¹ 400 V

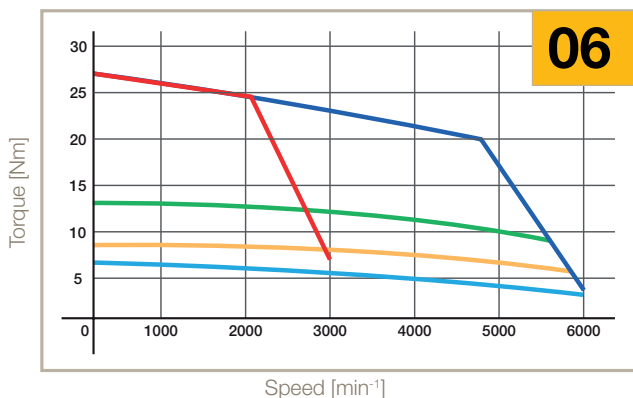

3000 min⁻¹ 230 V - 6000 min⁻¹ 400 V

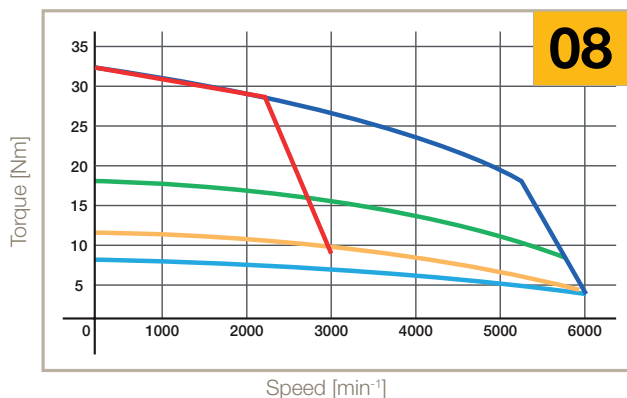

- S1 65 K, ΔT
- S3 10 %, 5 min, 400 V
- S3 50 %, 5 min
- S3 10 %, 5 min, 230 V
- S3 20 %, 5 min

MH / MB Motors, Size 145 - 4.5...28 Nm

230 VAC

Model	Size	Stall		Nominal			Peak Torque ⁽¹⁾	Inertia		Ke ⁽²⁾⁽³⁾	Kt ⁽²⁾⁽³⁾
		Torque ⁽¹⁾	Current	Torque ⁽¹⁾	Speed	Current		No brake	With brake		
		T ₀₆₅ (T ₁₀₅) [Nm]	I ₀₆₅ [A]	T _{n065} [Nm]	n [min ⁻¹]	I _{n065} [A]	T _{max} [Nm]	J [kgmm ²]	J [kgmm ²]	Ke [Vs]	Kt [Nm/A _{rms}]
M_145 5,5 04	145	4.5 (9)	1.1	4.6	550	1.1	28	780	975	2.1	3.65
M_145 11 04			2.3	4.6	1100	2.4				1.2	2.03
M_145 16 04			3.4	4.5	1600	3.3				0.8	1.42
M_145 25 04			4.7	4.3	2500	4.5				0.6	1.01
M_145 40 04			8.1	4.1	4000	7.2				0.4	0.60
M_145 5,5 08		8.7 (16)	2.0	8.7	550	2.0	49	1050	1245	2.7	4.69
M_145 11 08			3.7	8.7	1100	3.6				1.4	2.49
M_145 16 08			5.4	8.6	1600	5.2				1.0	1.70
M_145 25 08			8.2	8.1	2500	7.4				0.7	1.14
M_145 40 08			12.3	7.0	4000	9.7				0.4	0.76
M_145 5,5 15		15.0 (27)	3.3	15.0	550	3.2	86	1600	1795	2.9	4.94
M_145 11 15			6.2	14.7	1100	5.9				1.5	2.59
M_145 16 15			9.1	14.3	1600	8.5				1.0	1.78
M_145 25 15			14.2	13.6	2500	12.5				0.7	1.14
M_145 40 15			21.3	10.9	4000	15.0				0.4	0.76
M_145 5,5 22		22.0 (37)	4.7	21.9	550	4.6	117	2150	2345	2.9	5.03
M_145 11 22			8.9	21.3	1100	8.4				1.5	2.65
M_145 16 22			13.1	20.8	1600	12.1				1.0	1.80
M_145 25 22			20.8	19.1	2500	17.6				0.7	1.13
M_145 40 22			31.1	13.4	4000	18.6				0.4	0.76
M_145 5,5 28		28.0 (45)	5.9	27.8	550	5.8	143	2700	2895	2.9	5.07
M_145 11 28			11.3	26.9	1100	10.6				1.5	2.65
M_145 16 28			17.0	26.2	1600	15.5				1.0	1.78
M_145 25 28			26.5	23.2	2500	21.4				0.7	1.13
M_145 40 28			39.6	14.1	4000	19.7				0.4	0.76

400 VAC

Model	Size	Stall		Nominal			Peak Torque ⁽¹⁾	Inertia		Ke ⁽²⁾⁽³⁾	Kt ⁽²⁾⁽³⁾
		Torque ⁽¹⁾	Current	Torque ⁽¹⁾	Speed	Current		No brake	With brake		
		T ₀₆₅ (T ₁₀₅) [Nm]	I ₀₆₅ [A]	T _{n065} [Nm]	n [min ⁻¹]	I _{n065} [A]	T _{max} [Nm]	J [kgmm ²]	J [kgmm ²]	Ke [Vs]	Kt [Nm/A _{rms}]
M_145 10 04	145	4.5 (9)	1.1	4.5	1000	1.1	28	780	975	2.1	3.65
M_145 20 04			2.3	4.5	2000	2.3				1.2	2.03
M_145 30 04			3.4	4.3	3000	3.2				0.8	1.42
M_145 45 04			4.7	3.9	4500	4.0				0.6	1.01
M_145 10 08			8.7 (16)	2.0	8.7	1000				1.9	49
M_145 20 08		3.7		8.4	2000	3.5	1.4	2.49			
M_145 30 08		5.4		7.9	3000	4.8	1.0	1.70			
M_145 45 08		8.2		7.1	4500	6.6	0.7	1.14			
M_145 10 15		15.0 (27)		3.3	14.8	1000	3.1	86	1600	1795	
M_145 20 15			6.2	13.7	2000	5.5	1.5				2.59
M_145 30 15			9.1	12.7	3000	7.5	1.0				1.78
M_145 45 15			14.2	9.8	4500	9.1	0.7				1.14
M_145 10 22			22.0 (37)	4.7	21.4	1000	4.5				117
M_145 20 22		8.9		19.4	2000	7.6	1.5	2.65			
M_145 30 22		13.1		17.3	3000	10.1	1.0	1.80			
M_145 45 22		20.8		11.6	4500	10.8	0.7	1.13			
M_145 10 28		28.0 (45)		5.9	27.1	1000	5.6	143	2700	2895	
M_145 20 28			11.3	23.9	2000	9.4	1.5				2.65
M_145 30 28			17.0	21.1	3000	12.5	1.0				1.78
M_145 45 28			26.5	10.0	4500	9.4	0.7				1.13

Speed Torque Curves

MH/MB145

2500 min⁻¹ 230 V - 4500 min⁻¹ 400 V

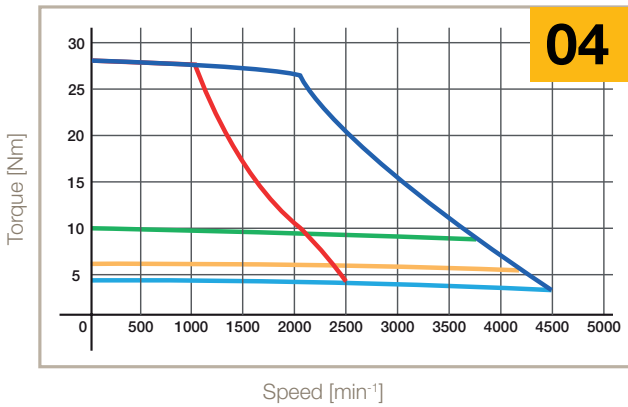

2500 min⁻¹ 230 V - 4500 min⁻¹ 400 V

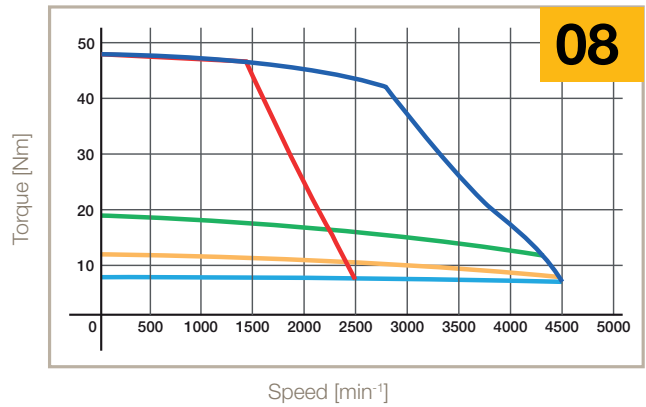

2500 min⁻¹ 230 V - 4500 min⁻¹ 400 V

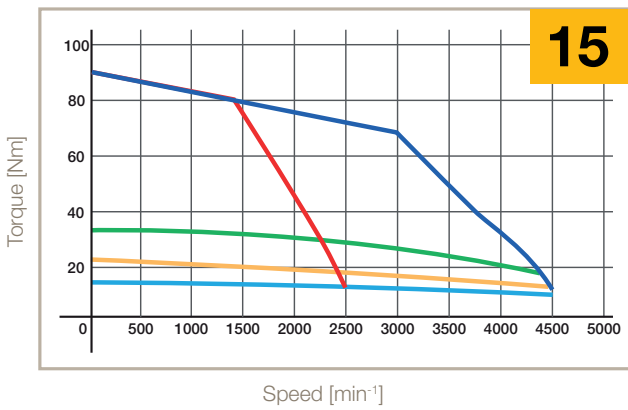

2500 min⁻¹ 230 V - 4500 min⁻¹ 400 V

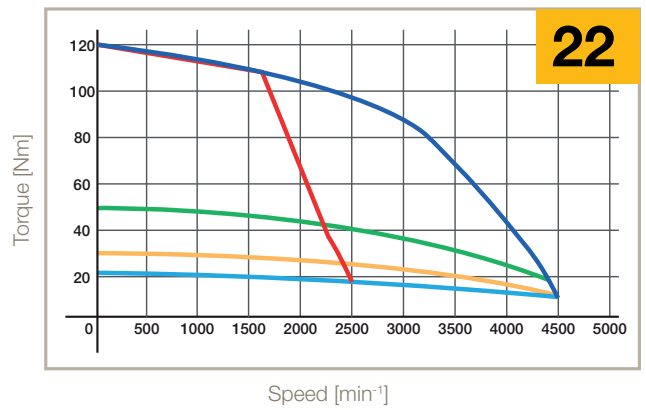

2500 min⁻¹ 230 V - 4500 min⁻¹ 400 V

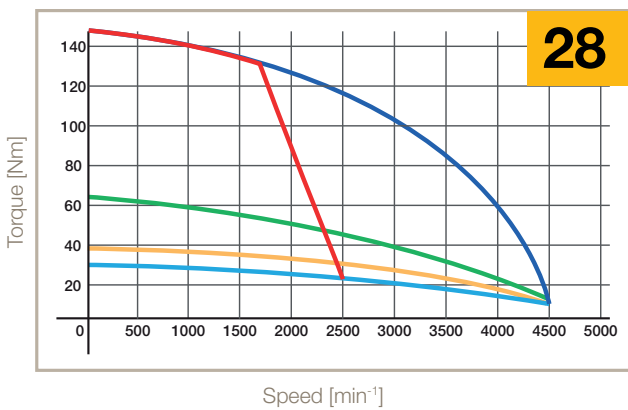

- S1 65 K, ΔT
- S3 10 %, 5 min, 400 V
- S3 10 %, 5 min, 230 V
- S3 50 %, 5 min
- S3 20 %, 5 min

⁽¹⁾ Data referred to motor suspend in horizontal position in free still air, 20 °C ambient temperature
⁽²⁾ Data measured at 20 °C. When "hot" consider 5 % derating
⁽³⁾ Tolerance data ±10 %

MH / MB Motors, Size 205 - 15...90 Nm

230 VAC

Model	Size	Stall		Nominal			Peak Torque ⁽¹⁾	Inertia		Ke ⁽²⁾⁽³⁾	Kt ⁽²⁾⁽³⁾
		Torque ⁽¹⁾	Current	Torque ⁽¹⁾	Speed	Current		No brake	With brake		
		T ₀₆₅ (T ₁₀₅) [Nm]	I ₀₆₅ [A]	T _{n065} [Nm]	n [min ⁻¹]	I _{n065} [A]	T _{max} [Nm]	J [kgmm ²]	J [kgmm ²]	Ke [Vs]	Kt [Nm/A _{rms}]
M_205 11 15	205	15 (22)	6.3	14.7	1150	6.2	69	3500	4035	1.4	2.38
M_205 17 15			8.6	14.4	1700	8.3				1	1.74
M_205 5,5 28		28 (39)	6.9	28.6	550	6.9	123	5000	5535	2.5	4.35
M_205 11 28			13.0	28.2	1150	12.7				1.3	2.31
M_205 17 28			20.1	27.6	1700	19.3				0.9	1.50
M_205 5,5 50		50 (70)	12.4	51.3	550	12.3	222	8000	8535	2.5	4.35
M_205 11 50			22.1	50.0	1150	21.3				1.4	2.45
M_205 17 50			33.1	48.0	1700	30.8				0.9	1.63
M_205 5,5 70		70 (98)	16.8	71.1	550	16.5	310	11 000	11 535	2.6	4.49
M_205 11 70			30.7	68.6	1150	29.3				1.4	2.45
M_205 17 70			46.1	65.0	1700	41.7				0.9	1.63
M_205 5,5 90		90 (126)	22.1	90.9	550	21.8	398	14 000	14 535	2.5	4.35
M_205 11 90			44.3	87.0	1150	41.8				1.3	2.18
M_205 17 90			59	81.7	1700	52.4				0.9	1.63

400 VAC

Model	Size	Stall		Nominal			Peak Torque ⁽¹⁾	Inertia		Ke ⁽²⁾⁽³⁾	Kt ⁽²⁾⁽³⁾
		Torque ⁽¹⁾	Current	Torque ⁽¹⁾	Speed	Current		No brake	With brake		
		T ₀₆₅ (T ₁₀₅) [Nm]	I ₀₆₅ [A]	T _{n065} [Nm]	n [min ⁻¹]	I _{n065} [A]	T _{max} [Nm]	J [kgmm ²]	J [kgmm ²]	Ke [Vs]	Kt [Nm/A _{rms}]
M_205 20 15	205	15 (22)	6.3	14.1	2000	5.9	69	3500	4035	1.4	2.38
M_205 30 15			8.6	13.4	3000	7.7				1	1.74
M_205 10 28		28 (39)	6.9	28.2	1000	6.8	123	5000	5535	2.5	4.35
M_205 20 28			13.0	27.3	2000	12.3				1.3	2.31
M_205 30 28			20.1	25.7	3000	18.0				0.9	1.50
M_205 10 50		50 (70)	12.4	50.4	1000	12.1	222	8000	8535	2.5	4.35
M_205 20 50			22.1	47.0	2000	20.1				1.4	2.45
M_205 30 50			33.1	41.7	3000	26.8				0.9	1.63
M_205 10 70		70 (98)	16.8	69.4	1000	16.1	310	11 000	11 535	2.6	4.49
M_205 20 70			30.7	62.9	2000	26.9				1.4	2.45
M_205 30 70			46.1	52.3	3000	33.7				0.9	1.63
M_205 10 90		90 (126)	22.1	88.2	1000	21.2	398	14 000	14 535	2.5	4.35
M_205 20 90			44.3	78.3	2000	37.7				1.3	2.18
M_205 30 90			59.0	61.6	3000	39.7				0.9	1.63

⁽¹⁾ Data referred to motor suspend in horizontal position in free still air, 20 °C ambient temperature

⁽²⁾ Data measured at 20 °C. When "hot" consider 5 % derating

⁽³⁾ Tolerance data ±10 %

Speed Torque Curves

MH/MB205

1700 min⁻¹ 230 V - 3000 min⁻¹ 400 V

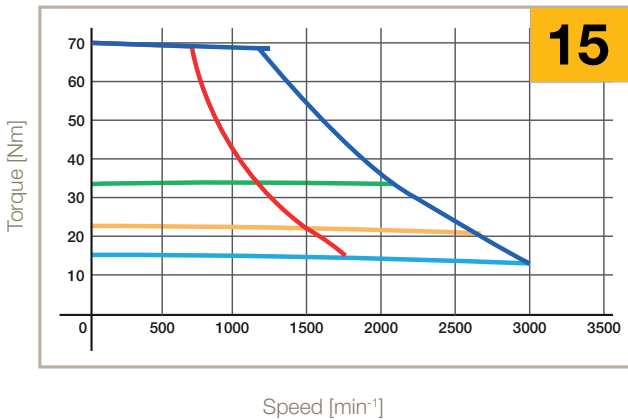

1700 min⁻¹ 230 V - 3000 min⁻¹ 400 V

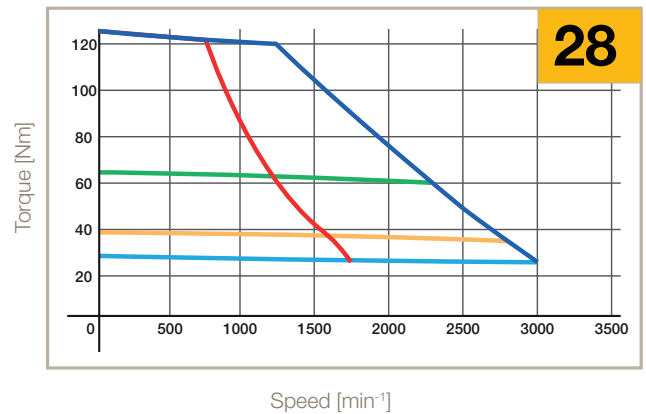

1700 min⁻¹ 230 V - 3000 min⁻¹ 400 V

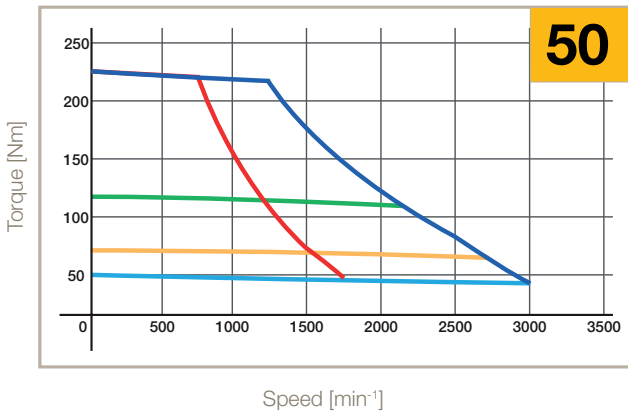

1700 min⁻¹ 230 V - 3000 min⁻¹ 400 V

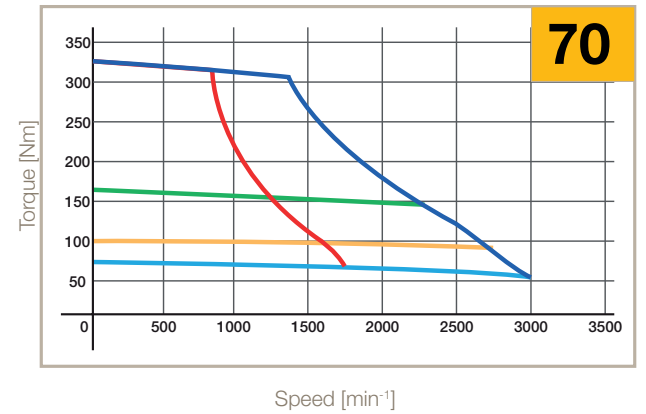

1700 min⁻¹ 230 V - 3000 min⁻¹ 400 V

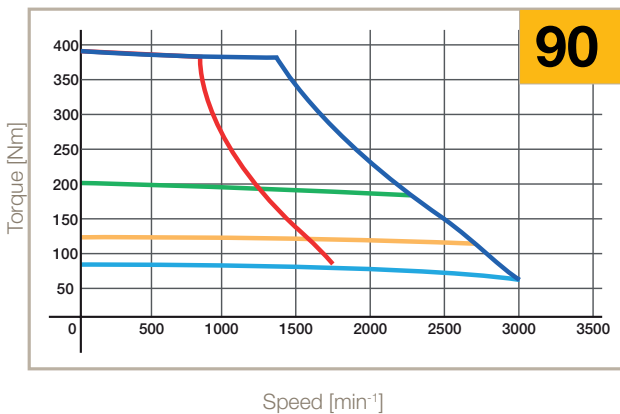

- S1 65 K, ΔT
- S3 10 %, 5 min, 400 V
- S3 10 %, 5 min, 230 V
- S3 50 %, 5 min
- S3 20 %, 5 min

MH / MB Motors, Size 265 - 75...270 Nm

400 VAC

Model	Size	Stall		Nominal			Peak Torque ⁽¹⁾	Inertia		Ke ⁽²⁾⁽³⁾	Kt ⁽²⁾⁽³⁾
		Torque ⁽¹⁾	Current	Torque ⁽¹⁾	Speed	Current		No brake	With brake		
		T ₀₆₅ (T ₁₀₅) [Nm]	I ₁₀₅ [A]	T _{n105} [Nm]	n [min ⁻¹]	I _{n105} [A]	T _{max} [Nm]	J [kgmm ²]	J [kgmm ²]	Ke [Vs]	Kt [Nm/A _{rms}]
M_265 10 75	265	75 (95)	17.8	94	1000	17.6	240	22 000	30 100	3.08	5.33
M_265 20 75			35.6	92	2000	34.5				1.54	2.67
M_265 30 75			55.3	87	3000	48.8				1.03	1.78
M_265 10 150		145 (175)	32.8	175	1000	32.8	480	36 000	44 100	3.08	5.33
M_265 20 150			73.7	170	2000	71.6				1.37	2.37
M_265 30 150			98.1	144	3000	80.7				1.03	1.78
M_265 10 220		205 (255)	47.8	254	1000	47.6	695	49 000	61 960	3.08	5.33
M_265 20 220			95.6	231	2000	86.6				1.54	2.67
M_265 30 220			143	185	3000	104				1.03	1.78
M_265 10 285		270 (330)	69.5	325	1000	68.5	900	63 000	75 960	2.74	4.75
M_265 20 285			139	288	2000	121				1.37	2.37
M_265 30 285			185	215	3000	151				1.03	1.78

⁽¹⁾ Data referred to motor suspend in horizontal position in free still air, 20 °C ambient temperature

⁽²⁾ Data measured at 20 °C. When "hot" consider 5 % derating

⁽³⁾ Tolerance data ±10 %

Speed Torque Curves

3000 min⁻¹ 400 V

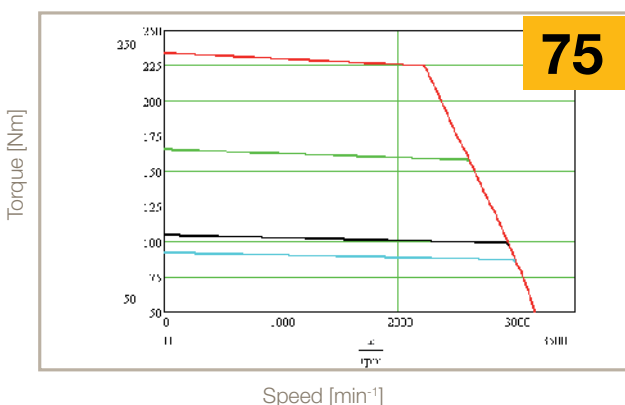

3000 min⁻¹ 400 V

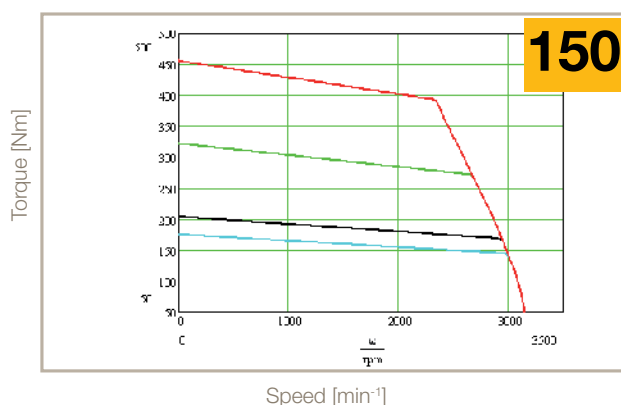

3000 min⁻¹ 400 V

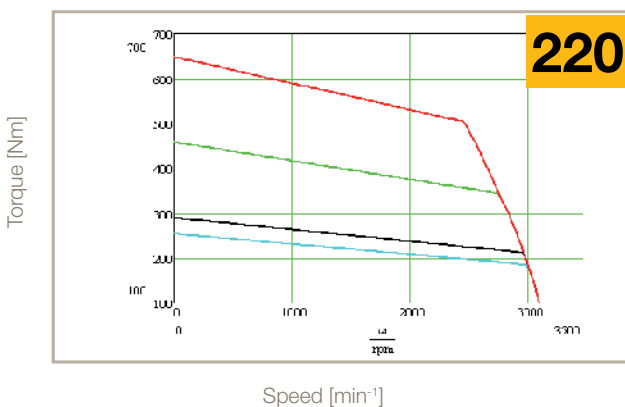

3000 min⁻¹ 400 V

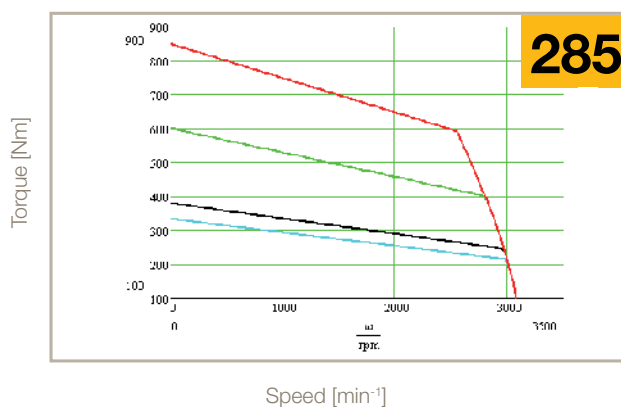

— S1 65 K, ΔT — S3 50 %, 5 min
— S3 10 %, 5 min, 400 V — S3 20 %, 5 min

Dimensions

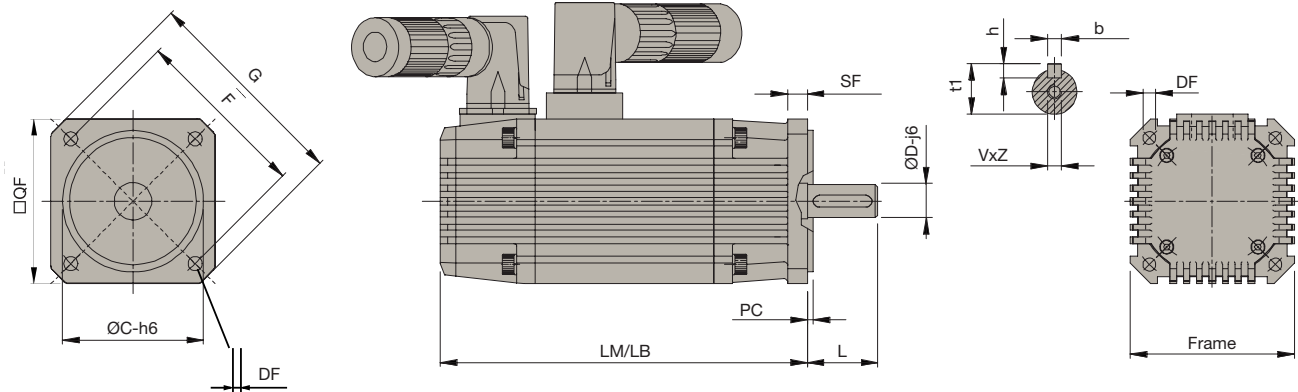

Motor - Size	LM/LB	Weight	DxL	bxh	t1	VxZ	C	F	DF	G	SF	PC	QF	Order code QF	
70	0,5	158/214	2	11x23 14x30	4x4 5x5	12.5 16	M4x10 M4x12.5	60	75	6	90	8.5	2.5	70	5
	01	188/244	2.8												
	1,5	218/274	3.5												
	02	248/304	4.3												
	2,5	278/334	5.1												
105	02	186/250	5	19x40 24x50	6x6 8x7	21.5 27	M6x16 M8x19	95	115	9.5	140	10	3.5	105	5
	04	229/293	7					95	115	9.5	140	10	3.5	105	4
	06	273/337	9					80	115	9.5	140	10	3.5	105	9
	08	317/381	11					110	115	9.5	140	10	3.5	105	6
145	04	200/274	8	19x40 24x50 28x60	6x6 8x7	21.5 27 31	M6x16 M8x19 M10x22	130	165	11.5	200	12	3.5	145	5
	08	231/305	12					130	165	11.5	200	12	3.5	145	4
	15	292/366	18					130	165	11.5	200	12	3.5	145	4
	22	354/428	23					130	165	11.5	200	12	3.5	145	4
205	28	416/490	28	38x80 42x110	10x8 12x8	41 45	M12x32 M16x40	180	215	14	250	18	4	205	5
	15	239/338	20												
	28	273/372	29												
	50	342/441	44												
	70	411/510	59												
265	90	480/579	74	48x110	14x9	51.5	M16x40	250	300	19	342	35	4	264	5
	75	340/475	89												
	150	447/582	126												
	220	554/689	164												
285	661/796	203													

LM: Motor length without brake with resolver

LB: Motor length with brake with resolver

DxL: Shaft

bxh: Key

t1: Overall shaft height

VxZ: Shaft hole depth

mm for dimensions, kg for weight

C: Center

F: Distance between center of holes clamp

DF: Fixing holes

G: Dimension in diagonal

SF: Flange thickness

PC: Centering depth

QF: Flange square

Options

Parker Mx family motors are available with standard and custom options to adapt motor on your application. If the option for your application is not listed, please consult our technical department.

Holding Brake

All MH, MB motors are available with an optional holding brake. Two different brake types exist, standard holding brake (option A) and special brake (option B) depending on the features of your application needs. Incorporated into the motor is the fail-safe holding brake (supply voltage 24 VDC \pm 10 %) which is applied when no voltage is present. Because of the power taken by the brake, torque values must be reduced by 5 % (10 % for size 265). The holding brake shall be used with the motor only at a standstill and not for dynamic braking. For maintenance, please refer to technical manual.

Holding Brake ⁽¹⁾	Option	Voltage [V]	Current @20 °C [A]	Torque @20 °C [Nm]	Added Length [mm]	Added Weight [kg]	Torque derating of motor
M_70_A	A	24 \pm 10 %	0.53	2	56	1.1	5 %
M_70_B	B	n.a.					
M_105_A	A	24 \pm 10 %	1.1	10	64	3	5 %
M_105_B	B	n.a.					
M_145_A_04	A	24 \pm 10 %	1.8	4	74	5	5 %
M_145_A_08				8			
M_145_A_15				15			
M_145_A_22				22			
M_145_A_28				28			
M_145_B	B	24 \pm 10 %	0.8	22	74	5	5 %
M_205_B	B	24 \pm 10 %	2.1	120	99	14	5 %
M_265_A_75	A	24 \pm 10 %	2.9	225	135	30	10 %
M_265_A_150				450		35	
M_265_A_220							
M_265_A_285							
M_265_B	B	n.a.					

⁽¹⁾ If more than one option is required, please check with our technical department the feasibility.

Fan cooling

For high duty cycle applications, Parker offer 3 different types of cooling option: servo-ventilated, self ventilated and water cooled. Please refer to motors in the table below.

With servo-ventilated the motors (order Code M_SV), an increase of 25 % torque and current based on nominal values (except for the maximum torque and current data) is provided. The servo-ventilated 205 motor is equipped with an external condenser for starting the fan.

With the self-ventilated option (order Code M_V), the torque is increased proportionally to the nominal speed.

For water-cooled motors (order code M_W, available only for size 145), consider a performance increase of approx. 100 % in the torque and current, except peak data.

Motor MB / MH	Option ⁽¹⁾	Voltage	Current [A]	Frequency [Hz]	Speed [min ⁻¹]	Added Length [mm]	Added Weight [kg]	Torque increasing of motor
105	SV	24 VDC \pm 10 %	0.17	n.a.	3000	64	1	25 %
	V	n.a.	n.a.	n.a.	n.a.	34	0.25	Depending of speed
145	SV	230 VAC Single Phase \pm 10 %	0.35	50	3000	97	2	25 %
	V	n.a.	n.a.	n.a.	n.a.	44	0.55	Depending of speed
205	SV	230 VAC Single Phase \pm 10 %	0.22	50	3000	109	2.2	25 %
	V	n.a.	n.a.	n.a.	n.a.	54	1.1	Depending of speed

⁽¹⁾ If more than one option is required, please check with our technical department the feasibility.

Feedback options

M_ motors are available with standard resolver feedback, but for different type of application we can offer the following types of feedback:

- Incremental Encoder with hall sensors
- Hiperface absolute encoder (single or multi-turn), DSL®
- EnDat absolute encoder (single or multi-turn)

Resolver

Poles	2
Transformation ratio	0.5
Operating temperature	-50...+150 °C
Motor associations	all sizes

Incremental Encoder with Hall Sensor

Code	A1	A2	A3	B1	C4
Resolution [C/T]	2000	2048	4096	3000	5000
Poles	8			4	8
System Accuracy	±32"	±32"	±16"	±22"	±13"
Voltage	+5 VDC ±5 % - 200 mA				
Reference Mark	Yes				
Max Speed [min ⁻¹]	6000				
Output Circuit	Line drive differential mode 20 mA				
Operating Temperature	-20...+100 °C	-20...+85 °C	-20...+100 °C		
M_ Motors Associations					
M_70	-	-	-	Δ 10 mm	-
M_105	✓	✓	✓	-	✓
M_145	✓	✓	✓	-	✓
M_205	✓	✓	✓	-	✓
M_265	-	-	-	-	-

- Not possible

✓ Possible without increment

Δ Possible with increment motor length

Hiperface Absolute Encoder

Code	S1	S2	A6	A7	S5	S6	L2	L4
Type	Optical							
Turn	Single	Multi	Single	Multi	Single	Multi	Multi	Multi
Incremental Signals	1 V _{PP}				-	-	-	-
Line Count	1024				-	-	-	-
Resolution	32 768 (15 bit)		32 768 (15 bit)		262 144 (18 bit)		2 097 152 (21 bit)	
Absolute rotation	1	4096	1	4096	1	4096	4096	
System Accuracy	±45"				±40"		±52"	
Power Supply	8 VDC				7...12 VDC		7...12 VDC	
Max Speed [min ⁻¹]	6000				-		9000	
Temperature	-20...+115°C				-20...+105°C		-30°C... +120°C	-30°C ... +115°C
Safety integrity level	SIL2 (IEC 61508), SILCL2 (IEC 62061)		Not Available		SIL2 (IEC 61508), SILCL2 (IEC 62061)		-	SIL2 (IEC 61508), SILCL2 (IEC 62061)
MB / MH Motors Associations								
M_70	Δ 10 mm	Δ 10 mm	Δ 10 mm	Δ 10 mm	-	-	-	-
M_105	Δ 19 mm	Δ 19 mm	Δ 19 mm	Δ 19 mm	-	-	-	-
M_145	Δ 19 mm	Δ 19 mm	Δ 19 mm	Δ 19 mm	Δ 19 mm	Δ 19 mm	Δ 19 mm	Δ 19 mm
M_205	Δ 19 mm	Δ 19 mm	Δ 19 mm	Δ 19 mm	Δ 19 mm	Δ 19 mm	Δ 19 mm	Δ 19 mm
M_265	-	-	-	-	-	-	-	-

- Not possible

✓ Possible without increment

Δ Possible with increment motor length

EnDat Absolute Encoder

Code	B9	D5
Type	Inductive	Optical
Turn	Multi	Multi
Incremental Signals	1V _{PP}	
Line Count	32	512
Positions per revolutions	524288 (19bit)	8192 (13 bit)
Distinguishable revolutions	4096	
System Accuracy	±400"	±60"
Power Supply	5 VDC	
Max Speed [min ⁻¹]	12 000	7000
Temperature	-20...+115 °C	-30...+115 °C
Absolute position values	EnDat 2.1	EnDat 2.2
Safety integrity level:	not available	
M_Motors Associations		
M_70	-	-
M_105	Δ 19 mm	Δ 19 mm
M_145	✓	Δ 19 mm
M_205	Δ 19 mm	Δ 19 mm
M_265	-	✓

- Not possible
- ✓ Possible without increment
- Δ Possible with increment motor length

Technical specification for high inertia

Option Inertia	Added ...	Unit	105				145					205				
			02	04	06	08	04	08	15	22	28	15	28	50	70	90
M	Inertia	[kgmm ²]	140				790					4400				
	Length	[mm]	0				0					0				
	Weight	[kg]	0.340				0.990					2.065				
ML	Inertia	[kgmm ²]	530		n.a.		1770			n.a.		12100			n.a.	
	Length	[mm]	64		n.a.		74			n.a.		99			n.a.	
	Weight	[kg]	1.5		n.a.		3.3	3.6		n.a.		7.6	11.9		n.a.	

Layout and connectors

M_ motors are available with different combinations of connectors and layout, depending of size of motor and the application

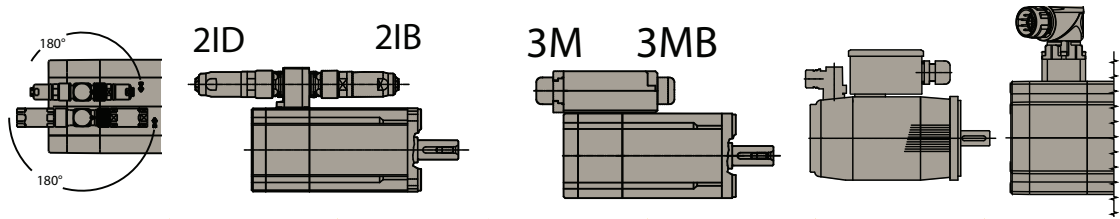

	2x Parallel upright connectors	2x Forward facing connectors	2x Rear facing connectors	Terminal box rear facing	Terminal box forward facing	Terminal box forward facing	Hiperface DSL® connector
	2I	2IB	2ID	3M	3MB	3I	IZ
MH_70	✓	-	-	-	-	-	-
MH_105	✓	-	-	-	-	-	-
MH_145	-	-	-	-	-	✓	✓
MH_205	-	-	-	-	-	✓	✓
MH_265	-	-	-	✓	-	-	-
MB_70	✓	-	-	✓	✓	-	-
MB_105	✓	-	-	✓	✓	-	-
MB_145	✓	-	-	✓	✓	✓	✓
MB_205	-	-	-	✓	✓	✓	✓
MB_265	-	-	-	✓	-	-	-
ME_70	✓	-	-	-	-	-	-
ME_105	✓	-	-	-	-	-	-
ME_145	✓	-	-	-	-	✓	✓
ME_205	-	-	-	-	-	✓	✓
ME_265	-	-	-	✓	-	-	-

- Not possible

✓ Possible without increment

Δ Possible with increment motor length

Shaft

M_ motors are available with or without key option; shafts are available in different sizes suitable for your existing machine or gearbox

Increased Safety

M_ motors size 105 and 145 are also available with increased safety which conform to ATEX... directive 94/9/CE  II 2G Ex e II T3 with environment temperature between -20 and +40 °C

Only with drive HIDX. The feature and characteristics of the MBX motors are different from the standard version. For more info please consult technical department of Parker EME.

Custom options

Flange and shafts

In addition to the standard product it is possible to specify a fully customized mechanical interface for the motor ie flange, shaft and mounting holes. This option requires technical collaboration between the customer and Parker.

KIT (frameless) options

We can also supply our motors as only stator + rotor. Our mechanical team will develop / propose the right solution for your mechanical application which integrates into the existing elements of the machine.

A second output shaft / external encoder mount

Certain applications need a second shaft on the rear of motor; for this reason with M_ motors we offer alternative solutions for adding existing feedback or other mechanical accessories. For more details contact your Parker sales engineer.

Order Code

MH / MB Motors

To ensure that you select the correct motor we recommend that you have the following information.

- Diagram speed / time of load cycle to identify the type of the cycle (S1, S3 or others)
- Information about inertia load system
- Check the duty cycle - acceleration/deceleration
- Calculate the average torque and peak torque of the system
- Calculate the average speed and maximum speed of the cycle
- Check the temperature and altitude of environment / application
- Check the mechanical compatibility

With these preliminary data you can start to choose the motor (with the correct drive) for your application.

	1	2	3	4	5	6	7	8	9	10	11	12	13	14	15	16	17	18	
Order example	MH	x	A	V	205	11	28	5	9		2IB			64	A1				2

1 Type Of Motor (mandatory field)

MH	Motor with Resolver MH Series for PSD/C3
MB	Motor with Resolver MB Series for TPDM/SLVDN
ME	Motor with Encoder ME Series for TPDM/SLVDN

2 EX Protection

empty field	Standard motor no EX Certification
x	Motor with EX Certification (increased protection safety) (only for 105 and 145 without the holding brake at 3000 min ⁻¹) (only with HID, MB)

3 Brake Option

empty field	No Brake Option
A	Motor with Holding Brake (brakes when the supply voltage is 0)
B	Motor with Holding Brake (size145 up to 15Nm and 205)

4 Cooling Option

empty field	no cooling option
V	Motor with shaft-drive fan cooling
SV	Motor with (single-phase) motorised fan cooling
W	Water cooled motor (only size 145)

5 Motor Frame Size (mandatory field)

70	Torque range 0.5...2,5 Nm
105	Torque range 2.2...8 Nm
145	Torque range 4.5...28 Nm
205	Torque range 15...90 Nm
265	Torque range 75...265 Nm

6 Winding (mandatory field)

nn	min ⁻¹ (x100) except for size 205 1150 min ⁻¹ which is only 11
-----------	--

7 Motor Torque (mandatory field)

nn	Torque in Nm
-----------	--------------

8 Flange (mandatory field)

5	B5 Flange
6	116 mm Flange, only for frame 105
9	96 mm Flange, only for frame 105

9 Shaft (mandatory field)

11	11x23 mm for size 70
14	14x30 mm for size 70
19	19x40 mm for size 105/145
24	24x50 mm for size 105/145
28	28x60 mm for size 145
38	38x80 mm for size 205
42	42x110 mm for size 205
48	48x110 mm for size 265
A*	Special shaft under request

10 Key Shaft option

empty field	Shaft with key
S	Shaft without key

11 Layout - Connectors (mandatory field)

2I	Interconnectron rotatables receptacles (not for size 265 and 205 with brake)
3M	Terminal Box - opposite shaft glands
3MB	Terminal Box -toward shaft glands
2IB	90° Interconnectron receptacles - forward facing
2ID	90° Interconnectron receptacles - rear facing
3I	Terminal Box + Interconnectron 90° (not for size 265)
3MBS	Terminal Box + Interconnectron 90° (only for size 265)

12 Female connectors option

empty field	With Female / flying connectors
W	Without Female / flying connectors

13 Form Option

empty field	no Foot Mount Option
3	B3 - Foot Mount Option

14 Protection Degree (mandatory field)

64	IP64
65	IP65

15 Feedback	
empty field	Resolver (Standard) not for ME motors
A1	Tamagawa OIH48 2000 ppr / on request - No Stock
A2	Tamagawa OIH48 2048 ppr for size 105/145/205
A3	Tamagawa OIH48 4096 ppr for size 105/145/205
A6	Stegman SRS50 Hiperface Single-Turn for size 70/105/145/205
A7	Stegman SRM50 Hiperface Multi-Turn for size 70/105/145/205
B1	Encoder 3000 ppr + Hall - TAMAGAWA OIH35
B9	SinCos EnDat Encoder Multi-Turn - HEIDENHAIN EQI1331
C4	Encoder 5000 ppr + Hall - TAMAGAWA OIH48
D5	SinCos EnDat Encoder Multi-Turn - HEIDENHAIN EQN1325
S1	SinCos Hiperface Encoder Single-Turn - STEGMANN SRS50S
S2	SinCos Hiperface Encoder Multi-Turn - STEGMANN SRS50S
S5	Hiperface DSL® Encoder Feedback SIL2 262 144 ppr - Single Turn
S6	Hiperface DSL® Encoder Feedback SIL2 262 144 ppr - Multi Turn
L2	Hiperface DSL® Encoder Feedback 2 097 152 ppr x 4096 Multi Turn
L4	Hiperface DSL® Encoder Feedback SIL2 2 097 152 ppr x 4096 Multi Turn
16 Option Inertia	
empty field	Standard Inertia
M	Medium Inertia
ML	High Inertia
17 Special Option	
empty field	No Special Option
Exx	Prearrangement for external encoder mounting; where xx is the model of feedback
18 Voltage	
2	220-230 V
4	380-400 V

Order Code

Motor Power Cable for MH / MB Motors

	1	2	3	4		5		6		7		8
Order example	CBM	005	H	D	-	M15	-	PSX	-	0010	-	00

1	Power Cable Drive	
	CBM	Power cable drive
2	Section [mm²]	
	005	0.5 mm ²
	007	0.7 mm ²
	010	1 mm ²
	015	1.5 mm ²
	025	2.5 mm ²
3	Cable	
	S	Standard
	H	High Flex
4	Brake	
	0	Power cable standard - without brake
	B	Power cable standard - with brake
	D	DSL® Power cable with brake
5	Motor Connector	
	M15	M15 Interconnectron connector
	M23	M23 Interconnectron connector
	M40	M40 Interconnectron connector
6	Drive	
	PSX	Parker PSD1-S
	PMX	Parker PSD1-M
	SDX	Parker Servonet DC
7	Length	
	0000	Cable length 4 digits (example 50 m = 0500)*
8	Special Execution	
	00	Standard

* Available length in meter: 1; 2.5; 5; 7.5; 10; 15; 20; 25; 30; 35; 40; 45; 50

Motor Feedback Cable for MH / MB Motors

	1	2	3	4		5		6		7		8
Order example	CBF	RE0	H	0	-	M15	-	PSX	-	0010	-	00

1	Power Cable Drive	
	CBF	Feedback cable drive
2	Feedback	
	RE0	Resolver
3	Cable	
	H	High Flex
4	Brake	
	0	Power cable standard - without brake
5	Motor Connector	
	M15	M15 Interconnectron connector
	M23	M23 Interconnectron connector
	M40	M40 Interconnectron connector
6	Drive	
	PSX	Parker PSD1-S
	PMX	Parker PSD1-M
	SDX	Parker Servonet DC
7	Length	
	0000	Cable length 4 digits (example 50 m = 0500)*
8	Special Execution	
	00	Standard

* Available length in meter: 1; 2.5; 5; 7.5; 10; 15; 20; 25; 30; 35; 40; 45; 50



Parker's Motion & Control Technologies

At Parker, we're guided by a relentless drive to help our customers become more productive and achieve higher levels of profitability by engineering the best systems for their requirements. It means looking at customer applications from many angles to find new ways to create value. Whatever the motion and control technology need, Parker has the experience, breadth of product and global reach to consistently deliver. No company knows more about motion and control technology than Parker. For further info call 00800 27 27 5374



Aerospace Key Markets

Aftermarket services
Commercial transports
Engines
General & business aviation
Helicopters
Launch vehicles
Military aircraft
Missiles
Power generation
Regional transports
Unmanned aerial vehicles

Key Products

Control systems & actuation products
Engine systems & components
Fluid conveyance systems & components
Fluid metering, delivery & atomization devices
Fuel systems & components
Fuel tank inerting systems
Hydraulic systems & components
Thermal management
Wheels & brakes



Climate Control Key Markets

Agriculture
Air conditioning
Construction Machinery
Food & beverage
Industrial machinery
Life sciences
Oil & gas
Precision cooling
Process
Refrigeration
Transportation

Key Products

Accumulators
Advanced actuators
CO₂ controls
Electronic controllers
Filter driers
Hand shut-off valves
Heat exchangers
Hose & fittings
Pressure regulating valves
Refrigerant distributors
Safety relief valves
Smart pumps
Solenoid valves
Thermostatic expansion valves



Electromechanical Key Markets

Aerospace
Factory automation
Life science & medical
Machine tools
Packaging machinery
Paper machinery
Plastics machinery & converting
Primary metals
Semiconductor & electronics
Textile
Wire & cable

Key Products

AC/DC drives & systems
Electric actuators, gantry robots & slides
Electrohydraulic actuation systems
Electromechanical actuation systems
Human machine interface
Linear motors
Stepper motors, servo motors, drives & controls
Structural extrusions



Filtration Key Markets

Aerospace
Food & beverage
Industrial plant & equipment
Life sciences
Marine
Mobile equipment
Oil & gas
Power generation & renewable energy
Process
Transportation
Water Purification

Key Products

Analytical gas generators
Compressed air filters & dryers
Engine air, coolant, fuel & oil filtration systems
Fluid condition monitoring systems
Hydraulic & lubrication filters
Hydrogen, nitrogen & zero air generators
Instrumentation filters
Membrane & fiber filters
Microfiltration
Sterile air filtration
Water desalination & purification filters & systems



Fluid & Gas Handling

Key Markets

Aerial lift
Agriculture
Bulk chemical handling
Construction machinery
Food & beverage
Fuel & gas delivery
Industrial machinery
Life sciences
Marine
Mining
Mobile
Oil & gas
Renewable energy
Transportation

Key Products

Check valves
Connectors for low pressure fluid conveyance
Deep sea umbilicals
Diagnostic equipment
Hose couplings
Industrial hose
Mooring systems & power cables
PTFE hose & tubing
Quick couplings
Rubber & thermoplastic hose
Tube fittings & adapters
Tubing & plastic fittings



Hydraulics

Key Markets

Aerial lift
Agriculture
Alternative energy
Construction machinery
Forestry
Industrial machinery
Machine tools
Marine
Material handling
Mining
Oil & gas
Power generation
Refuse vehicles
Renewable energy
Truck hydraulics
Turf equipment

Key Products

Accumulators
Cartridge valves
Electrohydraulic actuators
Human machine interfaces
Hybrid drives
Hydraulic cylinders
Hydraulic motors & pumps
Hydraulic systems
Hydraulic valves & controls
Hydrostatic steering
Integrated hydraulic circuits
Power take-offs
Power units
Rotary actuators
Sensors



Pneumatics

Key Markets

Aerospace
Conveyor & material handling
Factory automation
Life science & medical
Machine tools
Packaging machinery
Transportation & automotive

Key Products

Air preparation
Brass fittings & valves
Manifolds
Pneumatic accessories
Pneumatic actuators & grippers
Pneumatic valves & controls
Quick disconnects
Rotary actuators
Rubber & thermoplastic hose & couplings
Structural extrusions
Thermoplastic tubing & fittings
Vacuum generators, cups & sensors



Process Control

Key Markets

Alternative fuels
Biopharmaceuticals
Chemical & refining
Food & beverage
Marine & shipbuilding
Medical & dental
Microelectronics
Nuclear Power
Offshore oil exploration
Oil & gas
Pharmaceuticals
Power generation
Pulp & paper
Steel
Water/wastewater

Key Products

Analytical Instruments
Analytical sample conditioning products & systems
Chemical injection fittings & valves
Fluoropolymer chemical delivery fittings, valves & pumps
High purity gas delivery fittings, valves, regulators & digital flow controllers
Industrial mass flow meters/ controllers
Permanent no-weld tube fittings
Precision industrial regulators & flow controllers
Process control double block & bleeds
Process control fittings, valves, regulators & manifold valves



Sealing & Shielding

Key Markets

Aerospace
Chemical processing
Consumer
Fluid power
General industrial
Information technology
Life sciences
Microelectronics
Military
Oil & gas
Power generation
Renewable energy
Telecommunications
Transportation

Key Products

Dynamic seals
Elastomeric o-rings
Electro-medical instrument design & assembly
EMI shielding
Extruded & precision-cut, fabricated elastomeric seals
High temperature metal seals
Homogeneous & inserted elastomeric shapes
Medical device fabrication & assembly
Metal & plastic retained composite seals
Shielded optical windows
Silicone tubing & extrusions
Thermal management
Vibration dampening

Parker Worldwide

Europe, Middle East, Africa

AE – United Arab Emirates, Dubai
Tel: +971 4 8127100
parker.me@parker.com

AT – Austria, St. Florian
Tel: +43 (0)7224 66201
parker.austria@parker.com

AZ – Azerbaijan, Baku
Tel: +994 50 2233 458
parker.azerbaijan@parker.com

BE/NL/LU – Benelux,
Hendrik Ido Ambacht
Tel: +31 (0)541 585 000
parker.nl@parker.com

BG – Bulgaria, Sofia
Tel: +359 2 980 1344
parker.bulgaria@parker.com

BY – Belarus, Minsk
Tel: +48 (0)22 573 24 00
parker.poland@parker.com

CH – Switzerland, Etoy
Tel: +41 (0)21 821 87 00
parker.switzerland@parker.com

CZ – Czech Republic, Klecany
Tel: +420 284 083 111
parker.czechrepublic@parker.com

DE – Germany, Kaarst
Tel: +49 (0)2131 4016 0
parker.germany@parker.com

DK – Denmark, Ballerup
Tel: +45 43 56 04 00
parker.denmark@parker.com

ES – Spain, Madrid
Tel: +34 902 330 011
parker.spain@parker.com

FI – Finland, Vantaa
Tel: +358 (0)20 753 2500
parker.finland@parker.com

FR – France, Contamine s/Arve
Tel: +33 (0)4 50 25 80 25
parker.france@parker.com

GR – Greece, Piraeus
Tel: +30 210 933 6450
parker.greece@parker.com

HU – Hungary, Budaörs
Tel: +36 23 885 470
parker.hungary@parker.com

IE – Ireland, Dublin
Tel: +353 (0)1 466 6370
parker.ireland@parker.com

IL – Israel
Tel: +39 02 45 19 21
parker.israel@parker.com

IT – Italy, Corsico (MI)
Tel: +39 02 45 19 21
parker.italy@parker.com

KZ – Kazakhstan, Almaty
Tel: +7 7273 561 000
parker.easteurope@parker.com

NO – Norway, Asker
Tel: +47 66 75 34 00
parker.norway@parker.com

PL – Poland, Warsaw
Tel: +48 (0)22 573 24 00
parker.poland@parker.com

PT – Portugal
Tel: +351 22 999 7360
parker.portugal@parker.com

RO – Romania, Bucharest
Tel: +40 21 252 1382
parker.romania@parker.com

RU – Russia, Moscow
Tel: +7 495 645-2156
parker.russia@parker.com

SE – Sweden, Borås
Tel: +46 (0)8 59 79 50 00
parker.sweden@parker.com

SK – Slovakia, Banská Bystrica
Tel: +421 484 162 252
parker.slovakia@parker.com

SL – Slovenia, Novo Mesto
Tel: +386 7 337 6650
parker.slovenia@parker.com

TR – Turkey, Istanbul
Tel: +90 216 4997081
parker.turkey@parker.com

UA – Ukraine, Kiev
Tel: +48 (0)22 573 24 00
parker.poland@parker.com

UK – United Kingdom, Warwick
Tel: +44 (0)1926 317 878
parker.uk@parker.com

ZA – South Africa, Kempton Park
Tel: +27 (0)11 961 0700
parker.southafrica@parker.com

North America

CA – Canada, Milton, Ontario
Tel: +1 905 693 3000

US – USA, Cleveland
Tel: +1 216 896 3000

Asia Pacific

AU – Australia, Castle Hill
Tel: +61 (0)2-9634 7777

CN – China, Shanghai
Tel: +86 21 2899 5000

HK – Hong Kong
Tel: +852 2428 8008

IN – India, Mumbai
Tel: +91 22 6513 7081-85

JP – Japan, Tokyo
Tel: +81 (0)3 6408 3901

KR – South Korea, Seoul
Tel: +82 2 559 0400

MY – Malaysia, Shah Alam
Tel: +60 3 7849 0800

NZ – New Zealand, Mt Wellington
Tel: +64 9 574 1744

SG – Singapore
Tel: +65 6887 6300

TH – Thailand, Bangkok
Tel: +662 186 7000

TW – Taiwan, Taipei
Tel: +886 2 2298 8987

South America

AR – Argentina, Buenos Aires
Tel: +54 3327 44 4129

BR – Brazil, Sao Jose dos Campos
Tel: +55 800 727 5374

CL – Chile, Santiago
Tel: +56 2 623 1216

MX – Mexico, Toluca
Tel: +52 72 2275 4200

EMEA Product Information Centre

Free phone: 00 800 27 27 5374

(from AT, BE, CH, CZ, DE, DK, EE, ES, FI, FR, IE, IL, IS, IT, LU, MT, NL, NO, PL, PT, RU, SE, SK, UK, ZA)

US Product Information Centre

Toll-free number: 1-800-27 27 537

www.parker.com

Your local authorized Parker distributor

