

USER MANUAL

SOLAR RADIATION AND TEMPERATURE METER

IRM-1





USER MANUAL

SOLAR RADIATION AND TEMPERATURE METER IRM-1



**SONEL S.A.
Wokulskiego 11
58-100 Świdnica
Poland**

Version 1.08.1 12.09.2023

IRM-1 is a modern, state-of-the art measuring instrument, easy to operate and safe. Read this manual to avoid mistakes during the measurements and prevent operational problems.

CONTENTS



1	General information	5
1.1	Safety symbols	5
1.2	Safety	5
1.3	General characteristics	6
1.4	Compliance with standards	6
2	Quick start	7
2.1	Turning the meter on and off, display content	7
2.2	Selection of general measurement parameters	7
2.2.1	Time and date	7
2.2.2	Units of solar irradiance and temperature	8
2.2.3	Zeroing the meter inclination angle in relation to the ground	9
2.2.4	Compass orientation	11
2.2.5	Compass calibration	11
2.3	Pairing with a master meter	13
3	Measurements	14
3.1	Live mode	14
3.2	HOLD mode	14
3.3	Inclination in relation to the ground	15
3.4	Geographical direction	15
4	Recorder	16
4.1	Setting the recording interval and memory mode	16
4.2	Recording	17
5	Memory of measurement results	18
5.1	Recording measurement results in the memory of the user	19
5.2	Viewing user memory data	20
5.3	Deleting memory data	21
5.3.1	Deleting user memory data	21
5.3.2	Deleting the recorder memory	22
6	Communication	23
7	Troubleshooting	23
8	Power supply	24
8.1	Monitoring the power supply voltage	24
8.2	Replacing the battery	24
8.3	Charging rechargeable battery	24
8.4	General rules for using Li-Ion rechargeable batteries	24
9	Cleaning and maintenance	25
10	Storage	25
11	Dismantling and disposal	25
12	Technical data	25
12.1	Basic information	25
12.1.1	Measurement of solar irradiance	25

12.1.2	Temperature measurement of the PV module and the environment.....	25
12.1.3	Measuring of the inclination angle.....	25
12.1.4	Measuring the geographical position of the location – compass.....	25
12.2	Other technical specifications	26
12.2.1	Maximum operating time on a single battery charge	26
13	Manufacturer	27

1 General information

1.1 Safety symbols

The following international symbols are used in the device and/or in this manual:

	WARNING See explanation in the manual		Do not dispose of with other household waste		Declaration of Conformity with EU directives (<i>Conformité Européenne</i>)
---	---	---	---	---	---

1.2 Safety

To avoid damage to the device and to ensure its safe operation, the user must observe the notes and warnings provided in these operating instructions.

- Before you proceed to operate the device, acquaint yourself thoroughly with this manual and observe the safety regulations and specifications defined by the producer
- Any application that differs from those specified in this manual may result in damage to the device and constitute a source of danger for the user.
- Using this manual does not exclude the need to comply with occupational health and safety regulations and with other relevant fire regulations required during the performance of a particular type of work. Before starting the work with the device in special environments, e.g. potentially fire-risk/explosive environment, it is necessary to consult it with the person responsible for health and safety.
- Do not make any electrical contact between the temperature probe sensors and exposed live parts.
- It is unacceptable to operate:
 - ⇒ it is damaged and completely or partially out of order,
 - ⇒ its cords and cables have damaged insulation,
 - ⇒ of the device and accessories mechanically damaged,
 - ⇒ it was stored for an excessive period of time in disadvantageous conditions (e.g. excessive humidity) After moving the device from a cool to a warm place with a high level of relative humidity, do not start measurements until the device is warmed up to the ambient temperature (approximately 30 minutes).
- Remember that  symbol appearing on the display indicates insufficient voltage of power supply and the need to recharge the battery. Measurements performed with the meter supplied with insufficient voltage are burdened with additional errors that are impossible to be estimated by the user. Such measurements must not be used to confirm correctness of the tested photovoltaic installation or network.
- Opening the socket plug of the temperature probe results in the loss of its declared tightness, leading to a possible damage in adverse weather conditions. It may also expose the user to the risk of electric shock.
- Repairs may be performed only by an authorised service point.
- The battery may be replaced only by an authorised service point.



NOTE!

- The temperature sensor cannot be installed on damaged surface of the PV module. Installation on a damaged surface may result in a short circuit to the metal part of the temperature sensor.
- Only accessories intended for a given device should be used. Using other accessories may cause damage to measuring terminals, introduce additional measurement errors and create a risk for the user.
- The included charger is not intended for outdoor use as **it is not protected against the ingress of moisture.**



Due to continuous development of the meter's software, the actual appearance of the display, in case of some of the functions, may slightly differ from the display presented in this operating manual.

1.3 General characteristics

IRM-1 meter is a device for measuring environmental conditions during measurements of photovoltaic systems. The very high tightness class of the device (IP65) ensures measurements in diverse weather conditions.

Measured parameters:

- solar irradiance on the surface i.e. the power per unit area received from the sun that reaches the earth's surface, measured in W^2 or BTU/ft^2h ,
- air temperature,
- temperature of the cell(s) in a photovoltaic module,
- inclination of the photovoltaic system in relation to the ground surface,
- the geographical direction in which the photovoltaic system is oriented.

The meter is equipped with two sockets:

- socket for connecting the temperature probe (without the probe, other functions in the device work properly),
- micro-USB socket (for charging the device and communicating with a PC in order to collect measurement results).

The meter has a built-in LoRa radio interface for communication with the master device.



IRM-1 is a meter designed for measuring solar irradiance and the temperature of photovoltaic cells and their environment. The data it provides is necessary to convert the measured values to the STC conditions. The standardized values enable the user to determine whether the photovoltaic system is working with optimal efficiency and to check the PV modules for potential damage.

1.4 Compliance with standards

IRM-1 meets the requirements of the following standards:

Safety standards:

- IEC 61010-1 – Safety requirements for electrical equipment for measurement, control, and laboratory use – Part 1: General requirements.

Standards for electromagnetic compatibility:

- IEC 61326-1 – Electrical equipment for measurement, control and laboratory use – EMC requirements – Part 1: General requirements.

2 Quick start

2.1 Turning the meter on and off, display content



The white marks on the buttons refer to the functions that can be activated in the meter. Orange markings refer to appropriate commands for changing device settings.

Briefly press  button to **turn on** the meter. Press it for a longer time to **turn it off** (**OFF** is displayed).

Briefly press  button during the meter operation to see the following indications: temperature, angle (compass), clock.



2.2 Selection of general measurement parameters



2.2.1 Time and date







①  Use  button to enter the screen with the time and date.

②  Keeping  button depressed, press .

③  The parameter to be changed flashes.

④  Use  button to switch between parameters.

 Use   buttons to change the setting.



- 5  /  +  Press  button to confirm the changes and go to the measurement function or exit the settings without confirming the changes by simultaneously pressing  and .



- If the IRM-1 communicates with the master meter, the master meter changes the IRM-1 clock settings to synchronize time in both devices.
- Do not change time in the IRM-1 when it is synchronized with the master meter. However, if you change the time, the data in both devices will be desynchronized, and then the time in the IRM-1 will be corrected by the master meter.





2.2.2 Units of solar irradiance and temperature.



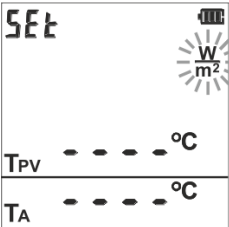

Irradiance measurements may be performed using two units (W/m^2 and BTU/ft^2h) and the results with selected unit may be saved in the memory. Measurements of ambient temperature and solar cell (module) temperature may be also carried out in two units ($^{\circ}C$ and $^{\circ}F$) and saved in the memory using these units.

- 1  Use  button to enter the screen with solar irradiance and temperature.

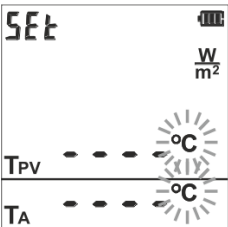
- 2  +  Keeping  button depressed, press .

- 3  The parameter to be changed flashes.

- 4  Use  button to switch between parameters.
- Use   buttons to change the setting.
- 

- 5  /  +  Press  button to confirm the changes and go to the measurement function or exit the settings without confirming the changes by simultaneously pressing  and .

2.2.3 Zeroing the meter inclination angle in relation to the ground

The default position of IRM-1 relative to the ground is parallel, i.e. its inclination angle in relation to the ground is 0° . The user can change this reference angle. This is useful when you need to specify the inclination angle in relation to any surface.

The type of the reference angle – default or user – is indicated by relevant icon on the display.



Default reference angle (0°)



User-set reference angle (e.g. 40°)





1





Use  button to enter the screen with solar irradiance and angle.

2a

In order to change the reference angle from the default, make sure you see the default angle icon  on the screen. It procedures are as follows:

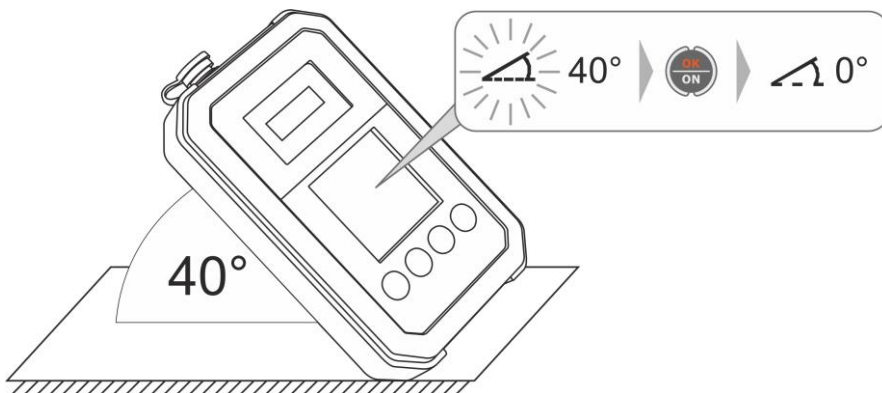
- keeping  button depressed, press ,
- set the meter to the new reference angle. Its value will be shown on the display,
- confirm by pressing . The angle symbol changes to . From now on, the meter will determine the inclination using the new reference angle.





2b) In order to change the reference angle to the default value (0°), make sure you see the angle icon  on the screen. Its procedures are as follows:

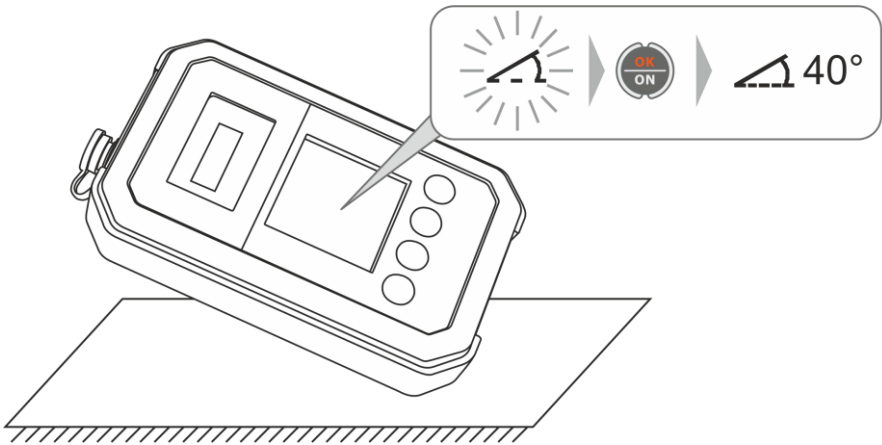

- keeping  button depressed, press ,
- the angle of the meter does not matter,
- press . The angle symbol changes to . From now on, the meter will determine the inclination using the default reference angle, i.e. 0° .



2.2.4 Compass orientation

①  Use  button to enter the screen with the meter inclination and its deviation angle from the north.

②  Keeping  button depressed, press .



③   Use  button to go to the compass orientation screen.

④  Adjust the compass orientation.



- **0** - the device indicates its deviation relative to north.
- **180** - the device indicates the deviation of the plane on which it is installed relative to north (default setting).







⑤  Approve the compass orientation.

2.2.5 Compass calibration

①  Use  button to enter the screen with the meter inclination and its deviation angle from the north.

②  Keeping  button depressed, press .

③   Use  button to go to the compass calibration screen.

4  /  +  Press  button to activate the calibration or exit the settings without confirming the changes by simultaneously pressing  and .

5 For 3 minutes, move the device in a way that will rotate it in as many directions as possible. The movement should be performed in each axis of the device.

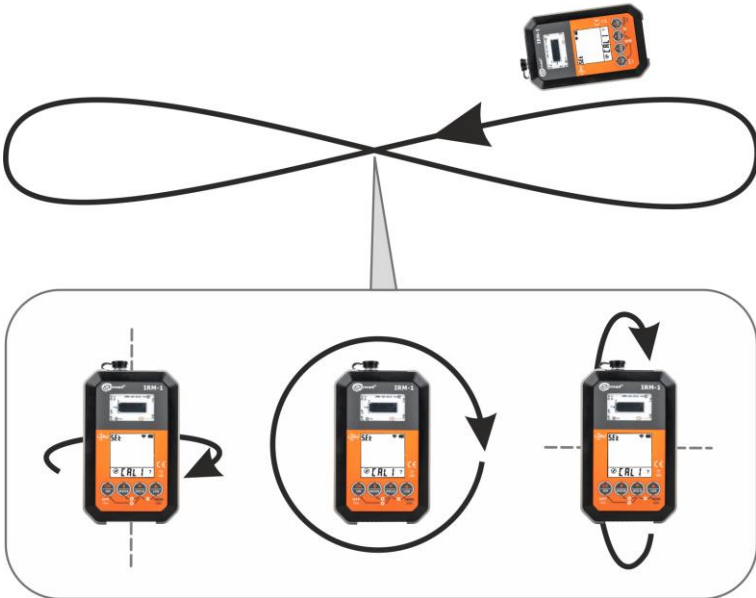

- The compass should be calibrated after noticing significant deviations of its indications from the real world directions. This can happen in environments, where magnetic materials are present (magnets, metals, etc.) or where there is a high magnetic field.
- During calibration, no peripheral devices may be connected to the IRM-1.
- If it is necessary to complete the calibration within 3 minutes, press  button.
- After leaving the "magnetic" environment, the compass must be recalibrated.
- When using the product, you may need to recalibrate the compass. It should be done in a free space, away from magnetic fields and materials.

2.3 Pairing with a master meter

1



Turn on the meter.

2



Keeping **HOLD** button depressed, press **OK**.

3



The device is in pairing mode.

4

Perform pairing on the master meter.

5



Pairing with the master meter is in progress.



Successful pairing is indicated by a message. Then, the device returns to displaying the measurement readings.





- The IRM-1 may be paired with up to 3 master meters. Each subsequent pairing will delete the oldest pairing with a master meter from the memory.
- Once paired with a master meter, the IRM-1 will remember it. When the device comes within the range of the paired master meter, which sends a connection request, the connection will be made automatically.

3 Measurements

3.1 Live mode

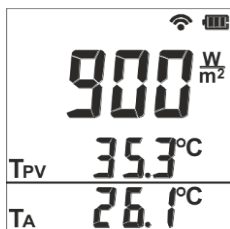
1





Use  button to switch between screens. The display is done in a loop.

Main reading – solar irradiance value
 T_{PV} – temperature of the tested object
 T_A – air temperature

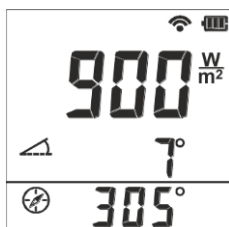
2



Main reading – solar irradiance value
 /  – inclination of the meter in relation to the reference angle. See **sec. 3.3**
 – angle of deviation from the north. See **sec. 3.4**

3



Main reading – hour
DDMM – current date (day – month – year)



The cell is protected by a special glass that transmits the spectrum of solar radiation in the measured range. In order to maintain the accuracy of the measurement, the protective glass should be kept clean.

3.2 HOLD mode

This function is used to 'freeze' the measurement result on the display. To do this, shortly press



button. When the function is enabled, the display shows symbol **H**.

To return to the normal operation mode of the device, press  button again.

3.3 Inclination in relation to the ground

The inclination value changes as shown in the figure below.

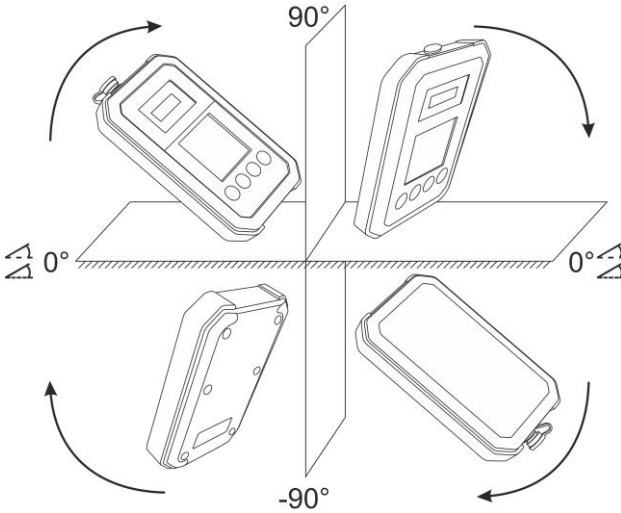

3.4 Geographical direction

The geographical direction is indicated as an angle in the range of $0^\circ \dots 359^\circ$. North (in the northern hemisphere) or south (in the southern hemisphere) is indicated when the angle is 0° . Angle rise – clockwise.

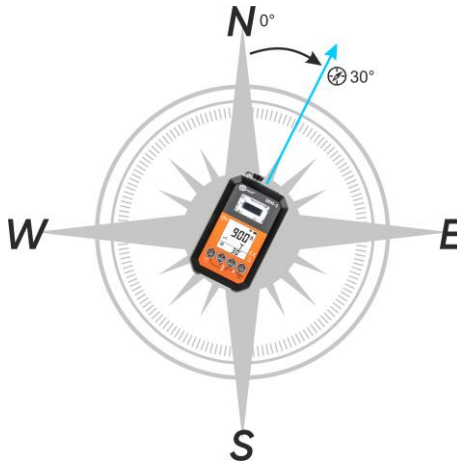

Depending on the compass orientation (**sec. 2.2.4**), indicated is the orientation of the instrument itself or the plane on which it is installed.

4 Recorder

The recorder allows you to save one or more records, i.e. sets of measurement records. The maximum cumulative number of records in the memory is 5000. The lowest number of records is 1 record, which means that you can record up to 5000 single records.



You can enable and disable recordings in the recorder. Each recording has its own unique tag. This allows unambiguous assignment of records to the recording data. This solution prevents confusing records from different recordings after transferring them to the computer

The recorder memory may work in one of two modes: linear or circular. In the linear **mode**, the memory is full until the last cell is used, then recording is stopped. In the **circular** mode, recording continues until the battery is discharged or until the device is turned off by the user. The results are saved in a loop, i.e. after the memory is full, the oldest records are overwritten with the newest ones. The last 5000 records are stored. Recording is made at the preset interval.



4.1 Setting the recording interval and memory mode

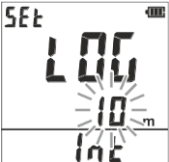

①  Press  button to turn on the recorder.

②  Keeping  button depressed, press .

③  Changing the recording interval. Use   buttons to change the setting (1... 59 s, then 1... 30 min).

④  Changing the memory mode.

 – line mode
 – circular mode

Use   buttons to change the setting.

⑤  Press  button to confirm the changes and go to the measurement function or exit the settings without confirming the changes by simultaneously pressing  and .

4.2 Recording

1



Press  button to turn on the recorder. The screen displays the following:

- interval (here: 10 m[inutes]),
- number of saved records (here: 1 record),
- number of free memory cells (4900) saved in the line mode ().

2



Press  to activate recording.

3



You will hear a short beep. The LOG will start flashing, the recording number will increase by 1. Short presses on the buttons will not cause any reaction. The screen will go blank after 10 seconds.

4 The **LOG** message will be displayed for 0.5 s every 10 seconds.

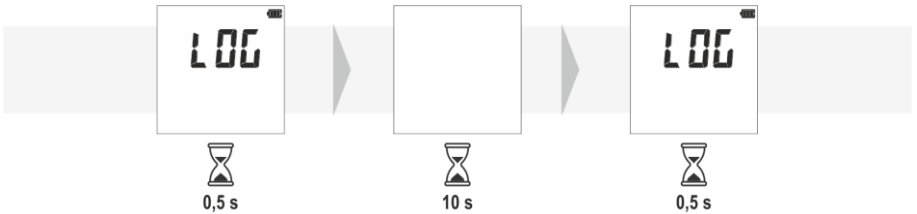

5

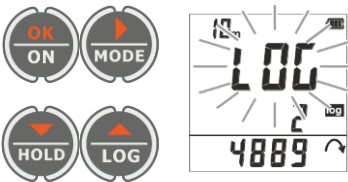

To temporarily activate the main screen of the recorder, briefly press any button.

6

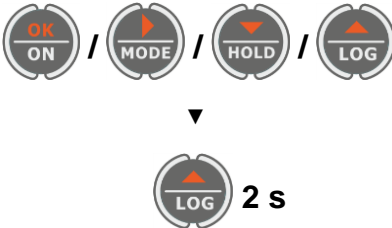

To disable recording:

- briefly press any button to activate the main screen of the recorder,
- press and hold . You will hear 3 beeps.



7



The recorder is ready for the next recording.

8



To exit the recorder mode, press briefly ,  or  when no recording is taking place,



If the memory of the meter is full, the attempt to start recording will end with **FULL** message, and the recording will not start.



In this case, you should do one of two things:

- switch the memory mode from linear to circular,
- clear the memory as described in **sec. 5.3.2**.

5 Memory of measurement results

The meter is equipped with three independent memories:

- user measurement memory – 999 records,
- recorder memory – 5000 records,
- temporary memory – 1200 records.

The memory with the measurement results **is not erased** after the meter is turned off. Results from the user memory and recorder can be transferred to a computer via USB.

Each record has a time stamp and all the values measured during the recording i.e. solar irradiance, air temperature T_a , temperature of the photovoltaic cell T_{PV} , angle of inclination to the reference surface, geographical direction. The measurement results are stored with the measurement unit set at the recording time, i.e. if the solar irradiance was measured in W/m^2 , then the result value will be saved in W/m^2 . The information about the set measuring unit is included in the record.

User measurement memory can be viewed directly on the IRM-1. You can save it, view it, delete it.

The recorder memory cannot be viewed in the IRM-1 device. It can only be deleted.

The temporary memory is not available to the user. It activates when the IRM-1 is communicating with the master meter and the connection is lost. Then, the internal recording of measurements is activated with an interval of 1 second. The results are saved in a loop, i.e. after the memory is full, the oldest records are overwritten with the newest ones. Due to the size of the memory, the records of the last 20 minutes of are saved in this mode.

After restoring the connection with the master meter, the IRM-1 shares the temporary memory with the master meter to supplement the missing data on environmental parameters.

5.1 Recording measurement results in the memory of the user

1 The device is in the solar irradiance measurement mode.

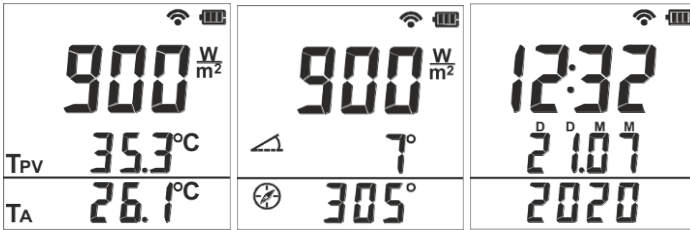



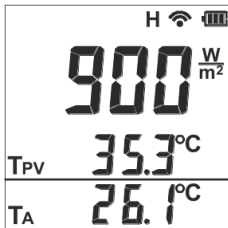

2 Press . H symbol is displayed on the screen.

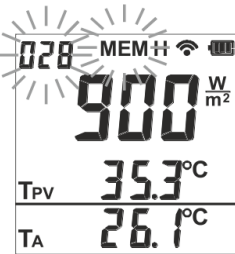

3 Press . The device shows the screen with saving the result to the user memory. The cell number under which the result will be saved is blinking.



 – saving the result to the user's memory
 /  /  – return to the measurement screen without saving the result



If the memory is full, the meter will ask for erasing it before saving. This request must be accepted or rejected.

- If it is rejected, press  ,  or .
- If it is accepted, proceed as described below. After erasing the memory, the result is saved in the cell number 1.



5.2 Viewing user memory data

- 1 The device is in the solar irradiance measurement mode.

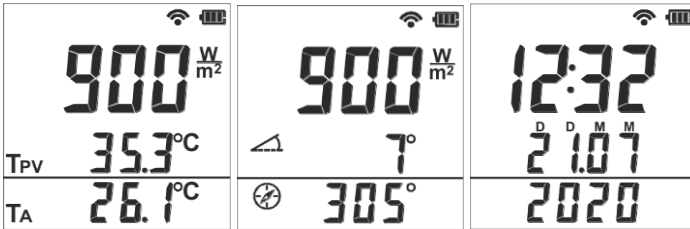

- 2 Press and hold . The meter will enter the user memory browsing mode.

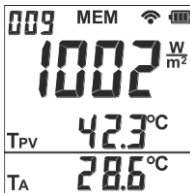

The number of the last saved cell is shown in the upper left corner. Below – solar irradiance, temperature of the tested object T_{PV} and ambient temperature T_A .

Use  button to display the values saved within a single record.

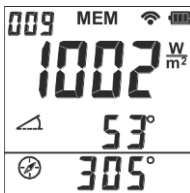

Solar irradiance, inclination angle of the meter, deviation from the north.



Time, date.

- 3 Use   buttons to change the cell number.

- 4 To exit the memory viewing mode, press .

5.3 Deleting memory data

5.3.1 Deleting user memory data

- 1 The device is in the solar irradiance measurement mode.

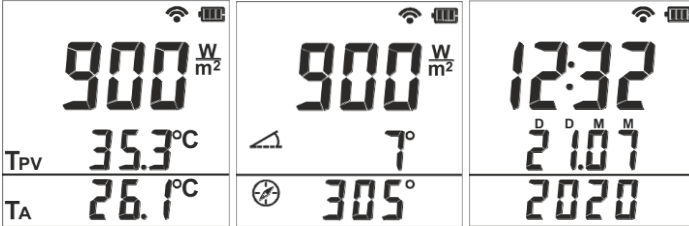

- 2 Press and hold . The meter will enter the user memory browsing mode.

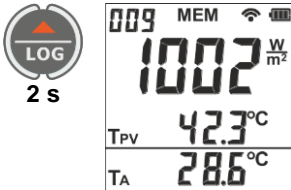



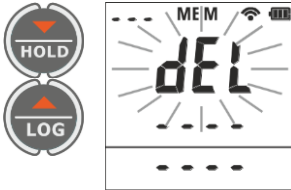

- 3 Use buttons   to set the cell ID using as --- (in front of 1). The deletion message appears.



- 4 Press . Prompt to acknowledge deletion is displayed



- Press  to clear the memory.

- To exit the mode without deleting the memory, press ,  or .

- 5 Screen after deleting all memory. Cell No. 1 is ready for saving. To go to the measurement screen, press .

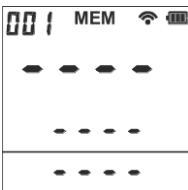

-  or .

5.3.2 Deleting the recorder memory.

- 1 The device is in the solar irradiance measurement mode.

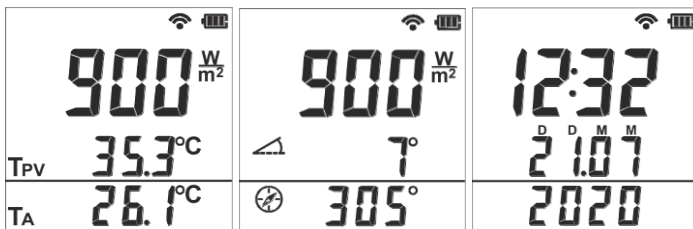

- 2 Press . The meter will enter the recorder mode.



- 3 Press and hold . The deletion message appears.



- 4 Press . Prompt to acknowledge deletion is displayed



- Press to clear the memory.
- To exit the mode without deleting the memory, press , or . A countdown of 0-200-400-... -5000 will start to reflect the deletion progress.

- 5 Screen after deleting all memory (0 records) To go to the measurement screen, press , or .



6 Communication

IRM-1 is equipped with two communication channels: wired USB and wireless LoRa®.

Wired communication via USB is used to transfer the results from the recorder's memory and from the user's memory to the computer. After connecting IRM-1 to a computer, it will be detected. Then, using the Sonel Reader software, the user will be able to download measurement records. Data transfer is indicated by the blinking **MEM** icon.

Wireless communication in the LoRa® standard is used to send measurement results to the master meter. Any loss of communication does not result in data loss. The readings are then recorded in the temporary memory and transmitted to the master meter after the communication is restored in accordance with **sec. 5**.

7 Troubleshooting

Before sending the instrument for repairs, call our service. Perhaps the meter is not damaged, and the problem has been caused by some other reasons.

The meter can be repaired only at outlets authorized by the manufacturer.

Troubleshooting of typical problems during the use of the meter is described in the table below.

Symptom	Cause	Action
The meter does not start after pressing button Ⓚ .	Battery discharged.	Charge the battery. If this does not help, sent the meter for servicing.
Measurement errors after moving the meter from cold environment to a warm and humid place.	No acclimatization.	Do not perform the measurements until the meter reaches the ambient temperature (about 30 minutes) and dries.

8 Power supply

8.1 Monitoring the power supply voltage

The batteries charging level is indicated by the symbol located in the top right-hand corner of the screen:



Battery charged.



Battery discharged.



Measurements performed with an insufficient supply voltage will be at risk of additional errors which the user is unable to evaluate.

8.2 Replacing the battery

The meter is powered by an internal battery. The battery may be replaced only by an authorised service point.

8.3 Charging rechargeable battery

Charge the battery using the provided charger or via the USB interface of a computer.

8.4 General rules for using Li-Ion rechargeable batteries

- Store the half-charged battery pack in a plastic container placed in a dry, cool and well ventilated place and protect them from direct sunlight. The battery pack may be damaged if stored when fully discharged. The ambient temperature for prolonged storage should be maintained within the range of 5°C...25°C.
- Charge the batteries in a cool, well-ventilated place at a temperature of 10°C ... 28°C. Modern fast chargers detect both too low and too high temperature of rechargeable batteries and react to the situation adequately. Too low temperature should prevent starting the process of charging, which might irreparably damage rechargeable batteries. The increase in temperature of the battery pack may cause electrolyte leakage and even its ignition or explosion.
- Do not exceed the charging current, as it may result in ignition or "swelling" of the battery pack. "Swollen" battery pack must not be used.
- Do not charge or use the batteries in extreme temperatures. Extreme temperatures reduce the lifetime of rechargeable batteries. Always observe the rated operating temperature. Do not dispose the battery pack into fire.
- Li-Ion cells are sensitive to mechanical damage. This kind of damage may cause its permanent damage and thus – ignition or explosion. Any interference in the structure of Li-ion battery pack may cause its damage. This may result in the ignition or explosion. A short-circuit of the battery poles "+" and "-" may permanently damage the battery pack or even cause its fire or explosion.
- Do not immerse Li-Ion battery in liquids and do not store in humid conditions.
- If the electrolyte contained in the Lithium-Ion battery pack, contacts eyes or skin, immediately rinse the affected place with plenty of water and consult a doctor. Protect the battery against unauthorised persons and children.
- When you notice any changes in the Lithium-Ion battery pack (e.g. changes in colour, swelling, excessive temperature), stop using the battery pack. Li-Ion batteries that are mechanically damaged, overcharged or excessively discharged are not suitable for use.
- Any misuse of the battery may cause its permanent damage. This may result in the ignition. The seller and the manufacturer shall not be liable for any damages resulting from improper handling Li-Ion battery pack.

9 Cleaning and maintenance



NOTE!

Use only the maintenance methods presented by the manufacturer in this manual.

Clean the meter casing with a wet cloth, using generally available detergents. Do not use any solvents and cleaning media which could scratch the casing (powder, paste, etc.).

The probes can be cleaned with water and then wiped dry. Before longer storage, it is recommended to lubricate the probes with any machine grease.

Clean the leads with water and detergents, then wipe dry.

The meter electronic system is maintenance free.

10 Storage

When storing the instrument, observe the following recommendations:

- disconnect all leads from the meter,
- thoroughly clean the meter and all accessories,
- In order to prevent a damage of the battery pack due to its total discharge in the case of a prolonged storage, charge it at least once every 3 months.

11 Dismantling and disposal

Used electric and electronic equipment should be collected selectively, i.e. not placed with other types of waste.

Used electronic equipment shall be sent to the collection point according to the Used Electric and Electronic Equipment Act.

Before sending the instrument to the collection point, do not dismantle any parts by yourself.

Observe local regulations on disposal of packagings and used batteries.

12 Technical data

12.1 Basic information

⇒ The abbreviation "m.v." used in the specification of accuracy denotes a measured value

12.1.1 Measurement of solar irradiance

Measurement range: 100 W/m²...1400 W/m², 32 BTU/ft²h...444 BTU/ft²h

Display range	Resolution	Accuracy
0...1400 W/m ²	1 W/m ²	±(5% m.v. + 2 digits)
0...444 BTU/ft ² h	1 BTU/ft ² h	

12.1.2 Temperature measurement of the PV module and the environment

Display range	Resolution	Accuracy
-20.0...100.0°C	0.1°C	±(1% m.v. + 5 digits)
-4.0...212.0°F	0.1°F	

12.1.3 Measuring of the inclination angle

Display range	Resolution	Accuracy
-90...+90°	1°	±4°

12.1.4 Measuring the geographical position of the location – compass

Display range	Resolution	Accuracy
0...360°	1°	±7°

12.2 Other technical specifications

- a) degree of housing protection acc. to IEC 60529 IP65
- b) power supply Li-Ion rechargeable battery 3.7 V 1.3 Ah
- c) indication for range exceeding
 - irradiance exceeded reading >1400
 - minimum temperature not reached UL symbol
 - maximum temperature exceeded OL symbol
- d) dimensions 134 x 79 x 28 mm
- e) weight approx. 0.2 kg
- f) storage temperature -20...+60°C
- g) operating temperature -10...+50°C
- h) humidity 20...80%
- i) reference temperature +23 ± 2°C
- j) reference humidity 40...60%
- k) altitude (above sea level): <2000 m
- l) time to Auto-OFF 15 min
- m) type of supported temperature probe
 - meters with serial number up to L20399 analogue
 - meters with serial number starting from L20400 digital
- n) display segmented LCD
- o) memory of measurement results
 - cache memory 1000 cells
 - recorder 5000 records
- p) communication with the master meter
 - interface LoRa®
 - range up to 300 m
- q) quality standard
.... design, construction and manufacturing are ISO 9001, ISO 14001, ISO 45001, IEC 61010-1 compliant
- r) the product meets EMC requirements (immunity for industrial environment) acc. to the following standards....
..... IEC 61326-1



SONEL S.A. hereby declares that the radio device type IRM-1 complies with Directive 2014/53/EU. The full text of the EU Declaration of Conformity is available at the following website address: <https://sonel.pl/en/download/declaration-of-conformity/>

12.2.1 Maximum operating time on a single battery charge

Operating time: up to 18 h

Conditions

- Active communication with master meter via LoRa® interface
- Temperature -10...50°C

13 Manufacturer

The manufacturer of the equipment and provider of service during and past the warranty period:

SONEL S.A.

Wokulskiego 11

58-100 Świdnica

Poland

tel. +48 74 884 10 53 (Customer Service)

e-mail: customerservice@sonel.com

web page: www.sonel.com



NOTE!

Service repairs must be performed solely by the manufacturer.

NOTES



SONEL S.A.

Wokulskiego 11
58-100 Świdnica
Poland

Customer Service

tel. +48 74 884 10 53
e-mail: customerservice@sonel.com

www.sonel.com