

# **USER MANUAL**

## **EARTH RESISTANCE METER**

**MRU-10**

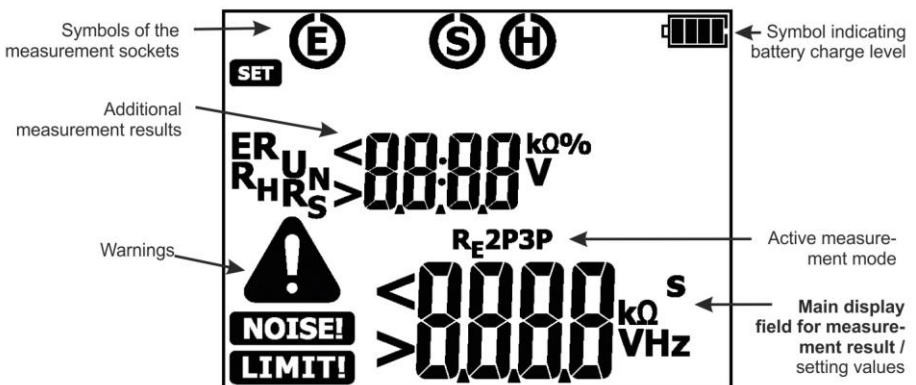



## **USER MANUAL**

# **EARTH RESISTANCE METER MRU-10**



**SONEL S.A.  
Wokulskiego 11  
58-100 Świdnica  
Poland**





The MRU-10 meter is a modern, easy and safe measuring device. Please acquaint yourself with this manual in order to avoid measuring errors and prevent possible problems in operation of the meter.

# CONTENTS

<b>1. Safety</b> .....	<b>4</b>
<b>2. Turning the meter ON and activating screen backlight</b> .....	<b>5</b>
<b>3. Meter Configuration</b> .....	<b>6</b>
<b>4. Measurements</b> .....	<b>9</b>
4.1 Measurement of interference voltages DC + AC.....	9
4.2 Measurement of earth resistances with 3-pole method ( $R_{E3P}$ ).....	10
4.3 Measurement of earth resistances using 2-pole method ( $R_{E2P}$ ) .....	14
<b>5. Power supply</b> .....	<b>16</b>
5.1 Monitoring the power supply voltage.....	16
5.2 Replacing (rechargeable) batteries .....	17
5.3 General principles regarding using Ni-MH rechargeable batteries .....	18
<b>6. Cleaning and maintenance</b> .....	<b>19</b>
<b>7. Storage</b> .....	<b>19</b>
<b>8. Dismantling and Disposal</b> .....	<b>19</b>
<b>9. Technical data</b> .....	<b>20</b>
9.1 Basic data .....	20
9.2 Other technical data .....	21
9.3 Additional data .....	21
9.3.1 Influence of serial interference voltage on the resistance measurements for function $R_{E3P}$ ..	21
9.3.2 Influence of the auxiliary electrodes on earth resistance measurements for function $R_{E3P}$ ..	22
9.3.3 Additional uncertainties according to IEC 61557-5 ( $R_{E3P}$ ) .....	22
<b>10. Manufacturer</b> .....	<b>22</b>

# 1. Safety

The following international symbols are used in the Analyzer and in this manual:

	Warning; See explanation in the manual		Dual insulation (Protection class II)
	Do not dispose of with other household waste		Declaration of Conformity with EU directives (Conformité Européenne)

MRU-10 meter is designed for measuring parameters important for safety of electrical installations. Therefore, in order to provide conditions for correct operation and accuracy of obtained results, the following recommendations must be observed:

- Before you proceed to operate the meter, acquaint yourself thoroughly with the present manual and observe the safety regulations and specifications provided by the producer.
- MRU-10 meter is designed to measure earth resistance values. Any application that differs from those specified in the present manual may result in a damage to the device and constitute a source of danger for the user.
- The meter must be operated solely by appropriately qualified personnel members holding required certificates for carrying measurements in electric installations. Unauthorized use of the meter may result in its damage and may be a source of serious hazard to the user.
- Using this manual does not exclude the need to comply with occupational health and safety regulations and with other relevant fire regulations required during the performance of a particular type of work. Before starting the work with the device in special environments, e.g. potentially fire-risk/explosive environment, it is necessary to consult it with the person responsible for health and safety.
- It is unacceptable to operate the device when:
  - ⇒ a damaged meter which is completely or partially out of order,
  - ⇒ a meter with damaged insulation,
  - ⇒ a meter stored for an excessive period of time in disadvantageous conditions (e.g. excessive humidity). **If the meter has been transferred from a cool to a warm environment with a high level of relative humidity, do not start measurements until the meter is warmed up to the ambient temperature (approximately 30 minutes).**
- Before measurement make sure that test leads are connected to appropriate measuring terminals.
- Do not power the meter from sources other than those listed in this manual.
- The inputs of the meter are protected electronically against overload e.g. due to having been connected to a live circuit, for all combinations of inputs - up to 276 V for 30 seconds.
- Factory calibration does not include the resistance of the test leads. The result displayed by the meter is a sum of the resistance of the measured object and the resistance of leads.
- The device meets the requirements of standards EN 61010-1 and EN 61557-1, -5.

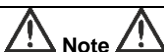

**Due to continuous product development, the manufacturer reserves the right to introduce changes to the functionality, appearance, accessories and technical data of the meter. Due to continuous development of the meter's software, the actual appearance of the display, in case of some of the functions, may slightly differ from the display presented in this operating manual.**

## 2. Turning the meter ON and activating screen backlight

①



To **turn ON** the meter, press **ON/OFF** button.

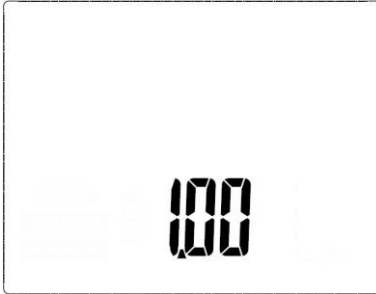

The screen of the device will activate its all segments (self-test), and then it will briefly show the software version.

②



When the meter is ON, a short press on **ON/OFF** button will turn ON and then OFF the screen backlight;

③



To **turn OFF** the device, press and hold **ON/OFF** button for approx. 2 seconds.

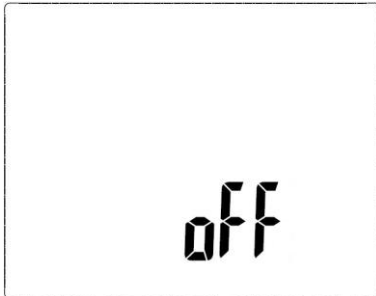

A screen indicating shutting off the device is shown briefly.

### 3. Meter Configuration

①



Turn on the meter by pressing and holding **DOWN** button.

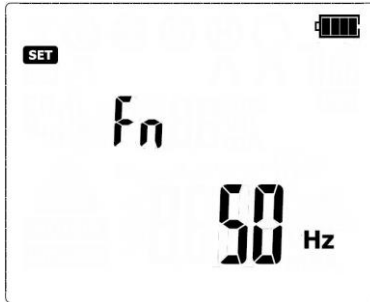

After switching the meter ON, a screen is shown with network frequency settings **Fn**.

②



When the **Fn** screen is displayed, use **UP** and **DOWN** buttons to set the network frequency of 50 Hz or 60 Hz (default: 50 Hz default).

③



Short press **START** button to accept the selected value.



You will enter the screen with settings of audio messages - **bEEP**.

④



Use **UP** and **DOWN** buttons to turn the audio messages ON (**on**) or OFF (**off**).



5



Short press **START** button to accept the selected option.

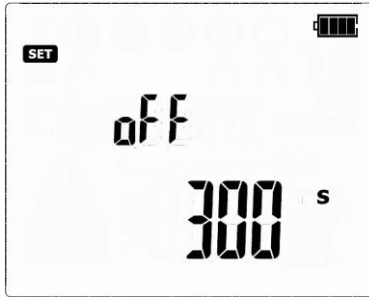

The screen of Auto-OFF time settings will be shown: **off**.

6



Use **UP** and **DOWN** buttons to set the auto-off time at 300 s, 600 s, 900 s or "- - -" (Auto-OFF inactive). Auto-OFF function is used to turn-off inactive meter after a pre-selected time, which is signalled by a beep.

7



Short press **START** button to accept the selected option.

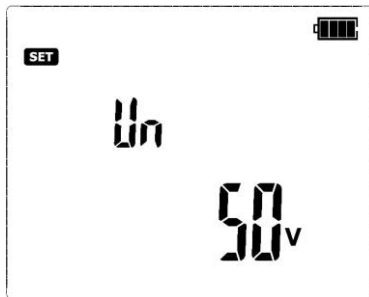

You will enter the screen with measuring voltage selection **Un**.

8



Use **UP** and **DOWN** buttons to set the measuring voltage at 25 V or 50 V. The measuring voltage set relates to all measurement functions in the meter.

9



Short press **START** button to accept the selected option and return to the network frequency selection screen **Fn**.

10



Long press (> 2 s) **START** button to the introduced changes and proceed to the measurement screen **R<sub>E</sub>3P**.

11



Long press (> 2 s) **ON/OFF** button to turn off the meter without accepting the changes introduced at the current setting position.

12



Short press (> 2 s) **ON/OFF** button to enter the measurement screen **R<sub>E</sub>3P** without accepting the changes introduced at the current setting position.

## 4. Measurements



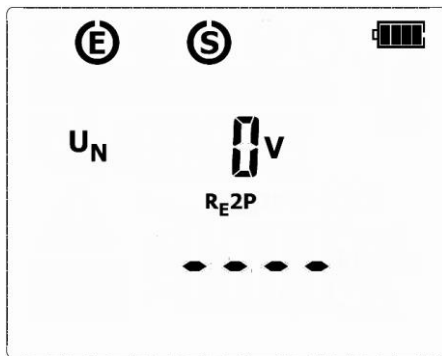

 Earth resistance measurements significantly different from other measurements performed to assess the protection against electric shock. They require a thorough knowledge of the structure of the earthing system, the phenomena occurring during the measurements and the skills of coping with adverse outdoor conditions. Earthing system tests/ measurements require adequate knowledge and measuring equipment, which will be able to maximally facilitate these examinations.

### 4.1 Measurement of interference voltages DC + AC



In measuring functions, before **START** button is pressed, the meter monitors the measuring voltage at the terminals (between **E** socket and **S** / **H** sockets) and the interference voltage value is displayed on the screen.

### Additional information displayed by the meter

<p><math>U_N &gt; 100V!</math>, <math>&gt; 100V</math> and a continuous beep ,</p> <p>"NOISE!" and </p>	<p>Voltage at test terminals is higher than 100 V, the measurement is blocked.</p>
<p><math>U_N xxV!</math>, <math>&gt; 40V</math> and a continuous beep ,</p> <p>"NOISE!" and </p>	<p>Where xx is the value of interference voltage. Voltage at test terminals is higher than 40 V but lower than 100 V, the measurement is blocked.</p>
<p><math>U_N xxV!</math>, <math>&gt; 24V</math>,</p> <p>"NOISE!" and </p>	<p>Where xx is the value of interference voltage. Voltage at test terminals is higher than 24 V but lower than 40 V, the measurement is blocked.</p>
<p>"NOISE!"</p>	<p>The interference voltage is lower than 24 V, but with a high value - the measurement result may be affected by additional uncertainty.</p>

## 4.2 Measurement of earth resistances with 3-pole method ( $R_{E3P}$ )

For earth resistance measurements, the most commonly used method is the 3-pole method, often called the potential drop method, or technical method. During the measurement, the voltage drop at the earthing is is measured with current flowing through it, then the Ohm's law is used to calculate the resistance.

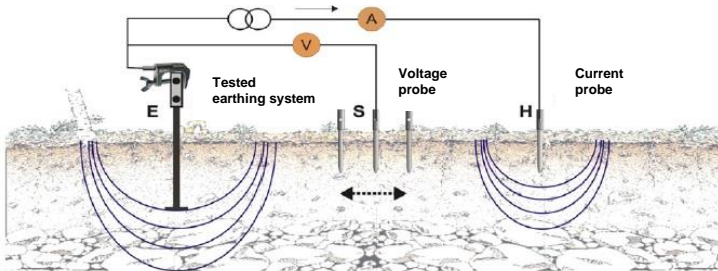

The scheme of measuring the earthing resistance with the 3-pole method is shown above. The figure shows the measurement of earthing resistance  $R_E$ . To perform the measurement, use two auxiliary electrodes:

- **H** electrode (current electrode) to allow excitation of current flow in the circuit: tested earth electrode  $R_E \rightarrow$  meter  $\rightarrow$  H current electrode  $\rightarrow$  earth  $\rightarrow$  tested earth electrode;
- **S** electrode (voltage electrode) for measuring the voltage drop across the resistance of the measured earthing as a result of current flow.

1

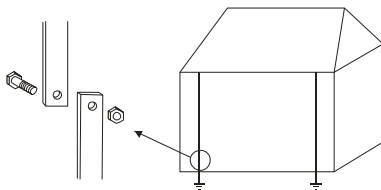

Disconnect the tested earth electrode from the installation of the facility.

2



Turn on the meter using **ON/OFF** button.

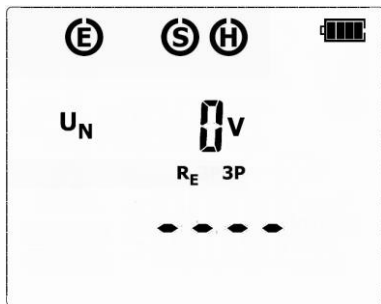

The meter enters the measurement function screen  **$R_{E3P}$** . The meter is in the mode of measuring the interference voltage between the test terminals. The measuring voltage is compatible with the voltage selected when setting up the device.

3

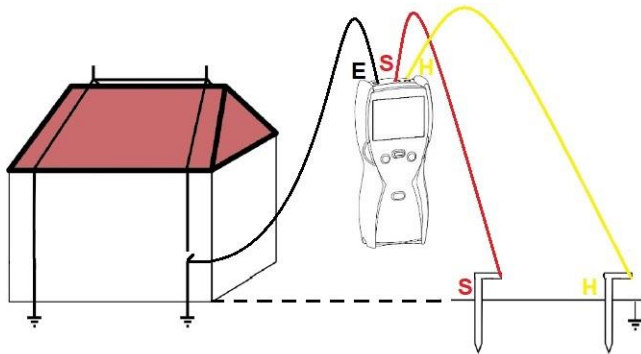

Test leads should be connected to the measurement terminals in the device, as shown above.

The current electrode **H** (driven into earth) should be connected to **H** socket of the meter.

The voltage electrode **S** (driven into earth) should be connected to **S** socket of the meter.

The earth electrode being tested should be connected to **E** socket of the meter with the lead.

The earth electrode being tested and the current electrode and the voltage electrode should be located in one line.

4



Press **START**.

The progress of the measurement is indicated by horizontal lines on the screen.

5

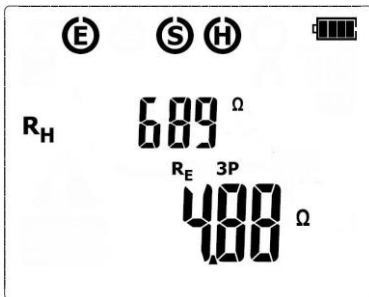

After completing the measurement, results are displayed for all the measurements carried-out: at the bottom of the screen, the main result is shown for **R<sub>E</sub>**, whereas the upper part of the screen shows additional results for **R<sub>H</sub>**. **The result is displayed for 20 seconds.**

The result can be recalled by pressing **UP** button.

6

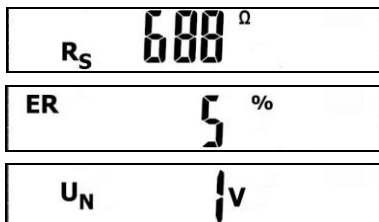

Use **UP** button to view the component results in the following order:

**R<sub>H</sub>→R<sub>S</sub>→ER→U<sub>N</sub>**, where:

**R<sub>H</sub>** – resistance of electrode **H**

**R<sub>S</sub>** – resistance of electrode **S**

**ER** – additional uncertainty

resulting from the probes

**U<sub>N</sub>** - interference voltage

7

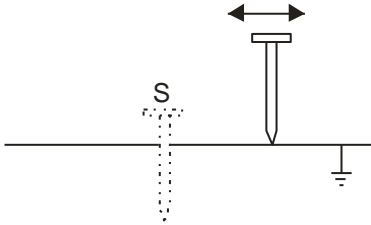

Repeat the measurements (steps 4, 5, 6) moving the voltage electrode a few meters - placing it farther and closer to the measured earth electrode.

If  $R_E$  measurement results differ from one another by more than 3%, the distance of the current electrode from the earth electrode being tested should be considerably increased and the measurements should be repeated.

## Note:











**Measurement of resistance-to-earth may be carried out if voltage of interferences does not exceed 24 V. Voltage of interferences is measured up to the level of 100 V, but above 40 V it is signalled as dangerous. The meter must not be connected to voltages exceeding 100 V.**

- Particular attention should be paid to quality of connection between the object being tested and the test lead – the contact area must be free from paint, rust, etc.

If resistance of electrodes is too high,  $R_E$  earth electrode measurement will include an additional uncertainty. Particularly high uncertainty of measurement occurs when a small value of resistance-to-earth is measured with electrodes that have a weak contact with earth (such a situation occurs frequently when the earth electrode is well made and the upper soil layer is dry and slightly conductive). In such a case, the ratio of resistance of the electrodes to resistance of the tested earth electrode is very high and consequently, uncertainty of measurement that depends on this ratio is also very high. Then, you can make a calculations according to the formulas given in sec. 9.2 to estimate the influence of measurement conditions. You can improve the contact between the electrode and soil, for example, by dampening with water the place where the electrode is driven into earth, driving the electrode into earth in a different place or using a 80 cm-long electrode. Check also the test leads for possible insulation damage and for corroded or loosened connection between the banana plug and the test lead. In majority of cases the achieved measurement accuracy is satisfactory. However, you should always be aware of the uncertainty included in the measurement.

## Additional information displayed by the meter

<b><math>R_E &gt; 9999 \Omega</math></b>	Measuring range is exceeded.
<b><math>U_N &gt; 100 \text{ V}</math>, <math>&gt; 100 \text{ V}</math></b> and a continuous beep  , <b>"NOISE!"</b> and 	Voltage at test terminals is higher than 100 V, measurement is blocked.
<b><math>U_N \text{ xxV}</math>, <math>&gt; 40 \text{ V}</math></b> and a continuous beep  , <b>"NOISE!"</b> and 	Where xx is the value of interference voltage. Voltage at test terminals is higher than 40 V, measurement is blocked.
<b><math>U_N \text{ xxV}</math>, <math>&gt; 24 \text{ V}</math>,</b> <b>"NOISE!"</b> and 	Where xx is the value of interference voltage. Voltage at test terminals is higher than 24 V but lower than 40 V, the measurement is blocked.
<b>"NOISE!"</b>	The interfering signal (noise signal) is too high - the measurement result may be affected by additional uncertainty.
<b>LIMIT!</b> and <b>ER</b> together with the value expressed in %	Measurement due to the resistance of the auxiliary probes > 30%. (Measured values are used in calculation of uncertainty.)
<b>LIMIT!</b> and <b><math>R_H</math></b> or <b><math>R_S</math></b> with the value of $\Omega$	Resistance of auxiliary electrodes H and S, or one of them exceeds 19.9 k $\Omega$ , correct measurement is not possible.
Flashing edges  ,  , 	Flashing edges of symbols: E or H or S, two or all three at the same time: disconnected one, two or three leads to the terminals, or the resistance of the auxiliary electrode/s is outside the measuring range.

### 4.3 Measurement of earth resistances using 2-pole method ( $R_{E2P}$ )

  $R_{E2P}$  method may be also used for measuring earth resistance. When the earthing system is known and earthing is available with a known resistance value, the measurement result will be the sum of the earth resistances: measured and known.

1



Turn on the meter. After turning the meter ON, the screen with measurement method  $R_{E3P}$  is shown.

2



To enter the screen of  $R_{E2P}$  measurement method, press **DOWN** button once.

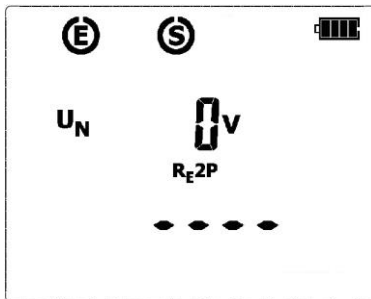

The meter is in the mode of measuring the interference voltage between the test terminals. The measuring voltage is compatible with the voltage selected when setting up the device.

3

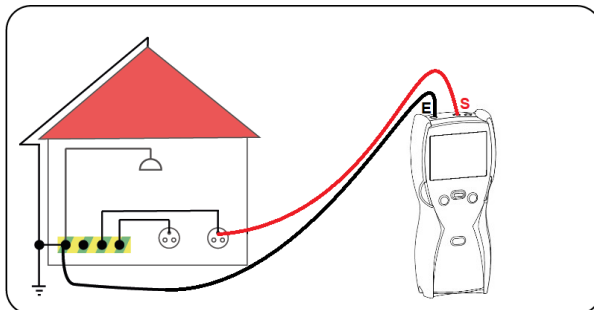

Test leads should be connected to the measurement terminals in the device, as shown above.

4



In order to start the measurement, press **START** button.





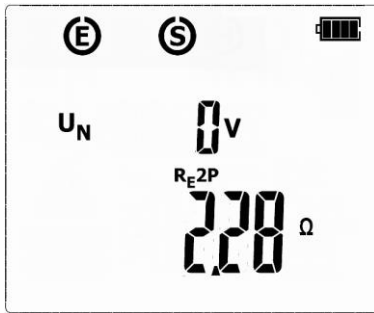

5



After the measurement, its result is shown: at the bottom of the screen, the main result is shown for **R<sub>E2P</sub>**, whereas the upper part of the screen shows the measured interference voltage **U<sub>N</sub>**. **The result is displayed for 20 seconds.** The result can be recalled by pressing **UP** button.

### Additional information displayed by the meter

<b>R &gt; 9999 Ω</b>	Measuring range is exceeded.
<b>U<sub>N</sub> &gt; 100 V, &gt; 100 V</b> and a continuous beep  , "NOISE!" and 	Voltage at test terminals is higher than 100 V, measurement is blocked.
<b>U<sub>N</sub> xxV, &gt; 40 V</b> and a continuous beep  , "NOISE!" and 	Where xx is the value of interference voltage. Voltage at test terminals is higher than 40 V, measurement is blocked.
<b>U<sub>N</sub> xxV, &gt; 24 V,</b> "NOISE!" and 	Where xx is the value of interference voltage. Voltage at test terminals is higher than 24 V but lower than 40 V, the measurement is blocked.
"NOISE!"	The interfering signal (noise signal) is below 24 V, but with a high value - the measurement result may be affected by additional uncertainty.

## 5. Power supply



Before the measurements, make sure that the status of the batteries or rechargeable batteries in the meter is sufficient for performing tasks related to the operation of the device.

### 5.1 Monitoring the power supply voltage

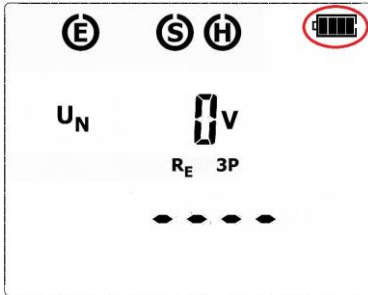

The charge level of the batteries or rechargeable batteries is indicated by the symbol in the right upper corner of the display on a current basis:



When all segments of the battery symbol are lit, it means that the batteries/rechargeable batteries are fully charged.



When all segments of the battery symbol are dark, it means that the batteries/rechargeable batteries are discharged and must be replaced.

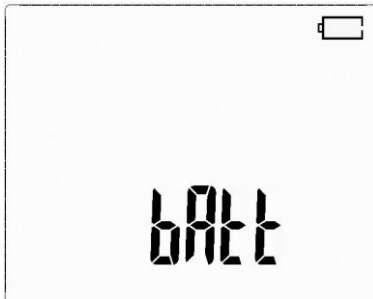

Message **bAtt** indicates that batteries/rechargeable batteries are totally discharged, all measurements are blocked. The meter switches off automatically after 5 sec.

## 5.2 Replacing (rechargeable) batteries

MRU-10 is powered by four AA alkaline LR6 batteries or rechargeable batteries of NiMH type. The (rechargeable) batteries are placed in the compartment at the bottom of the enclosure. The device is not equipped with an internal battery charger. Rechargeable batteries must be recharged in an external charger.



**Note**



**Do not power the meter from sources other than those listed in this manual. Before replacing the (rechargeable) batteries, disconnect the test leads from the meter.**

①

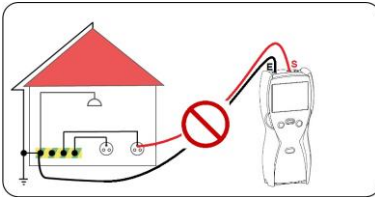

Disconnect the unit from the object!

②



Turn off the device using **ON/OFF** button.

③

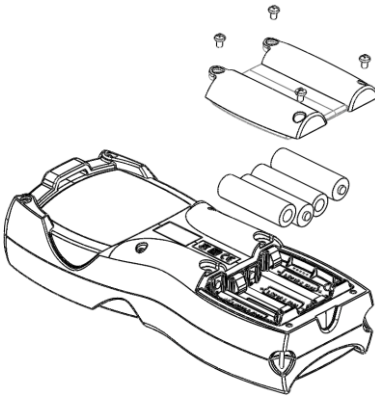

Remove the screws that secure the battery cover at the bottom of the compartment(4 pcs),

Remove all batteries (rechargeable batteries). Observe the correct polarity when inserting new batteries/rechargeable batteries.

Place and tighten the battery compartment cover.



**Note**



**Reverse polarity will not damage the meter or the batteries, but the meter will not work.  
Have the meter serviced in case of battery leakage inside the compartment.**

### **5.3 General principles regarding using Ni-MH rechargeable batteries**

- Store the he rechargeable batteries (the meter) in a dry, cool and well ventilated place and protect them from direct sunlight. The temperature of the environment in the case of prolonged storage should not exceed 30°C. If the rechargeable batteries are stored for a long time in a high temperature, then the occurring chemical processes may reduce their lifetime.
- Rechargeable batteries NiMH usually lasts for 500-1000 charging cycles. The rechargeable batteries reach their maximum capacity after being formatted (2-3 charge and discharge cycles). The most important factor which influences the lifetime of rechargeable batteries is the level of their discharge. The deeper the discharge level of the batteries, the shorter their lifetime.
- The memory effect is limited in the case of NiMH batteries. These batteries may be charged at any point with no serious consequences. However, it is recommended to discharge them completely every few cycles.
- During storage of Ni-MH rechargeable batteries they are discharged at the rate of approximately 20% per month. Keeping rechargeable batteries at high temperatures may accelerate this process even 100%. In order to prevent excessive discharge of rechargeable batteries, after which it would be necessary to format them, it is recommended to charge them from time to time (even if they are not used).
- Modern fast chargers detect both too low and too high temperature of the battery pack and react to the situation adequately. Too low temperature should prevent starting the process of charging, which might irreparably damage rechargeable batteries. An increase of the temperature of the rechargeable batteries is a signal to stop charging and is a typical phenomenon. However charging at a high ambient temperature apart from reducing batteries' lifetime causes an accelerated increase of their temperature and the result is that the batteries are not charged to their full capacity.
- Please note that when the batteries are charged with a fast-charger they are charged only to approx. 80% of their capacity - better results can be achieved by continuing charging: the charger enters trickle-charging mode and during the next few hours batteries are charged to their full capacity.
- Do not charge or use the batteries in extreme temperatures. Extreme temperatures reduce the lifetime of batteries and rechargeable batteries . Avoid placing devices powered by rechargeable batteries in very hot environments. The nominal working temperature must be absolutely observed.

## 6. Cleaning and maintenance



**Use only the maintenance methods specified by the manufacturer in this manual.**

The casing of the meter may be cleaned with a soft, damp cloth using all-purpose detergents. Do not use any solvents or cleaning agents which might scratch the casing (powders, pastes, etc.).

Clean the auxiliary electrode with water and dry it. Before the probe is stored for a prolonged period of time it is recommended to grease it with any machine lubricant.

The reels and test leads should be cleaned with water and detergents, and then dried.

The electronic system of the meter does not require maintenance.

## 7. Storage

In the case of storage of the device, the following recommendations must be observed:

- Disconnect all the test leads from the meter.
- Clean the meter and all its accessories thoroughly.
- Wind the long test leads onto the reels.
- If meter is to be stored for a prolonged period of time, the batteries must be removed from the device.
- In order to prevent a total discharge of the battery pack in the case of a prolonged storage, charge it from time to time.

## 8. Dismantling and Disposal

Worn-out electric and electronic equipment should be gathered selectively, i.e. it must not be placed with waste of another kind.

Worn-out electronic equipment should be sent to a collection point in accordance with the law of waste electrical and electronic equipment.

Before the equipment is sent to a collection point, do not dismantle any elements.

Observe local regulations concerning disposal of packages, waste batteries and accumulators.

## 9. Technical data

- The specified accuracy relates to the meter terminals.
- The abbreviation „m.v.” in the accuracy definition means the measured value.

### 9.1 Basic data

#### Measurement of interference voltage $U_N$ (RMS)

Range	Resolution	Accuracy
0...100 V	1 V	$\pm(10\% \text{ m.v.} + 1 \text{ digit})$

- Measurement for  $f_N$  45...65 Hz.
- The frequency of measurement - at least 2 measurements / sec.

#### Measurement of earth resistances $R_{E2P}$ (2-pole method)

Range	Resolution	Accuracy
0.01 $\Omega$ ... 19.99 $\Omega$	0.01 $\Omega$	$\pm(3\% \text{ m.v.} + 3 \text{ digits})$
20.0 $\Omega$ ...199.9 $\Omega$	0.1 $\Omega$	
200 $\Omega$ ...1999 $\Omega$	1 $\Omega$	$\pm 5\%$
2000 $\Omega$ ...9999 $\Omega$	1 $\Omega$	$\pm 8\%$

- Measuring current at the short circuit of > 20 mA.
- Measuring frequency of 125 Hz or 150 Hz.
- Selected test voltage: 25V or 50 V.
- Maximum interference voltage for the  $R_E$  measurement is 24 V.

#### Measurement of earth resistances $R_{E3P}$ (3-pole method)

Measurement method: 3-pole, conforming to EN 61557-5.

Measurement range according to EN 61557-5: 0.53  $\Omega$ ...9999  $\Omega$  for  $U_n = 50$  V.

Range	Resolution	Accuracy
0.00 $\Omega$ ...19.99 $\Omega$	0.01 $\Omega$	$\pm(3\% \text{ m.v.} + 3 \text{ digits})$
20.0 $\Omega$ ...199.9 $\Omega$	0.1 $\Omega$	
200 $\Omega$ ...1999 $\Omega$	1 $\Omega$	$\pm 5\%$
2000 $\Omega$ ...9999 $\Omega$	1 $\Omega$	$\pm 8\%$

- Measuring current at the short circuit of > 20 mA.
- Measuring frequency of 125 Hz or 150 Hz.
- Selected test voltage: 25V or 50 V.
- Maximum interference voltage for the  $R_E$  measurement is 24 V.

#### Measurement of resistance of auxiliary electrodes $R_H$ and $R_S$

Range	Resolution	Accuracy
0...999 $\Omega$	1 $\Omega$	$\pm(5\% + 8 \text{ digits})$
1.00...9.99 k $\Omega$	0.01 k $\Omega$	
10.0...19.9 k $\Omega$	0.1 k $\Omega$	

## 9.2 Other technical data

- a) type of insulation acc. to EN 61010-1 and IEC 61557 ..... double
- b) measurement category (for 2000 m a.s.l.) acc. to EN 61010-1 ..... III 300 V
- c) degree of housing protection acc. to EN 60529: ..... IP67
- d) maximum interference of AC + DC voltages, for the measurement ..... 24 V
- e) maximum measured voltage of interferences ..... 100 V
- f) measuring current frequency ..... 125 Hz for 50 Hz networks  
..... 150 Hz for 60 Hz networks
- g) measuring voltage for  $R_{E2P}$ ,  $R_{E3P}$  ..... 25 V or 50 V
- h) measuring current (short circuit) for  $R_{E2P}$ ,  $R_{E3P}$  ..... >20 mA
- i) maximum resistance of auxiliary electrodes ..... 20 k $\Omega$
- j) meter power supply ..... alkaline batteries or NiMH rechargeable batteries size AA - 4 pcs.
- k) number of measurements for  $R_{E3P}$  ..... >3000  
..... ( $R_E=10 \Omega$ ,  $R_H=R_S=100 \Omega$ , 25V 50 Hz, 2 measurements/minute)
- l) time of performing the resistance measurement with 2-pole method ..... <4 s
- m) time of performing the resistance measurement with 3-pole method ..... <8 s
- n) dimensions ..... 221 x 102 x 62 mm (without test leads)
- o) weight of the meter with batteries ..... 660 g
- p) operating temperature ..... -10°C..+50°C
- q) reference temperature ..... 23  $\pm$ 2°C
- r) storage temperature ..... -20..+60°C
- s) relative humidity ..... 20..90%
- t) nominal relative humidity ..... 40..60%
- u) altitude a.s.l. ....  $\leq 2000$  m\*
- v) quality standard, design and manufacturing are ..... ISO 9001 compliant
- w) the device meets the EMC requirements according to ..... EN 61326-1 and EN 61326-2-2

### NOTE

#### \* Information about the use of meter at altitude from 2000 m to 5000 m

As for voltage inputs E, S, H the instrument is to be considered downgraded to measurement category CAT III 150 V to ground (max 150 V between inputs) or CAT IV 100 V to ground (max 100 V between inputs). Markings and symbols indicated on the instrument are to be considered valid when using it at altitude lower than 2000 m.

## 9.3 Additional data

Data on additional uncertainties are useful mainly when the meter is used in non-standard conditions and for metrological laboratories for the purpose of calibration.

### 9.3.1 Influence of serial interference voltage on the resistance measurements for function $R_{E3P}$

$R_E$	$U_N$	Additional uncertainty [ $\Omega$ ]
0.00 ... 10.00 $\Omega$	25 V	$\pm(0,001R_E+0,01)U_Z+0,007U_Z^2$
	50 V	$\pm(0,001R_E+0,01)U_Z+0,004U_Z^2$
10.01..2000 $\Omega$	25 V, 50 V	$\pm(0,001R_E+0,01)U_Z+0,001U_Z^2$
2001..9999 $\Omega$	25 V, 50 V	$\pm(0.003R_E + 0.4)U_Z$

### 9.3.2 Influence of the auxiliary electrodes on earth resistance measurements for function R<sub>E</sub>3P

$R_H, R_S$	Additional uncertainty [%]
$R_H \leq 5 \text{ k}\Omega$ and $R_S \leq 5 \text{ k}\Omega$	$\pm \left( \frac{R_S}{R_S + 100000} \cdot 150 + \frac{R_H \cdot 0,004}{R_E} + 1,5 \cdot 10^{-8} \cdot R_H^2 \right)$
$R_H > 5 \text{ k}\Omega$ or $R_S > 5 \text{ k}\Omega$ or $R_H$ and $R_S > 5 \text{ k}\Omega$	$\pm \left( 7,5 + \frac{R_H \cdot 0,004}{R_E} + 1,5 \cdot 10^{-8} \cdot R_H^2 \right)$

$R_E[\Omega]$ ,  $R_S[\Omega]$  and  $R_H[\Omega]$  are values displayed by the device.

### 9.3.3 Additional uncertainties according to IEC 61557-5 (R<sub>E</sub>3P)

Significant parameter	Designation	Additional uncertainty
Position	E <sub>1</sub>	0%
Supply voltage	E <sub>2</sub>	0% ( <b>BAT</b> is not lit)
Temperature	E <sub>3</sub>	$\pm 0.2 \text{ digit}/^\circ\text{C}$ for $R < 1 \text{ k}\Omega$ $\pm 0.07\%/^\circ\text{C} \pm 0.2 \text{ digit}/^\circ\text{C}$ for $R \geq 1 \text{ k}\Omega$
Serial interference voltage	E <sub>4</sub>	According to the formulas shown in par. 9.2.1 ( $U_N = 3 \text{ V } 50/60 \text{ Hz}$ )
Resistance of auxiliary electrodes	E <sub>5</sub>	According to the formula in par. 9.2.2

## 10. Manufacturer

The manufacturer of the device and provider of guarantee and post-guarantee service:

**SONEL S.A.**  
Wokulskiego 11  
58-100 Świdnica  
Poland  
tel. +48 74 884 10 53 (Customer Service)  
e-mail: [customerservice@sonel.com](mailto:customerservice@sonel.com)  
web page: [www.sonel.com](http://www.sonel.com)

**Note:**  
**Service repairs must be performed only by the manufacturer.**



## NOTES

## NOTES





**SONEL S.A.**

Wokulskiego 11  
58-100 Świdnica  
Poland

**Customer Service**

tel. +48 74 884 10 53  
e-mail: [customerservice@sonel.com](mailto:customerservice@sonel.com)

[www.sonel.com](http://www.sonel.com)