

USER MANUAL

FAULT LOOP IMPEDANCE METER

MZC-20E

MZC-20E





USER MANUAL

FAULT LOOP IMPEDANCE METER MZC-20E



**SONEL S.A.
Wokulskiego 11
58-100 Świdnica
Poland**

Version 1.05 17.07.2023

MIC-20E meter is a modern, high quality, easy to use and safe measuring device. Please acquaint yourself with this manual in order to avoid measuring errors and prevent possible problems in operation of the meter.

CONTENTS

1	Safety	4
2	Measurements	5
2.1	Turning the meter on and off, display backlight	5
2.2	Selection of general measurement parameters	5
2.3	Remembering the last measurement result	6
2.4	Measurement of alternating voltage (AC)	7
2.5	Measurement of fault loop parameters	7
2.5.1	Cable length selection	7
2.5.2	Prospective short-circuit current	8
2.5.3	Measurement of fault loop parameters in the L-N(PEN) and L-L circuit	8
2.6	Measurement of resistance-to-earth	10
3	Troubleshooting	11
4	Power supply	12
4.1	Monitoring the power supply voltage	12
4.2	Replacing (rechargeable) batteries	12
4.3	General principles regarding using Ni-MH rechargeable batteries	13
5	Cleaning and maintenance	14
6	Storage	14
7	Dismantling and Disposal	14
8	Technical data	15
8.1	Basic data	15
8.2	Other technical data	16
8.3	Additional data	16
9	Manufacturer	16

1 Safety

MZC-20E meter is designed for performing check tests of protection against electric shock in mains systems. The meter is used for making measurements and providing results to determine safety of electrical installations. Therefore, in order to provide conditions for correct operation and accuracy of obtained results, the following recommendations must be observed:

- Before you proceed to operate the meter, acquaint yourself thoroughly with the present manual and observe the safety regulations and specifications provided by the producer.
- Any application that differs from those specified in the manual may result in a damage to the device and constitute a source of danger for the user.
- MZC-20E meters must be operated only by appropriately qualified personnel with relevant certificates authorising the personnel to perform works on electric systems. Unauthorized use of the meter may result in its damage and may be a source of serious hazard to the user.
- Using this manual does not exclude the need to comply with occupational health and safety regulations and with other relevant fire regulations required during the performance of a particular type of work. Before starting the work with the device in special environments, e.g. potentially fire-risk/explosive environment, it is necessary to consult it with the person responsible for health and safety.
- It is unacceptable to operate the device when:
 - ⇒ a damaged meter which is completely or partially out of order,
 - ⇒ a meter with damaged insulation,
 - ⇒ a meter stored for an excessive period of time in disadvantageous conditions (e.g. excessive humidity). If the meter has been transferred from a cool to a warm environment with a high level of relative humidity, do not start measurements until the meter is warmed up to the ambient temperature (approximately 30 minutes).
- One should remember that when the word **batt** appears on the display, it indicates insufficient voltage of power supply and the need to charge the accumulator or replace batteries. Measurements performed by means of the meter whose supply voltage is too low are burdened with additional uncertainties that are impossible to be estimated by the user. Such measurements must not be relied on in order to state correctness of protection of a network tested.
- Battery spill and damage to the meter may occur if discharged batteries are left in the meter.
- Before measurements may commence, make sure the leads are connected to the appropriate measurement sockets.
- Do not operate a meter with an open or incorrectly closed battery (accumulator) compartment or power it from other sources than those specified in the present manual.
- Repairs may be performed only by an authorised service point.

ATTENTION!

Only accessories for a given device should be used. Using other accessories may cause damage to measuring terminals and introduce additional measurement uncertainty.

Note:

Due to continuous development of the meter's software, the actual appearance of the display, in case of some of the functions, may slightly differ from the display presented in this operating manual.

2 Measurements



WARNING:

During the fault loop measurements, the earthed parts and parts accessible in the electrical installation being tested must not be touched.

CAUTION!



If an installation with residual current protection was modified for the time of measurement in order to ignore the RCD, remember to restore the state of the device that ensures correct operation of that switch.

2.1 Turning the meter on and off, display backlight

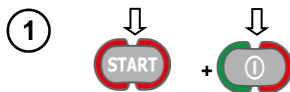

Briefly press the button to turn on the meter . Press it for a longer time to turn it off (text is displayed **off**). Press briefly the button  during meter operation to turn on/off the display.

2.2 Selection of general measurement parameters

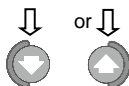

Keeping **START**  button depressed, turn on the meter with the **on/off**  button and wait a moment for the parameter selection screen. Briefly press the **on/off**, button keeping the **START** button depressed to turn on the meter without display backlight. Press the **on/off** button for a longer time with the **START** button depressed to turn on display backlight.



Press the button down  or up  to go to different values in a given setting.

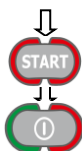

Validate the set parameter using the **START** button while moving to the next setting. Leave the parameter settings without validation using the **on/off** button and go to the meter readiness to measure.

2

Set the parameters according to the following algorithm:

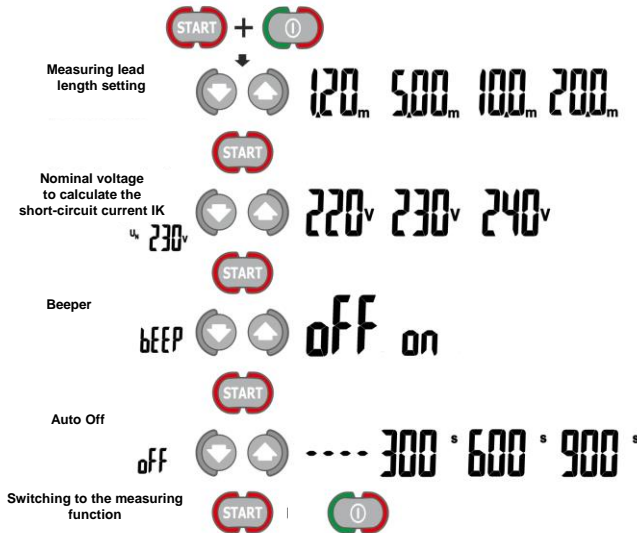

3



Press **START** to validate the changes and go to the measurement function, or...

4





...press **on/off** to go the measurement function without validating the changes.

Note:

- Before the first measurements, select the mains rated voltage U_n (220/380V, 230/400V or 240/415V) used in in the area where measurements are performed. This voltage value is used for calculating the values of prospective short-circuit current I_k .
- Symbol **---** indicates that no auto-off time has been set.

2.3 Remembering the last measurement result

The last measurement result is remembered until another measurement is started. The parameters of the settings will be changed or the device will turn off automatically (AutoOff). After a period of idle time since the last measurement (about 10 seconds) the meter will indicate its readiness for another measurement. Information **READY** is displayed after 5 seconds since the measurement was taken, and the measurement result disappears from the display after 10 seconds. Press the up  or down  arrow to restore the last measurement result. Re-press any of the arrows to recall the value of short-circuit current I_k and the real and imaginary component of the measured impedance (R , X_L).

2.4 Measurement of alternating voltage (AC)

After connecting the meter to the tested network its readiness for measurement is indicated by displaying information **READY**. The main display field shows alternating current of the network. This voltage is measured for the frequencies within the range of 45...65 Hz.

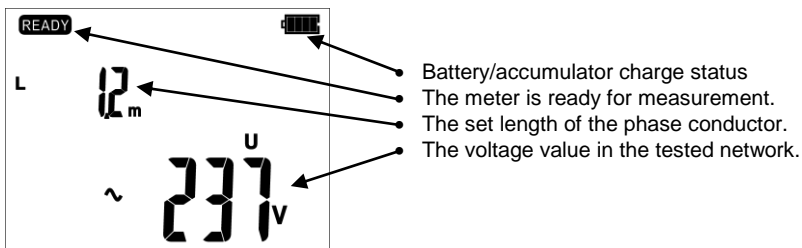

2.5 Measurement of fault loop parameters



If residual current devices have been installed in the network tested, they should be bypassed at the input and output of the active RDC cable (bridging). However, it should be remembered that the tested circuit is modified in this way and the obtained results may slightly differ from the actual results.

Each time after the measurements have been taken, remember to restore a state that ensures proper operation of the RCD switch and check whether it operates.



Measurements of short-circuit loop impedance downstream the inverters are ineffective and measurement results unreliable. This is due to the fluctuations of internal impedance of the inverter during its operations. Do not perform measurements of short-circuit loop impedance directly downstream inverters.

2.5.1 Cable length selection

Set the parameters according to the following algorithm, and according to the rules described in general parameters setting (see section 2.2)

Using cables terminated with banana plugs, before starting to measure, select the appropriate length of the phase conductor, compatible with the length of cable used for measurement.

Measuring lead
length setting



Cables from known manufacturers and selection of the correct length guarantees the declared measurement accuracy.

2.5.2 Prospective short-circuit current

The meter always measures impedance. The short-circuit current is calculated according to the following formula:

$$I_k = \frac{U_n}{Z_s}$$

where: U_n - mains rated voltage, Z_s - measured impedance.

On the basis of un rated voltage selected (section 2.2), the meter automatically recognizes the measurement at phase-to-neutral or phase-to-phase voltage and takes it into account in the calculations.

If the voltage of the network being tested is outside the tolerance range, the meter will not be able to determine a proper rated voltage for the short-circuit current calculation. In such a case, horizontal dashes will be displayed instead of short-circuit current value. The following diagram shows voltage ranges for which short-circuit current value is calculated.

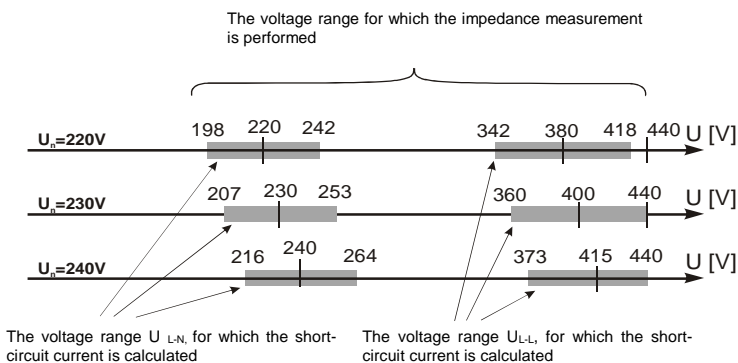

2.5.3 Measurement of fault loop parameters in the L-N(PEN) and L-L circuit

①



Turn on the meter. Depending on needs, select cable length according to section 2.5.1. and the value of nominal voltage of the tested network in accordance with section 2.5.2.

②

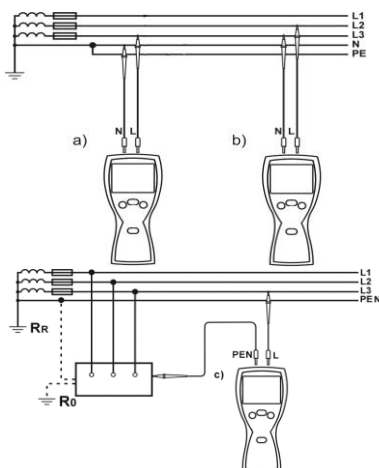

Connect test leads according to the drawing

a) for measurement in the L-N circuit

b) for measurement in the L-L circuit

b) for measurement in L-PEN circuit

3

The meter is ready for measurement.

- Phase conductor length L
- U_{L-N} or U_{L-L} voltage

4

Make measurement by pressing **START** push-button.

5

Read the main measurement result:

- mains voltage at the time of measurement
- fault loop impedance Z_S

6

The value of short-circuit current I_k and of individual impedance components Z_S (R , X_L) may be read when pressing the up or down arrow buttons for indications displayed in reverse order.

7

Indication:

- Standby
- Cable length
- Short-circuit current I_k

8

R fault loop resistance

9

X_L fault loop reactance

Note:

Minimum interval between successive measurements is 5 seconds. This minimum interval requirement is controlled by the meter. The next measurement may be performed only when a message **READY** appears on the screen.

Additional information displayed by the meter

READY	The meter is ready for measurement.
Z_{L-N} -U-	Voltage on terminals L and PEN is not within the measurable range. Conductor N (PEN) is not connected.
f	Incorrect voltage frequency (outside the range of 45...65 Hz)
Err	Error in the measurement.
ErrU	Error in the measurement of: loss of voltage after the measurement.
EOO	Short circuit malfunction!
NOISE!	This message displayed after the measurement indicates major noise in the system during the measurement. The measurement result may be affected by a large, unspecified error.
	The temperature inside the meter has risen above the limit. The measurement is blocked.
> 200Ω	Measuring range is exceeded.

2.6 Measurement of resistance-to-earth

The MZC-20E meter can be used for approximate measurements of resistance to earth. For this purpose, the phase conductor is used as a secondary source of voltage which generates test current. Connection diagram for the instrument for such measurement in the TN-C, TN-S and TT systems is shown in the figure below.

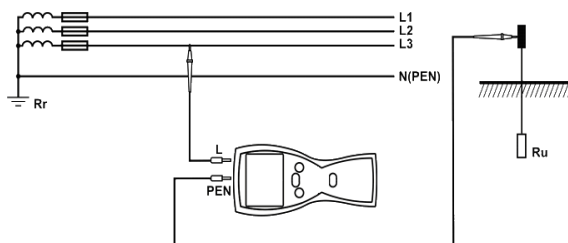

During the measurement, check the connections of the measured earth electrode with the electrical installation. For correct measurement, the tested earthing system should be disconnected from the electrical installation (N and PE conductors). If you want to measure the earth electrode, for instance in the TN-C-S system and simultaneously use the phase of the same system as a secondary source of current, disconnect the PE and N conductors from the measured earth electrode (see figure below). Otherwise, the meter will measure an incorrect value (the test current will flow not only through the measured earthing system).

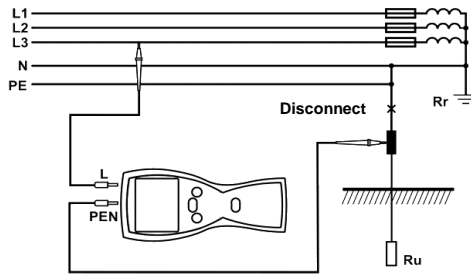

Note:

WARNING:

Disconnection of protective conductors is a serious life hazard for the staff performing the measurements and also third parties. When the measurements are completed, the protective and neutral conductors MUST be reconnected.

- If it is not possible to disconnect the conductors, use an earth resistance meter from the MRU range.
- As the measurement result is the sum of impedances of the measured earth electrode, operational earthing system, source and phase conductor, it contains a positive error. However, if such error does not exceed a limit value for the tested earthing system, it can be concluded that the earthing has been made correctly and there is no need for a more accurate measurement methods.

3 Troubleshooting

Before returning the meter for repair, call the service, perhaps the meter is not damaged, and the problem has occurred for another reason.

The meter repairs should be carried out only in the outlets authorized by the manufacturer.

The following table describes recommended activities in some situations that may occur during operation of the meter.

Symptom	Cause	Solution
The meter does not start after pressing the Ⓞ on/off button. The symbol is displayed during the voltage measurement bAt The meter turns off during the measurement	Discharged or incorrectly placed batteries/ rechargeable batteries	Check if the batteries are placed correctly, replace and/or recharge the rechargeable batteries. If this does not help, sent the meter for servicing.
Measurement errors after moving the meter from cold environment to warm and humid environment.	No acclimatization	Do not perform the measurements until the meter reaches the ambient temperature (about 30 minutes) and dries.
Further results obtained in the same measuring point are significantly different from each other	Incorrect connections in the tested system.	Check the connections and remove defects
	Mains with high noise or unstable voltage	Perform a larger number of measurements, average the results
The meter indicates the values close to zero or zero irrespective of the location of measurement and these values are significantly different than expected.	Incorrectly selected test leads in the meter settings.	

4 Power supply

4.1 Monitoring the power supply voltage

The charge level of the batteries or rechargeable batteries is indicated by the symbol in the right upper corner of the display on a current basis:

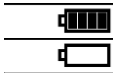

Batteries/rechargeable batteries charged.

Batteries/rechargeable batteries discharged.



Replace batteries or recharge rechargeable batteries!

Note:

- Symbol **bAt** in the display means that the supply voltage is too low and indicates that the batteries must be replaced or recharged.

Measurements performed with an insufficient supply voltage will be at risk of additional errors which the user is unable to evaluate. The charge level of the batteries or rechargeable batteries is indicated by the symbol in the right upper corner of the display on a current basis.

4.2 Replacing (rechargeable) batteries

The MZC-20E is powered by four LR6 batteries or AA size rechargeable batteries. The (rechargeable) batteries are placed in the compartment at the bottom of the enclosure.

WARNING:

Before replacing the (rechargeable) batteries, disconnect the test leads from the meter.

To replace the batteries/ rechargeable batteries:

- Disconnect the leads from the measuring circuit and turn off the meter,
- Remove the screw that secures the battery cover (the bottom of the compartment),
- Replace all batteries (rechargeable batteries). Observe the correct polarity when inserting new batteries/rechargeable batteries ("-" on the elastic part of the contact plate). Reverse polarity will not damage the meter or the batteries, but the meter will not work.
- Place and tighten the battery compartment cover.

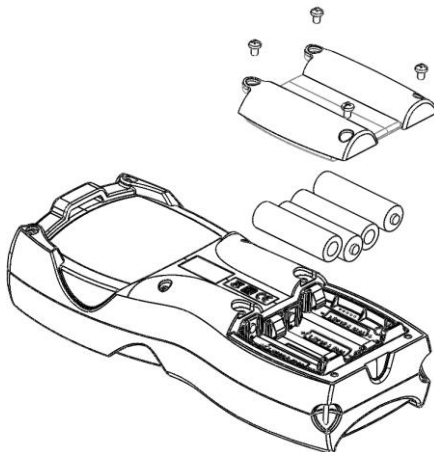

CAUTION!
Have the meter serviced in case of battery leakage inside the compartment.

Rechargeable batteries must be recharged in an external charger.

4.3 General principles regarding using Ni-MH rechargeable batteries

- If you do not use the device for a prolonged period of time, then it is recommended to remove the rechargeable batteries and store them separately.
- Store the accumulators in a dry, cool and well ventilated place and protect them from direct sunlight. The temperature of the environment in the case of prolonged storage should not exceed 30°C. If the rechargeable batteries are stored for a long time in a high temperature, then the occurring chemical processes may reduce their lifetime.
- Rechargeable batteries NiMH usually lasts for 500-1000 charging cycles. The rechargeable batteries reach their maximum capacity after being formatted (2-3 charge and discharge cycles). The most important factor which influences the lifetime a rechargeable battery is the level of its discharging. The deeper the discharge level of the batteries, the shorter their lifetime.
- The memory effect is limited in the case of NiMH batteries. These batteries may be charged at any point with no serious consequences. It is however, that every few cycles, they are completely discharged.
- During storage of Ni-MH rechargeable batteries they are discharged at the rate of approximately 30% per month. Storing batteries in high temperatures may increase this process even twofold. In order to prevent excessive discharge of rechargeable batteries, after which it would be necessary to format them, it is recommended to charge them from time to time (even if they are not used).
- Modern fast chargers detect both too low and too high a temperature of the battery pack and react to the situation adequately. Too low temperature should prevent starting the process of charging, which might irreparably damage rechargeable batteries. An increase of the temperature of the rechargeable batteries is a signal to stop charging and is a typical phenomenon. However charging at a high ambi-

ent temperature apart from reducing batteries' lifetime causes an accelerated increase of their temperature and the result is that the batteries are not charged to their full capacity.

- Please note that when the batteries are charged with a fast-charger they are charged only to approx. 80% of their capacity - better results can be achieved by continuing charging: the charger enters trickle-charging mode and during the next few hours batteries are charged to their full capacity.

- Do not charge or use the batteries in extreme temperatures. Extreme temperatures reduce the lifetime of batteries and rechargeable batteries. Avoid placing devices powered by rechargeable batteries in very hot environments. The nominal working temperature must be absolutely observed.

5 Cleaning and maintenance

CAUTION!

Use only the maintenance methods specified by the manufacturer in this manual.

The casing of the meter and its case may be cleaned with a soft, damp cloth using all-purpose detergents. Do not use any solvents or cleaning agents which might scratch the casing (powders, pastes, etc.).

Clean the probe with water and dry it. Before the probe is stored for a prolonged period of time it is recommended to grease it with any machine lubricant.

The reels and test leads should be cleaned with water and detergents, and then dried.

The electronic system of the meter does not require maintenance.

6 Storage

In the case of storage of the device, the following recommendations must be observed:

- Disconnect all the test leads from the meter.
- Clean the meter and all its accessories thoroughly.
- Wind the long test leads onto the reels.
- If meter is to be stored for a prolonged period of time, the batteries must be removed from the device.
- In order to prevent a total discharge of the accumulators in the case of a prolonged storage, charge them from time to time.

7 Dismantling and Disposal

Worn-out electric and electronic equipment should be gathered selectively, i.e. it must not be placed with waste of another kind.

Worn-out electronic equipment should be sent to a collection point in accordance with the law of waste electrical and electronic equipment.

Before the equipment is sent to a collection point, do not dismantle any elements.

Observe local regulations concerning disposal of packages, waste batteries and accumulators.

8 Technical data

8.1 Basic data

⇒ Abbreviation "m.v." used in the specification of measurement accuracy means a standard measured value

Voltage measurement

Display range	Resolution	Accuracy
0...440 V	1 V	±(2% m.v. + 3 digits)

- Frequency range: 45...65 Hz

Measurement of fault loop impedance Z_{L-PE} , Z_{L-N} , Z_{L-L}

Measurement of fault loop impedance Z_s

Test range according to IEC 61557:

Test lead	Test range Z_s
1.2 m	0.24...200 Ω
5 m	0.26...200 Ω
10 m	0.28...200 Ω
20 m	0.35...200 Ω

Display range:

Display range	Resolution	Accuracy
0.00...19.99 Ω	0.01 Ω	±(2,5% m.v. + 5 digits)
20.0...99.9 Ω	0.1 Ω	±(2,5% m.v. + 3 digits)
100...200 Ω	1 Ω	±(3% m.v. + 3 digits)

- Rated operating voltage U_{nL-N}/ U_{nL-L} : 220/380 V, 230/400 V, 240/415 V
- Operating voltage range: 180...270 V (dla Z_{L-PE} i Z_{L-N}) oraz 180...440 V (for Z_{L-L})
- Rated mains frequency f_n : 50 Hz, 60 Hz
- Operating frequency range: 45...65Hz
- Maximum measuring current: 15,3 A dla 230 V (10 ms) and 26,7 A dla 400 V (10 ms)

Indications of fault loop resistance R_s and fault loop reactance X_s

Display range	Resolution	Accuracy
0,00..9,99 Ω	0.01 Ω	±(5% + 5 digits) value Z_s

- Calculated and displayed for $Z_s < 10\Omega$

Indications of short-circuit current I_k

Test range according to IEC 61557 can be calculated on the basis of test ranges Z_s and rated voltages.

Display range	Resolution	Accuracy
1.15 ... 9.99 A	0.01 A	Calculated on the basis of accuracy for fault loop
10.0 ... 99.9 A	0.1 A	
100...999 A	1 A	
1.00...9.99 kA	0.01 kA	
10.0 ... 40.0 kA	0.1 kA	

- Prospective fault current calculated and displayed by the meter may slightly differ from the value calculated by the user with a calculator, basing on the displayed value of the impedance, because the meter calculates the current from unrounded value of fault loop impedance (which is used for displaying). As the correct value, consider I_k current value, displayed by the meter.

8.2 Other technical data

- a) type of insulation acc. to EN 61010-1 and IEC 61557.....double
- b) measurement category acc. to EN 61010-1..... III 300 V
- c) degree of housing protection acc. to EN 60529 IP67
- d) meter power supplyLR6 alkaline batteries or NiMH rechargeable batteries size AA (4 pcs)
- e) dimensions 220x98x58 mm
- f) weight of the meter and battery pack 509 g
- g) storage temperature -20...+70°C
- h) operating temperature -10...+50°C
- i) humidity 20...80%
- j) reference temperature +23 ± 2°C
- k) reference humidity 40...60%
- l) altitude (above sea level) < 2000 m
- m) time to Auto-OFF max. 900 seconds
- n) number of measurements Z (for rechargeable batteries) >5000 (2 measurements per minute)
- o) display LCD segment
- p) quality standard design and manufacturing are ISO 9001 compliant
- q) device meets the requirements of IEC 61557 standard
- r) the product meets EMC requirements (immunity for industrial environment) according to the following standards..... EN 61326-1 and EN 61326-2-2

8.3 Additional data

Data on additional uncertainties in accordance with IEC 61557-3 (Z) are useful mainly when the meter is used in non-standard conditions and for metrological laboratories for the purpose of calibration.

Significant parameter	Designation	Additional uncertainty
Position	E ₁	0%
Supply voltage	E ₂	0% (BATis not lit)
Temperature 0...35°C	E ₃	1.2 m lead 5 m lead – 0.011Ω 10 m lead – 0.019Ω 20 m lead – 0.035Ω
Phase angle 0..30° at the bottom of test range	E _{6,2}	0.6%
Frequency 99%..101%	E ₇	0%
Network voltage 85%..110%	E ₈	0%
Harmonic	E ₉	0%
DC component	E ₁₀	0%

9 Manufacturer

The manufacturer of the device and provider of guarantee and post-guarantee service:

SONEL S.A.

Wokulskiego 11
58-100 Świdnica
Poland

tel. +48 74 884 10 53 (Customer Service)

e-mail: customerservice@sonel.com

web page: www.sonel.com

Note:

Service repairs must be performed only by the manufacturer.



SONEL S.A.

Wokulskiego 11
58-100 Świdnica
Poland

Customer Service

tel. +48 74 884 10 53
e-mail: customerservice@sonel.com

www.sonel.com