

# **USER MANUAL**

## **EARTH RESISTANCE METER**

**MRU-30**

# MRU-30

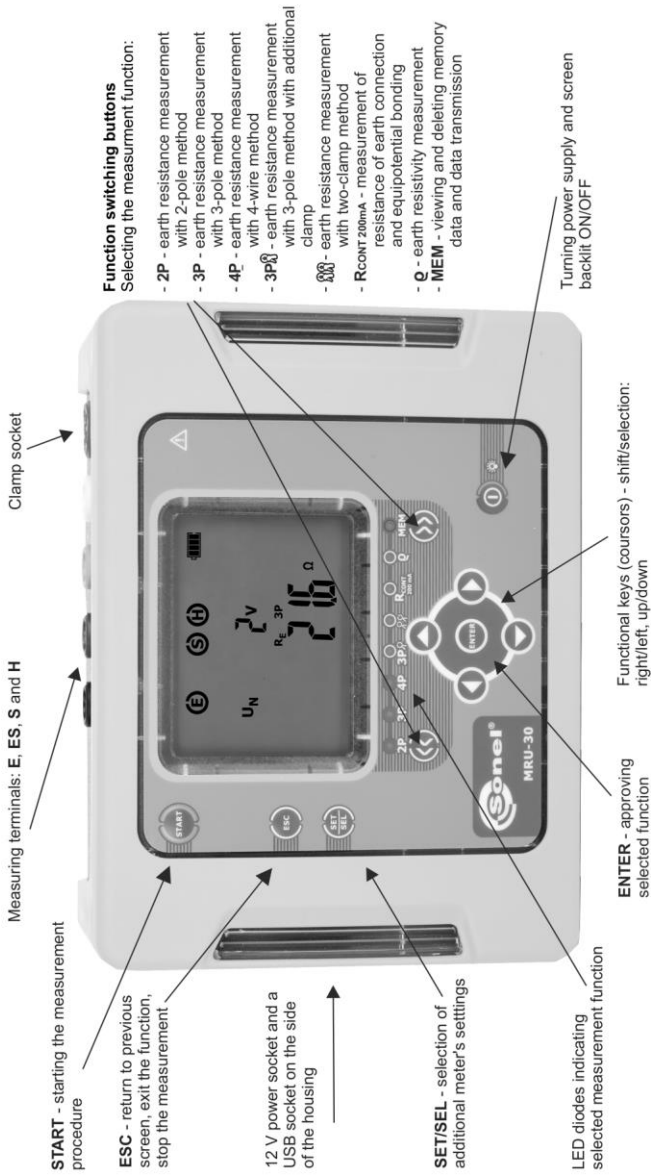



## **USER MANUAL**

# **EARTH RESISTANCE METER MRU-30**



**SONEL S. A.  
Wokulskiego 11  
58-100 Świdnica  
Poland**

The MRU-30 meter is a modern, high quality, easy to use and safe measuring device. Please acquaint yourself with the present manual in order to avoid measuring errors and prevent possible problems related to operation of the meter.

# TABLE OF CONTENTS

<b>1</b>	<b>Safety</b>	<b>5</b>
<b>2</b>	<b>Turning the meter ON and activating screen backlit.</b>	<b>6</b>
<b>3</b>	<b>Meter configuration</b>	<b>6</b>
<b>4</b>	<b>Measurements</b>	<b>9</b>
4.1	Measurement of AC+DC interfering (noise) voltages	9
4.2	Earth resistance measurement with 2-pole method ( $R_{E2P}$ )	10
4.3	Earth resistance measurement with 3-pole method ( $R_{E3P}$ )	11
4.4	Earth resistance measurement with 4-wire method ( $R_{E4P}$ )	15
4.5	Earth resistance measurement with 3-pole method with additional clamp ( $R_{E3P+C}$ )	18
4.6	Earth resistance measurement with two-clamp method (2C)	22
4.7	Calibration of the measurement clamp C-3	24
4.8	Measurement of resistance of earth connection and equipotential bonding ( $R_{CONT}$ )	26
4.9	Calibration of the test leads for $R_{CONT}$ measurement	28
4.10	Earth resistivity measurement ( $\rho$ )	29
<b>5</b>	<b>Memory of measurement results</b>	<b>33</b>
5.1	Storing the measurement results in the memory	33
5.2	Viewing memory data	35
5.3	Deleting memory data	36
5.3.1	Deleting cell data	36
5.3.2	Deleting bank data	37
5.3.3	Deleting the whole memory	39
<b>6</b>	<b>Data transmission</b>	<b>40</b>
6.1	Computer connection accessories	40
6.2	Data transmission through USB port	40
<b>7</b>	<b>Firmware update</b>	<b>41</b>
<b>8</b>	<b>Power supply of the meter</b>	<b>41</b>
8.1	Monitoring the power supply voltage	41
8.2	Charging the rechargeable battery pack	42
8.3	General principles of using Ni-MH batteries	43
<b>9</b>	<b>Cleaning and maintenance</b>	<b>43</b>
<b>10</b>	<b>Storage</b>	<b>43</b>
<b>11</b>	<b>Dismantling and disposal</b>	<b>44</b>
<b>12</b>	<b>Technical data</b>	<b>44</b>
12.1	Basic data	44
12.2	Other technical data	46
12.3	Additional data	47
12.3.1	Influence of the serial interference voltage $U_z$ on earth resistance measurements for methods $R_{E3P}$ , $R_{E4P}$ , $R_{E3P+C}$ , $\rho$	47
12.3.2	Influence of the auxiliary electrodes on earth resistance measurements for methods $R_{E3P}$ , $R_{E4P}$ , $R_{E3P+C}$ , $\rho$	47

12.3.3	<i>Influence of the interference current <math>I_z</math> on the result of the earth resistance for method <math>R_{E3P+C}</math>.....</i>	<i>47</i>
12.3.4	<i>Influence of interference current on the result of the earth resistance measurement for two-clamp method (2C) .....</i>	<i>48</i>
12.3.5	<i>Influence of the relation of the resistance measured with clamp for the multiple earthing branch to the resultant resistance (<math>R_{E3P+C}</math>).....</i>	<i>48</i>
12.3.6	<i>Additional uncertainties in accordance with IEC 61557-5 (<math>R_{E3P}</math>, <math>R_{E4P}</math>).....</i>	<i>48</i>
<b>13</b>	<b><i>Manufacturer.....</i></b>	<b><i>48</i></b>

# 1 Safety

The MRU-30 meter has been designed to carry out measurements which results determine the safety conditions of the installation. Therefore, in order to provide conditions for correct operation and the correctness of the obtained results, the following recommendations must be observed:

- Before you proceed to operate the meter, acquaint yourself thoroughly with the present manual and observe the safety regulations and specifications determined by the producer.
- The MRU-30 meter has been designed for the purpose of measurements of earth connection and equipotential bonding, and also ground resistivity. Any application that differs from those specified in the present manual may result in a damage to the device and constitute a source of danger for the user.
- The device must be operated solely by appropriately qualified personnel with relevant certificates to carry out measurements of electric installation. Operation of the meter realized by unauthorized personnel may result in damage to the device and constitute a source of danger for the user.
- Using this manual does not exclude the need to comply with occupational health and safety regulations and with other relevant fire regulations required during the performance of a particular type of work. Before starting the work with the device in special environments, e.g. potentially fire-risk/explosive environment, it is necessary to consult it with the person responsible for health and safety.
- It is unacceptable to operate the following:
  - ⇒ A damaged meter which is completely or partially out of order,
  - ⇒ A meter with damaged test leads insulation,
  - ⇒ A meter stored for an excessive period of time in disadvantageous conditions (e.g. excessive humidity). **If the meter has been transferred from a cool to a warm environment of a high level of relative humidity, do not start doing measurements until the meter has been warmed up to the ambient temperature (approximately 30 minutes).**
- Before measurements may commence, make sure the test leads are connected to the appropriate measurement sockets.
- The meter can't be powered from other sources than those mentioned in this manual.
- The meter's inputs are electronically protected from power surge, as a result for example, of accidental connection to the power supply source:
  - for all input combinations – up to 276 V for 30 seconds.
- Manufacturer's calibration doesn't include the resistance of test leads. Displayed result is sum of the measured object and the test leads resistance.
- The device complies with the following standards: EN 61010-1 and EN 61557-1, -4, -5.

## Note:

Manufacturer reserves the right to apply changes in the appearance, accessories and technical parameters of the meter. Due to continuous development of the meter's software, the actual appearance of the display, in case of some of the functions, may slightly differ from the display presented in this operating manual.

## 2 Turning the meter ON and activating screen backlight.

①



Turn on the meter with  button.

②



Short press  button to turn the screen backlight on; press the button again to turn the backlight off.

③



Switch off the meter by pressing and holding  button for approx. 2 sec.

Emergency situations.



Pressing  button for approx. 7 seconds will turn off the meter in case of emergency.

## 3 Meter configuration

①



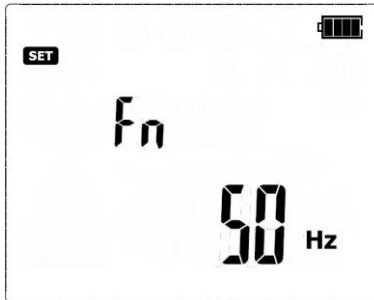

Turn on the meter by pressing and keeping **SET/SEL** button pressed.



②



When the **Fn** screen is displayed use  and  to set mains frequency – 50 Hz or 60 Hz (50 Hz is set as default).



3



Use ← and → buttons to enter the screen with audio message settings: **bEEP**.



4



Use ↑ and ↓ buttons to turn the audio messages ON (ON) or OFF (OFF).

5



Press ← and → to switch to auto off setting screen (Auto-OFF): **OFF**

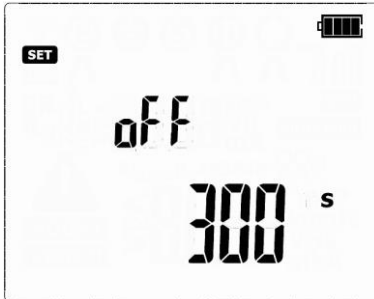

6



Use ↑ and ↓ to set the time period after which the meter will turn off automatically (Auto-OFF): 300 s, 600 s, 900 s or none (dashes - Auto-OFF is disabled). This function turns off the meter automatically after the certain (set by user) period of time.

7



Use **←** and **→** buttons to enter the screen where the unit of length can be selected: **diSt**.

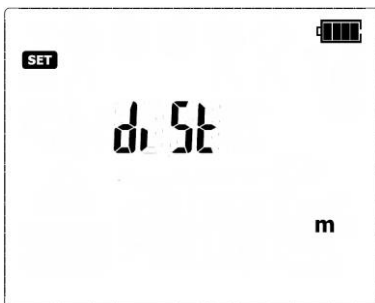

8



Use **↑** and **↓** buttons to set the unit of length: 'm' (meter) or 'ft' (feet) ('m' is set as default).

9



Use **←** and **→** buttons to enter the screen with firmware update: **USB UPdt**.

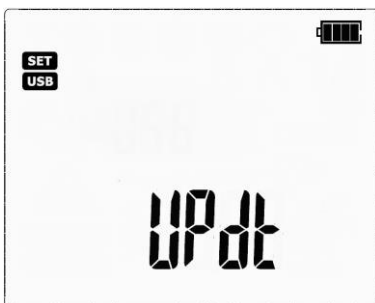

10



Press **ENTER** to enter the update mode. The update process is described in point 7.

After changing the parameters, you may exit **SETUP** menu:

11



Press **ENTER** button to memorize settings (not applicable for Update screen) or use **ESC** button to go to the measurement screen without confirming the changes.

## 4 Measurements

### Note:

During measurements the status bar is displayed.



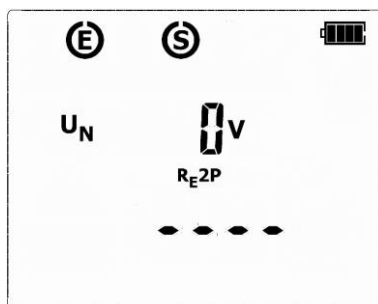

### 4.1 Measurement of AC+DC interfering (noise) voltages

**Note:**  
**This measurement is active only when the meter is set for the following measurements, before starting them with the START button:  $R_{E2P}$ ,  $R_{E3P}$ ,  $R_{E4P}$ ,  $R_{E3P+C}$ ,  $R_{CONT}$ ,  $\rho$ .**



In  $R_{E2P}$ ,  $R_{E3P}$ ,  $R_{E4P}$ ,  $R_{E3P+C}$ ,  $R_{CONT}$  and  $\rho$  modes, before starting the measurement with the **START** button, MRU-30 is monitoring the voltage present on the measurement points (between **E** and other sockets). The value of the interfering voltage is displayed on screen.

### Additional information displayed by the meter

<p><math>U_N &gt; 100V</math>, <math>&gt; 100V</math> and a continuous sonic signal , 'NOISE!' and </p>	<p>The voltage on the measurement points exceeds 100 V, the measurement is blocked.</p>
<p><math>U_N xxV</math>, <math>&gt; 40V</math> and a continuous sonic signal , 'NOISE!' and </p>	<p>Where <math>xx</math> is the value of interfering voltage. The voltage on the measurement points exceeds 40 V, the measurement is blocked.</p>
<p><math>U_N xxV</math>, <math>&gt; 24V</math>, 'NOISE!' and </p>	<p>Where <math>xx</math> is the value of interfering voltage. The voltage on the measurement points exceeds 24 V, but it's below 40 V, the measurement is blocked.</p>
<p>'NOISE!'</p>	<p>The value of the interfering signal is below 24 V, but it has too high value, so the result may be distorted by additional uncertainty.</p>

## 4.2 Earth resistance measurement with 2-pole method ( $R_{E2P}$ )

①



Use << or >> button to start the meas-

urement **2P** (LED **2P** is on). The meter is in the mode of noise voltage measurement between measurement points.

②



Press **SET/SEL** button to select measurement voltage.

③



Use  $\uparrow$  and  $\downarrow$  button to set the measurement voltage value of 25 V or 50 V.

④



or



Press **ENTER** to confirm settings or press **ESC** to exit without saving the changes.

⑤

Connect test leads according to the drawing.

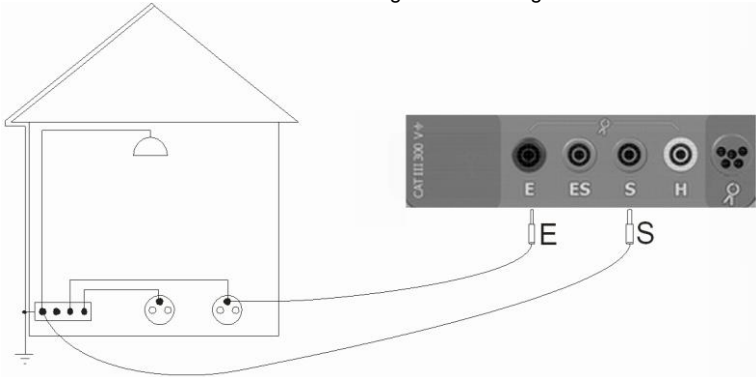

⑥

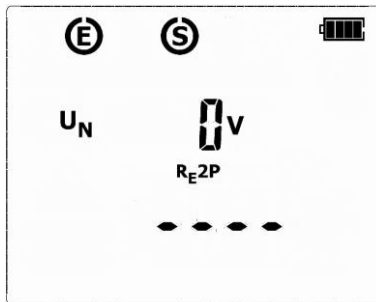

The meter is ready for measurement.

⑦



Press **START** to commence measurement.

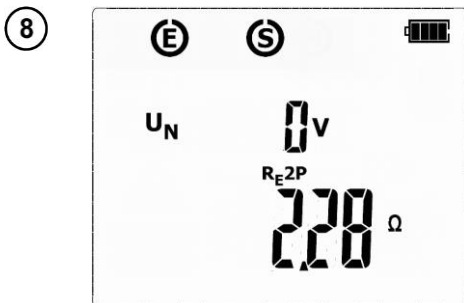

After finishing the measurement, read out the result. The results of all the measurements that have been carried out will be displayed on screen.

The result is displayed for 20 s. It may be displayed again when **ENTER** is pressed.

## Additional information displayed by the meter

<b>R&gt;9999Ω</b>	Measurement range exceeded.
<b>U<sub>N</sub> &gt;100V, &gt;100V</b> and a continuous sonic signal ⚡, 'NOISE!' and ⚠	The voltage on the measurement points exceeds 100 V, the measurement is blocked.
<b>U<sub>N</sub> xxV, &gt;40V</b> and a continuous sonic signal ⚡, 'NOISE!' and ⚠	Where xx is the value of interfering voltage. The voltage on the measurement points exceeds 40 V, the measurement is blocked.
<b>U<sub>N</sub> xxV, &gt;24V, 'NOISE!'</b> and ⚠	Where xx is the value of interfering voltage. The voltage on the measurement points exceeds 24 V, but it's below 40 V, the measurement is blocked.
<b>'NOISE!'</b>	The value of the interfering signal is below 24 V, but it has too high value, so the result may be distorted by additional uncertainty.

### 4.3 Earth resistance measurement with 3-pole method (R<sub>E3P</sub>)

The basic type of the earth resistance measurement is 3-pole measurement.

- 1 Disconnect the tested earth electrode for the object installation.

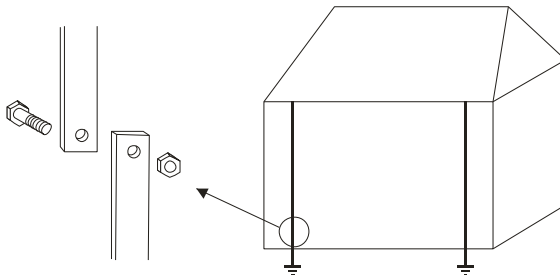

2



Use << or >> button to start the meas-

urement of 3P (LED 3P is on). The meter is in the mode of noise voltage measurement between measurement points.

3



Press SET/SEL button to select measurement voltage.

4



Use ↑ and ↓ button to set the measurement voltage value of 25 V or 50 V.

5



or



Press ENTER to confirm settings or press ESC to exit without saving the changes.

Connect test leads according to the drawing .

6

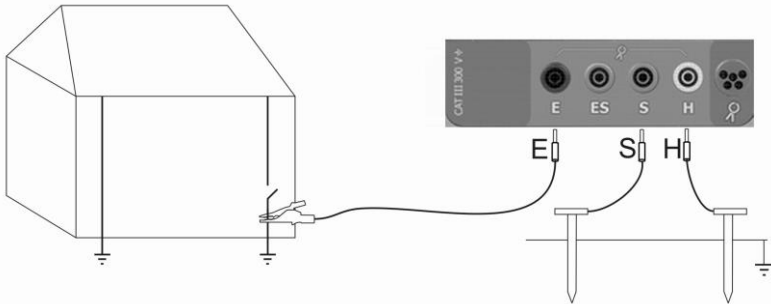

Connect the current electrode driven into ground to the H socket of the meter, Connect the voltage electrode driven into ground to the S socket of the meter, Connect the tested earth electrode to the E socket of the meter. The tested earth electrode as well as the current electrode and voltage electrode should be aligned.

7

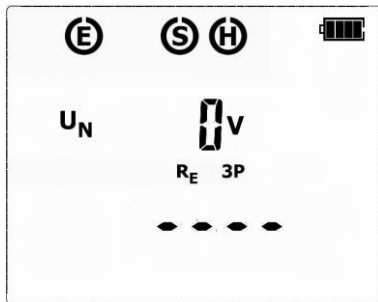

The meter is ready for measurement.

8



Press **START** to commence measurement.

9

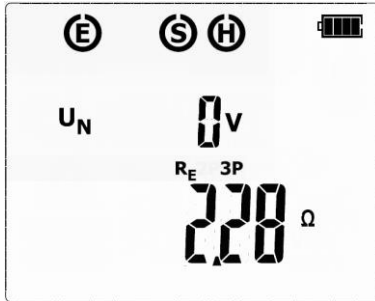

Read out the result. The results of all the measurements that have been carried out will be displayed on screen.

10



Use and button to toggle between the measurement result components:  
**R<sub>H</sub>** – resistance of current electrode  
**R<sub>S</sub>** – resistance of voltage electrode  
**R<sub>E</sub>** – additional uncertainty caused by the resistance of the auxiliary electrodes  
**U<sub>N</sub>** – interfering (noise) voltage

The result is displayed for 20 s. It may be displayed again when **ENTER** is pressed.

11

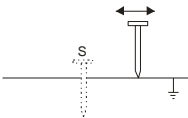

Repeat the measurements (see points 7, 8 and 9) moving the voltage electrode by a couple of meters: approaching it to and moving it away from the tested earth electrode.

If the **R<sub>E</sub>** test results differ more than 3%, then it is necessary to significantly increase the distance between the current electrode from the earth electrode in question and repeat the measurement.

### Note:











**Earth resistance measurement may be carried out if the interference voltage does not exceed 24 V. The interference voltage is measured up to 100 V, but over 40 V it is signalled as hazardous. Do not connect the meter to a voltage exceeding 100 V.**

- Pay particular attention to the quality of the connection of the tested object with the test leads – the contact area must be cleaned of paint, rust, etc.

- If the resistance of the auxiliary electrodes is too high, then the measurement of the **R<sub>E</sub>** earth electrode will be distorted by additional uncertainty. A particularly high measurement uncertainty is generated if we measure a low value of the earth resistance with electrodes of a loose contact with the soil (such a situation occurs often if the earth electrode is properly made and the upper layer of the ground is dry and characterized by a low conductivity). Then the relation between the electrode re-

sistance and the resistance of the measured earthing is very high, and so is the case of the measurement uncertainty which depends on it. What may be done then is to perform, in accordance with the formulae specified in point 12.2, calculations, which will permit to evaluate the influence of the measurement conditions. It is also possible to improve the contact of the electrode with the ground, for example by means of moistening of the place when the electrode is driven, its driving into the ground in another place or using a 80 cm electrode. Check also the test leads and make sure the insulation is not damaged and the contacts: test lead – banana plug – electrode are not corroded or loosened. In most cases the achieved resolution of the measurement is sufficient, but it is necessary to be conscious of the uncertainty the measurement is burdened with.

## Additional information displayed by the meter

<b><math>R_E &gt; 9999\Omega</math></b>	Measurement range exceeded.
<b><math>U_N &gt; 100V, &gt; 100V</math></b> and a continuous sonic signal  , 'NOISE!' or 	The voltage on the measurement points exceeds 100 V, the measurement is blocked.
<b><math>U_N xxV, &gt; 40V</math></b> and a continuous sonic signal  , 'NOISE!' and 	Where xx is the value of interfering voltage. The voltage on the measurement points exceeds 40 V, the measurement is blocked.
<b><math>U_N xxV, &gt; 24V,</math></b> 'NOISE!' and 	Where xx is the value of interfering voltage. The voltage on the measurement points exceeds 24 V, but it's below 40 V, the measurement is blocked.
'NOISE!'	The value of the interfering signal is below 24 V, but it has too high value, so the result may be distorted by additional uncertainty.
<b>LIMIT!</b> and ER along with % value	The uncertainty caused by resistance of the electrodes > 30%. (Uncertainties calculated on the basis of the measured values.)
<b>LIMIT!</b> and $R_H$ or $R_S$ along with $\Omega$ value	The resistance of H and S electrodes, or one of them exceeds 19.9 k $\Omega$ , the proper measurement is not possible.
Flashing symbols:  ,  , 	Flashing symbols E or H or S, or both of them, or all three at the same time – one or two or three test leads are disconnected from the measurement sockets.



## 4.4 Earth resistance measurement with 4-wire method ( $R_{E4P}$ )

The 4-wire method is recommended in the case of measurements of earth resistance of very low values. It permits to eliminate the influence of the test leads resistance over the result of the measurement. In order to evaluate the resistivity of the ground it is recommended to use the dedicated measurement function (point 4.9).

- ① Disconnect the tested earth electrode for the object installation.

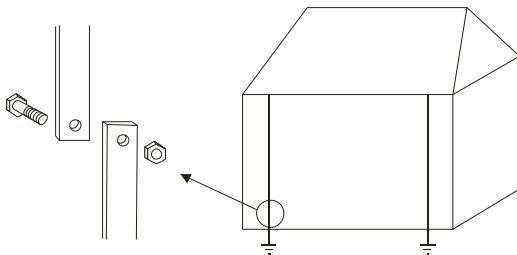

- ② Use **<<** or **>>** button to start the measurement of **4P** (LED **4P** is on). The meter is in the mode of noise voltage measurement between measurement points).



- ③ Press **SET/SEL** button to select measurement voltage.



- ④ Use **▲** and **▼** button to set the measurement voltage value of 25 V or 50 V



- ⑤ Press **ENTER** to confirm settings or press **ESC** to exit without saving the changes.



or



- ⑥ Connect test leads according to the drawing.

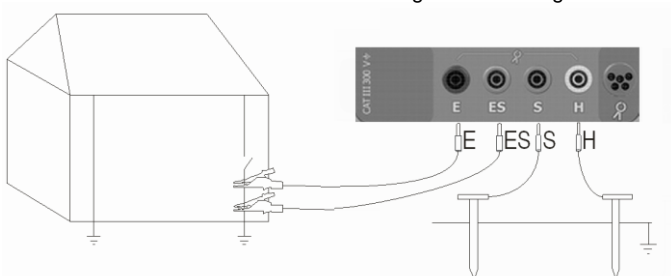

Connect the current electrode driven into ground to the **H** socket of the meter.  
 Connect the voltage electrode driven into ground to the **S** socket of the meter.  
 Connect the tested earth electrode to the **E** socket of the meter.  
 Connect the **ES** socket to the earth electrode In question below the **E** cable.  
 The tested earth electrode as well as the current electrode and voltage electrode should be aligned.

7

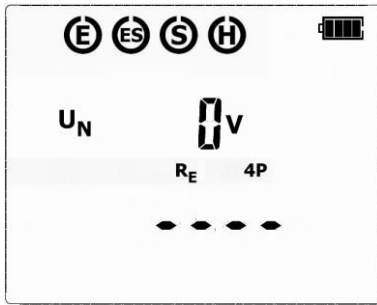

The meter is ready for measurement.

8



Press **START** to commence measurement.

9

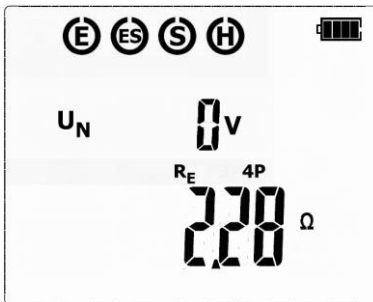

After finishing the measurement, read out the result. The results of all the measurements that have been carried out will be displayed on screen.

10



Use ← and → button to toggle between the measurement result components:

**R<sub>H</sub>** – resistance of current electrode

**R<sub>S</sub>** - resistance of voltage electrode

**ER** – additional uncertainty caused by the resistance of the electrodes

**U<sub>N</sub>** – interfering (noise) voltage.

The result is displayed for 20 s. It may be displayed again when **ENTER** is pressed.

11

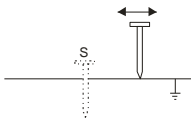

Repeat the measurements (see points 7, 8 and 9) moving the voltage electrode by a couple of meters: approaching it to and moving it away from the tested earth electrode.

If the R<sub>E</sub> test results differ more than 3%, then it is necessary to significantly increase the distance between the current electrode from the earth electrode in question and repeat the measurement.







## Note:



Earth resistance measurement may be carried out if the interference voltage does not exceed 24 V. The interference voltage is measured up to 100 V, but over 40 V it is signalled as hazardous. Do not connect the meter to a voltage exceeding 100 V.

- Pay particular attention to the quality of the connection of the tested object with the test leads – the contact area must be cleaned of paint, rust, etc.
- If the resistance of the auxiliary electrodes is too high, then the measurement of the  $R_E$  earth electrode will be distorted by additional uncertainty. A particularly high measurement uncertainty is generated if we measure a low value of the earth resistance with electrodes of a loose contact with the soil (such a situation occurs often if the earth electrode is properly made and the upper layer of the ground is dry and characterized by a low conductivity). Then the relation between the electrode resistance and the resistance of the measured earthing is very high, and so is the case of the measurement uncertainty which depends on it. What may be done then is to perform, in accordance with the formulae specified in point 12.2, calculations, which will permit to evaluate the influence of the measurement conditions. It is also possible to improve the contact of the electrode with the ground, for example by means of moistening of the place when the electrode is driven, its driving into the ground in another place or using a 80 cm electrode. Check also the test leads and make sure the insulation is not damaged and the contacts: test lead – banana plug – electrode are not corroded or loosened. In most cases the achieved resolution of the measurement is sufficient, but it is necessary to be conscious of the uncertainty the measurement is burdened with.

## Additional information displayed by the meter

<b><math>R_E &gt; 9999 \Omega</math></b>	Measurement range exceeded.
<b><math>U_N &gt; 100V, &gt; 100V</math></b> and a continuous sonic signal  , 'NOISE!' and 	The voltage on the measurement points exceeds 100 V, the measurement is blocked.
<b><math>U_N xxV, &gt; 40V</math></b> and a continuous sonic signal  , 'NOISE!' and 	Where xx is the value of interfering voltage. The voltage on the measurement points exceeds 40 V, the measurement is blocked.
<b><math>U_N xxV, &gt; 24V</math></b> , 'NOISE!' and 	Where xx is the value of interfering voltage. The voltage on the measurement points exceeds 24 V, but it's below 40V, the measurement is blocked.
<b>'NOISE!'</b>	The value of the interfering signal is below 24 V, but it has too high value, so the result may be distorted by additional uncertainty.
<b>LIMIT!</b> and <b>ER</b> along with % value	The uncertainty caused by resistance of the electrodes > 30%. (Uncertainties calculated on the basis of the measured values.)
<b>LIMIT!</b> and <b>R<sub>H</sub></b> or <b>R<sub>S</sub></b> along with $\Omega$ value	The resistance of H and S electrodes, or one of them exceeds 19.9 k $\Omega$ , the proper measurement is not possible.
Flashing symbols: 	Flashing symbols E or H or S, or both of them, or all three at the same time, one or two or three test leads are disconnected from the measurement sockets.

## 4.5 Earth resistance measurement with 3-pole method with additional clamp ( $R_{E3P+C}$ )

①



Use << or >> button to start the meas-

urement of  $3P+C$  (LED  $3P+C$  is on). The meter is in the mode of noise voltage measurement between measurement points and also it measures the current flowing through the clamp.

②



Press **SET/SEL** button to select measurement voltage.

③



Use  $\uparrow$  and  $\downarrow$  button to set the measurement voltage value of 25 V or 50 V.

④



or



Press **ENTER** to confirm settings or press **ESC** to exit without saving the changes.

⑤

Connect test leads according to the drawing.

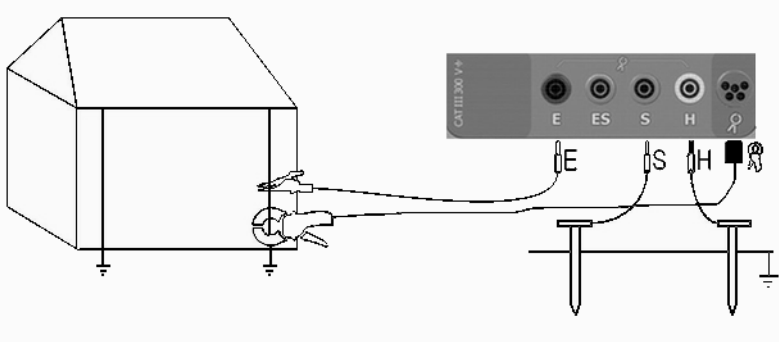

Connect the current electrode driven into ground to the **H** socket of the meter,  
 Connect the voltage electrode driven into ground to the **S** socket of the meter,  
 Connect the tested earth electrode to the **E** socket of the meter,  
 The tested earth electrode as well as the current electrode and voltage electrode should be aligned.

Attach the receiving clamp around the tested earth electrode below the **E** cable connection.

6

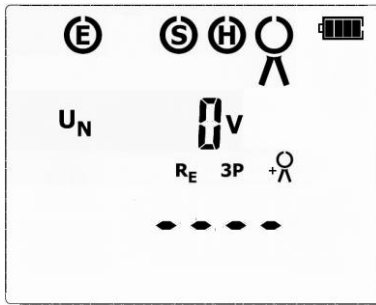

The meter is ready for measurement.

7



Use ← and → to toggle between the measurements:  
U<sub>N</sub> – interfering (noise) voltage,  
I<sub>L</sub> – leakage current measured by the clamp

8



Press **START** to commence measurement.

9

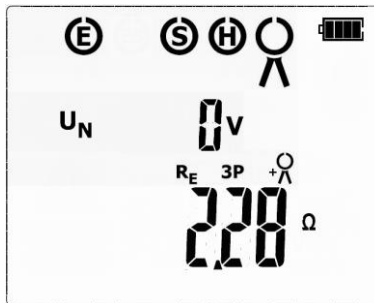

After finishing the measurement, read out the result. The results of all the measurements that have been carried out will be displayed on screen.

10



Use ← and → to toggle between the measurement result components:  
R<sub>H</sub> – resistance of current electrode  
R<sub>S</sub> – resistance of voltage electrode  
ER – additional uncertainty caused by the resistance of the electrodes  
U<sub>N</sub> – interfering (noise) voltage  
I<sub>L</sub> – leakage current.

The result is displayed for 20 s. It may be displayed again when **ENTER** is pressed.

11

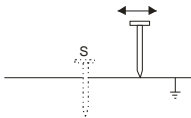

Repeat the measurements (see points 6, 8 and 9) moving the voltage electrode by a couple of meters: approaching it to and moving it away from the tested earth electrode.

If the  $R_E$  test results differ more than 3%, then it is necessary to significantly increase the distance between the current electrode from the earth electrode in question and repeat the measurement.

## Note:











**Earth resistance measurement may be carried out if the interference voltage does not exceed 24 V. The interference voltage is measured up to 100 V, but over 40 V it is signalled as hazardous.**

**Do not connect the meter to a voltage exceeding 100 V.**

- The clamps are not the part of the meter's standard accessories, they are to be purchased separately.
- The clamp must be calibrated before it is used for the first time. It may be periodically calibrated in order to avoid the influence of the ageing elements upon the resolution of measurements. The clamp calibration option is described in point 4.7.
- Pay particular attention to the quality of the connection of the tested object with the test leads – the contact area must be cleaned of paint, rust, etc.
- If the resistance of the auxiliary electrodes is too high, then the measurement of the  $R_E$  earth electrode will be distorted by additional uncertainty. A particularly high measurement uncertainty is generated if we measure a low value of the earth resistance with electrodes of a loose contact with the soil (such a situation occurs often if the earth electrode is properly made and the upper layer of the ground is dry and characterized by a low conductivity). Then the relation between the electrode resistance and the resistance of the measured earthing is very high, and so is the case of the measurement uncertainty which depends on it. What may be done then is to perform, in accordance with the formulae specified in point 12.2, calculations, which will permit to evaluate the influence of the measurement conditions. It is also possible to improve the contact of the electrode with the ground, for example by means of moistening of the place when the electrode is driven, its driving into the ground in another place or using a 80 cm electrode. Check also the test leads and make sure the insulation is not damaged and the contacts: test lead – banana plug – electrode are not corroded or loosened. In most cases the achieved resolution of the measurement is sufficient, but it is necessary to be conscious of the uncertainty the measurement is burdened with.

## Additional information displayed by the meter

<b><math>R_E &gt; 9999\Omega</math></b>	Measurement range exceeded.
<b><math>U_N &gt; 100V</math>, <math>&gt; 100V</math></b> and a continuous sonic signal  , <b>'NOISE!'</b> and 	The voltage on the measurement points exceeds 100 V, the measurement is blocked.
<b><math>U_N xxV</math>, <math>&gt; 40V</math></b> and a continuous sonic signal  , <b>'NOISE!'</b> and 	Where xx is the value of interfering voltage. The voltage on the measurement points exceeds 40 V, the measurement is blocked.
<b><math>U_N xxV</math>, <math>&gt; 24V</math>,</b> <b>'NOISE!'</b> and 	Where xx is the value of interfering voltage. The voltage on the measurement points exceeds 24 V, but it's below 40 V, the measurement is blocked.
<b>'NOISE!'</b>	The value of the interfering signal is below 24 V, but it has too high value, so the result may be distorted by additional uncertainty.
<b>LIMIT!</b> and <b>ER</b> along with % value	The uncertainty caused by resistance of the electrodes > 30%. (Uncertainties calculated on the basis of the measured values.)
<b>LIMIT!</b> and <b>R<sub>H</sub></b> or <b>R<sub>s</sub></b> along with $\Omega$ value	The resistance of H and S electrodes, or one of them exceeds 19.9 k $\Omega$ , the proper measurement is not possible.
Flashing symbols: 	Flashing symbols E or H or S, or both of them, or all three at the same time – one or two or three test leads are disconnected from the measurement sockets.
Flashing clamp  symbol	Current clamp disconnected or the current value measured by the clamp is too low.
<b>I<sub>L</sub> xxA</b> , <b>I &gt; 3A</b> , 	Interfering current exceeds 3 A – the measurement is not possible.

## 4.6 Earth resistance measurement with two-clamp method (2C)

Two-clamp measurement is applied where there is no possibility of using auxiliary electrodes.

**NOTE!**

The two-clamp method may be used solely in the case of multiple earthing systems.

①



Use << or >> button to start the meas-

urement of  $\Lambda\Lambda$  (LED  is on). The meter is in the mode of noise voltage measurement between measurement points and also it measures the current flowing through the receiving clamp.

②

Connect test leads according to the drawing.

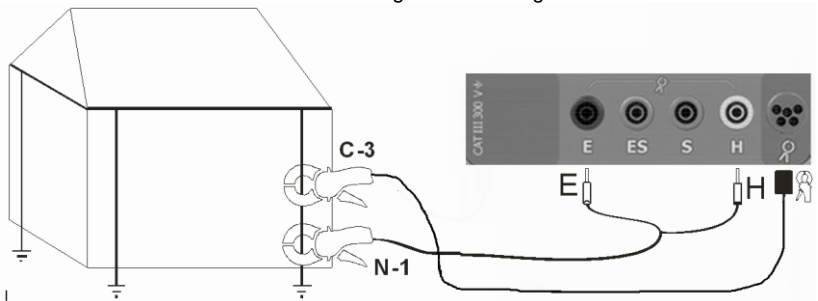

Connect the transmission clamp to sockets **H** and **E**, while the measurements clamp should be connected to the clamp socket  $\Lambda$ .

Attach the transmission clamp and the measurement clamp around the tested earth electrode at least 30 cm from each other.

③

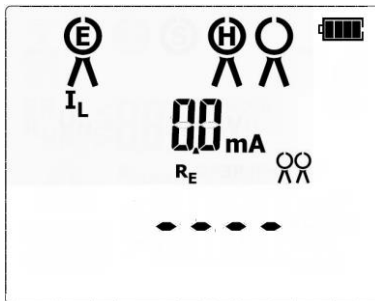

The meter is ready for measurement.



4



Press **START** to commence measurement.

5

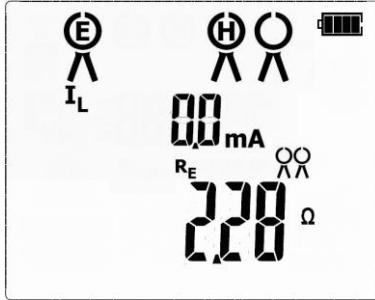

Upon completing the measurement read out the result and the value of the leakage current.

The result is displayed for 20 s. It may be displayed again when **ENTER** is pressed.



### Note:



**Measurements may be performed in the presence of interference current not exceeding 3 A and whose frequency complies with the value set in the MENU.**

- The clamps are not the part of the meter's standard accessories, they are to be purchased separately.
- The clamps must be calibrated before it is used for the first time. It may be periodically calibrated in order to avoid the influence of the ageing elements upon the resolution of measurements. The clamp calibration option is described in point 4.7.

### Additional information displayed by the meter

<b>R<sub>E</sub>&gt;99,9Ω</b>	Measurement range exceeded.
 Flashing clamp symbols	Transmitting clamp disconnected.
 Flashing clamp symbol	Receiving clamp disconnected, or the measured current value is too low.
<b>I<sub>L</sub> xxA , I&gt;3A, </b>	Interfering current exceeds 3 A – the measurement is not possible.

## 4.7 Calibration of the measurement clamp C-3

The additional C-3 clamp must be calibrated before the first use. It may be periodically calibrated in order to avoid the influence of the ageing elements on the measurements accuracy. The procedure of calibration must be carried out also after replacing clamp with the new one.



1

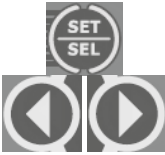

or:



While in  $\Omega\Omega$  mode (LED  is on) press **SET/SEL** button to enter the screen where the clamps calibration can be performed.

While is 3P+ $\Omega$  mode (LED  is on) press **SET/SEL** button to enter the screen where test voltage can be selected, then use  and  buttons to enter the screen where the measuring clamp calibration can be performed.

2

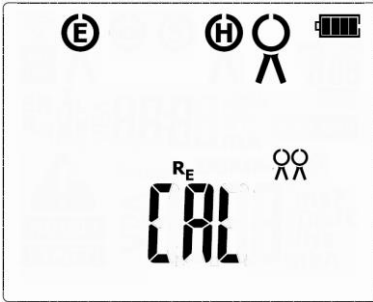

Flashing **CAL** message indicates the readiness to commence the clamp calibration procedure.

3

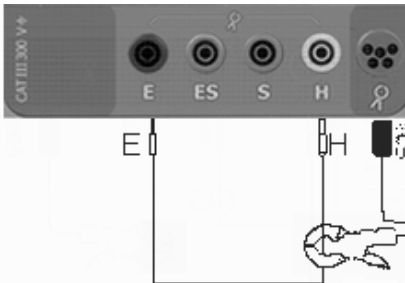

Bridge the 'E' and the 'H' terminals with the test lead and attach the clamp on in.

4



Press **START** button.

The meter has determined the correction factor for connected clamp. The factor is saved in the memory also when the power supply of the meter is off until the following successful calibration of the clamp has been performed.

5

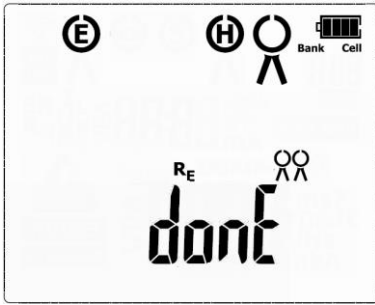

When the **done** is displayed on the screen, the clamp calibration procedure is completed.

6



or





After 20 seconds the meter will automatically return to the standby screen where the measurement can be started. Press **ESC** or **ENTER** to skip the waiting time and return to the standby screen immediately.

**Note:**

- Make sure the test lead passes centrally through the clamp.

**Additional information displayed by the meter**

<p>Flashing symbols:            and following message:  <b>oPEn</b></p>	<p>Flashing symbols E and H – calibration lead disconnected.</p>
<p>Flashing clamp            symbol</p>	<p>Measurement clamp disconnected.</p>

## 4.8 Measurement of resistance of earth connection and equipotential bonding ( $R_{CONT}$ )

### Note:

The measurement complies with the requirements specified in the standard EN 61557-4 ( $U < 24V$ ,  $I > 200mA$  and  $R \leq 10\Omega$ ).

1



Use << or >> button to start the meas-

urement of  $R_{CONT} 200mA$  (LED  $R_{CONT} 200 mA$  is on). The meter is in the mode of noise voltage measurement between measurement points.

Connect test leads according to the drawing.

2

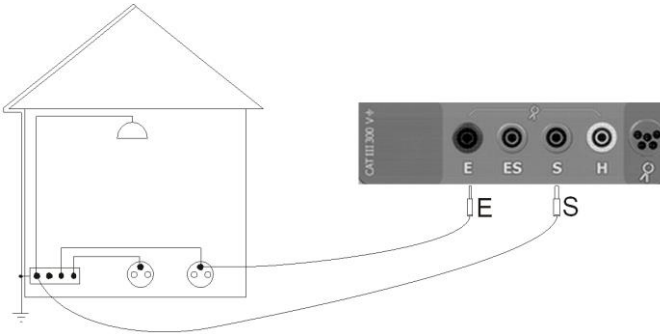

3

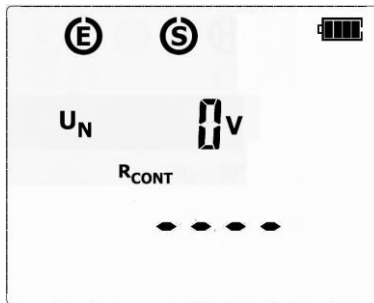

The meter is ready for measurement.

4



Press **START** to commence measurement.

5

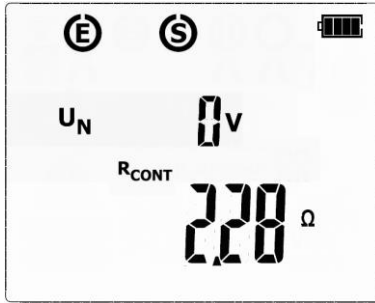

Upon completing the measurement read out the result and the value of the interfering voltage.

The result is displayed for 20 s. It may be displayed again when **ENTER** is pressed.

### Additional information displayed by the meter

<b>R&gt;1999Ω</b>	Measurement range exceeded.
<b>U<sub>N</sub> &gt;100V, &gt;100V</b> and a continuous sonic signal ↵, 'NOISE!' and ⚠	The voltage on the measurement points exceeds 100 V, the measurement is blocked.
<b>U<sub>N</sub> xxV, &gt;40V</b> and a continuous sonic signal ↵, 'NOISE!' and ⚠	Where xx is the value of interfering voltage. The voltage on the measurement points exceeds 40 V, the measurement is blocked.
<b>U<sub>N</sub> xxV, &gt;3V, 'NOISE!'</b> and ⚠	Where xx is the value of interfering voltage. The voltage on the measurement points exceeds 3 V, but it's below 40V, the measurement is blocked.
<b>'NOISE!'</b>	The value of the interfering signal is below 3 V, but it has too high value, so the result may be distorted by additional uncertainty.

## 4.9 Calibration of the test leads for $R_{CONT}$ measurement

In order to eliminate the influence of the resistance of the test leads over the result of the  $R_{CONT}$  measurement, it is advised to perform its compensation (auto-zeroing). This function is available while in  $R_{CONT}$  measurement mode.

1



In  $R_{CONT}$  mode (LED  $R_{CONT}$  200 mA is on) press **SET/SEL** to switch into test leads auto-zeroing mode.

2

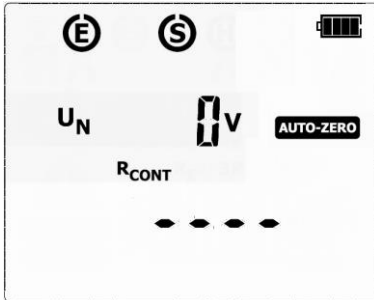

Flashing **AUTO-ZERO** message indicates the readiness to commence the test leads calibration procedure.

Connect test leads according to the drawing.

**Short-circuit the test leads connected to 'E' and 'S' sockets.**

3

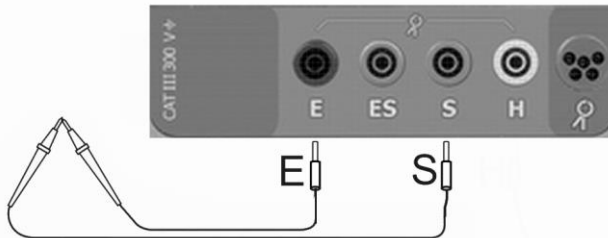

4



Press **START** button.

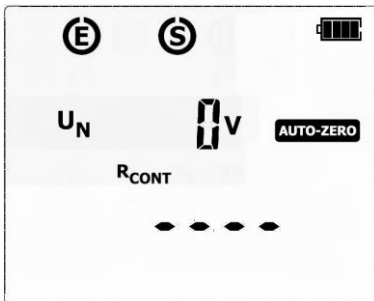

5



When **AUTO-ZERO** is displayed on the screen, the test leads calibration procedure is completed.







The result is compensated value, and the correction is available for  $R_{CONT}$ . The compensation is also active after switching the meter off and on (it is indicated by the **AUTO-ZERO** being displayed on screen).

- 6 In order to delete compensation (restore default calibration) proceed with the above steps with open (not shorted) test leads. In the place where the result is expected **OFF** message will appear (test leads compensation is now deactivated). When the procedure is completed **AUTO-ZERO** message will disappear from the screen.

- 7  or  After 20 seconds the meter will automatically return to the standby screen where the measurement can be started. Press **ESC** or **ENTER** to skip the waiting time and return to the standby screen immediately.

## 4.10 Earth resistivity measurement ( $\rho$ )

For the purpose of earth resistivity measurements – which are used as a preliminary measure for the project of earthing systems or in geology - there is a separate function: earth resistivity measurements  $\rho$ . The function is metrologically identical as the four-pole earth resistance measurement, but it includes an additional procedure of storing of the distance between the electrodes. The result of the measurement is the resistance value which is calculated automatically in accordance with the following formula:  $\rho = 2\pi LR_E$ , which is used in the Wenner's measurement method. The method in question assumes equal distances between electrodes.

- 1 Use **<<** or **>>** buttons to switch into earth resistivity measurement mode  $\rho$  (LED  is on). The meter is in the mode of noise voltage measurement between measurement points and also it measures the current flowing through the receiving clamp.
- 2  Press **SET/SEL** button to switch into mode of selecting the distance between the auxiliary electrodes.
- 3  Use **▲** and **▼** to set the distance between the auxiliary electrodes. From 1 to 50 m, with 1 m step, or from 1 to 150 ft, with 1 ft step.
- 4  Use **▶** to switch into the mode for selecting test voltage.
- 5  Use **▲** and **▼** to set the measurement voltage value of 25 V or 50 V
- 6  or  Press **ENTER** to confirm settings or press **ESC** to exit without saving the changes.

Connect test leads according to the drawing.

7

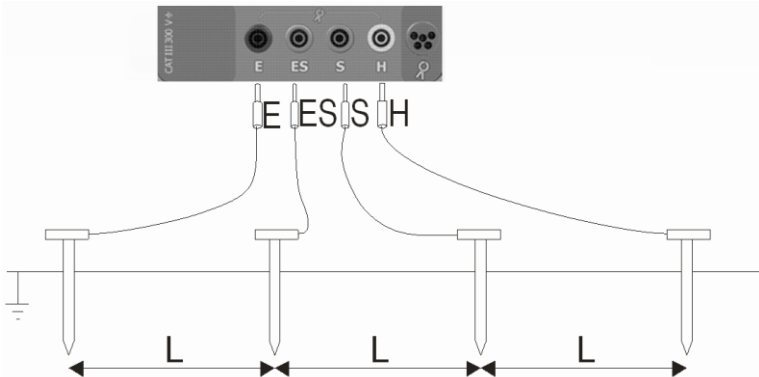

Connect the four aligned and equally spaced electrodes, which are driven into the ground, to the meter, and do so in accordance with the diagram above:  
 Connect the current electrode driven into ground to the **H** socket of the meter,  
 Connect the voltage electrode driven into ground to the **S** socket of the meter,  
 Connect the voltage electrode driven into ground to the **ES** socket of the meter,  
 Connect the current electrode driven into ground to the **E** socket of the meter.

8

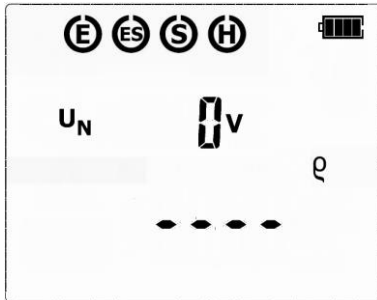

The meter is ready for measurement.

9



Press **START** to commence measurement.

10

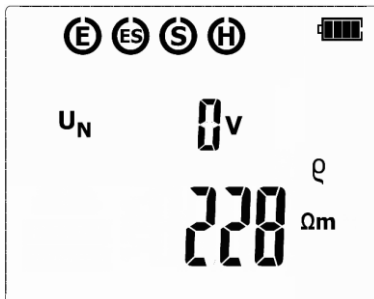



After finishing the measurement, read out the result. The results of all the measurements that have been carried out will be displayed on screen.



11



Use  and  to toggle between the measurement result components:

$R_H$  – resistance of current electrode

$R_S$  – resistance of voltage electrode

$ER$  – additional uncertainty caused by the resistance of the electrodes

$U_N$  – interfering (noise) voltage

The result is displayed for 20 s. It may be displayed again when **ENTER** is pressed.

## Note:



**Earth resistivity measurement may be performed if the interference voltage does not exceed 24 V. The interference voltage is measured up to 100 V, but over 40 V is it signalled as hazardous.**





**Do not connect the meter to a voltage exceeding 100 V.**

- Calculations are based upon the assumption that the distances between the specific measurement electrodes are equal (the Wenner's method). If this is not the case the earthing resistance measurement must be carried out by means of the four-pole method and calculations must be performed individually.

- Pay particular attention to the quality of the connection of the tested object with the test leads – the contact area must be cleaned of paint, rust, etc.

- If the resistance of the auxiliary electrodes is too high, then the measurement of the  $R_E$  earth electrode will be distorted by additional uncertainty. A particularly high measurement uncertainty is generated if we measure a low value of the earth resistance with electrodes of a loose contact with the soil (such a situation occurs often if the earth electrode is properly made and the upper layer of the ground is dry and characterized by a low conductivity). Then the relation between the electrode resistance and the resistance of the measured earthing is very high, and so is the case of the measurement uncertainty which depends on it. What may be done then is to perform, in accordance with the formulae specified in point 12.2, calculations, which will permit to evaluate the influence of the measurement conditions. It is also possible to improve the contact of the electrode with the ground, for example by means of moistening of the place when the electrode is driven, its driving into the ground in another place or using a 80 cm electrode. Check also the test leads and make sure the insulation is not damaged and the contacts: test lead – banana plug – electrode are not corroded or loosened. In most cases the achieved resolution of the measurement is sufficient, but it is necessary to be conscious of the uncertainty the measurement is burdened with.

## Additional information displayed by the meter

$\rightarrow$ xxxk $\Omega$ m or $\rightarrow$ xxxk $\Omega$ ft	Measurement range exceeded, where xxx is maximum value that can be measured for the selected settings.
$U_N > 100V, > 100V$ and a continuous sonic signal $\leftarrow$ , 'NOISE!' and 	The voltage on the measurement points exceeds 100 V, the measurement is blocked.
$U_N$ xxV, >40V and a continuous sonic signal $\leftarrow$ , 'NOISE!' and 	Where xx is the value of interfering voltage. The voltage on the measurement points exceeds 40 V, the measurement is blocked.
$U_N$ xxV, >24V, 'NOISE!' and 	Where xx is the value of interfering voltage. The voltage on the measurement points exceeds 24 V, but it's below 40 V, the measurement is blocked.
'NOISE!'	The value of the interfering signal is below 24 V, but it has too high value, so the result may be distorted by additional uncertainty.
<b>LIMIT!</b> and ER along with % value	The uncertainty caused by resistance of the electrodes > 30%. (Uncertainties calculated on the basis of the measured values.)
<b>LIMIT!</b> and R <sub>H</sub> or R <sub>s</sub> along with $\Omega$ value	The resistance of H and S electrodes, or one of them exceeds 19,9 k $\Omega$ , the proper measurement is not possible.
Flashing symbols: 	Flashing symbols E or ES or H or S, or two of them, or three, or all of them at the same time – one or two or three or four test leads are disconnected from the measurement sockets.

## 5 Memory of measurement results

The MRU-30 meter has memory divided into 10 banks of 99 cells each. Thanks to dynamic memory allocation, each of the memory cells can contain different quantity of single measurement results, depending on the needs. Optimal use of the memory can be ensured in this way. Each measurement result can be stored in a memory cell marked with a selected number and in a selected memory bank. Thanks to this, the user of the meter can, at his/her option, assign memory cell numbers to individual measurement points and the memory bank numbers to individual facilities. The user may also perform measurements in any chosen sequence and repeat them without losing other data.

Memory of measurement results **is not deleted** when the meter is switched off. Thanks to this, the data can be later read or sent to a computer. The number of a current memory cell or memory bank is not changed either.

### Note:

Results of single measurement can be stored in one memory cell.

- After entering the measurement result, the ID number of the cell is automatically increased.
- It is recommended to delete the memory after reading the data or before performing a new series of measurements that may be stored into the same memory cells as the previous ones.

### 5.1 Storing the measurement results in the memory

①



After completing measurement press **ENTER**. The meter will turn into mode for test results storing.

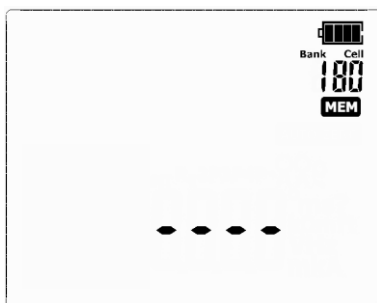

The cell is empty.

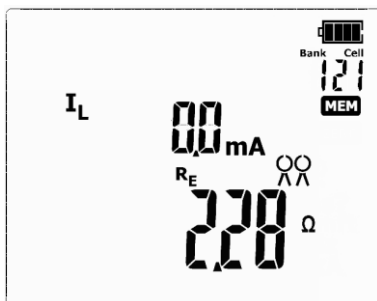

The cell is occupied by the same type of result, which is to be entered.

2



Use ← and → buttons to preview the results stored in the selected cell. If any.

To change the cell number or bank number:

3



When the cell number is flashing, use ↑ and ↓ buttons to set the desired number of the cell.

4



Press **SET/SEL** button – bank number is flashing.

5



Use ↑ and ↓ buttons to set the desired number of the bank.

6



After selecting the desired bank and cell, press **ENTER** button, to save the result in the memory. Recording is indicated by a triple beep sound.



Press **ESC** to return to the measurement screen without saving.

If you try to store data in an occupied memory cell, the following warning message will appear: **OVER ?**:



7



or



Press **ENTER**, to overwrite the result or **ESC**, to cancel and select other cell or bank.

## Note:

- After the measurement, its result is shown on the display for 20 s or until:
  - the measurement function is changed,
  - Auto-OFF function is activated,
  - the meter detects interference voltage >50 V,
  - one of the following operations is performed:
    - **ESC** button is pressed to exit to the voltmeter,
    - next measurement is performed,
    - an entry into the memory is introduced.
- After exiting to the voltmeter by pressing **ESC**, or after 20 s have gone by or after the test results have been stored into the memory, the last result may be recalled by pressing **ENTER**.
- **Complete set of results (main result and supplementary results) for a given measuring function and preset measurement settings are stored in the memory.**

### 5.2 Viewing memory data

①



Use << or >> to browse the memory: **MEM**  
(LED  is on).

②



Use ← and → buttons to preview the test results components stored in the selected cell, if any exist.

To change the cell number or bank number:

③



When the cell number is flashing, use ↑ and ↓ buttons to set the desired number of the cell.

④



Press **SET/SEL** button – bank number is flashing.

⑤



Use ↑ and ↓ buttons to set the desired number of the bank.

- Viewing test results components is disabled for **R<sub>CONT</sub>** and **R<sub>E2P</sub>** measurements.

## 5.3 Deleting memory data

You can delete the entire memory or its individual cells or banks.

### 5.3.1 Deleting cell data

①



Use << or >> to browse the memory:

MEM (LED  is on).

②

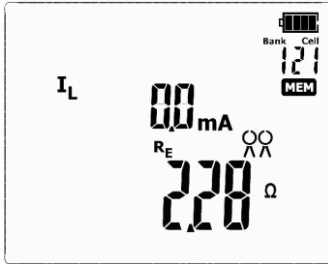

Set the cell number to be deleted acc. to point 5.2.

③



Press **ENTER** button.



then symbol **dEL ?** will be displayed to indicate the readiness for deleting.

④



Press **ENTER** button.



 and **dEL Conf ?** symbols appear, asking you to confirm deletion.

5



Press **ENTER** button again to delete the selected cell.  
After deleting the cell, the meter beeps three times. Press **ESC** to cancel and return to memory browsing more

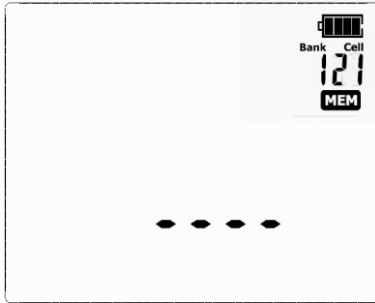

The contents of the cell has been deleted.

### 5.3.2 Deleting bank data

1



Use << or >> to browse the memory:

**MEM** (LED  **MEM** is on).

2

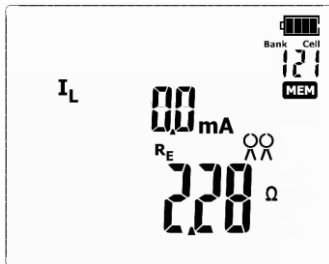

Set the bank number to be deleted acc. to point 5.2.  
Set the **cell number** as '- -' (before "01") below screen will appear.

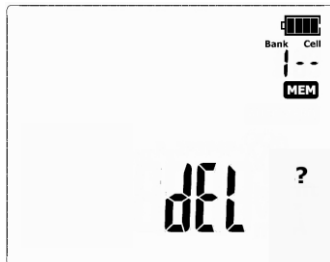

then symbol **DEL ?** will be displayed to indicate the readiness for deleting.

3



Press **ENTER** button.



 and **dEL Conf ?** symbols appear, asking you to confirm deletion.

4



or



Press **ENTER** button again to delete the selected bank.

After deleting the bank, the meter beeps three times. Press **ESC** to cancel and return to memory browsing mode.

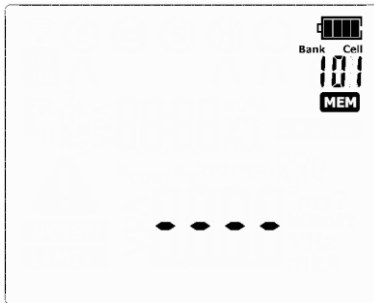

The content of the bank has been deleted.



### 5.3.3 Deleting the whole memory

①



Use << or >> to browse the memory: **MEM** (LED  is on).

②

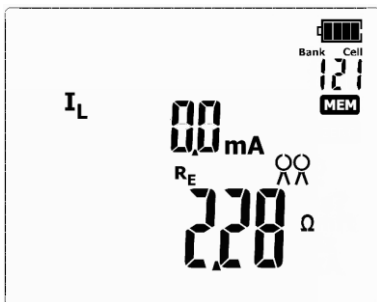

Set the **bank number** as '- -' (before '0')....

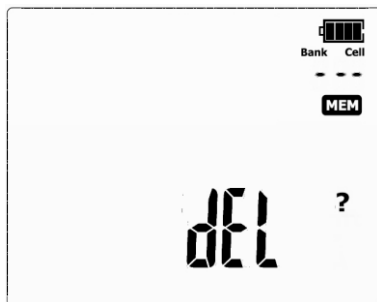

... the bank number will change into '- -', then symbol **dEL ?** will be displayed to indicate the readiness for deleting the whole memory.

③



Press **ENTER** button.



 and **dEL Conf ?** symbols appear, asking you to confirm deletion.

4



Press **ENTER** again.  
After deleting the memory, the meter beeps three times. Press **ESC** to cancel and return to memory browsing mode.



The entire contents of the memory has been deleted.

## 6 Data transmission

### 6.1 Computer connection accessories

What is necessary in order to operate the meter with a computer is additional accessories, namely a USB cable and appropriate software. If the required accessories have not been purchased along with the meter, then they are available from the manufacturer or an authorized distributor.

The accessories may be used with other devices manufactured by SONEL S.A. which are equipped with the USB interface, or other (depending on the device).

Detailed information regarding software is available from the manufacturer or an authorized distributor.

### 6.2 Data transmission through USB port

1



Use << or >> to switch into memory browsing mode: **MEM** (LED  **MEM** is on).

2

Connect the cable to the USB port of the computer and the USB socket of the meter. The meter will display below message:

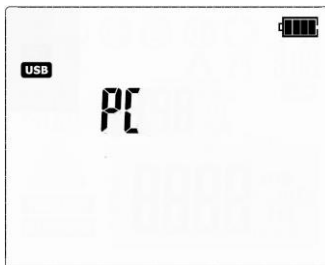

3

Start the program for communicating with the meter (processing results) and follow the commands of the software.

## 7 Firmware update

- 1 In accordance with the guidelines of Section 3 of this manual, enter the meter's firmware update mode: **UPdT**
- 2 Connect the cable to the USB port of the computer and the USB socket of the meter.



- 3 Run a program for updating the firmware and follow on-screen instructions.

## 8 Power supply of the meter

### 8.1 Monitoring the power supply voltage

The charge level of the batteries or rechargeable batteries is indicated by the symbol in the right upper corner of the display on a current basis:



rechargeable batteries are charged.

rechargeable batteries are nearly discharged.

No battery symbol on screen (with charger connected) indicates that the battery is either disconnected or corrupted.



Rechargeable batteries completely discharged.  
The meter switches off automatically after 5 seconds.

## 8.2 Charging the rechargeable battery pack

### CAUTION!

The MRU-30 meter is powered from SONEL battery pack, which includes NiMH 9.6 V batteries and it may be replaced only by the manufacturer's service department.

Battery charger is installed inside the meter and cooperates only with the manufacturer's rechargeable battery pack. The charger is powered by external power supply adapter. The device may be also powered from the car cigarette lighter socket (**12 V only**), using an optional charger.

Charging commences once the power supply has been connected to the meter regardless of the fact whether the meter is on or off, only the charging mode is different, as described below. When the meter is switched off - the charging process is indicated on the screen by displaying animated symbol of battery being charged; when the meter is switched on - the charging is indicated by blinking LED's of measurement functions (they blink consecutively in red).

Charging modes:

- the meter (user interface) is switched off: the battery pack is charged in 'quick charging' mode - the charging process takes approx. 4 hours. Completed charging is indicated by full battery symbol, **FULL** message and beep. In order to fully turn the device off, unplug the power charger.
- the meter (user interface) is switched on: the battery pack is charged in 'background charging' mode - the charging may be longer than the charging process of the device which is switched off. Completed charging is indicated by full battery symbol and beep. If the charging time exceeds 10 hours, the meter will automatically switch off for safety reasons.

In order to fully turn the device off, unplug the power charger and turn the meter off.

### CAUTION!

Do not power the meter from sources other than those listed in this manual.

### Note:

- Due to interferences in the mains, the process of battery pack charging may finish prematurely. When charging time is too short, turn off the meter and start charging again.

## Additional information displayed by the meter

Message	Cause	Proceeding
<b>Err ACU H°C</b>	The temperature of the batteries is too high.	Wait for the batteries to cool down. Start the charging procedure again.
<b>Err ACU L°C</b>	The temperature of the batteries is too low.	Wait for the batteries to warm up. Start the charging procedure again.
<b>Err ACU X</b> (where X is an error digit indicator)	Emergency.	Try to start the charging procedure again. While trying to get the power supply from the car lighting socket, verify if the 12 V voltage is present. If it doesn't help, contact the service, as the batteries may be corrupted.
<b>No battery symbol</b> (with connected battery charger)	Disconnected or corrupted batteries.	Contact the manufacturer's service department.

### 8.3 General principles of using Ni-MH batteries

- Store the accumulators in a dry, cool and well ventilated place and protect them from direct sunlight. The temperature of the environment in the case of prolonged storage should not exceed 30°C. If the accumulators are stored for a long time in a high temperature, then the occurring chemical processes may reduce their lifetime.
- Ni-MH batteries normally withstand 500-1000 charging cycles. The accumulators reach their maximum capacity after being formatted (2-3 charge and discharge cycles). The most important factor which influences the lifetime of the battery is the depth of discharge. The deeper the discharge of the battery, the shorter its lifetime.
- The memory effect is limited in the case of Ni-MH batteries. These batteries may be charged at any point with no serious consequences. However, it is recommended to discharge them completely every few cycles.
- During storage of Ni-MH batteries they are discharged at the rate of approximately 20% per month. Keeping them at high temperatures may accelerate this process even 100%. In order to prevent excessive discharge of batteries, after which it would be necessary to format them, it is recommended to charge the batteries from time to time (even if not in use).
- Modern fast chargers detect both too low and too high a temperature of batteries and react to the situation adequately. Too low a temperature should prevent the start of the process of charging, which might damage the battery irreparably. An increase of the temperature of the battery is a signal to stop charging and is a typical phenomenon. However charging at a high temperature of the environment apart from reducing the lifetime causes an accelerated increase of the temperature of the battery, which will be not charged to its full capacity.
- Remember that in the case of quick charging batteries are charged to approximately 80% of their capacity; better results may be obtained if the process of charging is continued: the charger goes then to the phase of charging with a low current and after next couple of hours the batteries are charged to their full capacity.
- Do not charge or use batteries in extreme temperatures. Extreme temperatures reduce the lifetime of batteries. Avoid placing devices powered from batteries in very hot environments. The nominal working temperature must be absolutely observed.

## 9 Cleaning and maintenance

### NOTE!

**Apply solely the maintenance methods specified by the manufacturer within the present manual.**

The casing of the meter may be cleaned with a soft, damp cloth using all-purpose detergents. Do not use any solvents or cleaning agents which might scratch the casing (powders, pastes, etc.).

Clean the auxiliary electrode with water and dry it. Before the electrode is stored for a prolonged period of time it is recommended to grease it with any machine lubricant.

The reels and test leads should be cleaned with water and detergents, and then dried.

The electronic system of the meter does not require maintenance.

## 10 Storage

In the case of storage of the device, the following recommendations must be observed:

- Disconnect all the test leads from the meter,
- Clean the meter and all its accessories thoroughly,
- Wind the long test leads onto the reels,
- In order to prevent a total discharge of the accumulators in the case of a prolonged storage, charge them from time to time.

## 11 Dismantling and disposal

Worn-out electric and electronic equipment should be gathered selectively, i.e. it must not be placed with waste of another kind.

Worn-out electronic equipment should be sent to a collection point in accordance with the law of worn-out electric and electronic equipment.

Before the equipment is sent to a collection point, do not dismantle any elements. Observe the local regulations concerning disposal of packages, worn-out batteries and accumulators.

## 12 Technical data

- The specified accuracy applies to meter terminals.
- The abbreviation 'm.v.' in the accuracy definition means the measured value.

### 12.1 Basic data

#### Measurement of interference voltage $U_N$ (RMS)

Range	Resolution	Accuracy
0...100 V	1 V	$\pm(5\% \text{ m.v.} + 2 \text{ digits})$

- measurement for  $f_N$  45...65 Hz
- frequency of measurements – minimum two measurements/s

#### Measurement of earth resistance – 2-pole method ( $R_{E2P}$ )

Range	Resolution	Accuracy
0,01 $\Omega$ ...19,99 $\Omega$	0,01 $\Omega$	$\pm(3\% \text{ m.v.} + 3 \text{ digits})$
20,0 $\Omega$ ...199,9 $\Omega$	0,1 $\Omega$	
200 $\Omega$ ...1999 $\Omega$	1 $\Omega$	$\pm 5\% \text{ m.v.}$
2000 $\Omega$ ...9999 $\Omega$	1 $\Omega$	$\pm 8\% \text{ m.v.}$

#### Measurement of earth resistance – 3-pole method ( $R_{E3P}$ ), 4-wire method ( $R_{E4P}$ )

The measurement method: 3-pole, in accordance with IEC 61557-5.

Range of measurement in acc. with IEC 61557-5: 0,53 $\Omega$  .... 9999 $\Omega$  for 50 V test voltage.

Range of measurement in acc. with IEC 61557-5: 0,68 $\Omega$  .... 9999 $\Omega$  for 25 V test voltage.

Range	Resolution	Accuracy
0,00 $\Omega$ ...19,99 $\Omega$	0,01 $\Omega$	$\pm(3\% \text{ m.v.} + 3 \text{ digits})$
20,0 $\Omega$ ...199,9 $\Omega$	0,1 $\Omega$	
200 $\Omega$ ...1999 $\Omega$	1 $\Omega$	$\pm 5\% \text{ m.v.}$
2000 $\Omega$ ...9999 $\Omega$	1 $\Omega$	$\pm 8\% \text{ m.v.}$

#### Measurement of resistance of auxiliary electrodes $R_H$ and $R_S$

Range	Resolution	Accuracy
0...999 $\Omega$	1 $\Omega$	$\pm(5\% (R_S+R_E+R_H) + 8 \text{ digits})$
1,00...9,99 k $\Omega$	0,01k $\Omega$	
10,0...19,9 k $\Omega$	0,1k $\Omega$	

### Measurement of earth resistance – 3-pole method with additional clamp (R<sub>E3P+C</sub>)

Range	Resolution	Accuracy
0,00...19,99 Ω	0,01Ω	±(3% m.v. + 3 digits)
20,0...199,9 Ω	0,1Ω	
200...1999 Ω	1 Ω	±5% m.v.
2000...9999 Ω	1 Ω	±8% m.v.

### Measurement of multiple earth resistance – two-clamp method (2C)

Range	Resolution	Accuracy
0,00...19,99 Ω	0,01Ω	±(10% m.v. + 8 digits)
20,0...99,9 Ω	0,1Ω	±(20% m.v. + 3 digits)

### Measurement of leakage current in functions utilizing C-3 clamp

Range	Resolution	Accuracy
0,1...99,9 mA	0,1 mA	±(8% m.v. + 5 digits)
100...999 mA	1 mA	±(8% m.v. + 3 digits)
1,00...5,00 A	0,01 A	±(5% m.v. + 5 digits)

- measurement for f<sub>N</sub> 45...65 Hz

### Measurement of resistance of earth connection and equipotential bonding (R<sub>CONT</sub>)

The measurement method: technical, in accordance with IEC 61557-4

Range of measurement in accordance with IEC 61557-4: 0,13 Ω .... 1999 Ω

Range	Resolution	Accuracy
0,00...9,99 Ω	0,01 Ω	±(2% m.v. + 3 digits)
10,0...99,9 Ω	0,1 Ω	
100...1999 Ω	1 Ω	

### Earth resistivity measurement (ρ)

The measurement method: Wenner's,  $\rho = 2\pi LR_E$

Range	Resolution	Accuracy
0,00...9,99 Ωm	0,01 Ωm	Depends on the basic uncertainty of the R <sub>E</sub> 4P measurement but not less than ±1 digit.
10,0...99,9 Ωm	0,1 Ωm	
100...999 Ωm	1 Ωm	
1,00...9,99 kΩm	0,01 kΩm	
10,0...99,9 kΩm	0,1 kΩm	
100...999 kΩm	1 kΩm	

- distance between auxiliary electrodes (L): 1...50 m or 1...150 ft





### 12.3 Additional data

Data regarding additional uncertainties are useful mainly in the case the meter is used under non-standard conditions as well as for measurement laboratories for the purpose of calibration.

#### 12.3.1 Influence of the serial interference voltage $U_z$ on earth resistance measurements for methods $R_E3P$ , $R_E4P$ , $R_E3P+C$ , $\rho$

$R_E$	$U_N$	Additional uncertainty [ $\Omega$ ]
0,00...10,00 $\Omega$	25 V	$\pm(0,001R_E+0,01)U_z+0,007U_z^2$
	50 V	$\pm(0,001R_E+0,01)U_z+0,004U_z^2$
10,01...2000 $\Omega$	25 V, 50 V	$\pm(0,001R_E+0,01)U_z+0,001U_z^2$
2001...9999 $\Omega$	25 V, 50 V	$\pm(0,003R_E + 0,4)U_z$

#### 12.3.2 Influence of the auxiliary electrodes on earth resistance measurements for methods $R_E3P$ , $R_E4P$ , $R_E3P+C$ , $\rho$

$R_H, R_S$	Additional uncertainty [%]
$R_H \leq 5 \text{ k}\Omega$ and $R_S \leq 5 \text{ k}\Omega$	$\pm \left( \frac{R_S}{R_S + 100000} \cdot 150 + \frac{R_H \cdot 0,004}{R_E} + 1,5 \cdot 10^{-8} \cdot R_H^2 \right)$
$R_H > 5 \text{ k}\Omega$ or $R_S > 5 \text{ k}\Omega$ or $R_H$ and $R_S > 5 \text{ k}\Omega$	$\pm \left( 7,5 + \frac{R_H \cdot 0,004}{R_E} + 1,5 \cdot 10^{-8} \cdot R_H^2 \right)$

$R_E[\Omega]$ ,  $R_S[\Omega]$  and  $R_H[\Omega]$  are values which are displayed by the device.

#### 12.3.3 Influence of the interference current $I_z$ on the result of the earth resistance for method $R_E3P+C$

The MRU-30 meter may perform a measurement, if the value of the interference current does not exceed 3 A RMS and the frequency complies with the value set in the MENU.

$R_E$	Additional uncertainty [ $\Omega$ ]
0,00...50,00 $\Omega$	$\pm (0,03R_E \cdot I_z^2)$
50,01...2000 $\Omega$	$\pm (0,0009 \cdot R_E \sqrt{R_E} \cdot I_z^2)$
2001...9999 $\Omega$	$\pm (9 \cdot 10^{-7} \cdot R_E^2 \cdot I_z(I_z + 15))$

If the interference current exceeds 3 A the possibility of measurement is blocked.

### 12.3.4 Influence of interference current on the result of the earth resistance measurement for two-clamp method (2C)

The MRU-30 meter may perform a measurement, if the value of the interference current does not exceed 3 A RMS and the frequency complies with the value set in the MENU.

$R_E$	Additional uncertainty [ $\Omega$ ]
0,00....10,00 $\Omega$	$0,03R_E^2I_Z$
10,01....99,99 $\Omega$	$0,0004R_E^2I_Z(I_Z+10)$

If the interference current exceeds 3 A the possibility of measurement is blocked.

### 12.3.5 Influence of the relation of the resistance measured with clamp for the multiple earthing branch to the resultant resistance ( $R_{E3P+C}$ )

$R_C$	Additional uncertainty [ $\Omega$ ]
$\leq 50 \Omega$	$\pm (0,003 \frac{R_C}{R_W^2})$
$> 50 \Omega$	$\pm (0,5 \frac{R_C}{\sqrt{R_W}})$

$R_C[\Omega]$  is the value of the resistance measured with clamps for the branch displayed by the device, and  $R_W[\Omega]$  is the value of the resultant multiple earth resistance.

### 12.3.6 Additional uncertainties in accordance with IEC 61557-5 ( $R_{E3P}$ , $R_{E4P}$ )

Influencing factor	Symbol	Additional uncertainty
Location	$E_1$	0%
Power supply voltage	$E_2$	0% ( <b>batt</b> not displayed)
Temperature	$E_3$	$\pm 0,2$ digits/ $^{\circ}\text{C}$ for $R < 1 \text{ k}\Omega$ $\pm 0,07\%$ / $^{\circ}\text{C}$ $\pm 0,1$ digits/ $^{\circ}\text{C}$ for $R \geq 1 \text{ k}\Omega$
Serial interference voltage	$E_4$	In accordance with formulas in 10.2.1 ( $U_N=3 \text{ V } 50/60 \text{ Hz}$ )
Resistance of electrodes and auxiliary earth electrodes	$E_5$	In accordance with formula in 10.2.3

## 13 Manufacturer

The manufacturer of the device, which also provides warrantee and post-warrantee service is the following company:

**SONEL S.A.**  
 Wokulskiego 11  
 58-100 Świdnica  
 Poland  
 tel. +48 74 884 10 53 (Customer Service)  
 e-mail: [customerservice@sonel.com](mailto:customerservice@sonel.com)  
 web page: [www.sonel.com](http://www.sonel.com)

**Attention:**  
**Service repairs must be carried out solely by the manufacturer.**





**SONEL S.A.**

Wokulskiego 11  
58-100 Świdnica  
Poland

**Customer Service**

tel. +48 74 884 10 53  
e-mail: [customerservice@sonel.com](mailto:customerservice@sonel.com)

[www.sonel.com](http://www.sonel.com)