

BRIEF USER MANUAL

METER FOR ELECTRICAL INSTALLATION PARAMETERS

MPI-540 • MPI-540-PV

MPI-540 • MPI-540-PV

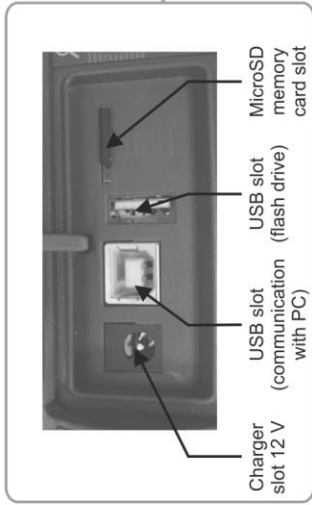

Clamps slots
I1, I2, I3 - recorder
 R_e - measurement
of earth systems

Measuring
terminals

Recorder N socket











ES socket for measuring
earth resistance and soil
resistivity



Starting
the measurement
procedure

Contact
electrode

Touchscreen

-  Back
-  Save
-  Show last measurement
-  Return to main menu
-  Select item
-  Show more icons
-  Add item
-  Edit item
-  Search
-  Remove item
-  Close menu



BRIEF USER MANUAL

METER FOR ELECTRICAL INSTALLATION PARAMETERS MPI-540 • MPI-540-PV



**SONEL S.A.
Wokulskiego 11
58-100 Świdnica
Poland**

**Full version of the manual is provided
on the manufacturer's website**

Version 2.09 16.10.2023

CONTENTS

1 Security	5
2 Main menu	6
2.1 Meter settings.....	7
2.2 Measurement settings.....	7
2.2.1 Sub-menu Measurements.....	7
2.2.2 MPI-540-PV Sub-menu PV modules.....	8
2.3 Communication	9
2.3.1 USB communication	9
2.3.2 MPI-540-PV Connection with an irradiance meter.....	9
2.4 Regional settings	9
3 Measurements	10
3.1 Checking the correctness of PE (protective earth) connections	11
3.2 Fault loop parameters	12
3.2.1 Fault loop parameters in the L-N and L-L circuits.....	12
3.2.2 Fault loop parameters in the L-PE circuit.....	12
3.2.3 Fault loop impedance in L-PE circuit protected with a residual current device (RCD)	13
3.2.4 Measurement of fault loop impedance in IT networks	14
3.3 Voltage drop.....	15
3.4 Resistance-to-earth.....	16
3.4.1 Earth resistance measurement with 3-pole method (R_{E3P}).....	16
3.4.2 Earth resistance measurement with 4-wire method (R_{E4P}).....	17
3.4.3 Earth resistance measurement with 3-pole method with additional clamp (R_{E3P+C})	18
3.4.4 Earth resistance measurement with two-clamp method (2C)	19
3.5 Soil resistivity	20
3.6 RCD parameters	21
3.6.1 Measurements in IT networks.....	22
3.7 Automatic measurements of RCD parameters.....	23
3.7.1 Setting automatic measurements of RCD parameters	23
3.7.2 Automatic measurement of RCD parameters.....	24
3.8 Insulation resistance	26
3.9 Low-voltage measurement of resistance	28
3.9.1 Measurement of resistance.....	28
3.9.2 Measurement of resistance of protective conductors and equipotential bonding with ± 200 mA current.....	28
3.10 Sequence of phases	29
3.11 Motor rotation direction	30
3.12 Illuminance.....	31
3.13 MPI-540-PV Resistance-to-earth (PV).....	31
3.14 MPI-540-PV Insulation resistance (PV)	32
3.15 MPI-540-PV Continuity of connections (PV).....	32
3.16 MPI-540-PV Open circuit DC voltage U_{oc}	33
3.17 MPI-540-PV Short circuit DC current I_{sc}	34
3.18 MPI-540-PV Test of the inverter panel η , P, I	35
3.18.1 Measurement configuration.....	36
3.18.2 Live mode.....	37
3.19 MPI-540-PV Resetting C-PV clamp.....	38
3.20 MPI-540-PV Irradiance and temperature.....	38

4	Auto measurements	39
4.1	Proceeding auto measurements	39
4.2	Creating measurement procedures.....	41
5	Recorder	43
5.1	Functional description	43
5.2	Main elements of the screen	45
5.2.1	Main menu.....	45
5.2.2	Information bar on the parameters of the current network.....	46
5.2.3	Help.....	46
5.3	Connecting the measuring system.....	46
5.3.1	Measuring arrangements	46
5.3.2	Recording configuration.....	49
5.4	Analyzer settings.....	51
5.5	LIVE mode of the network.....	51
5.5.1	Transient waveforms of current and voltages (waveforms)	51
5.5.2	Timeplot of effective values	52
5.5.3	"Live" mode - tabular view	52
5.5.4	Vector diagram of fundamental components (phasor).....	53
5.5.5	Harmonics graph/table.....	53
5.6	Switching the recording on/off.....	53
5.7	Recording analysis.....	54
5.8	Energy loss calculator.....	55
5.8.1	Functional description.....	55
5.8.2	Configuration of the loss calculator	56
5.9	Inverter efficiency.....	56
6	Memory of the meter.....	57
6.1	Memory of measurements	57
6.1.1	Memory settings	57
6.1.2	Structure of the memory	58
6.1.3	Entering the measurement result.....	58
6.2	Recorder memory	59
6.2.1	MicroSD memory card	59
6.2.2	USB external memory (flash drive)	59
6.2.3	Compatibility with Sonel Analysis software	59
6.2.4	PC connection and data transmission.....	60
7	Power supply.....	60
7.1	Monitoring of the battery charge status.....	60
7.2	Replacing rechargeable batteries	60
7.3	Charging the rechargeable batteries.....	60
8	Technical data	61
8.1	Basic data	61
8.1.1	Measurement of alternating voltages (True RMS).....	61
8.1.2	Frequency measurement	61
8.1.3	Measurement of fault loop impedance Z_{L-PE} , Z_{L-N} , Z_{L-L}	61
8.1.4	Measurement of fault loop impedance $Z_{L-PE RCD}$ (without triggering of RCD)	62
8.1.5	Measurement of parameters of RCD	62
8.1.6	Measurement of resistance-to-earth R_E	63
8.1.7	Low-voltage measurement of continuity of circuit and resistance.....	64
8.1.8	Measurement of insulation resistance.....	64
8.1.9	Light measurements	65

8.1.10	Phase sequence.....	66
8.1.11	Motor rotation.....	66
8.1.12	MPI-540-PV Measurement of open circuit DC voltage U_{oc}	66
8.1.13	MPI-540-PV Measurement of short circuit DC current I_{sc}	66
8.2	Recorder data.....	66
8.2.1	Inputs.....	66
8.2.2	Sampling and RTC.....	67
8.2.3	Voltage measurement.....	67
8.2.4	Measurement of current (True RMS).....	68
8.2.5	Frequency measurement.....	68
8.2.6	Measuring harmonics.....	69
8.2.7	Unbalance.....	69
8.2.8	Power and energy measurement.....	69
8.3	Other technical data.....	70

1 Security

MPI-540 meter is designed for performing check tests of protection against electric shock in AC mains systems and recording mains systems parameters. The meter is used for performing measurements and providing results to determine the level safety of electrical installations. Therefore, in order to provide conditions for correct operation and accuracy of obtained results, the following recommendations must be observed:

- Before you proceed to operate the meter, familiarise yourself thoroughly with this manual and observe the safety regulations and specifications provided by the manufacturer.
- Any application that differs from those specified in this manual may result in a damage to the device and constitute a source of danger for the user.
- MPI-540 meters must be operated only by appropriately qualified personnel with relevant certificates authorising the personnel to perform works on electric systems. Unauthorized use of the meter may result in its damage and may be a source of serious hazard to the user.
- Using this manual does not exclude the need to comply with occupational health and safety regulations and with other relevant fire regulations required during the performance of a particular type of work. Before starting the work with the device in special environments, e.g. potentially fire-risk/explosive environment, it is necessary to consult it with the person responsible for health and safety.
- It is unacceptable to operate:
 - ⇒ a damaged meter which is completely or partially out of order,
 - ⇒ a meter with damaged insulation,
 - ⇒ a meter stored for an excessive period of time in disadvantageous conditions (e.g. excessive humidity). If the meter has been transferred from a cool to a warm environment with a high level of relative humidity, do not start measurements until the meter is warmed up to the ambient temperature (approximately 30 minutes).
- If the battery is discharged to a level preventing further measurements, the meter displays an appropriate message and then turns off.
- Battery spill and damage to the meter may occur if discharged batteries are left in the meter.
- Before measurement, make sure that test leads are connected to appropriate measuring terminals.
- Do not operate a meter with an open or incorrectly closed battery (accumulator) compartment or power it from other sources than those specified in the present manual.
- **R_{ISO}** meter inputs are electronically protected against overloads (caused by e.g. connecting the meter to a live circuit) up to 463V RMS for 60 seconds.
- Repairs may be performed only by an authorised service point.



NOTE!

Only accessories for a given device should be used. Using other accessories may cause damage to measuring terminals, introduce additional measurement errors and create a risk for the user.



Due to continuous development of the meter's software, the actual appearance of the display, in case of some of the functions, may differ from the display presented in this operating manual.

2 Main menu

The main screen is available:

- after the meter has been turned on,
- at any time after the  icon has been selected on the display (does not apply to the recorder).

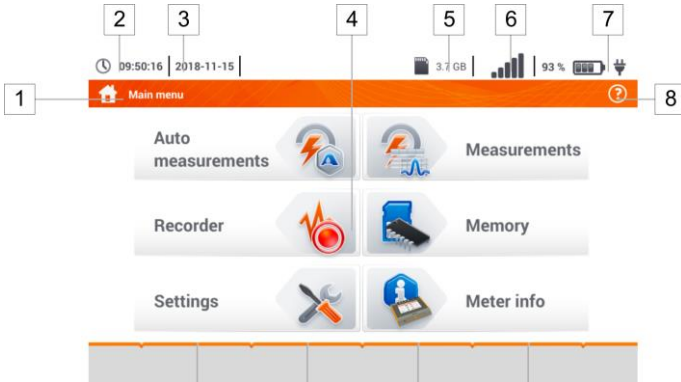

Fig. 2.1 Main elements of the screen

- 1 **Name of the active menu**
The fact of introducing a change that has not been saved yet is indicated by the * symbol in the screen header.



- 2 **Time**
3 **Date**
4 **Main screen**
5 **Free space on the memory card**
If the card is not in the slot, the icon on the screen is crossed out.
6 **Wireless network signal strength**
7 **Battery discharge indicator**
8 **Active menu help**

Tapping a selected main menu item redirects to the sub-menu. Available options:

- **Recorder** – measurement of electrical parameters of the tested network (described in **section 4.2**),
- **Settings** – going to the settings of the main functions and parameters of the meter,
- **Measurements** – Selecting the measurement function. The description of individual functions is provided in **section 3**,
- **Memory** – viewing and managing the saved measurement results (described in **section 6**),
- **Meter information.**



A detailed description of individual functionalities is provided in the full version of the manual on the manufacturer's website.

2.1 Meter settings

The **date**, **time** and display **brightness** can be set from the **Meter settings** screen.

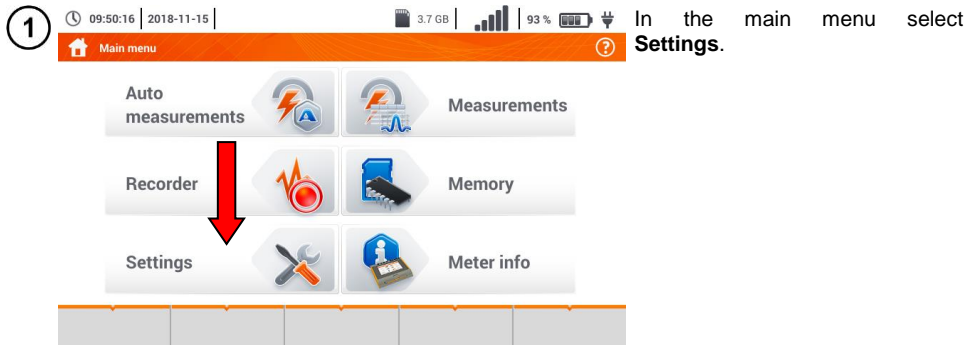

2.2 Measurement settings

From the **Measurement settings** menu it is possible to edit:

- measurement settings - mains parameters,
- fuses database,
- **MPI-540-PV** photovoltaic installation parameters,
- **MPI-540-PV** photovoltaic modules database.

2.2.1 Sub-menu Measurements

The option of **Measurements** contains the following items:

- mains rated voltage,
- network frequency,
- manner of presentation of fault loop result,
- type of mains for the tested object,
- system of units,
- memory settings (auto-incrementing memory cells),
- auto measurements timer,
- **MPI-540-PV** minimum value of irradiance for conversion of STC conditions,
- **MPI-540-PV** temperature measurement source,
- **MPI-540-PV** the number of photovoltaic modules in series,
- **MPI-540-PV** the number of photovoltaic modules in parallel,
- RCD EV measurement standard.

Before the measurements, select the **mains type** from which the tested object is powered. Then select the mains rated **U_n voltage** (110/190 V, 115/200 V, 127/220 V, 220/380 V, 230/400 V or 240/415 V). This voltage value is used for calculating the values of prospective short-circuit current.

Determination of **network frequency** f_n that is the source of potential interferences, is necessary in order to select a proper measuring signal frequency in resistance to earth measurements. This selection ensures optimum interference filtering. The meter is designed for filtration of interferences generated by 50 Hz and 60 Hz networks.

RCD EV measurement standard defines the parameters for measuring RCD protectors dedicated to the field of electromobility and photovoltaics.

Setting **Auto-increment** as active (→) places each saved measurement in an automatically created new measurement point.

Auto measurements timer determines the time interval of starting subsequent steps of the measurement procedure.

2.2.2 MPI-540-PV Sub-menu PV modules

1 

- In **Module** column, use **+** icon to add PV module.
- In **Parameters** column, complete the module parameters.

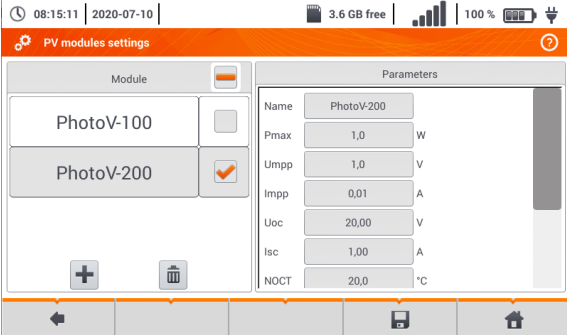
2 

Description of function icons

- record inactive
- record active
- +** add new record
- edit active record name
- remove active record
- return to the previous screen
- return to the main menu

List of parameters

Name – name of the module

Pmax – power in MPP point*

Umpp – voltage in MPP point*

Impp – current in MPP point*

Uoc – open circuit voltage

Isc – short-circuit current

NOCT – nominal operation cells temperature

alpha – temperature current coefficient - Isc

beta – temperature voltage coefficient - Uoc

gamma – temperature power coefficient - Pmax

Rs - serial resistance of PV module

* MPP – maximum power point

2.3 Communication

2.3.1 USB communication

The B-type USB port built-in in the meter is used to connect the meter to the computer in order to download the data stored in its memory. The data may be downloaded directly from the Windows system or through the software provided by the manufacturer.

In addition, the meter is compatible with PC software.

- **Sonel Analysis** – the software provides support for the meter's recorder and all PQM series analyzers. It enables data reading from the recorder and data analysis,
- **Sonel Reader** – the software is used to retrieve the data saved from the meter memory. In addition, it enables data transfer to the PC, data saving in popular formats and printing.
- **Sonel Reports PLUS** – supports creation of documentation after testing of electrical installation. Software communicates with Sonel test instruments, download data from memory of test instrument and creates necessary documentation.

Detailed information is available from the manufacturer and distributors.

- 1 Connect the cable to the USB port of the computer and the type B USB slot of the meter.
- 2 Start the program.

2.3.2 **MPI-540-PV** Connection with an irradiance meter

- 1 Go to **Settings** ► **Communication settings** ► **LoRa**.
- 2 Connect the LoRa adapter to the USB socket of the meter. The **LoRa** symbol will appear on the top bar.
- 3 Set the irradiance meter into the pairing mode. Enter its serial number to MPI-540-PV.
- 4 Select **Pair**.

2.4 Regional settings



- Expand the list of languages to select from.
- Select the required language.

Description of function icons

- ◀ returning to the previous screen (you may be prompted to save or reject changes)
- 💾 saving changes
- 🏠 returning to the main menu

3 Measurements



WARNING

During measurements (fault loop, RCD), do not touch conductive, accessible or foreign parts of the tested electrical installation.

The following tests are available from the **Measurements** menu.



Low voltage measurements - LV:

- fault loop impedance (Z_{L-N} , $L-L$, Z_{L-PE} , $Z_{L-PE[RCD]}$ for mains secured with RCD),
- voltage drop ΔU ,
- insulation resistance R_{iso} ,
- checking the parameters of RCD (tripping current **RCD** I_A , tripping time **RCD** t_A and automatic measurements),
- resistance R_x ,
- continuity of connections R_{cont} ,
- phase sequence **1-2-3**,
- direction of motor rotations **U-V-W**,
- resistance to earth R_E ,
- soil resistivity Ωm ,
- illuminance **Lux**.

MPI-540-PV



Measurements of photovoltaic devices - PV:

- continuity of protective conductors and equipotential bonding R_{cont} ,
- resistance-to-earth R_E ,
- insulation resistance R_{iso} **PV**,
- open circuit voltage U_{oc} ,
- short circuit current I_{sc} ,
- currents and powers on AC and DC side of the inverter and its efficiency η , **P**, **I**,
- irradiance **Irr**.

3.1 Checking the correctness of PE (protective earth) connections

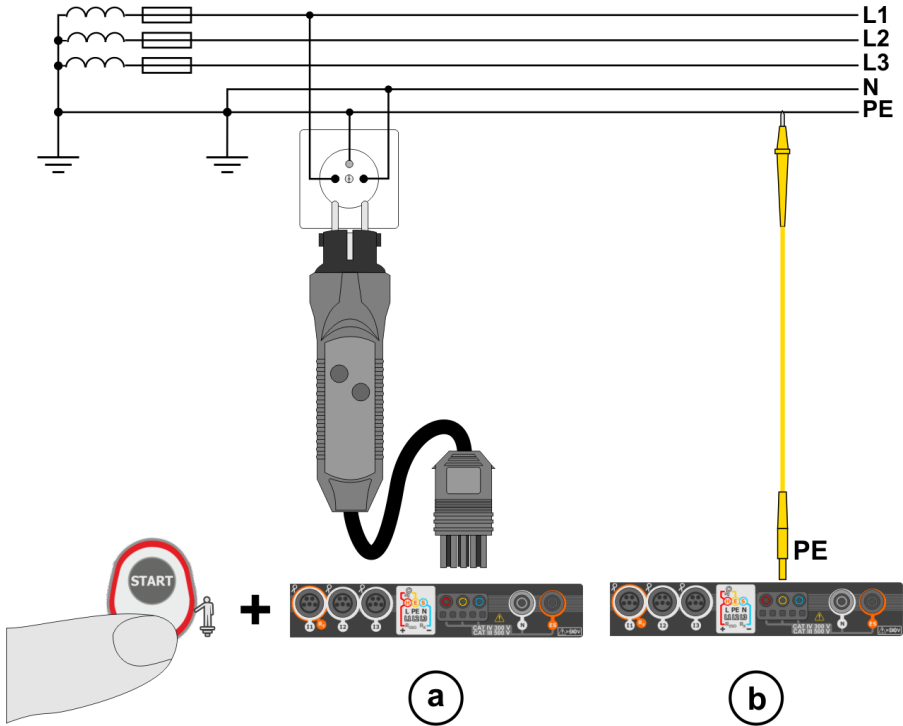

When the meter is connected as in the drawing, touch the contact electrode and wait for about **1 second**. If voltage is detected on the PE conductor, the device:

- will display text **PE!** (installation error, the PE conductor connected to the phase conductor) and
- will generate a continuous audio signal

This option is available for all measuring functions that apply to residual current devices (RCD) and fault loop **except Z_{L-N} measurement**.



WARNING

When phase voltage is detected on PE lead, measurements must be immediately stopped and a fault in the installation must be removed.



- Make sure to stand on non-insulated ground when measuring. Insulated ground may cause an incorrect test result.
- If the voltage on the PE conductor exceeds the acceptable limit value (approx. 50 V), the meter will signal the fact.

3.2 Fault loop parameters



$Z_{L-N, L-L}$



Z_{L-PE}



$Z_{L-PE[RCD]}$

Select item Z_{L-N} , $L-L$, Z_{L-PE} or $Z_{L-PE[RCD]}$.

3.2.1 Fault loop parameters in the L-N and L-L circuits

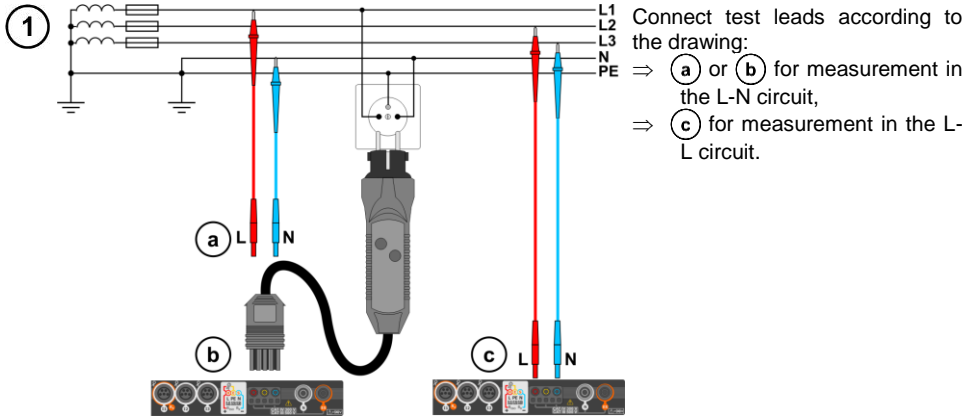

②



$Z_{L-N, L-L}$

Select item $Z_{L-N, L-L}$.

③ Select other settings and perform the measurement using the **START** button on the device.

3.2.2 Fault loop parameters in the L-PE circuit

① Connect test leads according to Fig. 3.1 or Fig. 3.2.

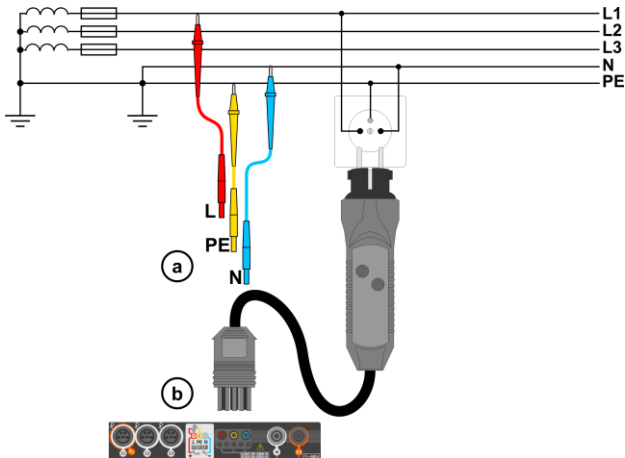

Fig. 3.1 Measurement in L-PE circuit

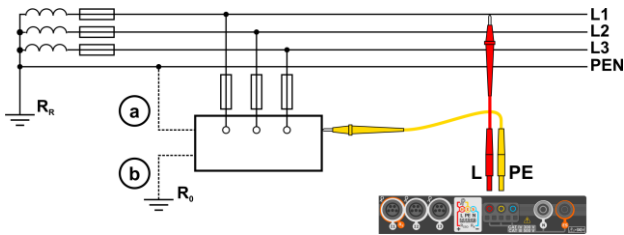

Fig. 3.2 Checking effectiveness of protection against electric shock of the meter housing in case of: (a) TN network or (b) TT network

2



Select item **ZL-PE**.

3

Select other settings and perform the measurement using the **START** button on the device.

3.2.3 Fault loop impedance in L-PE circuit protected with a residual current device (RCD)

1

Connect test leads according to **Fig. 3.3**, **Fig. 3.4** or **Fig. 3.5**.

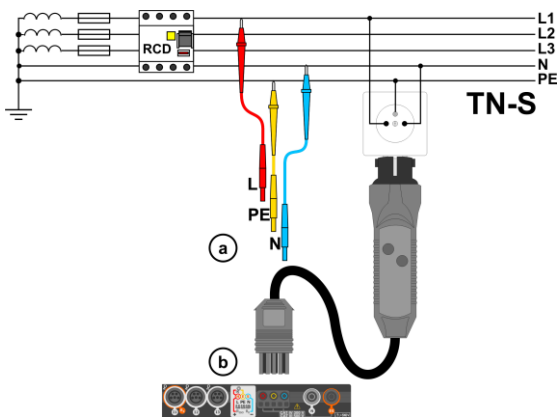

Fig. 3.3
Measurement in the TN-S system

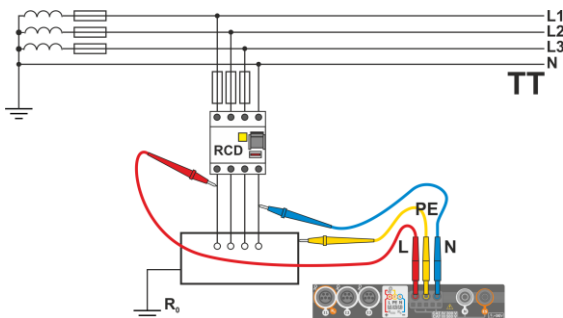

Fig. 3.4
Measurement in the TT system

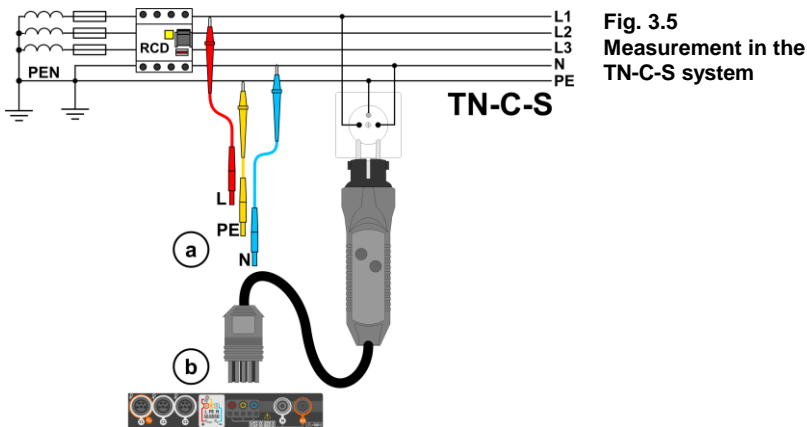

Fig. 3.5
Measurement in the
TN-C-S system

2



Select item $Z_{L-PE[RCD]}$.

3

Select other settings and perform the measurement using the **START** button on the device.

3.2.4 Measurement of fault loop impedance in IT networks

Before performing the measurements select the appropriate network type in the **Measurement settings** menu.



NOTE!

- After selecting an IT type network, the function of the contact electrode is **inactive**.
- When attempting to perform the Z_{L-PE} and $Z_{L-PE[RCD]}$ measurement a message will appear informing that the measurement is impossible.

The manner of connecting the device to the installation is shown in **Fig. 3.6**.

The manner of performing the fault loop measurements is described in **section 3.2.1**.
Operating voltage range: **95 V ... 440 V**.

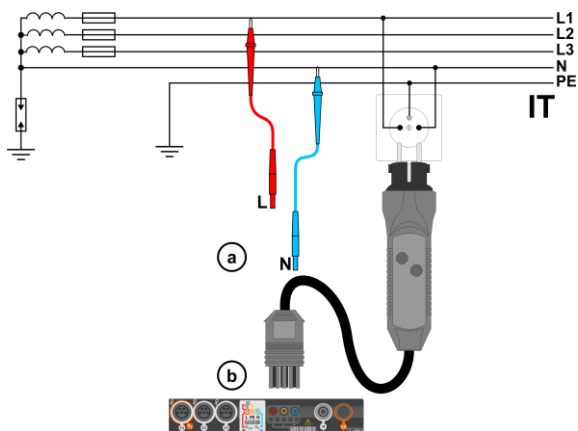
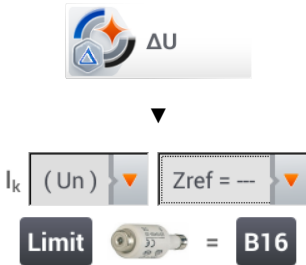

Fig. 3.6 Measurement in the IT system

3.3 Voltage drop

This function determines the voltage drop between two points of the tested network, selected by the user. The test is based on measurement of fault loop impedance L-N at these points. In a standard network, usually the voltage drop is tested between the socket and the switchgear (reference point).

①



- Select item **ΔU**.
- Use setting **Zref=---** to reset previous measurement, if it has not been done yet.
- Enter the **limit** of voltage drop **ΔU_{MAX}**.
- Enter the **fuse type**, which protects the tested circuit.

②

- Connect the meter to the reference point of the tested network, as for Z_{L-N} measurement
- Press **START**.

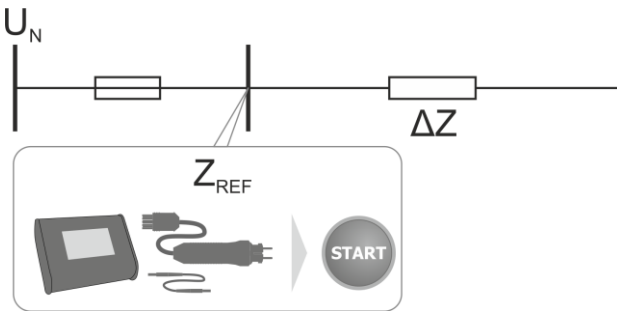

③

- Change the setting from **Zref** to **Z**.
- Connect the meter to the reference point, as for Z_{L-N} measurement.
- Press **START**.

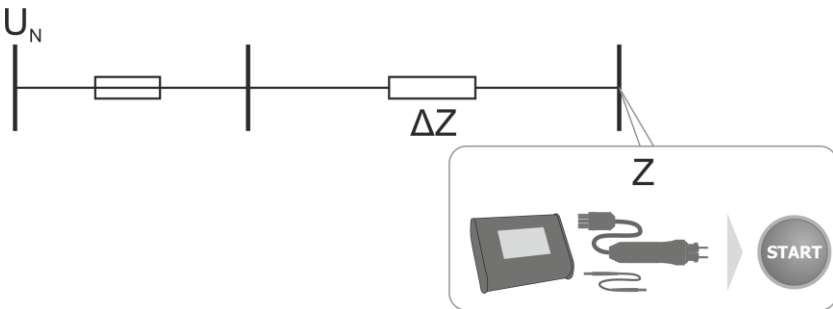

3.4 Resistance-to-earth



WARNING

- Measurement of resistance to earth may be carried out if voltage of interferences does not exceed 24 V. Voltage of interferences is measured up to the level of 100 V.
- Over 50 V it is signalled as hazardous. The meter must not be connected to voltages exceeding 100 V.

1



Select item R_E .

3.4.1 Earth resistance measurement with 3-pole method (R_{E3P})

The three-pole measuring method is the basic type of resistance to earth measurement.

1

Disconnect earth electrode being tested from the installation of the building.

2

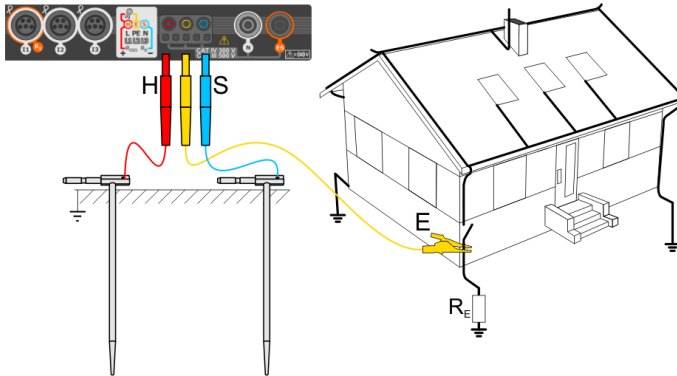

- Drive the **current** electrode into the ground and connect to the **H** socket of the meter.
- Drive the **voltage** electrode into the ground and connect to the **S** socket of the meter.
- The **earth electrode** being tested should be connected to **E** socket of the meter.
- It is recommended that the tested **earth electrode** as well as **H** and **S** electrodes should be located along one line and at relevant distances, in accordance with the rules of earth measurements.

3



- Select the **3P** option in the measurement menu.
- Select other settings and perform the measurement using the **START** button.

3.4.2 Earth resistance measurement with 4-wire method (R_{E4P})

1 Disconnect earth electrode being tested from the installation of the building.

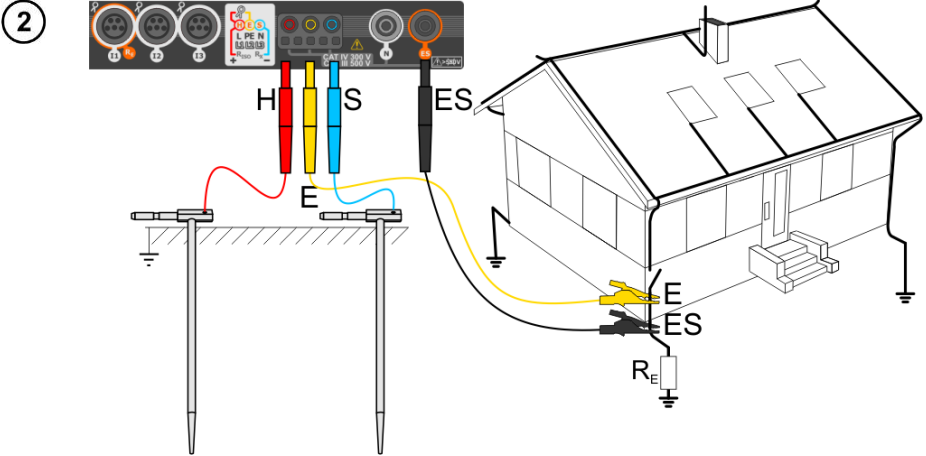

- Drive the **current** electrode into the ground and connect to the **H** socket of the meter.
- Drive the **voltage** electrode into the ground and connect to the **S** socket of the meter.
- The earth electrode being tested should be connected to **E** socket of the meter with the lead.
- **ES** socket should be connected to the tested earth electrode below **E** lead.
- It is recommended that the tested **earth electrode** as well as **H** and **S** electrodes should be located along one line and at relevant distances, in accordance with the rules of earth measurements.

3

14:03:04 | 2018-07-21 | 7.1 GB | 44% | **Earth resistance** | Select the **4P** option in the measurement menu.

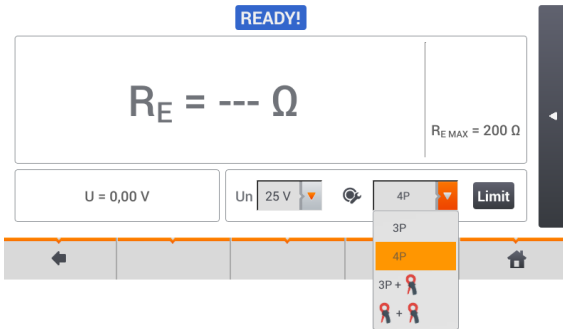

- Select other ones and perform the measurement using the **START** button.

3.4.3 Earth resistance measurement with 3-pole method with additional clamp (R_{E3P+C})

1

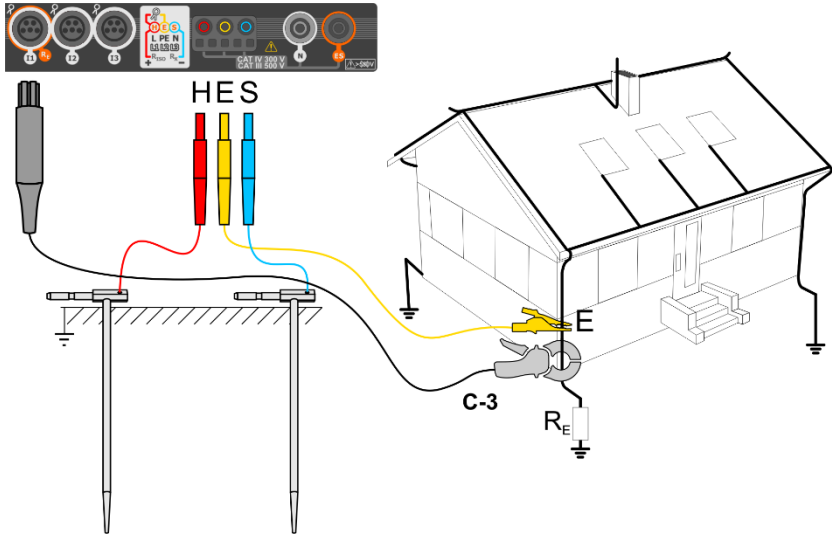

- Drive the **current** electrode into the ground and connect to the **H** socket of the meter.
- Drive the **voltage** electrode into the ground and connect to the **S** socket of the meter.
- The earth electrode being tested should be connected to **E** socket of the meter with the lead.
- It is recommended that the tested **earth electrode** as well as **H** and **S** electrodes should be located along one line and at relevant distances, in accordance with the rules of earth measurements.
- **Receiving clamps** should be attached to the tested earth electrode below the connection point of **E** lead.
- **The arrow on the clamps** can be directed in **any direction**.

2

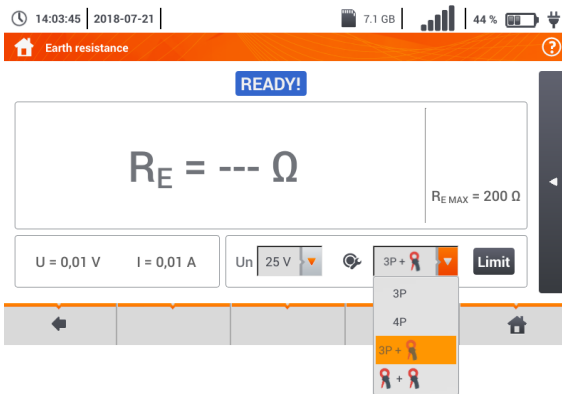

Select the **3P + clamps** option in the measurement menu.

Select other settings and perform the measurement using the **START** button.

3.4.4 Earth resistance measurement with two-clamp method (2C)

1 a

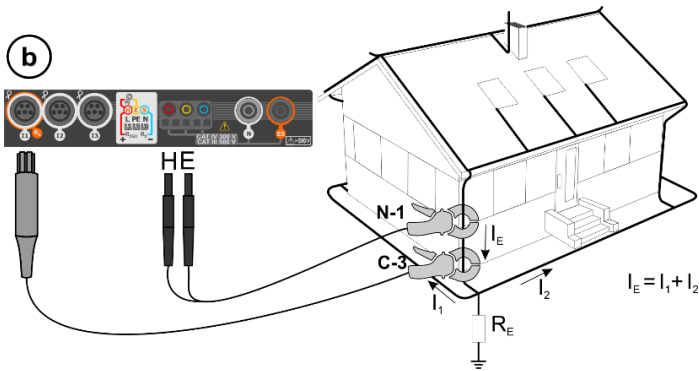
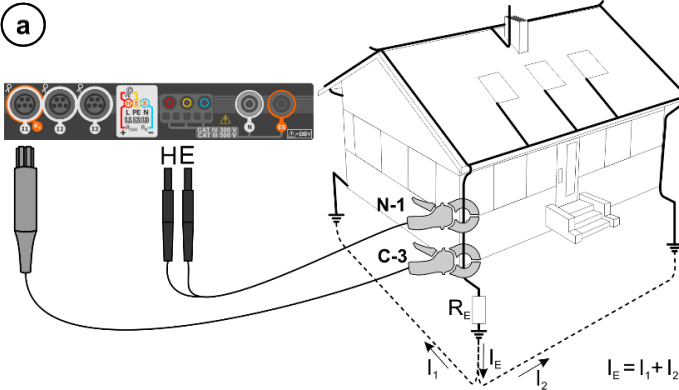

- Transmitting clamps and measuring clamps should be attached to the tested earth electrode **at a distance of at least 30 cm from each other.**
- **The arrow on the clamps can be directed in any direction.**
- Connect the transmitting **clamps N-1** to **H** and **E** socket.
- Connect the **measuring clamps C-3** to the clamp socket.

2



- Select the **clamps + clamps** option in the measurement menu.

- Select other settings and perform the measurement using the **START** button.

3.5 Soil resistivity

For soil resistivity measurements – used as preparation for the designing the earthing system or in geology measurements – a separate function is provided: measurement of soil resistivity ρ . This function is identical to 4-pole measurement of earth resistance, however, it contains an additional procedure of entering the distance between the electrodes. The measurement result is the resistivity value, calculated automatically according to the formula applied in Wenner method:

$$\rho = 2\pi L R_E$$

where:

L – distance between the electrodes (all distances must be equal),

R_E – measured resistance.

①



Select item Ωm .

②

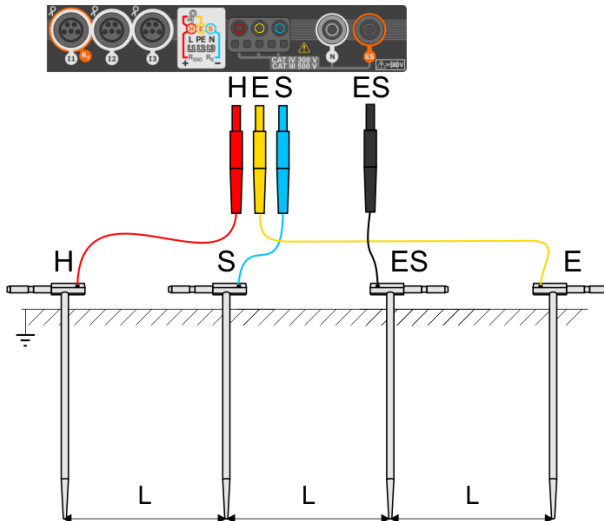

- Drive 4 probes into the ground **in one line** and at **equal** distances.
- Connect the probes to the meter according to the drawing above.

③



• Call up the measurement menu.

• Select other settings and perform the measurement using the **START** button.

3.6.1 Measurements in IT networks

Before performing measurements select the appropriate network type in the main menu (menu **Measurement settings**, section 2.2.1).



NOTE!

After selecting an IT type network, the function of the **contact electrode** is inactive.

The manner of connecting the device to the installation is shown in **Fig. 3.7** and **Fig. 3.8**.

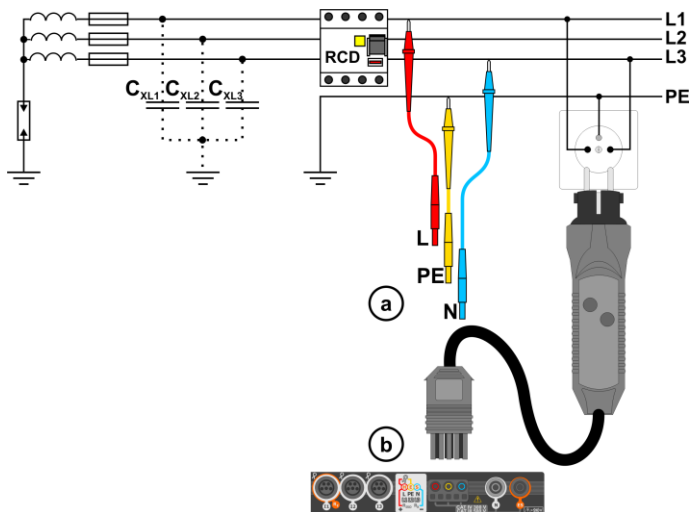

Fig. 3.7 RCD measurement in the IT network. The circuit is closed by the parasitic capacitances C_x

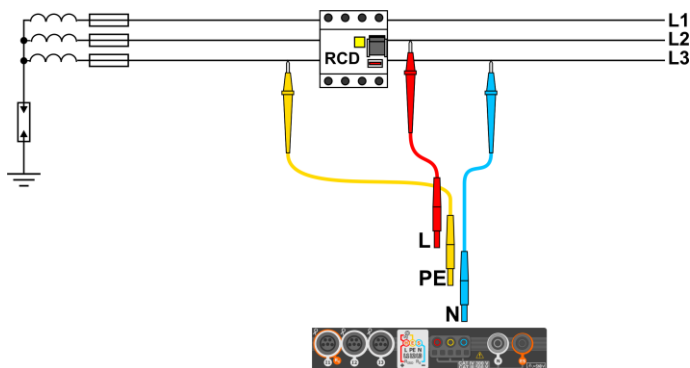

Fig. 3.8 RCD testing without the PE conductor

Operating voltage range: **95 V ... 270 V**.

3.7 Automatic measurements of RCD parameters

The meter enables user to measure automatically RCD triggering time (t_A), disconnection current (I_A), contact voltage (U_B) and resistance-to-earth (R_E). In this mode, there is no need to trigger each measurement by pressing **START** button. The role of the user is reduced to initiating the measurement by single pressing **START** and switching RCD on after each tripping.

3.7.1 Setting automatic measurements of RCD parameters

①  Select **RCD_{AUTO}**.

②  • Select **U_L** and from then select the required measuring voltage from the list.

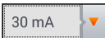
$I_{\Delta n}$  • Select the rated differential current of tested protection.

 • Select the type of tested protection.

③  • Select the parameters to be measured. Designations:
I_A tripping current
t_A response time
+ current with increasing head is forced
- current with decreasing head is forced
x0.5 / 1 / 2 / 5 a multiplicity of RCD rated current, according to IEC 61557-6

• Select the metering mode:

- ① a full,
- ② b standard.

④a  If **full** mode has been selected, select the type of tested protection.

 **RCD other than EV.** There is no 6 mA DC module in this type of device.

 **EV type RCD.** Here there is a 6 mA DC module. In this situation, before the test it is necessary to:

- determine according to which standard the measurement is to be carried out (**sec. 2.2.1**),
- determine the multiplication factor of the 6 mA DC differential current (**EV** button). The test settings vary depending on the selected standard.

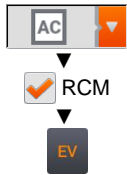

RCD other than the EV, which is protected by a RCM (residual current monitoring device at 6 mA DC). In this situation, before the test it is necessary to:

- determine according to which standard the measurement is to be carried out (**sec. 2.2.1**),
- tick **RCM**,
- determine the multiplication factor of the 6 mA DC differential current (**EV** button). The test settings vary depending on the selected standard.

4b



If **standard** mode has been selected, set the shape of the testing current. In this mode, RCD EV and RCM tests are unavailable.

3.7.2 Automatic measurement of RCD parameters

1 Connect the meter to the installation according to the drawing.

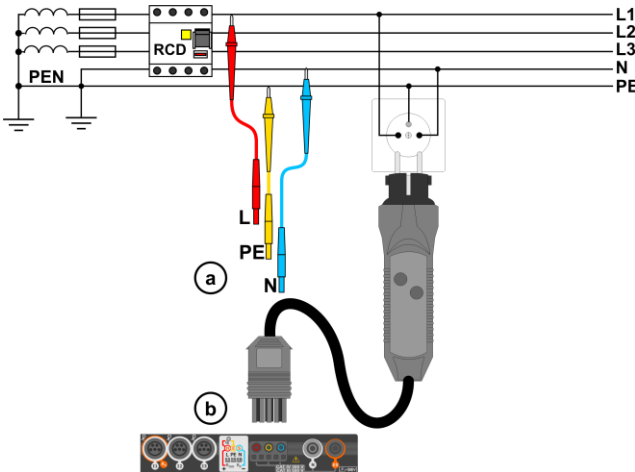

2



Select **RCD_{AUTO}**.

3 Enter the measurement settings in accordance with **section 3.7.1**.

4 Press **START** to start the measurement.

Criteria for assessing the correctness of component results

Parameter	Assessment criterion	Notes
$I_A \sim$	$0.5 I_{\Delta n} \leq I_A \leq 1 I_{\Delta n}$	-
$I_A \sim \sim$ $I_A \sim \sim \sim$	$0.35 I_{\Delta n} \leq I_A \leq 2 I_{\Delta n}$	for $I_{\Delta n} = 10 \text{ mA}$
$I_A \sim \sim$ $I_A \sim \sim \sim$	$0.35 I_{\Delta n} \leq I_A \leq 1.4 I_{\Delta n}$	for other $I_{\Delta n}$
$I_A \sim \sim \sim$	$0.5 I_{\Delta n} \leq I_A \leq 2 I_{\Delta n}$	-
$I_A \sim \sim \sim 6 \text{ mA}$	$3 \text{ mA} \leq I_A \leq 6 \text{ mA}$	for 6 mA RCD EV and RCM (acc. to IEC 62955 and IEC 62752)
t_A at $0.5 I_{\Delta n}$	$t_A \rightarrow \text{rcd}$	<ul style="list-style-type: none"> ▪ for all types of RCD ▪ for AC module of RCD EV
t_A at $1 I_{\Delta n}$	$t_A \leq 300 \text{ ms}$	<ul style="list-style-type: none"> ▪ for general purpose RCDs □ ▪ for AC module of RCD EV
t_A at $2 I_{\Delta n}$	$t_A \leq 150 \text{ ms}$	<ul style="list-style-type: none"> ▪ for general purpose RCDs □ ▪ for AC module of RCD EV
t_A at $5 I_{\Delta n}$	$t_A \leq 40 \text{ ms}$	<ul style="list-style-type: none"> ▪ for general purpose RCDs □ ▪ for AC module of RCD EV
t_A at $1 I_{\Delta n}$	$130 \text{ ms} \leq t_A \leq 500 \text{ ms}$	for selective RCDs S
t_A at $2 I_{\Delta n}$	$60 \text{ ms} \leq t_A \leq 200 \text{ ms}$	for selective RCDs S
t_A at $5 I_{\Delta n}$	$50 \text{ ms} \leq t_A \leq 150 \text{ ms}$	for selective RCDs S
t_A at $1 I_{\Delta n}$	$10 \text{ ms} \leq t_A \leq 300 \text{ ms}$	for short-time delay RCDs G
t_A at $2 I_{\Delta n}$	$10 \text{ ms} \leq t_A \leq 150 \text{ ms}$	for short-time delay RCDs G
t_A at $5 I_{\Delta n}$	$10 \text{ ms} \leq t_A \leq 40 \text{ ms}$	for short-time delay RCDs G
t_A at $1 I_{\Delta n}$	$t_A \leq 10 \text{ s}$	for 6 mA RCD EV and RCM ($I_{\Delta} = 6 \text{ mA}$ acc. to IEC 62955 and IEC 62752)
t_A at $10 I_{\Delta n}$	$t_A \leq 300 \text{ ms}$	for 6 mA RCD EV and RCM ($I_{\Delta} = 60 \text{ mA}$ acc. to IEC 62955 and IEC 62752)
t_A at $33 I_{\Delta n}$	$t_A \leq 100 \text{ ms}$	for 6 mA RCD EV and RCM ($I_{\Delta} = 200 \text{ mA}$ acc. to IEC 62955)
t_A at $50 I_{\Delta n}$	$t_A \leq 40 \text{ ms}$	for 6 mA RCD EV and RCM ($I_{\Delta} = 300 \text{ mA}$ acc. to IEC 62752)

3.8 Insulation resistance



WARNING

- The tested object must not be live.
- During measurements of insulation resistance, dangerous voltage up to 1 kV occurs at the ends of test leads of the meter.
- It is forbidden to disconnect test leads before the measurement is completed. Failure to obey the above instruction will lead to high voltage electric shock and make it impossible to discharge the tested object.

1



Select item **RISO**.

2

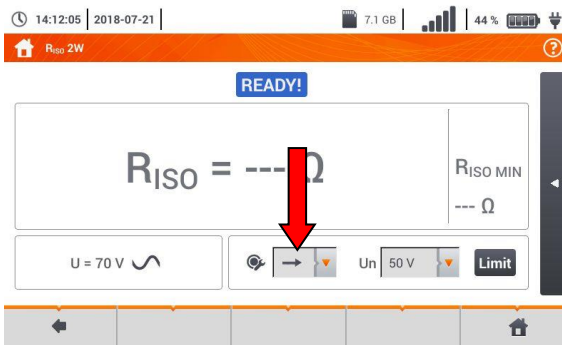

• Connect the meter probe or the adapter which the measurements will be performed with.

• Select other settings and perform the measurement using the **START** button.

Items will vary depending on whether the following have been connected to the meter:

- (a) probes,
- (b) UNI-Schuko adapter,
- (c) AutoISO-1000C adapter.

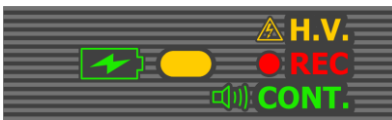

During the measurement the **H.V./REC/CONT.** diode is lit **orange**.

a

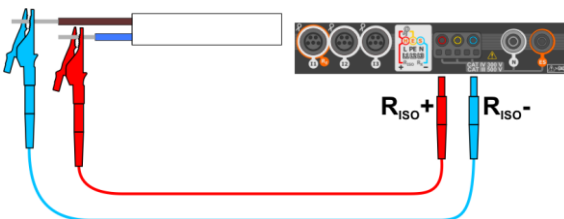

Measurement using probes.

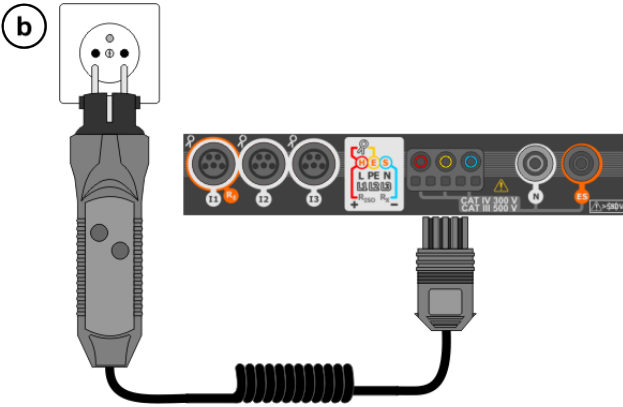

Measurements using UNI-Schuko adapter (WS-03 and WS-04).

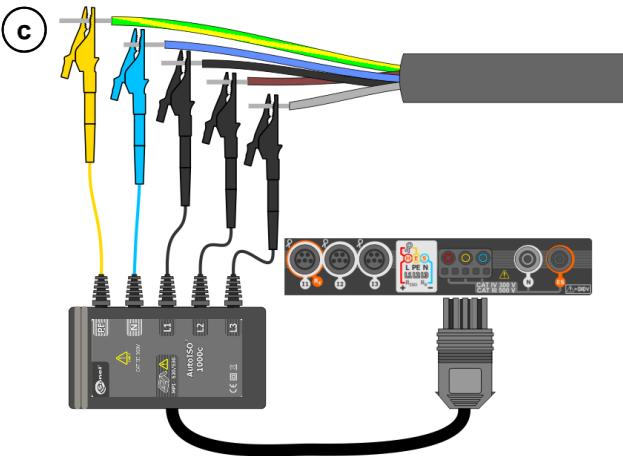

Measurements using AutoISO-1000c adapter.

3.9 Low-voltage measurement of resistance

3.9.1 Measurement of resistance

①



Select item R_x , to call up the measurement screen.

②

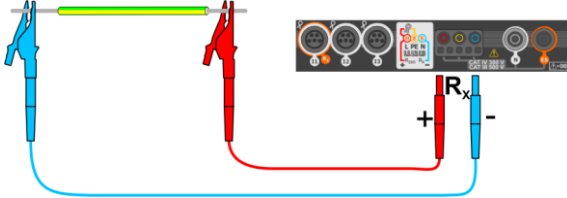

- Connect the meter to the tested object.

- Measurement starts automatically.

- During the measurement the **H.V./REC/CONT. diode** is lit **green** and a sound signal is emitted.

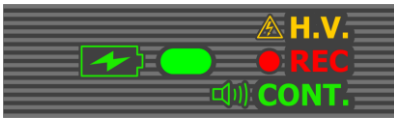

NOTE!

Display of symbols  **VOLTAGE!** indicates that the tested object is live. The measurement is blocked. The meter must be **immediately disconnected from the object**.

3.9.2 Measurement of resistance of protective conductors and equipotential bonding with ± 200 mA current

①



Select item R_{cont} , to call up the measurement screen.

②

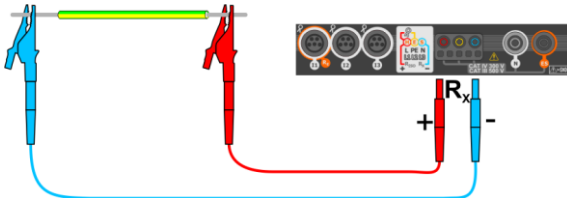

- Connect the meter to the tested object.

- Measurement starts automatically.



NOTE!

Display of symbols  **VOLTAGE!** indicates that the tested object is live. The measurement is blocked. The meter must be **immediately disconnected from the object**.

3.10 Sequence of phases

1



Select item **1-2-3**, to call up the measurement screen.

2

Connect the meter to the installation according to the drawing.

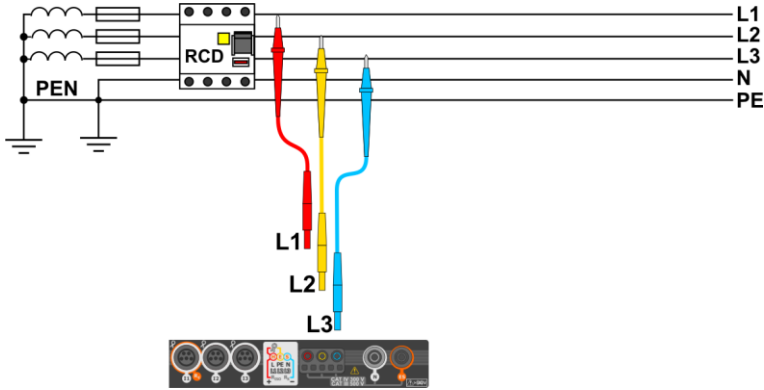

3

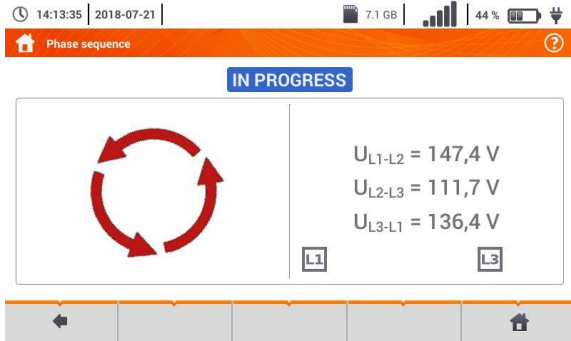

The phase sequence is **correct**, i.e. the phase sequence is in **clockwise** direction.

The phase sequence is **incorrect**, i.e. the phase sequence is in **anticlockwise** direction.

3.11 Motor rotation direction

1



Select item **U-V-W**, to call up the measurement screen.

2

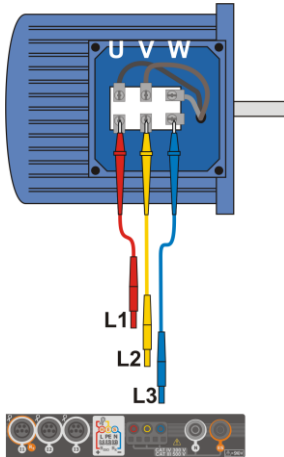

- Connect the meter to the motor according to the drawing, i.e. U terminal do input L1, V to L2, W to L3.

- Vigorously rotate the motor shaft to the right.

3

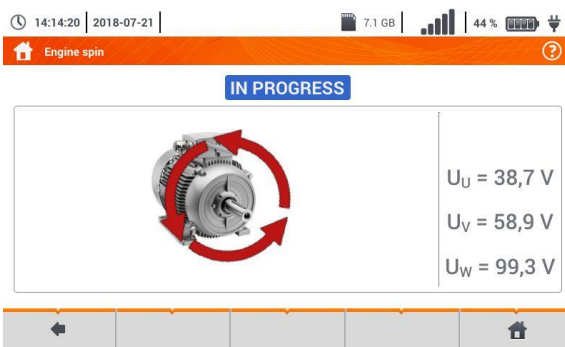

Arrows on the screen rotating **to the right** mean that the motor connected to a 3-phase network will rotate the shaft **to the right**.

Arrows on the screen rotating **to the left** mean that the motor connected to a 3-phase network will rotate the shaft **to the left**.

3.12 Illuminance

①



Select item **Lux meter** to call up the measurement screen.

②

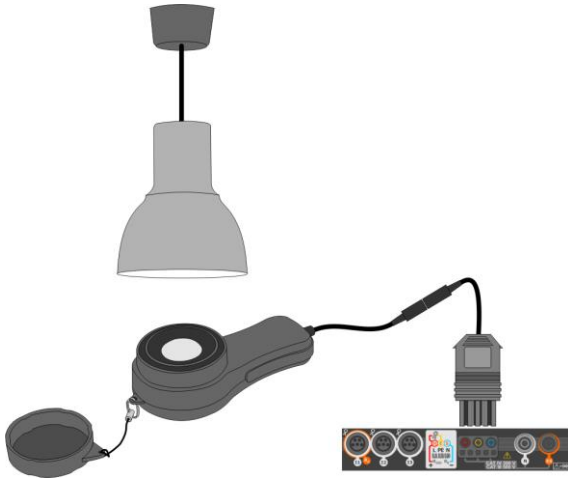

Connect the optical probe and place it in the tested plane. The meter will show the measurement.

3.13 MPI-540-PV Resistance-to-earth (PV)



Connect the measuring system. The measurement is performed similarly as in **section 3.4**.

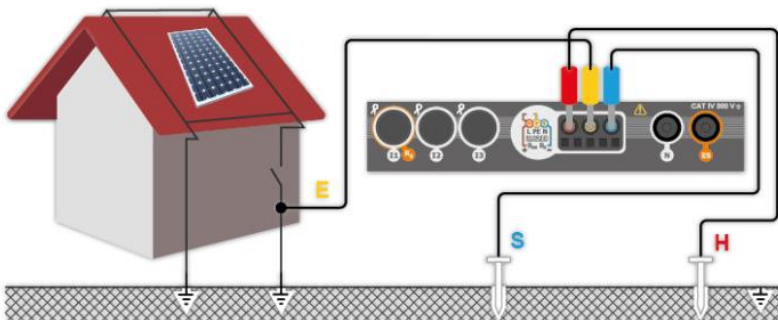

3.14 MPI-540-PV *Insulation resistance (PV)*



WARNING

- During measurements of insulation resistance, dangerous voltage up to 1 kV occurs at the ends of test leads of the meter.
- **It is forbidden** to disconnect test leads before the measurement is completed. Failure to obey the above instruction will lead to electric shock with high voltage and make it impossible to discharge the tested object.



The measurement is performed similarly as in **sec. 3.8**. Measure the insulation resistance between the positive pole (DC+) and grounding, as well as between the negative pole (DC-) and grounding. For this purpose:

- connect the grounding with R_{ISO-} socket of the meter, connect DC+ line with R_{ISO+} meter, select R_{ISO+} method in the instrument and start the measurement,
- connect DC- line with R_{ISO+} socket, select R_{ISO-} method in the instrument and start the measurement.

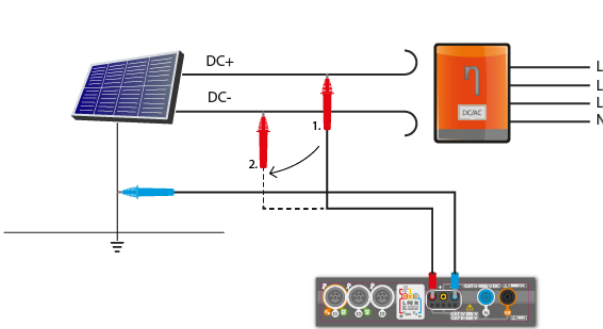

After selecting the bar ◀ on the right side, a menu will slide out with additional measurement results.

U_{iso} L-N – measurement voltage

Selecting the ▶ bar hides the menu.

3.15 MPI-540-PV *Continuity of connections (PV)*



Connect the measuring system. The measurement is performed similarly as in **sec. 3.9.2**.

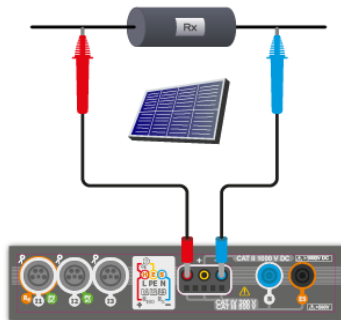

3.16 MPI-540-PV **Open circuit DC voltage U_{OC}**

1



2

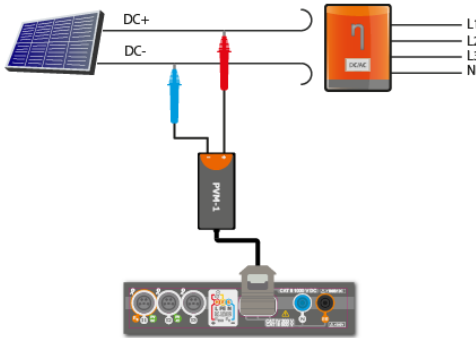

WARNING
Do not disconnect MC4 connectors when the load current of working inverter flows through them. This may cause arcing and danger to the user!

Select item U_{OC} to call up the measurement screen.

Turn off the inverter or disconnect it from the tested object. Connect the meter to the chain of PV modules using PVM-1 adapter and adapters of MC4 connectors. The following parameters will be measured:

U_{OC} – open circuit voltage,

$U_{OC:STC}$ – open circuit voltage after conversion to STC* conditions,

ΔU_{OC} – difference in open circuit voltage (measured and converted to STC conditions) and the same voltage declared by the producer of the panel, also converted to STC conditions.

*STC (Standard Test Conditions) – reference conditions, for which the manufacturer provides all the parameters of the modules.

3

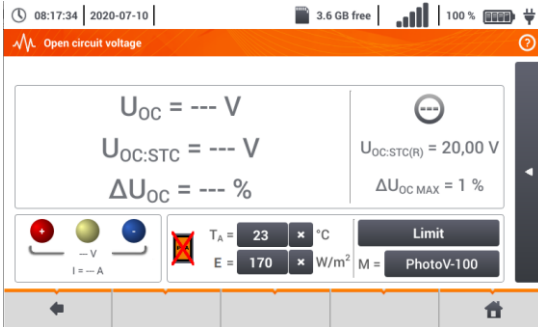

Enter the test parameters:

T_A – ambient temperature, if the source of temperature measurement = air (**sec. 2.2.1**),

T_{PV} – module temperature, if the source of temperature measurement = module (**sec. 2.2.1**),

E – irradiance,

Limit – setting of $\Delta U_{OC MAX}$ values,

M – photovoltaic module selected from the meter database (**sec. 2.2.2**).



Parameters T_A , T_{PV} , E come from the irradiance meter, if it is connected to the meter. See also **sec. 2.3.2**.

In addition, the screen displays the following:

$U_{OC:STC(R)}$ – open circuit voltage in STC conditions, declared by the manufacturer,

$\Delta U_{OC MAX}$ – limit ΔU_{OC} set.

4



Press **START** to start the measurement.

3.17 MPI-540-PV Short circuit DC current I_{sc}

1



2

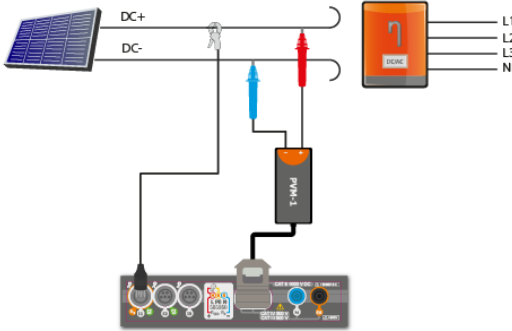

WARNING

Do not disconnect MC4 connectors when the load current of working inverter flows through them. This may cause arcing and danger to the user!

Select item I_{sc} , to call up the measurement screen. Then reset the clamp (sec. 3.19).

Turn off the inverter or disconnect it from the tested object. Connect the meter to the chain of PV modules using PVM-1 adapter and adapters of MC4 connectors. The following parameters will be measured:

I_{sc} – short-circuit current

$I_{sc:STC}$ – short circuit current after conversion for STC* conditions,

ΔI_{sc} – difference of short-circuit current (measured and converted to STC conditions) and the same current declared by the producer of the panel, also converted to STC.

*STC (Standard Test Conditions) – reference conditions, for which the manufacturer provides all the parameters of the modules.

3



Enter the test parameters:

T_A – ambient temperature, if the source temperature measurement = air (sec. 2.2.1),

T_{PV} – module temperature, if the source of temperature measurement = module (sec. 2.2.1),

E – irradiance,

Limit – setting of $\Delta I_{sc MAX}$ values,

M – photovoltaic module selected from the meter database (sec. 2.2.2).

In addition, the screen displays the following:

$I_{sc:STC(R)}$ – short-circuit current in STC conditions, as declared by the manufacturer,

$\Delta I_{sc MAX}$ – limit ΔI_{sc} set.



Parameters T_A , T_{PV} , E come from the irradiance meter, if it is connected to the meter. See also sec. 2.3.2.

4



If necessary, reset the clamps again. Press **START** to start the measurement.

3.18 MPI-540-PV Test of the inverter panel η , P, I

1



Select item η , P, I, to call up the measurement screen. Then reset the clamps (sec. 3.19).

2

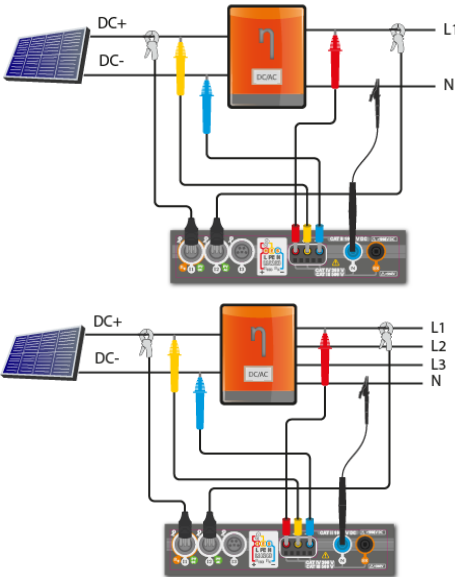

Connect the meter to the tested object. The following parameters will be measured:

- at the inverter input (DC)
- at the inverter output (AC).

◀ In the case of 3-phase inverter, the measurement is made assuming the symmetry of the output currents and voltages on the AC side.

3

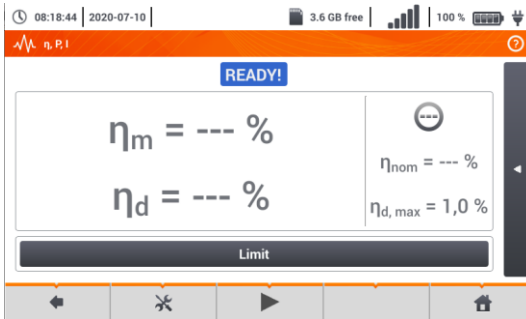

You may use icon, to select the data presented on the screen.

- ⇒ currents at input (I_{DC}) and output (I_{AC}),
- ⇒ power values at input (P_{DC}) and output (P_{AC}),
- ⇒ inverter efficiency (η_m) and the difference between the efficiencies of the inverter: measured and declared by the manufacturer (η_d).

Select **Limit**, to set the criterion of the maximum difference between the efficiencies of the inverter: measured and declared by the manufacturer.

If necessary, reset the clamp again.

Use icon to go to the measurement configuration. See sec. 3.18.1, 3.18.2.

4



Press **START**. The live mode readings will be captured and displayed in the main screen.

3.18.1 Measurement configuration

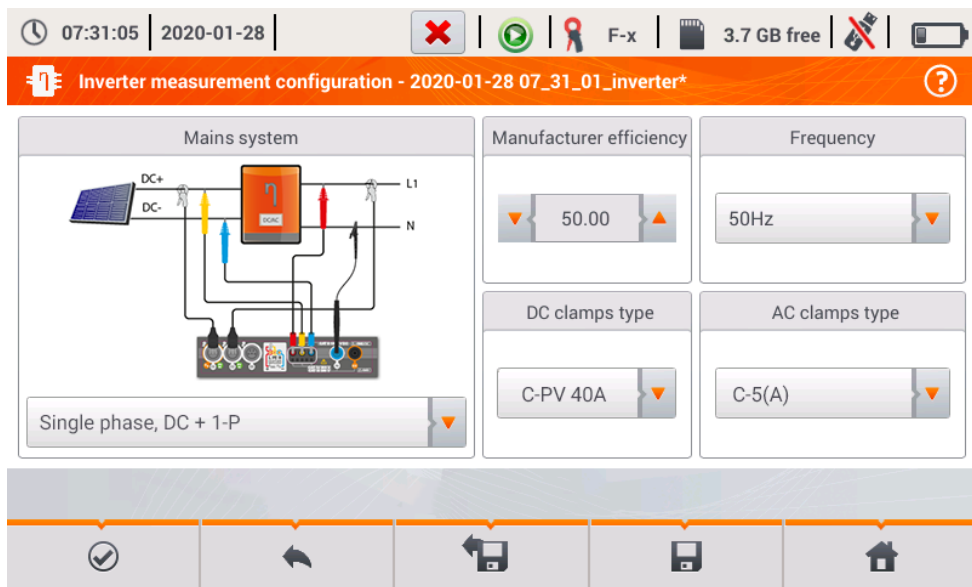

Fig. 3.9. Configuration screen of inverter efficiency measurement



Set the parameters of the tested inverter on the displayed configuration screen:

- **Mains system** – there are two types to choose from:
 - **Single phase, DC + 1-P**
Select this system type for inverters with single-phase AC output.
 - **Three phase, DC + 4-P**
It is possible to measure only the efficiency of three-phase, 4-wire inverters (star configuration with neutral wire).
- **Manufacturer efficiency** – efficiency of the inverter declared by the manufacturer. This value is used to compare the measured efficiency with the declared value.
- **DC clamps type** – the user may use the list to select the type of clamps used for current measurements on DC side of the inverter.
- **AC clamps type** – the user may use the list to select the type of clamps used for current measurements on AC side of the inverter.
- **Frequency** – nominal frequency of the AC output of the inverter.

Po ustawieniu wymaganych parametrów można od razu przejść do właściwych pomiarów.

After setting the required parameters, you can go directly to the required measurements.

Menu bar functions

- ✓ entering the measurement screen (live values in a tabular view) with the specified settings (without saving the configuration).
- 📁 saving the configuration of inverter efficiency to a file with an option to start the measurement directly after saving (field **Go to Live mode** in the pop-up window).
- 📁 entering the list of saved configurations of inverter efficiency and creating a new configuration. Configurations are presented similarly to the measuring configurations, they have their own icon . Double-tap on a selected configuration will open it automatically and entering the screen with inverter efficiency settings. The button in the menu bar **+** is used for adding new configurations starting of the inrush current (a window is displayed, as shown in **Fig. 3.10** with default settings). Icon  is used to edit the chosen configuration.

3.18.2 Live mode

After entering the live mode screen, all the parameters of the measured inverter circuit are shown in a tabular view.

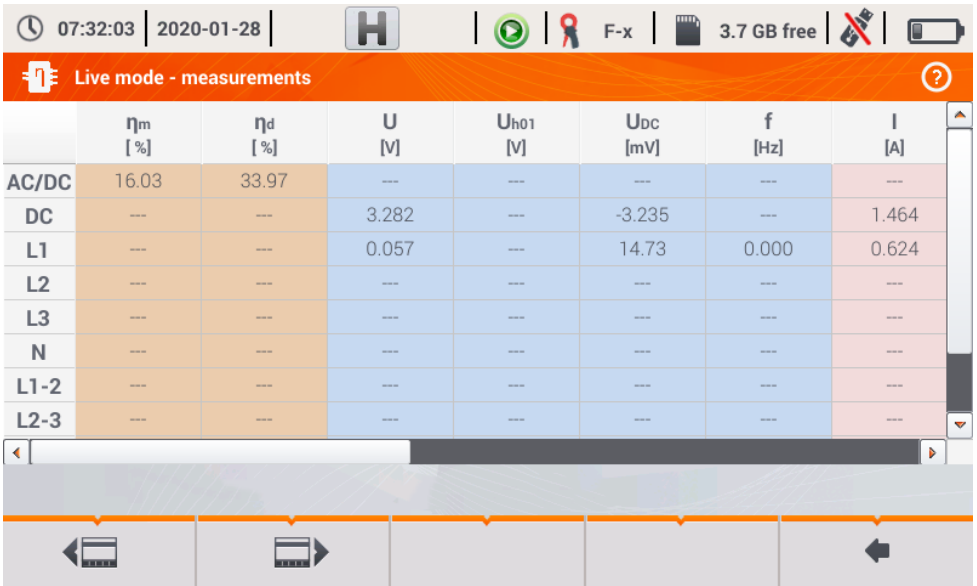
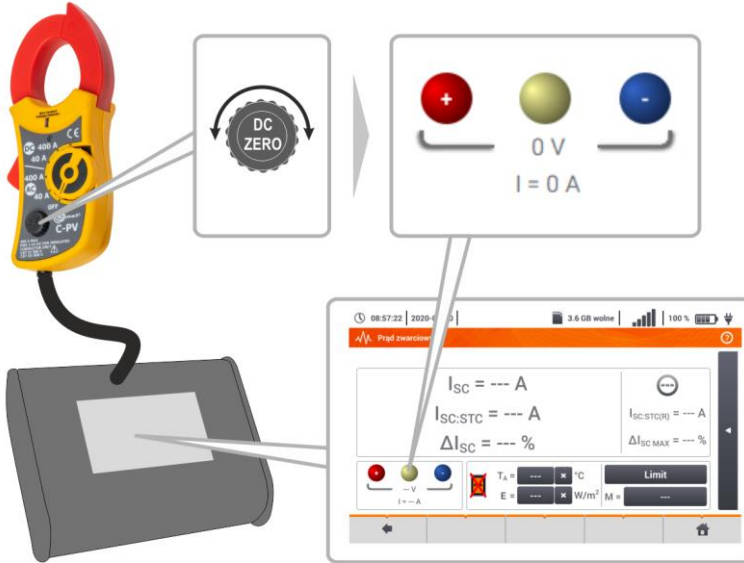

Fig. 3.10. Live mode in tabular view for the inverter efficiency measurement mode

3.19 **MPI-540-PV** *Resetting C-PV clamp*

Before the I_{SC} measurement and testing the inverter (**sec. 3.17, 3.18**) reset C-PV clamp. To do this, connect the clamp to the meter. Set the **DC ZERO** knob on the housing of the clamp to make the voltage and current readings as close to zero as possible. Only then you can connect the clamp to the tested object.



3.20 **MPI-540-PV** *Irradiance and temperature*

1 Pair the instrument and the irradiance meter according to **sec. 2.3.2**.



Select item **Irr**, to display the measurement screen.



Connect the irradiance meter to the tested object. The screen shows the current readings:

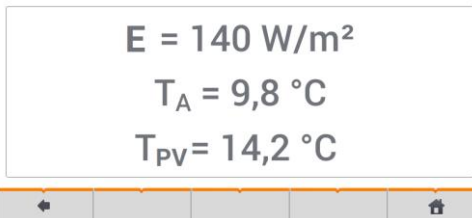

E – irradiance,
T_A – ambient temperature,
T_{PV} – PV module temperature.

4 Auto measurements

The meter includes automated test procedures.

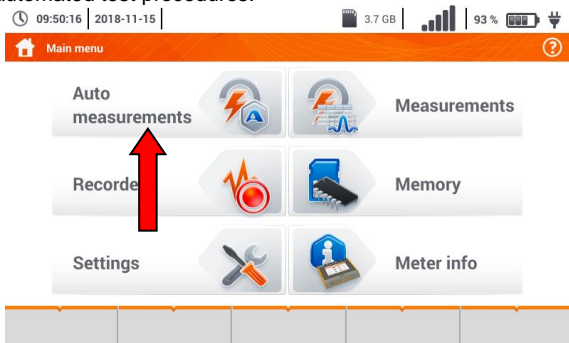

4.1 Proceeding auto measurements

1 The measurement sequences are grouped into two folders:

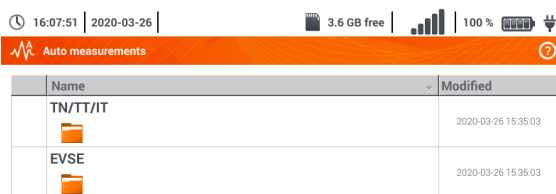

- ⇒ measurements in TN/TT/IT networks,
- ⇒ measurements dedicated for electric vehicles charging stations.

Select the measuring sequence from the list.



2 Connect the meter to the measuring system.

In each setting field, enter the type of measuring accessory, installation parameters and other required data.

Description of function icons

- assistance for a particular measurement
- collapsing setting fields
- expanding setting fields
- saving entered measurement data.



Press **START**. The automatic measurement sequence will start.

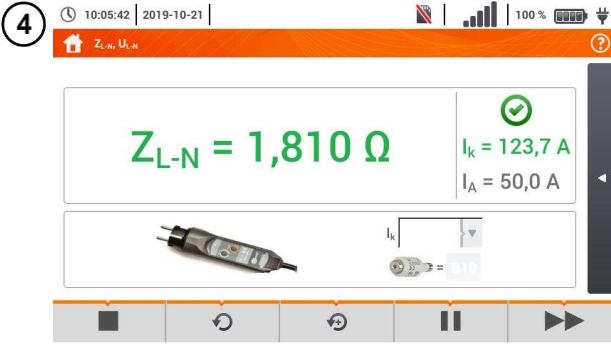

◀ The screen after completion of one of sequence measurements.

Description of function icons

- stopping the procedure and going to summary
- ↺ repeating the measurement with overwriting its result
- ↻ repeating the measurement without losing its previous result
- ⏸ stopping the procedure
- ▶▶ going to the next step of the procedure or to the summary. Time remaining to the next step is set according to **sec. 2.2.1.**

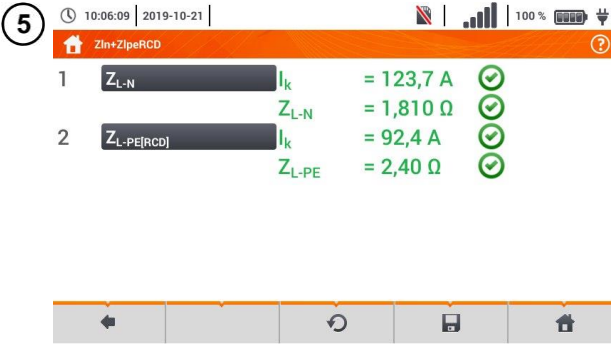

◀ Summary screen.

The procedure can be restarted with the ↺ icon.

Each measurement in a sequence hides partial results. To call them, touch the **label of such measurement**. A window as for a single measurement will be opened. Enter it with the use of the ◀ icon.

Save the measurement to the meter memory using the 💾 icon. A detailed description of memory management is contained in **section 6.1.3.**

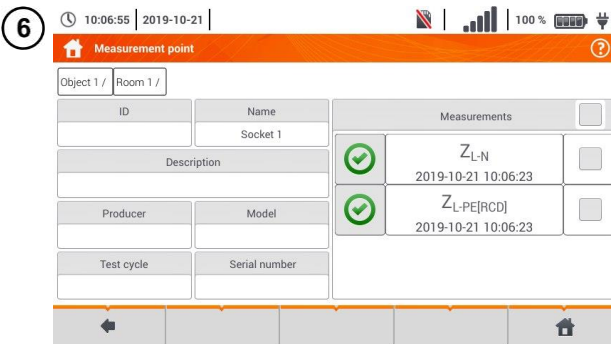

All sequence measurements will be saved in one measuring point.

Signal lights for reaching the limit

- ✔ the result is within the set limit
- ✘ the result is outside the set limit
- ⊖ assessment not possible
- no measurement was made

4.2 Creating measurement procedures

1

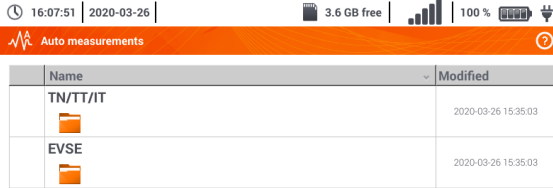

- Select **+**, to go to the sequence wizard.

- Select **+**, to add the desired measurement procedure.



2



From the available items select the one, which is to be a part of the procedure. In addition to standard measurements, the following are also available:

- => text message,
- => visual test.





3



After each selection, the menu with step parameters will be shown.



If the tests contain measurements in electric vehicle charging stations, then **EV** box should be selected.

Description of function icons

-  assistance for a particular measurement
-  collapsing setting fields
-  expanding setting fields
-  saving entered measurement data

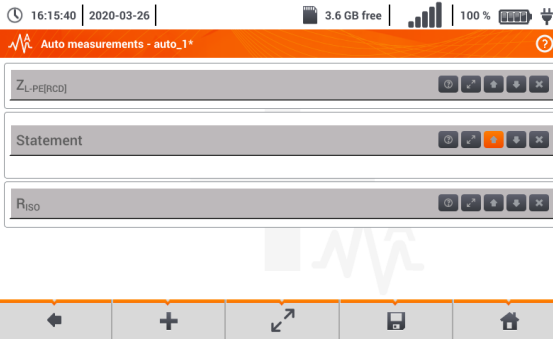
4





Changing the order of the steps is performed by using   icons. Delete the step by using  icon.

Save the procedure by using  icon. A window will be shown requesting the name of the procedure.

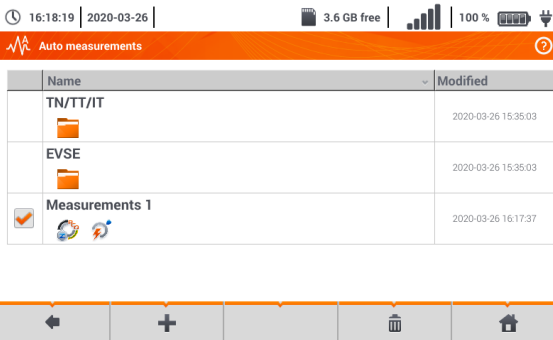
5



The procedure will be available from the main menu of auto-procedures. To remove it, select it with  and choose .

5 Recorder

5.1 Functional description

MPI-540 meter can be used as a 3-phase recorder of power supply parameters. It allows measurement and recording of parameters of 50/60 Hz power networks such as voltage, current, power, harmonics, etc. To switch the meter to power supply quality analyzer mode, select **Recorder** on the main screen.

In this mode it is possible to view the current network parameters (i.a. waveforms, component vectors, tabular data), record average parameter values according to the user settings and analyse the recorded data (timeplots, harmonics, etc.).

The analyzer module uses the following input sockets of the meter:

- three **current** clamps sockets I1, I2, I3,
- three **voltage** banana sockets L1, L2, L3 in the multifunctional socket, to which individual voltage phases are connected (max. 550 V relative to earth),
- separate banana socket marked N.



Fig. 5.1 Measuring inputs

Four sockets for current clamps allow the user to connect several types of clamps to measure currents. The following clamps may be connected to them:

- flexible clamps F-1A, F-2A, F-3A of nominal range of 3000 A AC (differing only in terms of the coil perimeter),
- CT clamps: C-4A (range 1000 A AC), C-5A (range 1000 A AC/DC), C-6A (range 10 A AC) and C-7A (range 100 A AC).

The measuring range may be changed by using additional transducers – for example, using a transducer of 10 000 A / 5 A with C-6A clamps the user may measure currents up to 10 000 A.

The recorded data is stored on a removable microSD memory card. The meter also has an internal memory, which is used for storing i.a. configuration files.

Configuration of the recorder consists in that the user only sets the basic parameters: type of network, type of clamps, frequency, averaging period. All data that the meter is able to measure is always recorded. All parameters of the power supply network measured by the meter in the recorder mode are listed below:

- RMS voltage,
- DC components of voltages,
- RMS currents,
- DC components of currents (only using C-5A clamps),
- mains frequency within the range of 40..70 Hz,
- harmonics of voltages and currents (up to 40th),
- total harmonic distortion (THD) THD_F for currents and voltages,
- active, reactive, apparent and distortion power,

- active positive and negative energies,
- passive energies consumed and returned,
- apparent energies,
- power factors (PF)
- unbalance factors of voltages and currents

Some of the parameters are aggregated (averaged) according to the time selected by the user (available settings: 1 s, 3 s, 10 s, 30 s, 1 min, 10 min, 15 min, 30 min) and may be stored on a memory card.

The meter is compatible with PC software *Sonel Analysis*, which also supports other analyzers produced by Sonel. This software allows analysis of the recorded data. The data may be read using the USB cable or directly from a microSD card after inserting it to an external memory card reader connected to PC.

Tab. 5.1 presents a summary of parameters measured by MPI-540, depending on the mains type.

Tab. 5.1. Measured parameters for different network configurations

Network type, channel		1-phase		2-phase				3-phase 4-wire					3-phase 3-wire			
		L1	N	L1	L2	N	Σ	L1	L2	L3	N	Σ	L12	L23	L31	Σ
U	Effective voltage	•		•	•			•	•	•			•	•	•	
U _{DC}	Voltage constant component	•		•	•			•	•	•			•	•	•	
I	Effective current	•		•	•	•		•	•	•	•		•	•	•	
I _{DC}	Current constant component	•	•	•	•	•		•	•	•	•		•	•	•	
F	Frequency	•		•				•					•			
P	Active power	•		•	•		•	•	•	•		•				•
Q ₁	Reactive power	•		•	•		•	•	•	•		•				•(1)
D, S _N	Distortion power	•		•	•		•	•	•	•		•				
S	Apparent power	•		•	•		•	•	•	•		•				•
PF	Power Factor	•		•	•		•	•	•	•		•				•
tanφ	Factor tangent φ	•		•	•		•	•	•	•		•				•(1)
THD _F U	Total harmonic distortion voltage	•		•	•			•	•	•			•	•	•	
THD _F I	Total harmonic distortion current	•	•	•	•	•		•	•	•	•		•	•	•	
E _{P+} , E _{P-}	Active energy (consumed and supplied)	•		•	•		•	•	•	•		•				•
E _{Q1+} , E _{Q1-} , E _{QB+} , E _{QB-}	Reactive energy (consumed and supplied)	•		•	•		•	•	•	•		•				•(1)
E _S	Apparent energy	•		•	•		•	•	•	•		•				•
U _{h1..U_{h40}}	Voltage harmonic amplitudes	•		•	•			•	•	•			•	•	•	
I _{h1..I_{h40}}	Current harmonic amplitudes	•	•	•	•	•		•	•	•	•		•	•	•	
Unbalance U, I	Symmetrical components and unbalance factors												•			•

- Explanations:** L1, L2, L3 (L12, L23, L31) indicate subsequent phases,
N is a measurement of I_N current depending on the parameter type,
Σ is the total value for the system.
 (1) In 3-wire networks, the total reactive power is calculated as inactive power N.
 (2) Only consumed energy E_{P+}.

5.2 Main elements of the screen

After entering the recorder mode the **Main menu** is displayed. It is available:

- after switching the meter on,
- at any time after the  icon has been selected on the display.

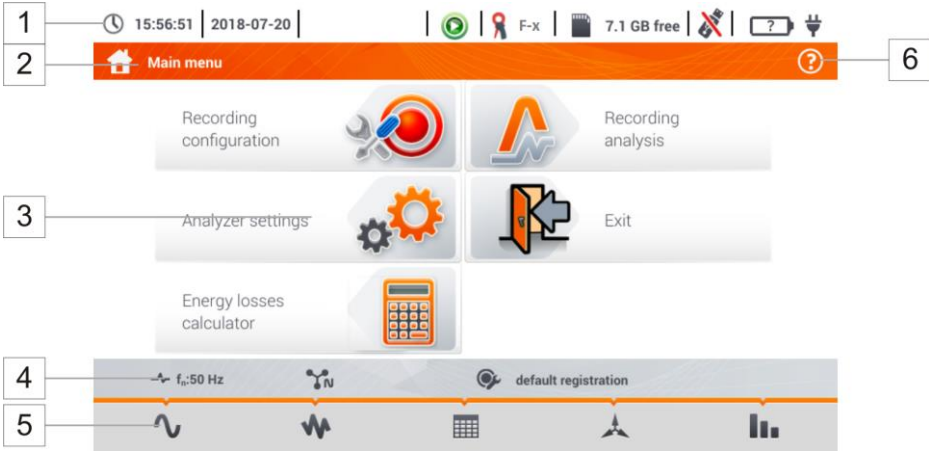

Fig. 5.2 Main elements of the recorder screen

1 Top bar

2 Name of the active menu

The fact of introducing a change that has not been saved yet is indicated by the * symbol in the screen header.



3 Main window

4 Information bar on current network configuration ,

5 Function icons bar

6 Active menu help

- Visualisation of connection systems
- Explanation of icons

5.2.1 Main menu

In the central part of the screen, the main window of the recorder is displayed. The default window (shown in Fig. 5.2) contains the following items:

- **Recording configuration** – this part of the interface is used to configure the measurement system and all aspects related to the recording of network parameters such as: network type (e.g. single-phase, three-phase) or clamps type,
- **Recording analysis** – provides an analysis of the recorded data and 'live' view of the recording process,
- **Analyzer settings** – a series of the recorder configuration options can be found here,





- **Energy losses calculator** – in this mode the user can estimate financial loss due to poor quality of power supply,
- **EXIT** – go to the main menu.

5.2.2 Information bar on the parameters of the current network

Below the main screen a bar is displayed, which shows the main parameters of the active measurement system (Fig. 5.2, element 4):

- nominal voltage,
- network frequency,
- network layout,
- name of the current recording configuration.

The network layout is symbolized by icons:

-  1-phase system,
-  2-phase system,
-  3-phase 4-wire system,
-  3-phase 3-wire system,
-  3-phase 3-wire system with the measurement of currents using Aron's method,

5.2.3 Help

On the right side of the title bar the help icon (?) is shown (Fig. 5.2, element 6). After its selection, a context help is displayed, which describes interface elements visible on the screen.

5.3 Connecting the measuring system

5.3.1 Measuring arrangements

The recorder may be connected directly to the following types of AC networks:

- single-phase (Fig. 5.3)
- 2-phase (split-phase) with split-winding of the transformer) (Fig. 5.4),
- 3-phase 4-wire (Fig. 5.5),
- 3-phase 3-wire (Fig. 5.6, Fig. 5.7).

In three-wire AC systems, current may be measured by the Aron method (Fig. 5.7), which uses only two clamps that measure linear currents I_{L1} and I_{L3} . I_{L2} current is then calculated using the following formula:

$$I_{L2} = -I_{L1} - I_{L3}$$

Pay attention to the direction of current clamps (flexible and hard). The clamps should be installed with the indicating the load direction. It may be verified by conducting an active power measurement – in most types of passive receivers active power is positive. When clamps are inversely connected, it is possible to change their polarity using in software (**Analyzer settings** → **Clamps**)

The following figures show schematically how to connect the analyzer to the tested network depending on its type.

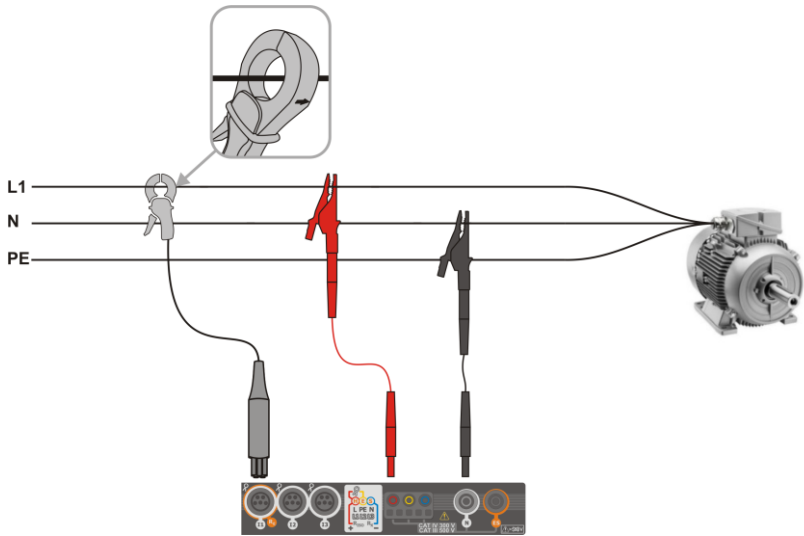

Fig. 5.3 Wiring diagram – single phase

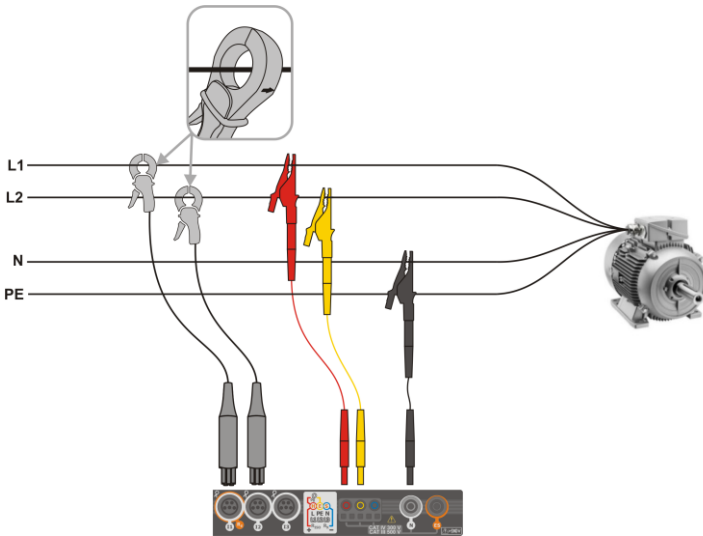

Fig. 5.4 Wiring diagram – 2-phase

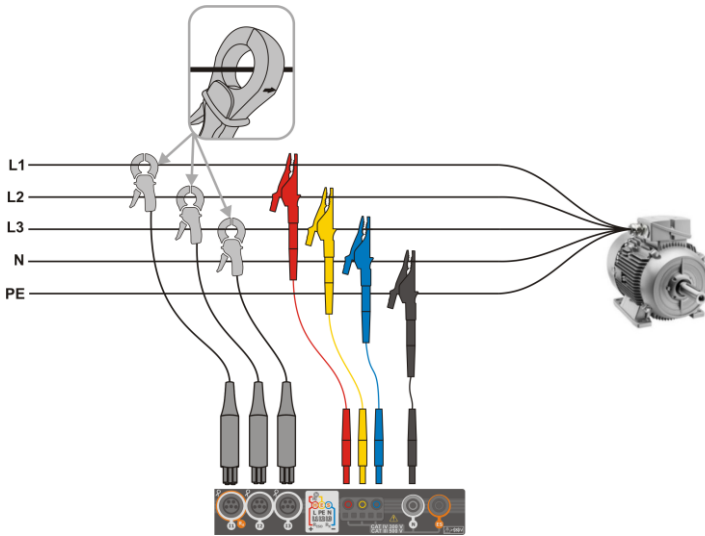

Fig. 5.5 Wiring diagram – 3-phase with four operating wires

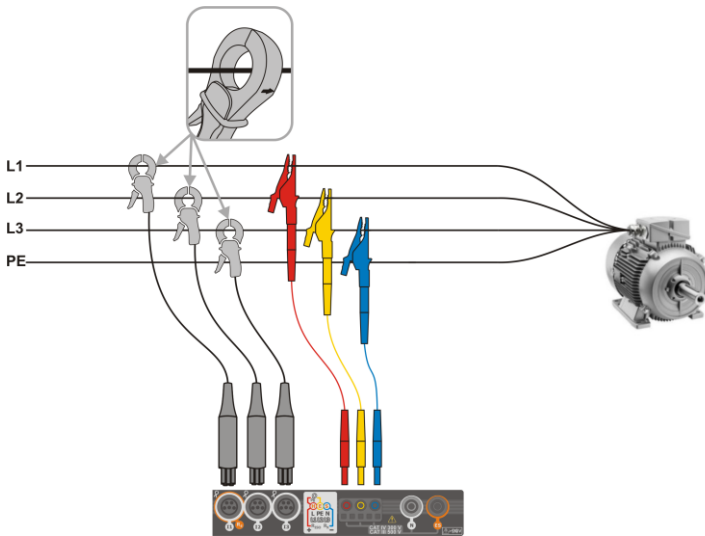

Fig. 5.6 Wiring diagram – 3-phase with three operating wires

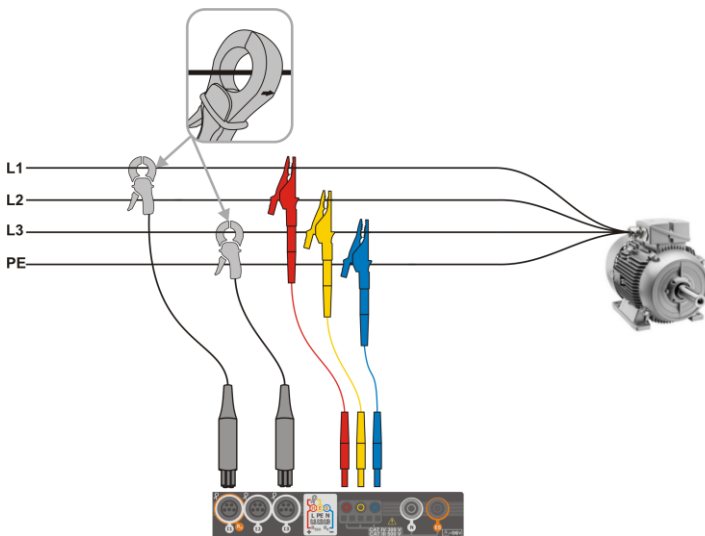

Fig. 5.7 Wiring diagram – 3-phase with three operating wires (measurement of currents using Aron method)

5.3.2 Recording configuration

After the **+** icon has been selected, a new window will be displayed as shown in Fig. 5.8. The default name of the new configuration will be displayed in the title bar. It is created from the current date and time in the "YYYY-MM-DD hh_mm_ss_settings" format, which may be modified.

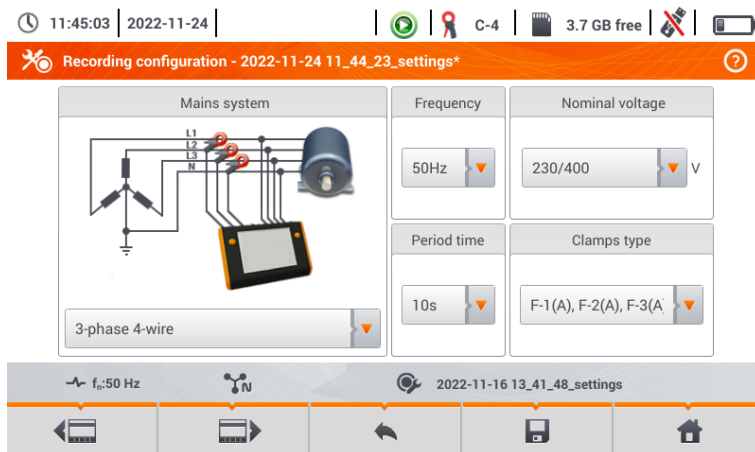





Fig. 5.8. Recording configuration – general settings

Buttons  and  at the bottom menu bar are used to switch between successive screens.

At this point, you may define:

- **Mains system.** By selecting the icon from drop-down list  or the network name, you can select the following types:
 - ⇒ **1-phase,**
 - ⇒ **Split-phase,**
 - ⇒ **3-phase 4-wire** – systems with neutral wire, e.g. star with N,
 - ⇒ **3-phase 3-wire** – systems without neutral wire – star without N and delta,
 - ⇒ **3-phase 3-wire Aron** – as standard 3-wire system, but with the current measurement using two clamps (I_1 i I_3). The third current (I_2) is determined by calculating from the relation
$$I_2 = -I_1 - I_3.$$
- **Frequency** – mains nominal frequency. The following positions are available: **50 Hz, 60 Hz.**
- **Nominal voltage.** The following settings are available: 58/100, 64/110, 110/190, 115/200, 120/208, 127/220, 133/230, 220/380, 230/400, 240/415, 254/440, 290/500, 400/690 V
- **Period time** - specifies the time of averaging recorded parameters and also the time between successive recorded data on a memory card (except events). The following settings are available: 1 s, 3 s, 10 s, 30 s, 1 min, 10 min, 15 min, 30 min.
- **Clamps type** – here you can enable or disable the measurement of currents and determine the type of clamps. If the current measurement is required, indicate clamps to be used from the following list:
 - ⇒ **No** – clamps not applied,
 - ⇒ **F-1(A), F-2(A), F-3(A)** – flexible clamps (Rogowski coil) with a nominal range of 3000 A AC,
 - ⇒ **C-4** – clamps CT (with core) with a range of 1000 A AC,
 - ⇒ **C-5** – clamps with a Hall sensor with a range of 1000 A AC/DC,
 - ⇒ **C-6** – clamps CT (with core) with a range of 10 A AC,
 - ⇒ **C-7** – clamps CT (with core) with a range of 100 A AC.
- **Voltage events: Log events** – ticking this box enables voltage event detection: swells, dips, interruptions. Three field with values allow the user to introduce own thresholds for these three types of events. Thresholds may be entered in volts or as a percentage values referenced to the nominal voltage of the network, e.g. setting the threshold of swell as +10% at nominal voltage of 230 V triggers the detection of swell after exceeding 253 V voltage ($RMS_{1/2}$). The event ends when the voltage drops to the threshold value reduced by hysteresis. If the hysteresis in the described case is 2%, then the end of the event will occur if when voltage ($RMS_{1/2}$) is lower than 248.4 V (253 V – 4.6 V).
- **Current events: Log events** – ticking this box enables current event detection. Entering "0" disables a given event. The entered values may be from range 0 ... I_n (where I_n is the current measurement range after taking into account current transformers).
 - **L max [A]** - maximum value threshold for current L1, L2, L3 (depending on the network). An event is detected when the value of $RMS_{1/2}$ current exceeds the specified threshold.
 - **L min [A]** – minimum value threshold for current L1, L2, L3. An event is detected when the value of $RMS_{1/2}$ current drops below the specified threshold.
 - **N max [A]** – similarly to L max, but it relates to N current channel (neutral current).
 - **N min [A]** – similarly to L min, but it relates to N current channel (neutral current).
- **Settings: Hysteresis** - percentage value in the range from 0.1 to 10, to be used for detecting events. Higher values allow to limit the number of detected events if the parameter value fluctuates around the threshold. The typical value of the hysteresis is 2%.

5.4 Analyzer settings



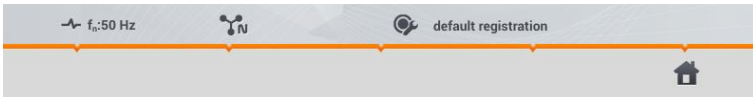

On the **Analyzer settings** screen it is possible to:

- specify the manner of clamps fastening,
- change the phase identification,
- view files stored in the recorder mode.



5.5 LIVE mode of the network

The recorder allows the user to preview network parameters in real time (LIVE mode). The icons of available views are displayed in the main recorder menu, in the bottom part:

-  view of waveforms of currents and voltages
-  timeplot view,
-  view of the table of measurements ,
-  view of the phasor diagram,
-  view of harmonics.

Screen refreshing in the LIVE mode can be temporarily blocked using the **HOLD** function.

- To pause refreshing, select the button on the top bar (the colour of the icon changes to **red**).
- To resume screen refreshing, select the icon again (the colour of the icon will change to **black**).

5.5.1 Transient waveforms of current and voltages (waveforms)

After the  icon has been selected, the view of waveforms of currents and voltages is displayed. They show two periods of network waveforms for active channels (depending on the measurement configuration).

Use labels on the right side of the window to **switch on** and **off** individual measuring channels (at least one waveform must be always visible). Each label includes the **name of the channel** (for example. "U L1") and its **effective value**.

5.5.2 Timeplot of effective values

After the  icon has been selected, the view of timeplot is displayed. This view displays a graph of the effective values of voltages and currents in time. The whole window covers time of approx. 110 seconds. After filling the entire window, the chart moves to the left by 30 seconds.

5.5.3 "Live" mode - tabular view

After the  icon has been selected a summary table with the values of network parameters is displayed. The table is refreshed in real time.

The next lines were determined as follows:

L1	phase values L1,
L2	phase values L2,
L3	phase values L3,
N	voltage values of the current channel I_N ,
L1-2	phase-to-phase values L1-L2,
L2-3	phase-to-phase values L2-L3,
L3-1	phase-to-phase values L3-L1,
Σ	total values.

The next column show the values of individual parameters:

U [V]	RMS voltage,
U_{h01} [V]	RMS of the fundamental voltage component,
U_{DC} [V]	voltage constant component,
f [Hz]	network frequency,
I [A]	RMS current,
I_{h01} [A]	RMS of the fundamental current component,
I_{DC} [A]	current constant component,
P [W]	active power,
Q1 or QB [var]	reactive power of the fundamental component or reactive power, acc. to Budeanu (depending on the method of calculating reactive power),
S [VA]	apparent power,
S_N [VA] or D [var]	apparent distortion power or Budeanu distortion power (depending on the method of calculating the reactive power),
E_{P+} [Wh]	active energy consumed,
E_{P-} [Wh]	active energy returned,
E_{oL+} [varh]	inductive reactive energy consumed,
E_{oC-} [varh]	capacitive reactive energy supplied,
E_{oL-} [varh]	inductive reactive energy supplied,
E_{oC+} [varh]	capacitive reactive energy consumed,
E_s [VAh]	apparent energy,
PF	Power Factor,
cosφ	displacement power factor,
tanφL+	tangent φ inductive reactive energy consumed,
tanφC-	tangent φ capacitive reactive energy supplied,
tanφL-	tangent φ inductive reactive energy supplied,
tanφC+	tangent φ capacitive reactive energy consumed,
Pst	short-term flicker factor,
Plt	long-term flicker factor,
U₀ [V]	zero symmetric voltage component,
U₁ [V]	positive sequence symmetrical component of voltage,

U_2 [V]	negative sequence symmetrical component of voltage,
U_2/U_1 [%]	voltage unbalance factor for negative sequence,
U_0/U_1 [%]	unbalance factor for zero component of voltage,
I_0 [A]	current zero symmetrical component,
I_1 [A]	current positive sequence symmetrical component,
I_2 [A]	current negative sequence symmetrical component,
I_2/I_1 [%]	current unbalance factor for negative sequence,
I_0/I_1 [%]	current unbalance factor for zero sequence.

5.5.4 Vector diagram of fundamental components (phasor)

After the  icon has been selected the phasor diagram appears. It shows the basic layout of component vectors of voltages and currents. It may be used to quickly verify the correctness of connecting the recorder to the network.

The following tables are next to the diagram:

- o the first, containing information on basic component values and their angles,
- o the second, containing the unbalance coefficients of negative components (the coefficients are only displayed for 3-phase networks).

The nature of the load is signalled by the icon of:

 the coil (inductive load) if the angle between the fundamental components of the voltage and current ($\varphi_{U_{h1}, I_{h1}}$) is greater than zero (voltage is ahead of current),

 the capacitor (capacitive load) if the angle $\varphi_{U_{h1}, I_{h1}}$ is negative (current is ahead of voltage).

5.5.5 Harmonics graph/table

After the  icon has been selected the mode of harmonics display is displayed. This screen allows you to view the harmonics of voltages and currents, angles between the current and voltage harmonics, $\cos\varphi$ factors of these currents and THD factors. Harmonics are displayed graphically in a bar graph (default) or in a table.

5.6 Switching the recording on/off

After correct configuration you can **trigger recording** by pressing the **START** button. Recording in-progress is signalled by icon  on the top bar and flashing of the red LED.

To **stop recording**, press the **START** button and confirm your intention to stop in the pop-up window. Stopping the recording will be **confirmed by sounds** (three long and three short signals) and the colour of the recording icon will change into  , and the red LED will stop flashing.

5.7 Recording analysis

Analysis of the recorded data is possible directly using the meter itself, without additional software. The scope of the analysis includes:

- general preview of the recording - start and end time, average values of voltages and currents,
- preview the average value of voltage across the whole recording range,
- preparing timelines of any recorded parameters (limited to 1100 points and 4 parameters on a single graph) with zoom-in option and time-point marker.
- preview of bar graph for harmonics (average value for the whole recording period).

It is possible to analyse records completed and saved on the memory card and on-going records.

The list of recording (entries on the symbol ) stored in the meter memory can be found on the **Recording analysis – recording list** screen.. The list can be scrolled by moving your finger up and down within the visible summary. Familiarise yourself with the detailed description of the manner of recording analysis contained in the full version of the device manual on the manufacturer's website.

5.8 Energy loss calculator

5.8.1 Functional description

In this mode, you can estimate the loss of active power and associated costs due to poor power supply quality. The loss analysis screen is shown in **Fig. 5.9**. Analysis can be performed in terms of the desired time.

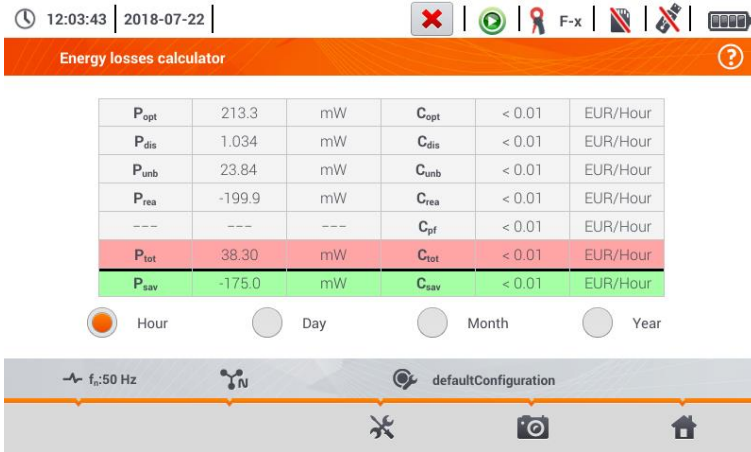

Fig. 5.9 Energy loss analysis

Parameters to analyse

P_{opt}	power loss due to wire resistance (assuming the absence of higher harmonics, unbalance and reactive power)	C_{opt}	cost related to P_{opt} loss
P_{dis}	loss due to higher harmonics	C_{dis}	cost related to P_{dis} loss
P_{unb}	power loss due to network asymmetry	C_{unb}	cost related to P_{unb} loss
P_{rea}	power loss due to poor power factor (from harmonics)	C_{rea}	cost related to P_{rea} loss
		C_{pf}	cost related to a low power factor (large share of reactive power)
P_{tot}	total loss (the sum of the above)	C_{tot}	cost related to P_{rea} loss
P_{sav}	loss which can be reduced by improving the quality parameters (e.g. compensation of harmonics, elimination of unbalance), arising from the relationship:	C_{sav}	cost related to P_{sav} loss



$$P_{sav} = P_{tot} - P_{opt}$$

The financial loss can be estimated based on the live mode readings in terms of:

- ⇒ one hour,
- ⇒ one day,
- ⇒ one month
- ⇒ one year.

When one of the above options is activated ( → ), the table will display data relevant to the selection.

5.8.2 Configuration of the loss calculator

After the  icon has been selected, the calculator configuration panel appears. It is possible to switch between screens using the   icons.

On the first screen, set the parameters of the wire, to which the analysis applies, namely:

- for phase conductors **L**:
 - **number of cores** in a phase,
 - **cross section** of cores in mm²,
- for neutral conductors **N**:
 - **number of neutral** cores,
 - **cross section** of cores in mm²,
- **length** of the line in metres,
- **line material** – copper or aluminium.

Based on the above parameters, the calculator will calculate the power loss in the analysed line.

On the second screen, set the parameters defining the financial loss, i.e:

- cost of 1 kWh of active energy,
- cost of 1 kWh of reactive energy at power factor PF ≥ 0.8,
- cost of 1 kWh of reactive energy at power factor PF < 0.8,
- currency.

To change the currency:

- tap the field with the current unit,
- enter a new unit using the on-screen keyboard.

5.9 Inverter efficiency

See **sec. 3.18.1, 3.18.2.**

6 Memory of the meter

6.1 Memory of measurements

6.1.1 Memory settings

①  In the main menu select **Settings**.



②  Select **Memory settings**.



③  Two options will appear.

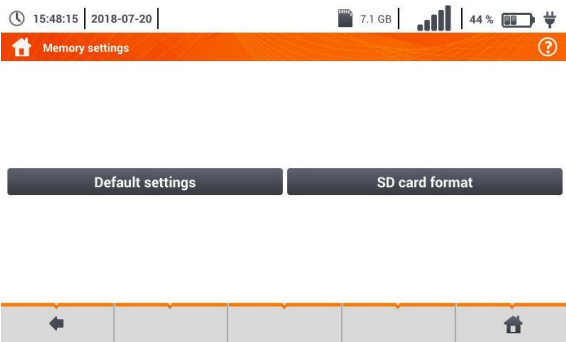

- **Default settings** – restores the meter memory to default memory settings. When this option has been selected, a prompt will appear asking the user to confirm the selection.

- **SD card format**. When this option has been selected, a prompt will appear asking the user to confirm that he/she wants to format the SD card.

Description of function icons

 returning to the previous screen

 returning to the main menu

6.1.2 Structure of the memory

The memory of measurement results is of a tree structure (**Fig. 6.1**). The user can record an unlimited number of clients. Any number of objects with sub-objects can be created in each client.

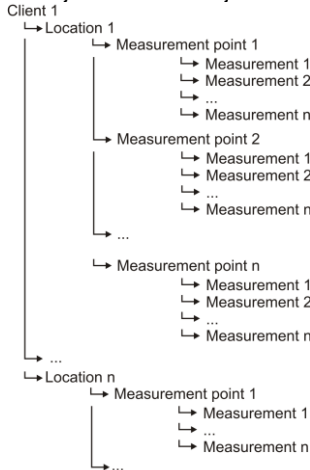
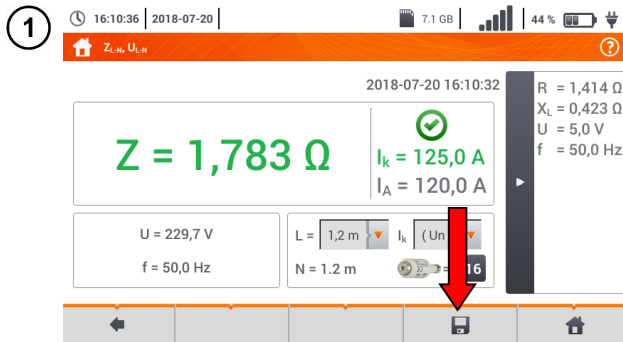



Fig. 6.1. Structure of meter memory for a single client



- The results of measurements performed for all measuring functions can be stored in one cell of the **Measurement points** column.
- Only the results of measurements activated by pressing the **START** button can be stored in the memory (except autozeroing in low-voltage measurement of resistance).
- Complete set of results (main result and supplementary results) for a given measuring function, preset measurement settings, date and time of the measurement are stored in the memory.

6.1.3 Entering the measurement result



- After the measurement, select the  icon.
- The menu Entering the measurement result will appear (the menu and control the same as in **section 6.1.1**).

6.2 Recorder memory

6.2.1 MicroSD memory card

Removable microSD HC card is the primary place of data storage. The following are saved on it:

- recorded measurement data,
- screenshot files.

The top bar shows the status of the card and its free space available.

To ensure proper operation of the meter and prevent data loss, do not:

- remove the memory card during recording. Removal of the card may result in **ending the recording process, damage** of data recorded, and in some cases, **damage to the entire structure of files** saved on the card.
- modify or delete files stored on the card or store your own files on it. If after inserting the card the meter detects an error in the file system, the memory format panel is shown to perform formatting of the card. Only after formatting (which removes all files) it will be possible to reuse the card in the device.

In addition, before removing the card from the meter (e.g. to read the data by *Sonel Analysis*) it is recommended to turn the meter off, to save all cached data.

MicroSD memory card may be formatted from the user interface level. Go to **Analyser settings**, and then select the **Memory** section, where the user can format the selected memory (see also **section 6.1.1**).

6.2.2 USB external memory (flash drive)

Connecting an external USB stick allows user to:

- copy selected files with screenshot from microSD memory card to the memory stick,
- save the log file of the meter, in case of an error in the device in order to perform an analysis in the service of the manufacturer,
- update the firmware of the device.

Supported file systems are FAT32. When a memory formatted in a different file system is inserted, the device will display a window informing that an unformatted media carrier has been detected. From this window, the user may directly enter the formatting screen.

The data on the memory stick are stored in the folder named "MPI-540_DATA".

6.2.3 Compatibility with *Sonel Analysis* software



Sonel Analysis is an application used to work with MPI-540 meter and power analyzers of PQM series. In combination with the above devices it enables to:

- read data from the device,
- present data in the tabular form,
- present data in the form of graphs,
- update firmware of analyzer to new and updating the application itself.

The software operates with Windows XP, Windows Vista, Windows 7, Windows 8 and Windows 10. Detailed manual for "*Sonel Analysis*" is available in a separate document (also downloadable from the manufacturer's website).

6.2.4 PC connection and data transmission

Connection to a computer (PC mode), ensures:

- transmission of data stored in the recorder memory:
 - it is possible to read data from all completed recordings,
- When connected to a PC, the display shows message "PC Connection"
- When connected to a PC, all buttons are locked except  button, unless the recorder operates with key lock mode (e.g. during recording) – then all the buttons are locked. The  icon whose selection interrupts the connection with the PC is displayed on the screen on the bottom bar.
- When within 10 seconds of connecting a PC to the device no data exchange occurs between the device and the computer, the device exits data exchange mode and terminates the connection.

Sonel Analysis software also allows you to read data directly from a microSD card using an external memory card reader. This method allows for the fastest reading of the recorded data. To use this mode, remove the memory card from the meter and put it into the reader connected to a computer (when removing the card, follow the rules described in 6.2.1; it is safe to turn the meter off earlier).

7 Power supply

7.1 Monitoring of the battery charge status

The device is equipped with a Li-Ion battery pack 11.1 V 3.4 Ah. The battery pack includes a circuit monitoring its charge status, which provides precise level of battery pack charge and a temperature sensor.

The charging level of the battery pack is indicated by icon on the top bar of the screen on the right side

7.2 Replacing rechargeable batteries

MPI-540 meter is powered from SONEL Li-Ion rechargeable battery pack.

Battery charger is installed inside the meter and cooperates only with the manufacturer's rechargeable battery pack. The charger is powered by external power supply adapter. It can be also powered from the car cigarette lighter socket. Both the rechargeable battery pack and the adapter are standard components of the meter.



WARNING

If the test leads are left in the terminals during replacement of the batteries, there is a risk of electric shock with a dangerous voltage.

7.3 Charging the rechargeable batteries

Charging the battery pack of the device is started automatically after connecting:

- 2 V DC power supply adapter,
- charging cable for the car cigarette lighter.

Charging is indicated by the  icon next to the battery symbol on the top bar and by the **H.V./REC/CONT.** diode. The temperature of the battery and the ambient temperature influence the charging process. If the battery temperature is below 0°C or higher than 45°C, the charging process is stopped.

8 Technical data

8.1 Basic data

⇒ Abbreviation "m.v." used in the specification of accuracy means standard measured value

8.1.1 Measurement of alternating voltages (True RMS)

Range	Resolution	Accuracy
0.0 V...299.9 V	0.1 V	±(2% m.v. + 4 digits)
300 V...500 V	1 V	±(2% m.v. + 2 digits)

- Frequency range: 45...65 Hz

8.1.2 Frequency measurement

Range	Resolution	Accuracy
45.0 Hz...65.0 Hz	0.1 Hz	±(0.1% m.v. + 1 digit)

- Voltage range: 50 ... 500V

8.1.3 Measurement of fault loop impedance Z_{L-PE} , Z_{L-N} , Z_{L-L}

Measurement of fault loop impedance Z_s

Test range according to IEC 61557-3:

Test lead	Test range Z_s
1.2 m	0.130 Ω...1999.9 Ω
5 m	0.170 Ω...1999.9 Ω
10 m	0.210 Ω...1999.9 Ω
20 m	0.290 Ω...1999.9 Ω
WS-03, WS-04	0.190 Ω...1999.9 Ω

Display range:

Display range	Resolution	Accuracy
0.000...19.999 Ω	0.001 Ω	±(5% m.v. + 0.03 Ω)
20.00...199.99 Ω	0.01 Ω	±(5% m.v. + 0.3 Ω)
200.0...1999.9 Ω	0.1 Ω	±(5% m.v. + 3 Ω)

- Rated operating voltage U_{nL-N} / U_{nL-L} : 110/190 V, 115/200 V, 127/220 V, 220/380 V, 230/400 V, 240/415 V
- Operating voltage range: 95 V...270 V (for Z_{L-PE} and Z_{L-N}) and 95 V...440 V (for Z_{L-L})
- Rated mains frequency f_n : 50 Hz, 60 Hz
- Operating frequency range: 45 Hz...65 Hz
- Maximum test current (for 415 V): 41.5 A (10 ms)
- Control of correctness of PE terminal connection by means of a touch electrode

8.1.4 Measurement of fault loop impedance $Z_{L-PE[RCD]}$ (without triggering of RCD)

Measurement of fault loop impedance Z_s

Test range according to IEC 61557-3:

- 0.50...1999 Ω for 1.2 m leads, WS-03 and WS-04
- 0.51...1999 Ω for 5 m, 10 m and 20 m leads

Display range	Resolution	Accuracy
0...19.99 Ω	0.01 Ω	$\pm(6\% \text{ m.v.} + 10 \text{ digits})$
20.0...199.9 Ω	0.1 Ω	$\pm(6\% \text{ m.v.} + 5 \text{ digits})$
200...1999 Ω	1 Ω	

- It will not trip RCDs of $I_{\Delta n} \geq 30 \text{ mA}$
- Rated operating voltage U_n : 110 V, 115 V, 127 V, 220 V, 230 V, 240 V
- Operating voltage range: 95 V...270 V
- Rated mains frequency f_n : 50 Hz, 60 Hz
- Operating frequency range: 45...65 Hz
- Control of correctness of PE terminal connection by means of a touch electrode

8.1.5 Measurement of parameters of RCD

- Measurement of RCDs type: AC, A, B, B+, F, EV
- Rated operating voltage U_n : 110 V, 115 V, 127 V, 220 V, 230 V, 240 V
- Operating voltage range: 95 V...270 V
- Rated mains frequency f_n : 50 Hz, 60 Hz
- Operating frequency range: 45...65 Hz

RCD trigger and response time test t_A (for measurement function t_A)

Test range according to IEC 61557-6: 0 ms ... to the upper limit of displayed value

Type of RCD	Setting of multiple values	Test range	Resolution	Accuracy
General type ▪ Short-time delay type ▪ AC module in EV type	0.5 $I_{\Delta n}$	0..300 ms (TN/TT)	1 ms	$\pm(2\% \text{ m.v.} + 2 \text{ digits})^{1)}$
	1 $I_{\Delta n}$	0..400 ms (IT)		
	2 $I_{\Delta n}$	0..150 ms		
	5 $I_{\Delta n}$	0..40 ms		
Selective	0.5 $I_{\Delta n}$	0..500 ms		
	1 $I_{\Delta n}$			
	2 $I_{\Delta n}$			
	5 $I_{\Delta n}$			
▪ EV 6 mA DC ▪ RCM	1 $I_{\Delta n}$	0.0..10.0 s	0.1 s	$\pm(2\% \text{ m.v.} + 3 \text{ digits})$
	10 $I_{\Delta n}$	0..300 ms	1 ms	
	33 $I_{\Delta n}^{2)}$	0..100 ms		
	50 $I_{\Delta n}^{3)}$	0..40 ms		

¹⁾ for $I_{\Delta n} = 10 \text{ mA}$ and 0.5 $I_{\Delta n}$ accuracy is $\pm(2\% \text{ m.v.} + 3 \text{ digits})$

²⁾ for measurements acc. to IEC 62955

³⁾ for measurements acc. to IEC 62752

- Accuracy of differential current setting:

for 1* $I_{\Delta n}$, 2* $I_{\Delta n}$, 5* $I_{\Delta n}$ 0..8%
for 0.5* $I_{\Delta n}$ -8..0%

8.1.6 Measurement of resistance-to-earth R_E

Test range according to IEC 61557-5: 0.50 Ω ...1.99 k Ω for test voltage of 50 V and 0.56 Ω ...1.99 k Ω for test voltage of 25 V

Range	Resolution	Accuracy
0.00...0.35 Ω	0.01 Ω	$\pm(2\% \text{ m.v.} + 10 \text{ digits})$
0.35...9.99 Ω	0.01 Ω	$\pm(2\% \text{ m.v.} + 4 \text{ digits})$
10.0...99.9 Ω	0.1 Ω	$\pm(2\% \text{ m.v.} + 3 \text{ digits})$
100...999 Ω	1 Ω	
1.00...1.99 k Ω	0.01 k Ω	

- test voltage: 25 V or 50 V rms
- test current: 20 mA, sinusoidal rms 125 Hz (for $f_n=50$ Hz) and 150 Hz (for $f_n=60$ Hz)
- blocking of measurement at interference voltage of $U_N > 24$ V
- maximum measured voltage of interferences $U_{Nmax}=100$ V
- maximum resistance of auxiliary earth electrodes 50 k Ω

Selective measurement of earthing with clamps

Range	Resolution	Accuracy*
0.00...0.35 Ω	0.01 Ω	$\pm(8\% \text{ m.v.} + 10 \text{ digits})$
0.35...9.99 Ω	0.01 Ω	$\pm(8\% \text{ m.v.} + 4 \text{ digits})$
10.0...99.9 Ω	0.1 Ω	
100...999 Ω	1 Ω	
1.00...1.99 k Ω	0.01 k Ω	

* – at maximum interference current of 1 A

- Measurement with additional current clamps C-3,
- The range of interference current is up to 9.99 A.

Selective measurement of earthing with two clamps

Range	Resolution	Accuracy*
0.00...0.35 Ω	0.01 Ω	$\pm(10\% \text{ m.v.} + 10 \text{ digits})$
0.35...9.99 Ω	0.01 Ω	$\pm(10\% \text{ m.v.} + 4 \text{ digits})$
10.0...19.9 Ω	0.1 Ω	
20.0...99.9 Ω		$\pm(20\% \text{ m.v.} + 4 \text{ digits})$

* – at maximum interference current of 1 A

- Measurement with transmitting clamps N-1 and receiving clamps C-3.
- The range of interference current is up to 9.99 A.

Measuring soil resistivity (ρ)

Range	Resolution	Accuracy
0.0...99.9 Ωm	0.1 Ωm	Depending on the accuracy of the measurement R_E
100...999 Ωm	1 Ωm	
1.00...9.99 k Ωm	0.01 k Ωm	
10.0...99.9 k Ωm	0.1 k Ωm	

- Measurement with Wenner method,
- Option for setting the distance in meters or feet,
- Selecting a distance: 1 m ... 30 m (1 ft ... 90 ft).

8.1.7 Low-voltage measurement of continuity of circuit and resistance

Measurement of continuity of protective conductors and equipotential bonding with 200 mA \pm current

Measurement range according to IEC 61557-4: 0.12...400 Ω

Range	Resolution	Accuracy
0.00...19.99 Ω	0.01 Ω	$\pm(2\% \text{ m.v.} + 3 \text{ digits})$
20.0...199.9 Ω	0.1 Ω	
200...400 Ω	1 Ω	

- Voltage at open terminals: 4 V...9 V
- Output current at $R < 2 \Omega$: min. 200 mA (I_{sc} : 200 mA..250 mA)
- Compensation of test leads resistance
- Measurements for both current polarizations

Measurement of resistance with low current

Range	Resolution	Accuracy
0.0...199.9 Ω	0.1 Ω	$\pm(3\% \text{ m.v.} + 3 \text{ digits})$
200...1999 Ω	1 Ω	

- Voltage at open terminals: 4 V...9 V
- Output current < 8 mA
- Audio signal for measured resistance < 30 $\Omega \pm 50\%$
- Compensation of test leads resistance

8.1.8 Measurement of insulation resistance

Measurement range, according to IEC 61557-2 for $U_N = 50 \text{ V}$: 50 k Ω ...250 M Ω

Display range for $U_N = 50 \text{ V}$	Resolution	Accuracy
0 k Ω ...1999 k Ω	1 k Ω	$\pm(3\% \text{ m.v.} + 8 \text{ digits})$, [$\pm(5\% \text{ m.v.} + 8 \text{ digits})$] *
2.00 M Ω ...19.99 M Ω	0.01 M Ω	
20.0 M Ω ...199.9 M Ω	0.1 M Ω	
200 M Ω ...250 M Ω	1 M Ω	

* – for WS-03 and WS-04 leads

Test range according to IEC 61557-2 for $U_N = 100 \text{ V}$: 100 k Ω ...500 M Ω

Display range for $U_N = 100 \text{ V}$	Resolution	Accuracy
0 k Ω ...1999 k Ω	1 k Ω	$\pm(3\% \text{ m.v.} + 8 \text{ digits})$ [$\pm(5\% \text{ m.v.} + 8 \text{ digits})$] *
2.00 M Ω ...19.99 M Ω	0.01 M Ω	
20.0 M Ω ...199.9 M Ω	0.1 M Ω	
200 M Ω ...500 M Ω	1 M Ω	

* – for WS-03 and WS-04 leads

Test range according to IEC 61557-2 for $U_N = 250 \text{ V}$: 250 k Ω ...999 M Ω

Display range for $U_N = 250 \text{ V}$	Resolution	Accuracy
0 k Ω ...1999 k Ω	1 k Ω	$\pm(3\% \text{ m.v.} + 8 \text{ digits})$ [$\pm(5\% \text{ m.v.} + 8 \text{ digits})$] *
2.00 M Ω ...19.99 M Ω	0.01 M Ω	
20.0 M Ω ...199.9 M Ω	0.1 M Ω	
200 M Ω ...999 M Ω	1 M Ω	

* – for WS-03 and WS-04 leads

Test range according to IEC 61557-2 for $U_N = 500 \text{ V}$: 500 k Ω ...2,00 G Ω

Display range for $U_N = 500 \text{ V}$	Resolution	Accuracy
0...1999 k Ω	1 k Ω	$\pm(3\% \text{ m.v.} + 8 \text{ digits})$ $[\pm(5\% \text{ m.v.} + 8 \text{ digits})]^*$
2.00...19.99 M Ω	0.01 M Ω	
20.0...199.9 M Ω	0.1 M Ω	
200...999 M Ω	1 M Ω	$\pm(4\% \text{ m.v.} + 6 \text{ digits})$ $[\pm(6\% \text{ m.v.} + 6 \text{ digits})]^*$
1.00...2.00 G Ω	0.01 G Ω	

* – for WS-03 and WS-04 leads

Test range according to IEC 61557-2 for $U_N = 1000 \text{ V}$: 1000 k Ω ...4,99 G Ω

Display range for $U_N = 1000 \text{ V}$	Resolution	Accuracy
0...1999 k Ω	1 k Ω	$\pm(3\% \text{ m.v.} + 8 \text{ digits})$
2.00...19.99 M Ω	0.01 M Ω	
20.0...199.9 M Ω	0.1 M Ω	
200...999 M Ω	1 M Ω	$\pm(4\% \text{ m.v.} + 6 \text{ digits})$
1.00...4.99 G Ω	0.01 G Ω	
5.00...9.99 G Ω	0.01 G Ω	unspecified

- Test voltage: 50 V, 100 V, 250 V, 500 V i 1000 V
- Accuracy of generated voltage (Robc [Ω] $\geq 1000 \cdot U_N$ [V]): -0% +10% from the set value
- Detection of a dangerous voltage before commencing a measurement
- Discharging the object tested
- Measurement of insulation resistance with the use of UNI-Schuko plug (WS-03, WS-04) between all three terminals (for $U_N=1000 \text{ V}$ is not available)
- Insulation resistance measurement for multi-wire cables (max. 5) using an optional external AutoISO-1000c adapter
- Measurement of voltage on terminals + R_{ISO} , - R_{ISO} within the range of: 0 V...440 V
- Test current < 2 mA

8.1.9 Light measurements

Measuring ranges of LP-1 probe

Range [lx]	Resolution [lx]	Spectral uncertainty	Accuracy
0...399.9	0.1	f1 < 6%	$\pm(5\% \text{ m.v.} + 5 \text{ digits})$
400...3999	1		
4.00 k...19.99 k	0.01 k		

- Probe class B

Measuring ranges of LP-10B probe

Range [lx]	Resolution [lx]	Spectral uncertainty	Accuracy
0...39.99	0.01	f1 < 6%	$\pm(5\% \text{ m.v.} + 5 \text{ digits})$
40.0...399.9	0.1		
400...3999	1		
4.00 k...39.99 k	0.01 k		
40.0 k...399.9 k	0.1 k		

- Probe class B

Measuring ranges of LP-10A probe

Range [Ix]	Resolution [Ix]	Spectral uncertainty	Accuracy
0...3.999	0.001	f1 < 2%	±(2% m.v. + 5 digits)
4.00...39.99	0.01		
40.0...399.9	0.1		
400...3999	1		
4.00 k...39.99 k	0.01 k		
40.0 k...399.9 k	0.1 k		

- Probe class A

8.1.10 Phase sequence

- Phase sequence indication: in the same direction (correct), opposite direction (incorrect)
- Range of network voltages U_{L-L} : 95 V...500 V (45 Hz...65 Hz)
- Display of phase-to-phase voltages

8.1.11 Motor rotation

- SEM motor voltage ranges: 1 V ÷ 500 V AC
- Test current (per phase): < 3,5 mA

8.1.12 **MPI-540-PV** Measurement of open circuit DC voltage U_{oc}

Range	Resolution	Accuracy
0.0 V...299.9 V	0.1 V	±(3% m.v. + 5 digits)
300 V...1000 V	1 V	±(3% m.v. + 2 digits)

8.1.13 **MPI-540-PV** Measurement of short circuit DC current I_{sc}

Range	Resolution	Accuracy
0.00 A...20.00 A	0.01 A	±(3% m.v. + 0,10 A)

- Before the measurement reset the clamp

8.2 Recorder data

Recorder class: compliance with EN 61000-4-30:2015 class S.

8.2.1 Inputs

Voltage input terminals

Number of inputs	4 (L1, L2, L3, N - 3 measuring channels) not galvanically insulated from one another
Maximum input voltage	L1, L2, L3, N: 500 V _{RMS} relative to earth.
Peak input voltage (without cutting)	1150 V (L-N)
Analogue transmission band (-3 dB)	12 kHz
Transformers	defined by user
Impedance of measurement inputs	14 MΩ (L-L, L-N)
CMRR	>70 dB (50 Hz)

Current input terminals

Number of inputs	3 (L1, L2, L3) not galvanically insulated from one another
Maximum peak input voltage	5 V relative to earth
Nominal input voltage (hard clamps)	1 V _{RMS}
Peak input voltage (hard clamps, without cutting)	3.6 V
Analogue transmission band (-3dB)	12 kHz
Input Impedance	Path for hard clamps: 100 kΩ Path for flexible clamps: 12.4 kΩ
Measurement range (without transformers)	Flexible clamps F-1(A)/F-2(A)/F-3(A): 1..3000 A (10000 A peak, 50 Hz) Hard clamps C-4(A), C-5(A): 1..1000 A (3600 A peak) Hard clamps C-6(A): 0,01..10 A (36 A peak) Hard clamps C-7(A): 0..100 A (360 A peak)
Transformers	defined by user
CMRR	60 dB (50 Hz)

8.2.2 Sampling and RTC

A/C converter	16-bit
Sampling rate	5.12 kHz for 50 Hz and 60 Hz Simultaneous sampling in all channels
Samples per period	102.4 for 50 Hz; 85.33 for 60 Hz
PLL synchronization	40..70 Hz
Reference channel for PLL	L1-N, L1-L2 (depending on the type of network)
Real-time clock	±30 ppm (approx. ±2.6 s/day)

8.2.3 Voltage measurement

Voltage	Range and conditions	Resolution	Accuracy
U _{RMS} (AC+DC)	20% U _{nom} ≤ U _{RMS} ≤ 120% U _{nom} for U _{nom} ≥ 100 V	0.1% U _{nom}	±0.5% U _{nom}
Crest factor	1..10 (1..2.2 for voltage 500 V) for U _{RMS} ≥ 10% U _{nom}	0.01	±5%

8.2.4 Measurement of current (True RMS)

Current	Range and conditions	Resolution	Accuracy
I _{RMS} (AC+DC)	Accuracy of the device		
	10% I _{nom} ≤ I _{RMS} < 100% I _{nom}	0.01% I _{nom}	±2%
	Flexible clamps F-1A/F-2A/F-3A		
	0..3000 A (10 kA _{p-p} @ 50Hz)	0.01% I _{nom}	Additional uncertainty ±1% (±2% taking into account additional error due to the position)
	Hard clamps C-4A		
	0..1000 A (3600 A _{p-p})	0.01% I _{nom}	Additional uncertainty 0.1..10 A: ± (3% + 0.1 A) 10 A: ±3% 50 A: ±1.5% 200 A: ±0.75% 1000..1200 A: ±0.5%
	Hard clamps C-5A		
	0..1000 A (3600 A _{p-p})	0.01% I _{nom}	Additional uncertainty 0.5..100 A: ≤ (1.5% + 1 A) 100..800 A: ≤ 2.5% 800..1000 A AC: ≤ 4% 800..1400 A DC: ≤ 4%
	Hard clamps C-6A		
0..10 A (36 A _{p-p})	0.01% I _{nom}	Additional uncertainty 0.01..0.1 A: ± (3% + 1 mA) 0.1..1 A: ±2,5% 1..12 A: ±1%	
Hard clamps C-7A			
0..100 A (360 A _{p-p})	0.01% I _{nom}	Additional uncertainty 0..100 A: ± (0,5% + 0,02 A) (45..65 Hz) 0..100 A: ± (1,0% + 0,04 A) (40..1000 Hz)	
Crest factor	1..10 (max. 3.6 for I _{nom}) for I _{RMS} ≥ 1% I _{nom}	0.01	±5%

8.2.5 Frequency measurement

Frequency	Range and conditions	Resolution	Accuracy
f	40..70 Hz 15% U _{nom} ≤ U _{RMS} ≤ 120% U _{nom}	0.01 Hz	±0,05 Hz

8.2.6 Measuring harmonics

Harmonics	Range and conditions	Resolution	Accuracy
Harmonic (n)	DC, 1..40, grouping: harmonics sub-groups acc. to EN 61000-4-7		
U _{RMS} amplitude	0..200% U _{nom}	0.01% I _{nom}	±0.15% U _{nom} if m.v.<3% U _{nom} ±(5% + 0,1% × n) m.v. if m.v.≥ 3% U _{nom}
I _{RMS} amplitude	Depending clamps used (see specifications for I _{RMS})	0.01% I _{nom}	±0.5% I _{nom} if m.v.<10% I _{nom} ±(5% + 0,1% × n) m.v. if m.v.≥ 10% I _{nom}
Voltage THD-F (n = 2..40)	0.0...100.0% for U _{RMS} ≥ 1% U _{nom}	0.1%	±5%
current THD-F (n = 2..40)	0.0...100.0% for I _{RMS} ≥ 1% I _{nom}	0.1%	±5%

8.2.7 Unbalance

Unbalance (voltage and current)	Range and conditions	Resolution	Accuracy
Unbalance factor for positive, negative and zero sequence	0.0% ... 10.0% for 80% U _{nom} ≤ U _{RMS} < 150% U _{nom}	0.1%	±0.15% (absolute uncertainty)

8.2.8 Power and energy measurement

Power and energy	Conditions (for power and energy 80% U _{nom} ≤ U _{RMS} < 120% U _{nom})	Resolution	Accuracy
Active power Active energy	2% I _{nom} ≤ I _{RMS} < 5% I _{nom} cosφ = 1	depending on U _{nom} and I _{nom}	± √(2,5 ² + δ _{ph} ²) %
	5% I _{nom} ≤ I _{RMS} ≤ I _{nom} cosφ = 1		± √(2,0 ² + δ _{ph} ²) %
	5% I _{nom} ≤ I _{RMS} < 10% I _{nom} cosφ = 0.5		± √(2,5 ² + δ _{ph} ²) %
	10% I _{nom} ≤ I _{RMS} ≤ I _{nom} cosφ = 0.5		± √(2,0 ² + δ _{ph} ²) %
Reactive power Reactive energy	2% I _{nom} ≤ I _{RMS} < 5% I _{nom} sinφ = 1	depending on U _{nom} and I _{nom}	± √(4,0 ² + δ _{ph} ²) %
	5% I _{nom} ≤ I _{RMS} < I _{nom} sinφ = 1		± √(3,0 ² + δ _{ph} ²) %
	5% I _{nom} ≤ I _{RMS} < 10% I _{nom} sinφ = 0.5		± √(4,0 ² + δ _{ph} ²) %
	10% I _{nom} ≤ I _{RMS} < I _{nom} sinφ = 0.5		± √(3,0 ² + δ _{ph} ²) %
	10% I _{nom} ≤ I _{RMS} < I _{nom} sinφ = 0.25		± √(4,0 ² + δ _{ph} ²) %
Apparent power Apparent energy	2% I _{nom} ≤ I _{RMS} < 5% I _{nom}	depending on U _{nom} and I _{nom}	±2.5%
	5% I _{nom} ≤ I _{RMS} ≤ I _{nom}		±2.0%
Power factor (PF)	0...1 50% U _{nom} ≤ U _{RMS} < 150% U _{nom} 10% I _{nom} ≤ I _{RMS} < I _{nom}	0.01	±0.03
Displacement power factor (cosφ/ DPF)	0...1 50% U _{nom} ≤ U _{RMS} < 150% U _{nom} 10% I _{nom} ≤ I _{RMS} < I _{nom}	0.01	±0.03

8.3 Other technical data

- a) type of insulation acc. to EN 61010-1 and IEC 61557 double
- b) measurement category acc. to EN 61010-2-030 IV 300 V, III 500 V, **MPI-540-PV** II 1000 V DC
- c) ingress protection acc. to EN 60529 IP51 (terminals sealed with silicone stopper)
- d) power supply of the meter Li-Ion 11,1 V 3,4 Ah 37,7 Wh
- e) parameters of AC adapter for the battery charge 12 V DC / 2,5 A
..... 100 V .. 240 V, 50 Hz .. 60 Hz (power grid)
- f) dimensions 288 mm x 223 mm x 75 mm
- g) weight of the meter with batteries approx. 2,5 kg
- h) storage temperature -20°C...+60°C
- i) working temperature 0°C...+45°C
- j) temperature range suitable for initiating battery charging +10°C...+40°C
- k) temperatures at which loading is interrupted <+5 °C and ≥ +50°C
- l) humidity 20%...90%
- m) reference temperature +23°C ± 2°C
- n) reference humidity 40%...60%
- o) altitude (above sea level) <2000 m
- p) time settings for automatic shut-down when idle (Auto-OFF) 2 min, 5 min or disabled
- q) number of measurements Z or RCD (for charged batteries) >3000 (6 measurements per minute)
- r) number of measurements Riso or R (for charged batteries) >1000
- s) time of recording (for charged batteries) 16 h
- t) display color LCD TFT with polytouch,
..... 800 x 480 pixels,
..... diagonal 7"
- u) memory of measurement results unlimited
- v) recorder memory unlimited
- w) data transmission USB
- x) quality standard
..... design, construction and manufacturing are ISO 9001, ISO 14001, ISO 45001 compliant
- y) the device meets the requirements of IEC 61557 standard
- z) the product meets EMC requirements (immunity for industrial environment) according to the following standards EN 61326-1 and EN 61326-2-2



EN 55022 Compliance statement

MPI-540 / MPI-540-PV is a class A product. In a domestic environment this product may cause radio interference in which case the user may be required to take adequate measures (e.g. increasing the distance between affected products).



SONEL S.A. hereby declares that the radio device type MPI-540 / MPI-540-PV complies with Directive 2014/53/EU. The full text of the EU Declaration of Conformity is available at the following website address: <https://sonel.pl/en/download/declaration-of-conformity/>

NOTES

NOTES

MEASURING MESSAGES



NOTE!

The meter is designed for operation at rated phase voltages of 110 V, 115 V, 127 V, 220 V, 230 V and 240 V and phase-to-phase voltages of 190 V, 200 V, 220 V, 380 V, 400 V, 415 V.

Connecting voltage higher than allowed between any of the test terminals may damage the meter and cause a hazard to the user.

Z_s measurement

L-N!

U_{L-N} voltage is incorrect for making a measurement.

L-PE!

U_{L-PE} voltage is incorrect for making a measurement.

N-PE!

U_{N-PE} voltage exceeds allowable value of 50 V.



Phase connected to N terminal instead of L terminal (for example, exchange of L and N in the mains socket).

TEMPERATURE!

Maximum temperature of the meter is exceeded.

f!

Network frequency is outside the range of 45 Hz...65 Hz.

ERROR!

Measurement error. Correct result cannot be displayed.

Loop circuit malfunction!

The meter should be serviced.

U>500V!

and continuous audio signal

Before measurement, voltage at test terminals exceeds 500 V.

VOLTAGE!

The voltage on the tested object is not within the limits specified for the set rated voltage of the network U_n .

LIMIT!

Too low value of the prospective short circuit current I_k for the pre-set fuse and time of its triggering.

R_E measurement

VOLTAGE!

Too high voltage at the meter terminals.

H!

Interruption in the test probe circuit.

S!

Interruption in the voltage probe circuit.

R_E>1.99 kΩ

Measuring range is exceeded.

NOISE!

Signal / noise ratio is too low (interfering signal too large).

LIMIT!

Measurement uncertainty R_E due to the resistance of electrodes >30 %. (For calculating uncertainty, measured values are taken into account).



Interruption in measuring circuit or resistance of test probes is higher than 60 kΩ.

RCD measurement

U_B>U_L!

The touch voltage exceeds a preset U_L threshold value.

!

displayed on the right side of the result indicates a fault of RCD.

PE!

and continuous audio signal

Voltages between the contact electrode and PE conductor exceeds the allowable limit value of U_L .

R_{iso} measurement



and continuous audio signal

Voltage detected on terminals of the meter. Measurement is not possible.

NOISE!

Interference voltage occurs on the tested object. Measurement is possible but may be burdened with additional uncertainty.

LIMIT!

Current limit tripped. The symbol displayed during the measurement is accompanied by a continuous beep. If it is displayed after the measurement, it means that the measurement result was obtained during operation with a current limiting device (e.g. short circuit of the test object).



SONEL S.A.

Wokulskiego 11
58-100 Świdnica
Poland

Customer Service

tel. +48 74 884 10 53
e-mail: customerservice@sonel.com

www.sonel.com