

USER MANUAL

POWER QUALITY ANALYZERS

**PQM-702 • PQM-702T • PQM-703
PQM-710 • PQM-711**



USER MANUAL

POWER QUALITY ANALYZERS

PQM-702
PQM-702T
PQM-703
PQM-710
PQM-711



SONEL S.A.
Wokulskiego 11
58-100 Świdnica
Poland



Due to continuous product development, the manufacturer reserves the right to make changes to functionality, features and technical parameters of the analyzers. This manual describes the firm-ware version 1.52 and the Sonel Analysis v4.4.2 software.

CONTENTS

1	General Information	6
1.1	Safety	6
1.2	General characteristics	8
1.3	Power supply of the analyzer	11
1.4	Tightness and outdoor operation	12
1.5	Mounting the fasteners	13
1.6	Mounting on DIN rail	14
1.7	Measured parameters	15
2	Operation of the analyzer	17
2.1	Buttons	17
2.2	Switching the analyzer ON/OFF	17
2.3	Auto-off	17
2.4	Screens	18
2.5	Verifying the connection	23
2.6	"Sonel Analysis" software	24
2.7	PC connection and data transmission	24
2.7.1	USB communication	25
2.7.2	Radio communication via OR-1	PQM-702 PQM-702T PQM-703 26
2.7.3	Communication via GSM network	26
2.7.4	Radio communication via Wi-Fi	PQM-710 PQM-711 27
2.8	Taking measurements	28
2.8.1	Measurement Points	28
2.8.2	Start / stop of recording	29
2.8.3	Recording configuration	29
2.8.4	Approximate recording times	30
2.9	Measuring circuits	32
2.10	Inrush current	39
2.11	Example of use	40
2.12	Time Synchronization	45
2.12.1	Requirements of IEC 61000-4-30	45
2.12.2	GPS receiver	45
2.12.3	Data flagging concept	45
2.12.4	Time resynchronization	46
2.13	GSM communication mode	47
2.13.1	General information about GSM connection	47
2.13.2	Modem Configuration	47
2.13.3	Checking GSM connection	49
2.13.4	Possible problems with GSM settings and troubleshooting	50
2.14	Wi-Fi communication mode	PQM-710 PQM-711 52
2.14.1	General Information	52
2.14.2	Factory configuration	52
2.14.3	Access Point mode	52
2.14.4	Client mode	55
2.14.5	Checking Wi-Fi connection	59
2.14.6	Possible problems with Wi-Fi and troubleshooting	60
2.15	Notification of analyzer changed location	61
2.16	Key lock	62









2.17 LCD sleep mode	62
2.18 Temperature protection.....	62
2.19 Emergency time setting.....	63
3 Design and measurement methods	64
3.1 Voltage inputs	64
3.2 Current inputs.....	64
3.3 Digital integrator.....	64
3.4 Signal sampling.....	65
3.5 PLL synchronization.....	65
3.6 Frequency measurement	66
3.7 The method for measuring harmonics.....	66
3.8 The method for measuring interharmonics.....	67
3.9 Measurement of ripple control signals.....	68
3.10 Measurement of transients PQM-703 PQM-711	68
3.10.1 Threshold method.....	70
3.10.2 Slew rate (dV/dt) method	70
3.11 Current limiting function	70
3.12 Event detection	72
3.12.1 Waveshape variation events.....	74
3.12.2 Phase jump events	75
3.12.3 Rapid Voltage Changes (RVC) events.....	75
3.13 Methods of parameter's averaging.....	76
4 Calculation formulas.....	77
4.1 One-phase network.....	77
4.2 Split-phase network.....	81
4.3 3-phase wye network with N conductor (3-phase, 4-wire).....	83
4.4 3-phase wye without N conductor and delta networks	85
5 Power quality - a guide.....	87
5.1 Basic information.....	87
5.1.1 Current Transformer (CT) probes for measuring alternating currents (AC).....	87
5.1.2 Probes for measuring alternating and direct currents (AC/DC).....	88
5.1.3 Flexible probes	89
5.2 Flicker	89
5.3 Power and energy measurement	90
5.3.1 Active power.....	90
5.3.2 Reactive power.....	91
5.3.3 Reactive power and three-wire systems.....	94
5.3.4 Reactive power and reactive energy counters.....	95
5.3.5 4-quadrant reactive energy measurement.....	96
5.3.6 Apparent power	97
5.3.7 Distortion power D_B and effective apparent power S_{eN}	98
5.3.8 Power Factor	99
5.4 Harmonics.....	99
5.4.1 Harmonics active power.....	100
5.4.2 Harmonics reactive power	101
5.4.3 Harmonics in three-phase systems	102
5.4.4 Total Harmonic Distortion	103
5.4.5 TDD - Total Demand Distortion.....	104
5.4.6 K-Factor.....	104
5.5 Interharmonics	105

5.5.1	Total Interharmonic Distortion	106
5.6	Mains signalling.....	106
5.7	Unbalance.....	108
5.8	Voltage dips, swells and interruptions	109
5.9	Rapid Voltage Changes (RVC)	111
5.10	Transients and overvoltages	112
5.11	CBEMA and ANSI curves.....	114
5.12	Averaging the measurement results.....	116
6	Technical data	119
6.1	Inputs	119
6.2	Sampling and RTC.....	120
6.3	Transient module PQM-703 PQM-711	120
6.4	Measured parameters - accuracy, resolution and ranges	121
6.4.1	Reference conditions	121
6.4.2	The measurement uncertainty due to ambient temperature	121
6.4.3	Voltage	121
6.4.4	Current	122
6.4.5	Frequency	123
6.4.6	Harmonics	123
6.4.7	Interharmonics	123
6.4.8	Harmonic Powers	123
6.4.9	Power and energy.....	124
6.4.10	Estimating measurement uncertainty values for power and energy.....	124
6.4.11	Flicker.....	126
6.4.12	Unbalance	126
6.4.13	Mains signalling.....	126
6.4.14	Transients PQM-703 PQM-711	126
6.4.15	External temperature PQM-702T	127
6.5	Event detection - dips, swells, interruptions, RVC, RMS current.....	127
6.6	Event detection - other parameters	128
6.6.1	Event detection hysteresis	129
6.7	Recording.....	129
6.8	Power supply, battery, heater.....	131
6.9	Supported mains types	132
6.10	Supported current probes	132
6.11	Communication	133
6.12	Environmental conditions and other technical data	133
6.13	Safety and electromagnetic compatibility	134
6.14	Standards.....	135
6.14.1	Compliance with standards	135
6.14.2	Product specification according to IEC 62586	137
7	Optional accessories	138
8	Other Information.....	140
8.1	Cleaning and maintenance.....	140
8.2	Storage	140
8.3	Dismantling and utilization.....	140
8.4	Manufacturer.....	140

1 General Information

PQM-703 *The icon with the analyzer name is placed next to sections of the text that refer to specific features of the analyzer, particularly to availability/unavailability of a given function.
All other parts of the text relate to all types of the analyzer.*

The following international symbols are used on the analyzer and in this manual:

	Warning; See explanation in manual		Functional earth terminal		Alternating voltage/ current
	Direct voltage/ current		Double Insulation (Protection Class)		Conforms to relevant European Union directives (<i>Conformité Européenne</i>)
	Do not dispose of this product as un- sorted municipal waste		Recycling information		Conforms to relevant Australian standards

1.1 Safety



To avoid electric shock or fire, you must observe the following guidelines:

- Before you proceed to operate the analyzer, acquaint yourself thoroughly with the present manual and observe the safety regulations and specifications provided by the producer.
- Any application that differs from those specified in the present manual may result in damage to the device and constitute a source of danger for the user.
- Analyzers must be operated only by appropriately qualified personnel with relevant certificates authorizing the personnel to perform works on electric systems. Operating the analyzer by unauthorized personnel may result in damage to the device and constitute a source of danger for the user.
- The device must not be used for networks and devices in areas with special conditions, e.g. fire-risk and explosive-risk areas.
- Before starting the work, check the analyzer, wires, current probes and other accessories for any sign of mechanical damage. Pay special attention to the connectors.
- It is unacceptable to operate the device when:
 - ⇒ it is damaged and completely or partially out of order,
 - ⇒ its cords and cables have damaged insulation,
 - ⇒ of the device and accessories mechanically damaged.
- Do not power the analyzer from sources other than those listed in this manual.
- Do not connect inputs of the analyzer to voltages higher than the rated values.

1 General Information

- Use accessories and probes with a suitable rating and measuring category for the tested circuit.
- Do not exceed the rated parameters of the lowest measurement category (CAT) of the used measurement set consisting of the analyzer, probes and accessories. The measurement category of the entire set is the same as of the component with the lowest measurement category.
- If possible, connect the analyzer to the de-energized circuits.
- Use the PE (earth) terminal only for connecting the local ground, do not connect it to any voltage.
- Opening the device socket plugs results in the loss of its tightness, leading to a possible damage in adverse weather conditions. It may also expose the user to the risk of electric shock.
- Do not handle or move the device while holding it only by its cables.
- Do not unscrew the nuts from the cable glands, as they are permanently fixed. Unscrewing the nuts will void the guarantee.
- **PQM-702T** It is not allowed to mount ST-2 temperature probe on objects with voltage higher than 50 V to earth. It is advisable to ground the examined object before mounting the probe.
- Repairs may be performed only by an authorized service point.

The analyzer is equipped with an internal Li-Ion battery, which has been tested by an independent laboratory and is quality-certified for compliance with the standard *UN Manual of Tests and Criteria Part III Subsection 38.3 (ST/SG/AC.10/11/Rev.5)*. Therefore, the analyzer is approved for air, maritime and road transport.

1.2 General characteristics

Power Quality Analyzers PQM-702(T), PQM-703, PQM-710 and PQM-711 (Fig. 1) are high-tech devices providing their users with a comprehensive features for measuring, analyzing and recording parameters of 50/60 Hz power networks and power quality in accordance with the European Standard EN 50160. Analyzers are fully compliant with the requirements of IEC 61000-4-30:2015, Class A.

The device is equipped with five voltage measurement inputs installed as cables terminated with banana plugs marked as L1/A, L2/B, L3/C, N and PE (ground). The range of voltages measured by four measurement channels is up to 760 V_{RMS} or 1000 V_{RMS} referred to ground (depending on rating). This range may be increased by using additional external voltage transformers.

Measurements are carried out using four current inputs installed on short cables terminated with probe terminals. The terminals may be connected to the following probe types: flexible probes (marked as F-1(A), F-2(A)(HD), F-3(A)(HD)) with nominal rating of 3000 A (differing from others only by coil diameter); F-1A6, F-2A6, F-3A6 probes with nominal range of 6000 A, F-1A1, F-2A1, F-3A1 probes with nominal range of 1500 A and CT probes marked as C-4(A) (range up to 1000 A AC), C-5A (up to 1000 A AC/DC), C-6(A) (up to 10 A AC) and C-7(A) (up to 100 A AC). The values of nominal measured currents may be changed by using additional transducers – for example, using a transducer of 1000:5 ratio, the user may select C-6(A) probes to measure currents up to 1000 A.

The device has a built-in 8 GB memory card. To guarantee fast data read-out, the analyzer is equipped with a built-in mass-storage reader, which ensures the data readout with a few MB/s. Data read-out may be also be carried out by one of the available communication links: USB, OR-1 radio receiver (PQM-702(T) and PQM-703 only), Wi-Fi (PQM-710 and PQM-711 only) and GSM modem.

The device is provided with a built-in GSM modem (UMTS standard) and an antenna. This solution provides it with almost unrestricted access to the analyzer from any chosen global location with available GSM network. On the left side of its housing the analyzer has a SIM card, which is required for data transmission via GSM networks.

Another advantage of the device is a built-in GPS receiver with antenna, making the analyzer fully compliant with the requirements of IEC 61000-4-30 Class A, without the need of installing additional accessories. The GPS receiver ensures the synchronization with UTC (Universal Time Clock), and provides measurement accuracy of tens of nanoseconds. GPS receivers may receive satellite signals in the open air; therefore synchronization with a built-in antenna is possible only outside of buildings. When the analyzer is used indoors, in order to ensure the availability of the GPS signal, the device should be connected to an external GPS antenna (cable length: 10 m) located outside the building. External antenna is an additional accessory.

Tab. 1. Main differences between analyzers

	PQM-702	PQM-702T	PQM-703	PQM-710	PQM-711
Transient module			•		•
433 MHz radio interface (with OR-1 receiver)	•	•	•		
Wi-Fi radio interface				•	•
External temperature measurement (with ST-2 probe)		•			

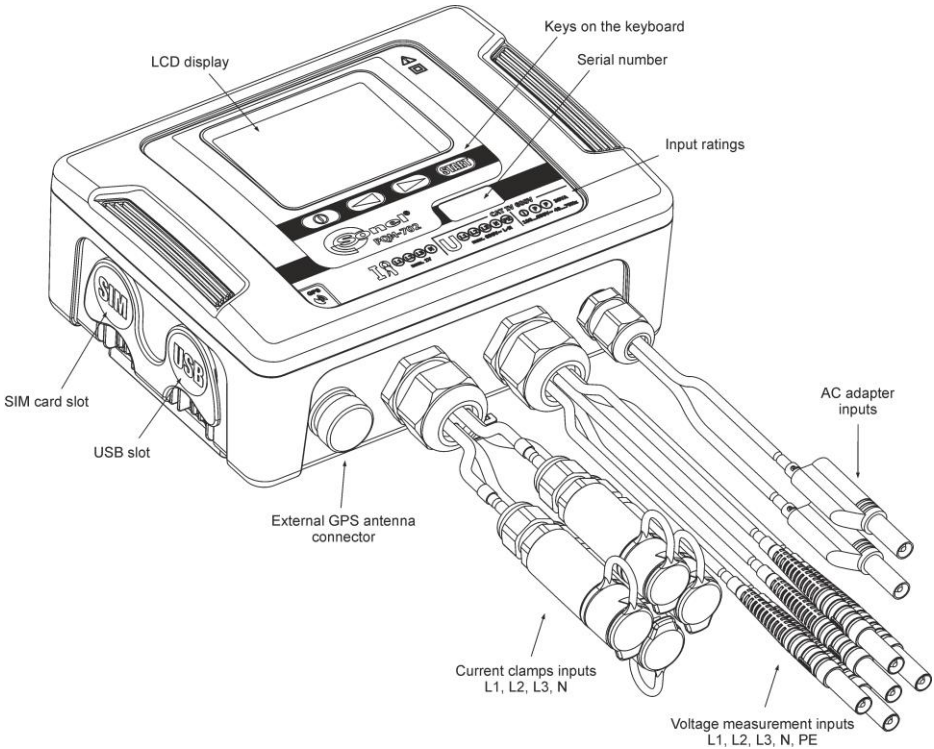

Fig. 1. Power Quality Analyzer. General view.

Recorded parameters are divided into groups that may be independently turned on/off for recording purposes and this solution facilitates the rational management of the space on the memory card. Parameters that are not recorded, leave more memory space for further measurements.

PQM-702T

PQM-702T power supply quality analyzer is a variant of PQM-702 analyzer and it additionally enables measurements of the temperature of external objects with ST-2 probe (standard accessory). Other capabilities and functions of PQM-702T analyzer are the same as in PQM-702.

The terminal for connecting the probe is in the pass together with current probe terminals and it is marked with the letter "T".

Unless stated otherwise, in the following part of the manual, all sections referring to PQM-702 analyzer also apply to PQM-702T.

The analyzer has an internal power supply adapter operating in a wide input voltage range 100...690 V AC (140...690 V DC), which is provided with independent cables terminated with banana plugs.

An important feature of the device is its ability to operate in harsh weather conditions - the analyzer may be installed directly on electric poles. The ingress protection class of the analyzer is IP 65, and operating temperature ranges from -20°C to +55°C.

Uninterrupted operation of the device (in case of power failure) is ensured by an internal rechargeable lithium-ion battery.

The user interface includes a color 3.5" LCD display with a resolution of 320x240 pixels and a keypad with four buttons.

The full potential of the device may be released by using dedicated PC software "Sonel Analysis".

The analyzer may communicate with a PC in the following ways:

- via USB connection with a transmission speed up to 921.6 kbit/s; available data reading from a memory card with a speed of a few MB/s,
- **PQM-702 PQM-703** via radio interface – using OR-1 receiver with a transmission rate of 57.6 kbit/s (range limited to approx. 5 m),
- **PQM-710 PQM-711** via Wi-Fi radio interface with effective transmission rate up to 300 kB/s (max. sustained speed in a 10 m distance),
- via GSM connection using the Internet.

PQM-702 PQM-703 In order to use the first mode of wireless communication, OR-1 receiver must be connected to a PC using its USB port. Communication in this mode is slower, therefore we recommend it to view current (live) parameters of the measured network and to configure and control the analyzer. It is not recommended to read a large amount of data stored on the memory card via a radio link, due to the slower data transmission.

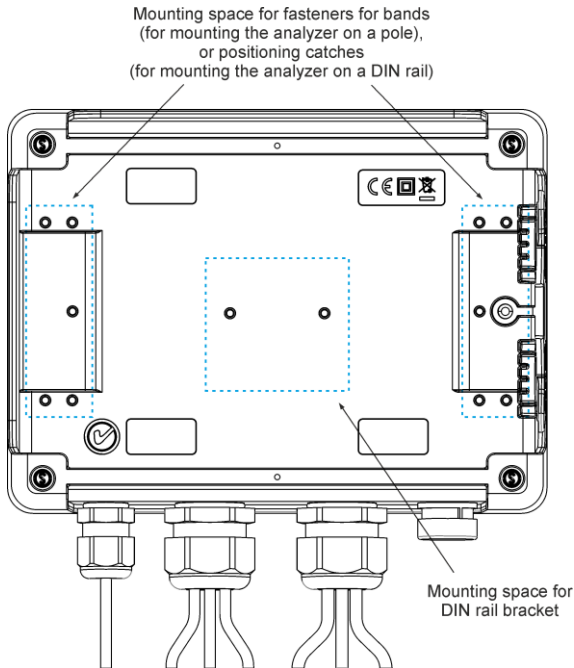

Fig. 2. The rear wall of the analyzer.

1 General Information

GSM network transmission requires an active user's SIM card to be inserted into the slot of the analyzer. The card should have the service of data transmission activated and a static IP number. A PC connected to the analyzer, must have the Internet access.

PQM-703 **PQM-711** Compared to PQM-702 and PQM-710 models, PQM-703 and PQM-711 analyzers additionally enables the user to measure transient voltages in the range of ± 8 kV with sampling rate from 100 kHz to 10 MHz. Measuring circuits for transients are independent from the rest of voltage circuits and connected to voltage inputs L1/A, L2/B, L3/C, N, PE. The analyzers have four measurement channels: L1/A-PE, L2/B-PE, L3/C-PE and N-PE. Recording time waveforms is done with user-defined pretrigger time and detection threshold, while the number of recorded samples is up to 20000 per channel (2 ms for 10 MHz sampling).

1.3 Power supply of the analyzer

The analyzer has a built-in power adapter with nominal voltage range of 100...690 V AC or 140...690 V DC (90...760 V AC or 127...760 V DC including fluctuations). The power adapter has independent lines (red) marked with letter P (*power*). To prevent the power adapter from being damaged by undervoltage, it automatically switches off when powered with input voltages below approx. 80 V AC (110 V DC).

To maintain power supply to the device during power outages, the internal rechargeable battery is used. It is charged when the voltage is present at terminals of the AC adapter. The battery is able to maintain power supply up to 2 h hours (PQM-702, PQM-710) at temperatures of $-20...+55^{\circ}\text{C}$. After the battery is discharged the meter stops its current operations (e.g. recording) and switches off in the emergency mode. When the power supply from mains returns, the analyzer resumes interrupted recording.

Note

The battery may be replaced only by the manufacturer's service department.

1.4 Tightness and outdoor operation

The analyzer is designed to work in difficult weather conditions - it can be installed directly on electric poles. Two bands with buckles and two plastic fasteners are used for mounting the analyzer. The fasteners are screwed to the back wall of the housing, and bands should be passed through the resulting gaps.

The ingress protection class of the analyzer is IP 65, and operating temperature ranges from -20°C to +55°C.



Note

In order to ensure the declared ingress protection class IP 65, the following rules must be observed:

- *Tightly insert the stoppers in the slots of USB and SIM card,*
- *Unused probe terminals must be sealed with silicone stoppers,*
- *Tighten the plug of the socket used for external GPS antenna (or tightly screw the external GPS antenna into the socket).*

At ambient temperatures below 0°C or when the internal temperature drops below this point, the internal heater of the device is switched on - its task is to keep the internal temperature above zero, when ambient temperatures range from -20°C to 0°C.

The heater is powered from the AC/DC power adapter, and its power is limited to approx. 5 W.

Due to the characteristics of the built-in lithium-ion rechargeable battery, the process of charging is blocked when the battery temperature is outside the range of -10°C...60°C (in such case, *Sonel Analysis* software indicates charging status as "charging suspended").

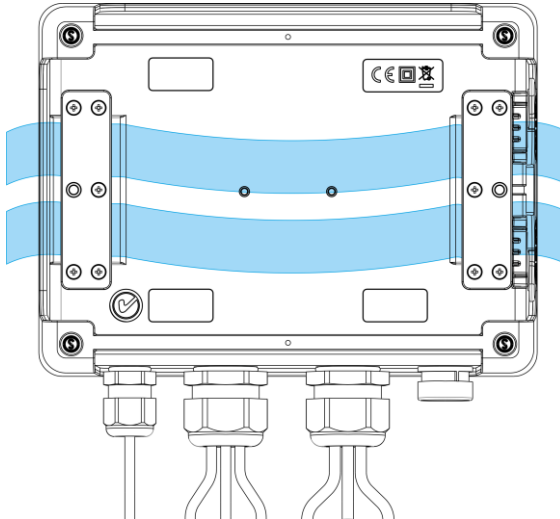
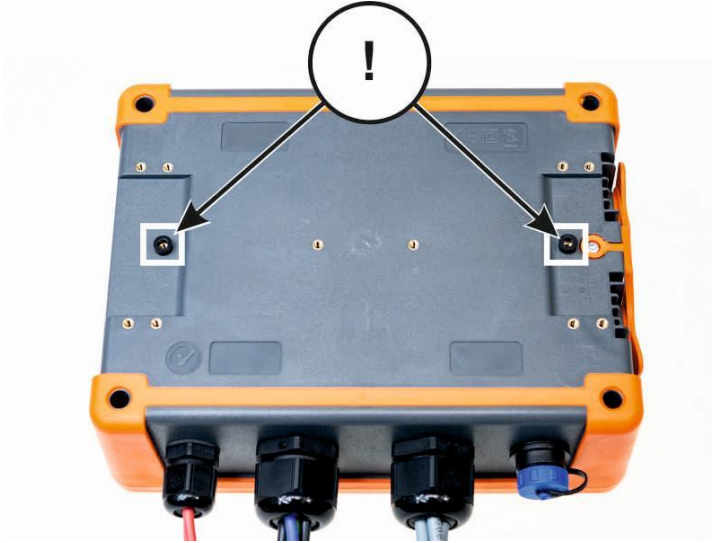

Fig. 3. Fasteners for bands (for mounting the analyzer on a pole)

1.5 **Mounting the fasteners**

1. Place the plastic spacer tubes 3 mm on the underside of the lower housing, in places marked on the photo.



2. Place the fasteners on the pole clamps on the underside of the lower housing, in places marked on the photo.

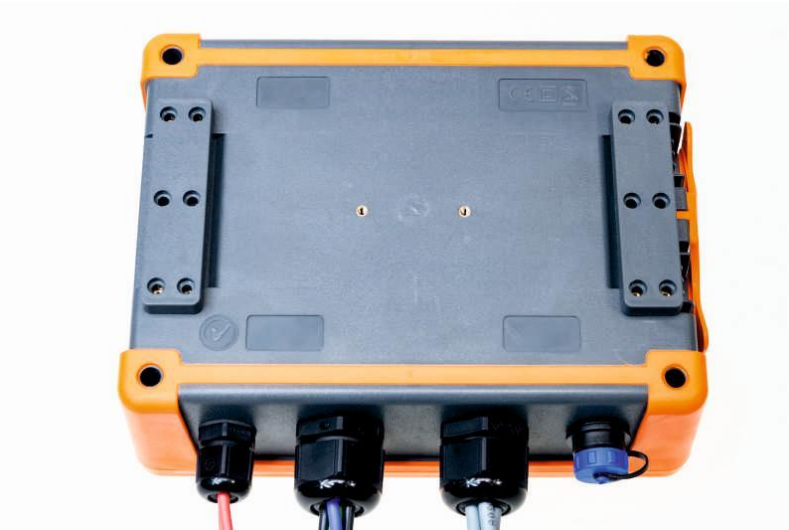

3. Tighten the fasteners to the housing using ten (10 pcs) M3x10 screws. **Use only the screws with dimensions specified in this manual.**

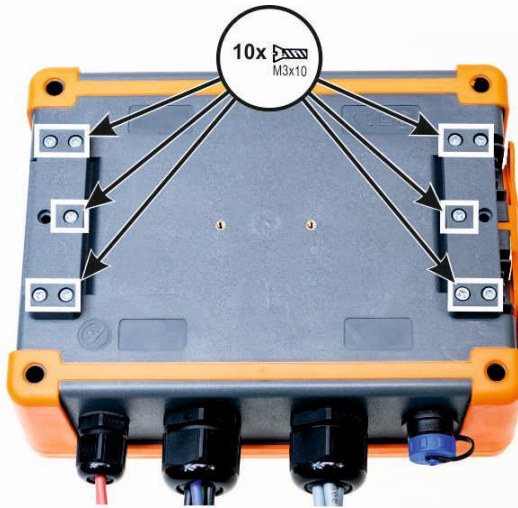

1.6 Mounting on DIN rail

The device is supplied with a bracket for mounting the analyzer on a standard DIN rail. The bracket must be fixed to the back of the analyzer with the provided screws. The set includes also positioning catches (in addition to fasteners for mounting the analyzer on a pole), which should be installed to increase the stability of the mounting assembly. These catches have special hooks that are supported on the DIN rail.

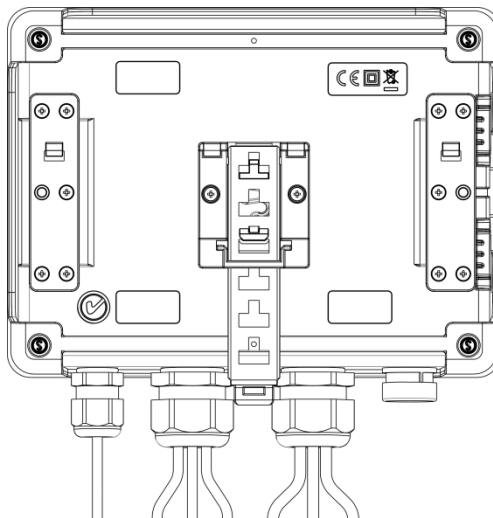

Fig. 4. The rear wall of the analyzer with fixtures for mounting on DIN rail.

1.7 Measured parameters

The analyzer is designed to measure and record the following parameters:

- RMS phase and phase-to-phase voltages - up to 760 V or 1000 V referred to ground depending on version (peak voltages up to ± 1500 V),
- **PQM-703** **PQM-711** transient voltages (overvoltages) in the range up to ± 8 kV,
- RMS currents:
 - up to 3000 A (peak currents up to ± 10 kA) using flexible probes F-1(A), F-2(A)(HD), F-3(A)(HD),
 - up to 6000 A (peak currents up to ± 20 kA) using flexible probes F-1A6, F-2A6, F-3A6; up to 1500 A (peak currents up to ± 5 kA) using flexible probes F-1A1, F-2A1, F-3A1,
 - up to 1000 A (peak values up to ± 3600 A) using probes (C-4(A) or C-5A),
 - up to 10 A (peak values - up to ± 36 A) using C-6(A) probes,
 - up to 100 A (peak values up to ± 360 A) using C-7(A) probes,
- Crest Factors for current and voltage,
- mains frequency within the range of 40..70 Hz,
- active, reactive and apparent power and energy, distortion power,
- harmonics of voltages and currents (up to 50th),
- Total Harmonic Distortion THD_F and THD_R for current and voltage,
- Total Demand Distortion for currents (TDD),
- K-Factor (loss factor in transformers caused by higher harmonics),
- active and reactive powers of harmonics,
- the angles between voltage and current harmonics,
- Power Factor, $\cos\phi$ (DPF), 4-quadrant $\tan\phi$,
- unbalance factors and symmetrical components for three-phase mains,
- flicker severity P_{ST} and P_{LT},
- interharmonics of voltages and currents (up to 50th),
- Total Interharmonic Distortion TID_F and TID_R for current and voltage,
- mains signaling voltage in the frequency band of 5...3000 Hz,
- Rapid Voltage Changes (RVC).

Some of the parameters are aggregated (averaged) according to the time selected by the user and may be stored on a memory card. In addition to average value, it is also possible to record minimum and maximum values during the averaging period, and to record the instantaneous value occurring at the end of aggregation period.

The module for event detection is also powerful. According to EN 50160, typical events include voltage dip (reduction of RMS voltage to less than 90% of nominal voltage), swell (exceeding 110% of the nominal value) and interruption (reduction of the supplied voltage below 5 % of the nominal voltage) The user does not have to enter the settings defined in EN 50160, as the software provides an automatic configuration of the device to obtain power quality measurement mode compliant with EN 50160 The user may also perform manual configuration - the software is fully flexible in this area. Voltage is only one of many parameters for which the limits of event detection may be defined. For example, the analyzer may be configured to detect power factor drop below a defined value, THD exceeding another threshold, and the 9th voltage harmonic exceeding a user-defined percentage value. Each event is recorded along with the time of occurrence. For events that relate to exceeding the pre-defined limits for voltage dip, swell, interruption, and exceeding minimum and maximum current values, the recorded information may also include a waveform for voltage and current. It is possible to record from 5 mains cycles of up to 1 second, with adjustable pre-triggering time. Together with the waveform, half-cycle RMS values (RMS_{1/2}) may be also recorded with time adjustable from 1 s to 30 s.

Additionally, the analyzer has the ability to detect events caused by the change of the shape of the voltage envelope and the voltage phase angle, by comparing consecutive successive periods of the network with each other.

A very wide range of configurations, including a multitude of measured parameters make the analyzer an extremely useful and powerful tool for measuring and analyzing all kinds of power supply systems and interferences occurring in them. Some of the unique features of this device make it distinguishable from other similar analyzers available in the market.

Tab. 2 presents a summary of parameters measured by analyzer, depending on the mains type.

Tab. 2. Measured parameters for different network configurations.

Parameter		Network type, channel		1-phase			split-phase			3-phase 4-wire					3-phase 3-wire			
		L1/A	N	L1/A	L2/B	N	Σ	L1/A	L2/B	L3/C	N	Σ	L12/AB	L23/BC	L31/CA	Σ		
U	RMS voltage	•	•	•	•	•		•	•	•	•		•	•	•			
U _{DC}	DC voltage	•	•	•	•	•		•	•	•	•		•	•	•			
I	RMS current	•	•	•	•	•		•	•	•	•		•	•	•			
I _{DC}	DC current	•	•	•	•	•		•	•	•	•		•	•	•			
F	Frequency	•		•				•					•					
CF U	Voltage crest factor	•	•	•	•	•		•	•	•	•		•	•	•			
CF I	Current crest factor	•	•	•	•	•		•	•	•	•		•	•	•			
P	Active power	•		•	•	•	•	•	•	•	•	•				•		
Q ₁ , Q _B	Reactive power	•		•	•	•	•	•	•	•	•	•				• ⁽¹⁾		
D, S _N	Distortion power	•		•	•	•	•	•	•	•	•	•						
S	Apparent power	•		•	•	•	•	•	•	•	•	•				•		
PF	Power Factor	•		•	•	•	•	•	•	•	•	•				•		
cosφ/DPF	Displacement power factor	•		•	•	•	•	•	•	•	•	•						
$\tan\phi_{C-}, \tan\phi_{L+}$ $\tan\phi_{L-}, \tan\phi_{C+}$	tangent φ factor (4-quadrant)	•		•	•	•	•	•	•	•	•	•				• ⁽¹⁾		
THD U	Voltage total harmonic distortion	•	•	•	•	•		•	•	•	•		•	•	•			
THD I	Current total harmonic distortion	•	•	•	•	•		•	•	•	•		•	•	•			
TDD I	Total Demand Distortion	•	•	•	•	•		•	•	•	•		•	•	•			
K	K-Factor	•	•	•	•	•		•	•	•	•		•	•	•			
E _{P+} , E _{P-}	Active energy (consumed and supplied)	•		•	•	•	•	•	•	•	•	•				•		
E _{QC-} , E _{OL+} E _{QL-} , E _{QC+}	Reactive energy (4-quadrant)	•		•	•	•	•	•	•	•	•	•				• ⁽¹⁾		
E _S	Apparent energy	•		•	•	•	•	•	•	•	•	•				•		
U _{h1..U_{h50}}	Voltage harmonic amplitudes	•	•	•	•	•		•	•	•	•		•	•	•			
I _{h1..I_{h50}}	Current harmonic amplitudes	•	•	•	•	•		•	•	•	•		•	•	•			
φ _{U11..φ_{U150}}	Angles between voltage and current harmonics	•		•	•	•		•	•	•	•							
P _{h1..P_{h50}}	harmonics active power	•		•	•	•		•	•	•	•							
Q _{h1..Q_{h50}}	harmonics reactive power	•		•	•	•		•	•	•	•							
Unbalance U, I	Symmetrical components and unbalance factors											•				•		
P _{st} , P _{It}	Flicker	•		•	•	•		•	•	•	•		•	•	•			
TID U	Voltage total interharmonic distortion	•	•	•	•	•		•	•	•	•		•	•	•			
TID I	Current total interharmonic distortion	•	•	•	•	•		•	•	•	•		•	•	•			
U _{ih0..U_{ih50}}	Voltage interharmonics amplitudes	•	•	•	•	•		•	•	•	•		•	•	•			
I _{ih0..I_{ih50}}	Current interharmonics amplitudes	•	•	•	•	•		•	•	•	•		•	•	•			
UR1, UR2	Mains signalling in voltage	•		•	•	•		•	•	•	•		•	•	•			
PQM-703 PQM-711 U _t	Voltage transients ⁽²⁾	•	•	•	•	•		•	•	•	•		•	•	•			

Explanations:





L1/A, L2/B, L3/C (L12/AB, L23/BC, L31/CA) indicate subsequent phases

N is a measurement for voltage channel N-PE or current channel I_N, depending on the parameter type, Σ is the total value for the system.







- (1) In 3-wire networks, the total reactive power is calculated as inactive power $N = \sqrt{S_0^2 - P^2}$ (see discussion on reactive power in section 5.3)
- (2) Voltage transients are measured in channels: L1/A-PE, L2/B-PE, L3/C-PE and N-PE.

2 Operation of the analyzer

2.1 Buttons

The keyboard of the analyzer consists of four buttons: ON/OFF , LEFT , RIGHT , START/STOP . To switch-on the analyzer, press ON/OFF button. Directional buttons LEFT and RIGHT are used primarily to change the information screens. The screens change circularly, i.e. after pressing RIGHT button, when the last screen is displayed, the device goes to screen 1. After pressing LEFT button, screens are displayed in reverse order. START/STOP button is used to start and stop the recording as defined in the configuration of current set point.

2.2 Switching the analyzer ON/OFF

- The analyzer may be switched-on by briefly pressing button . Then a welcome screen is displayed, showing the name of the meter, the internal software version (firmware), hardware version and serial number. Then, the analyzer performs a self-test and in case of detecting errors, the display shows an error message, accompanied by a long beep. When an error occurs during memory card launching, the following message is displayed **MEMORY CARD ERROR**. If the file system on the card is damaged (e.g. when the user manually formatted the card as mass storage memory accessible only for the user) the analyzer will suggest formatting the memory (message **FORMAT MEMORY CARD?**) and button  will trigger the process of formatting (3 short beeps). If the user does not press any button for 15 sec. the analyzer will restart. After the formatting is completed, the analyzer will repeat initialization of the card.
- When during the card initialization, the analyzer detects FIRMWARE.PQF file in the root directory, which includes a newer version of the firmware (internal software), the upgrade process will be suggested by the analyzer by displaying message **UPDATE FIRMWARE?**. Button  triggers this process (3 short beeps) and its progress may be observed on the display. The update may be skipped by briefly pressing the button . The update is also skipped if the user does not press any button for 10 sec. When the update is successfully completed, message **UPDATE SUCCESSFUL!**, will be displayed or in other case **UPDATE FAILED!**. Then the analyzer will automatically restart.
- After switching on, the analyzer is activated at the last measurement point and displays screen 1 with a phasor diagram.
- To switch the analyzer OFF, keep button  pressed for 2 seconds, when no button or recording lock are active.
- Pressing the active button results in a short beep of a higher pitch; for inactive button the beep is longer and at a lower pitch.
- Pressing button  or  for at least 1.5 s forces the display to refresh.

2.3 Auto-off

When the analyzer operates for at least 30 minutes powered by the battery (no power supply from mains) and it is not in the recording mode and PC connection is inactive, the device automatically turns-off to prevent onward discharging of the battery.

The analyzer turns off automatically also when the battery is fully discharged. Such emergency shut-down is performed regardless of the mode of the device. In case of active recording, it will be interrupted. When the power supply returns, the recording process is resumed. Emergency shut-down is signalled by message **BATTERY DISCHARGED!**

2.4 Screens

Note

Screens count is device dependent. PQM-702 and PQM-703 have 9 screens, whereas PQM-710 and PQM-711 have 10 screens.

Fig. 5 presents the first screen displayed by the analyzer. The bar in the upper part is a permanent element, shown independent of the selected screen.

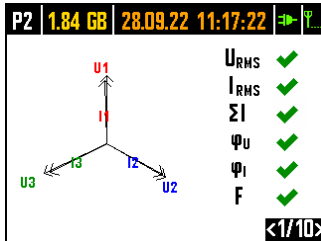

Fig. 5. Screen 1 with a phasor diagram and indicators of connection correctness.

The bar includes (from the left):

- number of active measurement point (configuration): **P1**, **P2**, **P3** or **P4**. In some modes measurement point number is displayed alternately with additional graphic symbol:
- The symbol of sinusoid is displayed when the memory of the measurement point is completely filled with recorded data, or when the measurement point is not assigned to any place (zero allocation). In such conditions, recording cannot be started; only viewing the current values is possible.
- The symbol of slope with an arrow indicates waiting for triggering the recording process by the first detected event (threshold triggering).
- The hourglass symbol indicates waiting for recording to start in the scheduled recording mode (also between recording intervals).
- available space on the memory card for an active measurement point - in MB or GB.
- current date and time in the format day.month.year, hour:minute:second. Date and time are displayed in green, when time of the analyzer is synchronized to GPS time and meets the requirements for the accuracy specified in IEC 61000-4-30 and valid for analyzers of class A. If time does not meet these requirements, it is displayed in orange.
- indicator of mains power supply or battery status,
- indicator of GSM network signal strength (if a SIM card is inserted and connection GSM network is active).

Screen number is displayed in the lower right corner of the display.

Screen 1 is displayed by default after turning the analyzer on and after changing a measurement point. It presents a phasor diagram of the measured mains and indicators of correct connection to the mains. This feature is described in section 2.5.

2 Operation of the analyzer

Screen 2 is shown in Fig. 6. It shows the measured values of RMS voltages and currents within the tested system and the mains frequency. The frequency value is displayed in orange when there is no PLL synchronization or when the analyzer is working on the internal generator (e.g. in the absence of voltage U_{L1}).

PQM-702T Additionally, for PQM-702T, after connecting ST-2 temperature probe to the analyzer, the sensor temperature is displayed on the screen on a current basis.

P3	1.80 GB	20.12.12	11:30:10	⇒	⌂
U1	= 224.57 V	I1	= 22.27 A		
U2	= 227.86 V	I2	= 28.39 A		
U3	= 228.03 V	I3	= 23.37 A		
Unpe	= 0.0218 V	In	= 10.95 A		
f	= 50.000 Hz				
					<2/9>

Fig. 6. Screen 2 with the values of effective voltages and currents.

Screen 3 (Fig. 7) shows the active and passive power values. Power values of successive phases are marked with numbers from 1 to 3. Total power values are displayed in the last line (marked as P and Q).

P3	1.80 GB	20.12.12	11:30:09	⇒	⌂
P1	= 4.825 kW	Q1	= 929.3 var		
P2	= 6.301 kW	Q2	= 1.087 kvar		
P3	= 4.981 kW	Q3	= 1.289 kvar		
P	= 16.11 kW	Q	= 3.307 kvar		
					<3/9>

Fig. 7. Screen 3 with active and reactive power.

Screen 4 (Fig. 8) shows values of apparent distortion power (marked as SN) and values of apparent power (S). When the user selected power measurement according to Budeanu method instead of apparent power distortion, the device displays distortion power "D".

P3	1.80 GB	20.12.12	11:30:08	⇒	⌂
SN1	= 984.6 var	S1	= 7.617 kVA		
SN2	= 778.3 var	S2	= 10.04 kVA		
SN3	= 1.100 kvar	S3	= 8.081 kVA		
SN	= 4.831 kvar	S	= 26.28 kVA		
					<4/9>

Fig. 8. Screen 4 with apparent and deformation power values.

Screen 5 (Fig. 9) indicates THD factors in voltage and current. The factors shown on this screen are related to the fundamental component.

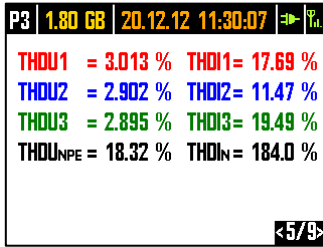

Fig. 9. Screen 5 with THD factors.

On screen 6 (Fig. 10) Power Factors (PF) are presented along with $\tan\phi$ (i.e. the ratio of reactive power to active power).

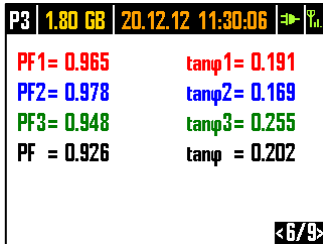

Fig. 10. Screen 6 with power factors and $\tan\phi$.

Screen 7 is the last of the measurement screens and it presents short-and long-term flicker factors P_{st} and P_{lt} . P_{st} flicker severity is updated every 10 minutes, whereas P_{lt} flicker severity every two hours.

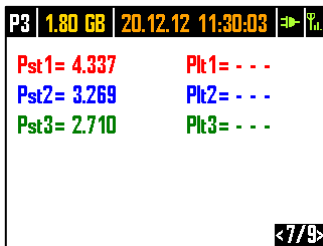

Fig. 11. Screen 7 with flicker.

2 Operation of the analyzer

Screen 8 presents the following information:



Fig. 12. Screen 8.

- start-time of the last recording, or the start-time of the next scheduled recording interval in the scheduled recording mode,
- end-time of the last recording (when recording is in progress dashes are displayed), or the end-time of the next scheduled recording interval in the scheduled recording mode,
- duration of the current or completed recording, optionally - duration of the interval in the scheduled recording mode,
- the number of events recorded by the analyzer from the start of recording,
- GSM network status. This line displays messages that relate to the current status of the built-in GSM modem:
 - **TURNING ON...**: the modem is being activated,
 - **CONNECTING TO NETWORK**: the modem logs on to GSM network
 - **CONNECTING TO INTERNET**: the modem initiates exchanging data packets and connects with the Internet,
 - **READY, UMTS**: the modem has properly registered itself in GSM network and waits for a client connection. UMTS (Universal Mobile Telecommunications System Network) is the name of a standard for data exchange, which depends on the availability of services in a given area.

The analyzer may display different messages here, e.g. indicate errors: **NO SIM CARD** when the SIM card is not inserted, **INVALID PIN** when PIN submitted by the analyzer was rejected by the SIM card, etc. More related information may be found in the chapter on GSM connections - section 2.13.

- the last line of screen 8 shows the status of the GPS receiver: when sufficient signal is received from GPS satellites (from internal or external antenna), the device displays word **YES**. When no signal is received, the device displays **NO SIGNAL** message. See more about GPS receiver in section 0.
- current level of GPS signal,
- information about GPS position (**2D**) and/or about receiving the correct GPS time (clock icon).

Screen 9 (Fig. 13) allows user to quickly view the main configuration parameters of the measurement point:

- mains system,
- probes type; in case of configurations with automatic probes recognition, the **AUTO** is displayed and in brackets the recognized probes model or **?** symbol if the probes are not connected or their configuration is invalid (i.e. not all required probes were connected or connected probes are of different types).
- nominal values of: voltage, current and frequency.

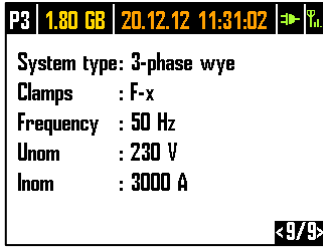



Fig. 13. Screen 9 with information on the measurement point settings.

PQM-710 **PQM-711** Screen 10 displays the current status of the wireless Wi-Fi connection. Using this screen, you can read:

- radio signal level (in client mode) – indicated by icon , where the number of green fields represents the signal level from 0 – none, to 4 – high (in Access Point mode, this place displays **AP**),
- connection status (**READY**, **GETTING IP ADDRESS**, **SEARCHING FOR NETWORK**)
- MAC address of the analyzer Wi-Fi interface,
- IP address of the analyzer in the Wi-Fi network. If the address is automatically assigned, then message (**DHCP**) is displayed,
- SSID of the Wi-Fi network, to which the analyzer is connected (in client mode) or in network distributed by the analyzer (in Access Point mode).

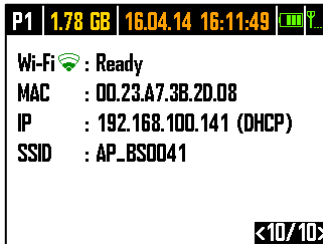

















Fig. 14. Screen 10 with information on the current status of Wi-Fi connection (PQM-710 and PQM-711 only).



2.5 Verifying the connection

Screen 1, next to phasor diagram displays correct connection indicators (see. Fig. 5), which give some relevant information on connecting the analyzer the tested network. This information helps the user to verify the compliance of the current configuration of the analyzer with the parameters of the measured network.

The indicators are sequentially marked as: U_{RMS} , I_{RMS} , φ_U , φ_I , f .

- **U_{RMS}** : effective values of voltages – two possible icons:
 -  - RMS voltages are correct, they are within the tolerance range of $\pm 15\%$ of the nominal voltage,
 -  - RMS values are outside the range of $U_{NOM} \pm 15\%$.
- **I_{RMS}** : effective values of current values – four options:
 -  - RMS currents are in the range of $0.3\% I_{NOM} \dots 115\% I_{NOM}$,
 -  - RMS currents are lower than $0.3\% I_{NOM}$,
 -  - RMS currents are higher than $115\% I_{NOM}$,
 - --- dashes are displayed when the current measurement is disabled in the configuration.

In all systems where it is possible the analyzer also calculates the sum of all the currents (instantaneous values) and checks if it totals to zero. This helps in determining if all current probes are connected correctly (i.e. arrows on current probes facing to the load). If the calculated current sum RMS value is higher than 0.3% of I_{nom} , it is treated as an error and the  icon is displayed.
- **ΣI** : The analyzer verifies the correctness of the clamps' connection on the basis of the instantaneous sum of all currents. In a closed system, the RMS value of the instantaneous sum of the current should be close to zero. The verification is only performed when the RMS of at least one measured current exceeds 0.3% of I_{nom} . In measuring systems with analytical calculation of the I_n current and in Aron circuits, this checking is disabled.
 -  - clamps connected correctly - the instantaneous sum of currents is close to zero,
 -  - the correctness of summing the currents cannot be verified due to too low current values,
 -  - the calculated RMS value of the instantaneous sum of the currents exceeds 0.3% of I_{nom} and at the same time it exceeds 25% of the maximum value of all measured currents. Such a situation may occur, e.g. when the clamps are connected inversely on the N conductor.
- **φ_U** : vectors - the analyzer verifies the correctness of the fundamental component angles and displays the corresponding icon:
 -  - the vectors have correct angles in the range of $\pm 30^\circ$ of the theoretical value for a resistive load and symmetrical circuit (in 3-phase systems),
 -  - the accuracy of angles cannot be verified, because the RMS voltage value is too low (less than 1% of U_{NOM}),
 -  - incorrect angles of vectors. In three-phase systems, this icon is displayed, among others, in case of reversed sequence of voltage phases.
- **φ_I** : current vectors - correctness of current vector angles is verified in relation to the voltage vectors. The following icons are displayed:
 -  - vectors are within $\pm 55^\circ$ in relation to angles corresponding to the voltage vectors,
 -  - the accuracy of current vector angles cannot be verified, because the RMS current values are too low (below 0.3% of I_{NOM}),
 -  - vectors are outside the acceptable range of angles ($\pm 55^\circ$),
 - --- dashes are displayed when the current measurement is disabled in the configuration.

- **f**: frequency:
 -  – the measured grid frequency is in the range of $f_{NOM} \pm 10\%$,
 -  - the RMS value of reference voltage phase is lower than 10V (the analyzer operates with internal generator) or there is no PLL synchronization,
 -  - the measured frequency is outside of $f_{NOM} \pm 10\%$.

Example from Fig. 5 illustrates the situation of incorrect connection of current clamps (swapped channels I_2 and I_3) – the icon ϕ_1 indicates an error in current vectors.

2.6 "Sonel Analysis" software



"Sonel Analysis" is an application required to work power analyzers of PQM series. It enables the user to:

- configure the analyzer,
- read data from the device,
- real-time preview of the mains,
- delete data in the analyzer,
- present data in the tabular form,
- present data in the form of graphs,
- analyzing data for compliance with EN 50160 standard (reports), system commands and other user-defined reference conditions,
- independent operation of multiple devices,
- upgrade the software and the device firmware to newer versions.

Detailed manual for "Sonel Analysis" is available in a separate document (also downloadable from the manufacturer's website www.sonel.pl).

2.7 PC connection and data transmission

The analyzer provides three ways of communication with a PC. They are as follows:

- wired communication via USB,
-  radio communication in 433 MHz band using OR-1 receiver,
- built-in wireless connectivity via GSM modem,
-  radio communication via wireless Wi-Fi transmission – a PC and the analyzer must be connected to the same LAN (or directly with each other, if the analyzer operates in Access Point mode) or have the ability to communicate through the WAN (correct configuration of the router).





Connection to a computer (PC mode), ensures:

- Transmission of data stored in the recorder memory:
 - it is possible to read the data of all measurement points regardless of the recording state,
- Viewing mains parameters on PC:
 - instantaneous values of: current, voltage, power and energy, total values for the entire system,
 - harmonics, interharmonics, harmonic power values, THD, TID,
 - unbalance,
 - phasor diagrams for voltages,
 - current and voltage waveforms drawn in real-time,
 - all other measured parameters not listed here.
- Analyzer configuration, remote triggering and stopping of the recording process.
- When connected to a PC, the display shows message **PC CONNECTION** and the type of connection.

2 Operation of the analyzer

- When connected to a PC, all analyzer buttons are locked except  button, but when the analyzer operates with key lock mode (e.g. during recording), all the buttons are locked.
- To connect to the analyzer, enter its PIN code. The default code is 000 (three zeroes). The PIN code may be changed using "Sonel Analysis" software.
- When wrong PIN is entered three times in a row, data transmission is blocked for 10 minutes. Only after this time, it will be possible to re-entry PIN.
- When within 30 seconds of connecting a PC to the device no data exchange occurs between the analyzer and the computer, the analyzer exits data exchange mode and terminates the connection.

Notes

- Holding down buttons  and  for 5 seconds results in an emergency setting of PIN code (000).
- If the keys are locked during the recording process, this lock has a higher priority (first the user would have to unlock buttons to reset the emergency PIN). To unlock the keypad in emergency cases hold buttons  and  pressed for 5 seconds.

- If there is an active connection via one of the media, it is not possible to communicate with the analyzer using another medium type, e.g. a USB connection is active, the user cannot use OR-1 radio or GSM connection. In this case, the device displays a message that another connection is already active.

2.7.1 USB communication

USB is an interface that is continuously active and there is no way to disable it. To connect the analyzer, connect USB cable to your PC (USB slot in the device is located on the left side and is secured with a sealing cap). Before connecting the device, install "Sonel Analysis" software with the drivers on the computer

Transmission speed is 921.6 kbit/s. In addition, a built-in mass-storage reader enables downloading recorded data with speed significantly higher than the standard speed. In this mode, the analyzer provides its memory card as a mass storage space, allowing you to read data at a speed of a few MB/s. During data read-out, the normal communication with the device is not available e.g. data preview in LIVE mode. After reading data from the memory card, "Sonel Analysis" automatically switches the analyzer from reader mode to standard communication mode.

Note

In the reader mode, the entire memory card appears as a drive in the operating system - this solution provides an unrestricted access to its contents. To prevent damaging the file system on the card and losing the stored data, the user must not interfere with the file system on the card (e.g. by creating and storing own files, or deleting files stored by the analyzer). For this purpose do not use programs other than Sonel Analysis.

Note

Use certified and good quality USB 2.0 cables with a length of no more than 5 meters. This is especially important in mass storage mode. It is recommended to use the USB cable supplied with the analyzer.

2.7.2 Radio communication via OR-1 **PQM-702** **PQM-702T** **PQM-703**

After connecting OR-1 radio module to a PC, the user may communicate with the analyzer using 433 MHz band. The range in this mode is limited to about 5 m, and the maximum rate data of data transmission is 57.6 kbit/s

Note

Before connecting to the analyzer through a wireless connection (OR-1 or GSM), the user must add the analyzer to the database of analyzers (**OPTIONS** → **ANALYZER DATABASE** in "Sonel Analysis"). When searching for analyzers, the list of displayed analyzers includes only those entered in the database. For more information - see the manual for "Sonel Analysis".

OR-1 is not supported by the devices (including their variants) with **serial numbers having the following prefixes:**

- PQM-702: LJ,
- PQM-703: LJ.

The radio interface that communicates with OR-1 receiver may be turned off in the analyzer. To switch it back on, use one of two remaining transmission modes: USB, or GSM.

2.7.3 Communication via GSM network

The built-in GSM modem ensures the access to the analyzer from any chosen global location with available GSM network. The modem supports UMTS HSPA data transfer with maximum data transfer rate of 5.76/7.2 Mbit/s (upload/download respectively). To operate this feature - insert a valid SIM card to the side slot of the analyzer.

The SIM card must have the following services activated:

- General Packet Radio Service,
- static IP address,
- SMS option to send alarm messages.

In order to configure the SIM card and modem in the analyzer, the user must obtain the following data from the data transmission service provider:

- PIN code for SIM card
- PUK code for SIM Card - for emergency cases, when SIM card is locked after repeated attempts of enter wrong PIN,
- IP number assigned to SIM card (it must be a static number),
- APN (*Access Point Name*),
- user name and password (optional, usually not required).

After inserting the SIM card for the first time into the analyzer, the device will attempt to use the PIN entered last time or the default code. Usually, such an attempt fails, and the analyzer displays the message about incorrect PIN code. To enter the correct data, establish a connection with the

2 Operation of the analyzer

analyzer via USB (or OR-1) and configure a GSM connection. The procedure described in section 2.13.2. If the analyzer is configured correctly it will attempt to connect to the GSM network and then to the Internet. The analyzer will now be visible on the Internet with assigned IP number. The device will wait for incoming connections using port 4001. Such connection may be established by "Sonel Analysis"

If the GSM modem will not be used, it may be turned off using the program.

More information about the analyzer configuration for GSM communication is presented in section 2.13.

2.7.4 Radio communication via Wi-Fi **PQM-710** **PQM-711**

PQM-710/711 analyzers are equipped with Wi-Fi module working in IEEE 802.11 b/g standard and n single stream. This allows the analyzer to communicate with the tablet (or computer) remotely. A direct connection: tablet ⇔ analyzer is possible, as well as operation in a local network or via the Internet.

You can work in an open network or in a network secured with WPA/WPA2-PSK.

Warning
*In analyzers with firmware version 1.25 or older, the Wi-Fi module can work only in client mode.
Analyzers with version from 1.30 may work in two modes: client and access point (AP).*

Client mode

In client mode an external Access Point is used to establish a connection between the analyzer and PC. When connected to an Access Point, the analyzer starts TCP/IP server connections with static IP address or with an address assigned by DHCP server of the Access Point. TCP port used in the local network and for direct connections is 4002.

Connecting to the analyzer via the Internet requires a Wi-Fi router properly configured by the network administrator.

The analyzer, which has no Access Point within its range, remains in scanning mode of 2.4 GHz Wi-Fi band.

Access Point (AP) mode



In this mode, the analyzer is an Access Point, distributing the local network (SSID) with a name and password provided by the user. This Access Point may be used to connect with other devices such as PCs, tablets or mobile phones. By the default, the Access Point operates on channel No. 10. If necessary, the channel may be changed to another.

For more information about configuring Wi-Fi connection and the ways of connecting with the meter, refer to section 2.14.

2.8 Taking measurements

2.8.1 Measurement Points

The analyzer allows the user to store four completely independent measurement configurations, which are also called "measurement points." Number of active measurement point is shown in the upper left corner of the screen as an **P** with a digit **1...4**.

Press buttons  and  at the same time and hold them pressed for 1 second to display the screen for selecting the measurement point Fig. 15.

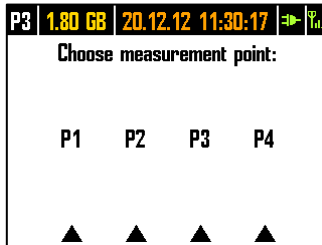





Fig. 15. Selection of the measurement point.

To select one of the four points, press the corresponding button indicated by a triangle on the screen:

- to select measurement point 1, select 
- to select measurement point 2, select 
- to select measurement point 3, select 
- to select measurement point 4, select 

After selecting the measurement point the analyzer displays the phasor diagram (screen 1), and checks the validity of mains connections. If an error is detected, the device emits a long beep.

If the user chooses to not to select the measurement point and does not press any key, after a few seconds, the analyzer returns to the previous screen.

In some cases, changing the measurement point is not possible. At least two of such cases are as follows:

- the analyzer is recording; in such case the device displays message **RECORDING IN PROGRESS**
- the communication with a PC is in progress (via USB, OR-1, Wi-Fi or GSM). In this case, LEFT and RIGHT keys are inactive.

The user may assign any chosen percentage of memory to each point (e.g. 100% for the first point and 0% for others or 25% for each point). If any measurement point has the whole memory assigned, selecting any other measurement point results in displaying the number of selected point alternately with the symbol of the sine wave, indicating that the parameters may be viewed only in "LIVE" mode.



2.8.2 Start / stop of recording

When the selected measurement point still has the assigned disk space left, the user may start recording by pressing button , or initiate it from the software using connected PC. Starting the recording mode depends on how its configuration during the configuration of the measurement point. There are three modes available:

- Immediate start - when recording begins immediately after pressing the button.
- start after detecting the first event - in such case the analyzer waits for the record-triggering event. i.e. when the first of the parameters configured for the measurement point exceeds the threshold triggering the event. While waiting for the event, the analyzer uses the status bar to display the number of the measurement point alternately with the symbol of slope with an arrow.
- start according to scheduled recording time. Screen **8** may be used to see the next scheduled start and end of the recording process. At the same time the status bar displays the number of measurement point alternately with the hourglass symbol. If all the scheduled times are over, the recording process will be inactive (unavailable) and the status bar will display the number of measurement point, alternately with the sinusoid symbol (meaning that only Live preview of current mains values is possible).

The measurement point number, which is displayed in the upper left corner of the screen, flashes once per second, while the device is in the recording mode,

Stopping the recording process:

- Recording may be manually stopped by holding for one second button  or from the PC application.
- Recording ends automatically as scheduled (if the end time is set), in other cases the user stops the recording (using button  or the software).
- Recording ends automatically when all memory assigned to a measurement point on the memory card is filled. In this situation, the display will show the number of the measurement point alternately with the sinusoid symbol.
- The display will remain blank after the recording process is completed, if the user activated the "sleep mode". Press any button to turn the screen on and to display the last screen (if the key lock is off) or the screen requesting the code for unlocking the keypad (if the key lock is on).

2.8.3 Recording configuration

Before you start recording, it is necessary to configure the selected measurement point, to perform the recording process according to your requirements. The configuration is carried out using *Sonel Analysis* software. The analyzer is supplied from the factory with sample configurations, which are described in details in the manual for *Sonel Analysis*.

In general, there are three different types of recording:

- recording acc. to user configuration,
- recording for compliance with the standard (EN 50160 or other),
- dual recording, allowing user to perform parallel measurement according to user configuration and regardless of compliance with the standard.

Recording by user configuration provides flexibility in selecting parameters to be recorded. The user indicates the type of network, nominal parameters, averaging time and parameters to be recorded or activates event detection, etc.

Recording for compliance with the indicated standard may be followed by a compliance report, which is used to assess the quality of power supply in the tested network point. In earlier versions of analyzer firmware (v1.16 or older) in this mode, the user could specify additional recording parameters (except those required by the selected standard and automatically included), but the

averaging time of all parameters could be only 10 minutes (as the main averaging time of the standards). Firmware v1.17 offers a new method of recording, removes the restriction on the averaging time. This means that the user may activate recording for compliance with the standard and simultaneously record other parameters with different averaging time - i.e. as in recording for the user. This opens up completely new diagnostic possibilities. In the dual mode, the recording for standard compliance is performed in the background, completely independently.

One exception (restriction) in relation to recording acc. to the user configuration is blocking the possibility of changing detection thresholds for voltage event (dip, swell, interruption), due to the strict requirements for such events included in the standards. These events are also always active and cannot be disabled.

The second exception occurs when a Standard is chosen that requires recording of RVC events. In this case the RVC parameters are configured in selected Standard profile and cannot be changed in user configuration.

In cases when the user only wants recording for compliance with the Standard and does not want the analyzer to record additionally any other parameters (and thus increase unnecessarily the size of recorded data), turn off (by unchecking in settings) all other parameters, or choose a long averaging time from the list (even if the parameters are to be recorded, it will take relatively little space). However, this does not include events, so the best solution is to disable unnecessary parameters.

2.8.4 Approximate recording times

The maximum recording time depends on many factors such as the size of the allocated space on a memory card, averaging time, the type of system, number of recorded parameters, waveforms recording, event detection, and event thresholds. A few selected configurations are given in Tab. 3. The last column gives the approximate recording times when 2 GB of memory card space is allocated to a measurement point. The typical configurations shown below are based on the measurement of the N-PE voltage and I_N current.

Tab. 3. Approximate recording times for a few typical configurations.

Configuration type/ recorded parameters	Averaging time	System type (current measurement on)	Events	Event waveforms	Waveforms after averaging period	Approximate recording time with 2 GB allocated space
according to EN 50160	10 min	3-phase wye	• (1000 events)	• (1000 events)		> 10 years
according to the "Voltages and currents" profile	1 s	3-phase wye				270 days
according to the "Voltages and currents" profile	1 s	3-phase wye			•	4 days
according to the "Power and harmonics" profile	1 s	3-phase wye				23 days
according to the "Power and harmonics" profile	1 s	3-phase wye	• (1000 events)	• (1000 events)		22.5 days
all possible parameters	10 min	3-phase wye				4 years
all possible parameters	10 s	3-phase wye				25 days
all possible parameters	10 s	1-phase				64 days
all possible parameters	10 s	1-phase	• (1000 events / day)	• (1000 events / day)	•	14.5 days

2.9 Measuring circuits

The analyzer may be connected directly to the following types of networks:

- 1-phase (Fig. 16)
- 2-phase (split-phase) with split-winding of the transformer (Fig. 17),
- 3-phase 4-wire wye with a neutral conductor (Fig. 18),
- 3-phase 3-wire wye without neutral conductor (Fig. 19 ,Fig. 22),
- 3-phase 3-wire delta (Fig. 20 ,Fig. 21).

Indirect measurements in medium voltage networks can be performed:

- in wye network (Fig. 23),
- in delta network (Fig. 24).

Measurements in DC systems is possible in two configurations:

- DC – one-voltage DC system (Fig. 25)
 - DC+M – two-voltage DC system with middle point (Fig. 26)
- In DC systems, it is possible to measure the current using probes C-5A.

In three-wire systems, current may be measured by the Aron method, which uses only two probes that measure linear currents I_{L1} and I_{L3} . I_{L2} current is then calculated using the following formula:

$$I_{L2} = -I_{L1} - I_{L3}$$

This method can be used in delta systems (Fig. 21, Fig. 24) and wye systems without a neutral conductor (Fig. 22).

Note

As the voltage measuring channels in the analyzer are referenced to N input, then in systems where the neutral is not present, it is necessary to connect N input to L3 network terminal. In such systems, it is not required to connect L3 input of the analyzer to the tested network. It is shown in Fig. 19, Fig. 20, Fig. 21 and Fig. 22 (three-wire systems of wye and delta type).

For transient measurement in L3 channel the connection of L3 input is required.

In systems with neutral conductor, the user may additionally activate current measurement in this conductor, after installing additional probes in I_N channel. This measurement is performed after activating in settings the option of **N-CONDUCTOR CURRENT** with option **MEASURED**.

An alternative to I_N current measurement with probes is the calculation of current in neutral conductor applying the analytical method. The analyzer provides such option after selecting **N-CONDUCTOR CURRENT** and **CALCULATED**. Neutral current is calculated from the following relations:

- $I_N = -I_{L1}$, in a single-phase system,
- $I_N = -I_{L1} - I_{L2}$, in a 2-phase system,
- $I_N = -I_{L1} - I_{L2} - I_{L3}$, in a 3-phase 4-wire wye system.

These relations stated above are true provided that zero current is present in PE conductor. In typical situations, this current is indeed negligible, but note that in emergency situations (e.g. short circuit - until the switch breaker is tripped) current in PE conductor may reach significant values; therefore the calculated value of current I_N will differ from the actual.

Note

*In order to correctly calculate total apparent power S_e and total Power Factor (PF) in a 4-wire 3-phase system, it is necessary to measure the current in the neutral conductor. Then it is necessary to activate option **N-conductor current** and connect 4 probes, as shown in Fig. 18. Another option is to turn on analytical calculation of current I_N . More information on total apparent power S_e - see sec. 5.3.6.*

For systems with available PE and N conductors (earthing and neutral) it is also possible to measure N-PE voltage. To do this, connect PE conductor to PE voltage input of the analyzer. In addition, select option **N-PE VOLTAGE** in measurement point settings.

Pay attention to the direction of current probes (flexible and CT). The probes should be installed with the indicating the load direction. It may be verified by conducting an active power measurement – in most types of passive receivers active power is positive. When probes are incorrectly connected, it is possible to change their polarity using "SoneI Analysis" software.

PQM-703 **PQM-711**

When measuring overvoltages (transients) is also required, remember that the analyzer measures them in relation to PE input. Therefore, in such cases always ensure that PE input of the analyzer is connected to a local earthing. This remark applies to all types of systems, including 3-wire systems. Unconnected PE conductor will result in a failure to detect transients. In 3-phase 3-wire systems, to be able to detect transients in L3 voltage channel, a L3 input must be connected to the tested mains (in these systems, when transients measurement is not needed, L3 input can be left disconnected).

The following figures show schematically how to connect the analyzer to the tested network depending on its type.

Icons used in the drawings with respect for optional connections have the following meanings:



if U_{N-PE} voltage measurement is required, make connection as shown by the icon in diagram (connect PE input to the protective conductor)



if I_N current measurement is required, make connection as shown by the icon in diagram (connect probes in channel I_N).



if transients measurement is required, make connection as shown by the icon in diagram (connect PE input to the local earthing or protective conductor, and L3 input depending on mains system).

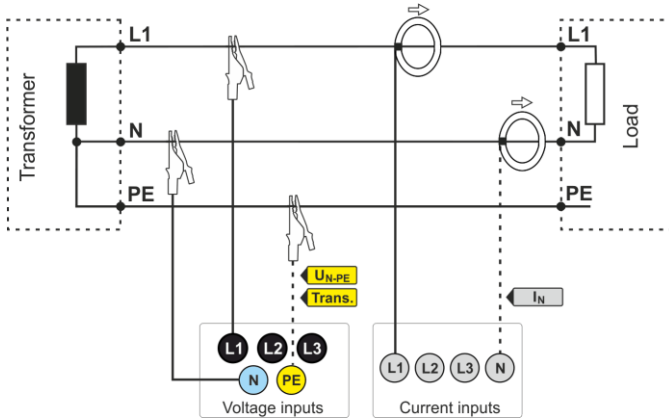

Fig. 16. Wiring diagram – single phase.

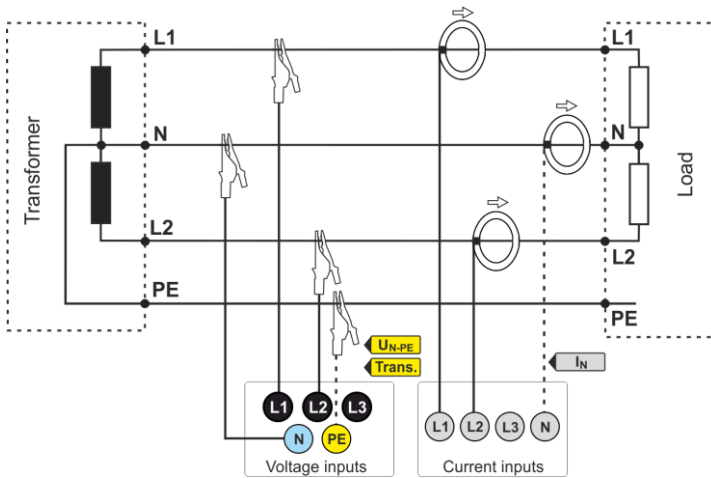

Fig. 17. Wiring diagram – split-phase.

2 Operation of the analyzer

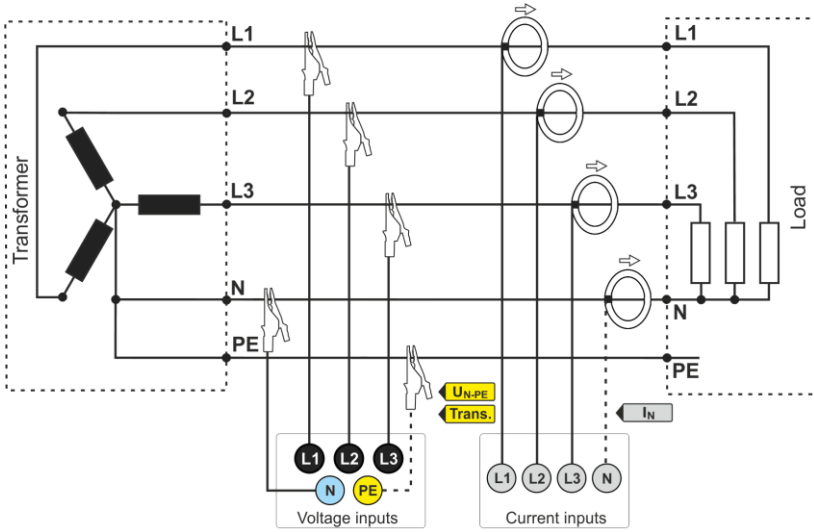

Fig. 18. Wiring diagram – 3-phase wye with a neutral conductor.

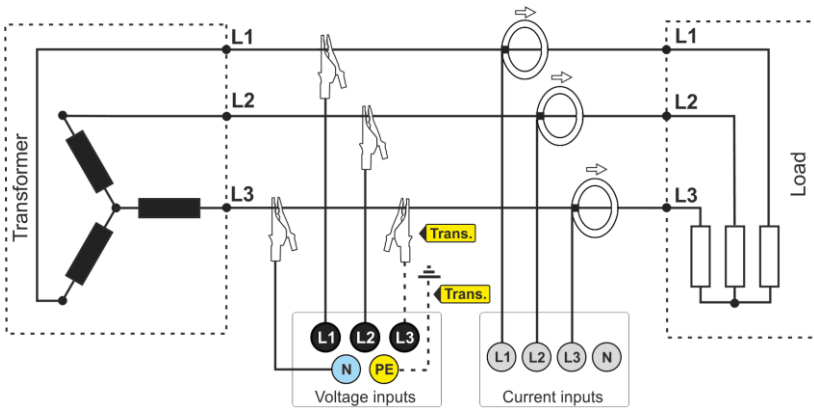

Fig. 19. Wiring diagram – 3-phase wye without neutral conductor.

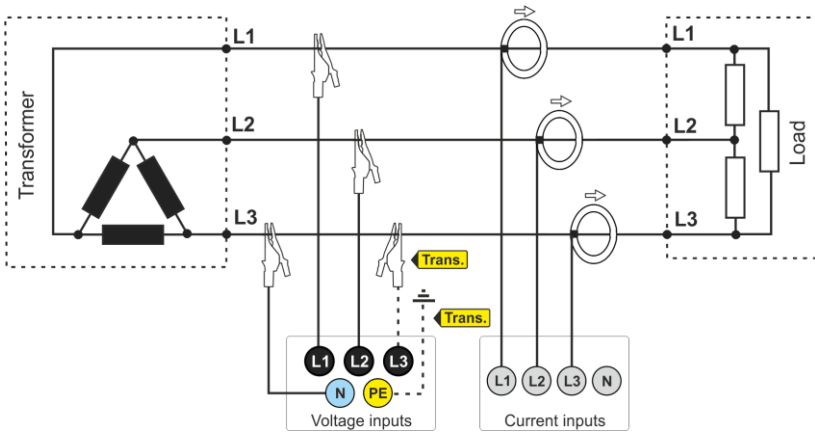

Fig. 20. Wiring diagram – 3-phase delta.

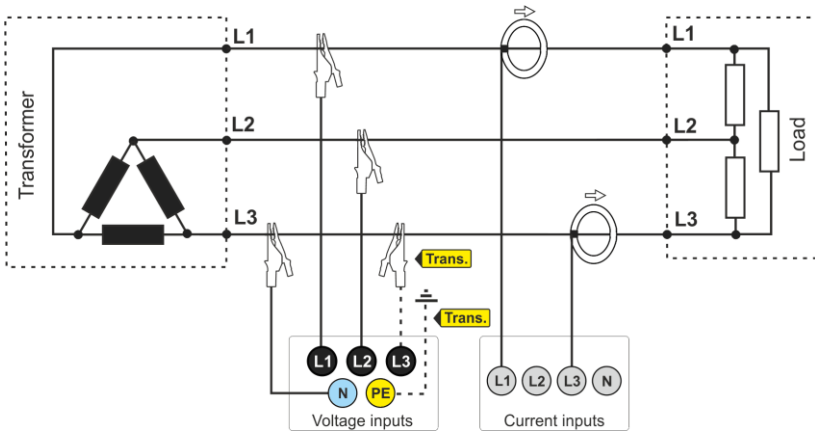

Fig. 21. Wiring diagram – 3-phase delta (current measurement using Aron method).

2 Operation of the analyzer

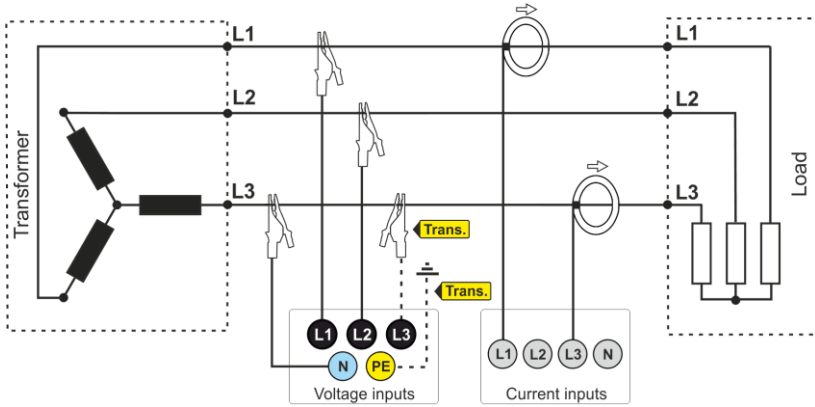

Fig. 22. Wiring diagram – 3-phase wye without neutral conductor (current measurement using Aron method).

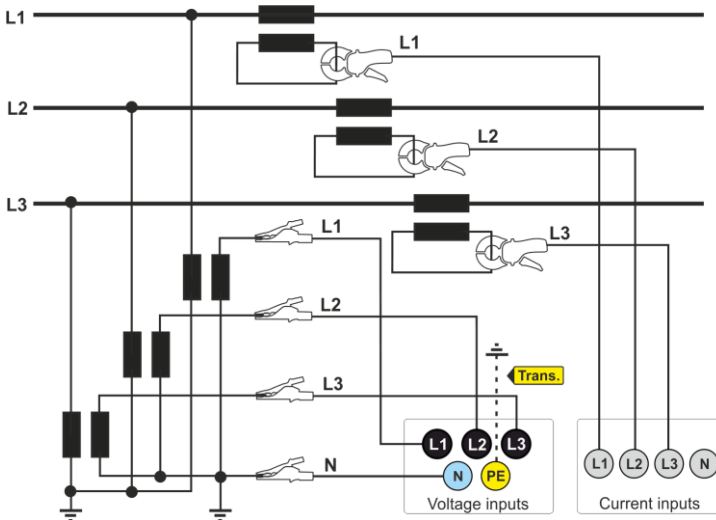

Fig. 23. Wiring diagram – indirect system with transducers – wye configuration.

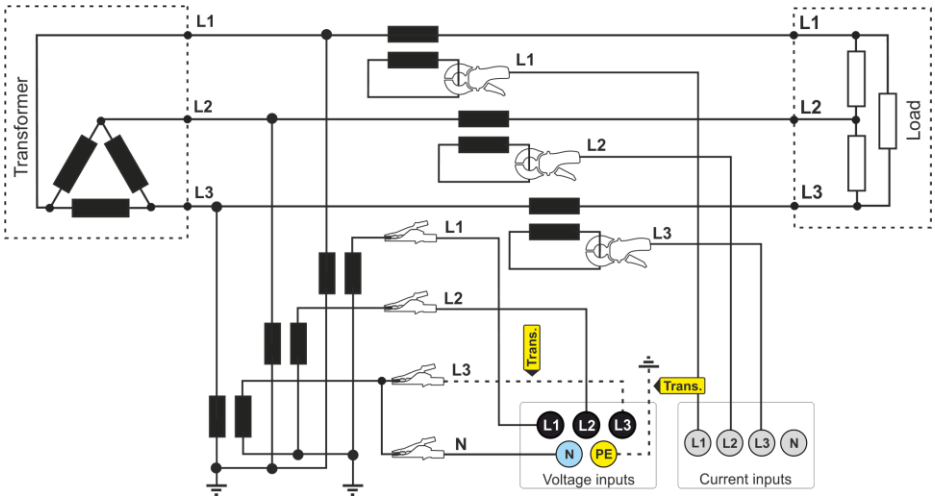

Fig. 24. Wiring diagram – indirect system with transducers – delta configuration.

Note

Frequency response of transformers is usually very narrow, so the network disturbances at high frequencies (e.g. lightning surges) are largely suppressed and distorted on the secondary side of the transformer. This should be taken into account when making transient measurements in configuration with transformers.

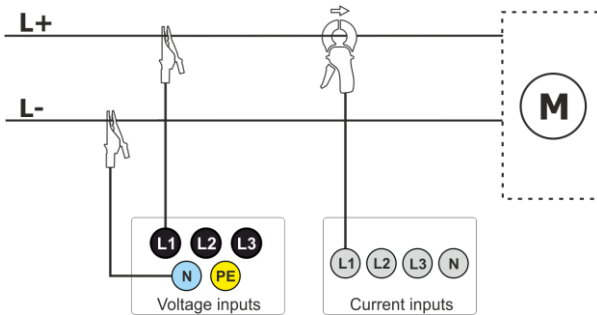

Fig. 25. Wiring diagram – DC system.

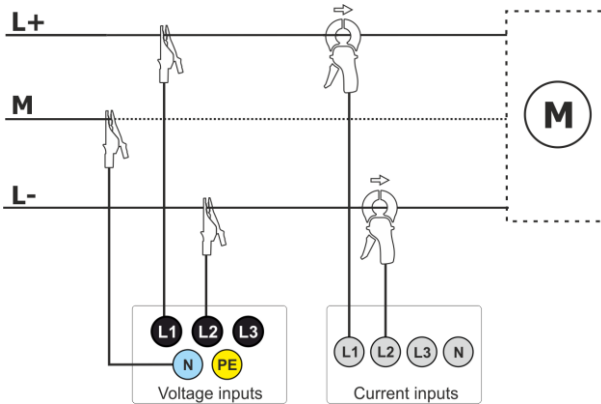

Fig. 26. Wiring diagram – DC+M system (bipolar).

2.10 Inrush current

The function enables user to record half-period values (RMS $\frac{1}{2}$) of voltage and current until the measurement memory is full (approx. two weeks of recording for 2 GB of memory). The user can stop the recording at any time. Before the measurement, set aggregation time at $\frac{1}{2}$ **period**. Other settings and measurement arrangements are not limited.

The second way to measure the inrush current is to set the current event to the selected current value (in *Sonel Analysis* select **CURRENT** screen ► **BASIC** ► **LOG EVENTS**). After exceeding the set current value, the analyzer will record a waveform (up to 1 s) and an RMS $\frac{1}{2}$ graph (up to 30 s).

2.11 Example of use

The procedure presented below shows how to make a sample measurement with the analyzer ('step by step'): from connecting the device to generating the measurement report. It provides guidelines how to quickly start to operate the analyzer and *Sonel Analysis* software. It is assumed that *Sonel Analysis* software is already installed. The example assumes the use of PQM-703 analyzer. If using an analyzer without transient measurement capability, skip settings that refers to transient measurement.

Scenario: single-phase measurement acc. to user settings.

Measurement scenario is as follows: the user wants to measure voltage parameters of 1-phase network 230 V 50 Hz. The measurement is to be made with averaging equal to 1 second. The following parameters are to be recorded:

- average values of voltage, THD and harmonics,
- frequency,
- voltage event detection should be turned on and set at level of: 105% U_{nom} for swell, 95% U_{nom} for dip, 10% U_{nom} for interruption. When an event is detected, the waveform and RMS_{1/2} graph must be recorded.
- waveshape variations events should be enabled, with the threshold set at 10%, and the hold-off time for recording next events set at 5 seconds,
- detecting events resulting from changes in the phase angle, with the threshold set at 10°,
- transients should be activated at the lowest possible voltage threshold of 50 V (the most sensitive setting) and a sampling frequency of 10 MHz. Transient graph recording should be activated.

After the measurement, generate timeplots of measured parameters and a sample measurement report. Data should be saved for further analysis.

How to perform the measurements:

Step 1: Connect the analyzer to the tested network, as shown in Fig. 16. Connect inputs L1, N, and PE (for transient measurements). Current probes do not need to be connected, as the current measurement is not required. Power supply of analyzer (red wires) may be also connected to the tested network, or other power supply that is compatible with analyzer's power adapter input ratings, to avoid battery discharge during recording.

Step 2: Turn on the analyzer by pressing  button. Screen 1 should be displayed as shown in Fig. 5.

Step 3: Connect the analyzer to a PC via USB cable. If this is the first connection, wait to install the drivers of the analyzer.

Run "*Sonel Analysis*" program.

Step 4a: If after launching *Sonel Analysis* the **STARTUP WINDOW** is displayed, select **SET UP AND RECORDING** and then **ADVANCED RECORDING SETTINGS** - move to **4c** (below).

Step 4b: When **STARTUP WINDOW** is not displayed, click **RECORDING SETTINGS** button on the toolbar of *Sonel Analysis* or select **ANALYZER** → **RECORDING SETTINGS** from the menu. In the displayed window, select **ADVANCED RECORDING SETTINGS**.

Step 4c: A window will be displayed, showing the detailed configuration of the analyzer. Click **RECEIVE SETTINGS** button. This will result in reading the current configuration of the measurement points saved in the analyzer.

Step 5 (optional): If the analyzer has not been previously connected to the program (status at the bottom bar of *Sonel Analysis* indicates **DISCONNECTED** in red, when the analyzer is not connected to the program), then clicking **RECEIVE SETTINGS** will result in displaying window for connecting with the analyzer. This window should display one analyzer found (if not, click **SEARCH AGAIN**). Select

2 Operation of the analyzer

the found analyzer by double-clicking it. If the analyzer has not been added yet to the database of the analyzers in the program, a window will be displayed prompting user to enter PIN code of the analyzer. Default factory code is "000" (three zeroes). Proper connection is confirmed by displaying window **CONNECTION ESTABLISHED** (the analyzer screen will display **CONNECTED TO PC (USB)**).

Step 6: Then a message will be displayed asking user to confirm the read-out of settings. Click **OK** and then in the confirming window also **OK**. Doing this will upload the settings of all four configurations - they may be viewed and changed in **ANALYZER SETTINGS** window.

Step 7: Checking allocation of the memory. In the top part of recording settings window, the program displays panel **LOCAL**. The first item in this panel is **MAIN SETTINGS**. In the main part of the window, one of the three tabs is displayed (**ANALYZER TYPE**, **Memory allocation**, **GPS SYNCHRONIZATION**). Display **MEMORY ALLOCATION** tab and ensure that there is enough space (memory allocation) on the memory card (default is 25%) for **CONFIGURATION NO. 1**. When the space is very little or set at 0%, adjust it using sliders.

Step 8: Modify the settings of **CONFIGURATION NO. 1** - carry out this operation as presented in the scenario above. In **LOCAL** panel click: **CONFIGURATION NO. 1**, to modify the settings for this point and expand the tree of cards for this point (double-clicking **CONFIGURATION NO. 1** automatically expands the tree). The following items should be displayed after expanding: **STANDARD, VOLTAGE, CURRENT, POWER AND ENERGY, HARMONICS, INTERHARMONICS**.

Advanced analyzer settings []*

Local

Configuration No. 1

Standard 1

Voltage 2

Current 3

Power and energy 4

Harmonics 5

Interharmonics 6

Configuration No. 2 7

Configuration No. 3 8

Configuration No. 4 9

Send settings 10

Receive settings 11

Analyzer

General settings

Configuration No. 1 10

Configuration No. 2

Configuration No. 3

Configuration No. 4

Basic Additional

Measurement point name 11

Voltages

Mains nominal values

Voltage Vn 230/400 V

Frequency fn 50 Hz

Mains system 3-phase 4-wire Wye 3

Triggering and averaging

Averaging period: 10s

Triggering: Immediate

Additional measurements

N-conductor current

Measured

Calculated

N-PE voltage

Events detection hysteresis 12

2,00 %

Probes type

F-1, F-2, F-3

4 max = 3,00 [kA]

13 Current limit

0,02 % [0,6A]

5 Voltage transducers

Primary 100,00 V

Secondary 100,000 V

Ratio 1,00

6 Current transducers

Primary 1,00 A

Secondary 1,0000 A

Ratio 1,00

Scheduled logging

Period	Start	Stop	Span
	09/08/2017 12:45:58	09/08/2017 12:45:58	
	09/08/2017 12:45:58	09/08/2017 12:45:58	
	09/08/2017 12:45:58	09/08/2017 12:45:58	
	09/08/2017 12:45:58	09/08/2017 12:45:58	

Estimated memory usage 0,0% (0,0/1 874MB) Total time span 0s

Fig. 27. Main settings of the recording configuration.

To change the main settings of the recording configuration, single-click **CONFIGURATION NO. 1** at **LOCAL** panel. The screen should look as shown in Fig. 27.

Set the following items:

- mains system (element **3** as in Fig. 27) as a single-phase,
- nominal voltage **1** at 230/400 V,
- nominal frequency **2** at 50 Hz,
- averaging period **8** at 1 s,
- triggering **9** at Immediate,
- event detection hysteresis **12** at 1.5%,
- probe type **4** set to **NONE**,
- voltage transducers **5** and **N-PE VOLTAGE** (in section **ADDITIONAL MEASUREMENTS 7**) set as unchecked,

In the upper part of the window select the second tab **ADDITIONAL**, where sliders may be used to set the required time of recording waveforms and RMS_{1/2} graphs for events and recording times for transient graphs. These times should be set according to individual preferences.

Then select **Standard** card from the tree with settings and ensure that **ENABLE LOGGING ACCORDING TO STANDARD** box is not checked.

Adjust settings at **VOLTAGE** card and **BASIC** tab, as shown in Fig. 28.

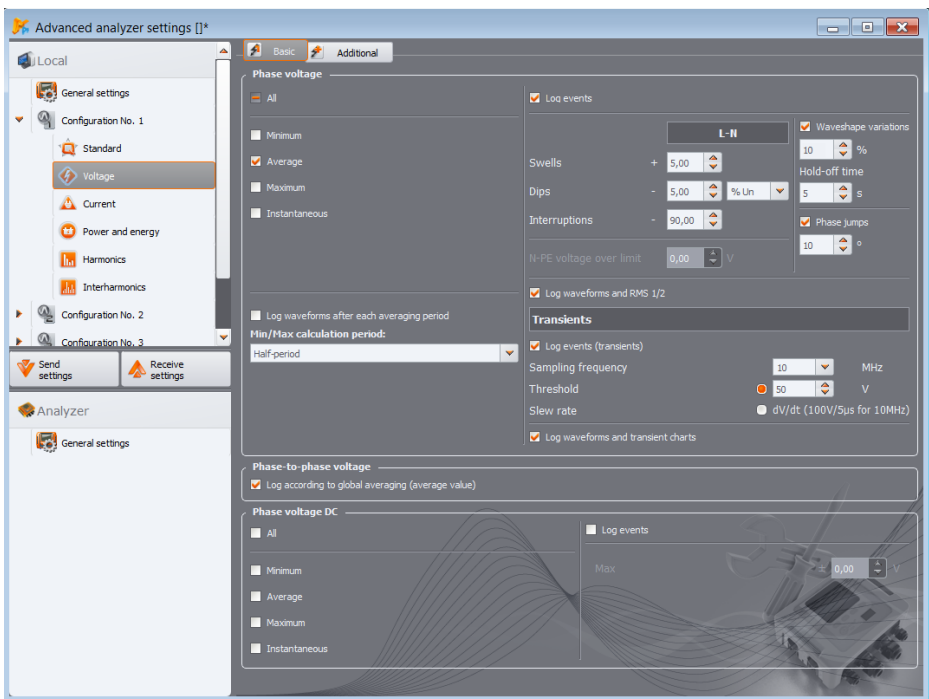

Fig. 28. Settings for 'Voltage' card in scenario.

2 Operation of the analyzer

At **ADDITIONAL** card select only the average value for the frequency, and uncheck other boxes.

At **HARMONICS** card and **VOLTAGE** tab select fields for THD average values and for voltage harmonic amplitudes - uncheck other boxes. List **THD CALCULATED FROM** may be set according to own requirements.

At **INTERHARMONICS** card and in **VOLTAGE** and **MAINS SIGNALLING** uncheck all the boxes.

Step 9: Settings of the measurement point has been properly prepared. The next step is to send the settings to the analyzer. The memory card will be formatted. To do this press **SEND SETTINGS** button. In the displayed window confirm the deletion of all data on the memory card of the analyzer and sending the new settings. If successful, a window will be displayed, to enable you immediately start recording. Select **YES** and the window **CONTROL** will be displayed.

Step 10: If window **CONTROL** is not open (option **NO** selected), then on the toolbar click **CONTROL**, or select it from menu **ANALYZER→CONTROL**. The analyzer is ready to start recording acc. to specified settings. To begin recording at the **CONFIGURATION NO. 1**, in the displayed window **CONTROL** select from **CURRENT CONFIGURATION** the first position, that is *configuration no. 1* (this field contains a list of names given to individual configurations) and start recording by clicking **START**. Start of the recording will be indicated by the analyzer by triple beep and recording is indicated on the display of the analyzer by flashing **P1** symbol in the upper left corner. Recording may be continued for any length of time; connection of the program with the analyzer is not required. During the measurement, disconnect L1 lead from the tested network to simulate a voltage dip.

Step 11: Stop recording and upload data for the analysis. Display **CONTROL** window (if not open yet). Click red button **STOP**. Click **ANALYSIS** icon on the toolbar (or select **ANALYZER→ANALYSIS** from the menu), to open the window for loading previously recorded data for analysis.

The window shows four bars of memory used for each of the measurement points. Check the box next to the bar of measurement point No. 1. The size of recorded data is shown in the right side of bar. After selecting it, **LOAD DATA** button is activated - press it. A window will appear showing data loading progress. After loading all data, a window is displayed for saving downloaded data into the disk. It is recommended to save the data to a desired location on the disk, in order to retrieve it for further analysis. Indicate the location on the disk, name the file and click **SAVE**.

In the displayed window click on the horizontal bar indicating time of recording placed under text **CONFIGURATION NO. 1 (USER)** (after clicking it turns orange) and then click **DATA ANALYSIS**.

Step 12: Data analysis. In the main window of data analysis four main buttons are available: **GENERAL** (default view after loading data), **MEASUREMENTS**, **EVENTS**, **CONFIGURATION**. In **GENERAL** view, on the right side, icons are displayed representing individual measurements, event and recorded waveforms in the timeline. This graph with a large amount of data may be freely enlarged to get more details.

Click **MEASUREMENTS** button to display table with the values of all measured parameters, according to selected averaging time. In this scenario, the selected averaging time is equal to 1 second, therefore every second the analyzer recorded voltage THD and harmonics (frequency is always measured every 10 seconds). Each line contains the data recorded in the consecutive second and each column shows individual parameters.

After pressing **EVENTS** you may view all the recorded events. In this scenario, the following voltage events were recorded: swell, dip, interruption and transients. Each row in the table corresponds to one detected event. When for a given event graphs are available (e.g. waveforms and RMS_{1/2} graphs), as in this scenario, the last column contains the icon of saved graphs. After clicking it, the user may display graphs related to a given event.

Step 13: Display the time plot for voltage and THD. To generate the graph, go to **MEASUREMENTS** (click **MEASUREMENTS** button), select column headings for L1 voltage, THD L1 (columns will be

highlighted along with the *Time* column) and then click **PLOTS** and choose **TIME PLOT**. A window will be displayed with a graph containing two timeplots: L1 voltage and THD. The graph may be freely enlarged, using the three markers mark specific points on the graph and read the parameters of indicated points. The graph may be saved (in selected graphic format) by clicking **SAVE** icon on the top toolbar.

Step 14: Displaying graphs with harmonics. Two types of graphs may be displayed for harmonics. The first one is a graph of recorded harmonics during the recording period. To display the graph, first select the time column and then the columns of selected harmonics (e.g. third and fifth order) and **CLICK PLOTS** → **TIME PLOT**.

The second type of the graph is a bar graph of harmonics. It shows all the harmonics in selected 1-second interval (one row). To generate it, first select the desired cell from the time column and then select the column of any harmonic, click **PLOTS** and choose **HARMONICS**. In the same manner, the user may also select the time interval by dragging time column cells. Then a graph is shown with average values of harmonics in the specified time period.

Step 15: Generating measurement report. In order to generate a report containing values of required parameters, select the columns of these parameters (always select the time column first), and then click **REPORTS** and select **USER REPORT**. Click **PREVIEW** in the displayed window to see saved data. **SAVE** button saves data in a format specified by the user (PDF, HTML, TXT, CSV).

Step 16: Checking events. If the analyzer, during recording process, detects any event, it will be displayed in a table in **EVENTS** view. The row describing the specific event displays time of the event (start and end), extreme value (e.g. minimum voltage during the dip), waveform and RMS_{1/2} graph when the event was voltage- or current-related. In this scenario, event graphs were activated in settings, therefore when the analyzer detects any event, the last column of the table (with **WAVEFORM** header) should include a graph icon. Click it to display the graphs.

2.12 Time Synchronization

2.12.1 Requirements of IEC 61000-4-30

The analyzer has a built-in GPS receiver, whose main purpose is to synchronize the analyzer clock with an atomic clock signal distributed via GPS satellites. Time synchronization of the analyzer with UTC is required by IEC 61000-4-30 standard for Class A for marking the measurement data. Maximum error cannot exceed 20 ms for 50 Hz and 16.7 ms for 60 Hz. Such action is necessary to ensure that different analyzers connected to the same signal provide identical read-outs. Synchronization with UTC is also needed when the network of analyzers is dispersed. When the source of the time signal becomes unavailable, an internal real-time clock has to ensure the accuracy of time measurement with accuracy better than ± 1 second to 24 hours, but even in these conditions, to ensure the compliance with class A, the accuracy of measurement must be the same as previously specified (i.e., max. 1 period of mains).

2.12.2 GPS receiver

A GPS receiver and antenna is installed inside the analyzer, in order to receive GPS signal outdoors without any additional accessories. The antenna is installed in the lower left corner of the casing under the top cover (in a place where GPS logo on the sticker is applied). To enable the time synchronization of the analyzer inside buildings, the analyzer must be connected to an external antenna (optional accessory), with a cable of 10 m and installed outside of the building. The analyzer detects the external antenna and switches into the receiver mode instead of using additional internal antenna.

GPS synchronization time depends on weather conditions (clouds, precipitation) and on the location of the receiving antenna. The antenna should be provided with high "visibility" of the sky in order to obtain the best results. To read the time with the required accuracy, the GPS receiver must first determine its own current geographical location (it must "see" at least 4 satellites - position and altitude). After determining the position and synchronizing time to UTC, the receiver enters the tracking mode. To ensure time synchronization in this mode, the visibility of only one GPS satellite is required. However, to determine the analyzer position (when it is moved), still four satellites must be available [seen] (3 satellites if GPS does not update the altitude data). This is important for example in anti-theft mode, when the device needs continuous position information.

2.12.3 Data flagging concept

The analyzer saves measurement records along with the flag indicating the lack of time synchronization. If for the whole averaging period the analyzer was synchronized to UTC, then the flag

is not turned on and during data analysis the icon indicating the lack of synchronization  is not displayed. The absence of this icon indicates full compliance of gathered data with Class A in terms of time marking. Synchronization with UTC is also indicated on the screen of the analyzer by green date and time on the top bar.

When the analyzer was initially synchronized to UTC (GPS status on the analyzer screen displayed as **YES**) and later the signal was lost (**NO SIGNAL** status), this does not mean that the analyzer immediately lost the synchronization of its clock. In fact, for some time (even a few minutes or more) internal timing accuracy is sufficient to meet the requirements of IEC 61000-4-30 in part relating to the accuracy of determining time data. This is because the internal clock of the analyzer is very slow in de-synchronizing from UTC time (due to no GPS signal), and the error does not exceed a few milliseconds for an extended period of time. Thus, despite the "No signal" status, data will continue to be saved without the flag signalling the lack of synchronization to UTC. Only when the error exceeds the limit value the flag will be turned on.

2.12.4 Time resynchronization

As the availability of the GPS signal cannot be guaranteed on a permanent basis, it is necessary to ensure proper management of internal time when the GPS signal becomes available and when it differs from the internal time of the analyzer.

When no recording is on - the situation is simple - after receiving the satellite time, the analyzer clock automatically synchronizes with it without any additional conditions.

When the recording process is on, a sudden change of the internal time may lead to a loss of measurement data when time is reset, or it may create a time gap in gathered data, when UTC time is ahead of the analyzer time. To prevent this, a slow synchronizing mechanism was introduced to synchronize the internal analyzer time with UTC time. The implementation of this concept is based on the deceleration or acceleration of the internal analyzer clock in such a manner that after a time the two clocks - internal and GPS - are equalled and achieve synchronization. The advantage of this solution is the fact that there is no data loss or discontinuity.

The user has the option to set two configuration parameters that affect the resynchronization during the recording process. One of them (resynchronization factor) defines the speed of the synchronization. The lower is the factor value, the longer is resynchronization, but the length of the measurement intervals will be close to the averaging time.

Despite the aforementioned disadvantages of an abrupt time change, there is an option to carry it out even when recording process is active. A threshold is defined in seconds (**TIME RESYNCHRONIZATION THRESHOLD** parameter), to set the minimum difference between internal and UTC time at which the abrupt (one-step) time change will be performed.

Note

*Abrupt change of time during the recording process may lead to irreversible loss of recorded data, therefore it is advised to use the slow resynchronization mode (**TIME RESYNCHRONIZATION THRESHOLD** parameter set to zero).*

To avoid the problems with time measurement during recording, please remember the following issues:

- The analyzer must have properly set its time zone and the time displayed on its screen must be precisely compatible with local time (if there is no GPS signal before starting the recording).
- Turn slow resynchronization of time, by setting **TIME RESYNCHRONIZATION THRESHOLD** parameter to zero value and set resynchronization factor at a low value (e.g. 25% or less).
- If possible, before starting the process of recording, receive the GPS signal to synchronize the analyzer time to UTC. This will ensure the least possible timing errors during the recording and a fast tuning time in case of a temporary loss of GPS signal.
- In order to ensure the compliance of the whole measurement with requirements of IEC 61000-4-30 in terms of time marking for devices of Class A, the internal analyzer clock must be synchronized to UTC, and GPS signal must be available for the whole process of recording.

2.13 GSM communication mode

2.13.1 General information about GSM connection

Built-in GSM modem ensures wireless communication with the analyzer from almost any location with Internet access. Similarly as in case of USB and OR-1 connection, this mode provides the user with a full control of the analyzer - the user may view current data, start and stop recording, read the data for analysis, etc. To use this mode, the analyzer must be equipped with a SIM card of the following service parameters:

- General Packet Radio Service (GPRS)
- static public IP address,
- SMS option to send alarm messages.

Note

Ordinary SIM card removed from a cell-phone cannot be used with the analyzer. GPRS in the analyzer requires a non-standard static IP address service, reserved only for a given SIM card. This static IP address ensures that the analyzer has one permanent address in the Internet. This type of service is commonly used for transmission "machine-to-machine" (M2M) used e.g. in industry transmissions for monitoring and exchanging measurement data between devices.

The communication is performed in the following manner:

- the modem connects to a GSM network, and then log on to the Internet,
- the modem initiates TCP/IP server service with IP address assigned by the service provider. Usually, the port number used by the analyzer is 4001. The analyzer is present in the Internet with this IP and port.
- PC from which the user tries to connect with the analyzer via GSM modem must have access to the Internet.
- "Sone! Analysis" software while searching for analyzers, tries to connect to those analyzers that have IP number configured in the data base (additionally the user must enable **TCP/IP OVER GSM** in program settings). Only port 4001 of a remote host is checked by default.
- If an analyzer is found under typed address and its serial number match the serial number of an analyzer in the database, then the device will be shown in the list of found devices.
- After connecting the communication will be performed via the Internet. After completing the connection, the software closes the connection with the analyzer, which enters a "stand-by" mode waiting for a client connection.

2.13.2 Modem Configuration

In order to configure the SIM card and modem in the analyzer, the user must obtain the following data from the data transmission service provider:

- PIN code for SIM card
- PUK code for SIM Card - for emergency cases, when SIM card is locked after repeated attempts of enter wrong PIN,
- IP number assigned to SIM card (it must be a static number),
- APN (*Access Point Name*),
- user name and password (optional, usually not required).

Configure the analyzer for GSM connectivity in the following manner:

- connect to the analyzer via a USB cable. If the analyzer is not present in the database it should added to it.
- it is necessary to check whether the modem is turned on. To do this, select **ANALYZER** → **ANALYZER SETTINGS** from the program menu and go to **WIRELESS CONNECTIONS** card. Check whether **GSM TRANSMISSION AVAILABLE** option is active - enable it if it is not.
- disconnect the USB connection and use buttons to select screen **<8>**. If the modem is switched on, but no SIM card is inserted, line **GSM** will show message **No SIM CARD**.
- insert SIM card into the slot on the side of the device The slot is of "push-push" type (push gently to remove the card - it will be pushed out by the device). The analyzer will detect inserted card and will attempt to connect to the network.
- if PIN code of the SIM card has not been configured, the analyzer displays message **INVALID PIN CODE OF SIM CARD**. This message will also be displayed on screen **<8>**. It means that the SIM card rejected PIN, which was used by the analyzer to attempt the communication. This is normal when you insert a new card into the analyzer.
- To configure missing parameters required to perform GSM transmission, the user must re-connect PC to the analyzer via USB and choose **OPTIONS** → **ANALYZER DATABASE** from the program. In the analyzer database enter the option for editing the analyzer settings (click the line with the serial number of appropriate analyzer and click **Edit**). Click **CHANGE GSM SETTINGS** button.
- In the displayed widow enter the following data: IP number - in **IPv4** field (it should be provided by the service provider) **APN**, username and password (if required and provided by the service provider). Confirm new data by pressing OK.
- Then a pop-up will be displayed, asking you to enter PIN code of the SIM card. Enter the code supplied with the SIM card and confirm it by clicking OK.
- If you have entered the correct data, the analyzer will use it to properly log into the GSM network. The connection status may be checked in screen **<8>** of the analyzer (USB session must be disconnected). Correct connection is indicated by GSM status: "**READY, <connection type>**". *<connection type>* depends on the location and type of data transmission services in the area.
- the correct order of the messages displayed on screen **<8>** when connecting to GSM network is as follows:
 - **TURNING ON...**
 - **CONNECTING TO NETWORK...**
 - **CONNECTING TO INTERNET...**
 - **READY, <connection type>**

2 Operation of the analyzer

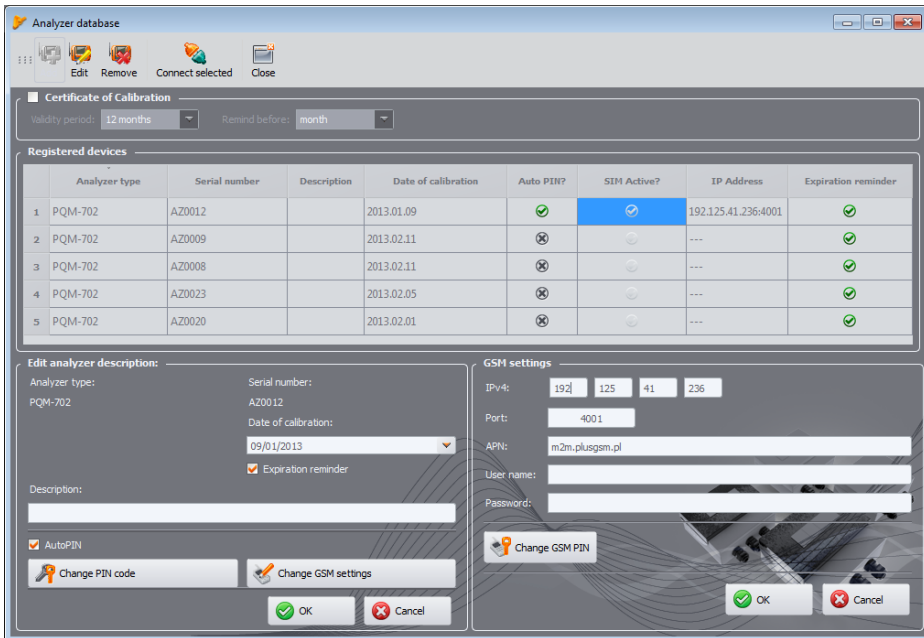

Fig. 29. Entering GSM settings in the analyzer database

If you remove the SIM card from the slot, the analyzer will display error message **NO SIM CARD**. This message is repeated during next activations of the analyzer. Removing the SIM card while the analyzer is in operating mode, it is not recommended, as it prevents correct analyzer logging off from the GSM network.

Note

After any change in GSM settings, automatic modem restart is initiated.

2.13.3 Checking GSM connection

If status screen <8/9> shows the status of GSM modem as "**READY**, <connection type>", it means that a connection from a remote PC may be performed via Internet. The user may perform a test connection to verify the connectivity with "*Sonel Analysis*":

- In the program settings, check whether the search of the analyzers via GSM network is enabled: select **OPTIONS** → **PROGRAM SETTINGS** → **MEDIA SETTINGS** → **ACTIVE MEDIA**. Check **TCP/IP OVER GSM** box.
- The analyzer that is chosen for the connection must be entered into the Analyzer database (when the modem was configured as described in sec. 2.13.2 this will be ensured).
- Disconnect any connection to the analyzer (USB or OR-1).
- Perform a search for the analyzer, selecting any available method (e.g., by clicking **LIVE MODE**). The search list should show the analyzer with note "**(GSM)**". Select the analyzer and click **SELECT**.

- After a while, the screen should display the desired window (e.g. **LIVE MODE**) and the status bar should display **CONNECTED** message. Also the analyzer screen will display **CONNECTED TO PC (GSM)** message. The connection attempt was successful.

2.13.4 Possible problems with GSM settings and troubleshooting

Problem: The search progress bar quickly reaches 100% and no analyzer is found.

Possible cause: It may indicate that GSM search is disabled in program settings or in the analyzer database.

Solution: from program menu select **OPTIONS → PROGRAM SETTINGS → MEDIA SETTINGS → ACTIVE MEDIA**. Check **TCP/IP OVER GSM** box.

Problem: The search progress bar in a few sec. reaches 100% and no analyzer is found.

Possible causes:

- 1) The analyzer is turned off or its GSM is inactive / not configured.
- 2) IP address of the analyzer does not match the address entered into the database of analyzers.
- 3) The analyzer has active GSM connection with another client or temporary network problems.

Solution:

- 1) When the analyzer is available check the status of GSM modem on screen **<8>**. If the status is **DISABLED**, then select: Select **ANALYZER → ANALYZER SETTINGS** from the program menu, go to **WIRELESS CONNECTION** card and check whether **GSM COMMUNICATION ENABLED** is enabled (if not, enable it). Check settings of the modem.
- 2) Check whether the correct IP address is entered to the database of analyzers.
- 3) Try again in a few minutes.

Problem: Despite correct status ("**READY, <connection type>**"), after the search, the analyzer is not displayed on the list. Option **GSM COMMUNICATION ENABLED** is enabled and the analyzer is properly configured in the database (including IP number).

Possible cause: TCP 4001 port is blocked - it is used for communication through a firewall installed on the PC or in the server of internet service provider.

Solution: check whether TCP 4001 port in program settings is not blocked. If it is not, please contact your local network administrator.

Problem: When a SIM card is inserted into the analyzer, message **INVALID IP** is displayed.

Possible cause: IP number assigned by the network is different than the one configured in the analyzer.

Solution: Check whether the analyzer database includes the correct IP number, as specified by the provider. In the analyzer database enter settings and select **CHANGE GSM SETTINGS**. Enter the correct IP address and confirm. Disconnect the analyzer and using the screen of GSM connection status to check whether the analyzer properly connects to the Internet. If this does not help, check whether the inserted SIM card is correct.

Problem: The analyzer reports an error of **INVALID PIN CODE OF SIM CARD**.

Possible cause: PIN code used by the analyzer to unlock the SIM card is incorrect. This may be caused by replacing SIM cards, or changing the PIN code of the card by an external device.

Solution: After connecting the analyzer via USB cable, enter the analyzer database and select **CHANGE GSM SETTINGS**, and then **CHANGE GSM PIN**. Enter any of the four digits in **PREVIOUS PIN** (this field is ignored in this case), and then enter the same correct SIM code in the two fields below. Save the settings. Disconnect the analyzer and screen **<8>** will be displayed by the analyzer to check the status of GSM (whether the connection available or not).

Problem: Analyzer reports a GSM error by displaying **PUK REQUIRED**.

Possible cause: The card inserted into the analyzer is blocked due to several attempts of entering incorrect PIN code. Unlock the SIM card by entering PUK code.

Solution: After connecting the analyzer via USB cable, enter the analyzer database and select option **CHANGE GSM SETTINGS**. Select **CHANGE GSM PIN**. This should open a window allowing you to enter PUK code and new PIN code. Enter the codes and confirm. Disconnect the analyzer and on screen **<8>** check the status of GSM (whether the connection is made properly).

The card may be also unlocked by inserting it into any mobile phone and entering PUK code and a new PIN code.

Note: several attempts to enter incorrect PUK code will result in irreversible blocking of the SIM card!

Problem: The analyzer reports GSM errors: **NETWORK ERROR, SMS ERROR, NO NETWORK** or other.

Possible Cause: One of GSM network errors occurred. It may be caused by entering wrong phone number for SMS notifications or temporary loss of network coverage.

Solution: In case of SMS error, check the correctness of the entered phone number. In other cases, do not take additional steps. The analyzer will try to repeat the operation after some time (e.g. 5 minutes).

2.14 Wi-Fi communication mode PQM-710 PQM-711

2.14.1 General Information

PQM-710/711 analyzers are equipped with Wi-Fi module working in IEEE 802.11 b/g standard and n single stream.

Wi-Fi module in the analyzer may operate in two modes:

- **Access Point (AP)** – the analyzer distributes its own Wi-Fi network. Devices connecting to the analyzer operate in client mode. This mode is available in analyzers with 1.30 firmware version or later.
- **client** – the analyzer connects to an existing external access point (access point may be configured, e.g. in the tablet supplied with the analyzer or it may be an external router with a Wi-Fi access point).

2.14.2 Factory configuration

The factory Wi-Fi configuration of the tablet and the analyzer is as follows:

- Operation mode: the analyzer acts as an Access Point.
- Analyzer settings:
 - Network SSID: *analyzer_model_analyser_serial_number* (e.g. PQM-710_BR0001),
 - channel: 10,
 - IP number of the access point: 10.0.71.1,
 - Subnet mask: 255.255.255.0,
 - Automatic assigning of IP addresses (DHCP): enabled
 - WPA2-PSK encryption enabled, default key: "12345678".
- Configuration of the tablet (client):
 - IP assigned automatically by the access point: 10.0.71.X (where X is in the range of 2...254), gateway 10.0.71.1.
 - WPA2-PSK encryption enabled, default key: "12345678".

2.14.3 Access Point mode

In Access Point mode (AP), the analyzer distributes own Wi-Fi sub-network with a fixed name (SSID). The default settings of the analyzer are presented in sec. 2.14.2. External devices (e.g. PCs) may connect to the analyzer if they are equipped with a compatible Wi-Fi interface operating in client mode.

Only one client at a given time may be connected with the analyzer.

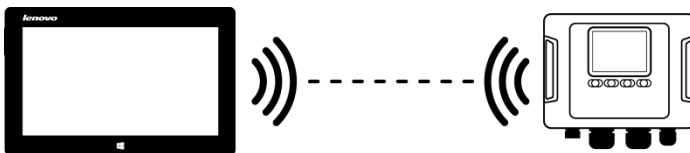

Fig. 30. Direct connection tablet/PC (client) ↔ analyzer (AP).

Access Point operating mode is indicated by the analyzer on screen <10> in the first row - next to **Wi-Fi** there is also **"AP"** displayed. This screen displays the following information:

- Status of the connection with the client (e.g. **READY**, **CLIENT CONNECTED**),
- MAC address of the analyzer's Wi-Fi module,
- IP address assigned to the access point,
- The current name of the distributed network (SSID).

2 Operation of the analyzer

The default Wi-Fi channel for analyzer operation (channel 10) may be changed when the channel is used by more devices, which may result in reduced bandwidth and mutual interference. To change the channel in the range of 1..13, assign a new SSID name, which ends with "_chX" (underscore, small letters "ch" and channel number), where X is a number indicating the channel in the range from 1 to 13. An example of SSID name, which changes the default channel to channel 5 is "PQM-711_BS0001_ch5".

When the analyzer is set in the access point mode and is ready to work, you can connect to the network distributed by the analyzer. In Windows OS, display the network connection window, find the SSID name of the analyzer on the list of available wireless networks and select Connect command. An example of such a window is shown in Fig. 31.



Fig. 31. Window of wireless network connection in Windows OS.

To connect, you need to enter the network password. It is recommended to change the default password. The password must contain at least 8 characters. If you successfully connected to the analyzer's network, the next step is to run *Sonel Analysis* software and checking the communication.

2.14.3.1 Configuring Wi-Fi connection via USB connection

The user can modify the default access point settings of the analyzer using *Sonel Analysis* software. You need to connect the analyzer via a USB cable.

Configure the analyzer in the following manner:

- Connect to the analyzer via a USB cable.
- Perform the analyzer search, e.g. by selecting **ANALYZER** → **ANALYZER SETTINGS** (F4) and connect to the analyzer.
- Go to **WIRELESS CONNECTIONS** tab (Fig. 32) and check whether **WI-FI COMMUNICATION ENABLED** is active. If it is not, enable it.

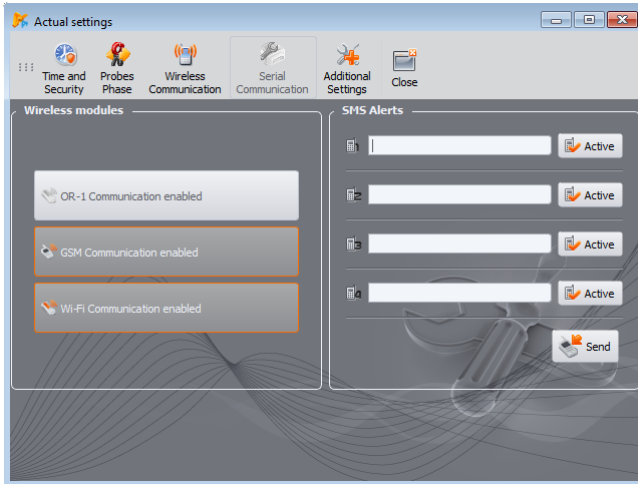

Fig. 32. Screen for settings of the analyzer, available wireless transmission media.

- Select **OPTIONS**→**ANALYZER DATABASE** (F3). In the analyzer database enter the option for editing the analyzer settings (select the line with the serial number of the analyzer and click **EDIT**). In the displayed menu, click **CHANGE Wi-Fi SETTINGS**.
- Set the **MODE** switch in **ACCESS POINT** position.
- Enter in the following order (field **NETWORK NAME (SSID)**) and network password twice (fields **NEW PASSWORD** and **CONFIRM PASSWORD**). The password must contain at least 8 characters.
- Use **RESTORE DEFAULT SETTINGS** to fill fields with default values presented in sec. 2.14.2.
- After approving the settings with **OK** button, the analyzer restarts the Wi-Fi module, and after a moment it should be ready to connect to the client with the new settings. Readiness to work and SSID name may be verified on screen <10> of the analyzer after terminating the USB connection.

2 Operation of the analyzer

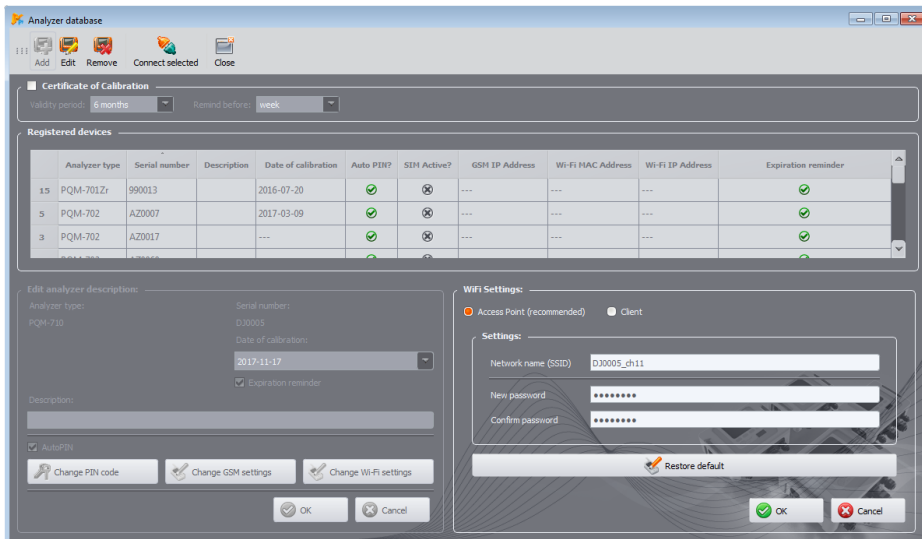

Fig. 33. Screen of configuring Wi-Fi access point.

2.14.4 Client mode

In client mode an operation in a local network (Fig. 34) or via the Internet (Fig. 35) is possible. When the tablet used has a software for setting-up the software access point, a direct connection tablet ↔ analyzer is also possible (Fig. 36 ,Fig. 37).

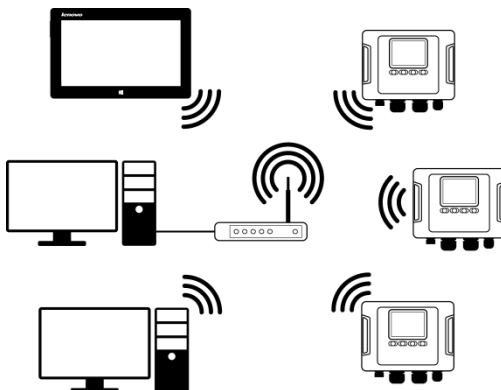

Fig. 34. Indirect connection via Wi-Fi router, local network, analyzers in client mode.

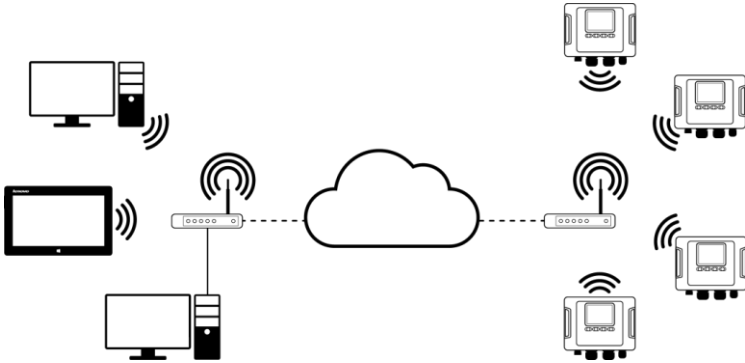

Fig. 35. Connection via Internet. Analyzers in client mode

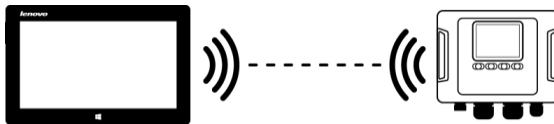

Fig. 36. Direct connection tablet (AP) ↔ analyzer (client). Requires a tablet with software access point capability (not included in software package provided by Sonel S.A.)

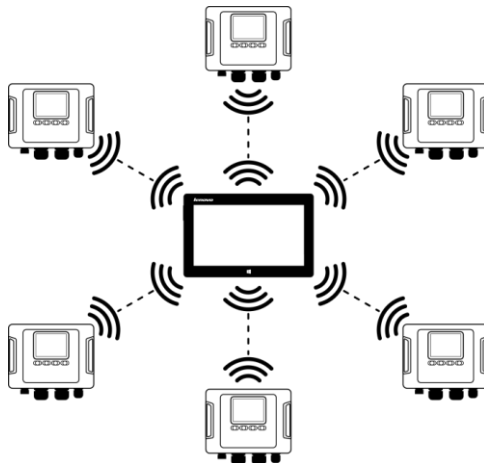

Fig. 37. Direct connection: tablet (AP) ↔ multiple analyzers (clients). Requires a tablet with software access point capability (not included in software package provided by Sonel S.A.)

2 Operation of the analyzer

In configurations with external router an operation in open or WPA/WPA2-PSK secured network is possible. When working in open networks the **KEY** field in **ANALYZER DATABASE** must be empty.

When connected to an access point, the analyzer starts TCP/IP server connections with static IP address or with an address assigned by DHCP server of the access point. The port used in the local network and for direct connections is 4002.

Connecting to the analyzer via the Internet requires a Wi-Fi router properly configured by the network administrator (redirecting traffic from the local network to the public network).

The analyzer, which has no access point within its range, remains in scanning mode of 2.4 GHz Wi-Fi band.

Remote connection of *Sonel Analysis* software via Wi-Fi is possible, when this mode is active in software settings (**PROGRAM SETTINGS** → **ACTIVE MEDIA**).

2.14.4.1 Configuring Wi-Fi connection via USB connection

To properly configure the connection, the following elements will be required:

- Access Point Name (**SSID**).
- Password (**KEY**) in case of secured networks.
- **EXTERNAL IP ADDRESS** and **EXTERNAL PORT**. These parameters are required to work in a different subnetwork than the tablet (computer), especially for connecting to the Internet.

Configure the analyzer in the following manner:

- Connect the tablet (computer) with the analyzer via a USB cable.
- Perform the analyzer search, e.g. by selecting **ANALYZER** → **ANALYZER SETTINGS** (F4) and connect to the analyzer.
- Go to **WIRELESS CONNECTIONS** (Fig. 32) and check whether **WI-FI COMMUNICATION ENABLED** is active. If it is not, enable it.
- Select **OPTIONS** → **ANALYZER DATABASE** (or F3 key). In the analyzer database enter the option for editing the analyzer settings (select the line with the serial number of the analyzer and click **EDIT**). In the displayed menu, click **CHANGE WI-FI SETTINGS**.
- Set the **MODE** switch in **CLIENT** position.
- Enter the following data: the access point name (**SSID** field) and in case of a secured network tick **MODIFY** box and enter the password (**KEY** field). In case of a non-secured network, **KEY** field remains empty, but **MODIFY** box must be ticked.

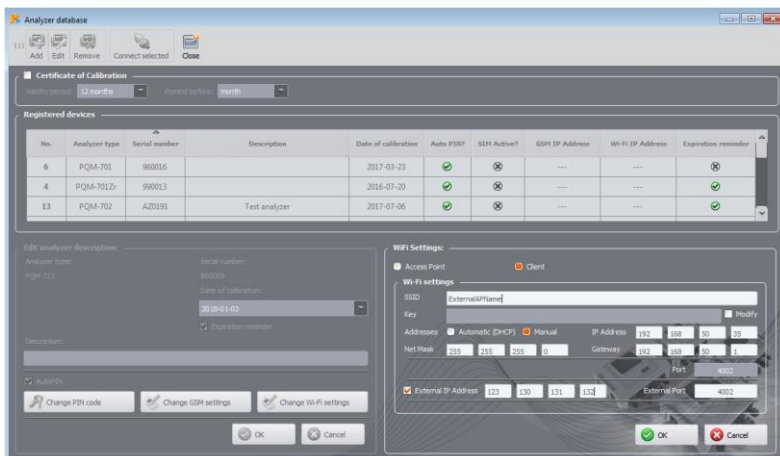

Fig. 38. Example configuration of Wi-Fi connection in client mode (external IP).

- Select the method for assigning IP address via access point. In case of selecting manual mode – enter appropriate values into fields: **IP ADDRESS** , **NET MASK** and **GATEWAY**. In automatic mode, select **DHCP**.
- **PORT** field is not editable, it is always 4002.
- In case of operating in other subnetworks (the Internet), fill-in **EXTERNAL IP ADDRESS** and **EXTERNAL PORT** fields. For a direct connection (tablet ⇔ analyzer), and for working in a local network (tablet ⇔ Wi-Fi router ⇔ analyzer) these fields must be left inactive. *Sonel Analysis* scans the network automatically and updates these fields after detecting the presence of an analyzer.
- Confirm the settings by pressing **OK**. This will send new data to the analyzer.
- If the correct data have been entered, the analyzer will try to connect to Wi-Fi access point. After disconnecting, the connection status may be followed on screen **<10>**.

The correct order of the messages displayed on the screen is as follows:

- **SEARCHING FOR NETWORK ...**
- **CONNECTING TO NETWORK ...**
- **OBTAINING IP ADDRESS...** (for DHCP)
- **READY**

2.14.4.2 Adding the previously configured analyzer to the database

The following procedure applies to cases when the analyzer was previously configured and has working Wi-Fi interface, and there is a need to add it to the database or to edit Wi-Fi parameters that identify the device.

To properly configure the connection, the following elements will be required **EXTERNAL IP ADDRESS** and **EXTERNAL PORT**.

Configure the analyzer in the following manner:

- Select the appropriate analyzer from the database and click **EDIT** or use **ADD** button to add it to the database.
- Use **CHANGE Wi-Fi SETTINGS** button. NOTE: Do not connect with the analyzer: in the window click **CANCEL**. The configuration will have it marked by **Wi-Fi SETTINGS (OFFLINE)**.
- Check the selection box: **EXTERNAL IP ADDRESS**
- Fill **EXTERNAL IP ADDRESS** by entering IP number of the analyzer (or IP assigned by the network administrator for the analyzer, which is available at this address) and **EXTERNAL PORT** (default 4002).
- Confirm the settings by pressing **OK**.

2 Operation of the analyzer

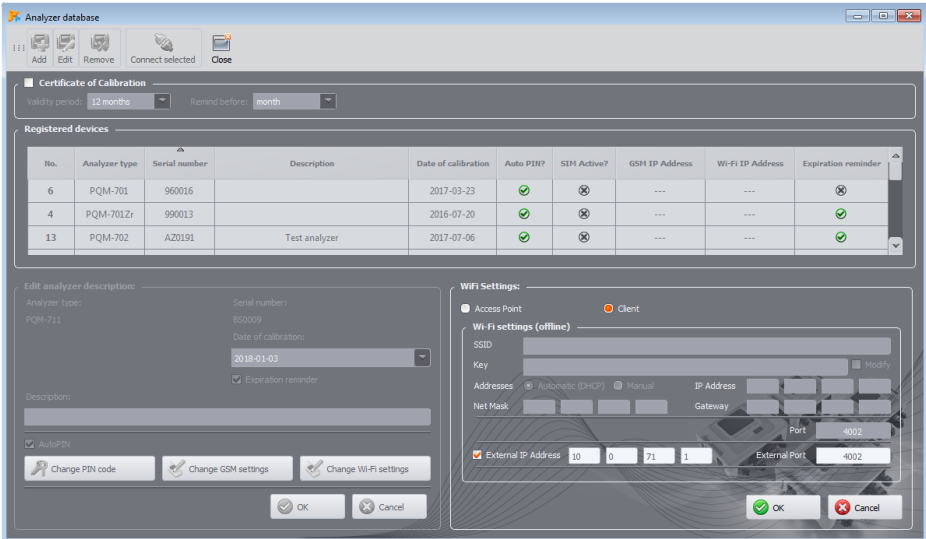

Fig. 39. Adding analyzer to database in client mode (offline)

2.14.5 Checking Wi-Fi connection

If status screen <10> shows the Wi-Fi status as **READY**, it means that a connection may be performed. The user may perform a test connection to verify the connectivity with *Sonel Analysis*:

- In the program settings, check whether the search of the analyzers via Wi-Fi is enabled: select **OPTIONS**→**PROGRAM SETTINGS**→**MEDIA SETTINGS**→**ACTIVE MEDIA**. **Wi-Fi** box should be ticked.
- The analyzer that is chosen for the connection must be entered into the Analyzer database (when the configuration was performed as described in sec. 2.14.4.1 this will be ensured).
- Disconnect the existing connection to the analyzer (USB, GSM).
- Perform a search for the analyzer, selecting any available method (e.g., by clicking **LIVE MODE**). The search list should show the analyzer with note **Wi-Fi CONNECTION**. Select the analyzer and click **SELECT**.
- After a while, the screen should display the desired window (e.g. **LIVE MODE**) and the status bar should display **CONNECTED** message. Also the analyzer screen will display **CONNECTED TO PC (Wi-Fi)** message. The connection attempt was successful.

2.14.6 Possible problems with Wi-Fi and troubleshooting

Problem: The search progress bar quickly reaches 100% and no analyzer is found.

Possible cause: It may indicate that Wi-Fi search is disabled in program settings or in the analyzer database.

Solution: From program menu select **OPTIONS**→**PROGRAM CONFIGURATION**→**MEDIA SETTINGS**→**ACTIVE MEDIA**. **Wi-Fi** box should be ticked.

Problem: The search progress bar quickly (in a few sec.) reaches 100% and no analyzer is found.

Possible causes:

- 1) The analyzer is turned off or its Wi-Fi connection is inactive/not configured.
- 2) IP address of the analyzer do not match to the address entered into the database of analyzers.
- 3) The analyzer has active Wi-Fi connection with another client or temporary network problems.

Solution:



- 1) When the analyzer is available check the Wi-Fi status on screen <10>. If the status is **DISABLED**, then select: **ANALYZER**→**ANALYZER SETTINGS** from the program menu, go to **WIRELESS CONNECTION** card and check whether **Wi-Fi COMMUNICATION ENABLED** is enabled (if not, enable it). Check Wi-Fi settings.
- 2) Check whether the correct IP address and port (only client mode) is entered to the database of analyzers.
- 3) Try to re-establish the connection.

Problem: (Applies to Access Point mode only). The network distributed by the analyzer is shown in the list of available networks, but an attempt to connect ends with error.

Possible causes:

- 1) The analyzer has been already connected to another client (screen <10> displays status **CLIENT CONNECTED**), or connection with *Sonel Analysis* is active with another computer (the screen displays message **CONNECTION WITH PC (Wi-Fi)**).
- 2) Error of network or Wi-Fi module of the analyzer.

Solution:

- 1) Disconnect the second client with the access point in the analyzer.
- 2) Restart Wi-Fi module in the analyzer by holding for at least 1.5 second the **LEFT** arrow button  or **RIGHT** arrow button,  until the display flashes. Try to connect again (NOTE: this restart is only possible when there is no active connection with *Sonel Analysis*).

Problem: Despite correct status **READY**, after the search, the analyzer is not displayed on the list. Option **Wi-Fi COMMUNICATION ENABLED** is enabled and the analyzer is properly configured in the database (including IP number).

Possible cause: TCP 4002 port is blocked – it is used for communication through a firewall installed on the PC (tablet) or in the server of internet service provider.

Solution: check whether TCP 4002 port in program settings is not blocked. If it is not, please contact your local network administrator.

Problem: During direct connection to the analyzer the transmission speed drops below 200 kB/s.

Possible causes:

- 1) The distance between the device and the Access Point/PC is too large.
- 2) Too much interference in the channel used for the transmission.

Solution:

- 1) Shorten the distance between devices to a less than 10 m.
- 2) Change the channel used for communication. When the analyzer is acting as access point then try to change the channel as described in 2.7.4. If an external Wi-Fi router is the access point, then force its operation in another channel.

Problem:

The connection with the analyzer is lost.

Possible cause:

- 1) In the window for wireless connections (Fig. 32), the Wi-Fi was disabled.
- 2) External Wi-Fi access point was disabled (only *Client* mode).
- 3) The distance between the analyzer and the PC is too large in case of a direct connection.
- 4) The distance between the analyzer and the Wi-Fi access point or between computer (tablet) and the Wi-Fi access point
- 5) Too much interference in the channel used for the transmission.

Solution:

- 1) Connect the analyzer via USB cable and enable Wi-Fi transmission in the analyzer (Fig. 32)
- 2) In *Client* mode: turn on a Wi-Fi access point and wait until the analyzer connects to it. On screen <10> Wi-Fi status is **READY**.
- 3) In *Client* mode: approach with the tablet to the analyzer and try to connect again. Preferably, the analyzer should be within sight, then screen <10> shows Wi-Fi status and signal level. Only **READY** status guarantees the ability for connection. Preferably, the indicated signal level should have at least two bars.
- 4) If possible, place the analyzer/computer (tablet) and/or Wi-Fi access point in a place where the level of Wi-Fi signal is indicated by at least two bars – both in the analyzer and the computer.
- 5) Change the channel used for communication. When the analyzer is acting as access point then try to change the channel as described in 2.7.4. If an external Wi-Fi router is the access point, then force its operation in another channel.

2.15 Notification of analyzer changed location

The analyzer, which operates a GSM modem and is within a range of GPS, may notify the user about its movements. To use this feature the user must activate **ANTI-THEFT FUNCTION** from the PC program and fill the appropriate list of emergency phone numbers for sending SMS messages with appropriate information. In this mode, the analyzer saves the position where it was acquired for the first time after turning on the recording and then sends an SMS message to the defined phone number(s), if the analyzer changes its location by more than 100 m. SMS message contains the actual coordinates of the analyzer. Also "*Sonel Analysis*" enables user to connect user to the analyzer via GSM to check the analyzer current location on the status screen (even when the analyzer is turned off - see below). When the analyzer remains for a long time at a distance greater than 100 m from its start position, then it sends SMS messages every 10 minutes detailing the current position of the analyzer (max. 10 SMS messages).

In adverse conditions for GPS reception (weak signal, signal reflections) the analyzer may send erroneous message on the location. The user is also notified of the loss/return of GPS signal by additional SMS messages.

After activating the anti-theft function, the analyzer behaves differently during switch-off mode: GSM modem and a GPS receiver are continuously active. This is also the cause of faster discharging of the battery in the absence of power supply from mains, similarly as during normal operation with the battery power supply. After discharging, the analyzer will switch-off totally and sending SMS messages will be impossible.

Note



Anti-theft feature requires the following arrangements for proper operation:

- active GSM modem with properly configured SIM card,
- at least one emergency telephone established to send SMS's.

While activating the anti-theft function, both of the above features must be checked.

2.16 Key lock

Using the PC program, the user may select an option of locking the keypad after starting the process of recording. This solution is designed to protect the analyzer against unauthorized stopping of the recording process. To unlock the buttons, the user must enter a code consisting of 3 digits:

- pressing any button will display message **ENTER CODE**, and three dashes "- - -"
- using buttons on the keyboard, the user can enter the correct unlock code: button  may be used to enter the correct unlock code: whereas button changes numbers in sequence 0, 1, 2...9, 0 at the first position, button  on the second and button  on the third.
- a three-second inactivity on the keyboard will start the verification of the entered code,
- correctly entered password is indicated by word **OK** and the lock is cancelled, whereas entering wrong password results in displaying message **INVALID CODE** and returning to the previous state (e.g. blank screen when it was blank before).

After unlocking, the keyboard automatically locks again, if the user has not pressed any button for 30 seconds.

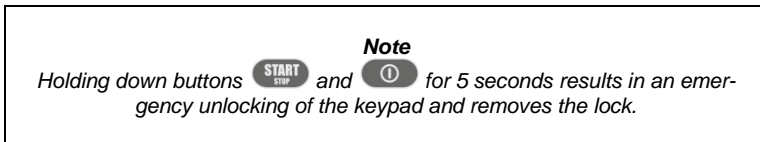

2.17 LCD sleep mode

The PC program provides an option to activate the **SLEEP MODE**. In this mode, after 10 seconds of the recording, the analyzer switches off the display. From this point, every 10 seconds the screen displays (in its upper left corner) the number of measurement point to indicate active recording. After completing recording (e.g. when the memory is full) the screen remains blank until the user presses a button.

2.18 Temperature protection





The analyzer has a temperature protection feature. When the internal temperature exceeds the specified threshold (limit operating temperature of electronic components), the analyzer stops the current operation (e.g. recording) and displays the message **MAX. OPERATING TEMP. EXCEEDED!** and then automatically switches off for 10 minutes to cool-down. The analyzer restarts when the internal temperature drops by at least 5 °C, otherwise it switches off again and the cycle is repeated.

2.19 Emergency time setting

The analyzer includes an internal button cell that supports real-time clock (RTC), regardless of the state of the Li-Ion battery. When the battery is discharged after activation of the meter, the time will be reset. To allow further work in the absence of access to a computer with *Sonel Analysis* software when it is impossible to synchronize the time with GPS time, the analyzer after starting detects the wrong time and enables its manual setting. The screen will display message **INCORRECT DATE/TIME DETECTED!** and the screen for setting the date and time will be displayed. In the next fields, the display shows the date and time in format DD.MM.YYYY, where:

- DD - day
- MM - month
- YYYY - year
- hh - hour
- mm - minutes
- ss - seconds

To set the time:

- use buttons  and  you can change the value of the selected parameter (holding down the button will automatically increase the value)
- use button  you can scroll successive parameters; the active parameter is highlighted,
- to confirm the setting, hold the  button for 2 seconds,
- to skip setting the time you can press  or wait 30 seconds without pressing any button.

3 Design and measurement methods

3.1 Voltage inputs

The voltage input block is shown in Fig. 38. Two measurement blocks are shown: on the right side of terminals main voltage circuits are presented - they are used for majority of voltage measurements. Sampling frequency of this circuit is 10.24 kHz. Three phase inputs L1/A, L2/B, L3/C and ground conductor (PE) have common reference line, which is the N (neutral) conductor.

PQM-703 PQM-711 On the left side: connection of transient module with input terminals (PQM-703 and PQM-711 only). As it is shown, all four channels are referenced to PE input. This circuit has wide bandwidth (sampling frequency: up to 10 MHz) and a greater range of measured voltages.

Fig. 38 presents that the power supply circuit of the analyzer is independent of the measuring circuit. The power adapter has a nominal input voltage range 100...690V AC and has separate terminals.

The analyzer has two voltage sub-ranges in the main circuit:

- low-voltage range, with peak voltage $\pm 450\text{V}$, is enabled at nominal voltages of mains with the range of 64V...127V and at the configurations with voltage transducers, the range is also always selected for channel U_{N-PE} ,
- high-voltage range, with peak voltage $\pm 1500\text{V}$, is enabled at nominal voltages of mains from 220V and more (without voltage transducers).

Using two voltage ranges enables the user to maintain the declared measurement accuracy, according to class A of IEC 61000-4-30 standard for all nominal voltages.

3.2 Current inputs

The analyzer has four independent current inputs with identical parameters. Each input may be used for connecting CT current probes with voltage output in standard 1 V, or several types of flexible (Rogowski) probes.

A typical situation is the use of flexible probes with built-in electronic integrator. However the described analyzer allows user to directly connect Rogowski coil to the current channel and the signal integration is performed digitally.

3.3 Digital integrator

The analyzer uses a solution of digital integration of signal provided directly from the Rogowski coil. This approach allowed us to eliminate problems related to analog integrators and the need to ensure declared accuracy for long periods and in difficult measurement environment. Analog integrators must also include protection systems to prevent output saturation when constant voltage is present at the input.

The ideal integrator has infinite gain for DC signals which descends at a rate of 20 dB/frequency decade. The phase shift is constant over the entire frequency range and is equal to 90° .

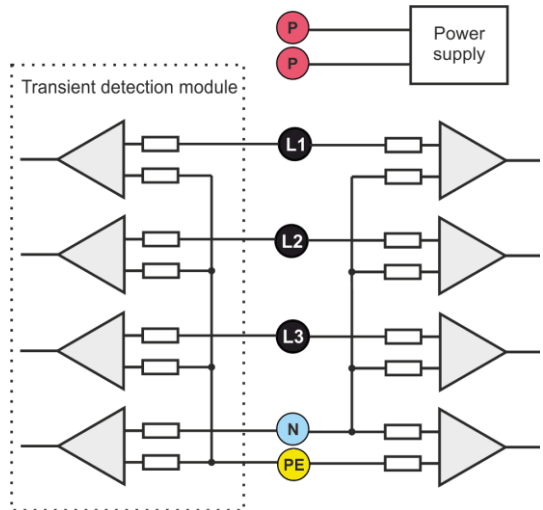

Fig. 40. Voltage inputs (with transient module) and AC adapter

Theoretically infinite gain for DC signal, when present at integrator input, causes the input saturation close to the supply voltage and prevents its further work. In practical systems, a solution is introduced to limit the gain for DC signals to some fixed value. Additionally, periodic reset of the output is performed. There are also techniques for active cancellation of DC voltage, based on its measuring and feeding it back to the input, but with the opposite sign, effectively cancelling it. In such case professionals use term "*leaky integrator*". Analog "*leaky integrator*" is simply an integrator with shunted capacitor (by resistor with high resistance). Such a system operates in the same manner as a low-pass filter with a very low cut-off frequency.

Digital implementation of the integrator ensures excellent long-term parameters - the whole procedure is performed by computing, there is no issue of component ageing, drifts etc. However, similarly to the analog version, the saturation problem may also occur and without adequate prevention it may cause the failure of digital integration. Please note that input amplifiers and analog-to-digital converters have some limited and undesirable offset, which must be removed before the integration process. The analyzer software includes a digital filter whose task is to completely remove the DC component. The filtered signal is subject to digital integration. The resulting phase characteristics are excellent and the phase shift for the most critical frequencies (50 Hz and 60 Hz) is minimal.

Ensuring the smallest phase shift between current and voltage signals is extremely important to achieve small power measurement errors. It can be shown that approximate power measurement error may be expressed in relation¹:

$$\text{Power measurement error} \approx \text{phase error (in radians)} \times \tan(\varphi) \times 100\%$$

where $\tan(\varphi)$ is the tangent of the angle between the current and its voltage fundamental components. The above formula indicates that measurement errors increase with decreasing displacement power factor, e.g. with the phase error of 0.1° and $\cos\varphi=0.5$ the error is 0.3%. Anyway, to ensure accurate power measurements, the phase coincidence of voltage and current circuits must be the highest.

3.4 Signal sampling

The signal is sampled simultaneously in all eight channels with a frequency synchronized with the frequency of power supply voltage in the reference channel. This frequency is 10.24 kHz for 50 Hz and 60 Hz.

Thus, the single period contains 204.8 samples for 50 Hz and 170.67 for 60 Hz. 16-bit analog-to-digital converter was used to ensure 64-times oversampling.

3-decibel analog attenuation has been specified for frequency approx. 20 kHz, and the amplitude error for the maximum usable frequency 3 kHz (i.e. the frequency of the 50th harmonic for 60 Hz network) is approximately 0.1 dB. The phase shift for the same frequency is less than 15° . Attenuation in the stop band is above 75 dB.

It should be noted that for the correct measurement of phase shift between the voltage harmonics in relation to current harmonics and power of these harmonics, the important factor is not absolute phase shift in relation to the basic frequency, but the phase coincidence of voltage and current circuits. Maximum phase difference error is $f = 3$ kHz, max. 15° . This error decreases with the decreasing frequency. When estimating measurement errors in power harmonics, also take into account additional error introduced by the probes and transformers.

3.5 PLL synchronization

The synchronization of sampling frequency is implemented by hardware or mixed hardware/software. After passing through the input circuits, the voltage signal is sent to a band-pass filter which is to reduce the harmonics level and pass only the voltage fundamental component. Then, the signal is routed to the Phase Locked Loop circuit as a reference signal. PLL circuit generates a frequency which is a multiple of the reference frequency required to clock the ADC.

The need for the phase-locked loop results directly from the requirements of IEC 61000-4-7

standard, which describes the methodology and acceptable errors when measuring harmonics. This standard requires that the measuring window (which is the basis for a single measurement and evaluation of the harmonics) is equal to the duration of 10 mains cycles for 50 Hz systems and 12 cycles for 60 Hz systems. In both cases, it corresponds to approx. 200 ms. Since the frequency of the mains may be subject to periodic changes and fluctuations, the duration of the window may not be exactly 200 ms, and for example for frequency 51 Hz it will be approx. 196 ms.

The standard also prescribes that before applying the Fourier formula (in order to extract the spectral components) data should not be subject to windowing. No frequency synchronization and a situation where FFT is performed on the samples not covering integer number of cycles, may lead to spectral leakage. This would cause blurring of the harmonic line over a few adjacent interharmonic bands, which may lead to loss of information about the actual level and power of the tested line. It is allowed to apply Hann weighting window, which reduces the adverse effects of spectral leakage, but this is limited only to situations when PLL loses synchronization.

IEC 61000-4-7 specifies also the required accuracy of the synchronization block. This is expressed as follows: the time between the rising edge of the first sampling pulse and (M+1)-th pulse (where M is the number of samples within the measuring window) should be equal to the duration of specified number of periods in the measuring window (10 or 12) with a maximum allowable error of $\pm 0.03\%$. To explain it in a simpler way, consider the following example. Assuming network frequency of 50 Hz, the measuring window lasts exactly 200 ms. If the first sampling pulse occurs exactly at time $t=0$, then the first sampling pulse of the next measurement window should occur at $t=200 \pm 0.06$ ms. This ± 60 μ s is the permissible deviation of the sampling edge. The standard also defines the recommended minimum frequency range at which the above-stated accuracy of the synchronization should be maintained and defines it as $\pm 5\%$ of nominal frequency, i.e. 47.5...52.5 Hz for 50 Hz and 57...63 Hz for 60 Hz .

Another issue is the input voltage range for which PLL will work properly. For this issue, 61000-4-7 standard does not provide any specific guidance or requirements. However, 61000-4-30 standard defines the input voltage range in which the metrological parameters cannot be compromised and for class A the range is: $10\% \dots 150\% U_{\text{din}}$. The analyzer meets the requirements listed above relating to the operation of PLL, for the rated voltage $U_{\text{nom}} \geq 64$ V, i.e. approx. 6 V.

3.6 Frequency measurement

The signal for measuring 10-second frequency values of the network, is taken from reference voltage channel (L1/A or L2/B or L3/C depending on availability). This is the same signal that is used to synchronize the PLL. The reference signal is sent to a 2nd order band-pass filter, for which the passband was set at range of 40...70 Hz. This filter is designed for reducing the level of harmonics. Then, a square signal is formed from the filtered waveform. The signal cycles number and their duration are counted during the 10-second measuring cycle. 10-second time intervals are determined by the real time clock (every full multiple of 10-second time). The frequency is calculated as the ratio of the number of cycles counted and their duration.

3.7 The method for measuring harmonics

Harmonics measurement is carried out according to IEC 61000-4-7. It defines the method for calculating individual harmonics.

The whole process consists of several steps:

- synchronous sampling (10/12 periods),
- FFT (Fast Fourier Transform),
- grouping.

FFT analysis for the test window of 10/12 period (approx. 200 ms). As a result of FFT, we receive a set of spectral lines from 0 Hz (DC) to the 50-th harmonics (approx. 2.5 kHz for 50 Hz or 3 kHz for 60 Hz). The distance between successive lines directly results from the duration of the measurement window and is approximately 5 Hz.

The analyzer collects 2048 samples per measurement window (for 50 Hz and 60 Hz), thus it fulfills the requirement for FFT stating that the number of samples subject to transformation equals

a power of 2.

It is essential to maintain a constant synchronization of the sampling frequency with the mains. FFT may be performed only on the data containing an integer multiple of the network period. This condition must be met in order to minimize the so-called spectral leakage, which leads to falsifying information about the actual levels of spectral lines. The analyzer meets these requirements, as the sampling frequency is stabilized by the phase locked loop (PLL).

Because the sampling frequency may fluctuate over time, the standard provides for grouping the main spectral lines of harmonics with the spectral lines located in their direct vicinity. The reason is that the energy of components may partially pass into adjacent interharmonics components. Two methods of grouping are provided:

- harmonic group (includes the main line and five or six adjacent interharmonic components),
- harmonic subgroup (includes the main line and one of each adjacent lines).

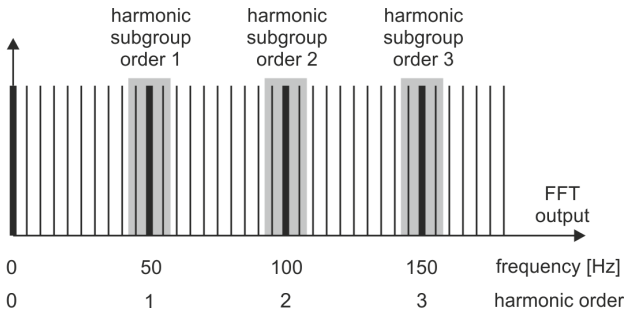

Fig. 41. Determining harmonics subgroups (50 Hz system)

Example

In order to calculate the 3rd harmonic component in 50 Hz system, use 150 Hz main spectral line and adjacent lines 145 Hz and 155 Hz. The resulting amplitude is calculated using RMS method.

3.8 The method for measuring interharmonics

Interharmonics measurement is carried out according to IEC 61000-4-7 and IEC 61000-4-30.

They provide a method of calculating the individual components of interharmonics in power quality analyzers.

The whole process, similarly as in case of harmonics, consists of several steps:

- synchronous sampling (10/12 periods),
- FFT (Fast Fourier Transform),
- grouping.

FFT analysis for the test window of 10/12 period (approx. 200 ms). As a result, we obtain a set of spectral lines from 0 Hz (DC). The distance between successive lines results from the duration of the measurement window and is approximately 5 Hz.

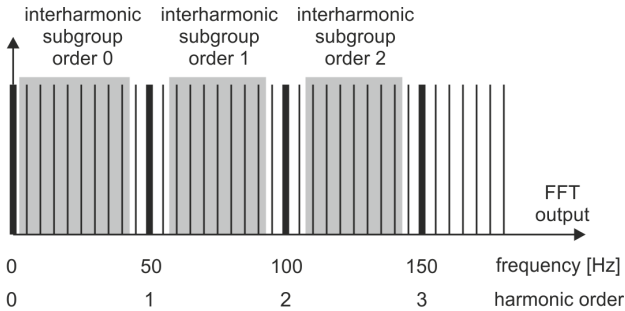

Fig. 42. Determining interharmonics subgroups (50 Hz system)

Each interharmonic subgroup is the sum of RMS for seven (for 50 Hz mains) or nine (for 60 Hz mains) spectral lines obtained by Fourier transform. The exception is zero subgroup, i.e. sub-harmonic subgroup that contains one line more - 5Hz. It is presented in Fig. 42 with an example of 50 Hz network. Interharmonic subgroup of 0 order, i.e. subharmonic, consists of eight lines with frequencies from 5 Hz to 40 Hz. Each following interharmonic subgroup consists of seven lines located between harmonic subgroups, e.g. subgroup of 1st order includes spectral lines of frequencies from 60 Hz to 90 Hz. In case of subharmonic subgroup, the range of spectral lines was extended by 5 Hz line, otherwise the energy in this lowest frequency band would not be included and would be lost. All subsequent spectral lines are included either in the harmonic subgroup or inter-harmonic subgroup.

Similarly as in case of the harmonics, interharmonics are calculated at least to 50th order; for mains frequency of 50 Hz it gives a range of slightly above 2.5 kHz, and for 60 Hz, a range of slightly above 3 kHz.

3.9 Measurement of ripple control signals

The analyzer allows user to monitor two user-defined frequencies in the range up to 3000 Hz. After exceeding the threshold limit defined by the user, the analyzer records the signal level for a specified period of time (up to 120 seconds). As a standard, the analyzer measures the average values of signals for the time interval selected in settings (the main averaging period). When recording acc. to EN 50160 is selected, then additionally all 3-second average values are recorded for both frequencies - they are compared with limits specified in the standard (when the report is prepared).

3.10 Measurement of transients PQM-703 PQM-711

The option for measuring transients is available only for PQM-703 and PQM-711.

Analog-to-digital converters, typically used in power quality analyzers, have relatively low sampling frequency and are insufficient to provide required accuracy of transient recording due to the short-term nature of these disturbances and their wide frequency spectrum. For this reason, PQM-703 and PQM-711 analyzers are using a separate 4-channel A/D converter with a maximum sampling frequency of 10 MHz. This corresponds to the time between individual samples of 100 ns. In this mode it is possible to record the fastest transients, and the recording time reaches 2 ms.

Tab. 4. Summary of transient measurement modes in PQM-703 and PQM-711.

Sampling frequency	Rise time with dV/dt method	Recording time range (2000...20000 samples)
10 MHz	100 V/5 μ s	0.2...2 ms
5 MHz	100 V/10 μ s	0.4...4 ms
1 MHz	100 V/50 μ s	2...20 ms
500 kHz	100 V/100 μ s	4...40 ms
100 kHz	100 V/500 μ s	20...200 ms

To configure the transients measurement, a few options are provided for the user:

- main sampling frequency of A/D converter in the range from 100 kHz to 10 MHz,
- detection method: threshold detection - based on the set minimum transient amplitude (from 50 V to 5000 V) or a minimum slew rate (dV/dt method),
- switching recording on/off of the transient waveforms,
- recording time for timeplot in the range from 2,000 to 20,000 samples,
- pretrigger time is within the range of 10% to 90% of the recording time.

The analyzer records the timeplot of transient only in channels where events meet the criteria set by the user. After detecting a transient, the analyzer is insensitive to subsequent transients for 3 seconds. A special case is when the transient is detected only in one channel and in the time between its detection and ending of the recording process, subsequent transients occur in other channels. In this particular situation, the analyzer will record waveforms of all channels where transient events were detected. Since transients detected slightly later than the transient in the first channel, will not have exactly the same pretrigger time (recording of these channels will end up at the same time as the recording in the first channel triggered by the first event), "Sonel Analysis" software marks these events as "Transient *". Waveforms for the channel that triggered the first event, they will always appear with the other channels that triggered later event. Similarly, the opening of the graph of a later waveform (secondary transient) will also display other channels, where the disturbance occurred within the same time period. In this way, you can easily analyze the time dependence between channels.

In the event table for transients the following parameters are specified:

- **EXTREME** column includes maximum measured transient amplitude (peak-to-peak),
- **DURATION** column presents an approximate duration of the disturbance.

Measuring lines are referenced to PE input (see also Fig. 38). Transient module monitors the voltage between the inputs:

- L1/A-PE,
- L2/B-PE,
- L3/C-PE,
- N-PE.

Note

For proper measurement of transients, it is necessary to connect PE input of the analyzer to the local earthing system. It is also required for 3-wire delta and wye systems without neutral conductor.

3.10.1 Threshold method

Threshold method is chosen by selecting **THRESHOLD** (in voltage settings of the measurement point) and setting the threshold voltage in the range from 50 V to 5000 V. In this method, the analyzer detects a transient after it exceeds the pre-set amplitude in volts. Transients, whose amplitude does not exceed the set threshold will not be detected by the analyzer. In this mode, the waveform rise time is not taken into account. Both slow and fast transients will be detected, when the amplitude criterion is met.

NOTE: Threshold value entered is a transient amplitude, not the absolute voltage referred to the PE earth voltage level.

Fig. 43 shows two examples of transients and their amplitudes U_{T1} and U_{T2} . In the threshold method, the analyzer detects an event if U_{T1} or U_{T2} is greater than the threshold set by the user.

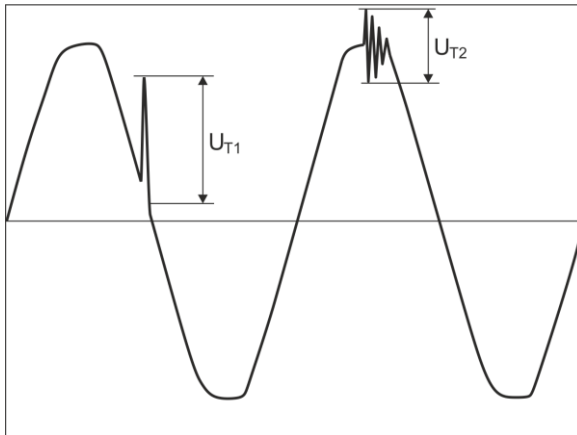

Fig. 43. Method of determining the amplitudes of transients.

3.10.2 Slew rate (dV/dt) method

Slew rate method (dV/dt) is activated by selecting **SLEW RATE** and indicating an appropriate sampling rate, which indirectly selects the voltage slew rate from several available values (see Tab. 4). In dV/dt method the device analyses the voltage waveforms in a specific time window and detects transient, if the slew rate in the window exceeds the value set by the user in settings. The absolute amplitude of the transient is not important - both transients of small and large amplitude will be detected, provided that the minimum rise requirement is met.

3.11 Current limiting function

In situations where the measured current has very low values or measuring probes were removed from the analyzer, resetting function may be useful for parameters related with the current channel. This is particularly important for parameters such as THD, which in case of noise indicate high and sometimes confusing values. When current probes are disconnected during event detection, then the analyzer almost instantly detect exceeding the threshold, which may mislead the user. To avoid such situations, limiting function is introduced for current parameters, when RMS value of the measured current is below the threshold specified by the user. To enable this function check box **CURRENT LIMIT**, located in the main settings of the measurement point, under the list of probe types. When the option is enabled, the user may specify the limit threshold as the percentage of the nominal range of selected probes, (0.00 to 0.50% of I_{nom}).

Checking whether the current value is below the specified threshold, is carried out every 10/12-period window (approx. every 200 ms). If the RMS value of the measured current in the channel is lower than the specified threshold, then the following parameters are zeroed:

3 Design and measurement methods

- RMS current,
- current direct component (DC),
- current crest factor,
- current harmonics/interharmonics amplitudes,
- current THD and TID,
- all power values in a given channel,
- power factor and $\cos\varphi$,
- the angles between voltage and current harmonics,
- harmonics active and reactive power
- $\tan\varphi$ and K-factor.

Total values of the system are zeroed only if all current channels are below the reset threshold. Then, the following values are also reset:

- current unbalance factors and current symmetrical components.

The energy counters are frozen when the corresponding power is in “zeroed” state.

For events, some parameters are managed in a way that takes zeroing into account. The parameter value is taken into account (when detecting start and end of the event and calculating extreme and average values) only when the current value is above the threshold. Parameters managed in this way include:

- current crest factor,
- current THD and TID,
- power factor and $\cos\varphi$,
- $\tan\varphi$ and K-factor,
- current unbalance.

Zeroing is highlighted in live mode and in analysis. In order to distinguish between the actual measured value from zeroed value of reset parameter, the following rules apply:

- in live mode, the zeroed values are marked with * symbol (asterisk) next to a value (e.g. 0.000 *).
- in the data analysis, the heading of a parameter that can be zeroed is marked by adding * symbol, e.g. "I * L1 [A]" (single cells are not selected but only the header to indicate that the limiting function was applied).
- the display of the analyzer shows the zeroed values in grey.

3.12 Event detection

The analyzer offers wide range of event detection options for measured networks. "Event" is a situation where the parameter value exceeds the threshold defined by the user. Detected events are recorded on a memory card as an entry containing:

- parameter type,
- channel, in which the event occurred,
- start and end time of the event,
- the threshold value set by the user,
- parameter extreme value measured during the event,
- parameter average value measured during the event.

Depending on the parameter type, you can set one, two or three thresholds which will be checked by the analyzer. Tab. 5 lists all parameters for which the events can be detected, including specification of threshold types. The "Waveform and RMS1/2" column indicates those events which has the option to enable recording of waveforms and RMS_{1/2} charts.

Tab. 5. Types of event thresholds for each parameter.

Parameter	Inter- ruption	Dip	Swell	Mini- mum	Maxi- mum	Waveform and RMS1/2
U	•	•	•		• ⁽¹⁾	•
U _{waveshape}					•	•
U _{phase_jump}					•	•
RVC					•	•
U _{DC}					•	
F				•	•	
CF U				•	•	
u ₂					•	
P _{st}					•	
P _{It}					•	
I				•	•	•
I _{DC}					• ⁽²⁾	
CF I				•	•	
i ₂					•	
P				•	•	
Q ₁ , Q _B				•	•	
S				•	•	
D, S _N				•	•	
PF				•	•	
cosφ				•	•	
tanφ				•	•	
E _{P+} , E _{P-}					•	
E _Q					•	
E _S					•	
THD _F U					•	
U _{h2..U_{h50}}					•	
THD _F I					•	

3 Design and measurement methods

$I_{h2}..I_{h50}$	Current harmonic amplitudes ($n = 2...50$)					•	
TID _F U	voltage TID _F					•	
$U_{ih0}..U_{ih50}$	Voltage interharmonics amplitudes ($n = 0...50$)					•	
TID _F I	current TID _F					•	
$I_{ih0}..I_{ih50}$	Current interharmonics amplitudes ($n = 0...50$)					•	
K	K-Factor					•	
UR ₁ , UR ₂	Mains signalling					•	
PQM-703 PQM-711 U _t	Voltage transients					•	• ⁽³⁾

⁽¹⁾ applies to U_{N-PE} voltage.

⁽²⁾ with C-5A probes only.

⁽³⁾ recording of transient chart and waveform, no RMS_{1/2} chart.

Some of the parameters may have values that are positive or negative (+/-). For example: active power, reactive power and power factor. Since the event detection threshold may only be a positive value and to ensure proper detection for these parameters, the analyzer compares absolute values of these parameters with the set threshold.

Example

Threshold for detecting active power events was set at 10 kW. If the load has a generator nature, the active power with correct connection of probes will be a negative value. If the measured absolute value exceeds the threshold, i.e. 10 kW (e.g. -11 kW) an event will be recorded for exceeded maximum active power.

Two types of parameters: RMS voltage and RMS current may generate events, for which the user may also record waveforms.

The analyzer records the waveforms of active channels (voltage and current) at the event start and end. The user may set recording time for waveforms (from 100 ms to 1s) and the pretrigger time (from 40 ms to 960 ms). Waveforms are saved in 8-bit format with sampling frequency of 10.24 kHz.

Information about the event is recorded when the event ends. In some cases, it may happen that event is active when the recording is stopped (e.g. during a voltage dip). Information about such event is also recorded, but with the following changes:

- there is no end-time of the event,
- extreme value is calculated only for the period until the recording is stopped,
- the average value is not reported,
- only the beginning waveform is available for RMS voltage or current related events.

To eliminate repeated event detection, when the value of the parameter oscillates around the threshold value, the analyzer has a function of user-defined event detection hysteresis. It is defined as a percentage value in the following manner:

- for RMS voltage events, it is the percent of the nominal voltage range (e.g. 2% of 230 V, which is 4.6 V),

- for RMS current events, it is the percent of the nominal current range (e.g. for C-4 probes and in absence of current transducers, 2% hysteresis is $0.02 \times 1000 \text{ A} = 20 \text{ A}$,
- for events related to DC voltage and U_{N-PE} voltage, the hysteresis is calculated as a percentage of the threshold value, but not less than 50 mV (referred to input).
- for remaining parameters, the hysteresis is specified as a percent of maximum threshold (e.g. when maximum threshold for current crest factor has been set to 4.0 the hysteresis is $0.02 \times 4.0 = 0.08$).

3.12.1 Waveshape variation events

Firmware version 1.25 and later provides a new method for detecting abnormalities in the shape of the voltage waveform: waveshape variation events.

This method compares two adjacent periods of the voltage waveform and the difference between them is calculated and their maximum amplitude is checked - these values are then compared with the threshold set by the user. The percentage value of the threshold refers to the nominal voltage. If the calculated change in the amplitude exceeds the threshold, the waveshape event is triggered. This event is considered completed when for at least three consecutive waveform periods no detected exceedance of the tolerance threshold is detected.

The principle of the algorithm may be explained using Fig. 44. Each period of the voltage waveform has assigned range of permissible changes (shown as bright red area), having a width (in volts) of $2U_{TH}$, which is formed on the basis of the voltage waveform in the previous period. U_{TH} is the detection threshold for events, which is set by user in the measurement configuration. If the instantaneous voltage exceeds the limits set for this area, then the event is detected. ΔU represents the difference in the values of voltage samples of the two adjacent periods.

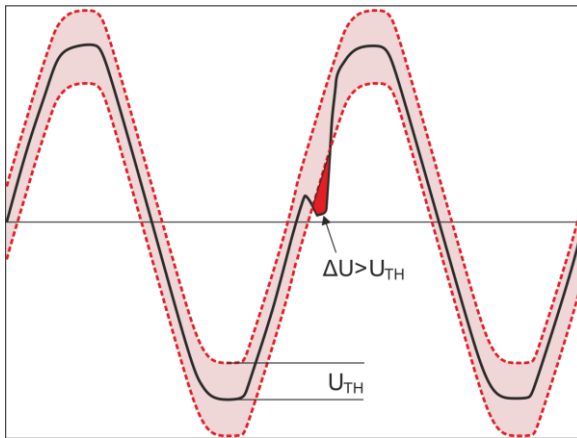

Fig. 44. Detecting waveshape variation events.

This functionality is very helpful in detecting any non-stationary disturbances in the supply network. Keep in mind that at low detection threshold, the analyzer may detect a very large number of events in a short period of time. Therefore, **HOLD TIME** parameter (expressed in seconds) is provided. After detecting an event, the analyzer blocks the detection of next events (in a given channel) for the time specified by this parameter. It may be set in the range of 1 s to 600 s.

Note

Analyzers with hardware version older than HWg, have the minimum built-in hold time of 2 seconds for waveshape variation and phase jump events (for all voltage channels) and it cannot be reduced. The hold time can be increased further in the measurement configuration if needed.

3.12.2 Phase jump events

The analyzer can detect changes in the voltage fundamental phase angle. This functionality is available for firmware version 1.25 upwards.

The detection algorithm compares the angles of the fundamental voltage component of two or three adjacent periods. If the angle difference is greater than the threshold set by the user (expressed in angle degrees), then the information is recorded on detecting the event, along with the measured value of the phase jump. Phase jumps are usually accompany voltage dips - change in the load impedance in relation to the impedance of the power supply network causes the change of observed angle of fundamental voltage.

Example of phase jump is shown in Fig. 45. Information about the detected event includes the time of its occurrence and designated phase jump value, expressed in angle degrees (angle φ shown in the figure). It is also possible to save waveform and graph of $RMS_{1/2}$ values. The lowest value of the detected phase jump is 1 angle degree.

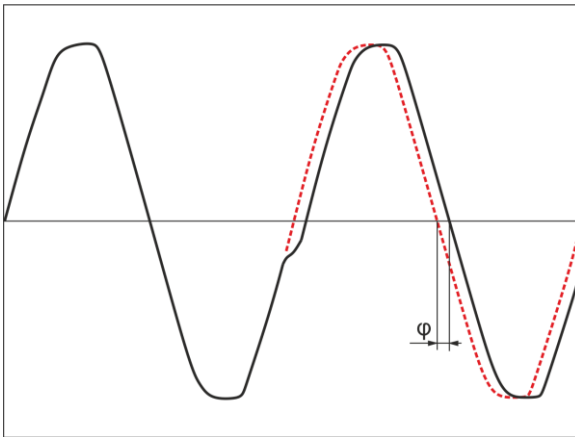

Fig. 45. Phase jump.

3.12.3 Rapid Voltage Changes (RVC) events

Rapid Voltage Changes (RVC) are described in sec. 5.9. The analyzer can detect and record such events, only when you turn on the appropriate option in the measurement configuration. The user sets the following parameters:

- **THRESHOLD** - expressed as a percentage of the nominal voltage, setting the detection sensitivity; the smaller the threshold value, the greater sensitivity and more events of this type will be detected. A typical threshold value is 5% of U_{NOM} . Entered threshold value refers to the value ΔU_{MAX} of RVC events.
- **HYSTERESIS** is also expressed as a percentage of the nominal voltage. It must be lower than the threshold. When the hysteresis is closer to the threshold, then the range of voltage changes is narrower, which is required to state that the voltage value is stable again, (see also Fig. 55). Typically, the hysteresis value is set as half of the threshold.

- If the user wants to record oscillographic waveforms and $RMS_{1/2}$ graphs for voltage and currents together with RVC events, then it may be done after selecting option **LOG WAVEFORMS AND RMS 1/2**. Saved waveforms relate only to the beginning of the RVC event.

In polyphase systems, the device detects both single-phase events and polyphase events (in accordance with IEC 61000-4-30). *Sonef Analysis* software indicates polyphase events by a yellow background in the event table. It should be noted that according to the algorithm specified in IEC 61000-4-30, a polyphase event is also an event which occurred only in one phase ("polyphase" is viewed here as a "systemic" phenomenon and not as a requirement to occur in many phases simultaneously).

In the case of recording for compliance with the selected standard, which also includes the RVC measurement, RVC parameters are taken from the default settings of the selected standard.

3.13 Methods of parameter's averaging

Method of parameter averaging	
Parameter	Averaging method
RMS voltage, RMS current	RMS
DC voltage, DC current	arithmetic average
Frequency	arithmetic average
Crest factor U, I	arithmetic average
Symmetrical components U, I	RMS
Unbalance factor U, I	calculated from average values of symmetrical components
Active, Reactive, Apparent and Distortion Power	arithmetic average
Power Factor PF	calculated from the averaged power values
$\cos\phi$	arithmetic average
$\tan\phi$	calculated as the ratio of the reactive energy delta (in the related quadrant) to the active energy delta.
THD U, I	calculated as the ratio of the RMS value of the higher order harmonics to the RMS value of the fundamental component (for THD-F), or the ratio of the RMS value of higher order harmonics to the total RMS voltage (for THD-R)
TID U, I	calculated as the ratio of the RMS value of interharmonics to the RMS value of the fundamental component (for TID-F), or the ratio of the RMS value of interharmonics to the total RMS voltage (for TID-R)
Harmonic amplitudes U, I	RMS
Interharmonic amplitudes U, I	RMS
K-factor	RMS
The angles between voltage and current harmonics	arithmetic average (Cartesian method)
Active and reactive power of harmonics	arithmetic average

Note:

RMS average value is calculated according to the formula:

$$RMS = \sqrt{\frac{1}{N} \sum_{i=1}^N x_i^2}$$

The arithmetic average (AVG) is calculated according to the formula:

$$AVG = \frac{1}{N} \sum_{i=1}^N x_{i\text{and}}$$

where:

- X_i is subsequent parameter value to be averaged,
- N is the number of values to be averaged.

4 Calculation formulas

4.1 One-phase network

One-phase network			
Parameter			Method of calculation
Name	Designation	Unit	
Voltage (True RMS)	U_A	V	$U_A = \sqrt{\frac{1}{M} \sum_{i=1}^M U_i^2}$ where U_i is a subsequent sample of voltage U_{A-N} $M = 2048$ for 50 Hz and 60 Hz
DC Voltage	U_{ADC}	V	$U_{ADC} = \frac{1}{M} \sum_{i=1}^M U_i$ where U_i is a subsequent sample of voltage U_{A-N} $M = 2048$ for 50 Hz and 60 Hz
Frequency	F	Hz	number of all voltage periods U_{A-N} counted during 10-sec period (clock time) divided by the total duration of full periods
Current (True RMS)	I_A	A	$I_A = \sqrt{\frac{1}{M} \sum_{i=1}^M I_i^2}$ where I_i is a subsequent sample of current I_A $M = 2048$ for 50 Hz and 60 Hz
DC Current	I_{ADC}	A	$I_{ADC} = \frac{1}{M} \sum_{i=1}^M I_i$ where I_i is a subsequent sample of current I_A $M = 2048$ for 50 Hz and 60 Hz
Active power	P	W	$P = \frac{1}{M} \sum_{i=1}^M U_i I_i$ where U_i is a subsequent sample of voltage U_{A-N} I_i is a subsequent sample of current I_A $M = 2048$ for 50 Hz and 60 Hz
Budeanu reactive power	Q_B	var	$Q_B = \sum_{h=1}^{50} U_h I_h \sin \varphi_h$ where U_h is the h -th harmonic of voltage U_{A-N} I_h is the h -th harmonic of current I_A φ_h is the h -th angle between harmonic U_h and I_h
Reactive power of fundamental component	Q_1	var	$Q_1 = U_1 I_1 \sin \varphi_1$ where U_1 is fundamental component of voltage U_{A-N} I_1 is fundamental component of current I_A φ_1 is angle between fundamental components U_1 and I_1
Apparent power	S	VA	$S = U_{ARMS} I_{ARMS}$
Apparent distortion power	S_N	VA	$S_N = \sqrt{S^2 - (U_1 I_1)^2}$ where U_1 is fundamental component of voltage U_{A-N} I_1 is fundamental component of current I_A
Budeanu distortion power	D_B	var	$D_B = \sqrt{S^2 - P^2 - Q_B^2}$
Power Factor	PF	-	$PF = \frac{P}{S}$ If $PF < 0$, then the load is of a generator type If $PF > 0$, then the load is of a receiver type

Displacement power factor	$\cos\varphi$ DPF	-	$\cos\varphi = DPF = \cos(\varphi_{U_1} - \varphi_{I_1})$ where φ_{U_1} is an absolute angle of the fundamental component of voltage U_{A-N} φ_{I_1} is an absolute angle of the fundamental component of current I_A
Tangent φ (4-quadrant)	$\tan\varphi_{(L+)}$	-	$\tan\varphi_{(L+)} = \frac{\Delta E_{Q(L+)}}{\Delta E_{P+}}$ where: $\Delta E_{Q(L+)}$ is the increase in reactive energy $E_{Q(L+)}$ (Budeanu/IEEE-1459) in a given averaging period, ΔE_{P+} is the increase in active power taken E_{P+} in a given averaging period
	$\tan\varphi_{(C-)}$	-	$\tan\varphi_{(C-)} = -\frac{\Delta E_{Q(C-)}}{\Delta E_{P+}}$ where: $\Delta E_{Q(C-)}$ is the increase in reactive energy $E_{Q(C-)}$ (Budeanu/IEEE-1459) in a given averaging period, ΔE_{P+} is the increase in active power taken E_{P+} in a given averaging period
	$\tan\varphi_{(L-)}$	-	$\tan\varphi_{(L-)} = \frac{\Delta E_{Q(L-)}}{\Delta E_{P+}}$ where: $\Delta E_{Q(L-)}$ is the increase in reactive energy $E_{Q(L-)}$ (Budeanu/IEEE-1459) in a given averaging period, ΔE_{P+} is the increase in active power taken E_{P+} in a given averaging period
	$\tan\varphi_{(C+)}$	-	$\tan\varphi_{(C+)} = -\frac{\Delta E_{Q(C+)}}{\Delta E_{P+}}$ where: $\Delta E_{Q(C+)}$ is the increase in reactive energy $E_{Q(C+)}$ (Budeanu/IEEE-1459) in a given averaging period, ΔE_{P+} is the increase in active power taken E_{P+} in a given averaging period
Harmonic components of voltage and current	U_{hx} I_{hx}	V A	method of harmonic subgroups according to IEC 61000-4-7 x (harmonic order) = 1..50
Total Harmonic Distortion for voltage, referred to the fundamental component	$THDU_F$	-	$THDU_F = \sqrt{\frac{\sum_{h=2}^{50} U_h^2}{U_1^2}} \times 100\%$ where U_h is the h -th harmonic of voltage U_{A-N} U_1 is fundamental component of voltage U_{A-N}
Total Harmonic Distortion for voltage, referred to RMS	$THDU_R$	-	$THDU_R = \frac{\sqrt{\sum_{h=2}^{50} U_h^2}}{U_{ARMS}} \times 100\%$ where U_h is the h -th harmonic of voltage U_{A-N}
Total Harmonic Distortion for current, referred to the fundamental component	$THDI_F$	-	$THDI_F = \frac{\sqrt{\sum_{h=2}^{50} I_h^2}}{I_1} \times 100\%$ where I_h is the h -th harmonic of current I_A I_1 is fundamental component of current I_A
Total Harmonic Distortion for current, referred to RMS	$THDI_R$	-	$THDI_R = \frac{\sqrt{\sum_{h=2}^{50} I_h^2}}{I_{ARMS}} \times 100\%$ where I_h is the h -th harmonic of current I_A
Total Demand Distortion	TDD	%	$TDD = \frac{\sqrt{\sum_{h=2}^{50} I_h^2}}{I_L} \times 100\%$ where I_h is the h -th harmonic of current I_A I_L is the demand current (in auto-mode I_L maximum average fundamental current from all measured current channels and whole recording period)
Interharmonic compo-	U_{hx} I_{hx}	V A	method of interharmonic subgroups acc. to IEC 61000-4-7

4 Calculation formulas

nents of voltage and current			x (interharmonic order) = 0..50 (sub-harmonic also includes the 5 Hz bin)
Total Interharmonic Distortion for voltage, referred to the fundamental component	$TIDU_F$	-	$TIDU_F = \frac{\sqrt{\sum_{ih=0}^{50} U_{ih}^2}}{U_1} \times 100\%$ <p>where U_{ih} is the ih-th interharmonic of voltage U_{A-N} U_1 is fundamental component of voltage U_{A-N}</p>
Total Interharmonic Distortion for voltage, referred to RMS	$TIDU_R$	-	$TIDU_R = \frac{\sqrt{\sum_{ih=0}^{50} U_{ih}^2}}{U_{ARMS}} \times 100\%$ <p>where U_{ih} is the ih-th interharmonic of voltage U_{A-N}</p>
Total Interharmonic Distortion for current, referred to the fundamental component	$TIDI_F$	-	$TIDI_F = \frac{\sqrt{\sum_{ih=0}^{50} I_{ih}^2}}{I_1} \times 100\%$ <p>where I_{ih} is ih-th interharmonic of current I_A I_1 is fundamental component of current I_A</p>
Total Interharmonic Distortion for current, referred to RMS	$TIDIR$	-	$TIDIR = \frac{\sqrt{\sum_{ih=0}^{50} I_{ih}^2}}{I_{ARMS}} \times 100\%$ <p>where I_{ih} is ih-th interharmonic of current I_A</p>
Voltage crest factor	CFU	-	$CFU = \frac{\max U_i }{U_{ARMS}}$ <p>where the operator $\max U_i$ expresses the highest absolute value of voltage U_{A-N} samples $i = 2048$ for 50 Hz and 60 Hz</p>
Current crest factor	CFI	-	$CFI = \frac{\max I_i }{I_{ARMS}}$ <p>where the operator $\max I_i$ expresses the highest absolute value of current I_A samples $i = 2048$ for 50 Hz and 60 Hz</p>
K-Factor	$K\text{-Factor}$	-	$K\text{Factor} = \frac{\sum_{h=1}^{50} I_h^2 h^2}{I_1^2}$ <p>where I_h is the h-th harmonic of current I_A I_1 is fundamental component of current I_A</p>
Harmonic active power	P_h $h=1..50$	W	$P_h = U_h I_h \cos \varphi_h$ <p>where U_h is the h-th harmonic of voltage U_{A-N} I_h is the h-th harmonic of current I_A φ_h is the angle between harmonics U_h and I_h</p>
Harmonic reactive power	Q_h $h=1..50$	var	$Q_h = U_h I_h \sin \varphi_h$ <p>where U_h is the h-th harmonic of voltage U_{A-N} I_h is the h-th harmonic of current I_A φ_h is the angle between harmonics U_h and I_h</p>
Short-term flicker	P_{st}	-	calculated according to IEC 61000-4-15
Long-term flicker	P_{lt}	-	$P_{LT} = \sqrt[3]{\frac{\sum_{i=1}^N P_{STi}^3}{N}}$ <p>where P_{STi} is subsequent i-th indicator of short-term flicker</p>

<p>Active energy (consumed and supplied)</p>	<p>E_{P+} E_{P-}</p>	<p>Wh</p>	$E_{P+} = \sum_{i=1}^M P_+(i)T(i)$ $P_+(i) = \begin{cases} P(i) & \text{for } P(\text{and}) > 0 \\ 0 & \text{for } P(i) \leq 0 \end{cases}$ $E_{P-} = \sum_{i=1}^M P_-(i)T(i)$ $P_-(i) = \begin{cases} P(i) & \text{for } P(\text{and}) < 0 \\ 0 & \text{for } P(i) \geq 0 \end{cases}$ <p>where: <i>i</i> is subsequent number of the 10/12-period measurement window <i>P(i)</i> represents active power <i>P</i> calculated in <i>i</i>-th measuring window <i>T(i)</i> represents duration of <i>i</i>-th measuring window (in hours)</p>
<p>Reactive energy (4-quadrant)</p>	<p>$E_{Q(L+)}$ $E_{Q(C-)}$ $E_{Q(L-)}$ $E_{Q(C+)}$</p>	<p>varh</p>	$E_{Q(L+)} = \sum_{i=1}^M Q_{L+}(i)T(i)$ $Q_{L+}(i) = Q(i) \text{ if } Q(i) > 0 \text{ i } P(i) > 0$ $Q_{L+}(i) = 0 \text{ in other cases}$ $E_{Q(C-)} = \sum_{i=1}^M Q_{C-}(i)T(i)$ $Q_{C-}(i) = Q(i) \text{ if } Q(i) > 0 \text{ i } P(i) < 0$ $Q_{C-}(i) = 0 \text{ in other cases}$ $E_{Q(L-)} = \sum_{i=1}^M Q_{L-}(i)T(i)$ $Q_{L-}(i) = Q(i) \text{ if } Q(i) < 0 \text{ i } P(i) < 0$ $Q_{L-}(i) = 0 \text{ in other cases}$ $E_{Q(C+)} = \sum_{i=1}^M Q_{C+}(i)T(i)$ $Q_{C+}(i) = Q(i) \text{ if } Q(i) < 0 \text{ i } P(i) > 0$ $Q_{C+}(i) = 0 \text{ in other cases}$ <p>where: <i>i</i> is subsequent number of the 10/12-period measurement window <i>Q(i)</i> represents active power (Budeanu or IEEE1459) calculated in <i>i</i>-th measuring window <i>P(i)</i> represents calculated active power in the <i>i</i>-th measuring window <i>T(i)</i> represents duration of <i>i</i>-th measuring window (in hours)</p>
<p>Apparent energy</p>	<p>E_S</p>	<p>VAh</p>	$E_S = \sum_{i=1}^M S(\text{and})T(i)$ <p>where: <i>i</i> is subsequent number of the 10/12-period measurement window, <i>S(i)</i> represents apparent power <i>S</i> calculated in <i>i</i>-th measuring window <i>T(i)</i> represents duration of <i>i</i>-th measuring window (in hours)</p>

4.2 Split-phase network

Split-phase network (parameters not mentioned are calculated as for single-phase)			
Parameter			Method of calculation
Name	Designation	Unit	
Total active power	P_{tot}	W	$P_{tot} = P_A + P_B$
Total Budeanu reactive power	Q_{Btot}	var	$Q_{Btot} = Q_{BA} + Q_{BB}$
Total reactive power of fundamental component	Q_{1tot}	var	$Q_{1tot} = Q_{1A} + Q_{1B}$
Total apparent power	S_{tot}	VA	$S_{tot} = S_A + S_B$
Total apparent distortion power	S_{Ntot}	VA	$S_{Ntot} = S_{NA} + S_{NB}$
Total Budeanu distortion power	D_{Btot}	var	$D_{Btot} = D_{BA} + D_{BB}$
Total Power Factor	PF_{tot}	-	$PF_{tot} = \frac{P_{tot}}{S_{tot}}$
Total displacement power factor	$\cos\varphi_{tot}$ DPF_{tot}	-	$\cos\varphi_{tot} = DPF_{tot} = \frac{1}{2}(\cos\varphi_A + \cos\varphi_B)$
Total tangent φ (4-quadrant)	$\tan\varphi_{tot(L+)}$	-	$\tan\varphi_{tot(L+)} = \frac{\Delta E_{Qtot(L+)}}{\Delta E_{Ptot+}}$ where: $\Delta E_{Qtot(L+)}$ is the increase in total reactive energy $E_{Qtot(L+)}$ (Budeanu/IEEE-1459) in a given averaging period, ΔE_{Ptot+} is the increase in total active energy E_{Ptot+} in a given averaging period
	$\tan\varphi_{tot(C-)}$	-	$\tan\varphi_{tot(C-)} = -\frac{\Delta E_{Qtot(C-)}}{\Delta E_{Ptot+}}$ where: $\Delta E_{Qtot(C-)}$ is the increase in total reactive energy $E_{Qtot(C-)}$ (Budeanu/IEEE-1459) in a given averaging period, ΔE_{Ptot+} is the increase in total active energy taken E_{Ptot+} in a given averaging period
	$\tan\varphi_{tot(L-)}$	-	$\tan\varphi_{tot(L-)} = \frac{\Delta E_{Qtot(L-)}}{\Delta E_{Ptot+}}$ where: $\Delta E_{Qtot(L-)}$ is the increase in total reactive energy $E_{Qtot(L-)}$ (Budeanu/IEEE-1459) in a given averaging period, ΔE_{Ptot+} is the increase in total active energy taken E_{Ptot+} in a given averaging period
	$\tan\varphi_{tot(C+)}$	-	$\tan\varphi_{tot(C+)} = -\frac{\Delta E_{Qtot(C+)}}{\Delta E_{Ptot+}}$ where: $\Delta E_{Qtot(C+)}$ is the increase in total reactive energy $E_{Qtot(C+)}$ (Budeanu/IEEE-1459) in a given averaging period, ΔE_{Ptot+} is the increase in total active energy taken E_{Ptot+} in a given averaging period
Total active energy (consumed and supplied)	E_{Ptot+} E_{Ptot-}	Wh	$E_{Ptot+} = \sum_{i=1}^M P_{tot+}(i)T(i)$ $P_{tot+}(i) = \begin{cases} P_{tot}(i) & \text{for } P_{tot}(i) > 0 \\ 0 & \text{for } P_{tot}(i) \leq 0 \end{cases}$ $E_{Ptot-} = \sum_{i=1}^M P_{tot-}(i)T(i)$

			<p>where: <i>i</i> is subsequent number of the 10/12-period measurement window, $P_{tot}(i)$ represents total active power P_{tot} calculated in <i>i</i>-th measuring window $T(i)$ represents duration of <i>i</i>-th measuring window (in hours)</p>
<p>Total Budeanu reactive energy (4-quadrant)</p>	$E_{Q_{tot}(L+)}$ $E_{Q_{tot}(C-)}$ $E_{Q_{tot}(L-)}$ $E_{Q_{tot}(C+)}$	<p>varh</p>	$E_{Q_{tot}(L+)} = \sum_{i=1}^M Q_{L+}(i)T(i)$ $Q_{L+}(i) = Q(i) \text{ if } Q(i) > 0 \text{ i } P(i) > 0$ $Q_{L+}(i) = 0 \text{ in other cases}$ $E_{Q_{tot}(C-)} = \sum_{i=1}^M Q_{C-}(i)T(i)$ $Q_{C-}(i) = Q(i) \text{ if } Q(i) > 0 \text{ i } P(i) < 0$ $Q_{C-}(i) = 0 \text{ in other cases}$ $E_{Q_{tot}(L-)} = \sum_{i=1}^M Q_{L-}(i)T(i)$ $Q_{L-}(i) = Q(i) \text{ if } Q(i) < 0 \text{ i } P(i) < 0$ $Q_{L-}(i) = 0 \text{ in other cases}$ $E_{Q_{tot}(C+)} = \sum_{i=1}^M Q_{C+}(i)T(i)$ $Q_{C+}(i) = Q(i) \text{ if } Q(i) < 0 \text{ i } P(i) > 0$ $Q_{C+}(i) = 0 \text{ in other cases}$ <p>where: <i>i</i> is subsequent number of the 10/12-period measurement window, $Q(i)$ represents total reactive power (Budeanu or IEEE1459) calculated in <i>i</i>-th measuring window, $P(i)$ represents total active power calculated in <i>i</i>-th measuring window, $T(i)$ represents duration of <i>i</i>-th measuring window (in hours)</p>
<p>Total apparent energy</p>	E_{Stot}	<p>VAh</p>	$E_{Stot} = \sum_{i=1}^M S_{tot}(i)T(i)$ <p>where: <i>i</i> is subsequent number of the 10/12-period measurement window $S_{tot}(i)$ represents the total apparent power S_{tot} calculated in <i>i</i>-th measuring window $T(i)$ represents duration of <i>i</i>-th measuring window (in hours)</p>

4.3 3-phase wye network with N conductor (3-phase, 4-wire)

3-phase wye network with N conductor (parameters not mentioned are calculated as for single-phase)			
Parameter			Method of calculation
Name	Designation	Unit	
Total active power	P_{tot}	W	$P_{tot} = P_A + P_B + P_C$
Total Budeanu reactive power	Q_{Btot}	var	$Q_{Btot} = Q_{BA} + Q_{BB} + Q_{BC}$
Total reactive power acc. to IEEE 1459	Q_{r^+}	var	$Q_1^+ = 3U_1^+ I_1^+ \sin \varphi_1^+$ where: U_1^+ is the voltage positive sequence component (of the fundamental component) I_1^+ is the current positive sequence component (of the fundamental component) φ_1^+ is the angle between components U_1^+ and I_1^+
Effective apparent power	S_e	VA	$S_e = 3U_e I_e$ where: $U_e = \sqrt{\frac{3(U_A^2 + U_B^2 + U_C^2) + U_{AB}^2 + U_{BC}^2 + U_{CA}^2}{18}}$ $I_e = \sqrt{\frac{I_A^2 + I_B^2 + I_C^2 + I_N^2}{3}}$
Effective apparent distortion power	S_{eN}	VA	$S_{eN} = \sqrt{S_e^2 + S_{e1}^2}$ where: $S_{e1} = 3U_{e1} I_{e1}$ $U_{e1} = \sqrt{\frac{3(U_{A1}^2 + U_{B1}^2 + U_{C1}^2) + U_{AB1}^2 + U_{BC1}^2 + U_{CA1}^2}{18}}$ $I_{e1} = \sqrt{\frac{I_{A1}^2 + I_{B1}^2 + I_{C1}^2 + I_{N1}^2}{3}}$
Total Budeanu distortion power	D_{Btot}	var	$D_{Btot} = D_{BA} + D_{BB} + D_{BC}$
Total Power Factor	PF_{tot}	-	$PF_{tot} = \frac{P_{tot}}{S_e}$
Total displacement power factor	$\cos \varphi_{tot}$ DPF_{tot}	-	$\cos \varphi_{tot} = DPF_{tot} = \frac{1}{3} (\cos \varphi_A + \cos \varphi_B + \cos \varphi_C)$
Total tangent φ (4-quadrant)	$\tan \varphi_{tot(L+)}$ $\tan \varphi_{tot(C-)}$ $\tan \varphi_{tot(L-)}$ $\tan \varphi_{tot(C+)}$	-	calculated as for the split-phase network
Total active energy (consumed and supplied)	E_{P+tot} E_{P-tot}	Wh	calculated as for the split-phase network
Total Budeanu reactive energy (4-quadrant)	$E_{Q_{tot}(L+)}$ $E_{Q_{tot}(C-)}$ $E_{Q_{tot}(L-)}$ $E_{Q_{tot}(C+)}$	varh	calculated as for the split-phase network

Total apparent energy	E_{Stot}	VAh	$E_{Stot} = \sum_{i=1}^M S_e(i)T(i)$ <p>where: i is subsequent number of the 10/12-period measurement window $S_e(i)$ represents the effective apparent power S_e, calculated in i-th measuring window $T(i)$ represents duration of i-th measuring window (in hours)</p>
RMS value of zero voltage sequence	U_0	V	$\underline{U}_0 = \frac{1}{3}(\underline{U}_{A1} + \underline{U}_{B1} + \underline{U}_{C1})$ $U_0 = \text{mag}(\underline{U}_0)$ <p>where \underline{U}_{A1}, \underline{U}_{B1}, \underline{U}_{C1} are vectors of fundamental components of phase voltages U_A, U_B, U_C Operator $\text{mag}()$ indicates vector module</p>
Voltage positive sequence component	U_1	V	$\underline{U}_1 = \frac{1}{3}(\underline{U}_{A1} + a\underline{U}_{B1} + a^2\underline{U}_{C1})$ $U_1 = \text{mag}(\underline{U}_1)$ <p>where \underline{U}_{A1}, \underline{U}_{B1}, \underline{U}_{C1} are vectors of fundamental components of phase voltages U_A, U_B, U_C Operator $\text{mag}()$ indicates vector module</p> $a = 1e^{j120^\circ} = -\frac{1}{2} + \frac{\sqrt{3}}{2}j$ $a^2 = 1e^{j240^\circ} = -\frac{1}{2} - \frac{\sqrt{3}}{2}j$
Voltage negative sequence component	U_2	V	$\underline{U}_2 = \frac{1}{3}(\underline{U}_{A1} + a^2\underline{U}_{B1} + a\underline{U}_{C1})$ $U_2 = \text{mag}(\underline{U}_2)$ <p>where \underline{U}_{A1}, \underline{U}_{B1}, \underline{U}_{C1} are vectors of fundamental components of phase voltages U_A, U_B, U_C Operator $\text{mag}()$ indicates vector module</p> $a = 1e^{j120^\circ} = -\frac{1}{2} + \frac{\sqrt{3}}{2}j$ $a^2 = 1e^{j240^\circ} = -\frac{1}{2} - \frac{\sqrt{3}}{2}j$
Voltage zero sequence unbalance ratio	u_0	%	$u_0 = \frac{U_0}{U_1} \cdot 100\%$
Voltage negative sequence unbalance ratio	u_2	%	$u_2 = \frac{U_2}{U_1} \cdot 100\%$
Current zero sequence component	I_0	A	$\underline{I}_0 = \frac{1}{3}(\underline{I}_{A1} + \underline{I}_{B1} + \underline{I}_{C1})$ $I_0 = \text{mag}(\underline{I}_0)$ <p>where \underline{I}_{A1}, \underline{I}_{B1}, \underline{I}_{C1} are vectors of fundamental components for phase currents I_A, I_B, I_C Operator $\text{mag}()$ indicates vector module</p>
Current positive sequence component	I_1	A	$\underline{I}_1 = \frac{1}{3}(\underline{I}_{A1} + a\underline{I}_{B1} + a^2\underline{I}_{C1})$ $I_1 = \text{mag}(\underline{I}_1)$ <p>where \underline{I}_{A1}, \underline{I}_{B1}, \underline{I}_{C1} are vectors of fundamental current components I_A, I_B, I_C Operator $\text{mag}()$ indicates vector module</p>

4 Calculation formulas

Current negative sequence component	I_2	A	$I_2 = \frac{1}{3}(I_{A1} + a^2 I_{B1} + a I_{C1})$ $I_2 = \text{mag}(I_2)$ <p>where I_{A1}, I_{B1}, I_{C1} are vectors of fundamental components for phase voltages I_A, I_B, I_C Operator $\text{mag}()$ indicates vector module</p>
Current zero sequence unbalance ratio	i_0	%	$i_0 = \frac{I_0}{I_1} \cdot 100\%$
Current negative sequence unbalance ratio	i_2	%	$i_2 = \frac{I_2}{I_1} \cdot 100\%$

4.4 3-phase wye without N conductor and delta networks

3-phase wye without N conductor and delta networks (parameters: voltage and current, DC voltage and DC current, THD and K factors, symmetrical components and unbalance factors, flicker are calculated as for 1-phase circuits; instead of the phase voltages, phase-to-phase voltages are used)			
Parameter			Method of calculation
Name	Designation	Unit	
Phase-to-phase voltage U_{CA}	U_{CA}	V	$U_{CA} = -(U_{AB} + U_{BC})$
Current I_2 (Aron measuring circuits)	I_2	A	$I_2 = -(I_1 + I_3)$
Total active power	P_{tot}	W	$P_{tot} = \frac{1}{M} \left(\sum_{i=1}^M U_{iAC} I_{iA} + \sum_{i=1}^M U_{iBC} I_{iB} \right)$ <p>where: U_{iAC} is a subsequent sample of voltage U_{A-C} U_{iBC} is a subsequent sample of voltage U_{B-C} I_{iA} is a subsequent sample of current I_A I_{iB} is a subsequent sample of current I_B $M = 2048$ for 50 Hz and 60 Hz</p>
Total apparent power	S_e	VA	$S_e = 3U_e I_e$ <p>where:</p> $U_e = \sqrt{\frac{U_{AB}^2 + U_{BC}^2 + U_{CA}^2}{9}}$ $I_e = \sqrt{\frac{I_A^2 + I_B^2 + I_C^2}{3}}$
Total reactive power (Budeanu and IEEE 1459)	Q_{tot}	var	$Q = N = \text{sign} \sqrt{S_e^2 - P^2}$ <p>where sign is equal to 1 or -1. The sign is determined basing on the angle of phase shift between standardized symmetrical components of voltages and currents</p>
Total Budeanu distortion power	D_{Btot}	var	$D_{Btot} = 0$
Effective apparent distortion power	S_{eN}	VA	$S_{eN} = \sqrt{S_e^2 + S_{e1}^2}$ <p>where: $S_{e1} = 3U_{e1} I_{e1}$</p>

			$U_{e1} = \sqrt{\frac{U_{AB1}^2 + U_{BC1}^2 + U_{CA1}^2}{9}}$ $I_{e1} = \sqrt{\frac{I_{A1}^2 + I_{B1}^2 + I_{C1}^2}{3}}$
Total Power Factor	PF_{tot}	-	$PF_{tot} = \frac{P_{tot}}{S_e}$
Active energy (consumed and supplied)	$\frac{E_{Ptot+}}{E_{Ptot-}}$	Wh	calculated as for the split-phase network
Total apparent energy	E_{Stot}	VAh	$E_{Stot} = \sum_{i=1}^M S_e(i)T(i)$ <p>where: <i>i</i> is subsequent number of the 10/12-period measurement window <i>S_e(i)</i> represents the total apparent power <i>S_e</i> calculated in <i>i</i>-th measuring window <i>T(i)</i> represents duration of <i>i</i>-th measuring window (in hours)</p>

5 Power quality - a guide

5.1 Basic information

The measurement methodology is mostly imposed by the power quality standards, mainly IEC 61000-4-30. This standard, introducing precise measurement algorithms, ordered analyzers market, allowing customers to easily compare the devices and their results between the analyzers from different manufacturers. Previously, these devices used different algorithms, and often the results from measurements on the same object were completely different when tested with different devices.

The factors behind growing interest in these issues have included wide use of electronic power controllers, DC/DC converters and switched-mode power supplies, energy-saving fluorescent lamps, etc., that is widely understood electrical power conversion. All of these devices had a tendency to significantly deform the supply current waveform.

The design of switched-mode power supplies (widely used in household and industrial applications) is often based on the principle that the mains alternating voltage is first rectified and smoothed with the use of capacitors, meaning that it is converted to direct voltage (DC), and then with a high frequency and efficiency is converted to required output voltage. Such a solution, however, has an undesirable side effect. Smoothing capacitors are recharged by short current pulses at moments when the mains voltage is close to peak value. From power balance rule it is known that if the current is taken only at short intervals, its crest value must be much higher than in case it is taken in a continuous manner. High ratio of current crest value to RMS value (a so-called Crest Factor) and reduction of Power Factor (PF) will result in a situation in which in order to obtain a given active power in a receiver (in watts), the power supplier must supply power greater than the receiver active power (this is a so-called apparent power expressed in volt-amperes, VA). Low power factor causes higher load on the transmission cables and higher costs of electricity transfer. Harmonic current components accompanying such parameters cause additional problems. As a result, the electricity suppliers have started to impose financial penalties upon the customers who have not provided sufficiently high power factor.

Among entities that may be potentially interested in power quality analyzers are power utility companies on one hand, (they may use them to control their customers), and on the other hand the energy consumers who may use the analyzers to detect and possibly improve the low power factor and solve other problems related to widely understood power quality issues.

The power source quality parameters, as well as the properties of receivers, are described with many various parameters and indices. This paper can shed some light on this area.

As already mentioned, the lack of standardization of measurement methods has caused significant differences in values of individual mains parameters calculated with various devices. Efforts of many engineers resulted in IEC 61000-4-30 standard concerning power quality. For the first time, this standard (and related standards) provided very precise methods, mathematical relations and required measurement accuracy for power quality analyzers. Compliance with the standard (in particular, the class A) should be a guarantee of repeatable and almost identical measurement results of the same magnitudes measured with devices from different manufacturers.

5.1.1 Current Transformer (CT) probes for measuring alternating currents (AC)

CT probes (CT - *Current Transformer*) are simply large current transformer processing high current of the primary winding into the lower current in the secondary winding. The jaws of typical current probe are made of a ferromagnetic material (e.g. iron) wound around the secondary winding. The primary winding is a conductor around which the probe jaws are closed - usually it is one single coil. If the 1000-ampere current flows through the tested conductor, in the secondary winding with 1000 coils the current will be only 1 A (if the circuit is closed). In probes with voltage output, a shunt resistor is located in the probes.

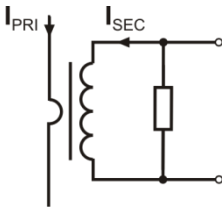

Fig. 46. CT probes with voltage output

This type of current transformer has several distinguishing features. It may be used to measure very high currents and its power consumption is low. Magnetizing current causes a phase shift (tenth of a degree), which may introduce an error in power measurement (especially at low power factor). The disadvantage of this type of probes is the core saturation when very high currents are measured (above the nominal range). Core saturation as a result of magnetizing hysteresis leads to significant measurement errors, which may be eliminated only by the core demagnetization. The core becomes saturated also when the measured current has a considerable DC component. Undeniable disadvantage of hard probes is their significant weight.

Despite these drawbacks, CT probes are currently the most widely used non-invasive method for measuring alternating currents (AC).

Together with the analyzer, you can use the following types of CT probes for measuring alternating currents:

- C-4(A), with a nominal range of 1000 A AC,
- C-6(A), with a nominal range of 10 A AC,
- C-7(A), with a nominal range of 100 A AC.

5.1.2 Probes for measuring alternating and direct currents (AC/DC)

In some situations it is necessary to measure the current DC component. For this purpose the user must apply probes with a principle of operation different than a traditional current transformer. Such probes operate basing on "Hall effect" and include a built-in Hall sensor (called also 'hallo-tron'). In brief: the effect is based on the occurrence of an electrical voltage on the walls of the conductor, through which an electric current flows and which is in magnetic field of direction transverse to the induction vector of this field.

Current probes based on this phenomenon may measure both DC and AC current components. The conductor with current located inside the probes generates a magnetic field which concentrates in its iron core. In the core slot, where the two parts of probes meet, a semiconductor Hall sensor is located, and its output voltage is amplified by battery-powered electronic circuit.

Probes of this type usually have a current-zero adjustment knob. To adjust the current zero, close the jaws (no conductor inside) and turn the knob until DC indication is zero.

Sonel S.A. offers this type of probes: C-5A with a nominal range of 1000 A AC / 1400 A DC. Probes of this type have a voltage output and for nominal current of 1000 A the provide voltage of 1 V (1 mV/A).

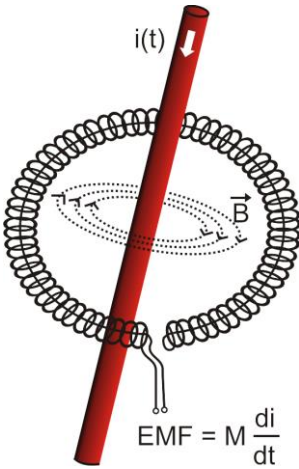

Fig. 47. Rogowski coil

5.1.3 Flexible probes

Flexible probes (*Flexible Current Probes*) operate on a different physical principle than the current transformer. Their most important part is Rogowski coil, named after Walter Rogowski - a German physicist. It is an air-core coil wound around a conductor with current. Special design of the coil allows leading out its both ends on the same side, thus facilitating probe placement around the conductor (the return end is placed inside the coil at its entire length). The current flowing through the measured conductor causes centric magnetic field lines which due to the self-induction phenomenon induce the electromotive force at the end of the coil. This voltage, however, is proportional to the rate of current change in the conductor, and not to the current itself.

Rogowski coil has some undeniable advantages compared with current transformers. As it does not have a core, the core saturation effect is eliminated; thus being a perfect instrument to measure high currents. Such coil has also an excellent linearity and a wide pass band, much wider than a current transformer, and its weight is much smaller.

However, until recently the wider expansion of flexible probes in the current measurement area was difficult. There are some factors that hinder the practical implementation of the measurement system with a Rogowski coil. One of them is a very low voltage level which is induced on the probes (it depends on geometrical dimensions of the coil). For example, the output voltage for 50 Hz frequency of the F-series flexible probes (to be used with the analyzer) is approx. $40\mu\text{V/A}$. Such low voltages require the use of precise and low-noise amplifiers which of course increase the costs.

As the output voltage is proportional to the current derivative, it is necessary to use an integrator circuit; generally, the flexible probes comprise a Rogowski coil and an analogue integrator circuit (characteristic battery-powered module). On the integrator output the voltage signal is available and proportional to the measured current and suitably scaled (for example 1mV/A).

Another problem concerning Rogowski coil, is its sensitivity to external magnetic fields. A perfect coil should be sensitive only to the fields closed within its area and should totally suppress external magnetic fields. But this is a very difficult task. The only way to obtain such properties is very precise manufacturing of the coil, with perfectly homogeneous windings and impedance as low as possible. It is the high precision which results in a relatively high price of such probes.

The user may connect the analyzer to the flexible probes offered by Sonel S.A. Clamp types and parameters are described in **section 7**.

5.2 Flicker

In terms of power quality 'flicker' means a periodical changes of light intensity as a result of fluctuations of voltage supplied to light bulbs.

The flicker measurement function appeared in the power quality analyzers when it turned out that this phenomenon causes discomfort, irritation, sometimes headache, etc. The luminous intensity fluctuations must have a specified frequency, they cannot be too slow, as the human pupil is able to adapt to changes in illumination; they cannot be too fast because the filament inertia eliminates these fluctuations almost totally.

Studies have shown that the maximum discomfort occurs for frequencies around 9 changes per second. The most sensitive light sources are the traditional light bulbs with a tungsten filament. Halogen bulbs, which filaments have much higher temperature, have also much higher inertia, which reduces the perceived brightness changes. Fluorescent lamps have the best flicker "resistance", as due to their specific properties they stabilize the current flowing through the lamp during the voltage changes, and thus reduce the fluctuations.

Flicker is measured in perceptibility units, and there are two types of flicker: short-term P_{ST} , which is determined once every 10 minutes and long-term P_{LT} , which is calculated on the basis of 12 consecutive P_{ST} values, i.e. every 2 hours. Long time of measurement results directly from the slow-changing nature of this phenomenon - to collect sample data the measurement must be long. P_{ST} equal to 1 is considered to be a value on the border of annoyance – certainly sensitivity to flicker is different for different persons; this threshold has been assumed basing on tests carried out on a representative group of people.

What causes flicker? Most frequently, the reason is the voltage drop as a result of connecting and disconnecting large loads and some level of flicker is present in the majority of mains systems. In addition to the previously described adverse impact on human health, flicker does not need to be (and usually it isn't) a symptom of malfunctioning of our installation. However, if a rather abrupt and unexplainable flicker increase is observed in the mains (increased P_{ST} and P_{LT} parameters) it should not be ignored under any circumstances. It may turn out that the flicker is caused by poor connections in the installation – increased voltage drops on connections in the distribution panel (for example) will result in higher voltage fluctuations on the receivers, such as light bulbs. The voltage drops on connections also cause their heating, and finally sparking and possibly a fire. Periodical mains tests and described symptoms may turn our attention and help find the source of hazard.

5.3 Power and energy measurement

Power is one of the most important parameters determining the properties of electrical circuits. The basic unit used in financial settlements between the electricity supplier and consumer is electric energy calculated as the product of power and time.

In electrical engineering, several different power types are distinguished:

- *Active Power* - marked with P and measured in Watts,
- *Reactive Power* - marked with Q, unit: var,
- *Apparent Power* S, unit: VA.

These three types of power are the most known, but there are also other types.

At school we are taught that these powers form the so-called 'power triangle' with properties expressed in the equation:

$$P^2 + Q^2 = S^2$$

This equation, however, is valid only for systems with sinusoidal voltage and current waveforms.

Before moving to a more detailed discussion concerning power measurement, individual types of power should be defined.

5.3.1 Active power

Active power P is a magnitude with precise physical meaning and it expresses the ability of a system to perform a particular work. It is the power most desired by the energy consumers and it is for this supplied power that the consumer pays the supplier in a given settlement period (the problem of fees for additional reactive power is discussed separately – see below). It is the active power (and consequently, the active energy) which is measured by electric energy meters in each household.

The basic formula for calculating the active power is as follows:

$$P = \frac{1}{T} \int_t^{t+T} u(t)i(t)dt$$

where: $u(t)$ – instantaneous voltage value, $i(t)$ - instantaneous current value, T - period for which the power is calculated.

In sinusoidal systems, the active power may be calculated as:

$$P = UI\cos\varphi$$

where: U is RMS voltage, I is RMS current and φ is the phase shift angle between voltage and current.

The active power is calculated by the analyzer directly from the integral formula, using sampled voltage and current waveforms:

$$P = \frac{1}{M} \sum_{i=1}^M U_i I_i$$

where M is a number of samples in 10/12-period measuring window (2048) and U_i and I_i are successive voltage and current samples.

5.3.2 Reactive power

The most known formula for *reactive power* is also correct only for one-phase circuits with sinusoidal voltage and current waveforms:

$$Q = UI \sin \varphi$$

Interpretation of this power in such systems is as follows: it is the amplitude of AC component of the instantaneous power on source terminals. Existence of a non-zero value of this power indicates a bidirectional and oscillating energy flow between the source and the receiver.

Imagine a system with a single-phase sinusoidal voltage source, where the load is a RC circuit. As under such conditions, these components behave linearly, the source current waveform will be sinusoidal, but due to the properties of the capacitor it will be shifted in relation to the voltage source. In such a circuit, reactive power Q is non-zero and may be interpreted as an amplitude of the energy oscillation, which is alternately stored and returned by the capacitor. Active power of the capacitor is zero.

However, it turns out the energy oscillation seems only an effect, and that it appears in particular cases of circuits with sinusoidal current and voltage waveforms, and is not the cause of reactive power. Research in this area has shown that reactive power occurs also in circuits without any energy oscillation. This statement may surprise many engineers. In latest publications on power theory, the only physical phenomenon mentioned which always accompanies appearance of reactive power is phase shift between current and voltage.

The above mentioned formula for calculating the reactive power is valid only for single-phase sinusoidal circuits. How then we should calculate the reactive power in non-sinusoidal systems? For electrical engineers this question opens the 'Pandora's box'. It turns out that the reactive power definition in real systems (and not only those idealized) has been subject to controversy and now (2018) we do not have one, generally accepted definition of reactive power in systems with non-sinusoidal voltage and current waveforms, not to mention even unbalanced three-phase systems. The IEEE (Institute of Electrical and Electronics Engineers) 1459-2010 standard (from 2010) does not give a formula for total reactive power for non-sinusoidal three-phase systems – as three basic types of power the standard mentions are active power, apparent power and – attention – non-active power designated as N . Reactive power has been limited only to the fundamental component and marked as Q_1 .

This standard is the last document of this type issued by recognized organization which was to put the power definition issues in order. It was even more necessary as for many years specialists in scientific circles reported that the power definitions used so far may give erroneous results. Controversies concerned mainly the definition of reactive power and apparent power (and distortion power – see below) in single- and three-phase circuits with non-sinusoidal voltages and currents.

In 1987, professor L.S. Czarniecki proved the widely used definition of reactive power defined by Budeanu was wrong. This definition is still taught in some technical schools and it was presented by prof. Budeanu in 1927. The formula is as follows:

$$Q_B = \sum_{n=0}^{\infty} U_n I_n \sin \varphi_n$$

where U_n and I_n are voltage and current harmonics of order n , and φ_n are angles between these components.

When this parameter has been introduced, the known power triangle equation was not valid for circuits with non-sinusoidal waveforms - therefore Budeanu introduced a new parameter called the *distortion power*.

$$D_B = \sqrt{S^2 - (P^2 + Q_B^2)}$$

Distortion power strain was meant to represent powers occurring in the system due to distorted voltage and current waveforms.

For years, reactive power was associated with the energy oscillations between its source and the load. The formula indicates that according to Budeanu's definition, the reactive power is the sum of individual harmonics. Due to $\sin\varphi$ factor, such components may be positive or negative depending on the angle between the voltage and current harmonics. Thus, it is possible that the total reactive power Q_B is zero at non-zero harmonics. Observation that at non-zero components, total reactive power may be zero (according to this definition) is a key to a deeper analysis which finally allowed proving that in some situations Q_B may give quite surprising results. The research has questioned the general belief that there is a relation between energy oscillations and Budeanu reactive power Q_B . Examples of circuits may be presented, where despite the oscillating character of instantaneous power waveform, reactive power according to Budeanu is zero. Over the years, the scientists have not been able to connect any physical phenomenon to the reactive power according to this definition.

Such doubts about the correctness of this definition of course also cast shadow on the related *distortion power* D_B . The scientists have started to look for answers to the question whether the distortion power D_B really is the measure of distorted waveforms in non-sinusoidal circuits. The distortion is a situation in which the voltage waveform cannot be "put" on the current waveform with two operations: change of amplitude and shift in time. In other words, if the following condition is met:

$$u(t) = Ai(t - \tau)$$

then, voltage is not distorted in relation to the current. In case of sinusoidal voltage and load which is any combination of RLC elements, this condition is always met (for sinusoidal waveforms, these elements maintain linearity). However, when the voltage is distorted, the RLC load does not ensure absence of current distortion in relation to voltage any more, and the load is no longer linear – it is necessary to meet some additional conditions (module and phase of load impedance changing with frequency).

And then, is really D_B a measure of such distortion? Unfortunately, also in this case the Budeanu's power theory fails. It has been proven that the *distortion power* may be equal to zero in a situation when voltage is distorted in relation to current waveform, and vice versa, the *distortion power* may be non-zero at total absence of distortion.

Practical aspect of this power theory which relates to improvement of power factor in systems with reactive power was to be the feature to take the most advantage of correct definitions of reactive power. The compensation attempts based on the Budeanu reactive power and related distortion power failed. These parameters did not allow even a correct calculation of correction capacitance which gives the maximum power factor. Sometimes, such attempts resulted even in additional deterioration of power factor.

How come, then, that the Budeanu's power theory has become so popular? There may be several reasons for this. Firstly, engineers got accustomed to old definitions and the curricula in schools have not been changed for years. This factor is often underestimated, though as a form of justification it can be said that this theory had not been refuted for 60 years. Secondly, in the 1920s

5 Power quality - a guide

there were no measuring instruments which could give insight in individual voltage and current harmonic components and it was difficult to verify new theories. Thirdly, distorted voltage and current waveforms (i.e. with high harmonics contents) are a result of revolution in electrical power engineering which did not start before the second part of the last century. Thyristors, controlled rectifiers, converters, etc. began to be widely used. All these caused very large current distortion in the mains, and consequently increased harmonic distortion. Only then the deficiencies of Budeanu's theory became evident. Finally, the scientific circles related to power engineering were aware of the fact that industrial plants had invested a fortune in the measuring infrastructure (energy meters). Any change in this regard could have huge financial implications.

However, slow changes in the approach of electrical engineers began to be visible. With time, as non-linear loads were more and more frequent and the waveforms more and more distorted, the limitations of used formulas could no longer be tolerated.

A very significant event was publishing by IEEE (in 2000) 1459 standard "*Definitions for the Measurement of Electric Power Quantities Under Sinusoidal, Non-sinusoidal, Balanced, or Unbalanced Conditions*". For the first time, Budeanu's definition of reactive power has been listed as not recommended for new reactive power and energy meters. Many parameters have been also divided into the part related to the current and voltage fundamental component (first harmonics) and the part related to remaining higher harmonics. In most cases, it is recognized that the usable part of energy is transmitted by the 50/60Hz components, with much smaller (and often harmful) participation of higher harmonics.

The standard also introduced a new parameter – non-active power N which represents all non-active components of power:

$$N = \sqrt{S^2 - P^2}$$

Reactive power is the power of one of the components of the inactive power N . In single-phase systems with sinusoidal voltage and current waveforms, N equals Q ; hence the non-active power does not have any other components. In three-phase systems, this is true only for symmetrical sinusoidal systems with a balanced purely resistive load.

Other non-active power components are related to specific physical phenomena. According to prof. Czarniecki's theory, which is one of the best in explaining the physical phenomena in three-phase systems, the power equation in such systems is as follows:

$$S^2 = P^2 + D_s^2 + Q^2 + D_u^2$$

D_s is the scattered power, which occurs in the system, as a result of changing conductance of the receiver with frequency. Thus, the presence of reactive elements may result in the scattered power.

In this equation, reactive power Q appears when there is a phase shift between the voltage and current harmonics.

D_u means the unbalanced power which is a measure of unbalance of a three-phase receiver. This component explains the situation in which an unbalanced three-phase load of a purely resistive character results in the power factor less than one. Such receiver has no reactive power Q , and still the results from the power triangle S , P , Q are totally different (the Budeanu's power theory with its distortion power could not explain this situation either – in a purely resistive receiver, the distortion power D_B equals zero).

An attempt to combine IEEE 1459-2000 standard with the Czarniecki's power theory leads to the conclusion that non-active power includes at least three separate physical phenomena, which influence the reduced effectiveness of energy transmission from the source to the receiver, i.e. reduction of the power factor:

$$PF = \frac{P}{S_e} = \frac{P}{\sqrt{P^2 + D_s^2 + Q^2 + D_u^2}}$$

In IEEE 1459-2000 standard, reactive power known as Q has been limited to the fundamental component and it applies both to single-phase and three-phase systems.

In single-phase systems:

$$Q_1 = U_1 I_1 \sin \varphi_1$$

In three-phase systems, only the positive sequence component is taken into account:

$$Q_1^+ = 3U_1^+ I_1^+ \sin \varphi_1^+$$

Correct measurement of this power requires the same phase rotation sequence (i.e. phase L2/B delayed by 120° in relation to L1/A, phase L3/C delayed by 240° in relation to L1/A).

The concept of positive sequence component will be discussed in more detail in the section devoted to unbalance.

The value of reactive power of the fundamental component is the main value which allows estimating the size of capacitor to improve the displacement power factor (DPF), that is the displacement of the voltage fundamental components in relation to the current fundamental component (i.e. compensator of the reactive power of the fundamental component).

5.3.3 Reactive power and three-wire systems

Correct reactive power measurement is impossible in unbalanced receivers connected in 3-wire systems (delta and wye systems without N conductor). This statement may be surprising.

The receiver can be treated as a "black box" with only 3 terminals available. We cannot determine its internal structure. In order to calculate the reactive power, we need to know the phase shift angle between the voltage and the current at each leg of such receiver. Unfortunately, we do not know this angle. In the delta-type receiver we know the voltages on individual impedances, but we do not know the current; in such systems, the phase-to-phase voltages and line currents are measured. Each line current is a sum of two phase currents. In the wye without N-type receivers, we know the currents flowing through impedance, but we do not know the voltages (each phase-to-phase voltage is a sum of two phase-to-neutral voltages).

We need to take account of the fact that at given voltage values at terminals and currents flowing into such "black box", there is an infinite number of variants of receiver internal structure which will give us identical measurement results of voltage and current values visible outside the black box.

Then, how is it possible that there are reactive power meters intended for measurements in three-wire systems and the mains analyzers which allow the reactive power measurement under such circumstances?

In both cases, the manufacturers use the trick which involves an artificial creation of a reference point (virtual neutral terminal N). Such point may be created very easily by connecting to the terminals of our black box a wye-connected system of three resistors of the same value. The potential of the central point in the resistor system is used to calculate the "phase voltages". Obviously quotation marks are justified here, as such virtual zero will provide quite correct results only when the unbalance of the receiver is minimal. In any other case, an indication of reactive power from such device should be treated very cautiously.

In no case should a measuring instrument mislead the user, and such approximation can be allowed only after a clear reservation that the indicated value is not a result of actual measurement, but only an approximated value.

5.3.4 Reactive power and reactive energy counters

Reactive energy counter are devices unknown to the household users who for settlements with energy suppliers use the meters of active energy expressed in Wh or kWh. Household users are in a comfortable situation – they pay only for usable energy and do not have to think what the power factor is in their installations.

In contrast to the first group, the industrial consumers are obliged in their contracts and sometimes under pain of financial penalties to keep the power factor at an appropriate level.

The EN 50160 standard gives some guidelines for the power quality requirements, and defines the quality parameters which should be met by energy supplier. Among these parameters are, among others, mains frequency, RMS voltage, total harmonic distortion (THD) and allowed levels of individual voltage harmonics. Besides EN 50160 requirements there is often an additional condition: the supplier does not need to comply with those requirements if an energy consumer does not ensure the $\tan\phi$ factor below some threshold (agreed value which can be changed in the contract between the energy supplier and consumer, i.e. 0.4) and/or exceeds the agreed level of consumed active energy.

The $\tan\phi$ is defined as a ratio of measured reactive energy to the active energy in a settlement period. Going back for a while to the power triangle in sinusoidal systems, we can see that the tangent of the phase shift angle between the voltage and the current is equal to the ratio of reactive power Q to active power P. Consequently, the requirement to maintain the $\tan\phi$ below 0.4 means nothing else but only that maximum level of measured reactive energy may not exceed 0.4 of the measured active energy. Each consumption of reactive energy above this level is subject to additional fees.

Does the knowledge of $\tan\phi$ calculated in this manner gives both interested parties an actual view of energy transmission effectiveness? Have we not mentioned before that the reactive power is only one of the non-active power components which influence the power factor reduction? Indeed, it seems that instead of $\tan\phi$ we should use the power factor PF which takes into account also other issues.

Unfortunately, the present regulations leave no choice, therefore the correct reactive power measurement seems a key matter. Now, a question should be asked whether the reactive energy meters ensure correct readings in the light of the controversies described above? And what we actually measure using this popular reactive power meters?

The answers to these questions may be searched in the standard concerning such devices: IEC 62053-23. Unfortunately, to our disappointment, we will not find there any reference to measurements in non-sinusoidal conditions – the calculation formulas relate to sinusoidal conditions (we can read in the standard that due to “practical” reasons, non-sinusoidal waveforms have been excluded). The standard does not give any measurement criteria which would allow checking the meter properties at distorted voltage and current waveforms. As a surprise comes also the fact that the older standard (IEC 61268: already withdrawn) defined the test which involved checking the measurement accuracy at 10% of the third current harmonic.

The present situation leaves the choice of measuring method to the energy counters designers, which unfortunately leads to significant differences in reactive energy indications in the presence of high harmonic distortion level.

Older, electromechanical meters have characteristics similar to that of a low-pass filter – the higher harmonics are attenuated in such meters and the reactive power measurement in the presence of harmonics is very close to the value of reactive power of the fundamental component.

Electronic meters which are more and more popular may carry out measurements using various methods. For example, they may measure active and apparent power, and then calculate the reactive power from the power triangle (square root from the sum of both such powers squared). In reality, taking into account IEEE 1459-2000 standard, they measure the non-active power, not the reactive power. Another manufacturer may use the method with voltage waveform shift by 90° , which gives a result close to the reactive power of the fundamental component.

The higher the harmonics content, the higher difference in readings, and of course, as a consequence, other fees for measured energy.

As it has been indicated before, the reactive power measurement in unbalanced three-wire systems with traditional meters is subject to an additional error caused by creation of a virtual zero

inside the meter which has little to do with actual zero of the receiver.

On top of that, the manufacturers usually do not give any information about the applied measuring method.

We may only wait for the next version of the standard, which will define (hopefully) the measuring and testing methods much more precisely, also for non-sinusoidal conditions.

5.3.5 4-quadrant reactive energy measurement

In the power sector, in many situations the reactive energy is divided into four separate components, each of which is counted separately. This division into so-called quadrants is based on the signs of active and reactive power as shown in Fig. 48.

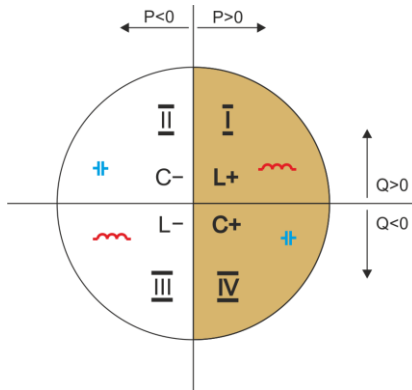

Fig. 48. Four-quadrant division of power and energy flow.

- quadrant I (marked as "L+"): active power is positive (receiving of active energy), reactive power is positive (receiving of reactive power). In such conditions, the nature of the load is inductive.
- quadrant II (marked as "C-"): active power is negative (delivering of active energy), reactive power is positive (receiving of reactive power). The nature of the load is capacitive.
- quadrant III (marked as "L-"): active power is negative (delivering of active energy), reactive power is also negative (delivering of reactive energy). In such conditions, the nature of the load is inductive.
- quadrant IV (marked as "C+"): active power is positive (receiving of active energy), reactive power is negative (delivering of reactive power). The nature of the load is capacitive.

Plus and minus signs in marking quadrants indicate the sign of active power.

Presented division allows the construction of reactive energy meters, which increase their state only when the energy flow takes place in a given quadrant. This also means that at a given moment, only one of the counters can increase its status.

In typical case of supplying the energy to a receiver, the operation takes place in two quadrants: I (L+) and IV (C+). Moreover, in these two quadrants the tangents φ ratio is monitored for customers connected to MV and LV networks in some countries. The four-quadrant $\tan\varphi$ coefficients are determined on the basis of recorded appropriate energy intakes:

$$\tan\varphi_{(L+)} = \frac{\Delta E_{Q(L+)}}{\Delta E_{P+}}$$

$$\tan\varphi_{(C+)} = \frac{\Delta E_{Q(C+)}}{\Delta E_{P+}}$$

5 Power quality - a guide

If the convention is used, assuming all energy meters have a positive sign, the calculated values of tangents are complemented with a character resulting from the character of active and reactive power in a given quadrant. Thus, the sign of $\tan\varphi_{(L+)}$ is always positive, while in case of $\tan\varphi_{(C+)}$ it is always negative.

The calculated values of tangents may be the basis to calculate any penalties for reactive power consumption above the contracted level. In case of quadrant I (L+), a typical limit value above which fees are charged is 0.4. Often, for quadrant IV (C+) any reactive power consumption is the basis for calculating fines. This also results in practical conclusion that the most profitable (for consumer) is operation in the first quadrant (L+) in the range of $\tan\varphi_{(L+)}$ between 0 and 0.4.

5.3.6 Apparent power

Apparent power S is expressed as the product of RMS voltage and current:

$$S = UI$$

As such, the apparent power does not have a physical interpretation; it is used during designing of transmission equipment. In terms of value, it is equal to maximum active power which can be supplied to a load at given RMS voltage and current. Thus, the apparent power defines the maximum capacity of the source to supply usable energy to the receiver.

The measure of effective use of supplied power by the receiver is the power factor, which is the ratio of apparent power to active power.

In sinusoidal systems:

$$PF = \frac{P}{S} = \frac{UI\cos\varphi}{UI} = \cos\varphi$$

In non-sinusoidal systems such simplification is not acceptable and the power factor is calculated based on the actual ratio of active power and apparent power:

$$PF = \frac{P}{S}$$

In single-phase systems, the apparent power is calculated as shown in the formula above and there are no surprises here. However, it turns out that in three-phase systems calculation of this power is equally difficult as calculation of reactive power. Of course, this is related to actual systems with non-sinusoidal waveforms which additionally can be unbalanced.

The tests have shown that the formulas used so far can give erroneous results if the system is unbalanced. Since the apparent power is a conventional parameter and does not have a physical interpretation, determination which of proposed apparent power definitions is correct could be difficult. Yet, the attempts have been made, based on the observation that the apparent power is closely related to the transmission losses and the power factor. Knowing the transmission losses and the power factor, one can indirectly specify a correct definition of apparent power.

The definitions used so far include arithmetic apparent power and vector apparent power. The test have shown however that neither the arithmetic definition nor the vector definition give correct value of the power factor. The only definition which did not fail in such a situation, was the definition proposed as early as in 1922 by F. Buchholz - a German physicist:

$$S_e = 3U_e I_e$$

It is based on the effective values of voltage and current, and the power is called the effective apparent power (for this reason, index "e" is used in marking three-phase systems). Those effective voltage and current values are such theoretical values which represent voltage and current in an energetically equivalent three-phase balanced system. Consequently, the key issue is to determine U_e and I_e .

IEEE Standard 1459 specifies the following formula. In three-wire systems:

$$I_e = \sqrt{\frac{I_a^2 + I_b^2 + I_c^2}{3}}$$

$$U_e = \sqrt{\frac{U_{ab}^2 + U_{bc}^2 + U_{ca}^2}{9}}$$

In four-wire systems:

$$I_e = \sqrt{\frac{I_a^2 + I_b^2 + I_c^2 + I_n^2}{3}}$$

$$U_e = \sqrt{\frac{3(U_a^2 + U_b^2 + U_c^2) + U_{ab}^2 + U_{bc}^2 + U_{ca}^2}{18}}$$

where I_a, I_b, I_c are RMS currents for individual phases (line or phase), I_n is the RMS current in neutral conductor, U_a, U_b, U_c are RMS phase-to-neutral voltages, and U_{ab}, U_{bc}, U_{ca} are RMS phase-to-phase voltages.

S_e calculated in this manner includes both the power losses in the neutral conductor (in four-wire networks) and the effect of unbalance.

5.3.7 Distortion power D_B and effective apparent power S_{eN}

During the discussion on reactive power, it was mentioned that the distortion power according to Budeanu cannot be used for large distortions of voltage and current and for the unbalance of three-phase systems (a paradox of distortion power which is not a measure of actual distortion). However, this power is often used by energy quality specialists and manufacturers of systems for reactive power compensation.

It must be clearly said that this parameter has given relatively good results only in conditions of slight distortion of voltage and current waveforms.

IEEE 1459-2000 standard lists this definition of power, however just like in case of Budeanu reactive power, it has a non-removable defect and it is recommended to discard it entirely. Instead of D_B , another value was proposed to reflect total distortion power in a system in a better way – it is called non-fundamental apparent power S_{eN} . S_{eN} power allows a quick estimation whether a load works in conditions of small or large harmonic distortion; it is also a basis for estimating the static values and active filters or compensators.

According to the definition (for 3-phase systems):

$$S_{eN} = \sqrt{S_e^2 - S_{e1}^2}$$

where:

$$S_{e1} = 3I_{e1}U_{e1}$$

Effective current and RMS voltage of the fundamental component (I_{e1} and U_{e1} respectively) are calculated similarly to I_e and U_e but instead of RMS phase-to-neutral or phase-to-phase voltages, the effective voltages of fundamental components are substituted.

In single-phase systems to calculate the distortion apparent power, a simpler formula may be used:

$$S_N = \sqrt{S^2 - (U_1 I_1)^2}$$

where U_1 and I_1 are effective values of the fundamental components of phase-to-neutral voltage and current.

5.3.8 Power Factor

True Power Factor or Power Factor (TPF or PF) is the value which takes into account also the presence of higher harmonics. For sinusoidal circuits, it is equal to Displacement Power Factor (DPF) i.e. popular $\cos\phi$.

DPF is therefore a measure of the phase shift between the fundamental voltage and current components. Power Factor is the ratio between active and apparent powers:

$$DPF = \frac{P_1}{S_1} = \frac{U_1 I_1 \cos\phi_{U_1 I_1}}{U_1 I_1} = \cos\phi_{U_1 I_1}$$

$$PF = \frac{P}{S}$$

In case of a purely resistive load (in a one-phase system), the apparent power is equal to active power (in terms of value), and reactive power equals zero, so such load fully uses the energy potential of the source and the power factor is 1. Appearance of reactive component inevitably leads to reduction of energy transmission effectiveness – the active power is then less than apparent power, and the reactive power is increasing.

In three-phase systems, the power factor reduction is also influenced by receiver unbalance (see discussion on reactive power). In such systems, correct power factor value is obtained using the effective apparent power S_e , that is the value defined, among others, in IEEE 1459-2000 standard.

5.4 Harmonics

Dividing periodic signal into harmonic components is a very popular mathematical operation based on Fourier's theorem which says that any periodic signal can be represented as a sum of sinusoidal components with frequencies equal to multiples of fundamental frequency of such signal. Time-domain signal can be subjected to Fast Fourier Transform (FFT) to receive amplitudes and phases of harmonic components in the frequency domain.

In a perfect situation, voltage is generated in a generator which at output gives a pure sinusoidal 50/60 Hz waveform (absence of any higher harmonics). If the receiver is a linear system, then also current in such situation is a pure sinusoidal waveform. In real systems, voltage and current waveforms can be distorted, hence in addition to the fundamental component there must be harmonics of higher orders.

Why is the presence of higher harmonics in the network undesirable?

One of the reasons is the skin effect which involves pushing out the electrons from the centre of conductor towards the surface as the current frequency is increasing. As a result, the higher the frequency, the smaller the effective conductor cross section which is available for the electrons, which means that the conductor resistance is increasing. Consequently, the higher the current harmonics, the higher effective cabling resistance for this harmonics, and this inevitably leads to more power losses and heating of conductors.

A classic example connected with this effect is related to neutral conductor in three-phase systems. In a system with little distortion, little unbalance and a balanced (or slightly unbalanced) receiver, the current in neutral conductor has the tendency of zeroing (it is much smaller than RMS phase currents). Such observation has tempted many designers to obtain savings by installing the cabling in such systems with neutral conductor of a smaller cross section than in phase conductors. And everything went well until the appearance of odd harmonic orders which are multiples of 3 (third, ninth, etc.). Suddenly, the neutral conductor began overheating and the measurement showed very high RMS current. Explanation of this phenomenon is quite simple. In this example, the designer did not take into consideration two circumstances: in systems with distorted waveforms, the higher harmonics might not zero in the neutral conductor, and quite to the contrary, they may sum up, and secondly, the skin effect and high harmonic currents additionally contributed to the neutral conductor heating.

Let's try to answer two basic questions:

What is the cause of harmonic components in voltage?

What is the cause of harmonic components in current?

Seemingly, these two questions are almost identical, but separation of current and voltage is extremely important to understand the essence of this issue.

The answer to the first question is as follows: harmonics in voltage are a result on a non-zero impedance of the distribution system, between the generator (assuming that it generates a pure sinusoid) and the receiver.

Harmonics in current, on the other hand, are a result of non-linear impedance of the receiver. Of course, it must be noted that a linear receiver to which distorted voltage is supplied will also have identically distorted current waveform.

The literature often uses the statement that "receiver generates harmonics". It should be remembered that in such case, the receiver is not a physical source of energy (as suggested by the word "generates"). The only source of energy is the distribution system. If the receiver is a passive device, the energy sent from the receiver to the distribution system comes from the same distribution system. We are dealing here with a disadvantageous and useless bidirectional energy flow. As mentioned earlier in the section on power factor, such phenomenon leads to unnecessary energy losses, and the current "generated" in the receiver causes an additional load on the distribution system.

Consider the following example. A typical non-linear receiver, such as widely used switched-mode power supplies (i.e. for computers) receives power from a perfect generator of sinusoidal voltage. For now, let's assume that the impedance of connections between the generator and the receiver is zero. The voltage measured on the receiver terminals will have sinusoidal waveform (absence of higher harmonics) – this is imply the generator voltage. The receiver current waveform will already include harmonic components – a non-linear receiver often takes current only in specified moments of the total sinusoid period (for example, maximum current can take place at the voltage sinusoid peaks).

However, the receiver does not generate these current harmonics, it simply takes current in alternating or discontinuous way. All the energy is supplied solely by the generator. In the next step, we may modify the circuit by introducing some impedance between the generator and the receiver. Such impedance represents the resistance of cabling, transformer winding, etc.

Measurements of voltage and current harmonics will give slightly different results. What will change? Small voltage harmonics will appear, and in addition current frequency spectrum will slightly change.

When analysing the voltage waveform on the receiver, one could notice that original sinusoidal waveform was slightly distorted. If the receiver took current mainly at voltage peaks, it would have visibly flattened tops. Large current taken at such moments results in larger voltage drops on the system impedance. A part of the ideal sinusoidal voltage is now dropped on this impedance. A change in the current spectrum is a result of slightly different waveform of voltage supplied to the receiver.

The example described above and "flat tops" of the sinusoid are very frequent in typical systems to which switched-mode power supplies are connected.

5.4.1 Harmonics active power

Decomposing receiver voltage and current to harmonic components enables using more detailed analysis of energy flow between the supplier and the consumer.

We assume that the power quality analyzer is connect between the voltage source and the receiver. Both, supply voltage and current are subjected to FFT, as a result of which we receive the harmonics amplitudes with phase shifts.

It turns out that the knowledge of voltage and current harmonics and of phase shift between these harmonics allows calculating the active power of each harmonic individually:

$$P_h = U_h I_h \cos \varphi_h$$

where:

- P_h – active power of the h-th order harmonic,
- U_h – RMS voltage of the h-th order harmonic,
- I_h – RMS current of the h-th order harmonic,
- φ_h – phase shift angle between the voltage and current harmonics of the h-th order.

When P_h power has positive sign (+), then the dominating source of energy of this harmonics is on the energy supplier's side. When it is negative, the receiver is the dominating source. It must be noted that on the basis of harmonics active powers measured in this way one cannot determine that only one party is the sole source of the harmonics, as the measured value is a resultant of the supplier and the consumer.

Example

When the supplier generates active power of harmonic $P_{hD} = 1 \text{ kW}$, and the consumer "generates" the power of this harmonics equal to $P_{hO} = 100 \text{ W}$, then the resultant power measured at the terminals between the supplier and the consumer is $P_h = P_{hD} - P_{hO} = 0.9 \text{ kW}$.

In a situation presented above, we are dealing with two separate sources of energy flow. Unfortunately, basing on such measurement, we cannot directly indicate the actual distribution.

In real systems, determination of the dominant source is often sufficient. By grouping the harmonic components with plus signs, we receive a set of power values which are responsible for the energy flow from the source to the receiver, which is the useful energy.

On the other hand, the set of harmonics active power values with negative signs makes up this part of energy which does not play any useful role and is "returned" back to the distribution system.

By adding all active harmonics power values we receive the receiver active power. Hence, we can notice that there are at least two alternative active power measurement methods.

The first method involves calculation of average active power instantaneous value, which is calculated on the basis of successive voltage and current:

$$P = \frac{1}{M} \sum_{i=1}^M U_i I_i$$

where U_i is a successive voltage sample, I_i is a successive current sample and M is the number of samples in the measuring window.

The second method involves adding individual harmonics active power values which are obtained by the FFT decomposition:

$$P = \sum_n U_n I_n \cos \varphi_n$$

5.4.2 Harmonics reactive power

The harmonics reactive power values may be calculated in a similar manner as the active power values:

$$Q_h = U_h I_h \sin \varphi_h$$

Knowledge of reactive power harmonics is valuable information used in the development of reactive parallel compensators of reactive power. Such compensators consist of LC branches tuned to a specific frequency harmonics.

The sign of the individual power components indicates the character of load for this component.

When the sign is positive (+), then the character is inductive, and when it is negative (-), it is capacitive.

Passive source current may be reduced to zero when the following condition is met for each harmonic²:

$$B_h + B_{kh} = 0$$

where:

B_h – receiver susceptance for the h -th harmonic,

B_{kh} – parallel compensator susceptance for the h -th harmonic.

As the compensator complexity grows proportionally to the number of harmonics subjected to compensation, usually only the fundamental component is compensated and maximum a few higher harmonics with the largest values. However, the compensation of the fundamental component may considerably improve the power factor and may be sufficient.

5.4.3 Harmonics in three-phase systems

In three-phase systems, harmonics of given orders have a particular feature which is shown in the table below:

Order	1	2	3	4	5	6	7	8	9
Frequency [Hz]	50	100	150	200	250	300	350	400	450
Sequence (+ positive, - negative, 0 zero)	+	-	0	+	-	0	+	-	0

"Sequence" line refers to the symmetrical components method which allows to decompose any of the three vectors into three sets of vectors: positive, negative and zero sequence (more in section related to unbalance).

For example: Let's assume that a three-phase motor is supplied from a balanced, 4-wire mains (RMS phase-to-neutral voltage values are equal, and angles between the individual fundamental components are 120° each).

"+" sign in the line specifying the sequence for the 1st harmonics means the normal direction of the motor shaft rotation. The voltage harmonics, for which the sign is also "+" cause the torque corresponding with the direction of the fundamental component. The harmonics of the 2nd, 5th, 8th and 11th order are the opposite sequence harmonics, meaning that they generate the torque which counteracts normal motor direction of rotation, which can cause heating, unnecessary energy losses, and reduced efficiency. The last group are the zero sequence components, such as the 3rd, 6th and 9th, which do not generate torque but flowing through the motor winding cause additional heating.

Basing on the data from the table, it is easy to note that the series +, -, 0 is repeated for all successive harmonic orders. The formula which links the sequence with order is very simple, and for 'k' being any integer:

Sequence	Harmonic order
positive "+"	$3k + 1$
negative "-"	$3k - 1$
zero "0"	$3k$

The even order harmonics do not appear when a given waveform is symmetrical in relation to its average value, and this is the case in majority of power supply systems. In a typical situation, the

measured even order harmonics are of minimal value. If we consider this property, it turns out that the group of harmonics with the most undesirable properties is the 3rd, 9th, 15th (zero sequence), and the 5th, 11th, and 17th (negative sequence).

The current harmonics which are multiples of 3 cause additional problems in some systems. In 4-wire systems, they have a very undesirable property of summing up in the neutral conductor. It turns out that, contrary to other order harmonics, in which the sum of instantaneous current values is zeroed, the waveforms of these harmonics are in phase with each other which causes adding of the phase currents in the neutral conductor. This may lead to overheating of this conductor (particularly in the distribution systems where the conductor has a smaller cross-section than the phase conductors, as it was widely practiced until recently). Therefore, in systems with non-linear loads and large current distortions, it is now recommended that the cross section of neutral conductor is larger than that of the phased conductors.

In the delta systems, the harmonics of these orders are not present in the line currents (provided these are balanced systems), but they circulate in the load branches, also causing unnecessary power losses.

The nature of individual harmonics as shown in the table is fully accurate only in three-phase balanced systems. Only in such systems, the fundamental component has the exclusively positive sequence character. In actual systems, with some degree of supply voltage unbalance and the load unbalance, there are non-zero positive and negative sequence components. The measure of such unbalance is so-called unbalance factors. And this is due to this unbalance of the fundamental component and additionally the differences in amplitudes and phases of the higher harmonics, that also these harmonics will have the positive, negative and zero sequence components. The larger the unbalance, the higher the content of remaining components.

IEC 61000-4-30 standard recommends that the harmonic subgroup method is used in power quality analyzers for calculating harmonic components.

5.4.4 Total Harmonic Distortion

Total Harmonic Distortion (THD) is the most widely used measure of waveform distortion. Two versions of this factor are applied in practical use:

- THD_F (THD-F or simply THD) – total harmonic distortion referred to the fundamental component,
- THD_R (THD-R) – total harmonic distortion referred to the RMS value.

In both cases, THD is expressed in percent. Definitions are presented below:

$$THD_F = \frac{\sqrt{\sum_{h=2}^n A_h^2}}{A_1} \times 100\%$$

$$THD_R = \frac{\sqrt{\sum_{h=2}^n A_h^2}}{A_{RMS}} \times 100\%$$

where: A_h – RMS of the h-th order harmonic,
 A_1 – RMS of the fundamental component,
 A_{RMS} – RMS of the waveform.

Limitation of the number of harmonics used to calculate THD is conventional and results mainly from measuring limitations of the device. As the analyzer is capable of measuring the harmonic components up to the 50th order, the harmonics of the 50th or 40th order are used to calculate THD (the user can select either 40th or 50th order as the limit).

Please note that when the waveforms are very distorted, the two definitions presented above will give significantly different results. THD_R cannot exceed 100%, while THD_F has no such limit and may be 200% or more. Such a case may be observed when measuring very distorted current. The voltage harmonic distortion usually does not exceed a few percent (both THD_F and THD_R); e.g. EN 50160 standard defines the limit of 8% (THD_F).

5.4.5 TDD - Total Demand Distortion

Total Demand Distortion is an indicator representing the level of the RMS value of the harmonics in current referenced to the maximum demand current. It is derived from THD, and the value is expressed by the formula:

$$TDD = \frac{\sqrt{\sum_{h=2}^n I_h^2}}{I_L} \times 100\%$$

where: I_h – RMS of the h -th order harmonic,
 I_L – demand current.

Comparing the above formula with the formula for THD currents it is apparent that they differ only by the value of the denominator. The nominator remains unchanged and represents the RMS value of harmonics.

Demand current I_L is the maximum average value of the fundamental component, recorded during the observation period. Usually, the observation period in one week or one month.

To understand the difference between THD and TDD, see the following example. Assume that the fundamental component of the current in the circuit changes between 1000 A and 10 A. The deformation of the current waveform is more or less at the same level over the entire range of variation of the fundamental component and has a level resulting in THD-F of approx. 50%. When a graph of the THD variation in time is generated, it presents more or less constant value of 50% of the entire time interval. Note that despite the fact that in the analyzed period of time, the fundamental component changed 100-fold, the graph of THD provides no basis for conclusions on energy losses in the circuit resulting from the flow of harmonics. A similar graph of the TDD would be similar to the waveform of fundamental current component - maximum TDD values would reach 50%, while the minimum values approx. 0.5%. Thus, TDD reflects the changes in RMS value of harmonics better: if the current reaches the maximum value, TDD value is close to THD, however, if the value of current in the circuit decreases, the TDD also decreases.

To calculate TDD, it is required to determine or calculate I_L current. PQM analyzers offer two methods:

- automatic – I_L current is determined by the application as the maximum recorded mean value of the fundamental current component (in the whole recording range of all the measured current channels). When TDD recording is enabled, the analyzer automatically records the parameters required to calculate its value,
- manual – I_L current is applied by the user (in the application, during the data analysis). TDD values are calculated based on the entered value.

5.4.6 K-Factor

K-Factor, also called the transformer loss factor is a measure used in determining the requirements for power transformers. Higher harmonics in current cause increased heat losses in windings and metal parts of the transformer. The main reasons is the presence of eddy currents generated by current components of higher frequencies and by the skin effect.

The transformer temperature increase is directly proportional to current components squared, the value called K-Factor takes this into account, and the factor is calculated according to the following formula:

$$KFactor = \sum_{h=1}^{50} I_{hr}^2 h^2 = \frac{\sum_{h=1}^{50} I_h^2 h^2}{I_1^2}$$

where: I_{hr} - relative value of the h -th order harmonic component (in relation to the fundamental component),
 I_h - amplitude of the h -th order of current harmonic component,
 I_1 - amplitude of current fundamental component,
 h – harmonic order.

In case of this parameter, the higher harmonics are much more important than the lower – each harmonic component is multiplied by its order squared.

K-Factor is useful when defining the requirements for transformers which must work in conditions of significant current distortion. It is assumed that the transformer, which works in conditions, where $K = x$, will generate x times more heat than at purely sinusoidal current ($K=1$).

5.5 Interharmonics

Interharmonics are components of the frequency spectrum for voltage or current with a frequency that is not a multiple of the fundamental frequency network (50 or 60 Hz). The cause of interharmonics may be e.g. asynchronous processes and transient states related to connection processes, frequency converters that generate the output frequency different from the frequency of the power supplying mains and introduce into the system spectral interharmonics, arc furnaces, induction motors and drives with variable load. Ripple control signals, i.e. signals with defined frequencies generated in control systems and introduced into mains should also be considered as interharmonics components. Interharmonics at frequencies lower than the mains fundamental frequency are called subharmonic components.

The effects of interharmonics may include:

- increased losses in mechanical motors, temperature rise; subharmonics are particularly harmful elements, as the power loss increases with decreasing frequency,
- flicker; also in this case subharmonics have particularly adverse effects. For example subharmonic with 8.8Hz frequency causes the modulation of mains voltage within the range, where human eye is most sensitive to this phenomenon (see also sec. 5.2),
- low-frequency oscillations in mechanical systems,
- interferences in the operation of control and protection systems,
- telecommunications and acoustic interferences,
- saturation of magnetic cores by subharmonic components (e.g. transformers, motors, etc.).

The interaction of higher harmonics and interharmonics may also lead to unexpected phenomena such as beating-in at low frequencies. For example, ninth harmonic (450 Hz) with interharmonic of 460 Hz frequency generates the effect of beating-in at the frequency of 10 Hz, despite the fact that in this frequency spectrum a component of this frequency is not present. Human eye is very sensitive in this frequency range, and the interaction may lead to a significant flicker effect. 230 V/50 Hz voltage waveform for this case is presented in Fig. 49 (significantly higher level of the interharmonic was assumed in this case to illustrate the effect better).

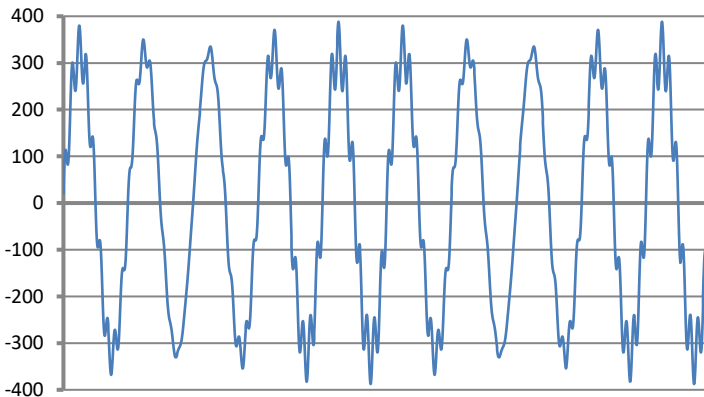

Fig. 49. The effect of 9th harmonic interaction (450 Hz, 10% U_{nom}) and interharmonic 460 Hz (10% U_{nom}). The apparent change in the voltage envelope with frequency of 10Hz that may cause flicker ($U_{nom} = 230$ V RMS, 50 Hz).

5.5.1 Total Interharmonic Distortion

A measure of the total presence of interharmonics is the TID, which is defined as:

$$TID_F = \frac{\sqrt{\sum_{ih=0}^n A_{ih}^2}}{A_1} \times 100\%$$

$$TID_R = \frac{\sqrt{\sum_{ih=0}^n A_{ih}^2}}{A_{RMS}} \times 100\%$$

where: TID_F - Total Interharmonic Distortion related to fundamental component,
 TID_R - Total Interharmonic Distortion related to RMS value,
 A_{ih} - RMS of ih -th interharmonic (interharmonic sub-group),
 A_1 - RMS of the fundamental component,
 A_{RMS} - RMS of the waveform,
 n - in case of analyzers described in this manual it is equal to 50.

TID is the ratio of the RMS value of all interharmonics to the fundamental component (for TID_F) or RMS value (for TID_R).

Acceptable level of interharmonic interferences in voltage is a matter discussed among professionals involved power quality matters. Some sources state that the overall rate of voltage interharmonics distortion should not exceed 0.2%.

5.6 Mains signalling

Ripple control signals are signals entered into the electricity network in order to control and check of remote control devices connected to the same network. In addition to the transmission of electricity, a distribution network is in this case used as a transmission medium for communication between devices. EN 50160 standard distinguishes three types of signals:

- *Ripple control signals* from 110 to 3000 Hz,
- *Power Line Carrier Communication*, *PLCC*, frequency range from 3 to 148.5 kHz,
- *Marking signals*, short transients imposed at a specific point on the voltage waveform.

Since the introduction of such signals to the power supply may have negative consequences for some devices, similarly to the effect of harmonics or interharmonics, EN 50160 standard defined limits for the 3-second mean values of such signals, as shown in Fig. 51. During the measurement, 99% of average 3-second control signals values must be below the specified limit.

Low frequency signals (up to 3 kHz) are used for switching on/off the loads, filters and protection devices. One application is to control the street lighting or (in some countries) remote controlling of HVAC devices. Often, this kind of signals are used for customers using two types of energy tariff (e.g. when using a cheaper night tariff, the energy supplier automatically disables selected loads). This type of communication is usually unidirectional. Due to the low attenuation features of the distribution network at this frequency range (attenuation increases with increasing frequency), communication using this method allows users to achieve the greatest range of transmission (even hundreds of kilometres). During the transmission control signal is transmitted in several packages and repeated at specified intervals. The period during which the signal is active may be quite long, e.g. for 2 seconds signal is on and for 2 seconds it is off - this sequence is repeated several times. There are cases when this type of transmission results in flicker. An example of this type of transmission is shown in Fig. 50.

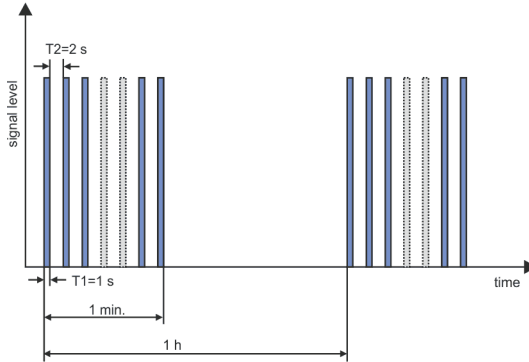

Fig. 50. An example of low-frequency signal transmission.

Higher transmission frequencies (and hence, higher bit rates) are typical for PLCC communication. This type of communication uses modulation of amplitude or carrier frequency (or other modulation method). Modern methods use complex algorithms to process signals in order to achieve the highest resistance to interference and highest bit rate (transmission speed). PLCC transmission continuously gains popularity and its application range increases. The communication between network points may be bidirectional. The concept of so-called *smart grid* is based on PLCC, which is one of the main methods of communication between energy meters and central points. The main application areas include: telemetry, optimization of power consumption, remote control of loads. Attenuation of the distribution network limits the maximum transmission range. Maximum range may reach a few km, while there is a strong correlation between the type of modulation, bit rate and achieved distances.

At the same time, standardization works are in progress to use of higher frequencies (above 148.5 kHz to tens of MHz) for the purpose of short-distance data transmission.

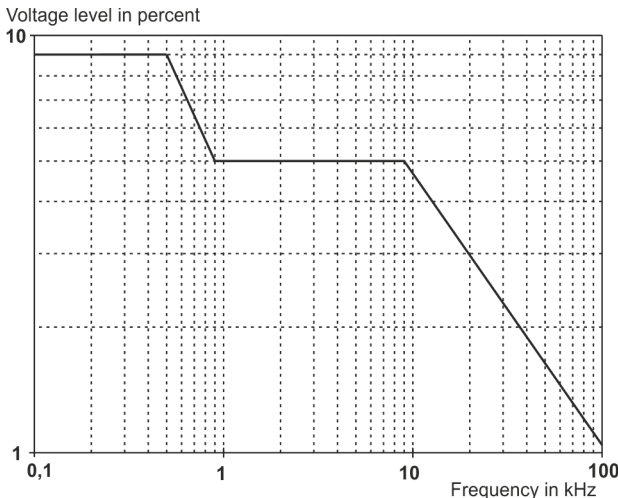

Fig. 51. Allowable levels of mains signalling according to EN 50160 standard.

In networks with substantial contents of harmonics, where additional filters are used for reducing interferences, the consequences of their use may also include additional attenuation of the frequency range used for the signalling. Both the presence of filters and a high level of harmonics and interharmonics may significantly reduce the possibility of efficient use of the distribution network for communication with low-frequency or PLCC methods.

IEC 61000-4-30 standard provides the following measurement method of ripple control signals:

- if the frequency of a control signal is a multiple of 5 Hz (i.e. it covers exactly the output line of FFT frequency analysis), then only this single line is taken into account along with its RMS,
- if the frequency is not a multiple of 5 Hz, then RMS value is calculated from four adjacent frequency lines of FFT.

5.7 Unbalance

Unbalance is a concept associated with the three-phase systems and may refer to:

- supply voltage unbalance,
- load current unbalance,
- receiver unbalance.

In three-phase systems, the unbalance of voltage (current) occurs when values of three component voltages (currents) are different and/or the angles between individual phases are not equal to 120° .

The receiver unbalance occurs when impedance values of individual receiver branches are not equal.

These phenomena are particularly dangerous for three-phase motors, in which even a slight voltage unbalance can cause current unbalance that is many times larger. In such situation, the motor torque is reduced, heat losses in windings increase, and mechanical wear is faster. The unbalance also has an unfavorable effect on power supply transformers.

The most frequent reason of unbalance is uneven load on individual phases. A good example is connecting to three-phase systems of large one-phase loads, such as railway traction motors.

The analyzer is capable of measuring the voltage and current unbalance with a symmetrical components method. This method is based on the assumption that each set of three unbalanced vectors can be resolved to three groups of vectors: positive sequence, negative sequence and zero sequence.

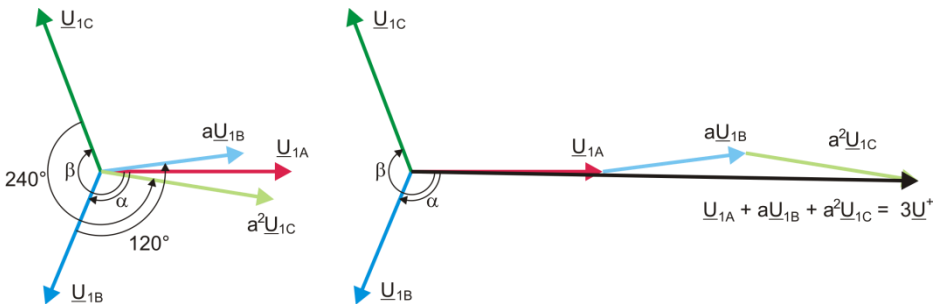

Fig. 52. Example of determining positive sequence component.

Presented example shows the method for calculating voltage positive sequence component. By definition:

$$\underline{U}^+ = \frac{1}{3}(\underline{U}_{1A} + a\underline{U}_{1B} + a^2\underline{U}_{1C})$$

where: \underline{U}^+ is a vector of positive sequence,

where \underline{U}_{1A} , \underline{U}_{1B} , \underline{U}_{1C} are vectors of fundamental components of phase voltages U_A , U_B , U_C

$$a = 1e^{j120^\circ} = -\frac{1}{2} + \frac{\sqrt{3}}{2}j$$

$$a^2 = 1e^{j240^\circ} = -\frac{1}{2} - \frac{\sqrt{3}}{2}j$$

Fig. 52 shows graphical method of determining this component. As we can see from the definition, the vector of positive-sequence component equals one third of the sum of the components: \underline{U}_{1A} , $a\underline{U}_{1B}$, $a^2\underline{U}_{1C}$. Operator a and a^2 are unit vectors with angles of 120° and 240° . The procedure is as follow: turn voltage vector \underline{U}_{1B} by 120° counter-clockwise (multiply by a) and add to vector \underline{U}_{1A} . Then, turn the vector \underline{U}_{1C} by 240° and add to the previous sum of vectors. The result is vector $3\underline{U}^+$. Vector \underline{U}^+ is the desired symmetrical positive sequence component. Note that in case of perfect symmetry (equal voltages and angles) the positive sequence component is equal to the value of the phase-to-neutral voltages.

The positive sequence component is a measure of similarity of the tested set of three-phase vectors to the symmetrical set of positive sequence vectors.

Similarly, the negative sequence component is a measure of similarity to the symmetrical set of negative sequence vectors.

The zero sequence component exists in the systems in which the sum of three voltages (or currents) is not equal to zero.

A measure of the system unbalance which is widely used in the power generation is the negative sequence and zero sequence unbalance (formulas are for voltage):

$$u_0 = \frac{U_0}{U_1} \cdot 100\%$$

$$u_2 = \frac{U_2}{U_1} \cdot 100\%$$

where: u_0 – unbalance factor for zero sequence,

u_2 – negative sequence unbalance,

U_0 – zero symmetric component,

U_1 – positive sequence symmetrical component,

U_2 – negative sequence symmetrical component.

The most convenient method to calculate the symmetrical components and unbalance is using the complex number calculus. The vectors parameters are amplitude of the voltage (current) fundamental component and its absolute phase shift angle. Both of these values are obtained from FFT.

5.8 Voltage dips, swells and interruptions

Voltage dips, swells and interruptions are network disturbances when the effective voltage (RMS) is significantly different from the nominal value. Each of the three states may be detected by the analyzer when the event detection is activated and when the user defines the threshold values.

Voltage dip is a state during which the RMS voltage is lower than the user-defined voltage dip threshold. The basis for the dip measurement is $U_{RMS(1/2)}$, which is the one period RMS value refreshed every half period.

Definition of dip (acc. to IEC 61000-4-30 standard):

The voltage dip starts at the moment when $U_{RMS(1/2)}$ voltage decreases below the dip threshold value, and ends at the moment when $U_{RMS(1/2)}$ voltage is equal to or greater than the dip threshold value plus the voltage hysteresis.

The dip threshold may be specified at 90% of U_{nom} . During the voltage dip, the analyzer remembers the minimum recorded voltage (this is called the residual voltage U_{res} and is one of the parameters characterizing the dip) and the average voltage value.

Interruption is a state during which $U_{RMS(1/2)}$ voltage is lower than the specified interruption threshold. The interruption threshold is usually set much below the voltage dip level, at approx. 1..10% U_{nom} .

The voltage interruption starts at the moment when $U_{RMS(1/2)}$ voltage decreases below the interruption threshold value, and ends at the moment when $U_{RMS(1/2)}$ voltage is equal to or greater than the interruption threshold value plus the voltage hysteresis.

During the interruption, the analyzer remembers the minimum recorded voltage and the average voltage value.

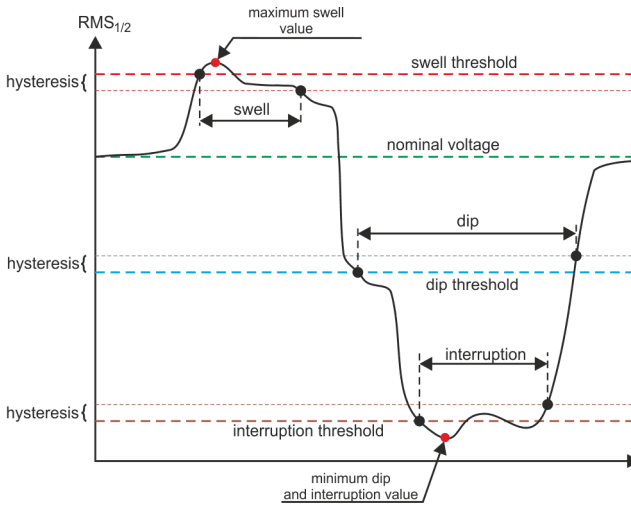

Fig. 53. Voltage swells, dips and interruptions

Voltage swell is a state of increased voltage. The swell threshold is usually set at a level close to 110% of U_{nom} .

Swell starts at the moment when $U_{RMS(1/2)}$ voltage increases above the swell threshold value, and ends at the moment when $U_{RMS(1/2)}$ voltage is equal or below the swell threshold value minus the voltage hysteresis. During the swell, the analyzer remembers the maximum recorded voltage and the average voltage value.

The hysteresis for all three states is the same and it is a user-defined percent of nominal voltage (**Events detection hysteresis** parameter).

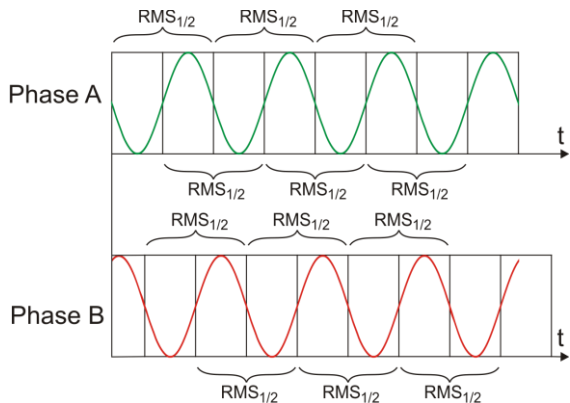

Fig. 54. Determining values of $U_{RMS(1/2)}$

The analyzer remembers the event start and end time (with a half a period accuracy).

The minimum voltage dip, interruption and swell duration is a half of the period.

$U_{\text{RMS}(1/2)}$ values are determined in 1 period during crossing through zero of the fundamental voltage component - they are refreshed every half-period, independently for each voltage channel. It means that these values will be obtained at different times for different channels. Fig. 52 shows the method for determining $\text{RMS}_{1/2}$ values at two voltage phases. Information on crossing zero of the fundamental component is obtained by FFT.

5.9 Rapid Voltage Changes (RVC)

Definition of Rapid Voltage Changes (RVC): a sudden change in RMS voltage between two stable states in which the RMS voltage does not exceed the dip and swell thresholds.

In simple terms, it may be stated that RVC have some similarities in nature to dips and swells, but of smaller amplitude. Events of this type usually results from changes in loads of power grid, switching effects or failures.

In both of these types of events, the same source data is used - the RMS values of 1-period, refreshed every half-period and indicated by symbol $U_{\text{RMS}(1/2)}$.

The algorithm of RVC is as follows (see Fig. 55):

- The arithmetic mean value is calculated from the preceding 100/120 values of $U_{\text{RMS}(1/2)}$ (approx. 1 s). The mean value is then updated with each new value $U_{\text{RMS}(1/2)}$. The figure shows it as the continuous curve in red.
- If all of 100/120 previous values $U_{\text{RMS}(1/2)}$ are within the area defined by the mean value, extended from both sides with the hysteresis (two red dotted lines in the figure), then it is considered that the voltage is in the "stable" condition.
- When the "stable" condition is not met, i.e. when one or more $U_{\text{RMS}(1/2)}$ values exceeds the permitted range, then RVC event starts (blue areas in the figure). At the same, the hysteresis is applied to the threshold (permissible range of changes is reduced by the hysteresis) and signal changes specifying the voltage "stability" are blocked for the duration of 100/120 network half-periods. For this reason, the RVC events will not be detected more than once per approx. 1 second.

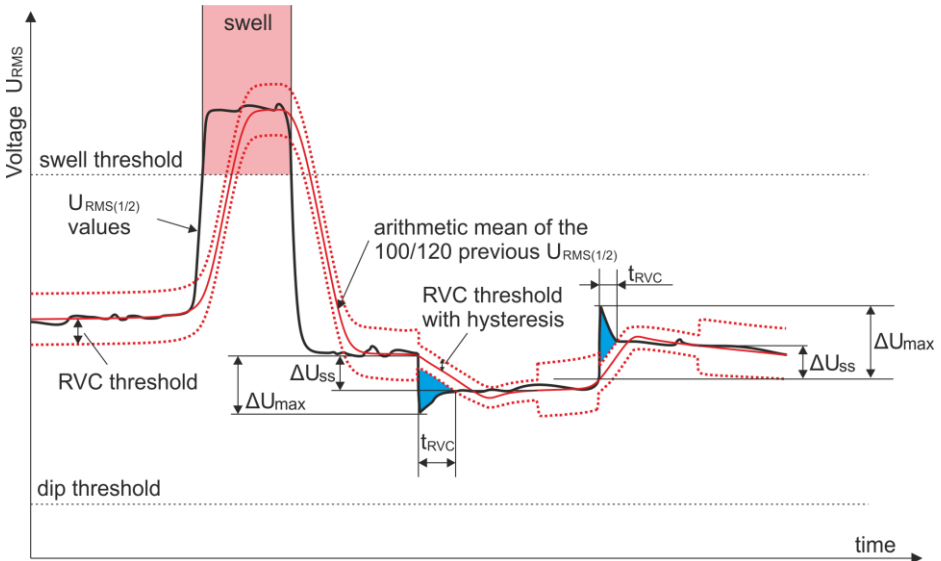

Fig. 55. Rapid Voltage Changes (RVC) - example.

- Once again the voltage "stability" condition is met, RVC event is completed. The end time of the event is retracted by 100/120 half-periods in relation to the change of stability signal "unstable" to "stable" state.
- If during the RVC event, a voltage dip or swell occurs, then such RVC event is dropped. The figure shows voltage increase - this event cancels the potential RVC events, if they are detected at that period.

Specific parameters for Rapid Voltage Changes include:

- ΔU_{SS} (steady-state) – it is the difference between the mean ("stable") voltages before and after RVC event.
- ΔU_{MAX} – is the maximum deviation of $U_{RMS(1/2)}$ value from the mean value during the event. ΔU_{MAX} is usually greater than ΔU_{SS} .
- Duration of RVC (in Fig. 55 marked as " t_{RVC} "). The shortest possible RVC event has a length of one half-cycle of the network.

At the time of publication of this manual, there are no international standards on permissible values of rapid voltage changes in electricity grids. European standard EN 50160 (edition of 2010) does not provide prescriptive requirements for this type of events. Some countries have their own criteria for RVC, e.g. an event is detected above the threshold of 5% of U_{NOM} (detected events have $\Delta U_{MAX} > 5\%$ of U_{NOM}). Sometimes the number of RVC events per day is established.

5.10 Transients and overvoltages

Transients are unwanted, rapid and short-term disturbances in the mains. They are accompanied by a sudden change in voltage and current. The duration of a disturbance is typically from a few nanoseconds to a few milliseconds. Often, terms used to describe them include: overvoltages, voltage peaks, surges, impulse waves, oscillations. But these terms narrow their meaning. Transient is a disturbance in signal over the time, and as such, its meaning includes all of the above terms. It may be classified in terms of duration and rise, amplitude, frequency spectrum, transmitted energy, source, etc. The most dangerous for electrical devices are transients that cause a significant voltage

5 Power quality - a guide

increase in the supply line (surges). Due to the source, the transients are often divided into the following groups:

- lightning surges - caused by atmospheric discharges,
- oscillating transients caused most often by switching capacitor banks,
- other switching transients (including ferroresonance).

Surges caused by atmospheric discharges may have destructive effects due to the very high energy triggered during the discharge. Most of surges of this type observed in networks, result from voltage induced by close but not direct lightning stroke. In the area of lightning stroke, a very strong electromagnetic field is generated and long overhead/underground lines induce high voltage that penetrate into the distribution network. These surges have pulse nature with rise time on the order of microseconds. An example of the lightning impulse recorded by PQM-703 analyzer, with amplitude of approx. 6.6 kV is shown in Fig. 56.

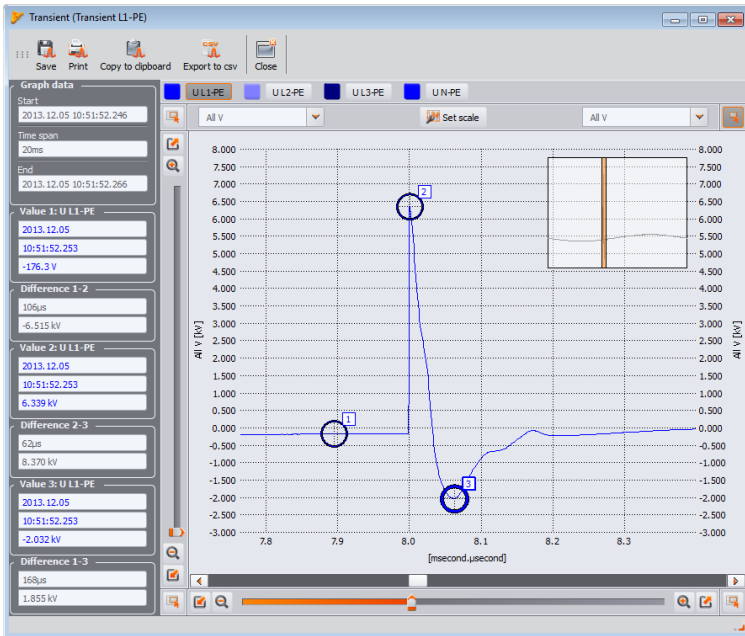

Fig. 56. Example of lightning surge.

Tests of ICT devices carried out before introducing them into markets, include immunity tests for simulated lightning surges. AC power connections are tested with ± 2 kV pulses applied between power lines and grounding lines, and ± 1 kV pulses applied directly between power supply lines. Standardized pulse has voltage rise time of $1.2 \mu\text{s}$ and voltage fall time of $50 \mu\text{s}$. For the measuring devices that may be connected directly to distribution networks at the distribution boards or at LV transformers, authorities defined a measurement category (overvoltage category), which informs about the device protection level against surges. For example, to be included into measurement category IV 600 V (the category of PQM-702 and PQM-703 analyzers), the devices must be immune to impulses of $1.2 \mu\text{s}/50 \mu\text{s}$ with 8 kV amplitude, applied directly between test terminals at source impedance of 2Ω . Peak current during surge may be therefore equal to 4 kA.

The main protection measures against such surges include the circuits limiting the maximum voltage such as gas discharge tubes (GDTs) and varistors. Their construction must ensure receiving impact energy and limiting voltage penetrating the device circuits to a safe level.

Transients caused by switching compensation capacitance, as opposed to lightning strokes, have their source within the distribution network. The compensation is used to improve the power factor and efficiency of energy transfer to the load. At the moment of switching on, a capacitor is a short circuit for the network, thus initially there is a sudden voltage drop almost to zero, followed by fast recovery and an overshoot when voltage much higher than the nominal is reached (usually it does not exceed the double value of peak voltage in standard conditions), and then the disturbance is suppressed in oscillatory way. The oscillating nature of the disturbance is caused by the interaction of the capacitor capacitance with network inductance and resulting resonance. The oscillation frequency is usually around a few hundred Hz. The resistance in the circuit results in gradual suppression of these oscillations. The whole transient usually lasts no longer than a few - few dozen milliseconds. An example of such a transient is shown in Fig. 57.

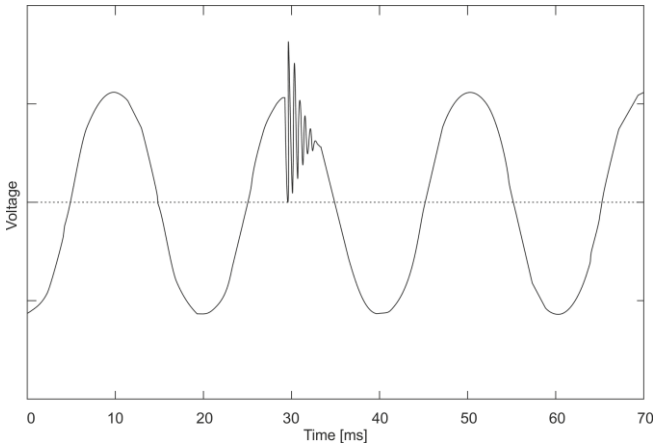

Fig. 57. An example of a transient after switching capacitor banks.

Apart from the causes listed above, transients in networks are generated by switching on and off capacitive loads, inductive loads, by tripping protection devices (fuses) and by short-circuits. Switching on loads (circuits) connected to the transformer windings, often leads to ferroresonance, which is an oscillating transient caused by resonance between the capacitances in the circuit and by the non-linear inductance of transformer ferromagnetic core. Disconnection of inductive loads is often accompanied by the sparking on contacts. The voltage generated at the switch contacts exceeds boundary voltage of the dielectric and spark-over occurs, which may be repeated, until the gap is too big for breakdown.

Transients may also be propagated in different ways between network segments, e.g. lightning stroke in a MV network can partially penetrate through the transformer to a LV sub-network. Attenuation properties of the transformer usually significantly reduce the amplitude of the surge, as well as change its timing parameters.

5.11 CBEMA and ANSI curves

CBEMA curve was first proposed in the 70's of the last century by the organization that gave the curve its name - *Computer and Business Equipment Manufacturers Association* (now *Information Technology Industry*), which associated manufacturers of computer and office equipment. The curve was developed as a guide in the construction of power supply adapters and at the beginning it was a graph showing the tolerance of equipment to the size and duration of the disturbances in the power grid. Later, the curve was used to design equipment sensitive to voltage fluctuations as the reference range in which the equipment must operate properly. Finally the curve began

5 Power quality - a guide

to be widely used in the analyses of power-supply quality in terms of disturbances such as swells, dips, interruptions.

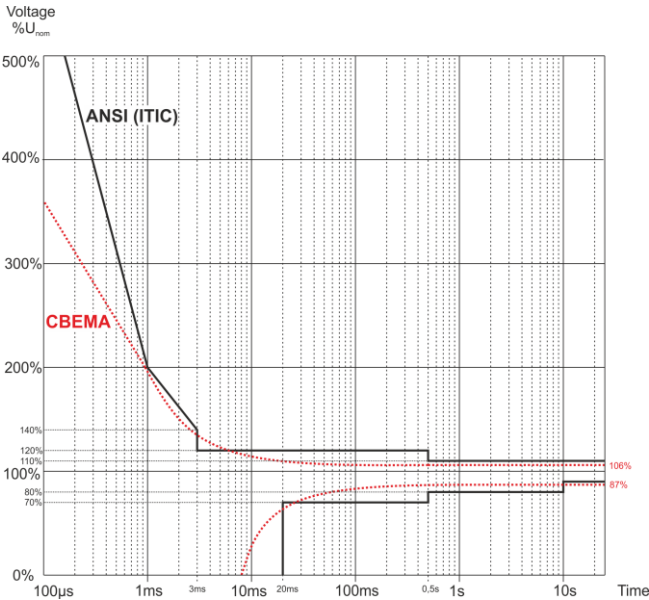

Fig. 58. Voltage tolerance curves: ANSI (ITIC) and CBEMA.

The vertical axis of the graph presents voltage in percent of the nominal value, whereas the horizontal axis presents time (in logarithmic scale). The middle part of the graph (between curves) represents the area of the correct operation of the device. The area above represents high voltage conditions that may damage the device or trigger over-voltage protection, while the area under the curves represents a situation of low voltage in mains, which may disconnect the power supply or temporary power shortage resulting in incorrect operation of the equipment.

As shown in the graph, there is a relationship between the voltage value and the duration of the disturbance. For example, voltage swell of 200% U_{NOM} and with duration of 1 ms, in typical cases, does not result in failure or malfunctioning (point between curves), but an interference of such amplitude, which lasts for half-period of the mains may have very adverse effects (the point above two curves). Generally it is accepted that in a typical situation, events occurring in the power grid when it comes to the value of the mains voltage, should fit in the middle area of the graph (between curves) and then they should not lead to malfunction or damage to the connected equipment. Equipment manufacturers (especially power adapters) often use this pattern while designing their products, in order to ensure their reliable operation and maintaining proper output voltage. Note, however, that the curve represents typical cases and cannot be a guarantee of correct operation for each device, as tolerance for interferences is very different.

ITIC curve is the successor of the CBEMA curve developed by ITI in 1994, and later modified to its present form in 2000. This curve has the form of two broken lines and is also known as ANSI curve, as it was adapted by ANSI (*American National Standards Institute*). Both curves are presented in Fig. 58.

Sonel Analysis software provides the ability to modify the characteristic points of the curves allowing user to adjust them to individual requirements.

5.12 Averaging the measurement results

Mains monitoring over a longer period means that a significant amount of data needs to be collected. To ensure that such data analysis is possible at all, it is necessary to introduce the mechanisms for reducing data size to the values acceptable by both, people and machines.

Let us take the example of EN 50160 compliant power quality measurements. The basic mains test period is one week. If all 200-millisecond RMS values were to be remembered, we would get 3.024 million measurements. Processing this amount of data may be time-consuming and difficult.

Therefore, the averaging concept has been introduced which involves recording one value per a specified time interval for the analysis purposes. For the EN 50160 standard, such time interval is 10 minutes. In such case, the analyzer calculates an average 10-minute value basing on about 3000 of 200-millisecond values (approximately, as in reality the conventional 200-millisecond value is 10/12-period value synchronized with the mains frequency). Each average voltage value is recorded every 10 minutes which gives "only" 1008 measurement results.

Fig. 59 presents the method according to which the analyzer determines the average values at averaging intervals equal to or greater than 10 seconds with the 10-minute averaging time. This method meets the requirements for a Class A of IEC 61000-4-30 standard.

Average values are synchronized with a real time clock as follows. When the clock counts another integer multiple of the averaging period, two processes occur:

- current 10/12-cycle interval (k -th measurement in Fig. 59) is assigned as the last in the aggregation interval (x),
- simultaneously the first 10/12-cycle interval is started for the next averaging period ($x + 1$).

Such a resynchronization method generates *Overlap 1* (see Fig. 59). The data from this area are processed twice, as each of the 10/12-cycle interval is analyzed independently. The aim of this kind of resynchronization is to ensure that the two analyzers of Class A, connected to the same system, and synchronized with UTC, will give the same results. In the analyzers here described in this manual, the resynchronization of intervals according to the method described above is performed for averaging times: 10 s, 15 s, 30 s, 1 min, 3 min, 5 min, 10 min, 15 min, 30 min, 60 min, 120 min.

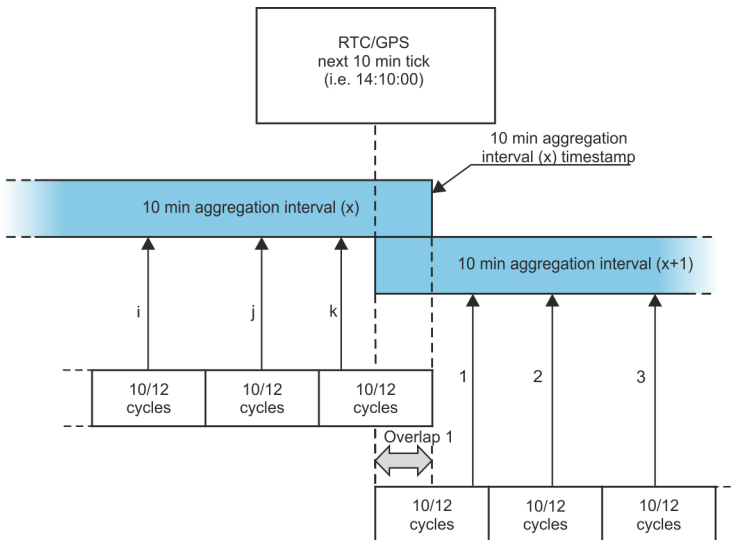
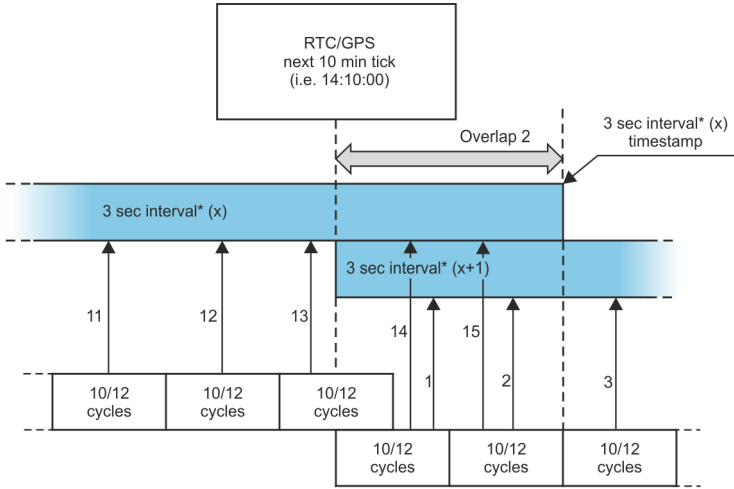

Fig. 59. Determining the averaging intervals longer than 10 seconds (with the 10-minute averaging).



(* actually it is a 150/180 cycles time interval

Fig. 60. Determining the averaging intervals shorter than 10 seconds (with the 3-second averaging).

Averaging with times less than 10 seconds is somewhat different. Although, they are all expressed in time units (200 ms, 1 s, 3 s, 5 s), in reality they are measured in multiples of the mains period. For example, selecting 3-second averaging period means averaging in the time equal to 150/180 mains cycles (fifteen 10/12-cycle measurements).

The method of determining average values for such periods is shown in Fig. 60. Also in this case the resynchronization of 10/12-cycle intervals, but it is always done using clock time of 10 minutes. When the clock counts another integer multiple of the 10-min. period, another aggregation interval is resynchronized and the next interval is started; the aggregation interval (x) is terminated normally, until the specified number of 10/12-cycle windows are gathered (e.g. for 3-second averaging, always 15 intervals are gathered). The re-synchronization results in generating *Overlap 2* (see Fig. 60), where data from two aggregation intervals are simultaneously processed ((x)-interval ends, (x+1)-interval starts). The size of the overlap depends on fluctuations in the mains frequency. The time stamp corresponds to the end of the aggregation interval.

Averaging of measurement results leads to the loss of extreme values (smoothing of results). In cases when the information about limit values of the measured parameter is important, the user may use the option of measuring the minimum, maximum values in the averaging period. If a given parameter is measured in the 10/12-cycle time, the minimum and maximum value is respectively the smallest and the largest 10/12-cycle value measured in a given averaging interval. On the other hand, the instantaneous value is the last 10/12-cycle value in this averaging interval.

In case of RMS current and voltage, the method of searching for minimum and maximum values is more flexible and it is controlled by **MIN/MAX CALCULATION PERIOD** parameter. The user may choose from the following options: half period, 200 ms, 1 s, 3 s and 5 s. If the half-period option is selected, the minimum and maximum values will be searched for with the highest sensitivity – up to $U_{RMS (1/2)}$. As this time is increasing, additional smoothing is being introduced; for example, with 5 seconds, first a 5-second average value is calculated which is then used to search for the minimum and maximum values. This gives a lower sensitivity to instantaneous changes of the measured value.

Note: similarly to the averaging times shorter than 10 seconds, the 200 ms, 1 s, 3 s and 5 s times are actually the multiples of the mains period - 10/12, 50/60, 150/180 and 250/300 mains cycles, respectively.

Selecting the right averaging time is not easy. To a large extent it depends on the type of disturbance in the system and the user's expectations for the final data analysis. A frequent situation is that we know only that there is a problem in the mains, and the measurements with the analyzer will only help us identify the cause. In this situation it is better to use shorter averaging times (e.g. 10 seconds), and activate the recording of minimum and maximum values (for the voltages and currents it is advisable in such situation to set the shortest possible time for determining the maximum and minimum value, i.e. half-period). Short time averaging will give more precise diagrams of changes of parameters over time, and minimums and maximums will be detected and recorded. Recording with short averaging times is performed mostly during a limited time, primarily due to rapid growth of data; the aim of such recording is identifying the possible cause of a problem, and not a long-term analysis.

Recording with a short averaging time may be sufficient to evaluate the performance of the mains and disturbances in it. However, equally detailed information can probably also be obtained with longer times (in minutes) but with activated recording of minimum and maximum values and event detection. An important advantage in this situation that the volume of recorded data is much smaller which means faster data retrieval and analysis.

On the other hand, the power quality tests are usually made according to the EN 50160. In this case, the analysis is carried out over a longer period of time (e.g. 7 days), and therefore the chosen averaging time is also long - 10 minutes.

Please note that there is no single best setting for both, the averaging time and other parameters or event thresholds. Each mains system is different and so are the goals of the mains tests. Therefore, the optimal configuration of the analyzer may require several approaches and will also depend on the experience of the operator.

6 Technical data

- Specifications are subject to change without prior notice. Recent revisions of technical documentation are available at www.sonel.pl.
- Basic uncertainty is the uncertainty of a measurement instrument at reference conditions specified Tab. 6.
- Provided uncertainties apply to the analyzer without additional transformers and probes.
- Abbreviations:
 - m.v. - reference measured value,
 - U_{NOM} – nominal voltage,
 - I_{NOM} – nominal current (probes),
 - RMS – root mean square value,
 - n – harmonic order,
 - s.d. – significant digits (or significant figures) – in reference to resolution of measurement result, the value is recorded with the given number of significant digits, e.g. resolution for 230 V with 4 s.d. will be 0,1 V (notation 230,0 V); resolution for 5 A with 4 s.d. will be 0,001 A (notation 5,000 A).
 - δ_{ph} – additional uncertainty caused by the error of phase measurement between the voltage and current harmonics.

6.1 Inputs

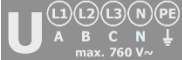
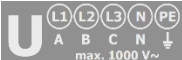
Voltage input terminals	
Number of inputs	5 (L1/A, L2/B, L3/C, N, PE (ground)) - 4 measuring channels
Maximum input voltage (referred to ground)	$U_{L-N} = 760 V_{RMS}$ $(U_{L-L MAX} = 1520 V \text{ for } U_{L-PE MAX} = 760 V)$ 40...70 Hz or DC 
Measurement category (depending on version – the rating is on the front sticker)	CAT IV 600 V / CAT III 760 V (up to 2000 m) CAT IV 300 V / CAT III 600 V / CAT II 760 V (2000 m up to 4000 m)
	$U_{L-N} = 1000 V_{RMS}$ $(U_{L-L MAX} = 2000 V \text{ for } U_{L-PE MAX} = 1000 V)$ 40...70 Hz or DC 
	CAT IV 600 V / CAT III 1000 V (up to 2000 m) CAT IV 300 V / CAT III 600 V / CAT II 1000 V (2000 m up to 4000 m)
Peak input voltage (no ADC clamping)	$\pm 1500 V$ (high voltage range) $\pm 450 V$ (low voltage range)
Analog pass band (-3dB)	20 kHz
Transducers	defined by user
Impedance of measurement inputs	10 M Ω (differential)
CMRR	>70 dB (50 Hz)

Current input terminals	
Number of inputs	4 (3 phases + neutral) not galvanically isolated
Nominal input voltage (CT probes)	1 V _{RMS}
Peak input voltage (CT probes)	±3.6 V
Nominal input voltage (flexible probes)	0.125 V _{RMS}
Peak input voltage (flexible probes)	±0.45 V
Maximum current probes input voltage referred to earth	5 V _{RMS}
Analog pass band (-3dB)	20 kHz
Input Impedance	CT probes circuit: 100 kΩ Flexible probes circuit: 12.4 kΩ
Measurement range (without transformers)	Flexible probes F-1(A)/F-2(A)/F-3(A): 1..3000 A (±10 kA peak, 50 Hz) Flexible probes F-2AHD/F-3AHD: 1..3000 A (±10 kA peak, 50 Hz) Flexible probes F-1A6/F-2A6/F-3A6: 1..6000 A (±20 kA peak, 50 Hz) Flexible probes F-1A1/F-2A1/F-3A1: 1..1500 A (±5 kA peak, 50 Hz) CT probes C-4(A), C-5A: 1..1000 A (±3600 A peak) CT probes C-6(A): 0.01..10 A (±36 A peak) CT probes C-7(A): 0..100 A (±360 A peak)
Transducers	defined by user
CMRR	60 dB (50 Hz)

6.2 Sampling and RTC

Sampling and RTC	
A/D converter	16-bit
Sampling rate	10.24 kHz for 50 Hz and 60 Hz Simultaneous sampling in all channels
Samples per period	204.8 for 50 Hz; 170.67 for 60 Hz
PLL synchronization	40..70 Hz
Reference channel for PLL	L1/A (default; possibility to switch to other channels)
Real-time clock	±3.5 ppm max (approx. ±9 sec./month) in the temperature range of -20°C...+55°C

6.3 Transient module **PQM-703** **PQM-711**

Transient detection module	
Number of input channels	4 (L1/A-PE, L2/B-PE, L3/C-PE, N-PE)
Maximum input voltage	760 V _{RMS} / 1000 V _{RMS} (depending on version – see rating on the front sticker)
Peak input voltage	±8000 V
Analog pass band (-3dB)	2.5 MHz
A/D converter	4-channel, 12-bit, simultaneous sampling in all channels
Sampling frequency	10 MHz, 5 MHz, 1 MHz, 500 kHz, 100 kHz (user selectable)
Waveform recording time	from 2000 to 20000 samples (from 200 μs to 200 ms, depending on settings)
Pretrigger time	from 10% to 90% of the recording time
Detection method	- amplitude (50 V...5000 V) - slew rate (dV/dt; from 100 V/500 μs to 100 V/5 μs)
Inactivity time after detection	3 s

6.4 Measured parameters - accuracy, resolution and ranges

6.4.1 Reference conditions

Tab. 6. Reference conditions.

Reference conditions	
Ambient temperature	0°C...+45°C (see also 6.4.2)
Relative Humidity	40...60%
Voltage unbalance	≤ 0.1% (applies only to 3-phase systems)
Continuous, external magnetic field	≤ 40 A/m (d.c.) ≤ 3A / m (a.c.) for 50/60 Hz frequency
DC voltage and DC current	none
Waveforms	sinusoidal
Frequency	50 Hz ±0.2% or 60 Hz ±0.2%

6.4.2 The measurement uncertainty due to ambient temperature

Basic uncertainty given in technical specifications is guaranteed for the ambient temperature range of 0°C...+45°C. Outside this range, use an additional multiplier (M), which increases the specified basic uncertainty to the actual measurement uncertainty. Fig. 61 shows a graph of M multiplier, depending on the ambient temperature within nominal operating temperatures. The multiplier has a value of 1.0 in the temperature range of 0°C...+45°C. Above +45°C and up to +55°C, the multiplier rises in linear manner up to 2.0. Below 0°C (down to -20°C), the multiplier rises in linear manner up to 1.8.

Example: Basic uncertainty for RMS voltage measurement is $\pm 0.1\% U_{nom}$ within ambient temp. range of 0°C...+45°C.

- at -20°C, measurement uncertainty is $\pm 0.18\% U_{nom}$ (multiplier 1.8)
- at -10°C, measurement uncertainty is $\pm 0.14\% U_{nom}$ (multiplier 1.4)
- at 0°C, measurement uncertainty is $\pm 0.1\% U_{nom}$ (multiplier 1.0)
- at +45°C, measurement uncertainty is $\pm 0.1\% U_{nom}$ (multiplier 1.0)
- at +55°C, measurement uncertainty is $\pm 0.2\% U_{nom}$ (multiplier 2.0)

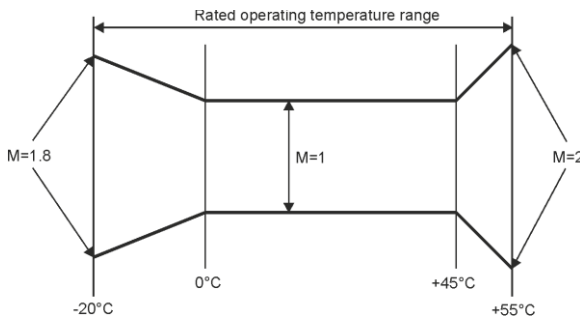

Fig. 61. Basic uncertainty multiplier M as a function of ambient temperature.

6.4.3 Voltage

Voltage	Range and conditions	Resolution	Basic uncertainty
U_{RMS} (AC+DC)	$10\% U_{nom} \leq U_{RMS} \leq 150\% U_{nom}$ for $U_{nom} \geq 64$ V	4 s.d.	$\pm 0.1\% U_{nom}$
Crest Factor	1..10 (1..1.65 for 690 V voltage) for $U_{RMS} \geq 10\% U_{nom}$	0.01	$\pm 5\%$

6.4.4 Current

Current	Range and conditions	Resolution	Basic uncertainty
I _{RMS} (AC+DC)	Input path without probes		
	CT line: 0..1 V (±3.6 V max)	4 s.d.	±0.1% I _{nom}
	flexible probes line: 0..125 mV (±450 mV max)		
	Flexible probes F-1(A)/F-2(A)/F-3(A)		
	0..3000 A (±10 kA max)	4 s.d.	Additional uncertainty ±1% (±2% taking into account additional error due to the position)
	Flexible probes F-2AHD/F-3AHD		
	0..3000 A (±10 kA max)	4 s.d.	Additional uncertainty ±0.5% (±2% taking into account additional error due to the position)
	Flexible probes F-1A6/F-2A6/F-3A6		
	0..6000 A (±20 kA max)	4 s.d.	Additional uncertainty ±1% (±2% taking into account additional error due to the position)
	Flexible probes F-1A1/F-2A1/F-3A1		
	0..1500 A (±5 kA max)	4 s.d.	Additional uncertainty ±1% (±2% taking into account additional error due to the position)
	CT probes C-4(A)		
	0..1000 A (±3600 A max)	4 s.d.	Additional uncertainty 0.1..10 A: ± (3% + 0.1 A) 10 A: ±3% 50 A: ±1.5% 200 A: ±0.75% 1000..1200 A: ±0.5%
CT probes C-5A			
0..1000 A (±3600 A max)	4 s.d.	Additional uncertainty 0.5..100 A: ≤ (1.5% + 1 A) 100..800 A: ≤ 2.5% 800..1000 A AC: ≤ 4% 1000..1400 A DC: ≤ 5%	
CT probes C-6(A)			
0..10 A (±36 A max)	4 s.d.	Additional uncertainty 0.01..0.1 A: ± (3% + 1 mA) 0.1..1 A: ±2.5% 1..12 A: ±1%	
CT probes C-7(A)			
0..100 A (±360 A max)	4 s.d.	Additional uncertainty 0..100 A: ± (0.5% + 0.02 A) (45..65 Hz) 0..100 A: ± (1.0% + 0.04 A) (40..1000 Hz)	
Crest Factor	1..10 (1..3.6 for I _{nom}) for I _{RMS} ≥ 1% I _{nom}	0.01	±5%

6.4.5 Frequency

Frequency	Range and conditions	Resolution	Basic uncertainty
f	40..70 Hz $10\% U_{nom} \leq U_{RMS} \leq 200\% U_{nom}$	0.01 Hz (0.001 Hz on the LCD screen of the analyzer)	± 0.01 Hz

6.4.6 Harmonics

Harmonics	Range and conditions	Resolution	Basic uncertainty
Harmonic (n)	DC, 1..50, grouping: harmonics sub-groups acc. to IEC 61000-4-7		
U _{RMS} amplitude	0..20% U _{nom} (n ≥ 2) 0..150% U _{nom} (n = 1, DC)	4 s.d.	$\pm 0.05\% U_{nom}$ if m.v. < 1% U _{nom} $\pm 5\%$ of m.v. if m.v. ≥ 1% U _{nom} (acc. to IEC 61000-4-7 Class I)
I _{RMS} amplitude	0..20% I _{nom} (n ≥ 2) 0..150% I _{nom} (n = 1, DC)	4 s.d.	$\pm 0.15\% I_{nom}$ if m.v. < 3% I _{nom} $\pm 5\%$ m.v. if m.v. ≥ 3% I _{nom} (acc. to IEC 61000-4-7 Class I)
Voltage THD-R (n = 2..50)	0.0...100.0% for U _{RMS} ≥ 1% U _{nom}	0.1%	$\pm 5\%$
Current THD-R (n = 2..50)	0.0...100.0% for I _{RMS} ≥ 1% I _{nom}	0.1%	$\pm 5\%$
TDD (n = 2..50)	depending on I _L	depending on I _L	depending on I _L
K-Factor	1.0...50.0 for I _{RMS} ≥ 1% I _{nom}	0.1	$\pm 10\%$
Phase angle (voltage)	-180°...+180°	0.1 °	$\pm (n \times 1^\circ)$
Phase angle (current)	-180°...+180°	0.1 °	$\pm (n \times 1^\circ)$

6.4.7 Interharmonics

Interharmonics	Range and conditions	Resolution	Basic uncertainty
Interharmonic order (n)	0..50, grouping: interharmonics subgroups acc. to IEC 61000-4-7 (subharmonic additionally takes into account 5 Hz bin)		
U _{RMS} amplitude	0..20% U _{nom}	4 s.d.	$\pm 0.05\% U_{nom}$ if m.v. < 1% U _{nom} $\pm 5\%$ of m.v. if m.v. ≥ 1% U _{nom} (acc. to IEC 61000-4-7 Class I)
I _{RMS} amplitude	0..20% I _{nom}	4 s.d.	$\pm 0.15\% I_{nom}$ if m.v. < 3% I _{nom} $\pm 5\%$ m.v. if m.v. ≥ 3% I _{nom} (acc. to IEC 61000-4-7 Class I)
Voltage TID-R (n = 0..50)	0.0...100.0% for U _{RMS} ≥ 1% U _{nom}	0.1%	$\pm 5\%$
Current TID-R (n = 0..50)	0.0...100.0% for I _{RMS} ≥ 1% I _{nom}	0.1%	$\pm 5\%$

6.4.8 Harmonic Powers

Harmonic Powers	Conditions	Resolution	Basic uncertainty ⁽¹⁾
Active and reactive power of harmonics	$80\% U_{nom} \leq U_{RMS} < 150\% U_{nom}$ $5\% I_{nom} \leq I_{RMS} \leq I_{nom}$	4 s.d.	$\pm \sqrt{\Delta_{Uh}^2 + \Delta_{Ih}^2 + \Delta_{ph}^2} \%$ where: δ _{Uh} – basic measurement uncertainty for voltage harmonic amplitude, δ _{Ih} – basic measurement uncertainty for current harmonic amplitude, δ _{ph} – basic uncertainty of the measurement of the phase between voltage and current harmonics.

(1) See section 6.4.10. Estimating measurement uncertainty values for power and energy.

6.4.9 Power and energy

Power and energy	Conditions (for power and energy 80% U _{nom} ≤ I _{RMS} < 120% U _{nom})	Resolution	Basic uncertainty ⁽¹⁾
Active power Active Energy	1% I _{nom} ≤ I _{RMS} < 5% I _{nom} cosφ = 1	4 s.d.	$\pm \sqrt{1,0^2 + \Delta_{ph}^2} \%$
	5% I _{nom} ≤ I _{RMS} ≤ I _{nom} cosφ = 1		$\pm \sqrt{0,5^2 + \Delta_{ph}^2} \%$
	2% I _{nom} ≤ I _{RMS} < 10% I _{nom} cosφ = 0.5		$\pm \sqrt{1,0^2 + \Delta_{ph}^2} \%$
	10% I _{nom} ≤ I _{RMS} ≤ I _{nom} cosφ = 0.5		$\pm \sqrt{0,6^2 + \Delta_{ph}^2} \%$
Reactive power Reactive energy	2% I _{nom} ≤ I _{RMS} < 5% I _{nom} sinφ = 1	4 s.d.	$\pm \sqrt{1,25^2 + \Delta_{ph}^2} \%$
	5% I _{nom} ≤ I _{RMS} < I _{nom} sinφ = 1		$\pm \sqrt{1,0^2 + \Delta_{ph}^2} \%$
	5% I _{nom} ≤ I _{RMS} < 10% I _{nom} sinφ = 0.5		$\pm \sqrt{1,25^2 + \Delta_{ph}^2} \%$
	10% I _{nom} ≤ I _{RMS} < I _{nom} sinφ = 0.5		$\pm \sqrt{1,0^2 + \Delta_{ph}^2} \%$
	10% I _{nom} ≤ I _{RMS} < I _{nom} sinφ = 0.25		$\pm \sqrt{1,25^2 + \Delta_{ph}^2} \%$
Apparent power Apparent energy	2% I _{nom} ≤ I _{RMS} < 5% I _{nom}	4 s.d.	±1%
	5% I _{nom} ≤ I _{RMS} ≤ I _{nom}		±0.5%
Power factor (PF)	-1...1 50% U _{nom} ≤ U _{RMS} < 150% U _{nom} 10% I _{nom} ≤ I _{RMS} < I _{nom}	0.01	±0.03
Displacement power factor (cosφ/ DPF)	-1...1 50% U _{nom} ≤ U _{RMS} < 150% U _{nom} 10% I _{nom} ≤ I _{RMS} < I _{nom}	0.01	±0.03

(1) See section 6.4.10. Estimating measurement uncertainty values for power and energy.

6.4.10 Estimating measurement uncertainty values for power and energy

The total measurement uncertainty for power, active and reactive energy and harmonics is based on the following relation (for energy we ignore the additional uncertainty due to time measurement, as it is much smaller than other uncertainties):

$$\Delta_{P,Q} \cong \sqrt{\Delta_{U_h}^2 + \Delta_{I_h}^2 + \Delta_{ph}^2}$$

where: $\delta_{P,Q}$ – measurement uncertainty for active or reactive power,

δ_{U_h} – total measurement uncertainty of voltage harmonic amplitude (analyzer, transducers),

δ_{I_h} – total measurement uncertainty of current harmonic amplitude (analyzer, transducers),

δ_{ph} – additional uncertainty of the measurement of the phase between voltage and current harmonics.

δ_{ph} uncertainty may be calculated when the phase angle is known for the considered frequency band. Tab. 7 shows the phase error between voltage and current harmonics for analyzers (without probes and transducers).

Tab. 7. Phase error of PQM-702/703/710/711 analyzers, depending on the frequency.

	Phase difference error					
Frequency range	40..70 Hz	70..200 Hz	200..500 Hz	500 Hz..1 kHz	1..2 kHz	2..3 kHz
Error	≤0.5°	≤1°	≤2.5°	≤4°	≤7°	≤10°

Phase error introduced by transducers and probes may be usually found in their technical documentation. In this case, we need to estimate the resultant phase error between the voltage and

the current for a given frequency caused by all elements of the measuring circuit: current and voltage transducers, probes, and the analyzer.

The uncertainty of the harmonics active power measurements may be calculated according to the following formula:

$$\Delta_{ph} = 100 \left(1 - \frac{\cos(\varphi + \Delta\varphi)}{\cos\varphi} \right) [\%], \cos\varphi \neq 0$$

On the other hand, the uncertainty of the harmonics reactive power measurement may be calculated according to the following formula:

$$\Delta_{ph} = 100 \left(1 - \frac{\sin(\varphi - \Delta\varphi)}{\sin\varphi} \right) [\%], \sin\varphi \neq 0$$

In both formulas, φ means the actual phase shift angle between the current and voltage components, and $\Delta\varphi$ means the total phase error for a given frequency. The conclusion which can be drawn from these relationships is that power measurement uncertainty for the same phase error very clearly depends on the displacement power factor between current and voltage. It is shown in Fig. 62.

Example

Calculation of measurement uncertainty of active power fundamental component.

Conditions: $\varphi = 60^\circ$, $U_{RMS} \cong U_{nom}$, $I_{RMS} = 5\% I_{nom}$.

Basic uncertainty is $\pm \sqrt{1.0^2 + \Delta_{ph}^2}$ %.

For the frequency range of 40..70 Hz, phase error of the analyzer is less than 0.5° . After substituting equation:

$$\Delta_{ph} = 100 \left(1 - \frac{\cos(\varphi + \Delta\varphi)}{\cos\varphi} \right) = 100 \left(1 - \frac{\cos(60.5^\circ)}{\cos(60^\circ)} \right) = 1.52\%$$

therefore, the measurement uncertainty is:

$$\delta = \pm \sqrt{1.0^2 + 1.52^2} = \pm 1.82\%$$

In the same conditions, but with phase shift $\varphi = 10^\circ$:

$$\Delta_{ph} = 100 \left(1 - \frac{\cos(10.5^\circ)}{\cos(10^\circ)} \right) = 0.16\%$$

and the measurement uncertainty is:

$$\delta = \pm \sqrt{1.0^2 + 0.16^2} = \pm 1.01\%$$

These calculations do not take into account the additional errors introduced probes and transformers.

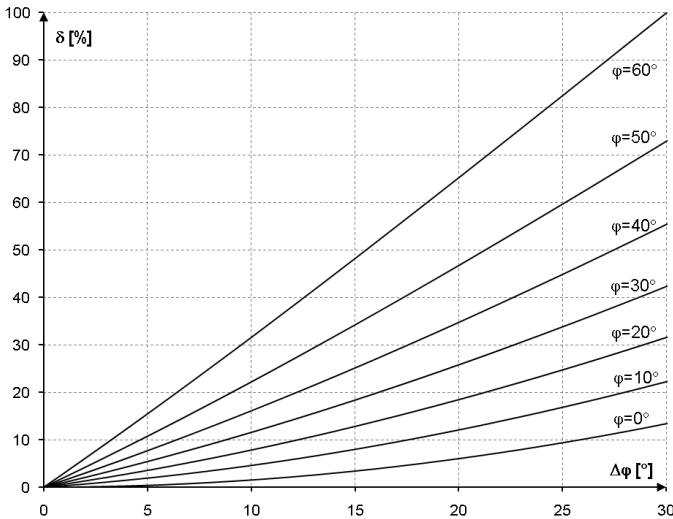

Fig. 62. Additional uncertainty due to the phase error, depending on the phase angle.

6.4.11 Flicker

Flicker	Range and conditions	Resolution	Basic uncertainty
P_{st} (10 min.) P_{It} (2 h)	0.2...10 for $U_{RMS} \geq 80\% U_{nom}$	0.01	$\pm 5\%$ within the values presented in tables of IEC 61000-4-15 standard
Class	F1 according to IEC 61000-4-15		

6.4.12 Unbalance

Unbalance (voltage and current)	Range and conditions	Resolution	Basic uncertainty
Unbalance ratio for positive, negative and zero sequence	0.0%...20.0% for $80\% U_{nom} \leq U_{RMS} < 150\% U_{nom}$	0.1%	$\pm 0.15\%$ (absolute uncertainty)

6.4.13 Mains signalling

Parameter	Range and conditions	Resolution	Basic uncertainty
Measurement method	in accordance with IEC 61000-4-30:2015		
Frequency	5.00...3000.00 Hz	0.01 Hz	not applicable
Amplitude of ripple control signal UR1, UR2	$< 1\% U_{nom}$	4 s.d.	not specified
	$1..3\% U_{nom}$		$\pm 0.15\% U_{nom}$
	$3..15\% U_{nom}$		$\pm 5\%$

6.4.14 Transients PQM-703 PQM-711

Parameter	Range and conditions	Resolution	Basic uncertainty
Voltage transients	± 8000 V	4 s.d.	$\pm(5\% + 25$ V)

6.4.15 External temperature **PQM-702T**

Parameter	Description	
Measurement accuracy (ST-2 probe + analyzer)	Temperature range	Measurement uncertainty
	$-55^{\circ}\text{C} \leq T < -10^{\circ}\text{C}$	$\pm 2^{\circ}\text{C}$
	$-10^{\circ}\text{C} \leq T \leq 85^{\circ}\text{C}$	$\pm 0.5^{\circ}\text{C}$
	$85^{\circ}\text{C} < T \leq 125^{\circ}\text{C}$	$\pm 2^{\circ}\text{C}$
Resolution	0.1°C	
Communication with analyzer	digital	
Galvanic isolation of temperature input	PQM-702T - hardware revision HWf and older: <ul style="list-style-type: none"> none (temperature input is on the same potential as USB and other accessible parts) 	
	PQM-702T – hardware revision HWg and newer: <ul style="list-style-type: none"> 2500 kV DC (additional independent isolation from USB and other accessible parts) 	
Mounting to the tested object	magnetic	
Probe cable length	2.2 m	
Measurement frequency	approx. 1 measurement per second	

6.5 Event detection - dips, swells, interruptions, RVC, RMS current

U_{RMS} voltage (dips, interruptions, rises)	Range	Resolution	Basic uncertainty
$U_{\text{RMS}(1/2)}$	0.0%...150.0% U_{nom}	4 s.d.	$\pm 0.2\% U_{\text{nom}}$
Duration	hh:mm:ss.ms	$\frac{1}{2}$ period	One period
Detection thresholds	Set by the user in percentage or absolute values. Event detection based on the measurement of $U_{\text{RMS}(1/2)}$ (1-period RMS refreshed every $\frac{1}{2}$ period).		
Waveform recording	max. 1 s of recording and max. 960 ms pretrigger time, sampling: 10.24 kHz, resolution: 8-bit.		
RMS $_{1/2}$ plot recording	max. 30 s of recording and max. 4.9 s pretrigger time sampling: half-cycle		

Rapid Voltage Change (RVC)	Range	Resolution	Basic uncertainty
$U_{\text{RMS}(1/2)}$	0.0%...150.0% U_{nom}	4 s.d.	$\pm 0.2\% U_{\text{nom}}$
Duration	hh:mm:ss.ms	$\frac{1}{2}$ period	One period
Measurement method	According to IEC 61000-4-30:2015		
Detection threshold	Set by the user in percentage of U_{nom} . Event detection based on the measurement of $U_{\text{RMS}(1/2)}$ (1-period RMS refreshed every $\frac{1}{2}$ period). Detection threshold cannot be higher than the absolute sum of dip and swell thresholds.		
Hysteresis	Set by the user in percentage of U_{nom} . Hysteresis cannot be higher than the RVC detection threshold.		
Waveform recording	max. 1 s of recording and max. 960 ms pretrigger time, sampling: 10.24 kHz, resolution: 8-bit. Recorded at the event start.		
RMS $_{1/2}$ plot recording	max. 30 s of recording and max. 4.9 s pretrigger time sampling: half-cycle. Recorded at the event start.		

I_{RMS} current (min, max)	Range	Resolution	Basic uncertainty
$I_{RMS(1/2)}$	0.0%...100.0% I_{Nom}	4 s.d.	$\pm 0.2\% I_{Nom}$
Duration	hh:mm:ss.ms	$\frac{1}{2}$ period	One period
Detection thresholds	Set by the user in percentage or absolute values. Event detection based on the measurement of $I_{RMS(1/2)}$ (1-period RMS refreshed every $\frac{1}{2}$ period).		
Waveform recording	max. 1 s of recording and max. 960 ms pretrigger time, sampling: 10.24 kHz, resolution: 8-bit.		
RMS _{1/2} plot recording	max. 30 s of recording and max. 4.9 s pretrigger time sampling: half-cycle		

6.6 Event detection - other parameters

Parameter	Range	Detection method
Frequency (min, max)	40 ... 70 Hz (percentage or absolute value)	Detection based on 10-sec. measurement (acc. to IEC 61000-4-30)
Voltage crest factor (min, max)	1.0 ... 10.0	Basing on 10/12-cycle value
Current crest factor (min, max)	1.0 ... 10.0	Basing on 10/12-cycle value
Voltage unbalance factor for negative sequence (max)	0.0 ... 20.0%	Basing on 10/12-cycle value
Current unbalance factor for negative sequence (max)	0.0 ... 20.0%	Basing on 10/12-cycle value
Short-term flicker P_{st} (max)	0..20	Basing on 10-minute value
Long-term flicker P_t (max)	0..20	Basing on 2-hour value
Active power P (min, max)	Depending on the configuration	Basing on 10/12-cycle value (for consumed and supplied power)
Reactive power Q (min, max)	Depending on the configuration	Basing on 10/12-cycle value (for consumed and supplied power)
Apparent power S (min, max)	Depending on the configuration	Basing on 10/12-cycle value
Distortion power D / Apparent distortion power S_N (min, max)	Depending on the configuration	Basing on 10/12-cycle value
Power Factor PF (min, max)	0...1	Basing on 10/12-cycle value
Displacement power factor $\cos\phi$ / DPF (min, max)	0...1	Basing on 10/12-cycle value
4-quadrant $\tan\phi$ (min, max)	0...10	Basing on 10/12-cycle value
Active energy E_P (max)	Depending on the configuration	Checked every 10/12 cycles (for consumed and supplied energy)
4-quadrant reactive energy E_Q (max)	Depending on the configuration	Checked every 10/12 cycles (for consumed and supplied energy)
Apparent energy E_S (max)	Depending on the configuration	Checked every 10/12 cycles
Total harmonic distortion of voltage THD-F (max)	0...100%	Basing on 10/12-cycle value
Total harmonic distortion of current THD-F (max)	0...200%	Basing on 10/12-cycle value
Voltage harmonic amplitudes (max)	0 ... 100% or absolute values	Basing on 10/12-cycle value; Independent thresholds for all harmonics in the range of 2...50
Current harmonic amplitudes (max)	0...200% or absolute values	Basing on 10/12-cycle value; Independent thresholds for all harmonics in the range of 2...50
Total interharmonics distortion of voltage TID-F (max)	0...100%	Basing on 10/12-cycle value

6 Technical data

Total interharmonics distortion of current TID-F (max)	0...100%	Basing on 10/12-cycle value
Voltage interharmonics amplitudes (max)	0 ... 100% or absolute values	Basing on 10/12-cycle value; Independent thresholds for all interharmonics in the range of 0...50
Current interharmonics amplitudes (max)	0 ... 100% or absolute values	Basing on 10/12-cycle value; Independent thresholds for all interharmonics in the range of 0...50
K-Factor (max)	1.0..50.0	Basing on 10/12-cycle value
Mains signaling (max)	0...U _{nom}	Basing on 10/12-cycle value
PQM-703 PQM-711 Voltage transients	50...5000 V or dV/dt	Independent transient detection module, Amplitude or slew rate method
Waveshape variation (voltage only)	1.0...100% U _{nom}	Comparison of two subsequent periods of voltage waveform. See sec. 3.12.2.
Phase jumps (voltage only)	1...359° (angle degrees)	Comparison of two or three fundamental voltage phase angles calculated from subsequent periods of voltage waveform

6.6.1 Event detection hysteresis

Event detection hysteresis	Range	Calculation method
Hysteresis	0..10%	For each of the parameters calculated as a percentage of maximum threshold value (for exceptions see section 3.12)

6.7 Recording

Recorder	
Averaging time ⁽¹⁾	200 ms, 1 s, 3 s, 5 s, 10 s, 15 s, 30 s, 1 min, 3 min, 5 min, 10 min, 15 min, 30 min, 60 min, 120 min. Special Mode: ½ period (recording only U _{RMS(1/2)} and I _{RMS(1/2)}) ⁽²⁾
Averaging min / max for U _{RMS}	½ period, period, 200 ms, 1 s, 3 s, 5 s ⁽³⁾
Averaging min / max for I _{RMS}	½ period, period, 200 ms, 1 s, 3 s, 5 s ⁽³⁾
Waveforms snapshot	Option to record three periods of waveforms of active channels, after each averaging period
Recording activation mode	- manual - starting at the first detected event - scheduled (four defined time intervals)
Recording configurations	4 independent recording configurations, defined memory allocation space on the memory card, the option to allocate the whole space to a given configuration
Recording time	Depending on the configuration (see 2.8.3)
Memory	Built-in memory card 8 GB (as standard), option of extending up to 32 GB
Memory Model	Linear
Security	Key lock to prevent unauthorized access, data read-out lock with PIN

(1) Averaging times shorter than 10 sec. are in fact equal to a multiple of the mains cycle:

200 ms – 10/12 cycles, 1 s – 50/60 cycles, 3 s – 150/180 cycles, 5 s – 250/300 cycles.

(2) U_{RMS(1/2)} and I_{RMS(1/2)} are RMS values for one cycle, refreshed every half-cycle.

(3) Averaging periods min./max. 200 ms, 1 s, 3 s, 5 s are in fact equal to a multiple of the mains cycle: 200 ms – 10/12 cycles, 1 s – 50/60 cycles, 3 s – 150/180 cycles, 5 s – 250/300 cycles

Recorded parameters	Mean value	Minimum value	Maximum value	Instantaneous value
RMS phase/phase-to-phase voltage (depending on the type of system) U_{RMS}	•	•	•	•
RMS phase-to-phase voltage (only 3-phase wye system with N and 2-phase system) U_{RMS}	•			
Voltage DC component	•	•	•	•
RMS current I_{RMS}	•	•	•	•
Current DC component ⁽¹⁾	•	•	•	•
Frequency f	•	•	•	•
Voltage crest factor CF U	•	•	•	•
Current crest factor CF I	•	•	•	•
Unbalance factors for negative and positive sequence, symmetrical components: negative, positive, zero (voltage) U_0, U_1, U_2, u_0, u_2	•	•	•	•
Unbalance factors for negative and positive sequence, symmetrical components: negative, positive, zero (current) I_0, I_1, I_2, i_0, i_2	•	•	•	•
Flicker severity P_{st} and P_{it}	•	•	•	•
Active power (consumed and supplied) P_+, P_-	•	•	•	•
Reactive power (consumed and supplied) $Q_{1+}, Q_{1-} / Q_{B+}, Q_{B-}$	•	•	•	•
Apparent power S	•	•	•	•
Distortion power D / Apparent distortion power S_N	•	•	•	•
Power Factor PF	•	•	•	•
Displacement power factor $\cos\phi/DPF$	•	•	•	•
$\tan\phi$ factor (4 quadrants): $\tan\phi(L+), \tan\phi(C-), \tan\phi(L-), \tan\phi(C+)$	•	•	•	•
Active energy (consumed and supplied) E_{P+}, E_{P-}				•
Reactive energy (4 quadrants) $E_{Q(L+)}, E_{Q(C-)}, E_{Q(L-)}, E_{Q(C+)}$				•
Apparent energy E_s				•
Voltage total harmonic distortion (THD) THD-F	•	•	•	•
Current total harmonic distortion (THD) THD-F	•	•	•	•
Total Demand Current (TDD)	•			
Voltage harmonic amplitudes $U_{h1}...U_{h50}$	•	•	•	•
Current harmonic amplitudes $I_{h1}...I_{h50}$	•	•	•	•
Voltage total interharmonic distortion TID-R	•	•	•	•
Current total interharmonic distortion TID-F	•	•	•	•
Voltage interharmonics amplitudes $U_{ih0}...U_{ih50}$	•	•	•	•
Current interharmonics amplitudes $I_{ih0}...I_{ih50}$	•	•	•	•
K-Factor (max)	•	•	•	•
Harmonics active power (1...50) $P_{h1}...P_{h50}$	•	•	•	•
Harmonics reactive power (1...50) $Q_{h1}...Q_{h50}$	•	•	•	•
Angles between voltage and current harmonics $\phi_1... \phi_{50}$	•	•	•	•
Ripple control signals UR1, UR2	• ⁽²⁾		•	

⁽¹⁾ Only when using C-5A probes

⁽²⁾ During recording for the purposes related to compliance with EN 50160 standard, 3-second average values are also recorded.

6.8 Power supply, battery, heater

Power supply		
Input voltage range (nominal)	100...690 V AC, 40...70 Hz 140...690 V DC	
Input voltage range (including fluctuations)	90...760 V AC, 40...70 Hz 127...760 V DC	
Overvoltage category of the power supply	CAT IV 600 V CAT III 690 V CAT III 760 V (including fluctuations)	
Power consumption from mains (max)	50 VA / 20 W	
Power consumption from mains depending on configuration (typical)	PQM-702/PQM-710, no battery charging, heater disabled, GSM turned off, supply voltage 230 VAC	9 VA / 6 W
	PQM-702/PQM-710, with battery charging, heater disabled, GSM turned off, supply voltage 100...300 VAC	13 VA / 8 W
	PQM-703/PQM-711, with battery charging, heater disabled, GSM turned off, transient measurement enabled, supply voltage 100...300 VAC	15 VA / 10 W
	PQM-703/PQM-711, with battery charging, heater disabled, GSM turned on, transient measurement enabled, supply voltage 100...300 VAC	18 VA / 12 W
	PQM-703/PQM-711, with battery charging, heater disabled, GSM turned on, transient measurement enabled, supply voltage 500...690 VAC	38 VA / 13 W
	PQM-703/PQM-711, with battery charging, heater enabled and active, GSM turned on, transient measurement enabled, supply voltage 500...690 VAC	48 VA / 18 W

Rechargeable battery	
Type	Li-Ion 4.4 Ah
Operating time on battery	PQM-702, PQM-710: approx. 2 h PQM-703, PQM-711: approx. 1.5 h
Battery charging time (fully discharged battery)	< 8 h
Charging temperature range	-10°C ...+60°C
Current consumption from battery in analyzer off mode (mains power disconnected, does not apply to anti-theft mode)	< 1 mA

Heater	
Heater temperature threshold (activation)	+5°C
Heater power supply	from internal AC/DC adapter
Heater power	max. 5 W

6.9 Supported mains types

Types of supported mains (directly and indirectly)	
1-phase	1-phase with a neutral conductor (terminals: L1/A, N)
2-phase (split-phase)	Split phase with a neutral conductor (terminals: L1/A, L2/B, N, PE)
3-phase wye with N,	3-phase 4-wire (terminals: L1/A, L2/B, L3/C, N, PE)
3-phase delta	3-phase 3-wire delta (terminals: L1/A, L2/B, L3/C, N, PE; optionally N shorted with L3)
3-phase Aron delta	3-phase 3-wire (terminals: L1/A, L2/B, L3/C, N, PE; optionally N shorted with L3/C) with two current probes
3-phase wye without N,	3-phase 3-wire (terminals: L1/A, L2/B, L3/C, N, PE; optionally N shorted with L3/C)
3-phase wye without Aron N,	3-phase 3-wire (terminals: L1/A, L2/B, L3/C, N, PE; optionally N shorted with L3/C) with two current probes

6.10 Supported current probes

Types of supported current probes	
F-1(A)	Flexible probes (Rogowski coil), perimeter: 120 cm, measuring range 3000 A _{RMS}
F-2(A)	Flexible probes (Rogowski coil), perimeter: 80 cm, measuring range 3000 A _{RMS}
F-3(A)	Flexible probes (Rogowski coil), perimeter: 45 cm, measuring range 3000 A _{RMS}
F-2AHD	Flexible probes (Rogowski coil), perimeter: 91,5 cm, measuring range 3000 A _{RMS}
F-3AHD	Flexible probes (Rogowski coil), perimeter: 45 cm, measuring range 3000 A _{RMS}
F-1A6	Flexible probes (Rogowski coil), perimeter: 120 cm, measuring range 6000 A _{RMS}
F-2A6	Flexible probes (Rogowski coil), perimeter: 80 cm, measuring range 6000 A _{RMS}
F-3A6	Flexible probes (Rogowski coil), perimeter: 45 cm, measuring range 6000 A _{RMS}
F-1A1	Flexible probes (Rogowski coil), perimeter: 120 cm, measuring range 1500 A _{RMS}
F-2A1	Flexible probes (Rogowski coil), perimeter: 80 cm, measuring range 1500 A _{RMS}
F-3A1	Flexible probes (Rogowski coil), perimeter: 45 cm, measuring range 1500 A _{RMS}
C-4(A)	CT, AC probes, measuring range 1000 A _{RMS} , 1 mV/A
C-5A	CT, AC/DC probes with Hall sensor, measuring range 1000 A _{RMS} , 1 mV/A
C-6(A)	CT, AC probes for low currents, measuring range 10 A _{RMS} , 1 mV/10 mA
C-7(A)	CT, AC probes, measuring range 1000 A _{RMS} , 5 mV/A

NOTE: Clamps with letter 'A' in the marking (e.g. F-3A) are clamps with automatic type detection in compatible devices. Other parameters are the same as in the case of clamps without automatic clamp type detection. Automatic clamp type detection is available in analyzers: PQM-702/703/710/711 with HWg hardware and later and with firmware 1.40 or later.

6.11 Communication

Communication	
USB	Galvanic isolated Max. transmission speed 921.6 kbit/s, mass-storage reader mode with few MB/s throughput. Compatible with USB 2.0
PQM-702 PQM-703 Wireless	Built-in 433 MHz radio module, Connection via OR-1 wireless module, Max. transmission speed: 57.6 kbit/s Range up to 5 m
PQM-710 PQM-711 Wi-Fi	Internal Wi-Fi IEEE 802.11b/g/n module, Max. effective transmission speed 300 kB/s (on distance up to 10 m) IEEE 802.11b/g IEEE 802.11 n single stream WPA/WPA2-PSK encryption supported
GSM	Built-in GSM modem with internal antenna, user-accessible SIM card slot (mini SIM 15 x 25 mm) Max. data rate: 5.76/7.2 Mbit/s Supported frequency bands: GSM/GPRS/EDGE: 850/900/1800/1900 MHz UMTS/HSPA: 2100 MHz (versions for European market, HWf hardware and earlier) UMTS/HSPA: 850/1900/2100 (versions for global market, HWf hardware and earlier) UMTS/HSPA: 850/900/1900/2100 (HWg hardware and later)

6.12 Environmental conditions and other technical data

Environmental conditions	
Operating temperature range:	-20°C...+55°C
Storage temperature range	-30°C...+60°C
Humidity	10...90% with possible condensation
Ingress protection (according to IEC 60529)	IP 65
Solar radiation	Do not use in direct sunlight conditions, use sunshade cover. Recommended covers made of plastic – metal covers may degrade GPS signal reception.
Reference conditions	Ambient temperature: 0°C...+40°C Humidity: 40...60%
Operating altitude	up to 2000 m (up to 4000 m with derated measurement category, see section 6.1)
Dimensions	200 x 180 x 77 mm (without cables)
Weight	approx. 1.6 kg
Display	color LCD TFT, 320x240 pixels, diagonal 3.5"
Data Memory	built-in memory card 8 GB (as standard), option of extending up to 32 GB

6.13 Safety and electromagnetic compatibility

Safety and EMC	
Compliance with	IEC 61010-1:2010/AMD1:2016 (Ed. 3.0) IEC 61010-2-030:2017 (Ed. 2.0)
Measurement category	CAT IV 600 V CAT III 760 V or CAT III 1000 V depending on version (see section 6.1) pollution class 2
Overvoltage category (internal AC/DC power supply)	IV 600 V III 690 V III 760 V (including fluctuations) pollution class 2
Insulation	double
Electromagnetic compatibility	IEC 61000-6-5:2015 EN 55032 (CISPR 32)
Immunity to radio frequency interferences	IEC 61000-4-3 sinusoidal modulation 80% AM, 1 kHz 80...1000 MHz, 10 V/m 1.4...2.0 GHz, 3 V/m 2.0...2.7 GHz, 1 V/m
Immunity to electrostatic discharge	IEC 61000-4-2 Air discharge: 8 kV Contact discharge: 4 kV
Immunity to conducted disturbances, induced by radio-frequency fields	IEC 61000-4-6 sinusoidal modulation 80% AM, 1 kHz 0.15...80 MHz, 10 V
Immunity to series of fast transients/bursts	IEC 61000-4-4 Amplitude 2 kV, 5 kHz
Immunity to surges	IEC 61000-4-5 Amplitude 2 kV (L-L), 4 kV (L-PE)
Emission of radiated RF disturbances	IEC 61000-6-3 class A: 30...230 MHz, 40 dB(μ V/m) at 10 m 230...1000 MHz, 47 dB(μ V/m) at 10 m
Emission of conducted disturbances	IEC 61000-6-3 Levels for a quasi-peak detector: 0.15 kHz...0.5 MHz: 66 dB μ V...56 dB μ V 0.5 MHz...5 MHz: 56 dB μ V 5 MHz...30 MHz: 60 dB μ V

EN 55032 Compliance statement:

PQM-702, PQM-703, PQM-710 and PQM-711 are class A products. In a domestic environment these products may cause radio interference in which case the user may be required to take adequate measures (e.g. increasing distance between affected devices).

Note:

PQM-710 **PQM-711** SONEL S.A. hereby declares that the radio device type PQM-710/711 complies with Directive 2014/53/EU. The full text of the EU Declaration of Conformity is available at the following website address: <https://sonel.pl/en/download/declaration-of-conformity/>

6.14 Standards

Standards	
Product standard	IEC 62586-1:2017 (Ed. 2.0) IEC 62586-2:2017/COR1:2018 (Ed. 2.0) Product classification: PQI-A-PO (measurement class A acc. to IEC 61000-4-30, Portable , Outdoor , EMC environment G)
Measurement methods	IEC 61000-4-30:2015/COR1:2016 (Ed. 3.0) class A
Measurement accuracy	IEC 61000-4-30:2015/COR1:2016 (Ed. 3.0) class A
Power quality	EN 50160:2010
Flicker	IEC 61000-4-15:2010/COR1:2012 (Ed. 2.0)
Harmonics	IEC 61000-4-7:2002/AMD1:2008 (Ed. 2.0)
Safety	IEC 61010-1:2010/AMD1:2016 (Ed. 3.0) IEC 61010-2-030:2017 (Ed. 2.0)
EMC	EN 55032:2015 IEC 61000-6-5:2015
Quality standard	design, construction and manufacturing are ISO 9001 compliant

6.14.1 Compliance with standards

The analyzer is designed to meet the requirements of the following standards.

Product standards:

- IEC 62586-1:2017 – Power quality measurement in power supply systems - Part 1: Power quality instruments (PQI).
- IEC 62586-2:2017 – Power quality measurement in power supply systems - Part 2: Functional tests and uncertainty requirements.

Standards for measuring network parameters:

- IEC 61000-4-30:2015/COR1:2016 (Ed. 3.0) – Electromagnetic compatibility (EMC) - Testing and measurement techniques - Power quality measurement methods.
- IEC 61000-4-7:2002/AMD1:2008 (Ed. 2.0) – Electromagnetic compatibility (EMC) – Testing and Measurement Techniques - General Guide on Harmonics and Interharmonics Measurements and Instrumentation for Power Supply Systems and Equipment Connected to them.
- IEC 61000-4-15:2010/COR1:2012 (Ed. 2.0) – Electromagnetic compatibility (EMC) – Testing and Measurement Techniques - Flickermeter - Functional and Design Specifications.
- EN 50160:2010 – Voltage characteristics of electricity supplied by public distribution networks.

Safety standards:

- IEC 61010-1:2010/AMD1:2016 (Ed. 3.0) – Safety requirements for electrical equipment for measurement control and laboratory use. Part 1: General requirements.
- IEC 61010-2-030:2017 (Ed. 2.0) – Safety requirements for electrical equipment for measurement, control, and laboratory use – Part 2-030: Particular requirements for equipment having testing or measuring circuits

Standards for electromagnetic compatibility:

- EN 55032:2015 – Electromagnetic compatibility of multimedia equipment - Emission Requirements.
- IEC 61000-6-5:2015 – Electromagnetic compatibility (EMC) - Part 6-5: Generic standards - Immunity for equipment used in power station and substation environment.

The device meets all the requirements of Class A as defined in IEC 61000-4-30. The summary of the requirements is presented in the table below.

Tab. 8. Summary of selected parameters in terms of their compliance with the standards

Aggregation of measurements at different intervals	<p>IEC 61000-4-30 Class A:</p> <ul style="list-style-type: none"> • Basic measurement time for parameters (voltage, current, harmonics, unbalance) is a 10-cycle interval for 50 Hz power supply system and 12-cycle interval for 60 Hz system, • Interval of 3 s (150 cycles for the nominal frequency of 50 Hz and 180 cycles for 60 Hz), • Interval of 10 minutes, • Interval of 2 h (basing on 12 intervals of 10 min.) • Synchronization of aggregation intervals
Real-time clock (RTC) uncertainty	<p>IEC 61000-4-30 Class A:</p> <ul style="list-style-type: none"> • Clock synchronization to GPS time using the built-in GPS receiver with internal or external antenna, • Built-in real time clock, which is set from "Sonel Analysis", • RTC accuracy after GPS signal loss - better than ± 0.3 s/day
Frequency	Compliant with IEC 61000-4-30 Class A of the measurement method and uncertainty
Power supply voltage	Compliant with IEC 61000-4-30 Class A of the measurement method and uncertainty
Voltage fluctuations (flicker)	The measurement method and uncertainty meets the requirements of IEC 61000-4-15 standard, class F1
Dips, interruptions and surges of supply voltage	Compliant with IEC 61000-4-30 Class A of the measurement method and uncertainty
Supply voltage unbalance	Compliant with IEC 61000-4-30 Class A of the measurement method and uncertainty
Voltage and current harmonics	Compliant with IEC 61000-4-30 Class A of the measurement method and uncertainty (IEC 61000-4-7 Class I)
Voltage and current inter-harmonics	Compliant with IEC 61000-4-30 Class A of the measurement method and uncertainty (IEC 61000-4-7 Class I)
Mains signalling voltage on the supply voltage	Compliant with IEC 61000-4-30 Class A of the measurement method and uncertainty
Rapid Voltage Changes (RVC)	Compliant with IEC 61000-4-30 Class A of the measurement method and uncertainty
Magnitude of current	Compliant with IEC 61000-4-30 Class A of the measurement method and uncertainty





6.14.2 Product specification according to IEC 62586

Product specification		PQI-A-PO (measurement class A acc. to IEC 61000-4-30, Portable, Outdoor, EMC environment G)		
Symbol	Function	Class acc. to IEC 61000-4-30	Range	Additional information
f	power frequency	A	40...70 Hz	
U	magnitude of the supply voltage	A	10%...150% U_{din}	6,4...760 V $U_{din} \leq 506$ V
P_{ST}, P_{LT}	flicker	A	P_{ST} 0.2...10	class F1
U_{dip}, U_{swl}	supply voltage dips and swells	A	–	
U_{int}	supply voltage interruption	A	–	
u_0, u_2	supply voltage unbalance	A	0.0%...20.0%	
U_h	voltage harmonics	A	200% of class 3 compatibility levels from IEC 61000-2-4	
U_{ih}	voltage interharmonics	A	200% of class 3 compatibility levels from IEC 61000-2-4	
MSV	mains signalling voltage	A	0...15% U_{din}	$U_{din} \leq 690$ V
<i>Under/over</i>	under/over deviation	<i>not applicable</i>	–	
RVC	rapid voltage change	A	–	
I	magnitude of current	A	0%...150% I_{nom}	
i_0, i_2	current unbalance	A	0,0%...20,0%	
I_h	current harmonics	A	200% of class 3 compatibility levels from IEC 61000-2-4	
I_{ih}	current interharmonics	A	200% of class 3 compatibility levels from IEC 61000-2-4	

Notes: U_{din} is declared input voltage of the analyzer ie. taking into account the transducers. If transducers are not used then $U_{nom} = U_{din}$. If transducers are used then $U_{nom} = k \times U_{din}$, where k is the transducer ratio, eg. for a transducer 15 kV:100 V $\Rightarrow k=150$, $U_{nom}=15$ kV, $U_{din}=100$ V.

7 Optional accessories

The full list of accessories can be found on the manufacturer's website.

				
	C-4A	C-5A	C-6A	C-7A
	WACEGC4AOKR	WACEGC5AOKR	WACEGC6AOKR	WACEGC7AOKR
Rated current	1000 A AC	1000 A AC 1400 A DC	10 A AC	100 A AC
Frequency	30 Hz...10 kHz	DC...5 kHz	40 Hz...10 kHz	40 Hz...1 kHz
Max. diameter of measured conductor	52 mm	39 mm	20 mm	24 mm
Minimum accuracy	≤0.5%	≤1.5%	≤1%	0,5%
Battery power	—	√	—	—
Lead length	2.2 m	2.2 m	2.2 m	3 m
Measurement category	IV 300 V	IV 300 V	IV 300 V	III 300 V
Ingress protection	IP40			

					
	F-1A1 / F-1A / F-1A6	F-2A1 / F-2A / F-2A6	F-3A1 / F-3A / F-3A6	F-2AHD	F-3AHD
	WACEGF1A1OKR WACEGF1AOKR WACEGF1A6OKR	WACEGF2A1OKR WACEGF2AOKR WACEGF2A6OKR	WACEGF3A1OKR WACEGF3AOKR WACEGF3A6OKR	WACEGF2AHDOKR	WACEGF3AHDOKR
Rated current	1500 / 3000 / 6000 A AC	1500 / 3000 / 6000 A AC	1500 / 3000 / 6000 A AC	3000 A AC	
Frequency	40 Hz...10 kHz			10 Hz...20 kHz	
Max. diameter of measured conductor	380 mm	250 mm	140 mm	290 mm	145 mm
Minimum accuracy	1%			0.5%	
Battery power	—			—	
Lead length	2.5 m			2.5 m	
Measurement category	IV 600 V			IV 600 V	
Ingress protection	IP67			IP65	

7 Optional accessories

External active GPS antenna

- frequency: 1575.42 GHz
- polarization: RHCP
- LNA gain: 26 dB (3 V)
- VSWR: <1.2:1
- dimensions (without cable): 14.0 × 34.2 × 38.2 mm
- operating temperature: -40°C...+85°C
- protection rating acc. to IEC 60529: IP 67
- cable length: 10 m
- current consumption: 15...25 mA
- mounting: magnetic, any surface



Fig. 63. External GPS antenna.

8 Other Information

8.1 Cleaning and maintenance

Note

Use only the maintenance methods specified by the manufacturer in this manual.

The casing of the analyzer may be cleaned with a soft, damp cloth using all-purpose detergents. Do not use any solvents or cleaning agents which might scratch the casing (powders, pastes, etc.). Cables should be cleaned with water and detergents, and then dried. The analyzer electronic system does not require maintenance.

8.2 Storage

In the case of storage of the device, the following recommendations must be observed:

- Disconnect all the test leads from the meter.
- Clean the meter and all its accessories thoroughly.
- In order to prevent a total discharge of the accumulators in the case of a prolonged storage, charge them from time to time.

8.3 Dismantling and utilization

Worn-out electric and electronic equipment should be gathered selectively, i.e. it must not be placed with waste of another kind.

Worn-out electronic equipment should be sent to a collection point in accordance with the law of waste electrical and electronic equipment.

Before the equipment is sent to a collection point, do not dismantle any elements.

Observe local regulations concerning disposal of packages, waste batteries and accumulators.

8.4 Manufacturer

The manufacturer of the device and provider of guarantee and post-guarantee services:

SONEL S.A.

Wokulskiego 11

58-100 Świdnica

Poland

tel. +48 74 884 10 53 (Customer Service)

e-mail: customerservice@sonel.com

web page: www.sonel.com

Note

Service repairs must be performed only by the manufacturer.

Note

PQM-710 **PQM-711** SONEL S.A. does not provide a warranty for the included tablet or its accessories. In case of discrepancies in the operation of the tablet, please contact the tablet manufacturer directly to file a complaint. Current contact details can be obtained from the manufacturer's website.



SONEL S.A.

Wokulskiego 11
58-100 Świdnica
Poland

Customer Service

tel. +48 74 884 10 53
e-mail: customerservice@sonel.com

www.sonel.com