

Sonel PQM-700

Power Quality Analyzer • Quick Guide



v1.01 | 29.03.2023



Status signalization

ON	LED is on. The analyzer is on.	ERROR	LED flashes. Problem in at least one mains phase: <ul style="list-style-type: none"> reverse phase sequence, incorrect values of voltages and/or currents, energy generation. See tolerances in step ④ in page 6.	ERROR	ERROR is off, MEM is on. Problem with the memory or memory full.
ON	LED flashes. The meter is ready for software update (press START to confirm).	MEM		MEM	
ON	LEDs flash. Software update in progress.	ON	ON is on, LOG flashes. Recording in progress.	ERROR	LEDs are on. No memory card or unformatted memory card. If LEDs are still on after pressing START - the memory is damaged.
MEM		LOG		MEM	
BATT	LED flashes. Battery charge level $\leq 20\%$.	ON	ON is off, LOG flashes in every 10 s. Recording in progress. Analyzer in sleep mode.	ERROR	ERROR is on, MEM is off. Internal error of the analyzer.
BATT	LED is on. Battery completely depleted. After 5 s the analyzer shuts down.	LOG		MEM	

Maximum input voltage



Measurement inputs

Voltage - 4 inputs

L1, L2, L3, N
 AC: **MAX. 760 V_{RMS}**
 DC: **±760 V**
 referred to ground

Current - 4 inputs

Flexible probes: **F-xA1: 1...1500 A AC**
F-xA: 3...3000 A AC
F-xA6: 6...6000 A AC
 Hard clamps: **C-4A: 0.1...1000 A AC**
C-5A: 0.5...1000 A AC/DC
C-6A: 0.01...10 A AC
C-7A: 0.1...100 A AC

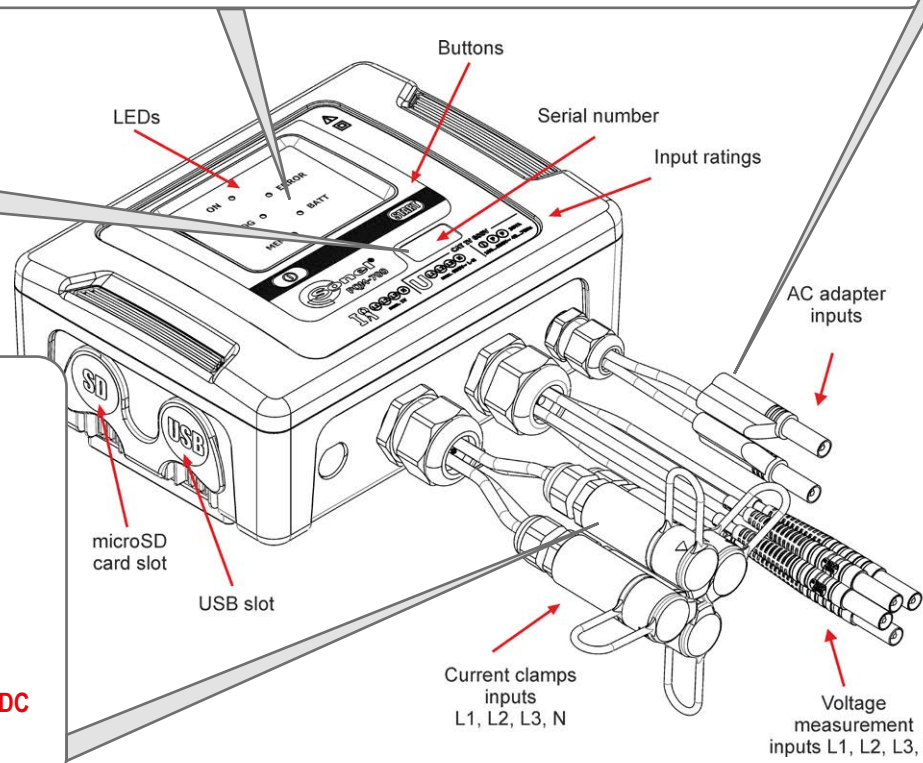

Li-Ion BATTERY

3.7 V
4.4 Ah

External DC power
MAX. 140...415 V

External AC power
MAX. 100...415 V AC
MAX. 40...70 Hz

Power supply

Mounting



Three steps to get results

1 Prepare measurement configuration and send it to the meter ▶ page 2

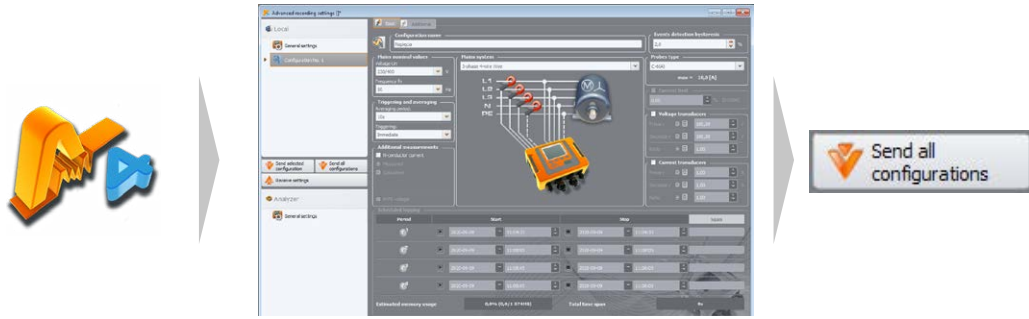

2 Install the analyzer and start the measurement ▶ page 6



3 Analyze the recorded data ▶ page 8

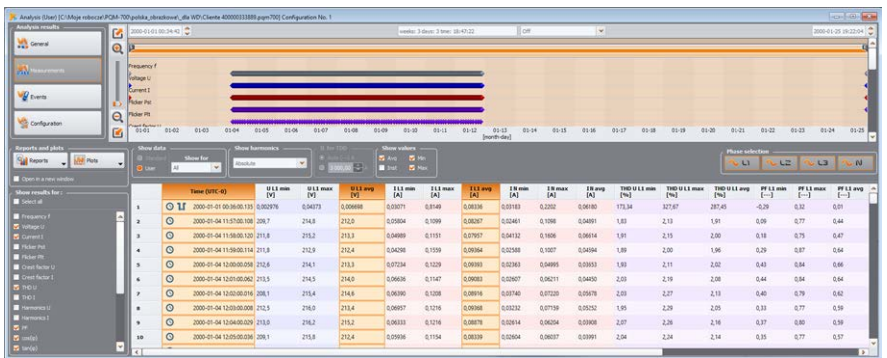

Getting started | Connecting the analyzer

Method 1. Choose a function requiring analyzer connection

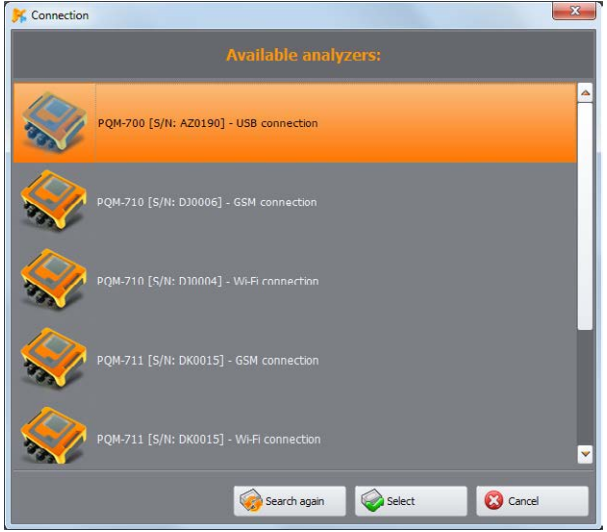
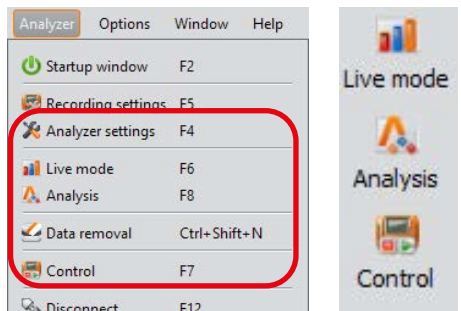

Analyzer connection window will appear.

- Choose the desired analyzer.
- Press **Select**.
- Enter PIN code (default: 000).

Method 2. Choose desired analyzer from the database

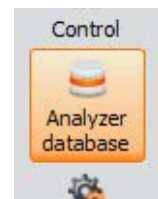

No.	Analyzer type	Serial number
1	PQM-700	AZ0025



Getting started | Creating a measurement configuration



Enter main settings.

Measured network parameters

- 1 Nominal voltage
- 2 Nominal frequency
- 3 Mains system

Choice of probes and transducers

- 4 Choice of current probes
- 5 Voltage transducers settings
- 6 Current transducers settings

Measurement parameters

- 7 Additional recording of U_{N-PE} and I_N
- 8 Averaging period
- 9 Measurement triggering
- 10 Events detection hysteresis (typical 2%)

Enter recording parameters.

Send configuration to the analyzer.

Receive configuration from the analyzer's memory.

View actual configurations of the connected analyzer (**Analyzer** section).

Advanced recording settings []*

Local

- General settings
- Configuration No. 1
- Standard
- Voltage
- Current
- Power and energy
- Harmonics
- Interharmonics

Analyzer

- General settings

Basic

Configuration name: Voltages

Mains nominal values

Voltage U_n : 230/400 V

Frequency f_n : Hz

Mains system: 3-phase 4-wire Wye

Triggers and averaging

Averaging period: 10s

Triggering: Immediate

Additional measurements

- N-conductor current
 - Measured
 - Calculated
- N-PE voltage

Scheduled logging

Period	Start	Stop	Span
	2020-01-10 11:55:48	2020-01-10 11:55:48	
	2020-01-10 11:55:56	2020-01-10 11:55:56	
	2020-01-10 11:55:56	2020-01-10 11:55:56	
	2020-01-10 11:55:56	2020-01-10 11:55:56	

Estimated memory usage: 0.0% (0.0 / 1.874 MB) Total time span: 0s

P1 Estimated recording time: 12y 8M 3w 0d 12h 20m 21s Analyzer: ... S/N: ... Status: Disconnected

Getting started | Choosing the mains system

Single-phase

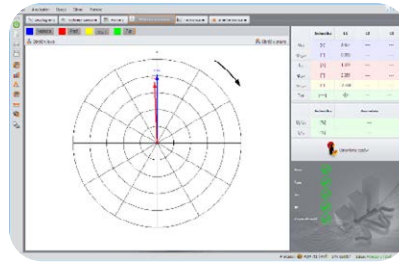
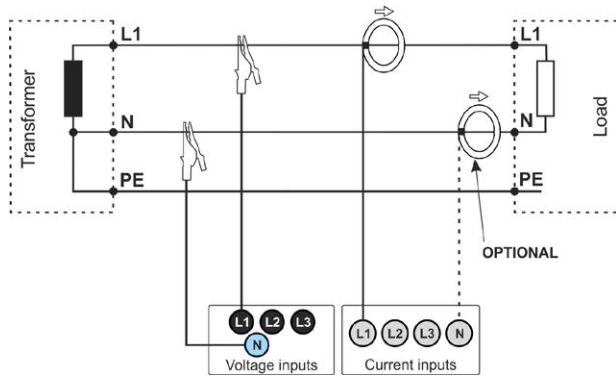

Split-phase

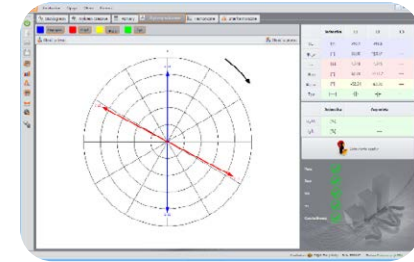
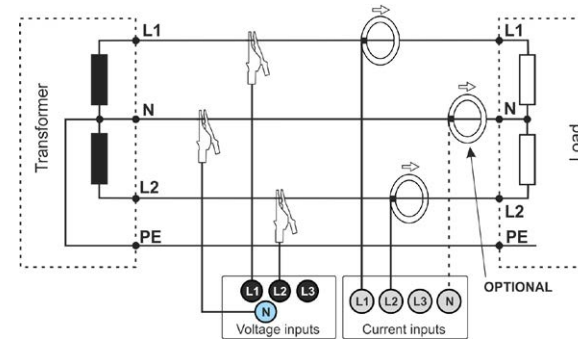

U1 ► U2

3-phase 4-wire (WYE with a neutral conductor)

Direct connection

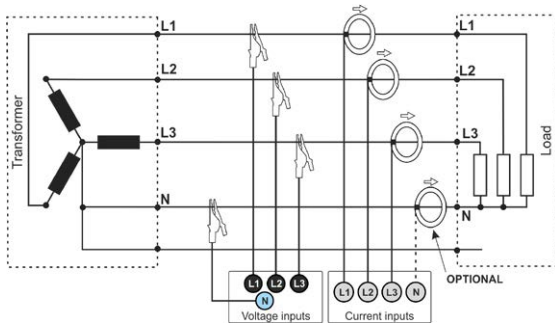

Connection with transducers

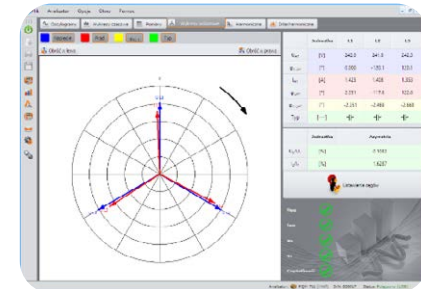
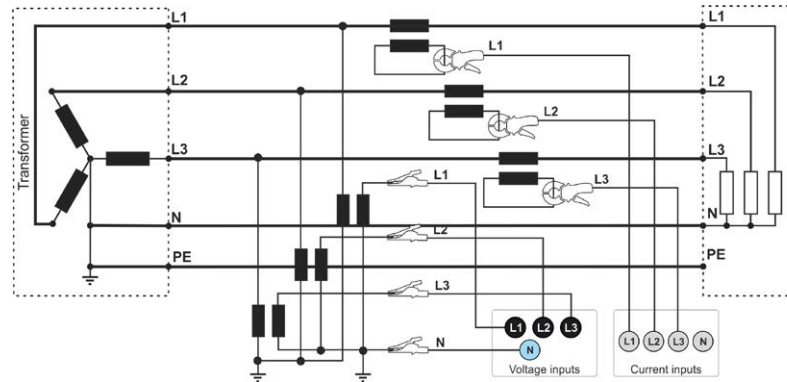

U1 ► U2 ► U3

3-phase 3-wire (Delta)

Direct connection

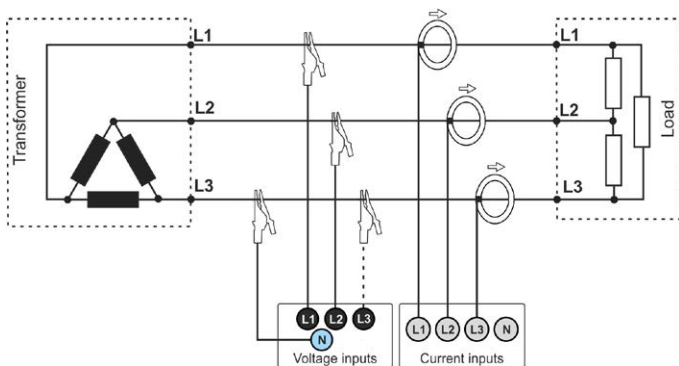

Connection with transducers

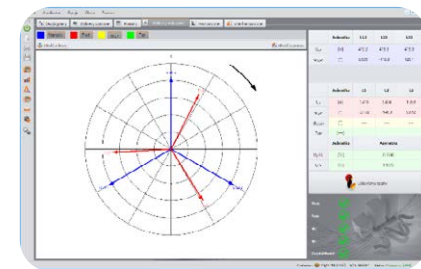
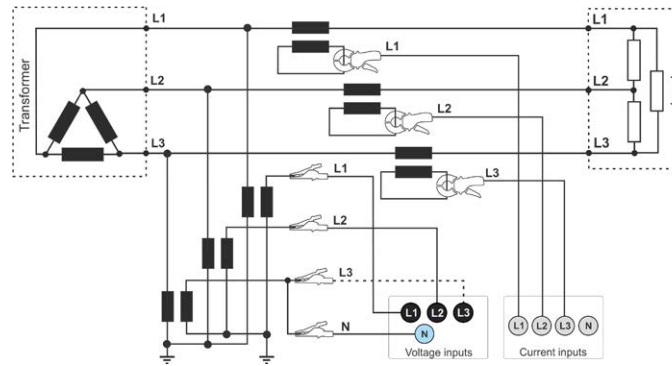

U12 ► U23 ► U31

Getting started | Adjusting transducer settings

Probes type
C-6(A)
max = 1,20 [kA]

Current limit
0,10 % [1,2A]

Voltage transducers
Primary: 21 750,00 V
Secondary: 103,57 V
Ratio: 210,00

Current transducers
Primary: 600,00 A
Secondary: 5,00 A
Ratio: 120,00

Activate **Voltage transducers**, if the measurement will not be carried out in a direct way.

Activate **Current transducers** for connection:

- with current transducers,
- direct (multiloop) measurement of small current for accuracy enhancement.

Direct current measurement - enhanced accuracy

The use of a current transmission in direct connection enhances probe sensitivity for small signal measurement. It decreases the upper measuring range according to the formula:

$$\text{New range} = \frac{\text{Nominal probe range}}{\text{no. of turns}}$$

and deepens the lower measuring range. It increases the accuracy and operating range of the probe.

C-7A probe • nominal range 100 A • no. of turns = 5



$$\text{New range} = \frac{100 \text{ A}}{5 \text{ turns}} = 20 \text{ A}$$

Current transducers
Primary: 20,00 A
Secondary: 100,00 A
Ratio: 0,20

F-1A probe • nominal range 3000 A • no. of turns = 2



$$\text{New range} = \frac{3000 \text{ A}}{2 \text{ turns}} = 1500 \text{ A}$$

Current transducers
Primary: 1 500,00 A
Secondary: 3 000,00 A
Ratio: 0,50

Measurement with transducers

Depending on the type of measured network (WYE with neutral / Delta), enter transducers' parameters and the nominal level of exceedings control.

Mains type: WYE with neutral conductor

Probes type
C-6(A)
max = 200 [A]

Current limit
0,02 % [0,04A]

Voltage transducers
Primary: 66 395,00 V
Secondary: 60,36 V
Ratio: 1 100,00

Current transducers
Primary: 100,00 A
Secondary: 5,00 A
Ratio: 20,00

For WYE+N type mains, tolerances, harmonics and exceedings are controlled according to **phase-to-neutral** value. Enter:

- 100-percent value of the nominal **phase-to-neutral** voltage,
- voltage transducer ratio k_U .

Enter parameters of current transducers:

- primary current,
- secondary current.

Mains type: Delta

Probes type
C-6(A)
max = 1,20 [kA]

Current limit
0,10 % [1,2A]

Voltage transducers
Primary: 21 750,00 V
Secondary: 103,57 V
Ratio: 210,00

Current transducers
Primary: 600,00 A
Secondary: 5,00 A
Ratio: 120,00

For Delta type mains, tolerances, harmonics and exceedings are controlled according to **phase-to-phase** value. Enter:

- 100-percent value of the nominal **phase-to-phase** voltage,
- voltage transducer ratio k_U .

Enter parameters of current transducers:

- primary current,
- secondary current.

Measurements

1

Mount the analyzer



2

Upload the configuration to the analyzer

Create a measurement configuration and upload it to the analyzer using **Sonel Analysis** software.

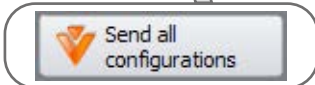
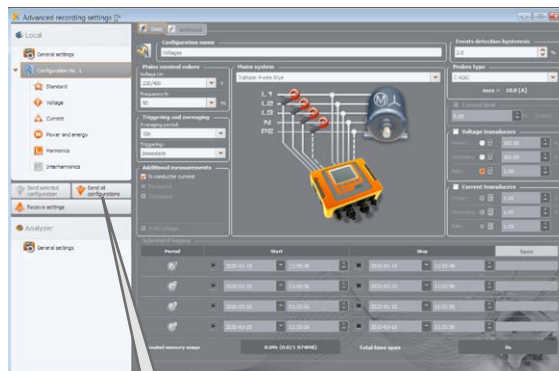

3

Connect the analyzer to the network acc. to the configuration

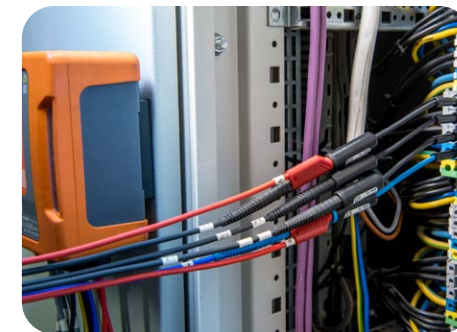

- Arrows on all clamps have to be pointed towards the electrical load.
- Pay close attention to connecting the analyzer in systems with transducers. In these systems, C-6A clamps will be useful - they are dedicated to measure current at transducers.

4

Check the network status and the analyzer connection status

RMS voltages

- ✓ U_{RMS} within $\pm 15\% U_N$ range
- ✗ U_{RMS} outside of $\pm 15\% U_N$ range

RMS currents

- ✓ I_{RMS} within 0.3%...115% I_N range
- ✗ I_{RMS} exceed 115% I_N
- ? I_{RMS} below 0.3% I_N
- current probes not selected

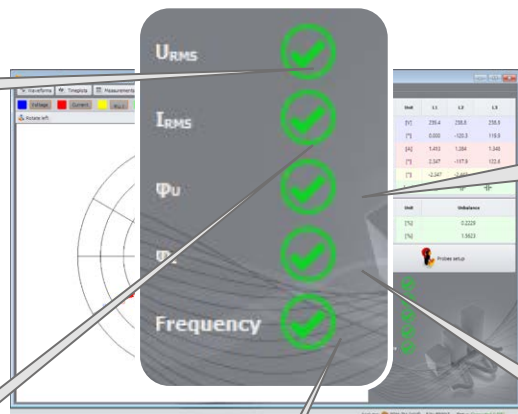

Frequency

- ✓ is within $\pm 10\% f_N$ range
- ✗ is outside the $\pm 10\% f_N$ range
- ? too low voltage: $< 10 V$

Voltage angles - phase succession (clockwise)

- ✓ angles of the range of $\pm 30\%$ of the theoretical values $0^\circ, 120^\circ, 240^\circ$
- ? too low voltages: $< 1\% U_N$
- ✗ incorrect angles

Current angles - relative to voltage

- ✓ current vectors are within $\pm 55^\circ$ range in relation to corresponding voltage vector
- ✗ at least one current vector is outside the acceptable range $\pm 55^\circ$
- ? too low currents: $< 0.3\% I_N$

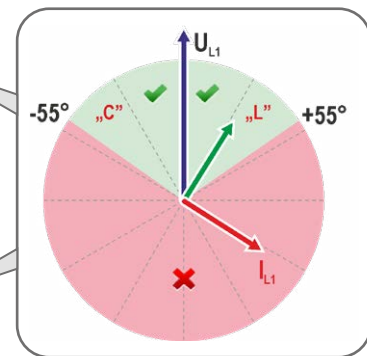

Measurements

5 Zweryfikuj czas analizatora

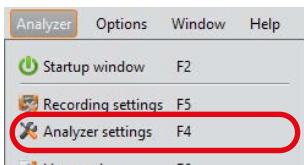

In Sonel Analysis software, in **Analyzer** menu, you can verify and change the time and date in the device.

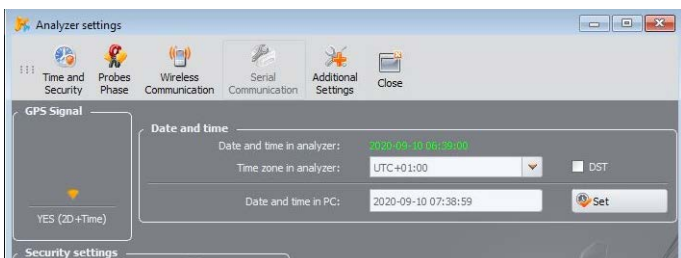

The button **Set** uploads the computer's current time to the analyzer.

6 Adjust analyzer settings

Using Sonel Analysis, under menu **Analyzer**, adjust:

- security,
- reverse current direction on the probe.



After each change, confirmation window will appear.

7 Start recording

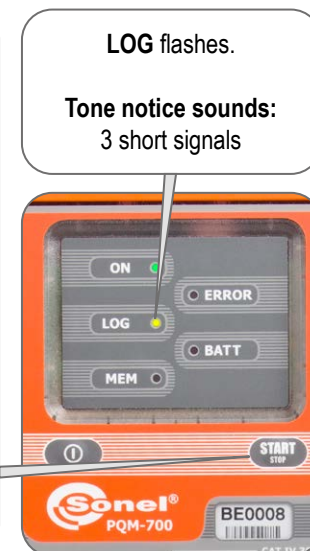
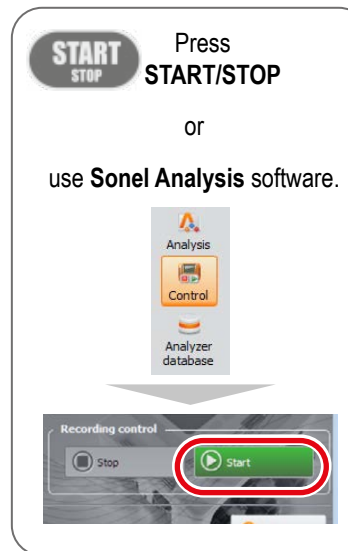

8 Monitor the meter and measurements

View live readings

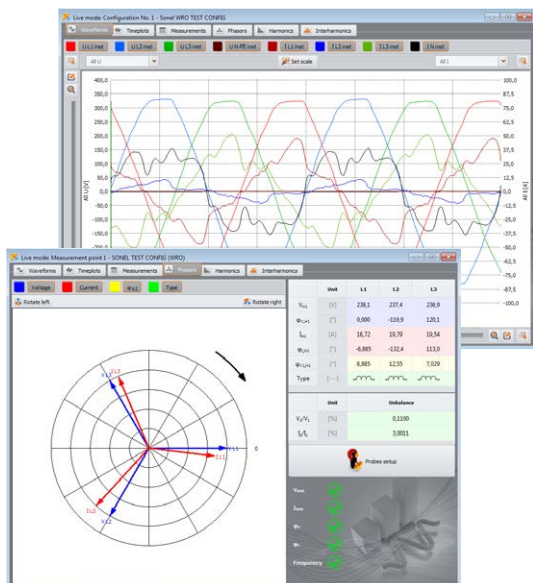
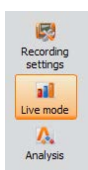

Change settings if necessary



9 Finish recording

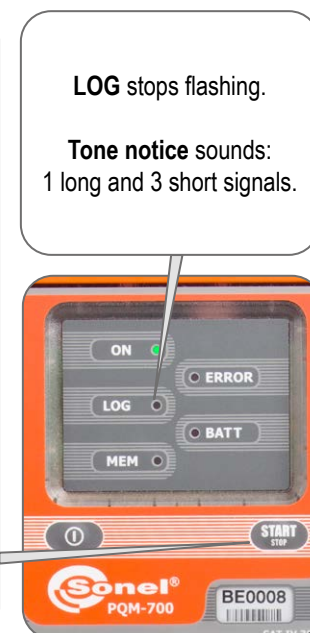
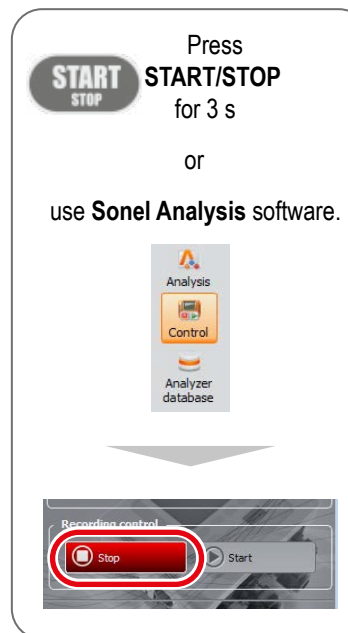

Data analysis

1 Download data from the analyzer

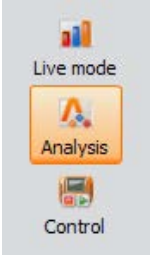

- Connect the analyzer.
- Select menu **Analysis**.

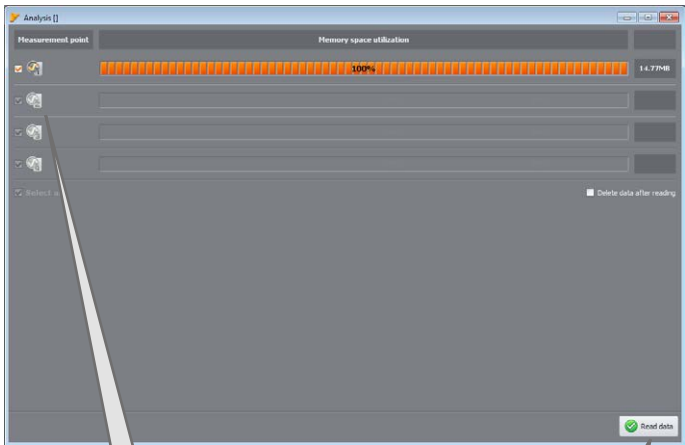

Choose the recording for analysis.

Press **Read data** button.

The recording will be saved to your computer as a file *.pqm700.

2 Choose the recording for analysis

On the top bar choose the time range if necessary.

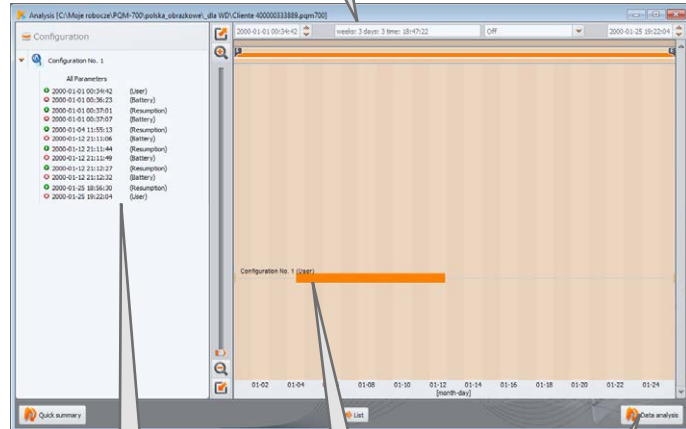

See the details of each downloaded recording.

Select the recorded data.

Press **Data analysis** button to see the measurements.

3 Analyze the data

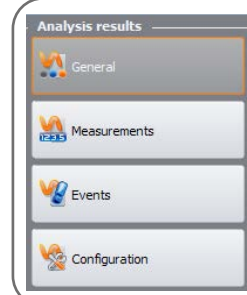

- There are four menu options to help you analyze the data:
- **General** - general information on the measurements,
 - **Measurements** - analyze the measurements, generate reports and plots,
 - **Events** - analyze the events,
 - **Configuration** - view, how the meter was set for the analyzed recording.

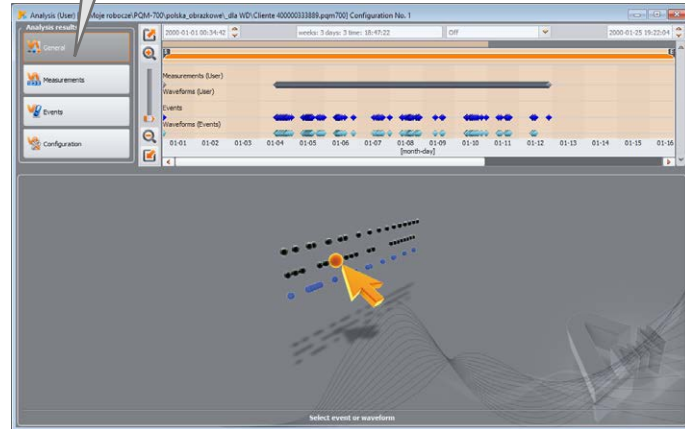

"General" menu

Ekran "Pomiary"

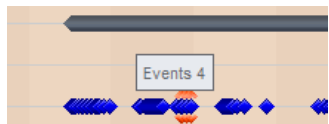

The top screen is the view of the whole recording.

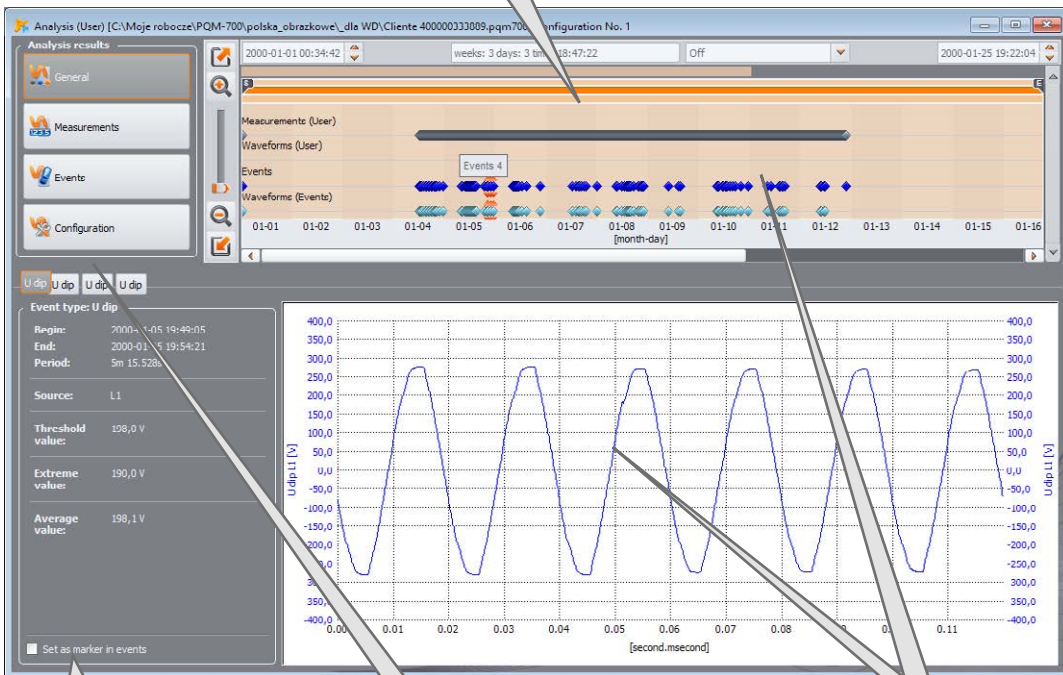

Set as marker in events

Mark the desired event to make it appear on the individual list in "Events" menu".

View event's details by choosing the correct tab.

Choosing a point in Events line will cause the oscillogram to appear.

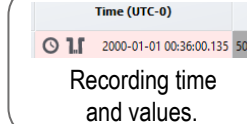

Recording time and values.

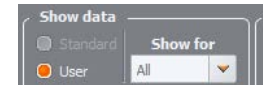

Choose data for analysis.



Filter phases from which you want to analyze data.

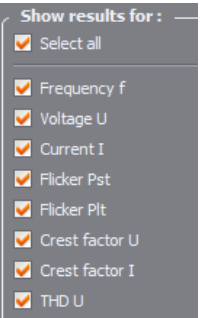
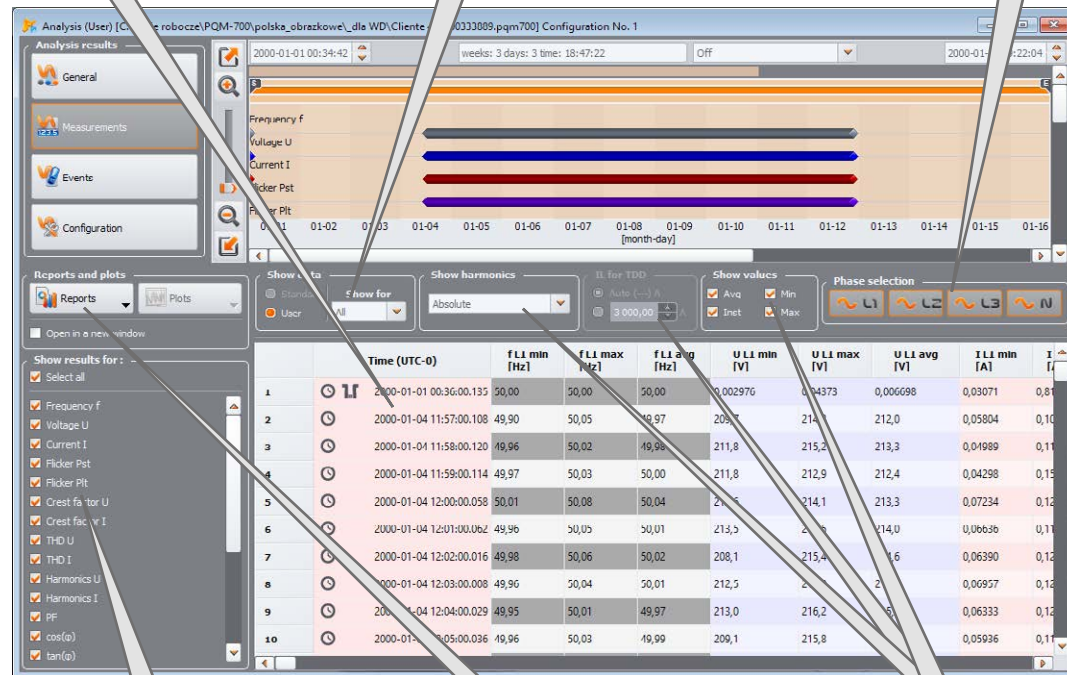

Here are groups of chosen parameters.

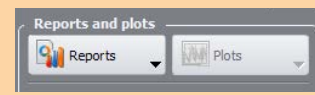

Choose the form of graph under menu **Plots**:

- timeplot,
- harmonics,
- interharmonics.

Create reports under menu **Reports**.

Choose the parameters for analysis.

ULLI min [V]	ULLI max [V]	ULLI avg [V]	ULLI min [V]
9 103	9 156	9 136	9 039
0 140	0 155	0 150	0 091

Mark columns for data analysis in order to create a plot or report.

Data analysis



Time plot

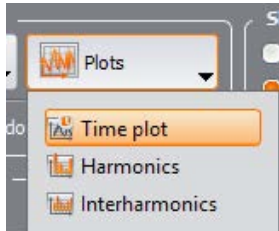

Choose the plot form. The graph will open in a new window.

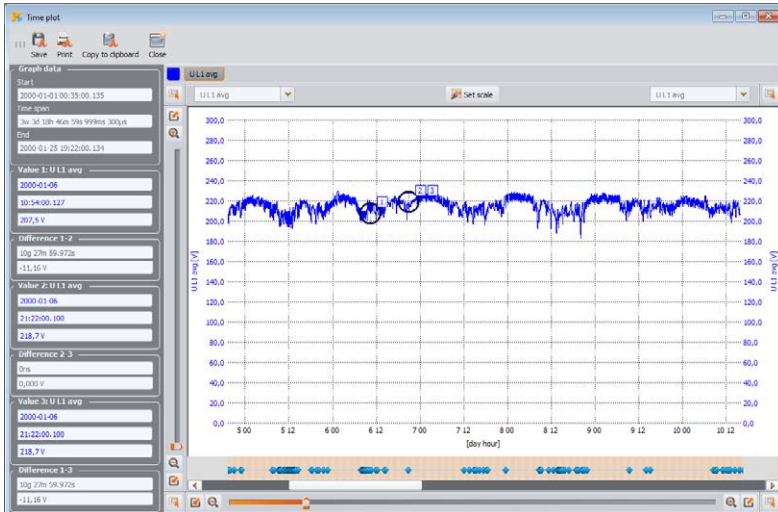

Creating reports

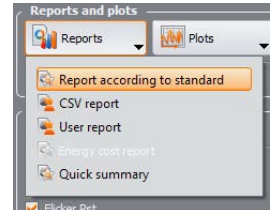

If the recording was made to verify compliance with a particular standard, choose **Report according to standard**, to create appropriate report.

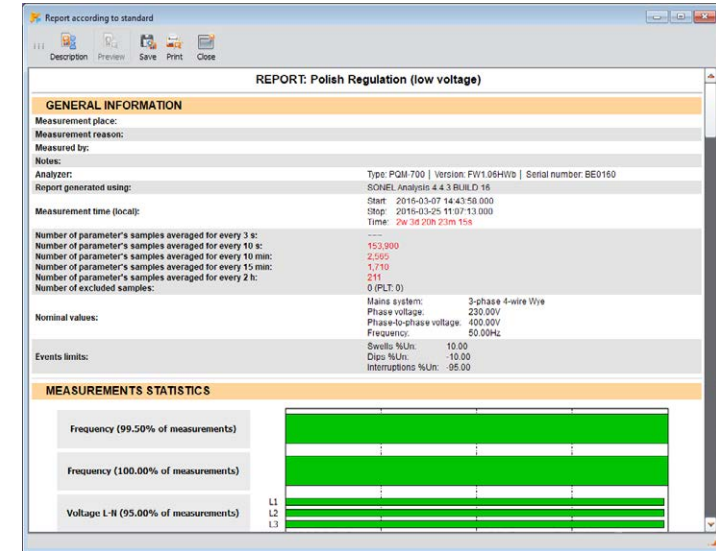

Harmonics and interharmonics

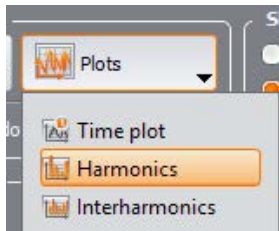

Choose appropriate plot to analyze harmonics or interharmonics.

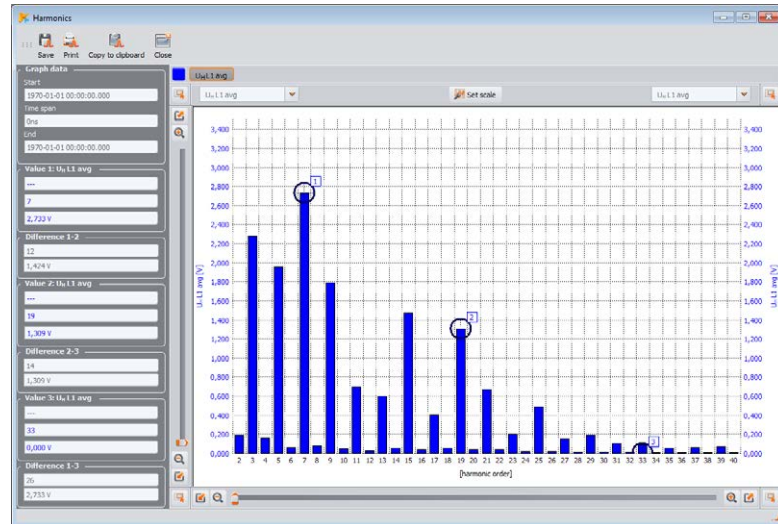

Data export to CSV file

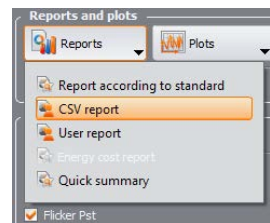

You can also export data directly to CSV file.

Nazwa	Typ	Data mo
Measurement 1	Microsoft Excel Comma Separated Values File	2019-05-
Measurement 2	Microsoft Excel Comma Separated Values File	2019-05-
Measurement 3	Microsoft Excel Comma Separated Values File	2019-05-

	A	B	C	D	E	F	G	H	I	J	K	L	M
1	Analyzer	PQM-700 (BE0702)											
2	Recording start:	01 01 2000 00:36											
3	Recording stop:	25 01 2000 19:22											
4	Time:	(UTC+0)											
5	Flag:												
6	E - event												
7	P - PLL no synchronization												
8	G - GPS no synchronization												
9	T - time resynchronization												
10	A - A/D overflow												
11													
12													
13													
14													
15													
16													
17													
18													
19													
20													
21													
22													
23													
24													
25													
26													
27													
28													
29													
30													
31													
32													
33													

"Events" menu

This menu contains the list of events that occurred during the recording.

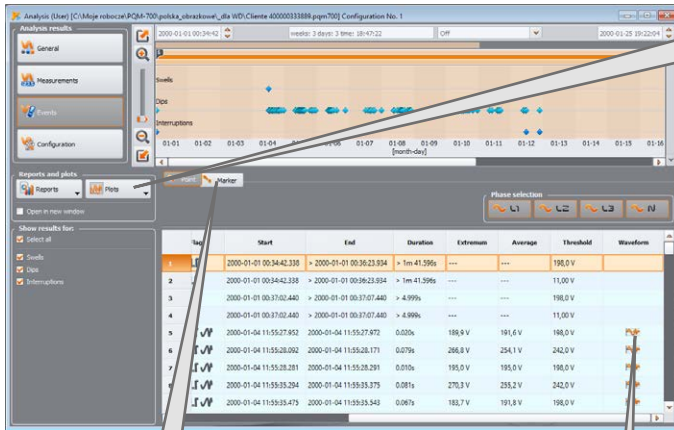

Find the list of events marked in "General" menu under tab **Marker**.

Choosing the **Oscillogram** icon will open two windows:

- timeplot for that event,
- waveform for that event.

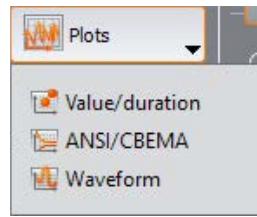
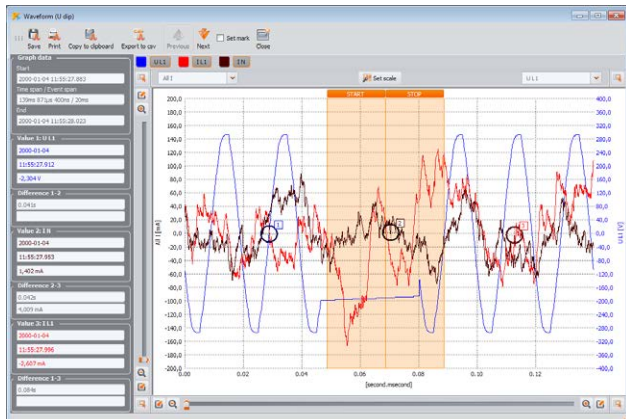

Using **Plots** button select the type of data presentation:

- value/duration,
- in the context of ANSI/CBEMA toleration curves,
- waveform for oscillograms and $RMS_{1/2}$ plots.

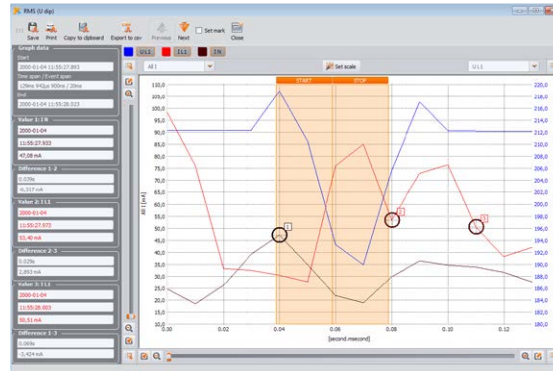
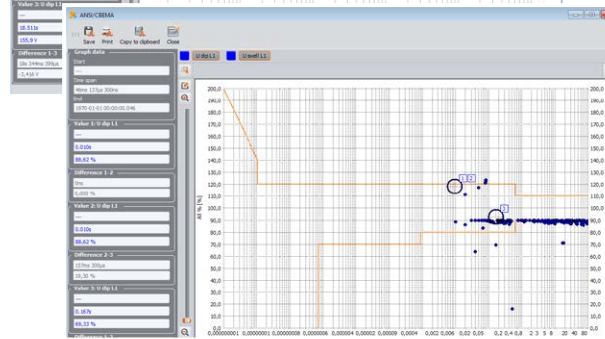
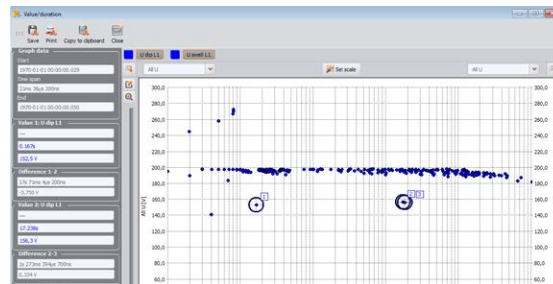

"Configuration" menu

View, how the analyzer was set for the analysed recording.

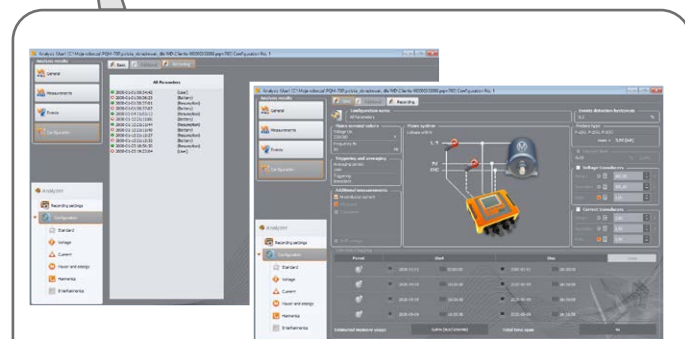
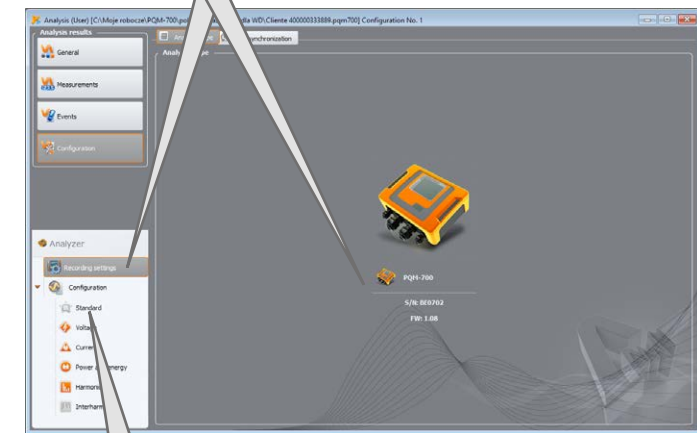
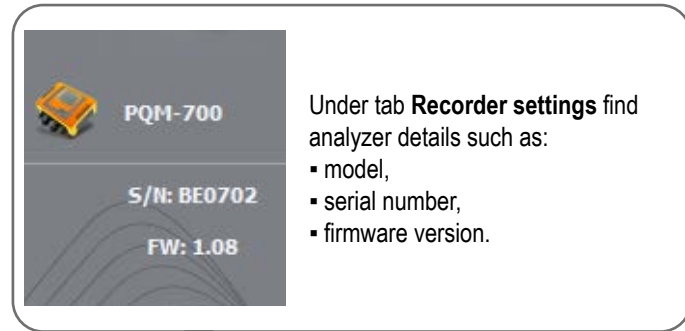

Find all recording settings under tab **Configuration**.



Find more information in the
user manual and on our website
www.soneel.pl/en