

USER MANUAL

PORTABLE APPLIANCE TESTERS

PAT-80 • PAT-85 • PAT-86

PAT-80 / 85 / 86

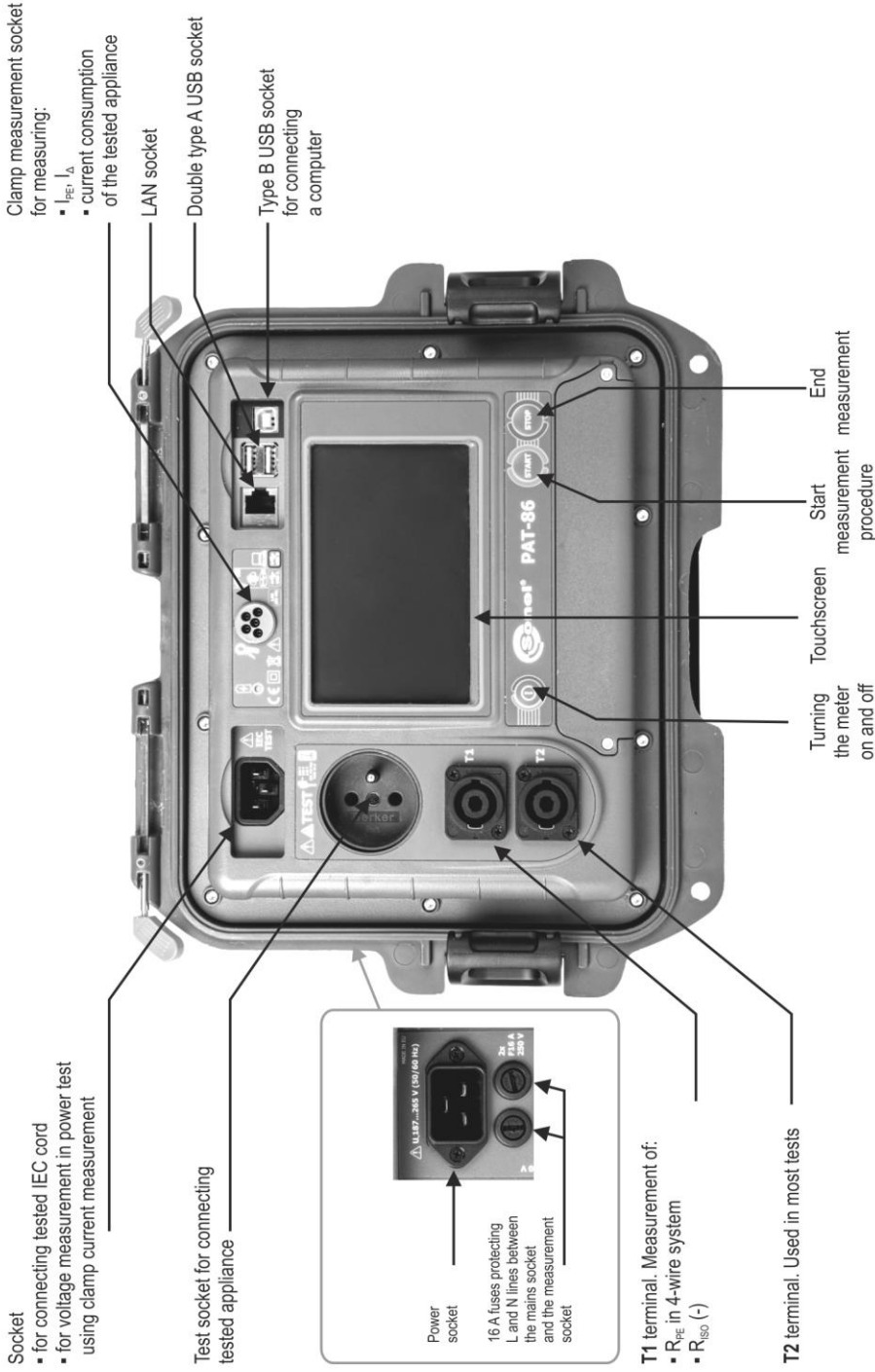

Socket

- for connecting tested IEC cord
- for voltage measurement in power test using clamp current measurement

Test socket for connecting tested appliance

Clamp measurement socket for measuring:

- I_{PE} , I_{Δ}
- current consumption of the tested appliance

LAN socket

Double type A USB socket

Type B USB socket for connecting a computer

Power socket

16 A fuses protecting L and N lines between the mains socket and the measurement socket

T1 terminal. Measurement of:

- R_{PE} in 4-wire system
- R_{SD} (-)

T2 terminal. Used in most tests

Turning the meter on and off

Touchscreen

Start measurement procedure

End measurement



USER MANUAL

PORTABLE APPLIANCE TESTERS PAT-80 • PAT-85 • PAT-86



**SONEL S.A.
Wokulskiego 11
58-100 Świdnica**

Version 1.12 05.07.2023

PAT-80/85/86 tester is a modern, high-quality tester, easy and safe in operation. Please acquaint yourself with the manual in order to avoid measuring errors and prevent possible problems related to operation of the tester.

CONTENTS

1	Safety	5
2	General description and features of the instrument	6
3	Switching on and main menu	8
3.1	Power supply	8
3.2	Start test after switching the tester on	8
3.3	General settings – menu	9
3.3.1	Symbols on screen	10
3.3.2	Setting date and time	11
3.3.3	Interface settings. QR-code scanner initialization	12
3.3.4	Measurement settings	13
3.3.5	Printing	14
3.3.6	Specifications	16
3.3.7	Information about tester and producer	17
3.3.8	Firmware update	17
3.3.9	Service	18
3.3.10	WiFi settings	19
3.3.11	Bluetooth settings	21
3.3.12	Backup	21
3.3.13	PAT Server (optional function)	22
3.3.14	Remote control (optional function)	23
3.3.15	List of Users	24
a.	Managing Users	24
b.	Switching Users	25
3.3.16	Memory structure (clients, objects, subobjects and appliances)	26
a.	Adding clients	26
b.	Adding objects	28
c.	Adding appliances	30
d.	Deleting clients, objects and appliances	31
3.3.17	Communication with PC	32
4	Measurements	33
4.1	Visual check (preliminary test)	33
4.2	Measurement of protective conductor resistance R_{PE}	34
4.3	Measurement of insulation resistance R_{ISO}	38
4.4	Measurement of substitute leakage current I_{SUB}	41
4.5	Measurement of leakage current I_{PE}	43
4.6	Measurement of differential leakage current I_{Δ}	46
4.7	Measurement of touch leakage current I_T	49
4.8	Measurement of current with clamp	51
4.9	IEC cord test	52
4.10	Testing PRCD devices (with built-in RCD)	53
4.11	Measurement of fixed RCD parameters	54
4.12	SELV/PELV appliances test	56
4.13	Power test	57
5	PAT-86 Measurement of welding machines	59
5.1	Measurement of R_{ISO} (LN-S, PE-S) in welding machines	59
5.2	Measurement of leakage current I_P in welding machines	61

5.3	Measurement of welding circuit leakage current I_L	64
5.4	Welding machine voltage without load U_0	65
6	Automatical tests	67
6.1	Configuring automatical tests	67
6.2	Automatical tests	68
6.3	Multibox function.....	70
6.3.1	Multibox OFF.....	70
6.3.2	Multibox ON	71
7	Memory of measurement results	72
7.1	Storing the measurement results in the memory.....	72
7.2	Browsing memory data	73
7.3	'Search' option in the memory	75
7.4	Moving appliance into another object.....	76
7.5	Copying client's data from memory into USB drive back and forth.....	77
7.6	Deleting memory data	78
7.7	Meter's data backup	79
8	Label printing.....	80
8.1	Printing availability.....	80
8.2	Label types.....	81
9	Power supply	81
10	Cleaning and maintenance.....	81
11	Storage	82
12	Dismantling and Disposal	82
13	Technical data.....	82
13.1	Basic data.....	82
13.1.1	Measurement of network parameters	82
13.1.2	Measurement of PE resistance.....	83
13.1.3	Measurement of insulation resistance	84
13.1.4	Measurement of leakage current.....	86
13.1.5	Testing RCDs / PRCDs	88
13.1.6	Power test.....	89
13.1.7	PAT-86 Measurement of welding machine voltage without load	90
13.2	Other technical data	91
14	Optional accessories	92
15	Manufacturer.....	93

PAT-86 The icon with the meter name is placed next to sections of the text that refer to specific features of the device. All other parts of the text relate to all types of the device.

1 Safety

PAT-80/85/86 testers are designed for performing check tests, providing results which determine the safety status of electrical equipment. Therefore, in order to provide conditions for correct operation and the correctness of the obtained results, the following recommendations must be applied:

- Before you commence operating the tester, acquaint yourself thoroughly with the present manual and observe the safety regulations and specifications determined by the manufacturer.
- Any application that differs from those specified in this manual may result in a damage to the device and constitute a source of danger for the user.
- PAT-80/85/86 tester must be operated only by appropriately qualified personnel. Operating the tester by unauthorised personnel may result in damage to the device and constitute a source of danger for the user.
- Using this manual does not exclude the need to comply with occupational health and safety regulations and with other relevant fire regulations required during the performance of a particular type of work. Before starting the work with the device in special environments, e.g. potentially fire-risk/explosive environment, it is necessary to consult it with the person responsible for health and safety.
- It is forbidden to operate the following:
 - ⇒ A damaged tester which is completely or partially out of order,
 - ⇒ A tester with damaged test leads insulation,
 - ⇒ A tester stored for an excessive period of time in disadvantageous conditions (e.g. excessive humidity). If the tester has been transferred from a cool to a warm environment with a high level of relative humidity, do not start measurements until the tester is warmed up to the ambient temperature (approximately 30 minutes).
- The tester may be powered only from grounded mains sockets.
- Before starting any measurement, make sure the test leads are connected to the proper test sockets.
- Do not touch the tested device during measurements.
- Test sockets and the socket for testing IEC cords are protected against improper connection to the voltage up to 300 V AC for 60 seconds.
- Repairs may be carried out only by an authorised service point.



NOTE!

Only dedicated accessories for a given device should be used. Use of different accessories can lead to errors in the test connection and can introduce additional measurement uncertainties.



- Due to continuous development of the tester's software, the actual appearance of the display, in case of some of the functions, may slightly differ from the display presented in this operating manual.
- An attempt to install drivers in 64-bit Windows 8 may result in displaying "Installation failed" message.
 - o **Cause:** Windows 8 by default blocks drivers without a digital signature.
 - o **Solution:** Disable the driver signature enforcement in Windows.

2 General description and features of the instrument

PAT-80/85/86 digital tester is intended to measure the basic parameters of portable electrical appliances (power tools, household appliances, etc.) important for their safety: protective conductor resistance, insulation resistance, continuity of connections, leakage current and RCDs.

The tester may be used to test equipment in accordance with the following standards:

- EN 60745-1 Hand-held motor-operated electric tools. Safety. Part 1: General requirements.
- EN 61029 Safety of transportable motor operated electric tools. General requirements.
- EN 60335-1 Household and similar electrical appliances. Safety. Part 1: General requirements.
- EN 60950 Information technology equipment – Safety- Part 1: General requirements.
- EN 61557-6 Electrical safety in low voltage distribution systems up to 1000 V AC and 1500 V DC - Equipment for testing, measuring or monitoring of protective measures - Part 6: Effectiveness of residual current devices (RCD) in TT, TN and IT systems.
- VDE 0404-1 Testing and Measuring Equipment for Checking the Electric Safety of Electric Devices - Part 1: General Requirements.
- VDE 0404-2 Testing and Measuring Equipment for Checking the Electric Safety of Electric Devices - Part 2: Testing Equipment for Tests after Repair, Change or in Case of Repeat Tests.
- VDE 0701-0702 Inspection after Repair, Modification of Electrical Appliances. Repeat Testing of Electrical Equipment. General Requirements for Electrical Safety.
- AS/NZS 3760:2010 In-service safety inspection and testing of electrical equipment.

Basic functions of the instrument

Measurement of network voltage and frequency

Measurement of protective conductor resistance (protection class - I)

- technical measurement method
- measurement with sinusoidal current of network frequency and following currents:
 - 200 mA
 - **PAT-85 PAT-86** 10 and 25 A
- adjustable measurement time
- adjustable upper limit in the range of: 10 mΩ...1.99 Ω with 0.01 Ω resolution

Measurement of insulation resistance

- Four test voltages:
 - **PAT-85 PAT-86** 100 V
 - 250 V, 500 V
 - **PAT-85 PAT-86** 1000 V
- measurement of insulation resistance up to 599 MΩ
- automatic discharge of the capacitance of tested object after the insulation resistance measurement is completed
- adjustable measurement time
- adjustable lower limit within the range of 0.1 MΩ...9.9 MΩ with 0.1 MΩ resolution

Measurement of substitute leakage current

- adjustable measurement time
- adjustable upper limit in the range of: 0.01 mA ... 9.9 mA with 0.01 mA / 0.1 mA resolution

Measurement of PE leakage current

- adjustable measurement time
- adjustable upper limit in the range of: 0.01 mA ... 9.9 mA with 0.01 mA / 0.1 mA resolution
- measurement of the current with clamp

Measurement of differential leakage current

- adjustable measurement time
- adjustable upper limit in the range of: 0.01 mA ... 9.9 mA with 0.01 mA / 0.1 mA resolution
- measurement of the current with clamp

Measurement of touch leakage current

- adjustable measurement time
- adjustable upper limit in the range of: 0.01 mA ... 1.99 mA with 0.01 mA / 0.1 mA resolution

PAT-86 **Measurement of welding machine parameters**

- primary circuit leakage current I_P
- welding circuit leakage current I_L
- U_{RMS} voltage
- U_P voltage (DC and AC_{peak})

Measurement of power P, Q and S

- adjustable measurement time
- measurement of power factor PF
- measurement of $\cos\phi$
- measurement of THD of voltage and current

Measurement of current consumption

- Measurement with the device's internal measurement circuits or with clamp

Measurement of RCD / PRCD parameters

- time-delayed and general
- $I_{\Delta n} = 10 \text{ mA}, 15 \text{ mA}, 30 \text{ mA}$
- measurement of I_A current and RCD tripping time t_A for $0.5 I_{\Delta n}, 1 I_{\Delta n}, 2 I_{\Delta n}, 5 I_{\Delta n}$

Visual test

IEC cord test

Furthermore:

- automatic selection of measuring range
- tree structure of measurement results memory with provision of printing or transferring the results to PC via USB link
- configurable with a QR-code scanner and printer
- power supply sustained for ca. 1 hour after disconnecting mains power supply with the use of built-in battery
- ergonomic operation

3 Switching on and main menu

3.1 Power supply

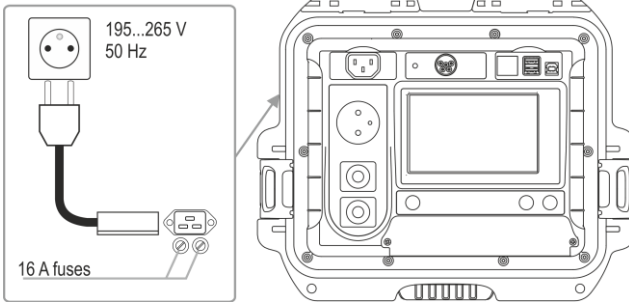

The device is powered from mains 195...265 V, 50 Hz.

Two 16 A fuses protect L and N lines from the supply socket to the test socket. They are tripped when current consumption from the test socket is too high (>16 A).

3.2 Start test after switching the tester on

After switching on, the tester performs a self-test to check its correct operational condition. When this test is successfully completed, the tester automatically performs the following measurements:

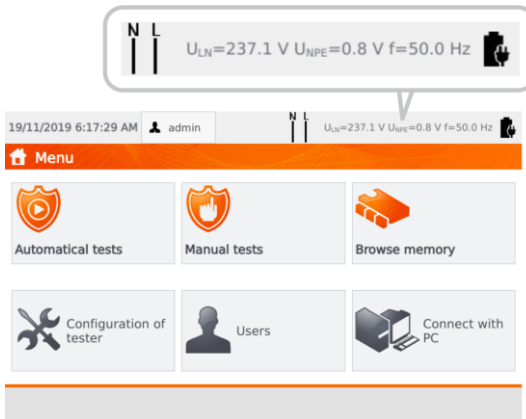

- voltage between L and N of power supply,
- measurement of mains frequency,
- checking the continuity PE in the power supply socket,
- measuring the voltage between N and PE in the power supply socket,
- indicates swapped L and N terminals

Upon completing above mentioned measurements, main menu screen is displayed. On the right upper corner of the screen mains network monitor is presented. It shows polarity of the power supply, voltage between N and PE, voltage between L and N, as well as mains frequency.



For mains voltages below 195 V and above 265 V all test functions are automatically blocked.

Additional information displayed on the screen

Voltage on the meter!	Voltage $U_{N-PE} > 25 \text{ V}$ or lack of PE continuity, measurements are blocked.
Message Too high U L-N! and audible signal	Mains voltage $> 265 \text{ V}$, measurements are blocked.
	Correct polarity of power supply (L and N), measurements possible.
	Incorrect polarity of power supply, swapped L and N in the power supply socket of the tester. The meter automatically swaps L and N in the test socket – measurements are possible.



Error message indicating incorrect voltage frequency may be caused by supplying power from an unstable voltage source (e.g. generator).

3.3 General settings – menu

In the menu the following actions are available:

- automatical tests,
- manual tests,
- memory browsing,
- configuration of tester:
 - date and time: setting date and time,
 - interface: switching on/off audible signals, choosing language,
 - measurements: setting nominal mains voltage and additional options,
 - prints: printing settings,
 - specifications,
 - info about tester and producer,
 - update: firmware upgrade,
 - service (service mode),
 - network setting: WiFi configuration,
- list of users,
- connection with PC.



- Settings are saved and remembered after switching off the tester.
- **Automatical tests**, **Manual tests** and **Browsing memory** are described in other chapters of this manual.

3.3.1 Symbols on screen

Measurements



connect measurement probe to the object



appliance under test must be switched on



WARNING: mains voltage in the measurement socket of the tester during the measurement, appliance under test will switch on and go



press START to start the test

READY!

the tester is ready to commence the test

TEST IN
PROGRESS

test procedure is in progress

Interface



go back to the main menu



add new element (client, site, appliance) / another measurement in Multibox function



save data (select appliance when saving to memory)



opening object or appliance data



deleting object or appliance



moving appliance into other object



go to USB flash drive memory (visible only if a USB flash drive is inserted)



go to meter memory (visible only if a USB flash drive is inserted)



save to USB flash drive memory (visible only if a USB flash drive is inserted)



save records from USB memory to the meter



move one level up



previous screen / window



next screen / window



close the window without saving changes



searching (e.g. client, object, appliance)



help



editing data of the selected element (e.g. client, site, appliance)



checkbox. Symbol  inside the square means that the selected option is on or given content assigned to this field has been confirmed and is correct



commencing the measurement



connection with selected WiFi network (see **sec. 3.3.10**)

3.3.2 Setting date and time

① Press **Configuration of tester**.

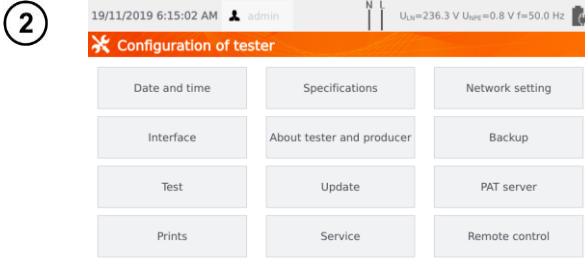

Press **Date and time**.

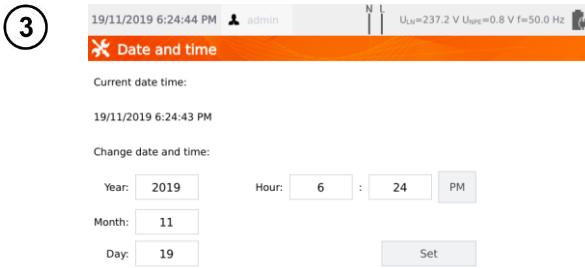

Press the field you intend to change.

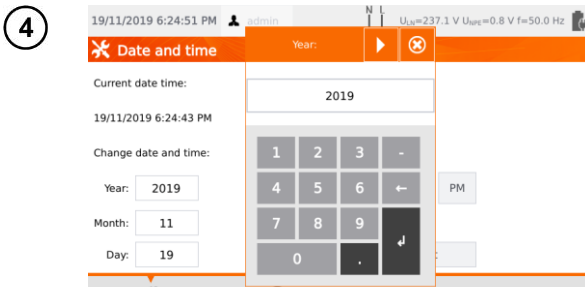

In the date edit window type in proper value. Press **▶** to proceed to editing next parameter. **Enter** saves changes and closes the window.

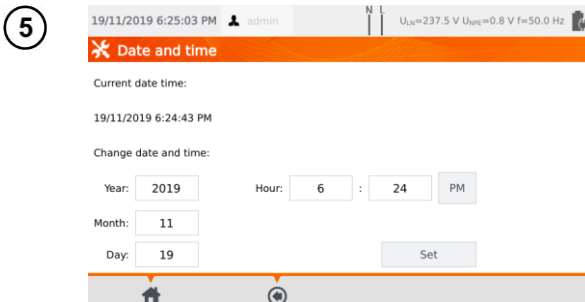

After entering new values press **Set** to confirm the date and time settings.

3.3.3 Interface settings. QR-code scanner initialization

① Press **Configuration of tester**.

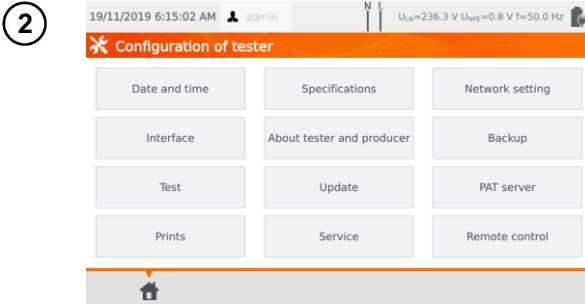

Press **Interface**

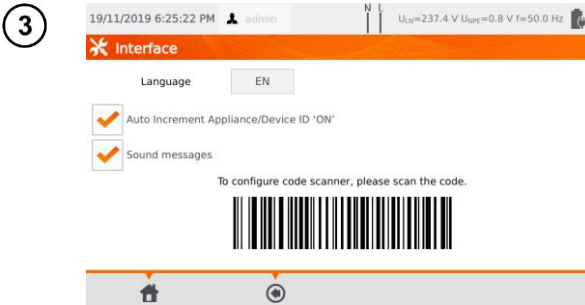

By checking the box **Auto Increment Appliance/Device ID**, you will enable or disable the automatic transmission of the next registration number assigned to the next device being added.

The **Sound messages** field enables or disables the sound signals.

The **Language** field allows you to select a language.

To initialize the QR code scanner on the meter, connect the scanner and scan the displayed code with it.

3.3.4 Measurement settings

1 Press **Configuration of tester**.

2  Select **Test**.

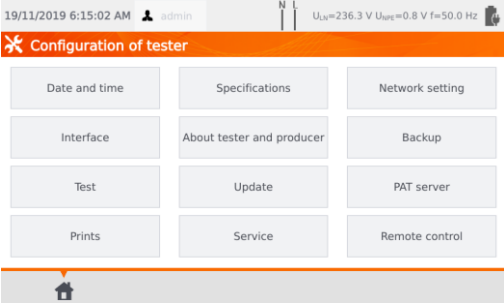

3  Tick checkboxes corresponding to the desired options.

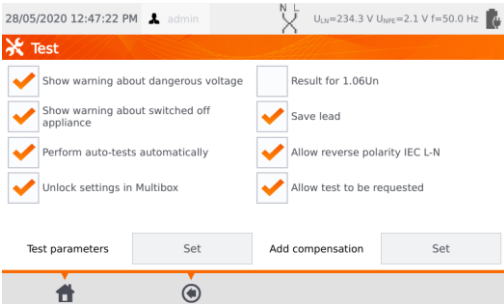

Then **set test parameters**:

- ⇒ type, frequency and voltage of the mains that the meter is powered from,
- ⇒ measurement delay.

Warnings

Show warning about dangerous voltage – switch on/off warnings about the possibility of the voltage being dangerous to user that may appear during tests.

Show warning about switched off appliance – switch on/off notification that the tested appliance is not connected or it's not turned on.



NOTE!

It is advised for less experienced users to keep all the above warnings on.

Auto-tests

Perform auto-tests automatically – switch on/off automatic mode of performing autotests, which is performing the complete set of autotests after single press of **START** button.



NOTE!

It is advised for less experienced users to keep all the above warnings on.

Polarity IEC L-N:

Allow reverse polarity IEC L-N – allows interchanging of L and N lines in the tested IEC cord. The test result is displayed as positive.

Substitute leakage current measurement

Mains nominal voltage – is used to calculate the I_{SUB} equivalent leakage current according to the formula:

$$I_{SUB} = (I_{MEASURED} \times U_n) / U_{MEASURED}$$

Result for 1.06Un – the result of I_{SUB} measurement is multiplied by 1.06, which is required by some standards.

Power cord for the appliance

Save lead – after ticking this box, the power cord is saved in the memory and printed on a printout as a separate appliance. Otherwise it is considered as an integral part of the appliance.

Unlock settings in Multibox – if Multibox is switched on, the option enables changing the measurement settings during the autoprocure realization, however this change is possible only after the first measurement of a given quantity.

Add compensation – compensation of test leads resistance. Various values in depending on the measuring current (200 mA, 10 A, 25 A).

Delay – the delay between powering the tested object and starting a measurement.

3.3.5 Printing

① Press **Configuration of tester**.

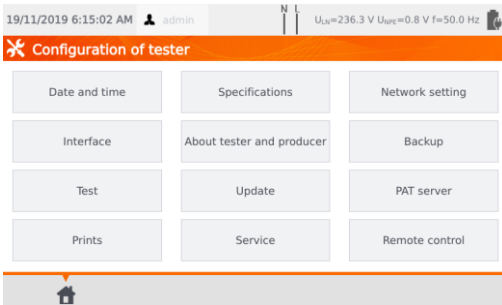

Press **Prints**.

③

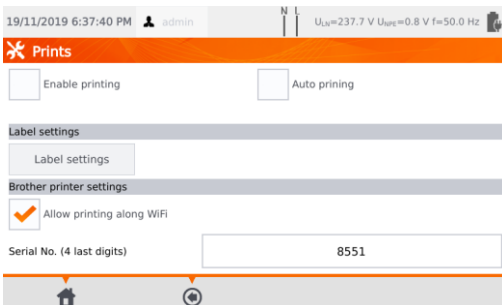

In the main window you can manage communication with printers.

Enable printing - enables / disables printer support.
Auto printing - automatic printing after the test.

If you want to connect to your Brother D3 printer via WiFi, you must enter the last 4 digits of its serial number in the **Serial No.** field.

Select **Label settings** to decide what to print on the labels.

4

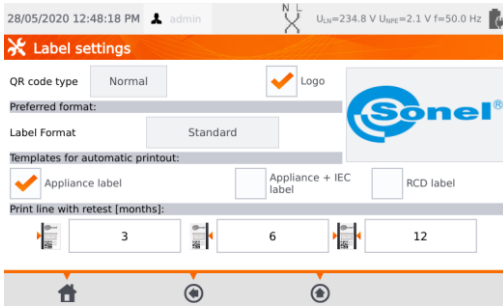

Select desired options by ticking empty squares.

QR code type

Normal – stores all information about the tested device: ID, name, measurement procedure number, technical data, location in memory, etc.

Shortened – stores only the ID of the tested device and its location in the meter memory.

Logo

Placing logo on the print-out. Logo can be changed by using **Sonel Reader** software.

Preferred format

Detailed – contains a list of questions of the visual examination together with the assessment and the results of individual measurements with the assessment.

Standard – includes overall result of the test, logos and additional data (name of the device, measuring person).

Shorted – similar to standard format but without the logo and additional information.

Mini – only the identifier, name and QR code of the tested device are printed.

Templates for automatic printout

Appliance label – label with a test result of an appliance.

Appliance + IEC label – label with a test result of an appliance and IEC power cord.

RCD label – label with an RCD test result.

Print line with retest [months]

Printing stripe on the left, right, or both sides of the label, depending on the number of the months, after which retest of the appliance must be done. The number of months is selected by clicking on proper field.

3.3.6 Specifications

In this place basic technical data of the meter are displayed.

① Press **Configuration of tester**.

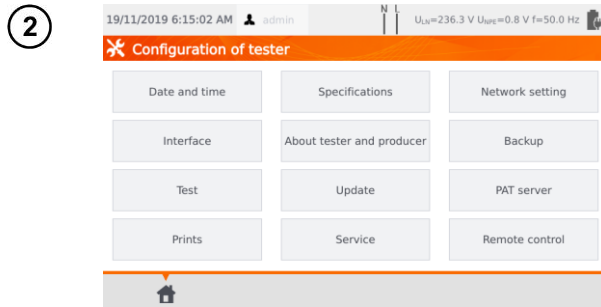

Press **Specifications**.

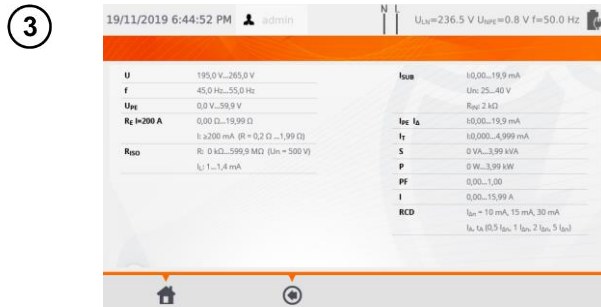

3.3.7 Information about tester and producer

1 Press **Configuration of tester**.

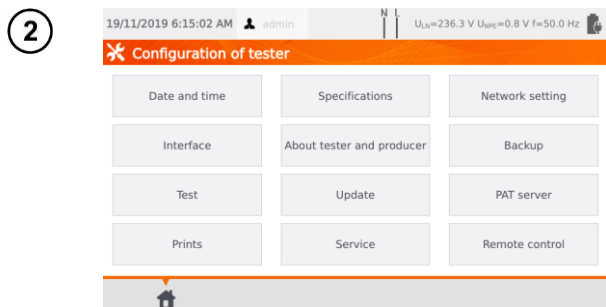

Press **About tester and producer**.



The tester data and the producer information window.

3.3.8 Firmware update

The tester's firmware update is done via WiFi or via an update package downloaded from the manufacturer's website. The package has to be saved to an USB stick. To avoid accidental deletion of the user memory, it is recommended to back it up before starting the update (**sec. 7.7**).

1 Press **Configuration of tester**.

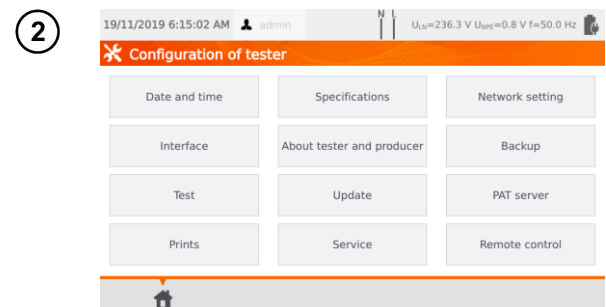

Press **Update**.

3

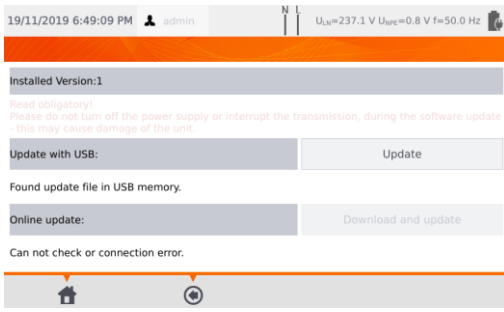

Read the warning message. To perform an update:

- ⇒ insert the USB drive with the update files and click **Update** or
- ⇒ ensure Internet connection of the meter via WiFi, and select **Download and update**.

4

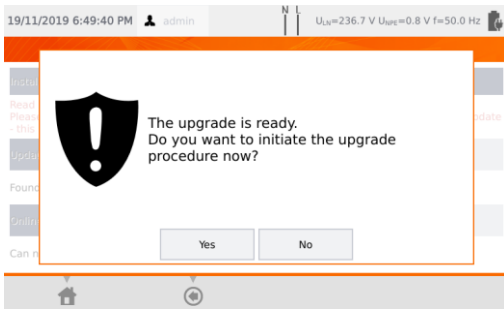

Press Yes.

5



Firmware upgrade is performed automatically. It can be completed in several stages. During the update procedure it is not allowed both to remove USB flash drive and switch off the tester.

The updating/configuring changes process is continued and will last until main menu screen comes up.

6

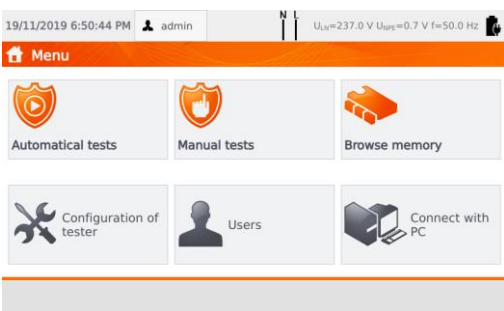

Only at this stage it is allowed to switch off the power supply or to start using the tester.

3.3.9 Service

This function is available solely for service and protected with password.

3.3.10 WiFi settings

1 Press **Configuration of tester**.



Select **Network setting**, and then **WiFi**.

3

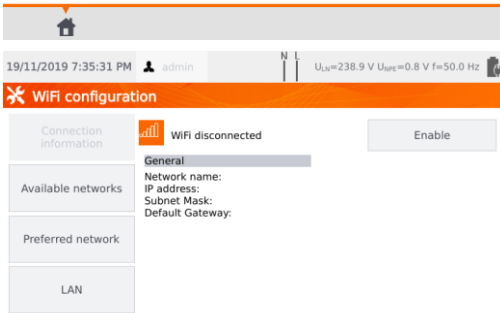

To get information about local active WiFi networks press **Available networks**.

4

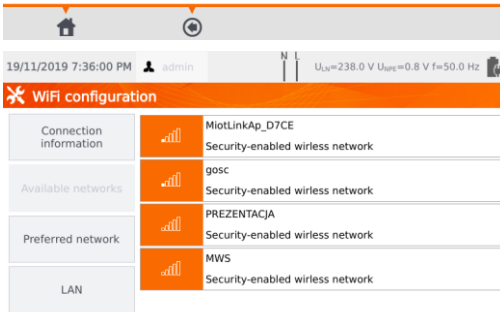

A network requiring the password was found.

5

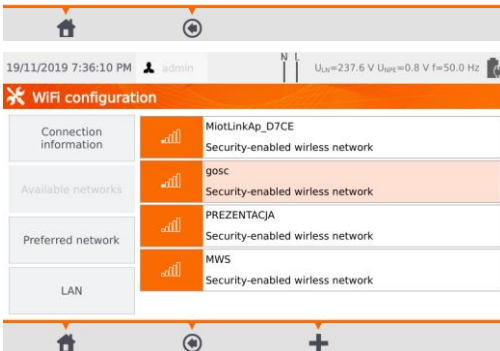

To add the found WiFi network to the memory, select it and press **+**.

6

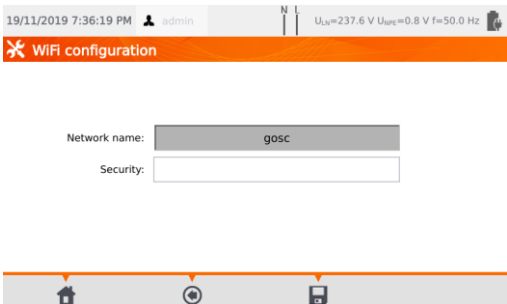

Type password required for this network and press .

7

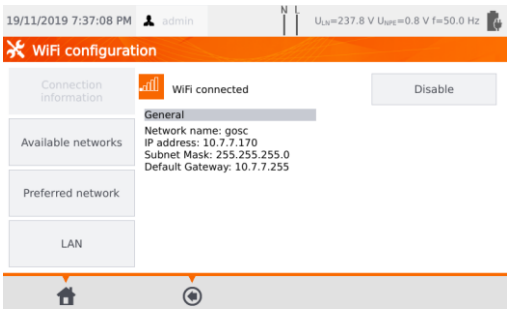

The network is saved and connection with the tester is established - connection's parameters are available.

The button **Disable/Enable** turns on or off the WiFi module in the tester.

8

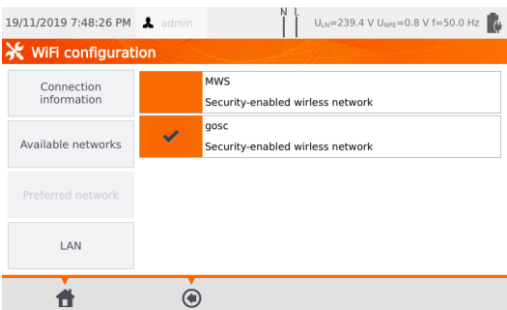

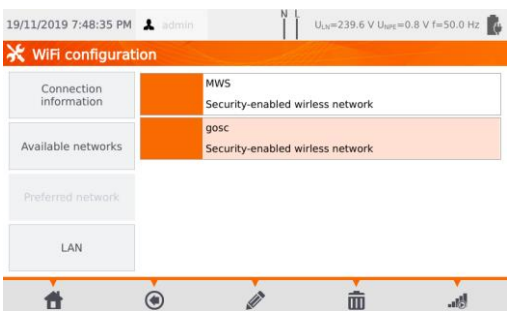

Pressing **Preferred network** enables displaying networks saved already in the tester. The network marked with ✓ is the network currently connected with the tester.

9



After selecting a network icons appear:

- ⇒  (**Connect**) - connection with the selected network (provided it is active on this territory),
- ⇒  (**Delete**) - removal of selected network,
- ⇒  (**Edit**) - changing of password.

10

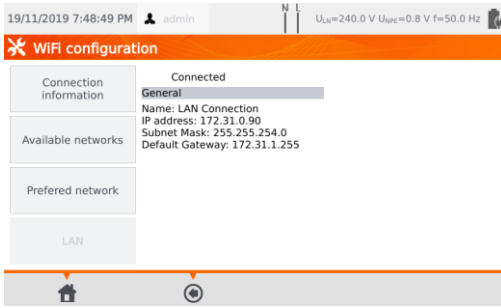

The **LAN** field displays a screen containing meter's IP in a situation, when it is connected to a LAN network.

3.3.11 Bluetooth settings

1

Press **Configuration of tester**.

2

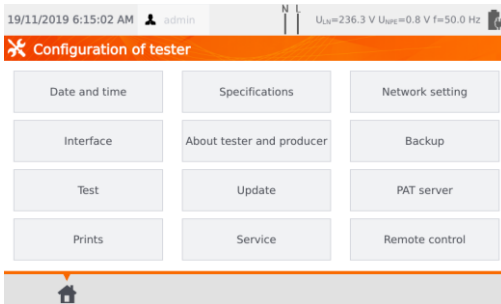

Select **Network setting**, and then **Bluetooth**.

3

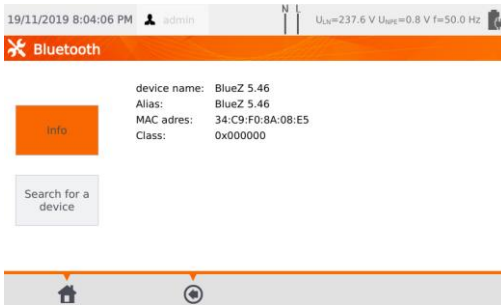

In the section **Info** information about the meter's Bluetooth module is displayed.

In the section **Search for a device** list of all devices with active Bluetooth module are displayed.

3.3.12 Backup

The function enables backing up and restoring data. A detailed description is worth in **sec. 7.7**.

3.3.13 PAT Server (optional function)

Using this menu, you can synchronize the meter with the PAT Server cloud service.

① Connect the meter to a network (sec. 3.3.10). Then select **Configuration of tester**.

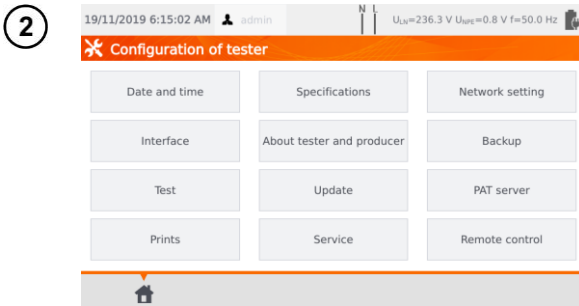

Select **PAT Server**.

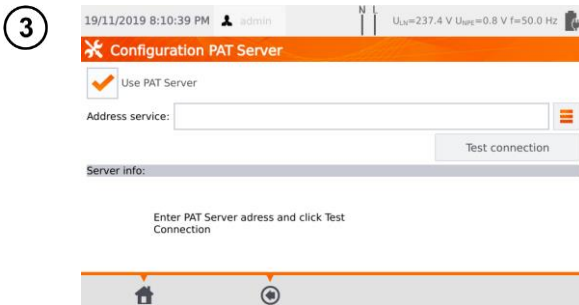

Check the box **Use PAT Server**.

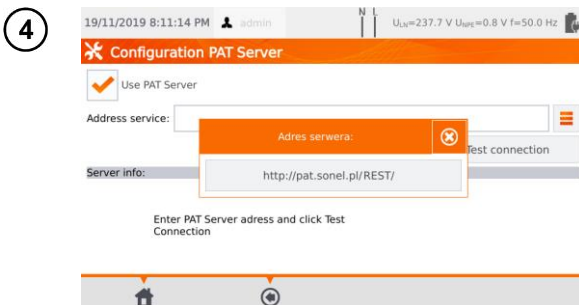

Enter server address. Under the icon  pre-defined addresses are placed.

5

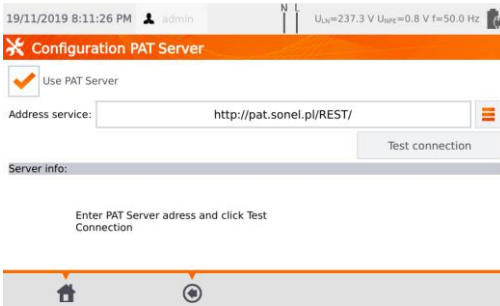

Enter PAT Server address and click Test Connection



Then select **Test connection**.

- PAT Server application provides:
- data storage on the server,
 - assigning tasks,
 - unlimited access to the software,
 - immediate reporting,
 - taking care of the crew and fleet,
 - access control,
 - the ability to work with a constant connection to the system.

3.3.14 Remote control (optional function)

1

Press **Configuration of tester**.

2

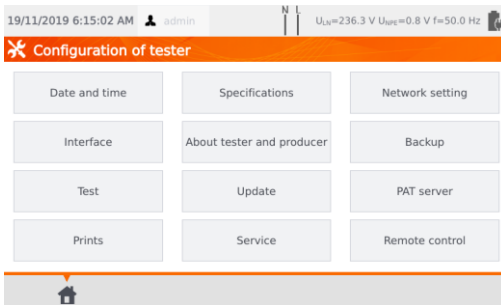

Select **Remote control**.

3

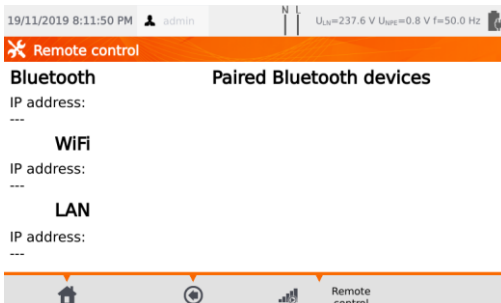

The window displays dedicated Bluetooth devices that provide remote control of the meter.

3.3.15 List of Users

Users are introduced to signing test's performers. The tester can be used by many people. Each person can log in with his own login and password. Passwords are introduced to prevent the signing of the test someone else's name. Only Administrator can add and delete users. Others can only change their own data.

a. Managing Users

1 Press **Users**.

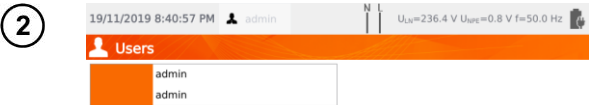

To add a User press **+**.

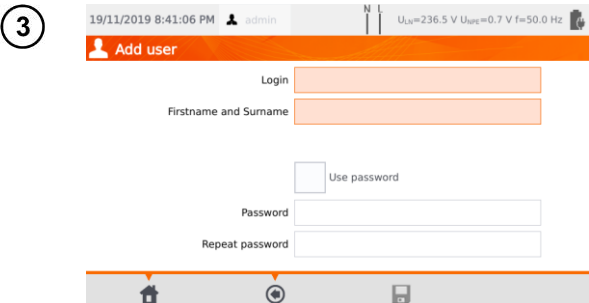

Pressing a field brings up the keyboard (see 4), which allows to enter login, first name and surname.

If necessary, after selecting **Use password**, user can secure the access to the new account with a password.

Red fields are mandatory.

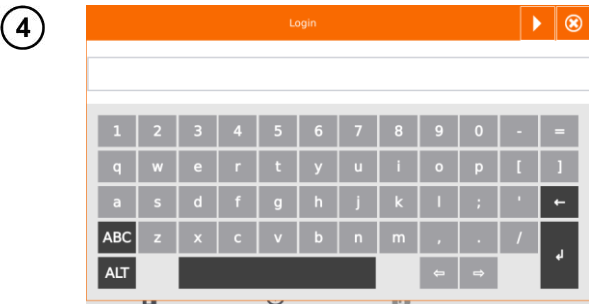



Press **▶** to proceed to next blank input data field without disabling the keyboard.

5

Confirm by pressing .

6

The padlock symbol means that the user is protected by a password.

To change User's data press .
To delete User's data press .



The tester remembers the last user if he/she is not protected by the password.

b. Switching Users

1

In order to change User, the current one has to log out: when you are in the main menu, press his name on the top of the screen, and then confirm the end of session.

2

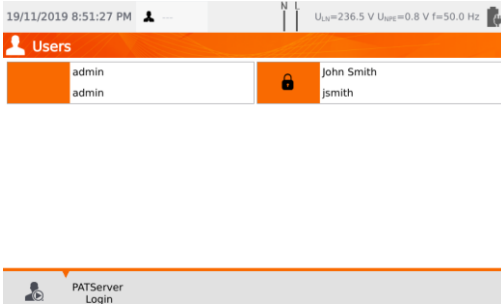

If you have:

- enabled PAT Server communication (sec. 3.3.13) and
 - connected with WiFi (sec. 3.3.10),
- then icon  is also available. It enables you to log in to the cloud user in the PAT Server service.

3.3.16 Memory structure (clients, objects, subobjects and appliances)

a. Adding clients

1

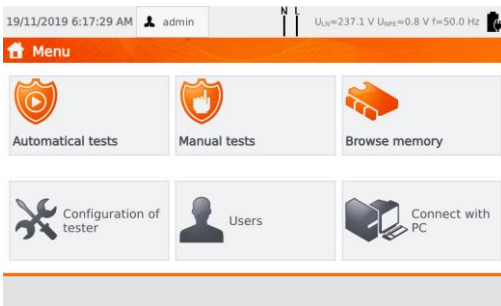

Press **Browse memory**.

2



To add new client press **+**.

3

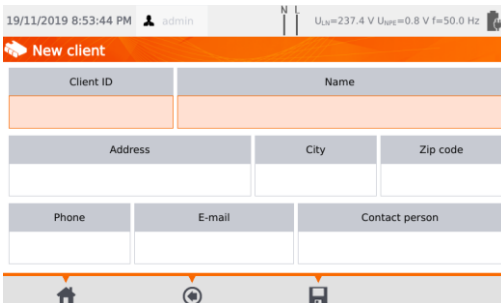

Press each field and enter client's data with on-screen keyboard. Data in red fields is mandatory.

4

Client ID

003

1	2	3	4	5	6	7	8	9	0	-	=
q	w	e	r	t	y	u	i	o	p	[]
a	s	d	f	g	h	j	k	l	;	'	←
ABC	z	x	c	v	b	n	m	,	.	/	↵
ALT											

Press to toggle between next and previous data field without disabling the keyboard.

After entering all data confirm the changes by pressing **Enter**. Press to close the window without saving changes.

5

19/11/2019 8:56:51 PM admin U_{Li}=237.5 V U_{LiN}=0.8 V f=50.0 Hz

New client

Client ID		Name	
003		SONEL S.A.	
Address		City	Zip code
Wokulskiego 11		Swidnica	58-100
Phone	E-mail	Contact person	
+48748583860	export@sonel.com	Adam Ris	

Press to save client's data.

6

19/11/2019 8:58:51 PM admin U_{Li}=237.5 V U_{LiN}=0.8 V f=50.0 Hz

Tester memory

Clients:		Information about client:
003	SONEL S.A. default.client	Client ID: 003 Name: SONEL S.A. Address: Wokulskiego 11 58-100 Swidnica Phone: +48748583860 E-mail: export@sonel.com Contact person: Adam Ris

New client has been added. To change client's data press (**Edit**).

b. Adding objects

1

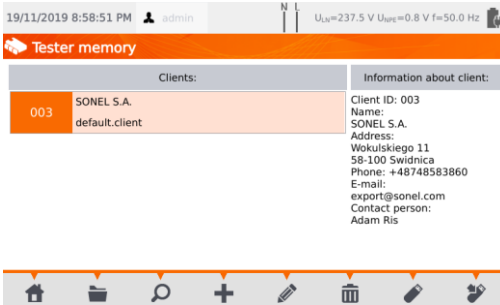

Enter the client or object:

⇒ Select client/object name and (Open) or

⇒ double-tap the name.

2



To add new object or appliance press .

3

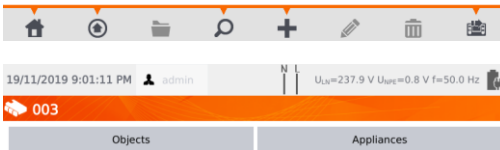

For adding new object press **Objects**.

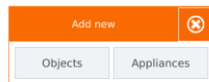

4

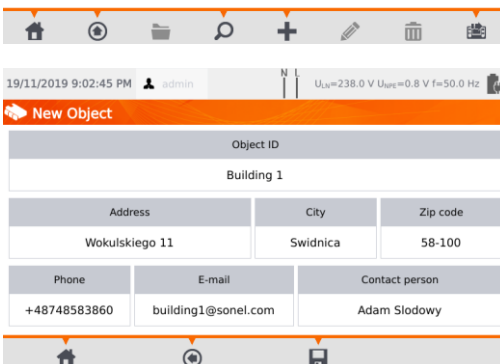

Enter object's data in the same way as when entering client's data. Filling data marked with red background is mandatory. Press to save object's data.

5





New site has been added. To change object's data press  (**Edit**).

To add subsite or appliance within the added already object (lower level), enter the site/subsite:

- ⇒ select the object's name and press  (**Open**) or
- ⇒ double-tap the object's name.

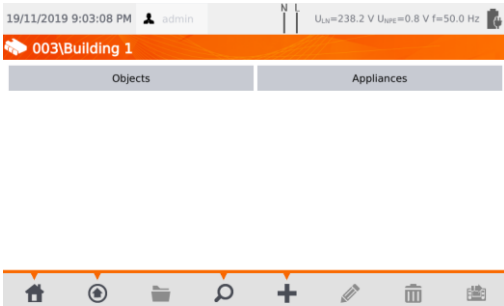

6

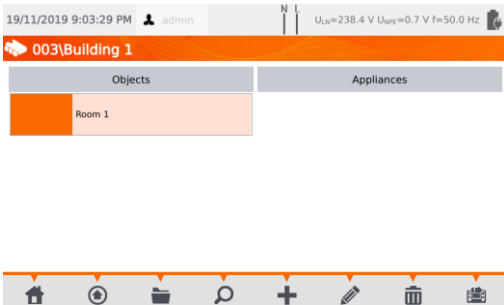

Press  (**Add**) and proceed in the same way as when adding previous objects.

7



Subject **Room 1** within the object **Building 1**. To add next subsubject within the subsubject **Room 1**, open the subsubject and proceed as described in steps  .



- Objects and subobjects (objects within objects) can be incremented up to 5 levels, starting from client.
- Memory structure can be expanded on each level.

c. Adding appliances



Appliances can be added directly to

- clients,
- individual objects and subobjects of given client.

1



To add an appliance on object "Room 1" press (Open), and then (Add).

2

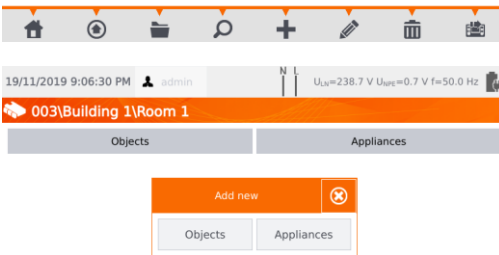

Press **Appliance**.

3

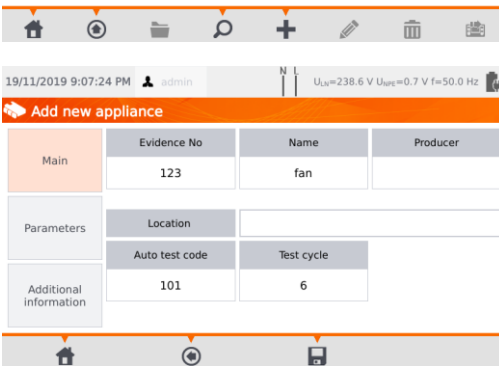

Enter appliance's data in the same way as for the client or object.

Data in red fields are mandatory. Additional data is available under **Parameters** and **Additional information**.

Press to save the appliance's data.

4



A new appliance has been added. To change the data press the appliance's name and then .

To add another appliance with in the same object press .



- The number of the appliances to be added is not limited by the firmware. The only limitation derives from the tester's memory capacity.
- Evidence numbers cannot be repeated.

d. Deleting clients, objects and appliances

1

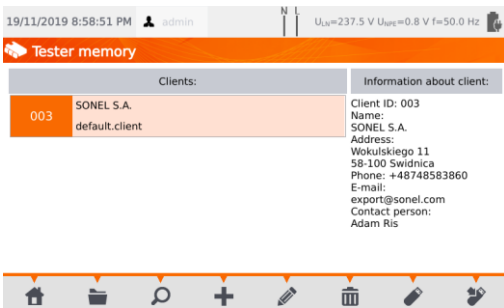

To delete client, object or appliance, make your selection and press .

2

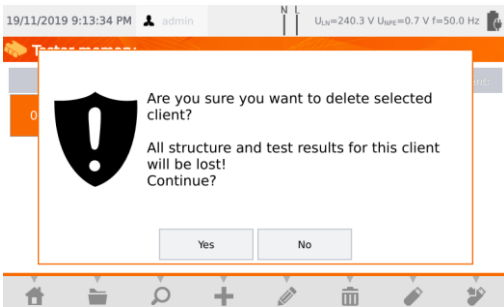

Confirm the deletion by pressing **Yes**. If you have changed your mind, select **No**.



NOTE!

Deleting client or object also deletes all objects (subobjects), appliances and measurement results linked to them.

3.3.17 Communication with PC

With the use of **Sonel PAT Analysis** software, the same settings, as within the tester, can be done. Additionally the user can:

- move data from tester to PC, and from PC to tester,
- program user editable auto tests,
- fully manage clients and their test results,
- change meter settings.

1

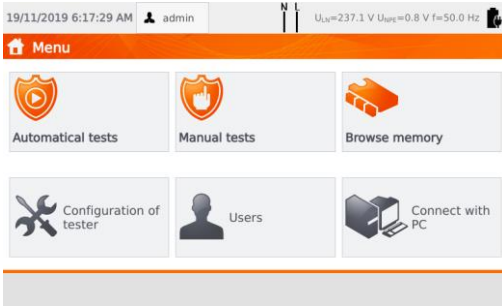

Press **Connect with PC**.

2

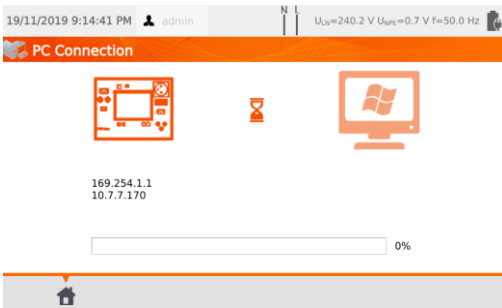

On your PC run **Sonel PAT Analysis**.

To terminate the connection press .



There is also a possibility to manage the meter (settings, auto procedures etc.) using **Sonel Reader** software. To do so:

- proceed according to steps 1 2,
- in the software: select the meter,
- click **Configure the tester**,
- insert PIN to be able to change settings. The default PIN is **123**.

If you want to secure the meter with an additional password:

- click **Configure the tester**,
- insert PIN,
- select **Meter configuration** tab and then **Settings password** tab,
- click the button **Set password**,
- fill in the form and press **OK**.

While changing/removing password you must enter the old one.

4 Measurements



WARNING

The socket marked with  symbol is connected with the PE pin of the test socket. It is not allowed to apply dangerous voltage to this socket.



- Tested appliance must be turned on.
- Continuous measurement lasts until **STOP** is pressed.
- After completing each measurement its parameters, date and duration of the measurement can be viewed.

4.1 Visual check (preliminary test)

1

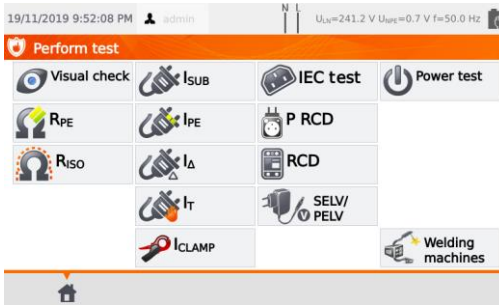

Select **Visual check**.

2

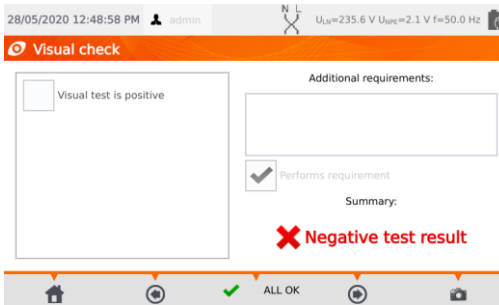

Examine the power cord and the mains plug for cracks and overheated spots.

3

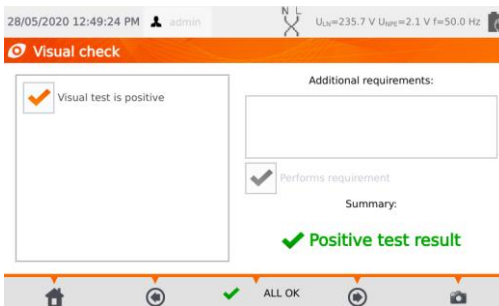

The icon  will take you to the menu where you can add and remove photos from the inspection. Adding photos is done using the **Sonel PAT Analysis Mobile** application and the phone's camera.

If everything is in order:

- ⇒ select **All OK** or
- ⇒ tick **Visual test is positive** and go further using icon .

- 4 Connect mains plug of the appliance under test into test socket of the tester.

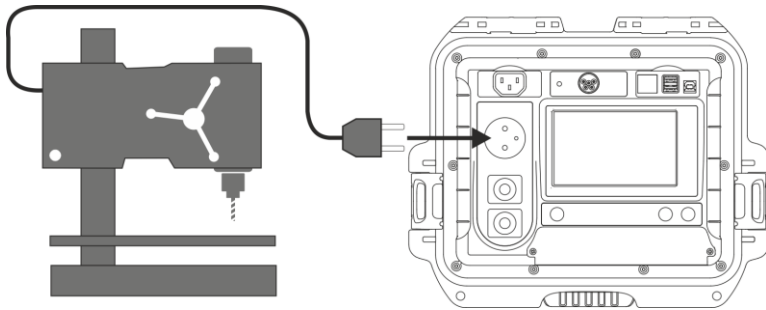

- Tested appliance must be turned on.
- R_{L-N} measurement is intended for resistance objects. In case of inductive objects, the result may be burdened with an additional error.
- R_{L-N} measurement is conducted before commencing any measurement and it verifies whether or not the tested appliance is properly connected and turned on. The criteria applied is $R_{L-N} < 5 \text{ k}\Omega$. Therefore, for some appliances, warning note may appear saying that the proper connection has not been established, even though it has.

4.2 Measurement of protective conductor resistance R_{PE}

- 1 Select R_{PE} .
- Before the measurement the following has to be set.

- 2 Test current.

3

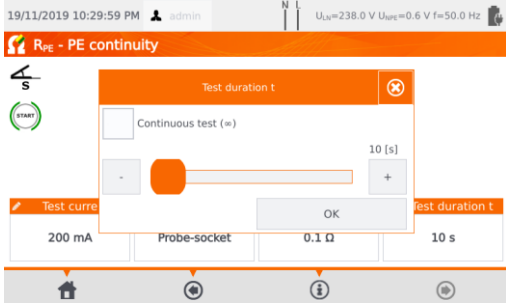

Test duration:

- ⇒ use slider or +/- icons, or
 - ⇒ select **Continuous test** (∞) (which will make the test last until **STOP** is pressed). Active only for 200 mA test current!
- Confirm by pressing **OK**.

4

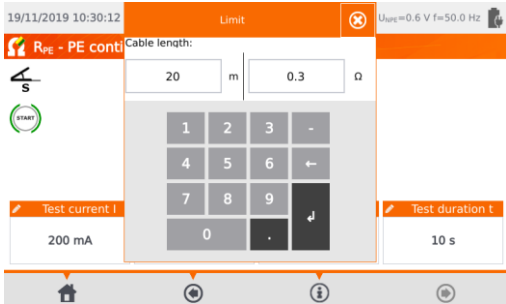

Resistance limit resulting from the length of the PE conductor. Use keyboard to enter:

- ⇒ conductor length or
- ⇒ upper limit of R_{PE} resistance.

5

Measurement method:

- 6a) probe-socket (3-pole method),
- 6b) probe-probe (4-pole method),
- 6c) IEC,
- 6d) PRCD.

6a

Probe-socket

Connect mains plug of the appliance under test into test socket of the tester. Using the probe connected to socket **T2** touch metal parts of the tested appliance that are connected to PE.

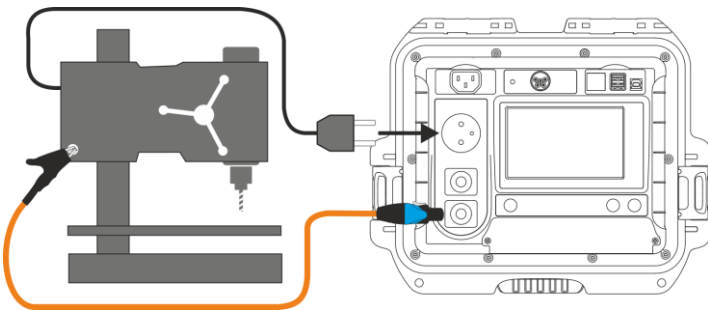

6b Probe-probe

Connect PE of the tested appliance's mains plug into **T1** terminal socket. Using the probe connected to socket **T2** touch metal parts of the tested appliance that are connected to PE.

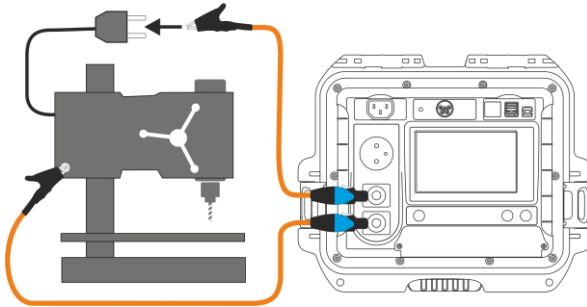
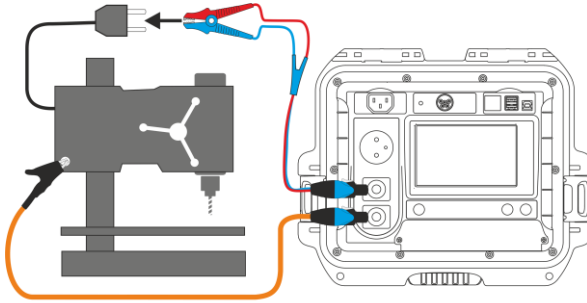

6c IEC power cord

Connect mains plug of the power cord into test socket. Connect the other end into IEC socket.

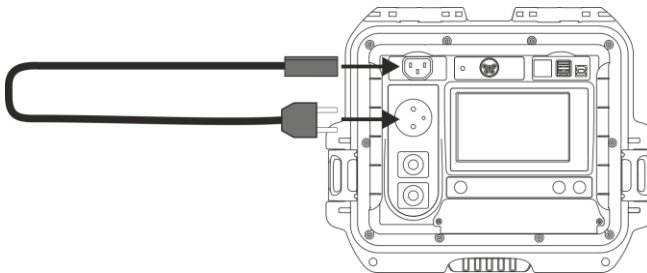

6d) PRCD cord (built-in RCD)

Connect the tested object to the meter.

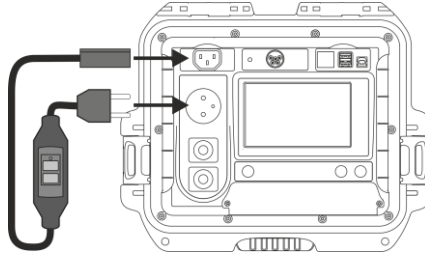

7



Press **START**.

Upon completing the measurement read the result. You can finish the test before the defined test time duration by pressing **STOP**.

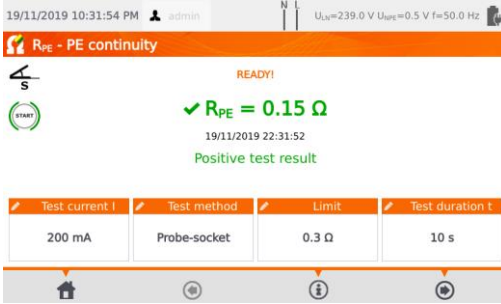

- ✓ Positive test result: $R_{PE} \leq \text{LIMIT}$
- ✗ Negative test result: $R_{PE} > \text{LIMIT}$



Test circuit is electrically isolated from the mains and from mains' PE lead.

4.3 Measurement of insulation resistance R_{ISO}



NOTE!

For Class I appliances, the measurement only makes sense if the R_{PE} measurement was positive.

1

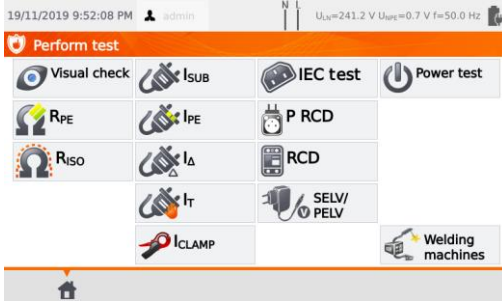

Press R_{ISO} .

Before starting the measurement, similarly to **sec. 4.2**, following parameters must be set: **test voltage**, **test duration**, **limit** and test method: **probe-socket** (measurement between shorted L-N and PE of the test socket or T2 probe), **probe-probe** (measurement between T1 and T2 probes) or **IEC** (IEC cord test).



- Tested appliance must be turned on.
- Test circuit is electrically isolated from the mains and from mains' PE lead.
- Test result should be read only after displayed values are stabilized.
- After the measurement the tested object is automatically discharged.

2a) R_{ISO} measurement in Class I appliances

Connect the mains plug of the tested appliance into the test socket of the tester (a). The measurement is made between L and N (which are shorted) and PE. Additionally, it is possible to carry out the measurement with the probe connected to T2 terminal socket (b).

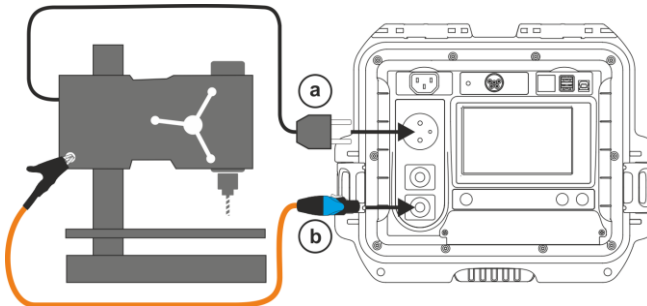

2b Measurement without using the test socket

Connect shorted L and N of the mains plug of the tested appliance to **T1** terminal socket. Using the probe connected to **T2** terminal socket touch the conductive accessible parts of the tested appliance.

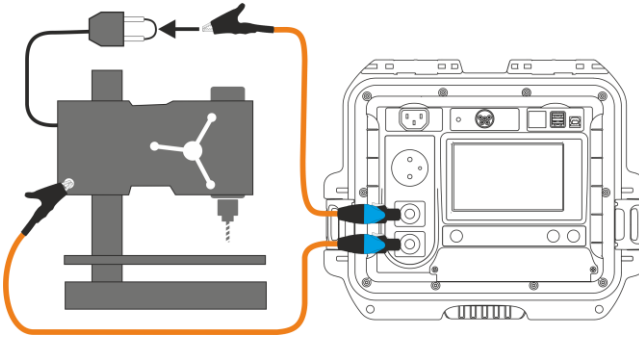
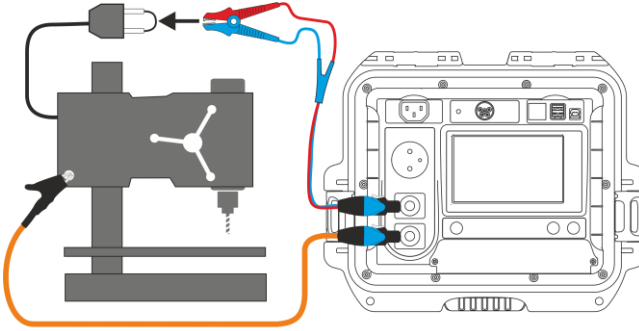

2c Riso measurement on Class II (III) appliances

Connect the mains plug of the tested appliance into the test socket of the tester. L and N are shorted. Connect the probe to the **T2** terminal socket. Using the probe touch the conductive accessible parts of the tested appliance.

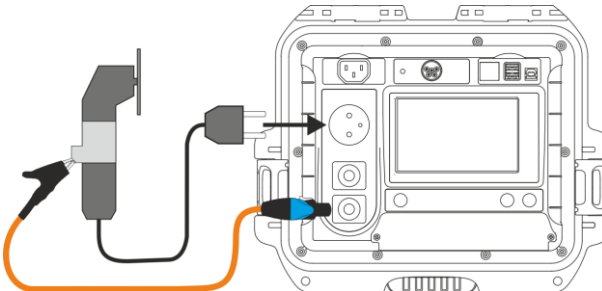

2d) R_{ISO} measurement of IEC power cord

Connect mains plug of the power cord into test socket, and connect the other end into IEC socket.

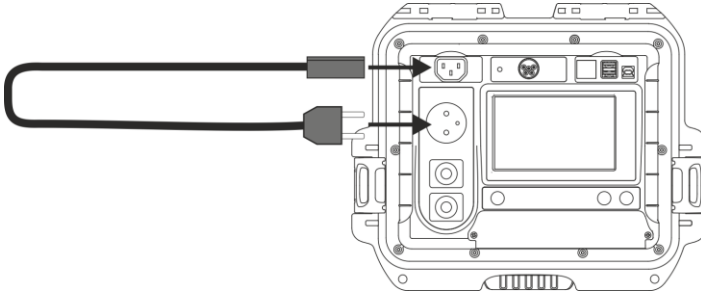

3



Press **START**.

Upon completing the measurement read the result. You can finish the test before the defined test time duration by pressing **STOP**.



- ✓ Positive test result: $R_{ISO} \geq \text{LIMIT}$
- ✗ Negative test result: $R_{ISO} < \text{LIMIT}$



NOTE!

Before the measurement (also in auto mode) check the resistance of the protective conductor R_{PE} – it should be correct.

4.4 Measurement of substitute leakage current I_{SUB}



NOTE!

- For Class I appliances, the measurement only makes sense if the R_{PE} measurement was positive.
- I_{SUB} current is measured at <50 V voltage. The value is rescaled to the nominal mains voltage value that is set in the menu (see **sec. 3.3.4**). The voltage is applied between L and N (that are shorted), and PE. The resistance of the measuring circuit is 2 k Ω .

1

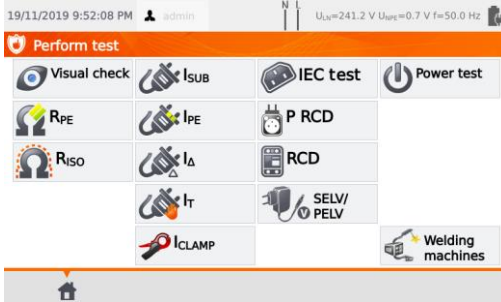

Press I_{SUB} .

Before starting the measurement, similarly to **sec. 4.2**, following parameters must be set: **test duration** and **limit**.

2a

For Class I: connect the mains plug of the tested appliance into the test socket of the tester.

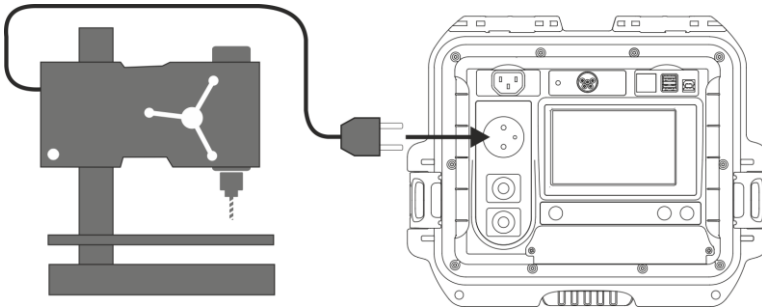

2b) For Class II and accessible parts disconnected from PE in Class I: connect the probe to T2 terminal socket and touch the accessible parts of the tested appliance.

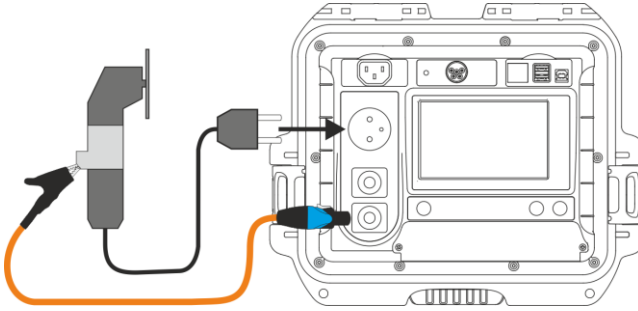

3 Press **START**.
Upon completing the measurement read the result. You can finish the test before the defined test time duration by pressing **STOP**.

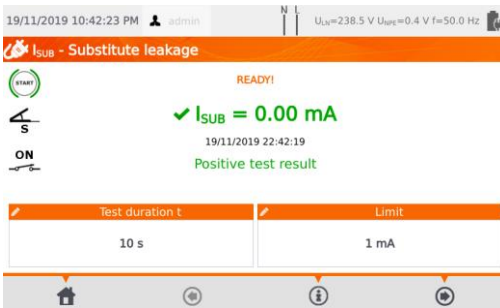

✓ Positive test result: $I_{SUB} \leq LIMIT$
✗ Negative test result: $I_{SUB} > LIMIT$



- Tested appliance must be turned on.
- Test circuit is electrically isolated from the mains and from mains' PE lead.
- Test voltage is 25 V...50 V RMS.

4.5 Measurement of leakage current I_{PE}



NOTE!

For Class I appliances, the measurement only makes sense if the R_{PE} measurement was positive.

1

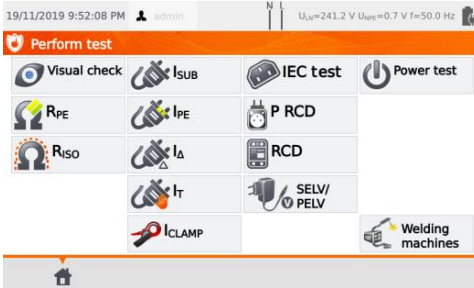

Press **I_{PE}** .

Before starting the measurement, similarly to **sec. 4.2**, following parameters must be set: **test duration, limit, polarity and method**.

2



In **Change polarity** select:

- ⇒ **yes** if the measurement is to be repeated for reverse polarity,
- ⇒ **no** if the measurement is performed for only one polarity.

In **Methods** select:

- ⇒ **socket** if test socket is to be used for the measurement, and go to step **3a**,
- ⇒ **clamp** if clamp is to be used for the measurement, and go to step **3b**,
- ⇒ **PRCD** if you want to test a device with built-in RCD, and go to step **3c**.

3a

Measurement with test socket

Connect the mains plug of the tested appliance into the test socket of the tester **(a)**. Additionally, it is possible to carry out the measurement with the probe connected to **T1** terminal socket **(b)**.

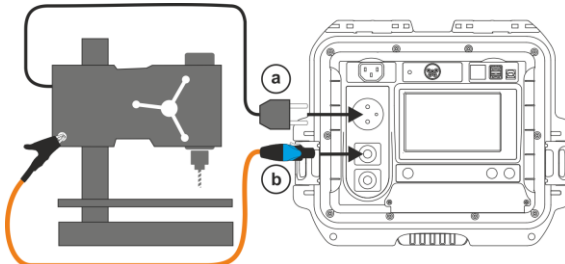

3b) Measurement with clamp

Attach clamp around PE conductor.

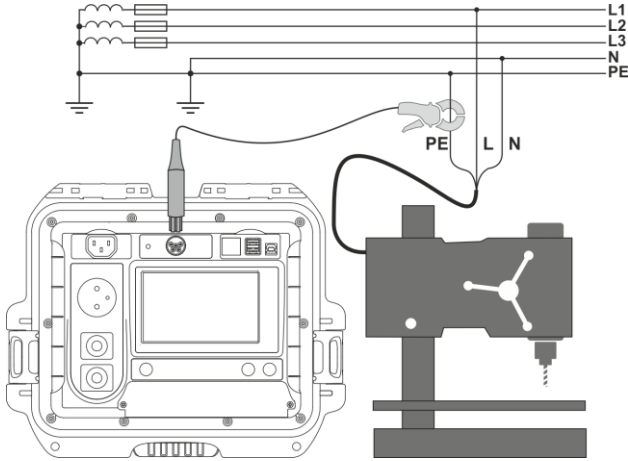

3c) PRCD cord (built-in RCD)

Connect the tested object to the meter.

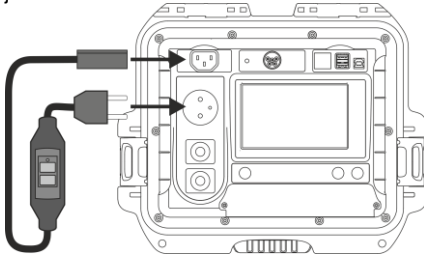

4



Press **START**.

Upon completing the measurement read the result. You can finish the test before the defined test time duration by pressing **STOP**.

19/11/2019 10:49:33 PM admin N I U_{LN}=238.7 V U_{PE}=0.4 V f=50.0 Hz

I_{PE} - Leakage current

READY! S=11 VA

✓ **I_{PE} = 0.05 mA** f=50.0 Hz

19/11/2019 22:49:27
Positive test result

Test duration t	Limit	Change polarity	Methods
10 s	1 mA	Yes	Socket

- ✓ Positive test result: $I_{PE} \leq \text{LIMIT}$
- ✗ Negative test result: $I_{PE} > \text{LIMIT}$



NOTE!

- During the measurement, the same mains voltage is present at the measuring socket which powers the tested appliance.
- During the measurement of a faulty appliance, RCD switch may be triggered off.



- PE leakage current is measured directly in PE conductor, which gives an accurate result even if the appliance consumes a current of 10 A or 16 A. Note that if the current does not leak to PE, but to other earthed elements (e.g. water pipe) – it cannot be measured in this measurement function. In that case it is advised that the differential leakage current I_{Δ} method of testing should be used.
- Ensure that the location of the tested appliance is insulated.
- When **Change polarity** is set on **Yes**, after the set time duration is over the tester automatically changes the polarity of the test mains socket and resumes the test. As a test result it displays the value of the higher leakage current.
- If the tested appliance is damaged, signaling a 16 A fuse burnout may also mean that the overcurrent protection device in the mains from which the meter is powered has tripped.

4.6 Measurement of differential leakage current I_{Δ}

1

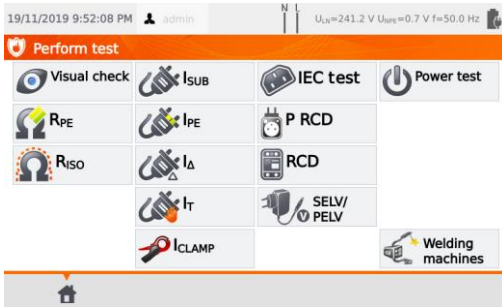

Press I_{Δ} .

Before starting the measurement, similarly to **sec. 4.2**, following parameters must be set: **test duration**, **limit**, **polarity** and **method**.

2

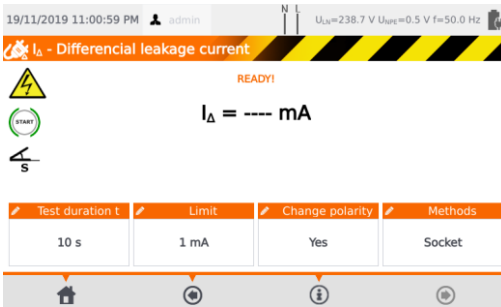

In **Change polarity** select:

- ⇒ **yes** if the measurement is to be repeated for reverse polarity,
- ⇒ **no** if the measurement is performed for only one polarity.

In **Method** select:

- ⇒ **socket** if test socket is to be used for the measurement, and go to step **(3a)**,
- ⇒ **clamp** if clamp is to be used for the measurement, and go to step **(3b)**,
- ⇒ **PRCD** if you want to test a device with built-in RCD, and go to step **(3c)**.

3a

Measurement with test socket

Connect the mains plug of the tested appliance into the test socket of the tester.

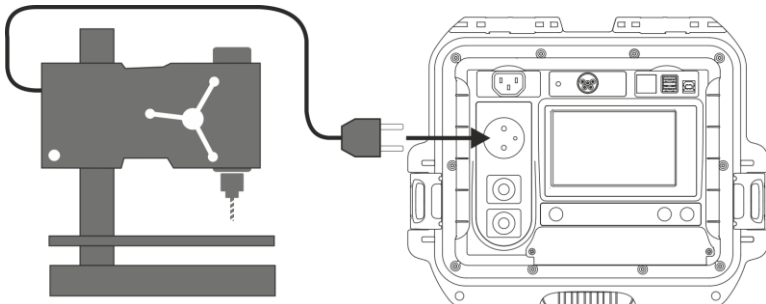

3b) Measurement with clamp

Attach clamp around L and N conductors.

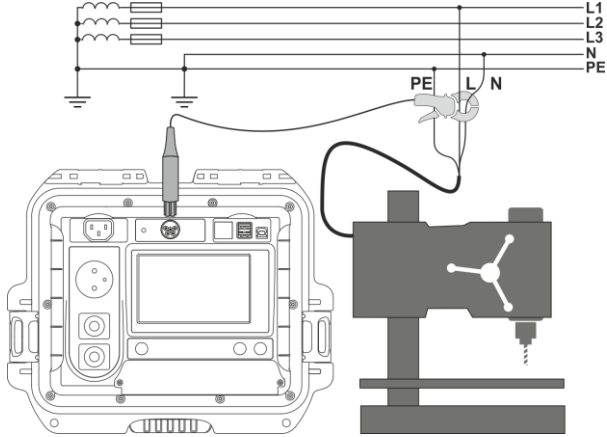

3c) PRCD cord (built-in RCD)

Connect the tested object to the meter.

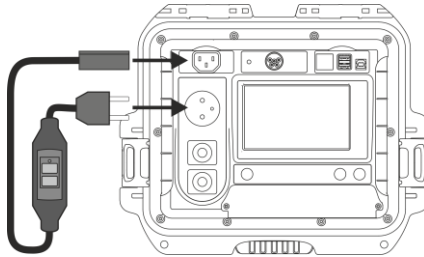

4



Press **START**.

Upon completing the measurement read the result. You can finish the test before the defined test time duration by pressing **STOP**.

19/11/2019 11:01:40 PM admin N I U_{LN}=238.6 V U_{PE}=0.5 V f=49.9 Hz

I_Δ - Differential leakage current

⚡ **READY!** S=11 VA

✓ **I_Δ = 0.06 mA** f=49.9 Hz

19/11/2019 23:01:32

Positive test result

Test duration t	Limit	Change polarity	Methods
10 s	1 mA	Yes	Socket

- ✓ Positive test result: $I_{\Delta} \leq \text{LIMIT}$
- ✗ Negative test result: $I_{\Delta} > \text{LIMIT}$



NOTE!

- During the measurement, the same mains voltage is present at the measuring socket which powers the tested appliance.
- During the measurement of a faulty appliance, RCD switch may be triggered off.



- Differential leakage current is measured as a difference between L current and N current. This measurement takes into account not only current leaking to PE, but also currents leaking to other earthed elements - e.g. water pipe. The disadvantage of this measurement is the presence of common current (supplied to the tested appliance through L line and returning via N line), which influences the measurement accuracy. If this current is high, the measurement will be less accurate (see **sec. 13**) than the measurement of PE leakage current.
- The tested appliance must be turned on.
- When **Change polarity** is set on **Yes**, after the set time duration is over the tester automatically changes the polarity of the test mains socket and resumes the test. As a test result it displays the value of the higher leakage current.
- The result of measurement may be affected by the presence of external fields and by the current used by the appliance.
- If the tested appliance is damaged, signaling a 16 A fuse burnout may also mean that the overcurrent protection device in the mains from which the meter is powered has tripped.

4.7 Measurement of touch leakage current I_T

1

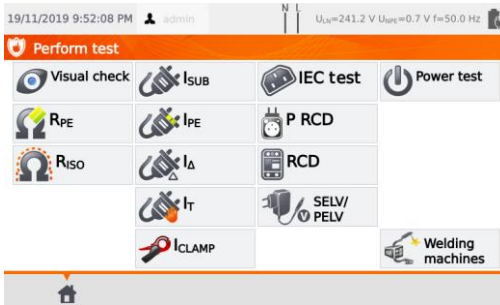

Press I_T .

Before starting the measurement, similarly to **sec. 4.2**, following parameters must be set: **test duration**, **limit**, **polarity** and **method**.

2

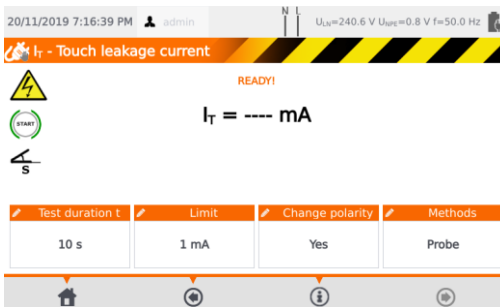

In **Change polarity** select:

- ⇒ **yes** if the measurement is to be repeated for reverse polarity,
- ⇒ **no** if the measurement is performed for only one polarity.

In **Method** select:

- ⇒ **Probe** if the measurement will be carried out using probe, and go to step (3a),
- ⇒ **PRCD** if you want to test a device with built-in RCD, and go to step (3b)

3a

Measurement with probe

Connect the mains plug of the tested appliance into the test socket of the tester. Use the probe connected to **T2** terminal socket and touch the accessible parts of the tested appliance (for Class I appliances - touch accessible parts not connected to PE).

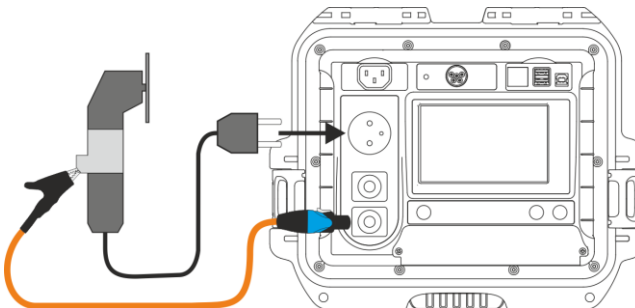

3b) PRCD cord (built-in RCD)

Connect the tested object to the meter.

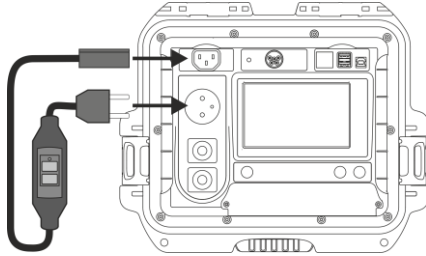

4



Press **START**.

Upon completing the measurement read the result. You can finish the test before the defined test time duration by pressing **STOP**.

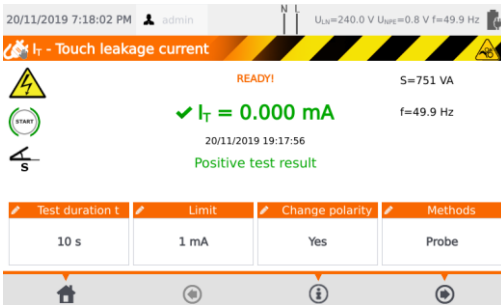

- ✓ Positive test result: $I_T \leq \text{LIMIT}$
- ✗ Negative test result: $I_T > \text{LIMIT}$



NOTE!

- During the measurement, the same mains voltage is present at the measuring socket which powers the tested appliance.
- During the measurement of a faulty appliance, RCD switch may be triggered off.



- When **Change polarity** is set on **Yes**, after the set time duration is over the tester automatically changes the polarity of the test mains socket and resumes the test. As a test result it displays the value of the higher leakage current.
- When tested appliance is powered from other socket, the measurement should be performed at both mains plug positions and as the result the higher current value should be accepted. When the appliance is powered from the tester's socket in auto tests, L and N terminals are swapped by the tester.
- The bandwidth of test current results from the measuring system with adjusted touch current which simulates human perception and reaction, in accordance with EN 60990:2002.

4.8 Measurement of current with clamp

1

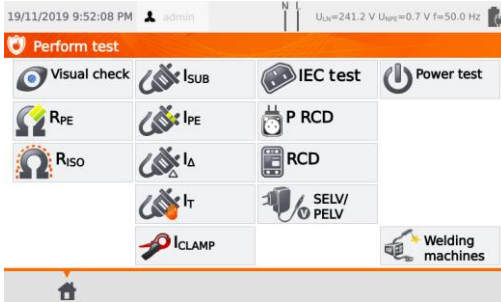

Press ICLAMP.

Before starting the measurement, similarly to **sec. 4.2**, following parameters must be set: **test duration** and **limit**.

2

Attach clamp around measured conductor.

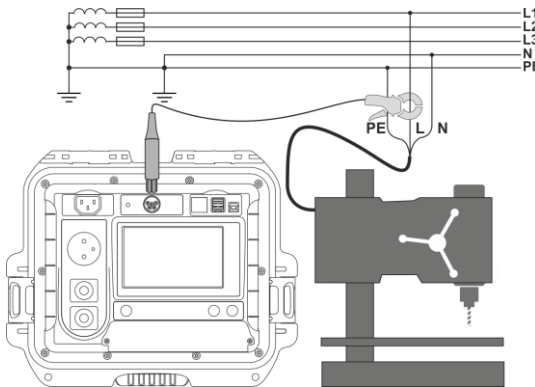

3



Press **START**.

Upon completing the measurement read the result. You can finish the test before the defined test time duration by pressing **STOP**.

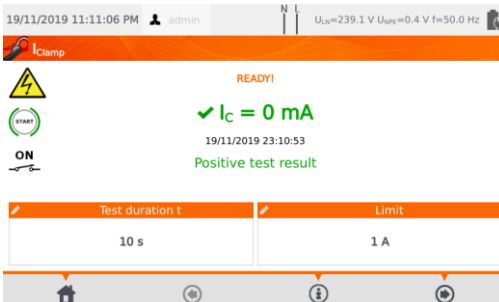

- ✓ Positive test result: $I_C \leq \text{LIMIT}$
- ✗ Negative test result: $I_C > \text{LIMIT}$



NOTE!

During the measurement, the same mains voltage is present at the measuring socket which powers the tested appliance.

4.9 IEC cord test

IEC cord test includes checking wires continuity, short circuits between the wires, correctness of L-L and N-N connection, PE resistance and insulation resistance measurement.

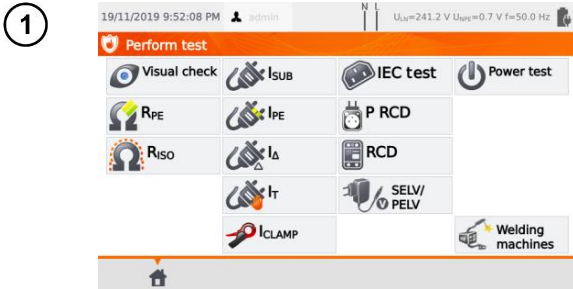

Press **IEC test**.

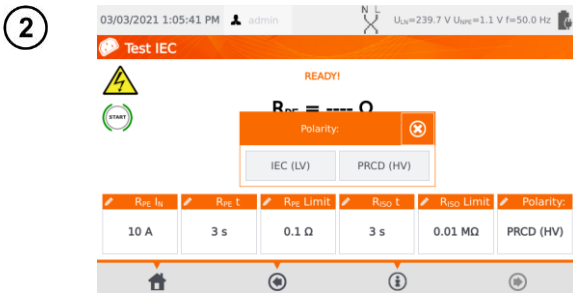

Before the measurement, similarly to previous tests, following parameters must be set:

- current,
- time of R_{PE} measurement,
- R_{PE} limit,
- time of R_{ISO} measurement,
- R_{ISO} limit,
- polarity check mode.



- The selection of the polarization test mode depends on whether the test is carried out on a standard IEC cable (**LV** method) or a cable equipped with an RCD (**HV** method).
- During the polarity test in HV mode, the RCD will trip. It must be switched on within 10 seconds. Otherwise, the meter treats this as a broken circuit and returns a negative measurement result.

- ③ Connect the mains plug of the cord into the test socket and the other end of the cord into the IEC socket on the tester.

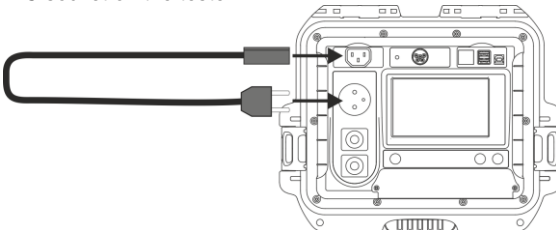

4



Press **START**.

Upon completing the measurement read the result. You can finish the test before the defined test time duration by pressing **STOP**.

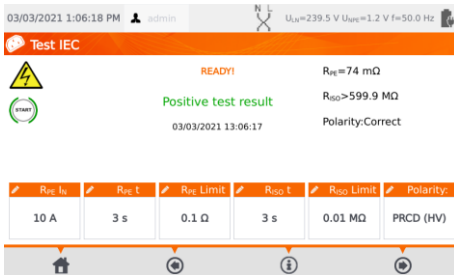

✓ Positive test result: parameters are within limits

✗ Negative test result: parameters are not within the limits

Information about irregularities in the lead are displayed in the test results field.

4.10 Testing PRCD devices (with built-in RCD)

1

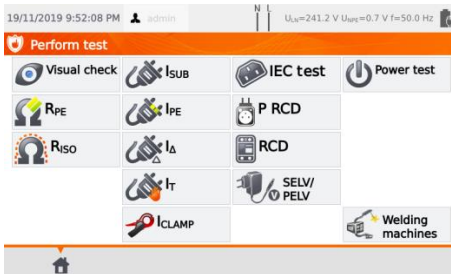

Press **P RCD**.

Before starting the measurement, following parameters must be set: **waveform**, **rated RCD current** and **test type**.

2

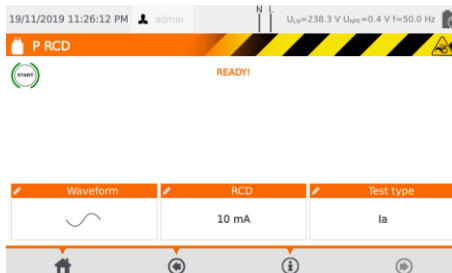

Waveform (shape of the current):

- ⇒ initial phase positive,
- ⇒ initial phase negative,
- ⇒ both.

In **RCD** select nominal current:

- ⇒ 10 mA,
- ⇒ 15 mA,
- ⇒ 30 mA.

In **Test type** select tests you want to provide:

- ⇒ Ia,
- ⇒ ta x0.5,
- ⇒ ta x1,
- ⇒ ta x2,
- ⇒ ta x5.



The measurement procedure contains polarity check of the cord.

- 3 Connect the tested object to the meter.

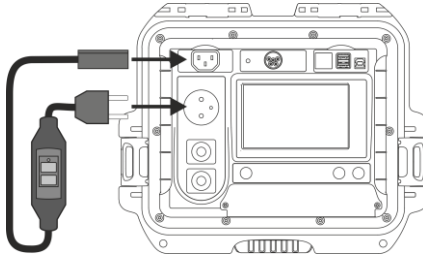

- 4



Press **START**.

Upon completing the measurement read the result. You can finish the test before the defined test time duration by pressing **STOP**.

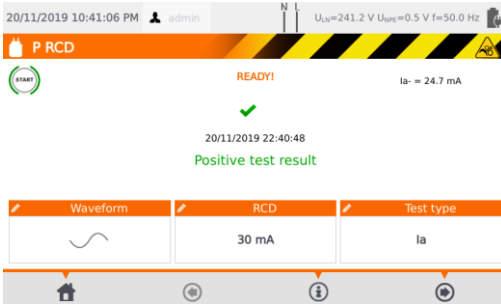

- Positive test result
- Negative test result



NOTE!

During the measurement, the same mains voltage is present at the measuring socket which powers the tested appliance.

4.11 Measurement of fixed RCD parameters

- 1 Connect the mains plug of the tester into the tested socket.

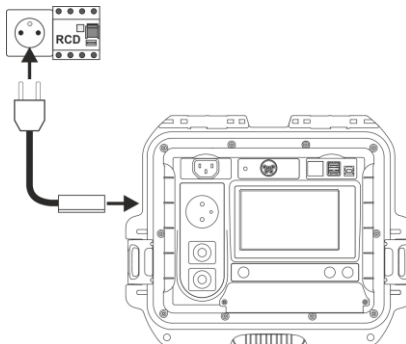

2

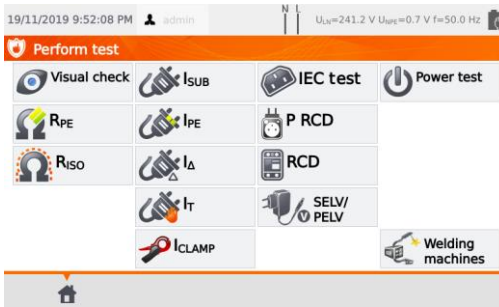

Press **RCD** and enter settings.

3

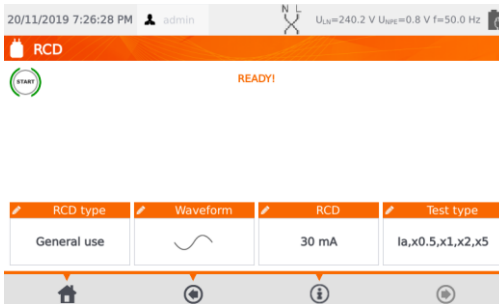

RCD type. Press to set:
 ⇒ general use or
 ⇒ shorttime.

Waveform (shape of the current):
 ⇒ initial phase positive,
 ⇒ initial phase negative,
 ⇒ both.

In **RCD** select nominal current:
 ⇒ 10 mA,
 ⇒ 15 mA,
 ⇒ 30 mA.

In **Test type** select parameters to check:
 ⇒ Ia,
 ⇒ ta x0.5,
 ⇒ ta x1,
 ⇒ ta x2,
 ⇒ ta x5.

4



Press **START**. Switch on RCD whenever it trips. Upon completing the test read the result.

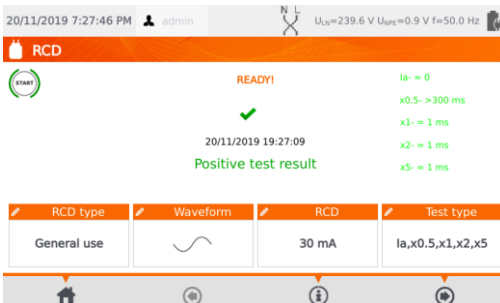

RCD must be immediately switched on after RCD trips. Meanwhile the meter is powered from built-in rechargeable battery.

4.12 SELV/PELV appliances test

The test consists in checking whether the source generates extra-low voltage within limits.

1

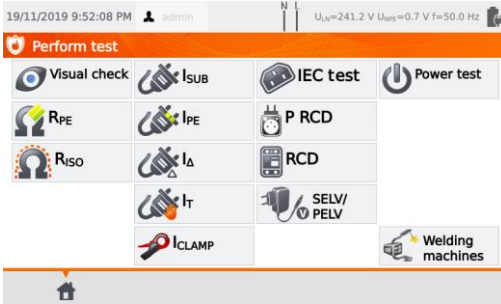

Press **SELV/PELV**.

Before starting the measurement, similarly to **sec. 4.2**, following parameters must be set: **test duration** and **limits**: lower and upper.

2

Using the 1.5 m double-wire test lead, connect the low-voltage plug of the tested voltage source to the tester's **T1** socket. Then connect the voltage source to power.

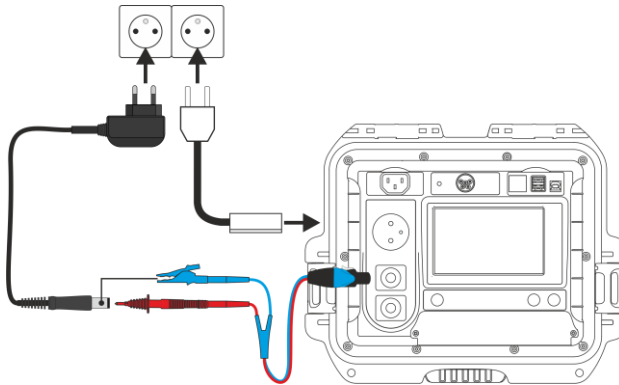

3



Press **START**.

Upon completing the measurement read the result. You can finish the test before the defined test time duration by pressing **STOP**.



✓ Positive test result:
LOWER LIMIT ≤ U ≤ UPPER LIMIT

✗ Negative test result:
U < LOWER LIMIT
or
U > UPPER LIMIT

4.13 Power test

The test consists on measuring the power parameters when the tested appliance is turned on. The powers, voltage, current are measured as well as $\cos\phi$, PF and THD factors.

1

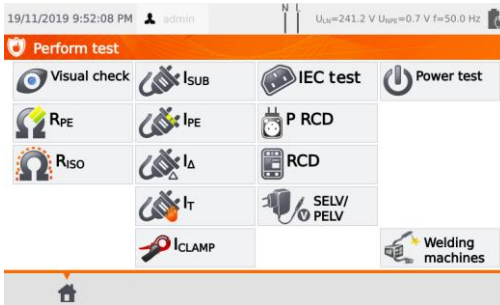

Press **Power test**.

Before starting the measurement, similarly to **sec. 4.2**, following parameters must be set: **test duration** and **clamp**.

2



In **Use clamp** select:

- ⇒ **Yes** if clamp is to be used for the measurement,
- ⇒ **No** if the test is to be performed in test socket of the tester.

3a

Measurement with clamp

Attach clamp around L conductor. To **T1** socket connect L and N conductors of the power cord of the tested appliance.

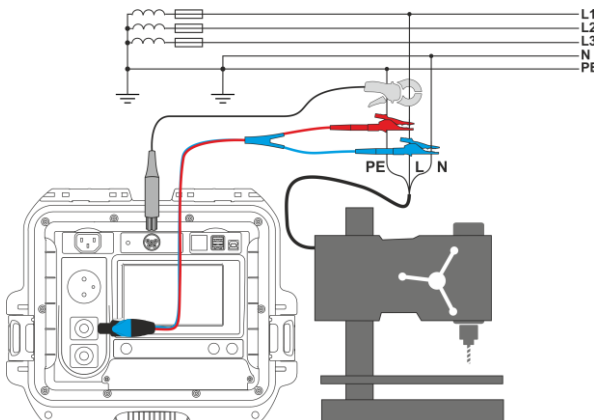

3b Measurement without clamp

Connect the mains plug of the tested appliance into the test socket of the tester.

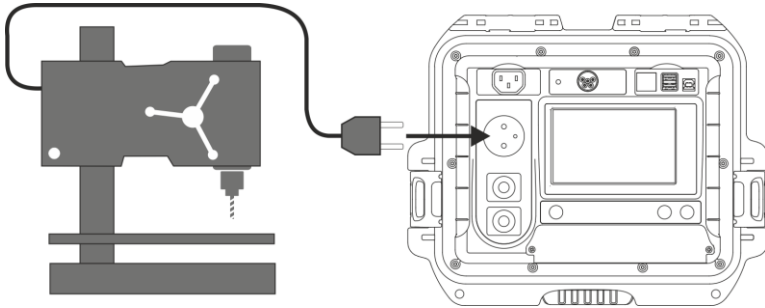

4



Press **START**.

Upon completing the measurement read the result. You can finish the test before the defined test time duration by pressing **STOP**.

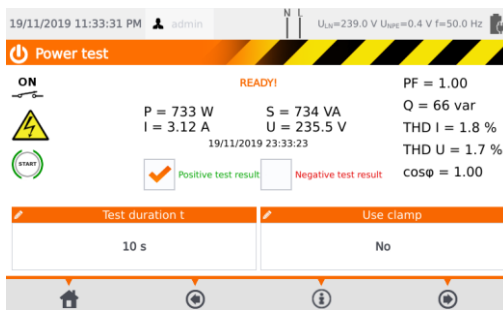

Compare the result with the technical data of the tested appliance. The assessment of the correctness of the test results can be performed by selecting the proper field in '**Positive test result**' or '**Negative test result**'. When saving test results in the memory, this assessment will also be saved along with the results.



NOTE!

During the measurement, the same mains voltage is present at the measuring socket which powers the tested appliance.



If the tested appliance is damaged, signaling a 16 A fuse burnout may also mean that the overcurrent protection device in the mains from which the meter is powered has tripped.

5 **PAT-86** Measurement of welding machines

In the test selection menu press **Welding machines** to go to a submenu with welding machine tests. Tests not described in this chapter are carried out identically to the corresponding manual tests, presented in **sec. 4**.

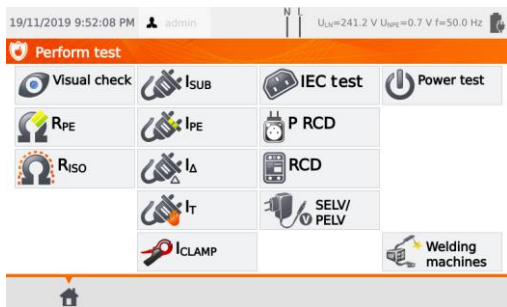

All welding measurements can also be made with welding cables – but **only if the cables are functional**.

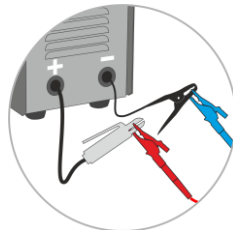

5.1 Measurement of R_{ISO} (LN-S, PE-S) in welding machines

Tests consist of measuring insulation resistance:

- ⇒ between shorted primary side conductors (L and N) and secondary winding of the welding machine (R_{ISO} LN-S),
- ⇒ between the PE conductor and the secondary winding of the welding machine (R_{ISO} PE-S).



NOTE!

For Class I appliances, the measurement only makes sense if:

- the R_{PE} measurement was positive and
- the standard R_{ISO} measurement was positive.

1

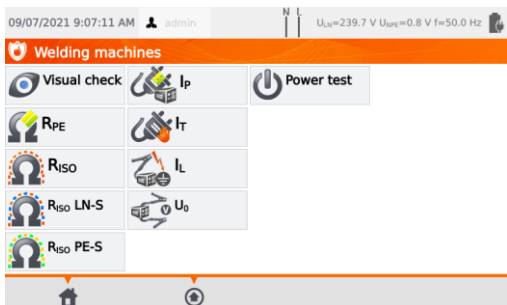

Press:

- ⇒ R_{ISO} LN-S. Depending on the tested appliance go to step (2a) or (2b).
- ⇒ R_{ISO} PE-S. Depending on the tested appliance go to step (2a) or (2b).

Before starting the measurement, similarly to **sec. 4.2**, following parameters must be set: **test voltage U_{ISO}** , **test duration** and **limit**.



- Tested appliance must be turned on.
- Test circuit is electrically isolated from the mains and from mains' PE lead.
- Test result should be read only after displayed values are stabilized.
- After the measurement the tested object is automatically discharged.

2a Measurement of R_{ISO} LN-S or R_{ISO} PE-S. 1-phase appliance.

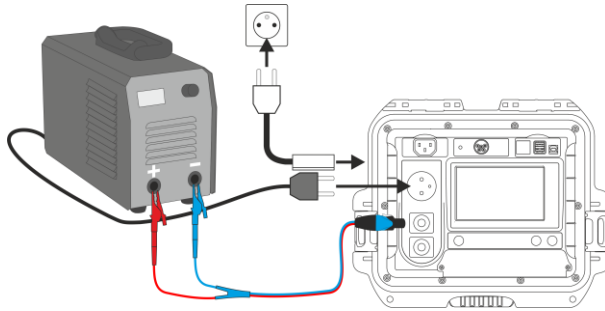

2b Measurement of R_{ISO} LN-S or R_{ISO} PE-S. 3-phase appliance or 1-phase appliance powered by an industrial socket.

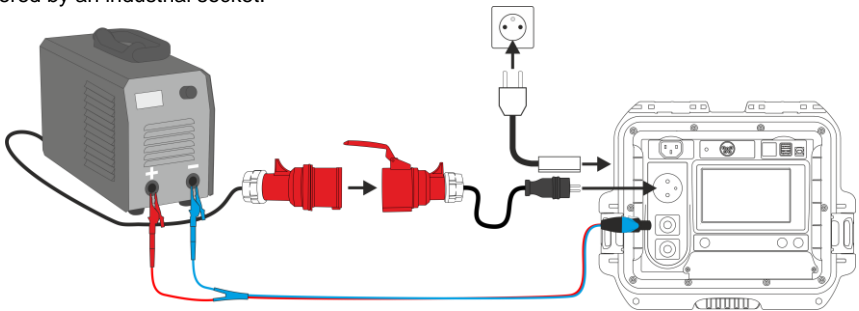

Press **START**.

Upon completing the measurement read the result. You can finish the test before the defined test time duration by pressing **STOP**.

20/11/2019 8:07:23 PM admin N I U_{LN}=240.6 V U_{PE}=0.8 V f=50.0 Hz

R_{ISO} LN-S

⚡

READY!

✓ R_{ISO} > 599.9 MΩ

20/11/2019 20:07:21

Positive test result

Test voltage U _{ISO}	Test duration t	Limit
500 V	10 s	5 MΩ

- ✓ Positive test result: R_{ISO} ≥ LIMIT
- ✗ Negative test result: R_{ISO} < LIMIT

5.2 Measurement of leakage current I_P in welding machines

1

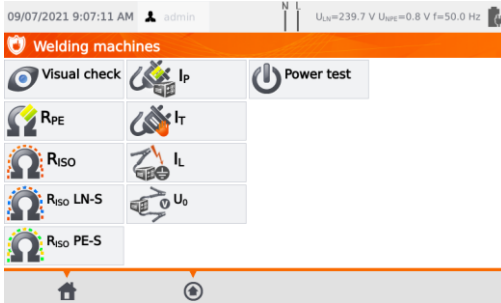

Press I_P .

Before starting the measurement, similarly to **sec. 4.2**, following parameters must be set: **test duration, limit, polarity** and **test method**.

2

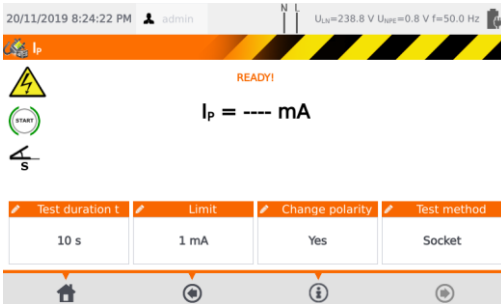

In **Change polarity** select:

- ⇒ **Yes** if the measurement is to be repeated for reverse polarity,
- ⇒ **No** if the measurement is performed for only one polarity.

In **Test method** select:

- ⇒ **Socket**, if test socket is to be used for the measurement,
- ⇒ **Adapter**, if test PAT-3F-PE adapter is to be used for the measurement.

3a Measurement with test socket

Connect the mains plug of the tested appliance into the test socket of the tester. The T1 cable can be connected but does not have to be.

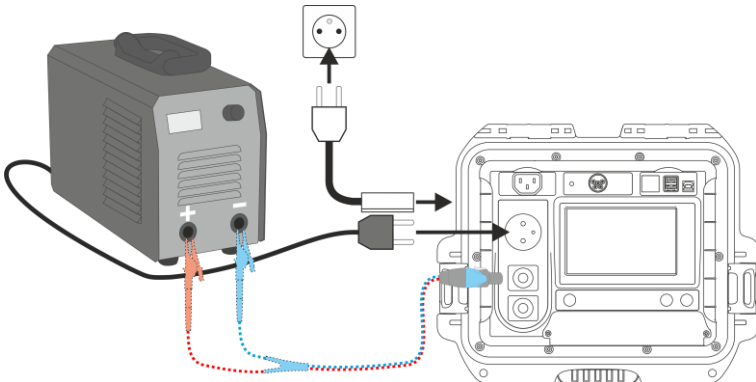

3b Measurement with PAT-3F-PE adapter. Connecting a 1-phase 230 V appliance.

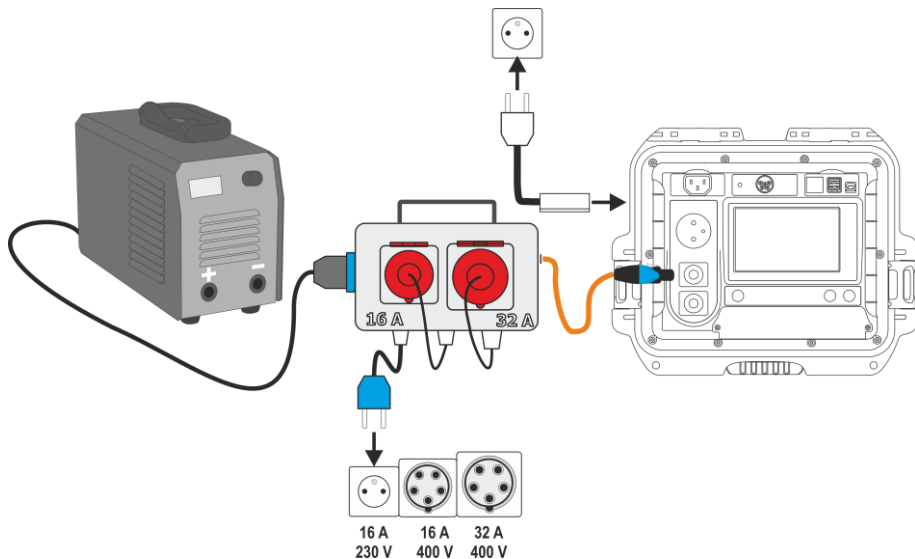

3c Measurement with PAT-3F-PE adapter. Connecting a 3-phase 16 A appliance.

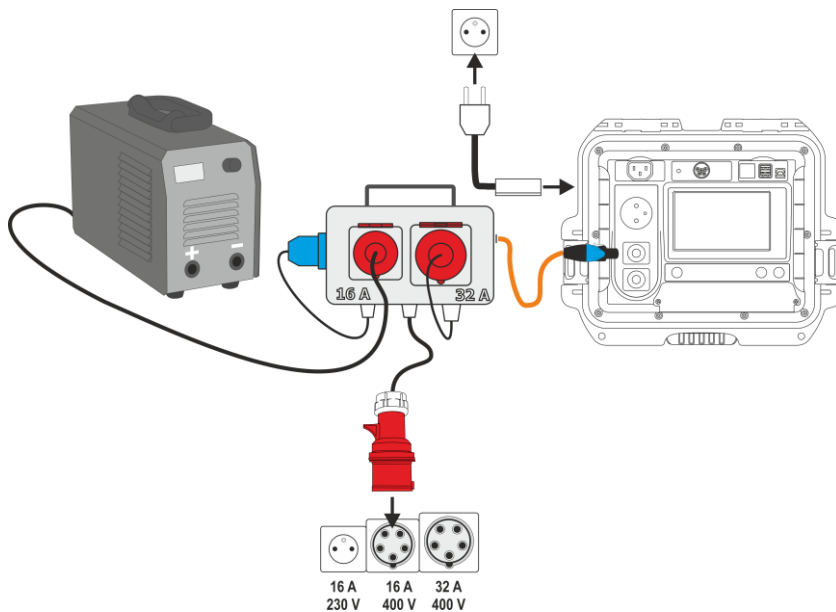

3d Measurement with PAT-3F-PE adapter. Connecting a 3-phase 32 A appliance.

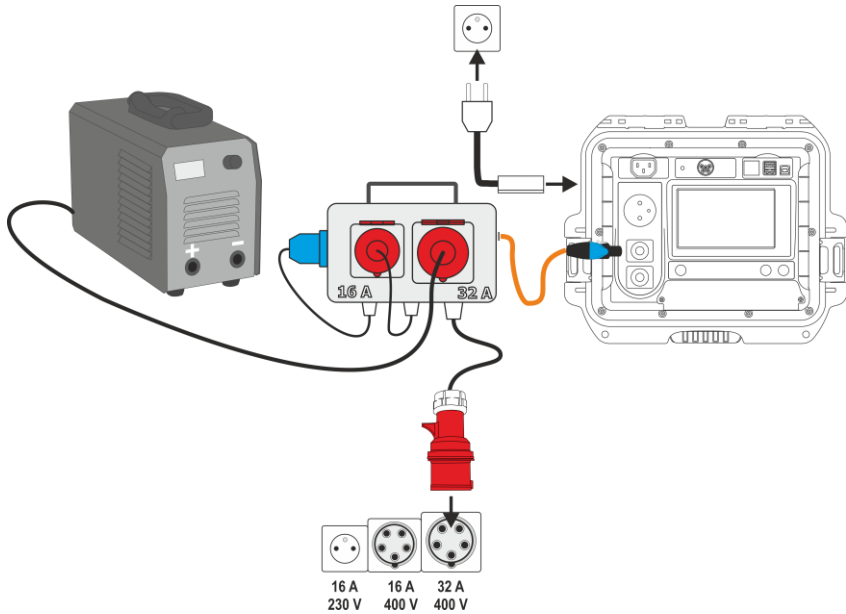

4 **START** / **STOP** Press **START**. Upon completing the measurement read the result. You can finish the test before the defined test time duration by pressing **STOP**.

20/11/2019 8:30:41 PM admin N L $U_{LN}=238.9\text{ V}$ $U_{PEL}=0.8\text{ V}$ $f=50.0\text{ Hz}$

READY! $S=11\text{ VA}$ $f=50.0\text{ Hz}$

✓ $I_p = 0.09\text{ mA}$

20/11/2019 20:30:29
Positive test result

Test duration t	Limit	Change polarity	Test method
10 s	1 mA	Yes	Socket

✓ Positive test result: $I_p \leq \text{LIMIT}$
 ✗ Negative test result: $I_p > \text{LIMIT}$

5.3 Measurement of welding circuit leakage current I_L

1

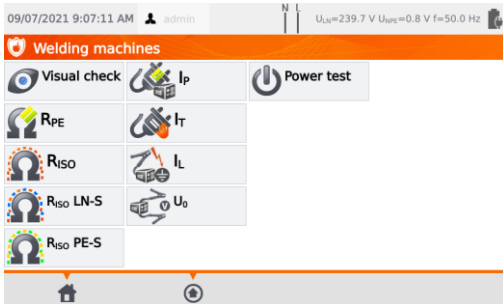

Press I_L .

2



- Before starting the measurement, similarly to **sec. 4.2**, following parameters must be set: **test duration** and **limit**.
- Connect the welding machine – step **3a** or **3b**.

3a

Variant with powering the welding machine from the meter's test socket (only 1-phase, max. 16 A).

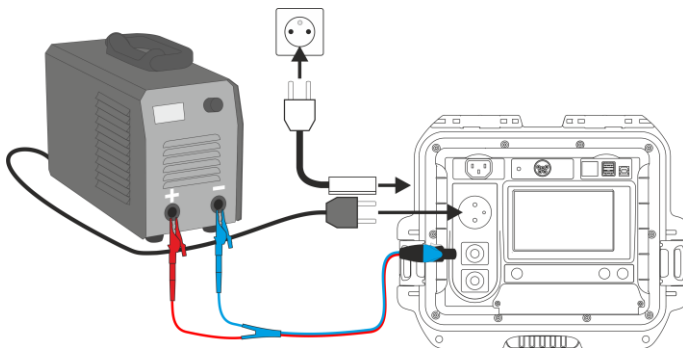

3b) Variant with powering the welding machine directly from the mains socket.

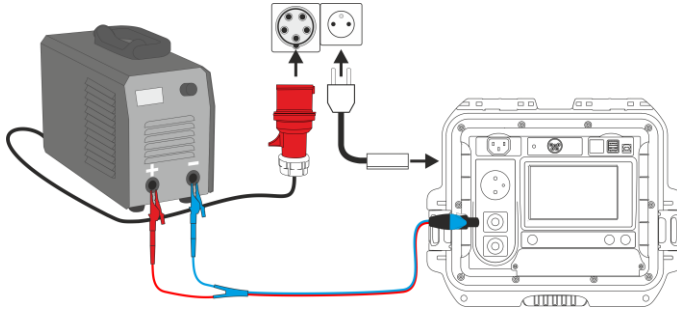

4 Press **START**.
Upon completing the measurement read the result. You can finish the test before the defined test time duration by pressing **STOP**.

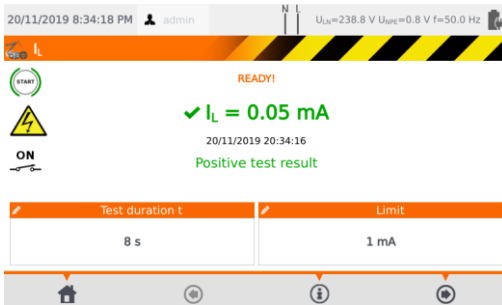

✓ Positive test result: $I_L \leq \text{LIMIT}$
 ✗ Negative test result: $I_L > \text{LIMIT}$

5.4 Welding machine voltage without load U_0

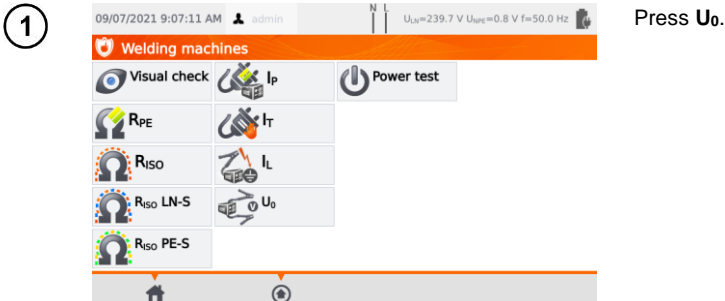

Before starting the measurement, similarly to **sec.4.2**, set U_0 voltage, **secondary voltage** type, **limit PEAK**, **limit RMS** and optionally also the criterion of **±15% PEAK**.

In U_0 field enter the secondary voltage of the welding machine, as specified on its nameplate.
 In **Voltage** field select the type of output voltage of the welding machine.

In **Limit PEAK** and **Limit RMS** fields select the acceptable values. Both parameters are changing at the same time, as they are interrelated by the following relationship:

$$\text{Limit PEAK} = \sqrt{2} \cdot \text{Limit RMS}$$

...wherein, if **voltage** = DC, then Limit RMS is disabled.

±15% PEAK field is responsible for checking whether the measured U_0 voltage is within the limits defined by the standard.

- ⇒ If **voltage** = AC, then $U_0(\text{PEAK})$ is checked.
- ⇒ If **voltage** = DC, then $U_0(\text{RMS})$ is checked.

2a Variant with powering the welding machine from the meter's test socket (only 1-phase, max. 16 A).

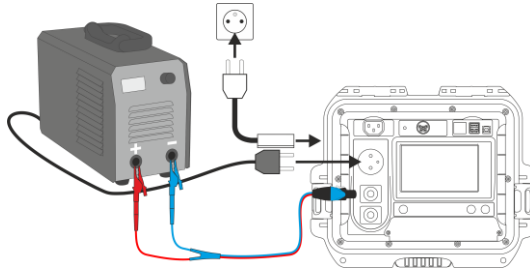

2b Variant with powering the welding machine directly from the mains socket.

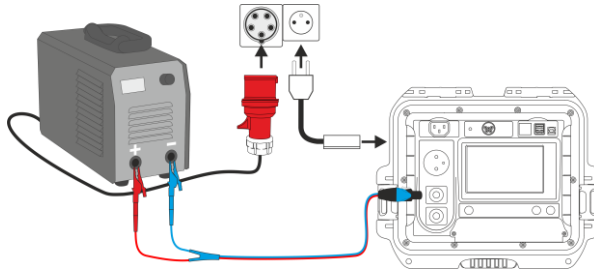

3



- Turn on the welding machine.
- Press **START**.
- Upon completing the measurement read the result. You can finish the test before the defined test time duration by pressing **STOP**.

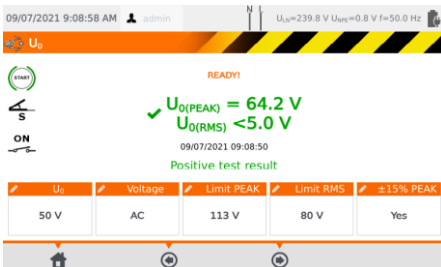

✓ Positive test result:
DC voltage: $U_0 \leq \text{LIMIT PEAK}$
AC, DC voltage: $U_0 \leq \text{LIMIT RMS}$

Optional: the criterion of ±15% PEAK for AC voltage:
 $U_0 \leq 115\% \text{ LIMIT PEAK}$
 $U_0 \geq 85\% \text{ LIMIT PEAK}$

Optional: the criterion of ±15% PEAK for DC voltage:
 $U_0 \leq 115\% \text{ LIMIT RMS}$
 $U_0 \geq 85\% \text{ LIMIT RMS}$

✗ Negative test result: U_0 does not meet at least one of the above conditions. .

6 Automatical tests

In this mode, readiness for the next measurement occurs without the need of returning to the menu. Automatical tests can be performed in two ways:

- **fully automatic** – every subsequent test will be executed without the need for the user's approval (provided that the previous test result is positive),
- **semiautomatic** – upon completing each test the tester will stop the sequence and the readiness for the next test will be indicated on screen. Commencing subsequent test will require pressing **START** button.

6.1 Configuring automatical tests

① Go to main menu and press **Configuration of tester**.

②

Select **Test**.

③

If each test is meant to be executed one after another automatically **Perform auto-tests automatically** option must be selected. Otherwise each test will be executed separately by pressing **START** button.

6.2 Automatical tests

1

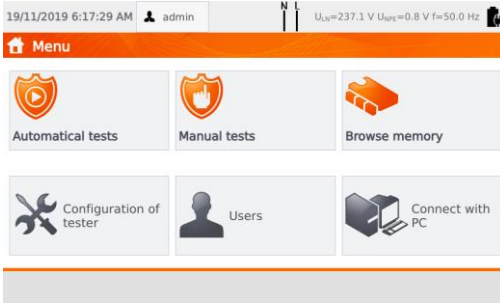



Press **Automatical tests**.

You can program your own list using the **Sonel PAT Analysis** computer program.

2



Toggle between lists using buttons  **User's procedures** and  **Standard procedures**.

Scroll the list of measurements with your finger. Each code stands for a test procedure compliant to a standard.

3

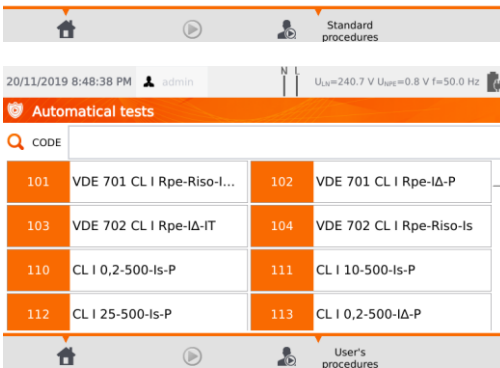

In order to load a test procedure, do one of the following:

To load a measurement procedure, do one of the following:

- ⇒ select a test from the list,
- ⇒ enter its code,
- ⇒ scan a suitable barcode with a QR code reader.

If a test method has already been assigned to the tester, it is started.

4

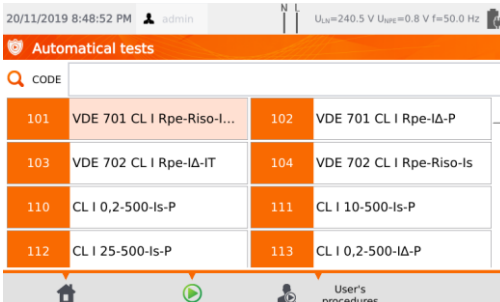

After selecting the test method press the icon  (**START**).

5

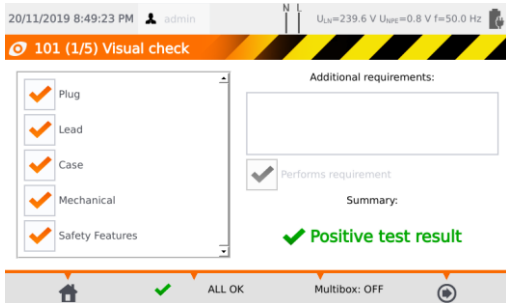

After visual test, check (or not) the corresponding boxes on the left side of the screen.





If you touch the **Additional requirements** box, you can add a note from the test.

Activate (or not) the **Multibox** function.

Then select the  icon.

Alternatively, if everything is correct and you do not want to enter comments, or have already entered them, select **ALL OK**.



- The test can be finished before the defined test time duration by pressing **STOP** button.
- When the result of a single test of the sequence is negative, the tester stops the sequence and does not proceed with the remaining tests. The failed test can be repeated (e.g. to verify whether the negative result was due to a connection error) by pressing **START** button again. In order to complete the test sequence and save the negative result into memory, press  to go to the end of the procedure.
- In the right side of the screen icons  and  are displayed. They are active only if you run a test for a specific appliance:
 - ⇒ by scanning a **QR code** placed on it,
 - ⇒ from menu **Browse memory > Client > Object > Appliance** using icon .

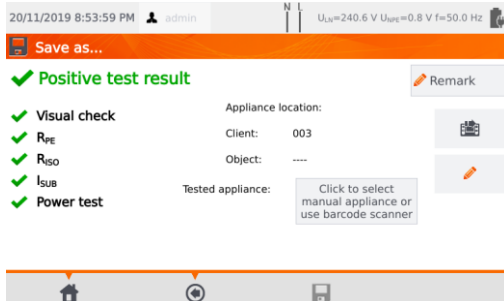



change the object the appliance is installed in.



edit information of the appliance that has been examined (see **sec. 3.3.16c**, step **3**).

6.3 Multibox function

Enabling this function (**Multibox: ON**) allows the user to perform multiple measurements of the parameter - except for power. The function is especially useful in situations when multiple measurements in a single point are required. Each measurement is treated as a separate. All of them are saved to the memory.

- To perform next measurement of the same parameter, use **+** button and press **START** or . Go to the next parameter using .
- The Multibox function is disabled by default (**Multibox: OFF**). Use **Sonel PAT Analysis** software to permanently enable an user procedure.

Measuring circuit for each test is the same as for its corresponding manual measurement.

6.3.1 Multibox OFF

1

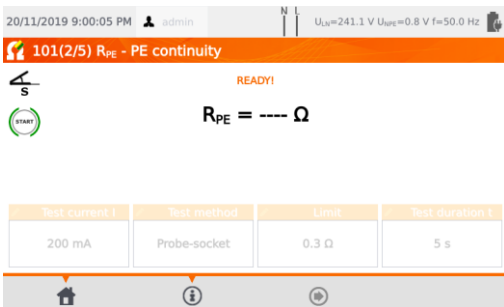

Press **START** or  to run the test sequence in the procedure.

Press **START** or  if you need to repeat the measurement. Only the last measurement will be included in the summary.

2

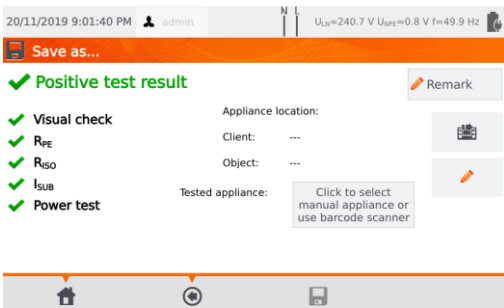



Upon completion of the measurement procedure and selecting  a summary screen is displayed.

The results can be saved into memory (see **section 7**).

6.3.2 Multibox ON

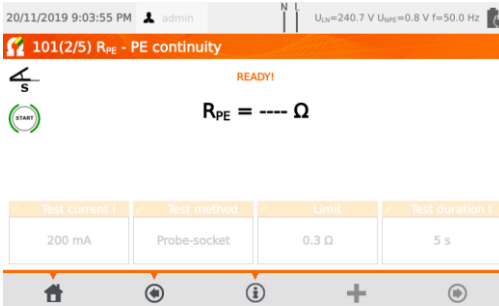
1





Press **START** or  to start the first measurement.

2





Press **START** or  if you have to repeat the measurement.

You can add a new measurement of the same parameter by pressing . The previous test result will be saved.

Press  to go to the next parameter to be tested.

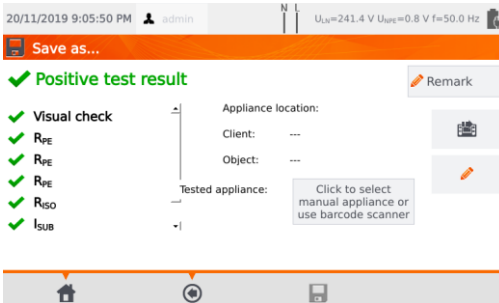
3



Upon completion of the measurement procedure and selecting  a summary screen is displayed.

The results can be saved into memory (see [section 7](#)).

7 Memory of measurement results

The tester's memory of the measurement results data has a tree structure. The user can save data for any number of clients. Any number of object can be assigned to each client. Every object contains:

- up to four levels of subobjects,
- any number of subobjects for each level.

Any number of appliances can be created for each object. The whole memory structure is limited only by the size of the built-in memory.

7.1 Storing the measurement results in the memory

1



For a single test press

2

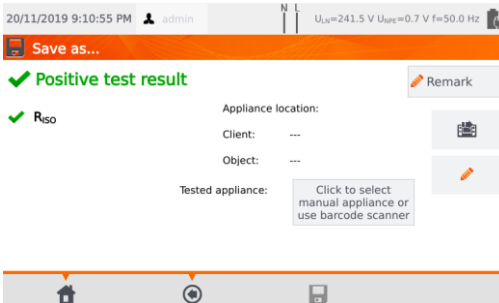

For each type of test (manual, auto) the result has to be assigned to a specific appliance, that exists in the memory. To do so:

- ⇒ press **Click to select manual appliance...** or
- ⇒ scan a barcode of the tested appliance.

The next step will look different depending on whether printer support is enabled or not (**sec. 3.3.5**).

3a

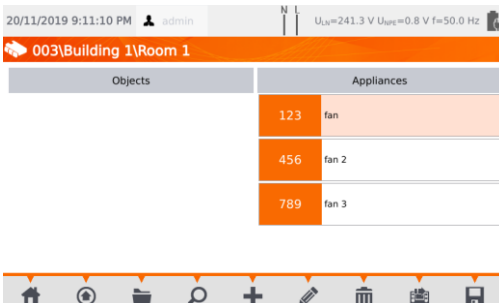



Printer support disabled
Auto printing disabled

Select an appliance in the data-base (or add a new one) and save the results with the icon

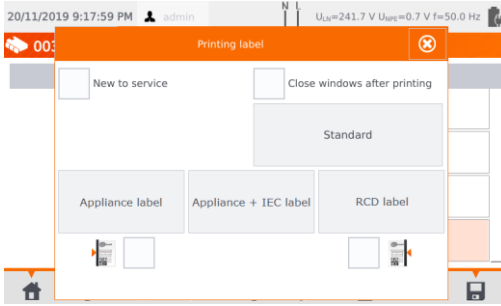
3b



Printer support enabled Auto printing enabled

- Select an appliance in the database (or add a new one) and save the results with the icon .
- If the object was tested for the first time, tick the appropriate box. In addition, set the sideline labeling method.
- Select the item with the desired type of label - the label will be printed and the result saved.
- If you close the window with the icon , the result will be saved, but the label will not be printed.



In case of auto measurement, if the code of the appliance was scanned at the beginning, the appliance will be selected automatically.

7.2 Browsing memory data

1

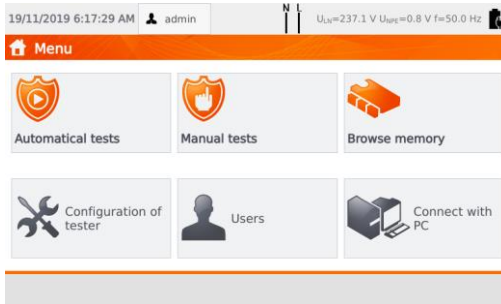

Press **Browse memory**.

2

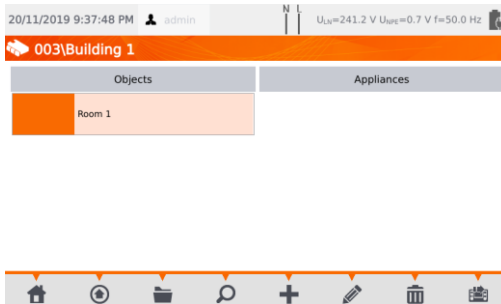

Enter the desired appliance. You can toggle the levels of the memory tree by:

- ⇒ double-tapping a label,
- ⇒ selecting a label and then  icon.

3

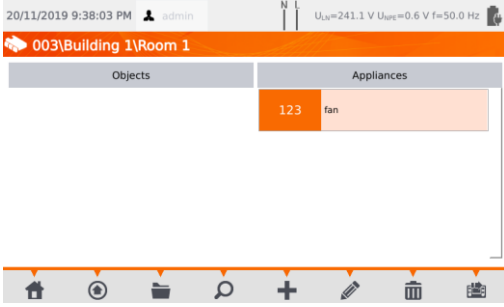

Open the appliance to display its measurement history.

4



The appliance data (left) and the list of measurements taken (right) are displayed.

Touch the measurement for details.

5

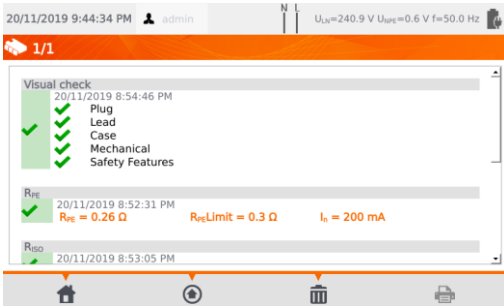

Test results screen (or several screens for automatic mode).

Using ◀ and ▶ scroll through next/previous results pages.

Press ⏪ to go back to the list of tests results.

Use button 🗑 (Delete) to delete the test result.

7.3 'Search' option in the memory

1

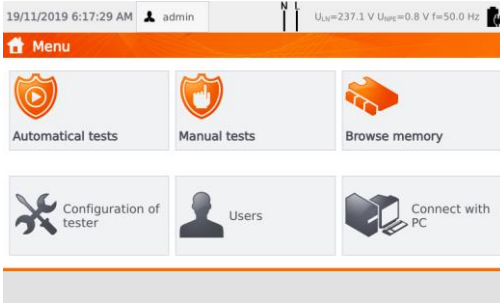

Press **Browse memory**.

2



Press  (**Search**) at any memory search window.

3

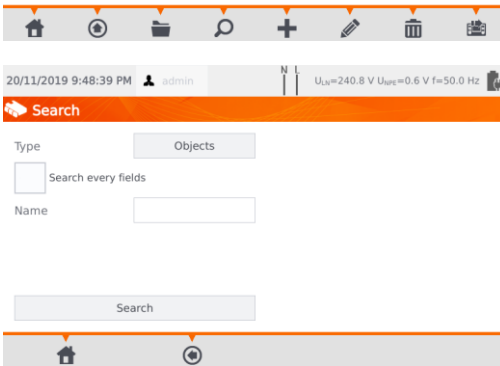

- Select between **Objects** and **Appliances**.
- Then fill out the search boxes to identify the appliance.
- If you check **Search every fields**, the entered phrase will be searched within all fields identifying objects or appliances.
- The size of letters in this option is ignored.

4

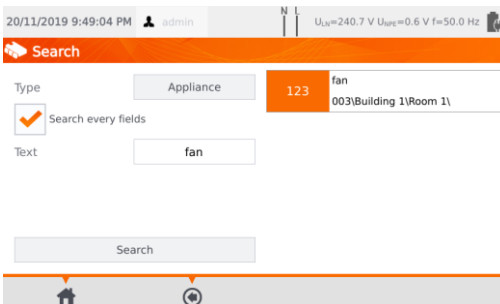

- Press **Search**.

7.4 Moving appliance into another object

1

20/11/2019 9:54:01 PM admin N L U_{LN}=241.0 V U_{LN}EQ=0.6 V F=50.0 Hz

003\Building 1\Room 1

Objects	Appliances
	123 fan

- Select the appliance to be moved.
- Press .

2

20/11/2019 9:54:15 PM admin N L U_{LN}=240.6 V U_{LN}EQ=0.6 V F=50.0 Hz

003\Building 1\Room 1

New location	Appliance to move
	Evidence No: 123 Name: fan Serial No: Current location: 003\Building 1\Room 1

Go to new location. If you resign, select .

3

20/11/2019 9:54:25 PM admin N L U_{LN}=240.9 V U_{LN}EQ=0.6 V F=50.0 Hz

003\Building 1

New location	Appliance to move
Room 1	Evidence No: 123 Name: fan Serial No: Current location: 003\Building 1\Room 1
Room 2	

Move object to:
003\Building 1

Go to new location. Confirm the transfer using .

7.5 Copying client's data from memory into USB drive back and forth

1 Insert USB flash drive into appropriate USB slot of the tester.

2

20/11/2019 10:01:47 PM admin N U_{bat}=240.3 V U_{usb}=0.6 V f=50.0 Hz

Tester memory

Clients:		Information about client:
003	SONEL S.A. default.client	Client ID: 003 Name: SONEL S.A. Address: Wokulskiego 11 58-100 Swidnica Phone: +48748583860 E-mail: export@sonel.com Contact person: Adam Ris

Home Folder Search + Edit Delete Copy Paste

To copy data into USB flash drive, select a client and press .

3

20/11/2019 10:02:05 PM admin N U_{bat}=240.1 V U_{usb}=0.6 V f=50.0 Hz

USB memory

Clients:		Information about client:
003	SONEL S.A. default.client	

Home Folder Search + Edit Delete Copy Paste

To copy data from USB flash drive into the tester's memory, browse the memory, select a client and press . Flash drive's content will be displayed.

4

20/11/2019 10:02:11 PM admin N U_{bat}=240.8 V U_{usb}=0.6 V f=50.0 Hz

USB memory

Clients:		Information about client:
003	SONEL S.A. default.client	Client ID: 003 Name: SONEL S.A. Address: Wokulskiego 11 58-100 Swidnica Phone: +48748583860 E-mail: export@sonel.com Contact person: Adam Ris

Home Folder Search + Edit Delete Copy Paste

 saves a client to the meter.

 leads back to the meter's memory menu.



NOTE!

Do not close the meter cover when the USB flash drive is in the USB port.

7.6 Deleting memory data

1



To delete client, object, appliance or test, select the item and press  (**Delete**).

2

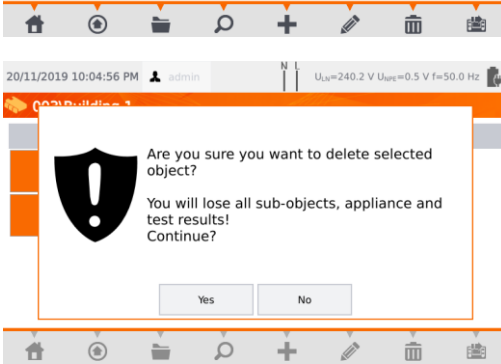

Press **Yes** to confirm deletion or **No** to cancel.

7.7 Meter's data backup

The meter provides the possibility to backup data stored within its internal memory and save them to a USB flash drive. The backup copy consists of folders:

- **AutoProcedures** – contains files of auto tests saved in the meter,
- **Clients** – contains files of all clients stored in the meter,
- **Settings** – contains files:
 - dictionary.db – database of words prompted while creating clients, appliances etc.,
 - settings.db – the user's database (language, prints settings etc.),
 - users.db – database of users of the meter,
 - wifi.db – database of wireless networks saved into the meter's memory.

1

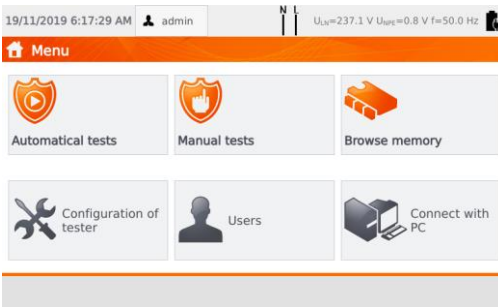

Insert USB memory into an appropriate socket in the meter. Press **Configuration of tester**.

2

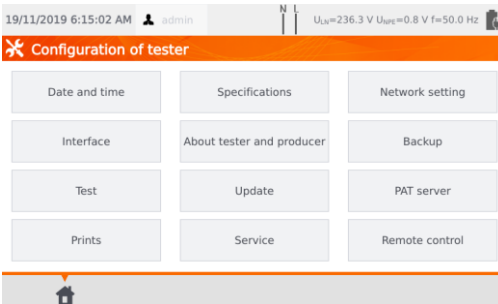

Select **Backup**.

3

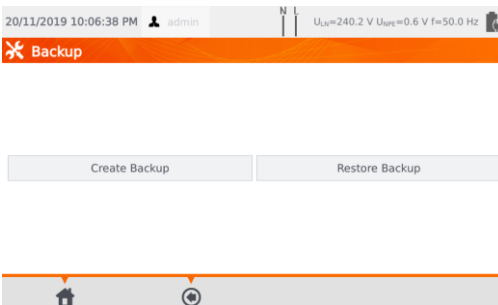

Decide whether to **create** a backup or **restore** it from files stored in the USB memory.

Press **Create Backup** to save backup files to USB memory.

Press **Restore Backup** to load the data from USB memory to the meter's memory.

If there is no backups in the USB memory, the **Restore Backup** button will be **inactive**.

8 Label printing

8.1 Printing availability

To print a label, the printing label option must be selected under Tester Configuration settings on home screen of the tester, and, if needed, the option for auto printing after test results are saved, can be enabled (see **sec. 3.3.5**).

- ⇒ D2 SATO or D3 Brother printer: connect it to one of the Host type USB sockets.
 - ⇒ D3 Brother printer: establish a WiFi connection – press **PLite** button, and then  two times. It can take up to 90 seconds from turning on the printer to connecting it to the meter.
- Printing is available in cases below.

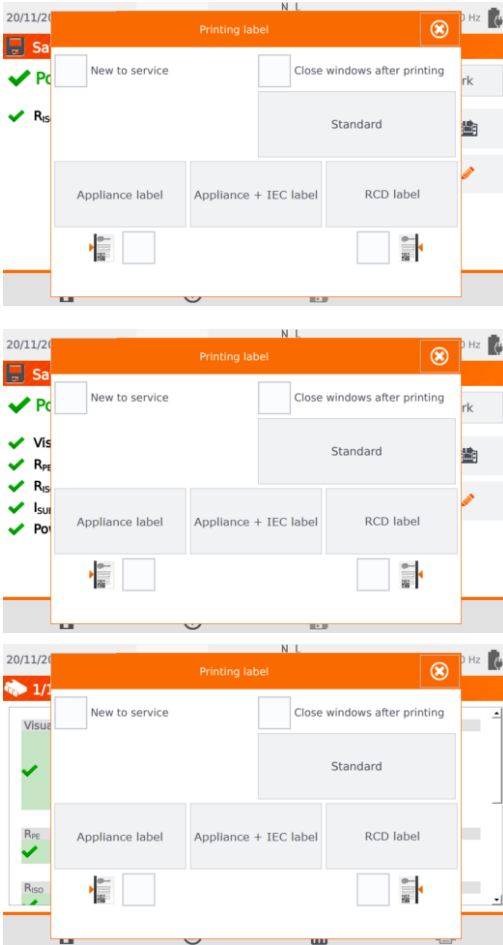

- ⇒ A single test is completed. When the result is being displayed on screen, after pressing  (**Save**) the tester will automatically ask to print a label.

When selecting **Perform auto-tests automatically** in the menu (see **sec. 3.3.5**), the label is printed immediately after pressing  (**Save**).

- ⇒ After completing the automatic test sequence. When the results are displayed the tester will automatically ask to print a label

- ⇒ When browsing memory. If a selected cell contains test results, press .

When **Printing Label** window shows up:

- ⇒ select **New to service** if the appliance is being tested for the first time,
- ⇒ tick the appropriate box, corresponding to the selected retest period (see **sec. 3.3.5**).

8.2 Label types

Before printing, you can set the format, template and time period marker.

Format

Detailed – contains a list of questions of the visual examination together with the assessment and the results of individual measurements with the assessment.

Standard – includes overall result of the test, logos and additional data (name of the device, measuring person).

Shorted – similar to standard format but without the logo and additional information.

Mini – only the identifier, name and QR code of the tested device are printed..

Template

⇒ **Appliance label** – basic printout,

⇒ **Appliance + IEC label** – printout containing the test result of the appliance and its IEC power cord,

⇒ **RCD label** – printout containing general RCD test result.

Time period of tests

Retest period can be put on label as a code and – exemplary – retest codes for a device using the tester's default settings is as follows:

⇒ 3 months retest period – stripes are printed along the left side of the label,

⇒ 6 months retest period – stripes are printed along the right side of the label,

⇒ 12 months retest period – stripes are printed along both sides of the label,

⇒ other retest period – no stripes printed.

Settings can be changed through **Sonel PAT Analysis** software, after connecting the tester to PC.

9 Power supply

The meter is powered by external power or a battery pack. When supplied from the mains, the battery pack is charged.

The charge level of the battery pack is indicated by the symbol in the right upper corner of the display on a current basis:



the battery pack is charged



the battery pack is discharged



the battery pack is being charged



NOTE!

- Only the manufacturer is authorized to replace the battery pack.
- Remember that measurements performed with an insufficient supply voltage feature additional errors which the user is unable to evaluate. Consequently, such measurements cannot prove correctness of measurement results.

10 Cleaning and maintenance



NOTE!

Apply solely the maintenance methods specified by the manufacturer in this manual.

The casing of the tester may be cleaned with a soft, damp cloth using all-purpose detergents. Do not use any solvents or cleaning agents which might scratch the casing (powders, pastes, etc.). Touch screen may be cleaned with all available cleaners dedicated for LCD screens.

The electronic system of the tester does not require maintenance.

11 Storage

In the case of storage of the device, the following recommendations must be observed:

- disconnect all the test leads from the tester,
- clean the tester and all its accessories thoroughly.
- recharge the battery every 3 months.

12 Dismantling and Disposal

Used electrical and electronic equipment should be collected selectively, i.e. it must not be placed with other kinds of waste.

Used electronic equipment should be sent to a collection point in accordance with the Used Electrical and Electronic Equipment Act.

Before the equipment is sent to a collection point, do not dismantle any elements.

Observe the local regulations concerning disposal of packages.

13 Technical data

13.1 Basic data

- ⇒ Abbreviation 'm.v.' used in the specification of measurement accuracy means a standard measured value.
- ⇒ Ranges and accuracies are additionally provided according to DIN VDE 404-1.

13.1.1 Measurement of network parameters

Measurement of network voltage

Range	Resolution	Accuracy
195.0 V...265.0 V	0.1 V	±(2% m.v. + 2 digits)

- measurement of the mains voltage between L and N of the power supply

Measurement of network frequency

Range	Resolution	Accuracy
45.0 Hz...65.0 Hz	0.1 Hz	±(2% m.v. + 2 digits)

- measurement of the mains voltage frequency of the power supply
- for the set value of 50 Hz, the range is 45 ... 55 Hz
- for the set value of 60 Hz, the range is 55 ... 65 Hz

Measurement of voltage occurring in PE line

Range	Resolution	Accuracy *
0.0 V...59.9 V	0.1 V	±(2% m.v. + 2 digits)

* for $U < 5$ V accuracy is not specified

- measurement of the mains voltage between PE and N of the power supply

13.1.2 Measurement of PE resistance

Measurement of resistance of protective conductor I = 200 mA (only Protection Class I)

Range	Resolution	Accuracy
0.00 Ω...0.99 Ω	0.01 Ω	±(4% m.v. + 2 digits)
1.00 kΩ...19.99 Ω		±(4% m.v. + 3 digits)

Influencing factor	Designation	Additional uncertainty
Position	E ₁	0%
Supply voltage	E ₂	0%
Temperature	E ₃	0.1% / °C for R ≥ 0.5 Ω 0% / °C for R < 0.5 Ω

- unloaded output voltage: 4 V... 12 V AC
- Test current: ≥200 mA for R = 0.2 Ω... 1.99 Ω
- adjustable upper limit in the range of: 10 mΩ ...1.99 Ω with resolution 0.01 Ω
- adjustable measuring time: 3 s...180 s with a resolution of 1 s and option **Continuous test**

PAT-85 PAT-86 Measurement of resistance of protective conductor I = 10 A (only Protection Class I)

Range	Resolution	Accuracy
0 mΩ...999 mΩ	1 mΩ	±(3% m.v. + 4 digits)
1.00 Ω...1.99 Ω	0.01 Ω	

Influencing factor	Designation	Additional uncertainty
Position	E ₁	0%
Supply voltage	E ₂	0%
Temperature	E ₃	0.1% / °C

- unloaded output voltage: <12 V AC
- test current: ≥10 A for R ≤ 0.5 Ω
- adjustable upper limit in the range of: 10 mΩ ...1.99 Ω with resolution 0.01 Ω
- adjustable measuring time in the range of: 3 s...180 s with resolution of 1 s

PAT-85 PAT-86 Measurement of resistance of protective conductor I = 25 A (only Protection Class I)

Range	Resolution	Accuracy
0 mΩ...999 mΩ	1 mΩ	±(3% m.v. + 4 digits)
1.00 Ω...1.99 Ω	0.01 Ω	

Influencing factor	Designation	Additional uncertainty
Position	E ₁	0%
Supply voltage	E ₂	0%
Temperature	E ₃	0.1% / °C

- unloaded output voltage: <12 V AC
- test current: ≥ 25 A for R ≤ 0.2 Ω
- adjustable upper limit in the range of: 10 mΩ ...1.99 Ω with resolution 0.01 Ω
- adjustable measuring time in the range of: 3 s...180 s with resolution of 1 s

13.1.3 Measurement of insulation resistance

PAT-85 PAT-86 Measurement of insulation resistance using test voltage of 100 V

Test range according to IEC 61557-2 for $U_N = 100\text{ V}$: 100 k Ω ...99.9 M Ω

Range	Resolution	Accuracy
0 k Ω ...1999 k Ω	1 k Ω	$\pm(5\% \text{ m.v.} + 8 \text{ digits})$
2.00 M Ω ...19.99 M Ω	0.01 M Ω	
20.0 M Ω ...99.9 M Ω	0.1 M Ω	

Influencing factor	Designation	Additional uncertainty
Position	E_1	0%
Supply voltage	E_2	0%
Temperature	E_3	0.1% / $^{\circ}\text{C}$
Capacitance	E_7	0% for $R \leq 20\text{ M}\Omega$ Unspecified for $R > 20\text{ M}\Omega$

- accuracy of generated voltage ($R_{\text{load}} [\Omega] \geq 1000 \cdot U_N [\text{V}]$): -0+30% from the set value
- nominal current: max. 1.4 mA
- adjustable lower limit within the range of 0.1 M Ω ...9.9 M Ω with resolution of 0.1 M Ω
- adjustable measuring time: 3 s...3 min with a resolution of 1 s and option **Continuous test**
- detection of a dangerous voltage before commencing a measurement
- discharging the tested object



For $R < 100\text{ k}\Omega$ the accuracy is not specified.

Measurement of insulation resistance using test voltage of 250 V

Test range according to IEC 61557-2 for $U_N = 250\text{ V}$: 250 k Ω ...199.9 M Ω

Range	Resolution	Accuracy
0 k Ω ...1999 k Ω	1 k Ω	$\pm(5\% \text{ m.v.} + 8 \text{ digits})$
2.00 M Ω ...19.99 M Ω	0.01 M Ω	
20.0 M Ω ...199.9 M Ω	0.1 M Ω	

Influencing factor	Designation	Additional uncertainty
Position	E_1	0%
Supply voltage	E_2	0%
Temperature	E_3	0.1% / $^{\circ}\text{C}$
Capacitance	E_7	0% for $R \leq 20\text{ M}\Omega$ Unspecified for $R > 20\text{ M}\Omega$

- accuracy of generated voltage ($R_{\text{load}} [\Omega] \geq 1000 \cdot U_N [\text{V}]$): -0+30% from the set value
- nominal current: max. 1.4 mA
- adjustable lower limit within the range of 0.1 M Ω ...9.9 M Ω with resolution of 0.1 M Ω
- adjustable measuring time: 3 s...3 min with a resolution of 1 s and option **Continuous test**
- detection of a dangerous voltage before commencing a measurement
- discharging the tested object



For $R < 250\text{ k}\Omega$ the accuracy is not specified.

Measurement of insulation resistance using test voltage of 500 V

Test range according to IEC 61557-2 for $U_N = 500 \text{ V}$: 500 k Ω ...599.9 M Ω

Range	Resolution	Accuracy
0 k Ω ...1999 k Ω	1 k Ω	$\pm(5\% \text{ m.v.} + 8 \text{ digits})$
2.00 M Ω ...19.99 M Ω	0.01 M Ω	
20.0 M Ω ...599.9 M Ω	0.1 M Ω	

Influencing factor	Designation	Additional uncertainty
Position	E ₁	0%
Supply voltage	E ₂	0%
Temperature	E ₃	0.1% / °C
Capacitance	E ₇	0% for $R \leq 20 \text{ M}\Omega$ Unspecified for $R > 20 \text{ M}\Omega$

- accuracy of generated voltage ($R_{\text{load}} [\Omega] \geq 1000 \cdot U_N [\text{V}]$): -0%+30% from the set value
- nominal current: max. 1.4 mA
- adjustable lower limit within the range of 0.1 M Ω 9.9 M Ω with resolution of 0.1 M Ω
- adjustable measuring time: 3 s...3 min with a resolution of 1 s and option **Continuous test**
- detection of a dangerous voltage before commencing a measurement
- discharging the tested object



For $R < 500 \text{ k}\Omega$ the accuracy is not specified.

Measurement of insulation resistance using test voltage of 1000 V

Test range according to IEC 61557-2 for $U_N = 1000 \text{ V}$: 500 k Ω ...599.9 M Ω

Range	Resolution	Accuracy
0 k Ω ...1999 k Ω	1 k Ω	$\pm(5\% \text{ m.v.} + 8 \text{ digits})$
2.00 M Ω ...19.99 M Ω	0.01 M Ω	
20.0 M Ω ...599.9 M Ω	0.1 M Ω	

Influencing factor	Designation	Additional uncertainty
Position	E ₁	0%
Supply voltage	E ₂	0%
Temperature	E ₃	0.1% / °C
Capacitance	E ₇	0% for $R \leq 20 \text{ M}\Omega$ Unspecified for $R > 20 \text{ M}\Omega$

- accuracy of generated voltage ($R_{\text{load}} [\Omega] \geq 1000 \cdot U_N [\text{V}]$): -0%+30% from the set value
- nominal current: max. 1.4 mA
- adjustable lower limit within the range of 0.1 M Ω 9.9 M Ω with resolution of 0.1 M Ω
- adjustable measuring time: 3 s...3 min with a resolution of 1 s and option **Continuous test**
- detection of a dangerous voltage before commencing a measurement
- discharging the tested object



For $R < 1000 \text{ k}\Omega$ the accuracy is not specified.

13.1.4 Measurement of leakage current

Substitute leakage current

Range	Resolution	Accuracy
0.00 mA...3.99 mA	0.01 mA	±(5% m.v. + 2 digits)
4.0 mA...19.9 mA	0.1 mA	

Influencing factor	Designation	Additional uncertainty
Position	E ₁	0%
Supply voltage	E ₂	0%
Temperature	E ₃	0.075% / °C

- opening voltage: 25 V...50 V
- internal resistance of the testing device 2 kΩ ± 20%
- adjustable upper limit in the range of: 0.01 mA... 19.90 mA with resolution of 0.01 mA
- adjustable measuring time in the range of: 1 s...60 s with resolution of 1 s and option **Continuous test**

PE leakage current



In the half-time of the measurement, the tester automatically changes the polarity of the test socket and as a final result it displays the value of higher leakage current.

Range	Resolution	Accuracy
0.00 mA...3.99 mA	0.01 mA	±(5% m.v. + 2 digits)
4.0 mA...19.9 mA	0.1 mA	

Influencing factor	Designation	Additional uncertainty
Position	E ₁	0%
Supply voltage	E ₂	0%
Temperature	E ₃	0.1% / °C
Power consumption of the tested appliance	E ₄	0%
Low frequency magnetic field	E ₅	0%
The shape of the network voltage (CF)	E ₈	0%

- test voltage from mains
- adjustable upper limit in the range of: 0.01 mA... 19.90 mA with resolution of 0.01 mA
- adjustable measuring time in the range of: 1 s...60 s with resolution of 1 s and option **Continuous test**

Differential leakage current



In the half-time of the measurement, the tester automatically changes the polarity of the test socket and as a final result it displays the value of higher leakage current.

Range	Resolution	Accuracy
0.00 mA...3.99 mA	0.01 mA	±(5% m.v. + 2 digits)
4.0 mA...19.9 mA	0.1 mA	

Influencing factor	Designation	Additional uncertainty	
Position	E ₁	0%	
Supply voltage	E ₂	0%	
Temperature	E ₃	0.1% / °C	
Power consumption of the tested unit	E ₄	Current common	
		0 A...4 A	0
		4 A...8 A	±0.03 mA
		8 A...16 A	±0.08 mA
Low frequency magnetic field	E ₅	2 digits < 4 mA 0 digits for ≥ 4 mA	
The shape of the network voltage (CF)	E ₈	0%	

- adjustable upper limit in the range of: 0.01 ... 9.9 mA with resolution of 0.01 mA/0.1 mA
- adjustable measuring time in the range of: 1 s...60 s with resolution of 1 s and option **Continuous test**

PE leakage current and differential current – clamp measurement

Range	Resolution	Accuracy
0.00 mA...9.99 mA	0.01 mA	±(5% m.v. + 5 digits)
10.0 mA...19.9 mA	0.1 mA	

- accuracy does not include the accuracy of the current clamp
- adjustable upper limit in the range of: 0.01 mA...19.90 mA with resolution of 0.01 mA
- adjustable measuring time in the range of: 1...180 s with resolution of 1 s and option **Continuous test**

Touch leakage current



The tester changes polarity automatically in the mains test socket during test, and it displays higher measured value as the final result.

Range	Resolution	Accuracy
0.000 mA...4.999 mA	0.001 mA	±(5% m.v. + 3 digits)

Influencing factor	Designation	Additional uncertainty
Position	E ₁	0%
Supply voltage	E ₂	0%
Temperature	E ₃	0.25 µA/°C
The shape of the network voltage (CF)	E ₈	0%

- the bandwidth of test current results from the measuring system with adjusted touch current which simulates human perception and reaction, in accordance with EN 60990:2002
- adjustable upper limit in the range of: 0.01 mA... 1.99 mA with resolution 0.01 mA
- adjustable measuring time in the range of: 1 s...60 s with resolution of 1 s and option **Continuous test**

PAT-86 Leakage current in welding machine's primary circuit I_p

Range	Resolution	Accuracy
0.00 mA...14.99 mA	0.01 mA	$\pm(5\% \text{ m.v.} + 5 \text{ digits})$

- measurement meets the requirements of EN 60974-4 standard

PAT-86 Leakage in welding machine's welding circuit I_L

Range	Resolution	Accuracy
0.00 mA...14.99 mA	0.01 mA	$\pm(5\% \text{ m.v.} + 5 \text{ digits})$

- measurement meets the requirements of EN 60974-4 standard

13.1.5 Testing RCDs / PRCDs

Measurement of RCD / PRCD parameters

RCD / PRCD tripping time t_A measurement for sine differential current

Measurement range in acc. with IEC 61557: 0 ms ... up to the upper limit of displayed value

RCD type	Rated Current multiplication factor	Measurement range	Resolution	Accuracy
General	0.5 $I_{\Delta n}$	0 ms...300 ms (999 s) ²⁾	1 ms	$\pm(2\% \text{ m.v.} + 2 \text{ digits})$ ¹⁾
	1 $I_{\Delta n}$	0 ms...150 ms		
	5 $I_{\Delta n}$	0 ms...40 ms		

¹⁾ for $I_{\Delta n} = 10 \text{ mA}$ and 0.5 $I_{\Delta n}$ accuracy is $\pm 2\% \text{ m.v.} \pm 3 \text{ digits}$

²⁾ AS/NZS 3017

Measurement of RCD / PRCD trip current I_A for sine differential current

Measurement range in acc. with IEC 61557: $(0.3...1.0)I_{\Delta n}$

Selected rated RCD current	Measurement range	Resolution	Test current	Accuracy
10 mA	3.0 mA...10.0 mA	0,1 mA	0.3 $I_{\Delta n}$...1.0 $I_{\Delta n}$	$\pm 5\% I_{\Delta n}$
15 mA	4.5 mA...15.0 mA			
30 mA	9.0 mA...30.0 mA			

- test current flow time: max. 3200 ms
- testing AC type RCD breakers
- start of the measurement from the positive or negative half sine period

13.1.6 Power test

Measurement of S power

Range	Resolution	Accuracy*
0 VA...999 VA	1 VA	±(5% m.v. + 3 digits)
1 kVA...3.99 kVA	0.01 kVA	

* current measurement with clamp ±(8% m.v. + 5 digits)

- adjustable measuring time in the range of: 1 s...60 s, with resolution of 1 s and option **Continuous test** (enabled by default), in AUTOTEST only adjustable: 1...60 s, with resolution of 1 s

Measurement of P power

Range	Resolution	Accuracy*
0 W...999 W	1 W	±(5% m.v. + 3 digits)
1 kW...3.99 kW	0.01 kW	

* current measurement with clamp ±(8% m.v. + 5 digits)

- adjustable measuring time in the range of: 1 s...60 s, with resolution of 1 s and option **Continuous test** (enabled by default), in AUTOTEST only adjustable: 1...60 s, with resolution of 1 s

Measurement of Q power

Range	Resolution	Accuracy*
0 W...999 Var	1 Var	±(5% m.v. + 3 digits)
1 kW...3.99 kvar	0.01 kvar	

Power factor PF

Range	Resolution	Accuracy
0.00...1,00	0.01	±(10% m.v. + 5 digits)

- adjustable measuring time in the range of: 1 s...60 s, with resolution of 1 s and option **Continuous test** (enabled by default), in AUTOTEST only adjustable: 1...60 s, with resolution of 1 s

Measurement of voltage THD

Range	Resolution	Accuracy
0.00%...999.9%	0.1%	±(5% m.v. + 5 digits)

Measurement of current THD

Range	Resolution	Accuracy
0.00%...999.9%	0.1%	±(5% m.v. + 5 digits)

Cosφ measurement

Range	Resolution	Accuracy
0.00i...1.00i	0.01	±(5% m.v. + 5 digits)
0.00c...1.00c		

Current consumption during power measurement

Range	Resolution	Accuracy
0.00 A...15.99 A	0.01 A	$\pm(2\% \text{ m.v.} + 3 \text{ digits})$

- adjustable measuring time in the range of: 1 s...60 s, with resolution of 1 s and option **Continuous test** (enabled by default), in AUTOTEST only adjustable: 1...60 s, with resolution of 1 s

Current consumption measurement with clamp during power measurement

Range	Resolution	Accuracy
100 mA...999 mA	1 mA	$\pm(5\% \text{ m.v.} + 5 \text{ digits})$
1.00 A...9.99 A	0.01 A	
10.0 A...24.9 A	0.1 A	

- accuracy above does not include accuracy of measurement clamp
- adjustable measuring time in the range of: 1 s...60 s, with resolution of 1 s and option **Continuous test** (enabled by default), in AUTOTEST only adjustable: 1...60 s, with resolution of 1 s

Voltage measurement in test socket

Range	Resolution	Accuracy
195.0 V...265.0 V	0.1 V	$\pm(2\% \text{ m.v.} + 2 \text{ digits})$

13.1.7 **PAT-86** Measurement of welding machine voltage without load

Measurement of U_{RMS} voltage

Range	Resolution	Accuracy
5.0 V...170.0 V	0.1 V	$\pm(2.5\% \text{ m.v.} + 5 \text{ digits})$

- measurement meets the requirements of EN 60974-4 standard

Measurement of U_P voltage (DC and AC_{peak})

Range	Resolution	Accuracy
5.0 V...240.0 V	0.1 V	$\pm(2.5\% \text{ m.v.} + 5 \text{ digits})$

- measurement meets the requirements of EN 60974-4 standard

Measurement of U_0 voltage

Range	Resolution	Accuracy
5.0 V...240.0 V	0.1 V	$\pm(2.5\% \text{ m.v.} + 5 \text{ digits})$

- measurement meets the requirements of IEC 61439 (60439) standard

13.2 Other technical data

- a) type of insulation acc. to EN 61010-1 and IEC 61557double



NOTE!

During the measurement of S, P, Q, I_{Δ} , I_{PE} and I_T , PE of the power supply socket is connected to PE of the test socket.

- b) measurement category acc. to EN 61010-1.....CAT II 300 V
 c) protection class of enclosure acc. to EN 60529 IP40
 d) power supply of the tester..... 195...265 V, 45...70 Hz
 e) load currentmax. 16 A (230 V)
 f) dimensions 318 x 257 x 152 mm
 g) weight.....ca. 5 kg
 h) storage temperature-10...+50°C
 i) operating temperature-20...+70°C
 j) humidity.....20...80%
 k) nominal temperature.....+20...+25°C
 l) reference humidity.....40...60%
 m) altitude.....<2000 m
 n) displayTFT 800 x 480 points
 o) memory of measurement results min. 4 GB
 p) data transfer USB 2.0, WiFi, LAN
 q) WiFi band frequency 2.4 GHz
 r) measurement standards.....EN 50678, EN 50699
 s) quality standards.....development, design and manufacturing are ISO 9001, ISO 14001, ISO 45001
 a) the product meets the EMC requirements acc. toEN 61326-1 and EN 61326-2-2



NOTE!

- During the measurement of PE continuity with 10/25 A current the tester may induce interferences of the values exceeding allowable limits defined in EN 61326-1 and cause interferences in other devices.
- If the meter freezes, you can restart it by holding the button  down for 8 seconds.



SONEL S.A. hereby declares that the radio device type PAT-80/85/86 complies with Directive 2014/53/EU. The full text of the EU Declaration of Conformity is available at the following website address: <https://sonel.pl/en/download/declaration-of-conformity/>

14 Optional accessories

The full list of accessories can be found on the manufacturer's website.

- calibration certificate with accreditation
- three-phase socket adapter, 16 A (5P)* – **WAADAPAT16P**
- three-phase socket adapter, 16 A (5P switchable)** – **WAADAPAT16PR**
- three-phase socket adapter, 16 A (4P) – **WAADAPAT16C**
- three-phase socket adapter, 16 A (4P switchable) – **WAADAPAT16CPR**
- three-phase socket adapter, 32 A (5P)* – **WAADAPAT32P**
- three-phase socket adapter, 32 A (5P switchable)** – **WAADAPAT32PR**
- three-phase socket adapter, 32 A (4P) – **WAADAPAT32C**
- three-phase socket adapter, 32 A (4P switchable) – **WAADAPAT32CPR**
- industrial socket adapter, 16 A (3P)*** – **WAADAPAT16F1**
- industrial socket adapter, 32 A (3P)*** – **WAADAPAT32F1**
- PAT-3F-PE adapter for testing leakage currents – **WAADAPAT3FPE**



* These adapters have permanently shorted lines of three-phase socket: L1, L2, L3 and they are connected to L line of one-phase socket.

** These adapters have a rotary switch allowing the following connections:

- 1 - L of test socket connected to L1
- 2 - L of test socket connected to L2
- 3 - L of test socket connected to L3
- 4 - L of test socket connected to L1+L2+L3 (shorted)

*** These adapters are designed for testing security of devices powered from industrial sockets 16 A and 32 A, providing that the tested device does not consume current higher than 16 A. The adapters enable users to perform all measurements available on the network measurement socket.



NOTE!

Adapters for three-phase sockets and for 32 A industrial sockets must not be used for the following measurements: leakage currents I_{PE} and I_{Δ} , power and current consumption (for detailed information on the use of adapters see PAT adapter's user manual).

- QR-code scanner, USB – **WAADACK2D**



To customize the newly bought reader DS4203 / DS4208 to cooperation with the PAT tester, connect it to the USB socket of turned on computer and read the code below.



15 Manufacturer

The manufacturer of the device, which also provides warranty and post-warranty services is:

SONEL S.A.

Wokulskiego 11

58-100 Świdnica

Poland

tel. +48 74 884 10 53 (Customer Service)

e-mail: customerservice@sonel.com

web page: www.sonel.com



NOTE!

Service repairs must be undertaken solely by the manufacturer.

NOTES

NOTES

NOTES



SONEL S.A.

Wokulskiego 11
58-100 Świdnica
Poland

Customer Service

tel. +48 74 884 10 53
e-mail: customerservice@sonel.com

www.sonel.com