



Measurement instruments

Sonel we measure globally

Multi-function meter
of electrical system parameters

Sonel MPI-540-PV



Measurements
of photovoltaic
installations

page 16

Sonel EVSE-01



Adapter for testing
vehicle charging stations

page 32



Maximum R_{ISO}
measuring
voltage: 2.5 kV

page 22

Multi-function meter
of electrical system parameters

Sonel MPI-536

Photovoltaic installation meters

Sonel PVM-1020 KIT

Sonel PVM-1020

Sonel IRM-1

page 34

Insulation quality analyzer

Sonel MIC-15k1

page 44



Contact resistance meter

Sonel MMR-6700

page 107



Wire tracer

Sonel LKZ-720 KIT

page 119



Thermal
imager

Sonel KT-256F

page 93



Pyrometer

Sonel DIT-200

page 96



AC digital clamp meter
with data logger

Sonel CMP-3kR

page 161



Safety tester for
electrical equipment







Sonel PAT-86

page 142



Sonel software 8



Electrical safety measurements 10

	Multi-function instruments NEW! Sonel MPI-502F	14-32
	Residual current device measurements PV installation measurements Accessories	33-40
	Insulation resistance measurements NEW! Sonel MIC-RS Accessories	41-58
	Fault loop measurements NEW! Sonel MZC-304F Accessories	59-67
	Earth (ground) measurements Accessories	68-81
	Sonel Reports Plus software	81

Measurement sets 82

	Measurement sets NEW! Sonel WME-8	82
---	---	----

Temperature measurements 84

	Thermal imagers, pyrometers NEW! Sonel KT-1K NEW! Sonel KT-256 / 256F Accessories	88-98
	Sonel ThermoAnalyze software	94

High voltage measurements 99

	Partial discharges meters High voltage insulation testers	104-103
---	--	---------

Low resistance measurements 105

	Low resistance meters Accessories	107-111
---	--------------------------------------	---------



Location of hidden infrastructure and faults 112

	Cable and underground infrastructure locators NEW! Sonel LKZ-2500 Reflectometers Accessories	114-123
---	--	---------



Illuminance measurements 124

	Illuminance meters Accessories	125
---	-----------------------------------	-----





Power quality analysis 126

	Power quality analyzers Accessories	128-135
	Sonel Analysis software	138



Safety of electrical equipment 139

	Safety of electrical equipment Accessories	141-147
	Sonel PAT Analysis software Sonel PAT Server software	145

Handheld devices 149

	Clamp meters NEW! Sonel CMP-1010 NEW! Sonel CMP-403 / 402 Accessories	152-163
	Multimeters Accessories	165-170
	Voltage testers	171-172
	Distance meter	172
	Phase sequence testers	173

Other devices 174

	Battery tester NEW! Sonel BT-120	175
	Leakage current alarm signaller	176
	Demonstration boards	177-178

SMT and THT assembly 179

Laboratory 180

Find out what problems you can solve **using Sonel products**.

Scan the code of the selected area **with your smartphone**.



Electromobility



Scan me

EVSE (*Electric Vehicle Supply Equipment*) charging stations are increasingly becoming part of the landscape of our cities, homes, workplaces and public spaces. Ensuring **maximum user safety** when operating them is the philosophy that defines our products. It is also important to guarantee **maximum comfort and ergonomics** by means of proper lighting in the charging area.



Photovoltaics



Scan me

Photovoltaic systems represent an **environmentally friendly source of renewable energy**. Photovoltaic cells work all year round - even in winter and the only condition for their operation is the presence of sunlight. Our equipment makes it possible to **measure the parameters of these systems**. A range of DC and AC side tests according to **EN 62446** is available, as well as all measurements to determine the **safety status of domestic electrical systems**.



Industry and Production

Sonel devices let you monitor the production process as well as the quality of the manufactured products. Analyse the power quality and the electrical installation status in order to avoid failure of your machines and devices. Control the safety parameters, ensure trouble-free operation and optimise energy generation in the facility thanks to the use of numerous dedicated series of measuring instruments and thermal imaging cameras. Using Sonel instruments, you can also ensure the continuity of operation by diagnosing problems before the occurrence of failure of important installations and devices.

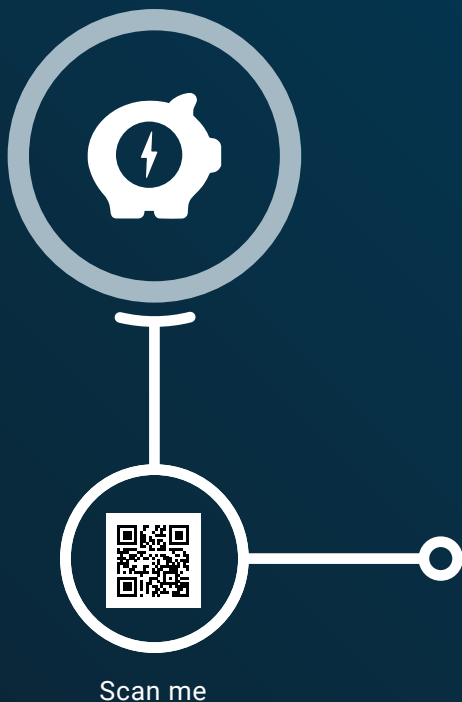

Energy Efficiency

In an era of rising utility prices, any savings are very welcome. When electricity, heat or fuel becomes more expensive, logic dictates that action needs to be taken appropriately to optimise the bills. Just which ones, specifically? How do you identify where and how to reduce costs? We want to help you answer these questions and offer you the tools you need to achieve your objectives: to improve energy efficiency with your customers, in your own business and at your home.

Stay up to date with our series of articles on areas of applications **and increase your safety.**

Time has allowed us to gain experience. We are a leader on the market!

- 1989** The beginning of activity as the Innovation Implementation Centre in Wrocław
- 1990** The first digital fault loop tester is created
- 1994** The production plant in Świdnica is opened
- 1995** The first Polish microprocessor-based insulation resistance meter is created
- 1996** Export sales of meters are initiated
- 1997** Start-up of surface mounting process in an automated line, and the creation of the first Polish microprocessor-based fault loop impedance meter
- 1998** Change of company name and legal entity
- 1999** The first Polish microprocessor-based earth resistance meter is manufactured
- 2001** Implementation and certification of quality management system
- 2004** First multi-function meter
- 2006** Sales in over 20 countries around the world
- 2008** Relocation to new headquarters and purchase of the most modern SMT assembly line in the world
- 2008** Debut on the Warsaw Stock Exchange
- 2008** Over 200 employees barrier exceeded
- 2010** Thermal imagers added to offer
- 2011** Creation of the first Polish safety tester of electrical equipment
- 2012** Implementation of SPS production management system
- 2013** Expansion into new markets
- 2013** Foxytech founded
- 2015** Start of cooperation with Lincoln Electric and acquisition of Lower Silesian Economic Certificate
- 2016** Won gold medal at the ENERGETAB trade fair in Bielsko-Biała - the largest electrotechnics and energy exhibition in Poland for PQM-711: power quality analyzer
- 2017** Acquisition of accreditation of Polish Centre for Accreditation
- 2018** Won gold medal at the ENERGETAB trade fair for MPI-540: multi-function meter of electrical system parameters
- 2019** We are celebrating 25 years on the market



Quality and safety

Our products have achieved a high position on the market thanks to the continuous development of the technologies and functions of the products we offer and their adaptation to market requirements. This has been confirmed by the following international certificates: **Quality Management System ISO 9001:2015, Environmental Management System ISO 14001:2015, and Occupational Health and Safety Management System ISO 45001:2018.** Manufactured instruments are compliant with standards **EN 61557, EN 61010 as well as the electromagnetic compatibility directive**, which allows us to bear the full responsibility that comes with the CE mark that we place on our products.



Be up to date with updates. Visit us online!

Complete product support is available on our website - including current: **meter firmware, drivers, instruction manuals, technical specifications and practical articles** that help to expand knowledge about the theory and practice of taking measurements.



for the latest news, visit:

www.sonel.com

facebook.com/sonel.measurement.instruments

youtube.com/sonelsafilm



Modern technologies for you

Our offer is not limited to measuring instruments only. We also provide calibration and rating services in our accredited Calibration and Research Laboratory. The calibration offer applies to all electrical safety meters. Besides such instruments, we also test many other meters of electrical values, including thermal imagers, pyrometers, illuminance meters and similar instruments.

We offer SMT surface mounting assembly services on a professional, automated assembly line manufactured by FUJI. We have two SMT surface assembly lines, a THT through-hole assembly line and inspection stations. All Assembly process are fulfill in accordance to IPC-A-610D standard.

We sincerely invite you to cooperate with us!

Products from SONEC S.A. are sold in nearly 50 countries around the world.



We care about our customers. Grow with us!

Excellent products, good logistical support, efficient guarantee and post-guarantee service as well as customer support after purchase are the most important elements of our success.

During numerous trainings, conferences and meetings organized by us, we systematically analyze the current needs of our clients

To satisfy these needs, we create new designs of measuring instruments that are fully adapted to users' expectations.

We are also preparing increasingly interesting training formulas. Over the course of training seminars and conferences, our specialists present the latest technological solutions, supported by an interpretation of currently applicable regulations and standards, and conduct practical demonstrations of measurement techniques.

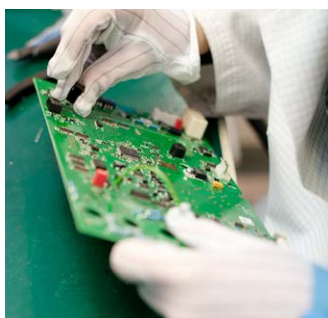

Electrical safety measurements

Current regulations require the measurements of electrical systems both during commissioning (after completing the installation, after any change or extension of the system), as well as regularly during the operation. The scope of acceptance or periodic inspection is specified in standard HD 60364-6. Requirements for measuring instruments are defined in standard EN 61557. Protective measures include, depending on needs, the measurement of fault loop impedance, insulation resistance, continuity of protection and equipotential bonding, earthing resistance and parameters of residual current devices. Devices used for this type of measurement shall have a document confirming their technical efficiency. Pursuant to the Metrology Act, this document shall be a calibration certificate. The period between checks of the instrument, recommended by the manufacturer is 12 months.

Measurement of fault loop impedance

One of measures for electric shock protection is a protection against indirect contact in circuits equipped with overcurrent protection - it is based on automatic disconnection of power supply in case of a dangerous touch voltage on the exposed conductive elements. In such case, the current will flow in the circuit of phase-protective conductor, and it is called the short-circuit current which should trip the overcurrent switch and power supply. As the exposed elements cannot remain too long under dangerous touch voltage, the protection has to trip in a sufficient time, which is specified in binding standards. The condition for correct protection is specified by the following formula:

$$Z_s = \frac{U_n}{I_A}$$

where: Z_s - fault loop impedance, I_A - current triggering overcurrent protection in required time (depending on the time-current characteristic of applied protection and required disconnection time), U_n - rated voltage of the network in relation to the earth.

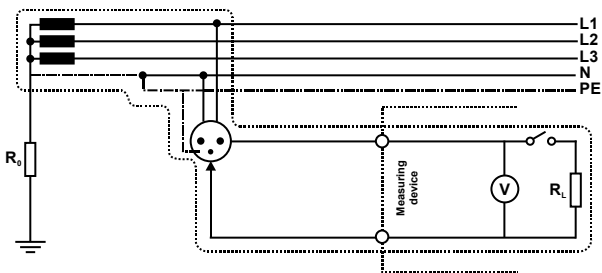

The impedance value Z_s (needed to determine whether the protection is correct) shall be measured. During fault loop measurement performed by the technical "method, an "artificial short circuit" is generated. The instrument measures the voltage without load and after that during a short-term load from short-circuit resistor. Fault loop impedance is calculated based on the difference in voltage drops. This measurement may be performed using the following fault loop impedance meters: MZC-304F, MZC-306, MZC-310S, MZC-320S and MZC-330S and MPI multifunctional meters - all of them indicate also components of the impedance, resistance and reactance.

$$Z = \sqrt{R^2 + X^2}$$

Fault loop impedance meters (except MZC-310S, MZC-320S and MZC-330S) provide also the measurement in L-PE circuits in systems protected by RCDs without any interference in the circuit. This measurement is carried out with current lower than 15 mA and it is extended in time, while the resolution of the result, is the same as for other measurements, i.e. 0.01 Ω . High current meters MZC-310S, MZC-320S and MZC-330S provide measurements with a result resolution of 0.1 m Ω (supply points, switchgear centres, transformer stations) applying the test current up to 300 A, which provides measurements in accordance with EN 61557 standard, even for circuits where the value of the fault loop impedance is in milli-ohm order.

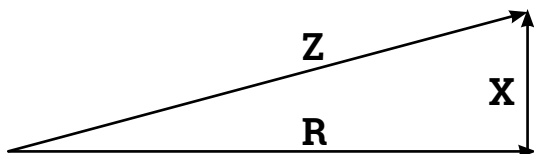

Fault loop impedance meters may be used for measuring the earth resistance by using an auxiliary voltage source (phase conductor of the network). The measured value is then overstated - the measurement result is the sum of resistance of the measured earth electrode, operational earthing system, source and phase conductor.

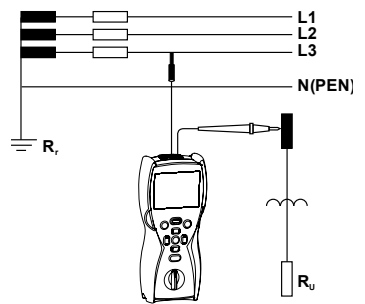

MZC-306 offers the measurements

- » for any AC voltages
- » up to 750 V – also in industrial systems.

Measurement of insulation resistance

The insulation condition is crucial for the operational safety and proper functioning of the system and electric appliances, guaranteeing also protection against direct contact. Systematic inspection of the insulation is necessary to detect its deterioration and it is a permanent element of measurement and control works. In case of measurements on industrial equipment it is crucial to determine the tendency of changes in the resistance, which may indicate a gradual deterioration of the insulation. The basic factors causing the insulation degradation include: electrical and mechanical exposures, chemical attack, thermal exposure and environmental pollution; their impact during normal operation of electrical system causes insulation wear and tear. Insulation resistance measurements are performed with direct current (DC), to eliminate the impact of capacitance on the results. The method of measuring insulation resistance and the required test voltages are specified in standards: PN-HD 60364-6; PN-E-04700; EN 61557-2. During the measurements, after applying the voltage, the insulation conducts electricity. During the resistance measurement, the current flowing through the insulation (1) consists of the following components:

- » capacitance charging current (2) - it depends on the capacitance (e.g. on the length of the tested cable),
- » polarization (absorption) current (3) - the result of charges and dipoles moved by electric field,
- » insulation leakage current (4) - the sum of currents flowing through the material and on its surface.

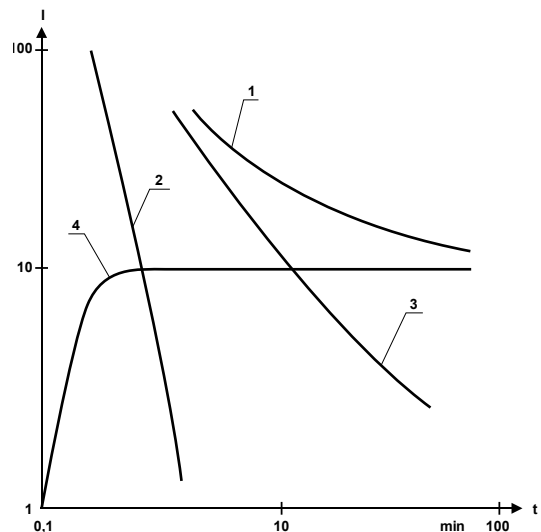

Due to the nature of the current flowing through the insulation, the measured insulation resistance value is affected by the time of measurement as well as by humidity, temperature, measurement voltage and surface cleanliness of the insulating material.

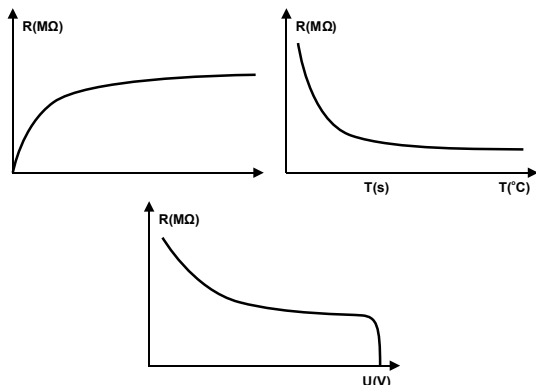

The 3-wire method, used in all advanced instruments, allows user to eliminate the impact of surface leakage current. In case of cables, wrap the core insulation with metal foil, which is connected to the shield terminal of the meter - only leakage current flowing through the insulation is measured. The measurement by 3-wire method is recommended for large areas exposed to pollutants (cables of large diameter, HV bushings, transformers, HV switches):

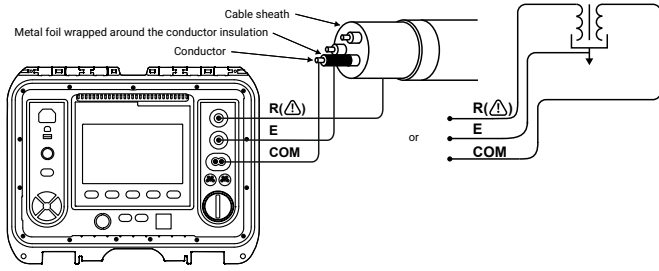

Using the 3-wire method is important in the case of measurements of objects with very large resistance values (100 M)

Meters MIC-10k1, MIC-5050, MIC-5010, MIC-5005, MIC-5001, MIC-2511, MIC-2501, MIC-30 as well as MPI-525 multifunctional meter, perform measurements at a specified time and provide readouts in intervals set by the user. The obtained results are used to calculate one or two absorption coefficients, providing information about the condition of the insulation. Before the measurements, make sure that the tested object is disconnected from the mains. Upon detection of voltage on the object (or when voltage appears during the measurements), the device stops the measurement signals the anomaly. During the measurement, the device displays the current, instantaneous value of the resistance or the current value of the leakage current. After completing the measurement, the devices save the values measured at the end of periods sets by the user (the range from 1 to 600 s) and the tested object is discharged by the device.

Measurements of RCD parameters

The main function of the Residual Current Device (RCD) is an additional protection against electric shock by disconnecting the protected circuit from power supply, when the circuit is subject to earth overcurrent.

When the circuit protected by the RCD is free from damage (differential current $I_{\Delta} = 0$), the inflow current I_1 is equal to outflow current I_2 . In case of any damage (e.g. punctured insulation) fault current I_{Δ} starts to flow and value of I_2 current is lower than I_1 .

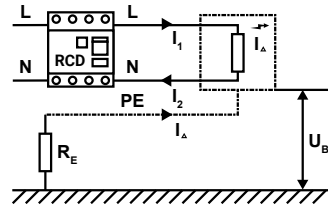

The RCD will trip (disconnecting power supply) if the measured difference of currents I and I_2 exceeds a certain characteristic for the RCD value. When a fault current flows, U_B voltage will appear on the housing of the protected device, which in accordance with Ohm's law is:

$$U_B = I_{\Delta} \cdot R_E$$

Rating current of the circuit breaker $I_{\Delta n}$ should be selected in a way ensuring that the contact voltage generated during fault current flow does not exceed the allowable long-term voltage U_L :

$$I_{\Delta n} < \frac{U_L}{R_E}$$

A system equipped with RCD must have, for safety reasons, a protective earthing conductor (PE). Therefore, the RCDs cannot be installed in networks without a dedicated protective conductor. RCD does not limit the fault current value, but only the time of its flow. However, as the criterion for tripping the RCD is the fault current exceeding the rated current of the RCD, it must be chosen appropriately to the type of protected devices. Due to the response time, the residual circuit devices are divided into: normal, short-time delay [G] - intended for receivers and circuits, where momentarily, small leakage currents and selective may occur. [S] - having a delayed triggering time, which is the minimum time, during which the device does not trip, despite the difference between the current flowing in and flowing out to/from the circuit. Depending on the shape of the fault current that causes tripping, the switches may be divided into: AC circuit breakers marked with [~] responding to a differential sinusoidal current, type A, marked with [A] responding to the sinusoidal, unidirectional pulsating current and pulsating current with constant component up to 6 mA, and B type switches marked with [B] responding to the sinusoidal, unidirectional pulsating current and pulsating current with constant component and to direct current Measurements on RCDs may be performed with MRP-201

meter or by multifunctional meters MPI.

During each measurement procedure (except AC voltage measurements), the me-

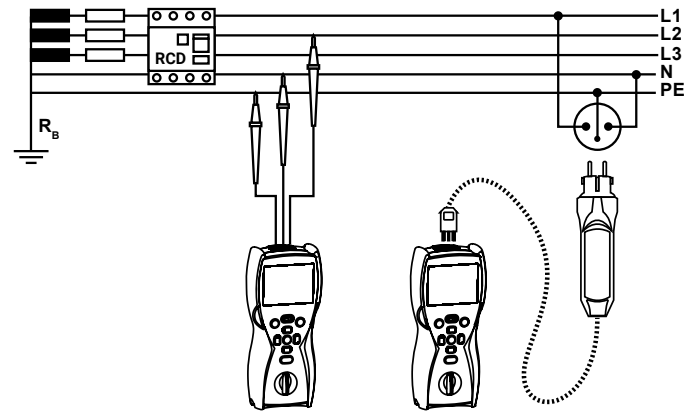

ter controls whether the resulting contact voltage does not exceed the predetermined voltage allowable for longer periods. If this value is exceeded, the measurement will be automatically interrupted (i.e. the differential test current is switched off). The value of the long-term allowable touch voltage can be set to 25 V or 50 V and for selective switches additionally at 12.5 V. The tripping time of RCD is measured from the start of differential current flow until the tripping of RCD - the user may select the initial phase (or polarity) as positive or negative. The maximum measured value of the triggering time is 300 ms, and with selected measurement of selective switches it is 500 ms. Tripping current of RCD is measured after enforcing a differential current increasing linearly in the tested circuit. The increases from approx. 30% of $I_{\Delta n}$ until RCD is tripped or $I_{\Delta n}$ exceeded for AC breakers (140% and 200% for A and B respectively).

With the touch electrode installed in the devices, instruments for RCD measurements may check the correctness of connections in the socket. When the voltage between the touch electrode and the protective conductor (PE) connected to the socket exceeds 50 V, the device will inform the user about it.

Measurements of resistance-to-earth

Earthing is an essential element of any electrical system regardless of its rated voltage. The efficient earthing system is important for:

- » human safety during the operation of electrical devices,
- » proper operation of electrical equipment,
- » elimination or significant reduction of the impact of lightning.

Earthing systems may be called differently depending on their destination. e.g.:

- » protective,
- » functional (working),
- » lightning protection,
- » auxiliary.

Checking the effectiveness of earthing, i.e. measuring its resistance or impedance, is carried out to determine whether the received value will effectively drain fault current. Term "effectiveness" means that the resistance does not exceed the maximum value allowed for the particular case and the type of the earth electrode.

Earthing system is subject to periodic checks, during the operation in order to assess whether corrosion or changes in soil resistivity do not significantly affect its performance.

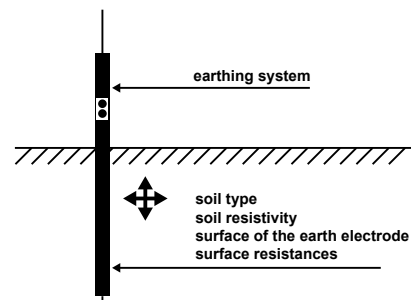

Methods of performing measurements are described in detail at www.sonel.com

Earthing measurements may be carried out with multifunctional meters having the appropriate function and with specialist meters of MRU series. The method most commonly used for measuring earth resistance is the technical method, where the meter calculates the resistance by measuring the voltage across its terminals after applying test current. For measurements of individual earthing systems, the most commonly used is 3-pole method of potential drop, which enforces current flow in the following circuit: the meter - tested earthing system - current electrode - the meter. Distances between the electrodes should be as large as possible; the current electrode should be at the distance of least 10-fold greater than the physical length of the measured earthing; In practice, the distance is approx. 40 m between the tested earth electrode and the current electrode.

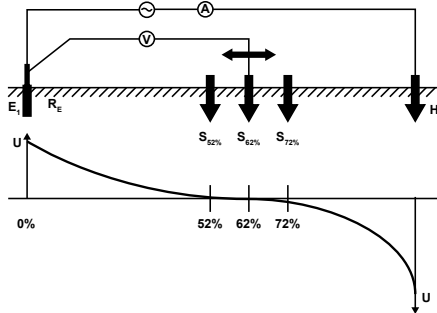

Distribution of voltage during the flow of the test current

voltage electrode is driven into the ground between the measured earth electrode and the current electrode in the area of the so-called zero potential. In practice, it is recommended to perform three measurements, changing the position of the voltage electrode by 1-2 meters in a direction from and to the tested earthing. If the results are identical, the place of driving the electrode into the ground has been chosen correctly. The measurement is performed with a current at a frequency that allows to avoid interference and distortion having the frequency of the network (50 Hz or 60 Hz) and its harmonics. Advanced earth resistance/resistivity meters of MRU series check and indicate the size of interference voltages before starting the measurement. In addition, these meters calculate the additional error related with too high resistance of probes.

Advanced devices have the ability to perform measurements using 4-lead method, eliminating the impact of the resistance of cable used to connect the meter with tested earthing system.

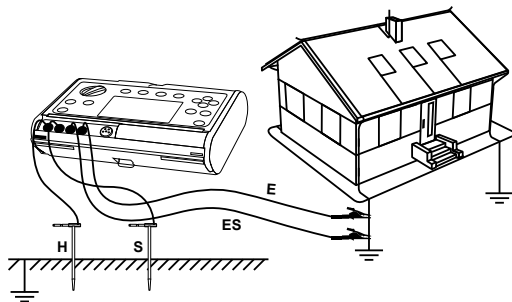

Measurement of resistance to earth - the 4-lead method

Nuisance arising from the need to disconnect individual earth electrodes when testing the systems with multiple electrodes may be eliminated by using the technical method with additional clamps (MRU-30, MRU-120, MRU-120HD, MRU-200, MRU-200-GPS, MPI-530, MPI-530-IT, MPI-535, MPI-536, MPI-540, MPI-540-PV). Current and voltage electrodes are arranged similarly to the 3-pole method, but the current is measured with clamps attached to the tested earthing. The meter calculates the resistance knowing that part of the current which flows through the tested earth electrode. The method of measurement with clamps cannot be used in multiple systems, which have individual earth electrodes connected to each other underground.

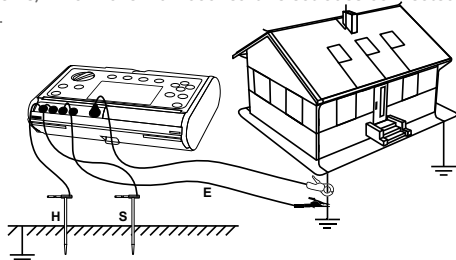

Measurement of resistance to earth - the 3P method + clamps

The 3-pole method with additional clamp has one more variation. Instead of using a directly connected current clamp with a split core, this method uses a special ERP-1 adapter. ERP-1 works with MRU meters with a measuring current of 200 mA. With use of a flexible clamp, it is possible to measure the total value of the current flowing through the earthing points of objects such as high and medium voltage pylons with a lattice structure or prestressed concrete spun transmission poles of medium and low voltage lines. The measurement procedure consists in wrapping the entire pole with the earthing with flexible clamp, thanks to which we measure the entire current flowing in the circuit to the ground.

The two-clamp method (MRU-30, MRU-120, MRU-120HD, MRU-200, MRU-200-GPS, MPI-530, MPI-530-IT, MPI-535, MPI-536, MPI-540, MPI-540-PV) allows the user to measure the resistance of multiple earthing systems, without the need to drive auxiliary probes into the ground. During this measurement, the current generated by transmission clamps is closed within the following circuit: tested earthing system + parallel connection of other earthing probes and it is measured by the receiving clamps to provide data for calculating the circuit resistance. As the parallel connection of a few resistances generates the resultant resistance of much lower value, the result is higher than the tested resistance. The difference is the smaller, the more earthing electrodes is within the tested object.

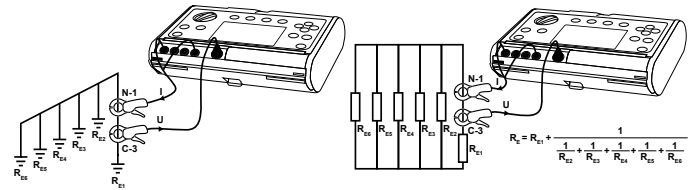

Connection of the meter in the 2-clamp method

Equivalent circuit of multiple earthing system in the 2-clamp method

The 2-clamp method is used for measurements of systems with multiple earthing electrodes not connected with each other underground. If the earthing electrodes are also connected underground, this method allows user to measure only the continuity of the circuit.

In the earthing system assessed for electric shock protection, it is important to maintain currents of low frequency (50, 60 Hz). The task of the lightning protection earthing systems is to discharge lightning strikes into the ground. The pulsed nature of such discharge makes the inductive component of the earth electrode quite important, as the lightning current is effectively discharged only by a part of the earth electrode, located in the immediate vicinity of the discharge. Therefore an earth electrode with low static resistance, which provides good basic protection does not ensure adequate lightning protection parameters - especially in the case of extensive earthing systems, having low static resistance, but several times higher dynamic impedance. The measurement using the impulse method (MRU-200, MRU-200-GPS), in accordance with: EN 62305 and withdrawn, but still applied PN-86/E-05003, enables user to diagnose the parameters of dynamic lightning protection earthing systems. The pulsed nature of the measurement does not require the disconnection of the earthing in case of multiple earthing probes or live objects, as the test current pulse, similarly to lightning stroke, operates only within a limited distance. The measurement is carried out in accordance with the description specified in EN 62305 standard. This method allows to determine the theoretical value of the surge impedance (Z_s), which is the ratio of peak voltage to peak current.

The surge impedance specified in the standard is a theoretical value, as generally peaks of voltage and current do not occur simultaneously. The surge impedance is considered an indicator of the effectiveness of earthing systems in the conditions of stricter or special protection.

Parameters of the test pulse (which simulates the shape of the lightning) are defined by two numbers: the pulse leading edge duration t_1 and a time to half-peak t_2 . The MRU-200 / MRU-200-GPS meter provides a selection of three pulse shapes: 10/350 μ s, 8/20 μ s and 4/10 μ s. Pursuant to EN 62305, the pulse with a shape of 10/350 μ s is typical for the first stroke of the lightning current. The same pulse is specified as a reference pulse in EN62305-1 standard. Pulse 4/10 μ s has parameters resulting from PN-92/E-04060.

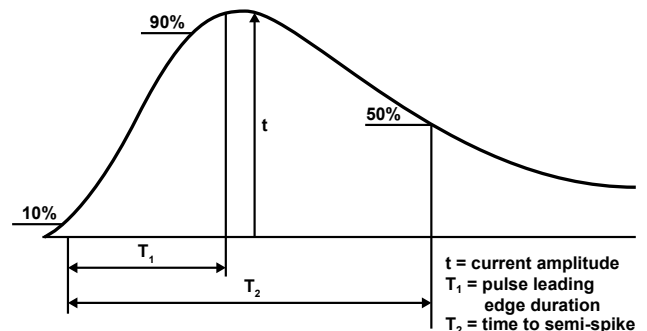

The shape of test pulse in the impulse method

All devices comply with European directives on electromagnetic compatibility and safety and are marked with CE

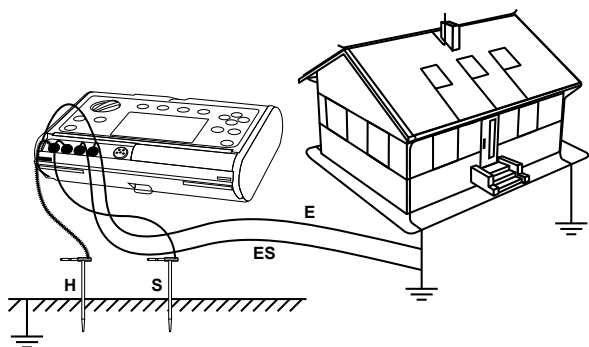

Earthing impedance measurement system (4P impulse method)

When the impulse method is used for measurements on multiple earthing systems, connected both above and under the ground, the test pulse operates only in the close proximity of tested earthing electrode, which allows user to carry out the measurement without the need to disconnect testing terminals and equipotential bondings - i.e. without the need to disconnect the power supply of the object.

The impulse method may also be used to measure the impedance of earthing used for HV poles; it allows also to determine the earthing impedance of the entire pole, including both ground band systems as well as the resistance of pole legs, and it may be used without the need to disconnect the tested HV line or to remove components of the earthing system.

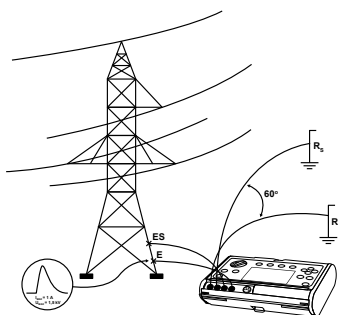

Measurements of HV pole earthing

Knowledge of the soil resistivity value (MRU-30, MRU-120, MRU-120HD, MRU-200, MRU-200-GPS, MPI-530, MPI-530-IT, MPI-535, MPI-536, MPI-540, MPI-540-PV) is important at the stage of designing the earthing system.

Knowing the cross-section of the soil, the user may select the appropriate type of earthing system - e.g. for low resistivity values occurring only at a certain depth, the single earth electrode may be designed as deeply immersed, whereas for soil with low resistivity at the shallower area; or rock base with a greater depth - it will be a set of shorter earthing electrodes connected by a vertical metal band.

Soil resistivity measurement is performed using four electrodes arranged linearly at equal distances (Wenner method). The soil resistivity is measured at the depth

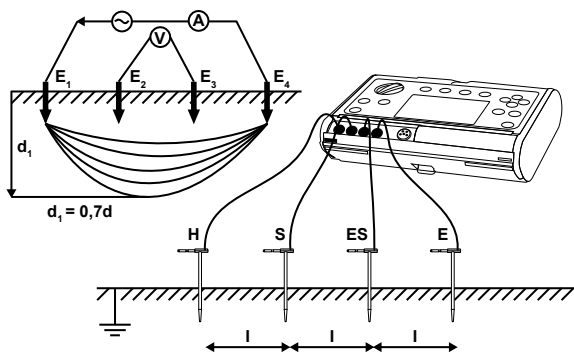

equal to 0.7 of the distance between the probes.

Facilitating the measurements

During measurements carried out under voltage (earth fault loop impedance, RCD parameters, voltage, sequence of phases) conductors ended with blade probes or crocodile clips may be used (of adequate measuring categories with a shape prevent slipping or disconnecting), as well as adapters suitable for measuring terminals/sockets.

Meters connected to the system equipped with sockets by a cable terminated with a mains plug, or by wires, automatically check the correctness of connections and signal any abnormalities. Measurements in single-phase sockets may be carried out using adapters ended with Uni-Schuko plug; the measurements are performed



also in the case of exchanging the phase conductor with neutral conductor (without the need for manual switching or using additional adapters). In addition, WS-01 and WS-03 adapters have buttons for triggering measurements and saving recorded values. For the measurements in three-phase or HV sockets, one of the following adapters may be optionally used: for three-phase sockets AGT-16P, AGT-32P, AGT-63P AGT-16C, AGT-32C and for HV sockets AGT-16T and AGT-32T.

Family of AutoISO adapters facilitate the insulation measurements carried out with suitable devices on insulation of 3-, 4- and 5-wire cables, without the need of manual selection of pairs and combinations of the measured wires. Adapter cables ended with crocodile clips (depending on the position 3, 4 or all 5) are attached to the tested cable cores; when the measurement is started, the adapter connected with the meters, performs the sequence of all required tests.



AutoISO-1000

AutoISO-2500

AutoISO-2511



AutoISO-5000



TWR-1J

AutoISO-2500 and **AutoISO-2511** adapter allows user to perform tests on cables under 2500 V voltage. In other hand, for **AutoISO-5000** adapter the test voltage is as high as 5000 .

TWR-1J adapter enables user to check RCD parameters before installing it within the system.

Instruments for measuring earth resistance are delivered with many ergonomic accessories that simplify measurements. Cables used for testing earthing systems, due to their length (50, 30, 25,15 meters) are wound on drums made of a material resistant to frost and strokes, allowing fast winding and unwinding by the user.

Sonel offers also long probes (80 cm) with a suitable cover, clamps of high sensitivity and accuracy (C-3, N-1) for earthing measurements without the need to disconnect the test connections or for current measurements, as well as special terminals guaranteeing adequate contact.

Measuring devices are supplied in appropriate casings or suitcases fitted to their sizes with inner compartments for transporting measuring accessories.

Detailed lists of standard and optional accessories can be found at the end of product groups.

Multi-function meters of electrical system parameters

MPI-540-PV
MPI-540
MPI-536
MPI-535



MPI-530-IT
MPI-530
MPI-525
MPI-520



MPI-507
MPI-506
MPI-502F
EVSE-01
MRP-201
PVM-1020 KIT / PVM-1020 / IRM-1



Comparison of multi-function meters



	MPI-540-PV / MPI-540 / MPI-536 / MPI-535	MPI-530-IT / MPI-530	MPI-525	MPI-520	MPI-507 / MPI-506	MPI-502F
Display	7" LCD touchscreen	LCD graphic	LCD graphic	LCD graphic	segmented LCD	segmented LCD
Network parameters recorder	three-phase / three-phase / - / -	single-phase	-	-	-	-
Autotests	√	-	-	-	-	-
Energy losses calculator	√ / √ / - / -	-	-	-	-	-
Fault loop impedance resolution [Ω]	0...1999	0...1999	0...1999	0...1999	0...1999	0...1999
Maximum resolution of fault loop impedance measurement [Ω]	0.001	0.001	0.01	0.01	0.01	0.01
Measurement voltages [V]	95...440	95...440	95...440	95...440	180...460	180...460
Resolution of fault loop impedance measurement without RCD tripping [Ω]	0,01	0,01	0,01	0,01	0.01	0,01
Calculation of fault current according to rated voltage	√	√	√	√	√	√
Calculation of fault current according to measured voltage	√	√	√	√	√	-
Automatic measurement in socket	√	√	√	√	√	√
Residual current device measurements	AC, A, F, B, B+, EV □ G S	AC, A, F, B, B+ □ G S	AC, A, F, B, B+ □ G S	AC, A, F, B, B+ □ G S	AC, A □ G S	AC, A □ G S
Automatic measurement of the full set of RCD parameters - RCD Auto	√	√	√	√	√	√
Measurement of tripping current I _A with rising current	10, 30, 100, 300, 500, 1000	10, 30, 100, 300, 500, 1000	10, 30, 100, 300, 500, 1000	10, 30, 100, 300, 500, 1000	10, 15, 30, 100, 300, 500	10, 30, 100, 300, 500
Simultaneous measurement of I _A and t _A in one RCD trip	√	√	√	√	√	√
Measurement of tripping time for factor of rated current	1/2 ⁿ , 1, 2, 5	1/2 ⁿ , 1, 2, 5	1/2 ⁿ , 1, 2, 5	1/2 ⁿ , 1, 2, 5	1/2 ⁿ , 1, 2, 5	1/2 ⁿ , 1, 2, 5
Measurement of touch voltage U _B	√	√	√	√	√	√
Detection of L and N swapping	√	√	√	√	√	√
Measurement of insulation resistance	√	√	√	√	√	-
Measurement voltages [V]	MPI-536 10 50, 100, 250, 500, 1000 MPI-536 1500, 2500	50, 100, 250, 500, 1000	50, 100, 250, 500, 1000, 2500	50, 100, 250, 500, 1000	100, 250, 500	-
Measuring range [Ω]	5G / 5G / 10G / 5G	10G	10G	3G	600M	-
Protection against appearance of voltage	√	√	√	√	√	-
Automatic discharging of object after measurement	√	√	√	√	√	-
Automatic measurement of multi-core cords with AutoISO-1000C adapter	√ / √ / - / √	√	√	√	-	-
Automatic measurement of multi-core cables with AutoISO-2500 adapter	- / - / √ / -	-	√	-	-	-
Sound signalling of time intervals for characteristics	√	√	√	√	-	-
Calculation of absorption coefficients	-	-	√	-	-	-
Continuity testing with current ≥ 200mA	√	√	√	√	√	√
Low-voltage resistance measurement	√	√	√	√	√	√
Earth resistance measurement	3p, 4p, 3p+clamps, double-clamp	3p, 4p, 3p+clamps, double-clamp	3p	3p	3p / -	-
Capability of setting limit for every function	√	√	-	-	-	-
Quick check of PE connection	√	√	√	√	√	√
Voltage measurement [V]	0...500	0...500	0...500	0...500	0...500	0...500
Frequency measurement [Hz]	√	√	√	√	√	√
Alternating current measurement [A]	optionally 0...3000	optionally 0...3000	-	optionally 0...400	-	-
Power and cosφ measurement	√ / √ / - / -	√	-	√	-	-
Measurement of U harmonics: I up to the 40th	√ / √ / - / -	√	-	-	-	-
THD measurement for U and I	√ / √ / - / -	√	-	-	-	-
Phase sequence check [V]	95...500	95...500	95...500	95...500	100...440	-
Memory (records)	unlimited	10 000 for every measurement type	990	990	990	990
Power supply	rechargeable battery	rechargeable battery / batteries	rechargeable battery / batteries	batteries / rechargeable battery	batteries / rechargeable batteries	batteries / rechargeable batteries
Built-in quick charger	√	√	√	√	-	-
Data transmission	USB, Bluetooth, Wi-Fi	USB, Bluetooth	USB	USB	Bluetooth	Bluetooth
Dimensions [mm]	288 x 223 x 75	288 x 223 x 75	288 x 223 x 75	288 x 223 x 75	220x102x61	220x102x61
Weight [kg]	2.5	2.2	2.2	2.2	0.8	0.8

Multi-function meter of electrical system parameters

SONEL MPI-540 / MPI-540-PV

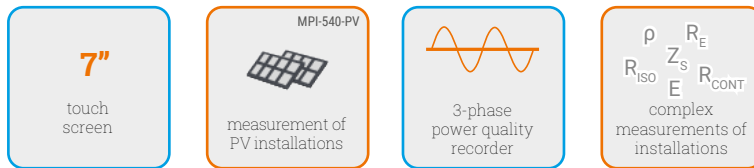
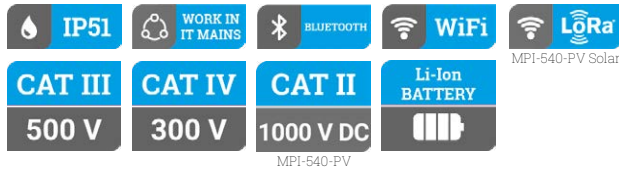

Features

- » **The largest touch screen on the market (7") – remarkable ergonomics and ease of use**
- » Removable microSD memory card – easy increase of memory capacity
- » Li-Ion battery – longer operation of the meter
- » **MPI-540-PV: measurement of photovoltaic installations according to EN 62446 standard**
- » MPI-540-PV: photovoltaic installation test report with **SoneI Reports Plus** software
- » **Three-phase power recorder – advanced power quality diagnostics**
- » Real time display of network parameters – immediate evaluation of the test site conditions
- » Parameters measured in accordance to class S of EN 61000-4-30 standard – high accuracy of measurements
- » Energy cost calculator – quick evaluation of potential savings
- » **Measurement of all parameters related to earthing and protection against electric shock – one device instead of several**
- » Quick measurement of the fault loop impedance in networks secured with RCD without triggering (up to several seconds) – time saver
- » Auto measurements – the ability to perform automatic measurements in sequence – simplified measurements
- » Fast path from measurements to report – time saver
- » **The MPI-540-PV instrument can measure photovoltaic installations in accordance with the EN 62446 standard:**
 - continuity of protective and equipotential bondings,
 - earth resistance,
 - insulation resistance on the DC side,
 - open circuit voltage U_{oc} ,
 - short circuit current I_{sc} ,
 - work currents and powers on both DC and AC side,
 - inverter efficiency.
- » **MPI-540 / MPI-540-PV can record 50/60 Hz power quality parameters in accordance to S class of EN 61000-4-30:**
 - voltage L1, L2, L3, – average values in the range up to 500 V,
 - L1, L2, L3 currents, – average values, current measurement in the range up to 3 kA (depending on the current probes used),
 - frequency in the range of 40 Hz – 70 Hz,
 - active (P), reactive (Q) and apparent (S) power,
 - power factor (PF), $\cos\phi$,
 - harmonics (up to 40th for voltage and current),
 - total harmonic distortion (THD) for current and voltage.
- » **MPI-540 / MPI-540-PV can be used for all measurements for commissioning of electrical installations in accordance with applicable regulations:**
 - short circuit loop impedance (also in circuits secured with RCDs),
 - RCD parameters,
 - insulation resistance,
 - earth resistance (4 measurement methods + soil resistivity measurement),
 - continuity of protective and equipotential bondings,
 - light intensity measurement,
 - phase sequence test,
 - motor rotation direction test.

Choose the best set for your needs

MPI-540-PV Solar

Multi-function meter of electrical and PV system parameters **with flexible coils and solar radiation measurement set**
index: WMGBMPI540PVIRMI

MPI-540-PV

Multi-function meter of electrical and PV system parameters **with flexible coils**
index: WMGBMPI540PV

MPI-540-PV Start

Multi-function meter of electrical and PV system parameters **without flexible coils**
index: WMGBMPI540PVNC

MPI-540

Multi-function meter of electrical system parameters **with flexible coils**
index: WMGBMPI540

MPI-540 Start

Multi-function meter of electrical system parameters **without flexible coils**
index: WMGBMPI540NC

Capabilities

The meter has **above-average functionality**. It combines the measuring capabilities of several devices, while ensuring equally good accuracy.





Automatic installation safety test

MPI-540 / MPI-540-PV allow safety control of **residential, commercial and industrial electrical installations**. Measurements can be easily automated with:

- » auto mode of residual current devices (RCD) tests,
- » auto measurements – freely configurable measuring sequences,
- » AutoISO-1000C adapter for automatic insulation resistance test of 3-, 4- and 5-conductor cables, without switching.

Photovoltaics under supervision

MPI-540-PV is an extremely universal meter, designed in particular for testing photovoltaic installations. The device allows a complete set of tests on the DC and AC side – in accordance with the guidelines of EN 62446 standard.

Measuring parameters related to the photovoltaic installation, the instrument will automatically convert them to the STC (Standard Test Conditions) reference conditions. Measurements of voltage, current and power on the AC and DC side of the inverter allow to verify its efficiency. **Sonel Reports Plus** software enables creating PV installation test report with measurement results saved meter's in memory..

Three-phase power quality recorder

The device has a three-phase power quality recorder with the LIVE mode view and the possibility to register electrical network parameters such as voltage, current, power, harmonics and THD. The meter enables reading of selected parameters and their graphic presentation on the screen in real time. These parameters are measured and displayed concurrently with the recording on the memory card. In the LIVE mode, the user can see:

- » voltage and current waveforms (oscilloscope),
- » voltage and current timeplots,
- » a phasor graph,
- » display of multiple parameters in tabular form,
- » spectrum graph of current and voltage harmonics.

Fault loop impedance measurements:

- » impedance measurement with 23 A current (40 A for phase-to-phase voltage), max. resolution 0.001 Ω ,
- » fault current-limiting resistor: 10 Ω ,
- » range of measurement voltages: 95...440 V, frequencies 45...65 Hz,
- » **fast fault loop impedance measurement with resolution up to 0.01 Ω in systems protected with RCDs not tripping at $I_{\Delta n} \geq 30$ mA,**
- » automatic calculation of fault current on the basis of nominal or measured voltage; differentiation of phase-to-neutral and phase-to-phase voltage,
- » measurements using UNI-Schuko plug with measurement triggering button (including case with swapped L and N leads) or 1.2 m, 5 m, 10 m, 20 m test leads, with optional use of three-phase socket adapters (AGT),
- » selection of installation protections and automatic evaluation of measurement results.

Testing of AC, A, F, B, B+ and EV residual current devices:

- » **MPI-540 / MPI-540-PV also enables measurements in IT networks,**
- » measurement of general, short-time delay and selective RCDs with rated residual currents of 10, 30, 100, 300, 500 and 1000 mA,
- » function of automatic measurement of all RCD parameters (after pressing the "START" button once, the meter performs the entire defined cycle of measurements, including the capability of earth fault loop impedance measurement with 15 mA current),
- » shape of the input leakage current selected by the user: sinusoidal (start from rising or falling edge), unidirectional pulsating (positive or negative), unidirectional pulsating with direct current offset (positive or negative), constant (positive or negative),
- » measurement of tripping current I_A with rising current,
- » measurement of tripping time t_A with currents $0.5 I_{\Delta n}$, $1 I_{\Delta n}$, $2 I_{\Delta n}$ and $5 I_{\Delta n}$,
- » measurement of touch voltage U_B and protective conductor resistance R_E without tripping the RCD,
- » detection of L and N phase swapping in a socket; does not affect measurements,
- » capability of measuring tripping current I_A as well as actual tripping time t_A with just one RCD trip,
- » voltage measurements within the range of 95...270 V.

Insulation resistance measurement:

- » measurement voltages: 50 V, 100 V, 250 V, 500 V, 1000 V,
- » measurement of insulation resistance up to 10 G Ω ,
- » capability measurement in-socket by means of UNI-Schuko adapter,
- » sound signalling of five-second time intervals, facilitating capture of time characteristics,
- » meter protected against the presence of voltage on the object and the appearance of voltage during measurement,
- » automatic discharge of the measured object's capacitance after completion of measurement,
- » **automatic measurement of all resistance combinations of 3-, 4- and 5-core cords by means of the optional AutoISO-1000C adapter.**

Earth resistance measurements:

- » according to 3- or 4-lead technical method with 2 auxiliary electrodes,
- » according to 3-lead method with additional clamp,
- » **according to double-clamp method,**
- » internal power source with frequency appropriate for 50 Hz or 60 Hz power network.

Soil resistivity measurements according to the Wenner method:

- » measuring range: 0.5 Ω m...9.99 k Ω m,
- » distances between electrodes can be set in meters (1...30 m) or feet (1...90 ft).

Low-voltage continuity testing of protective conductors and equipotential bonding:

- » measuring range according to EN 61557-4: 0.12...400 Ω , max. resolution 0.01 Ω ,
- » measurement of protective conductor continuity with current ≥ 200 mA in two directions,
- » low-current measurement with sound signaling,
- » voltage on open terminals: 4...9 V,
- » automatic calibration of test leads - leads of any length can be used.

Illuminance measurement:

- » display range: 0.001/0.01/0.1 lx...399.9 klx,
- » measurement in lux (lx) or foot-candles (fc),
- » measurement by means of external photodetectors (optional)

Additional functions of the meter:

- » real time display of network parameters,
- » autotests - pre-programmed measurement sequences,
- » quick check of correct connection of PE conductor by means of contact electrode,
- » check of phase sequence and direction of motor rotation,
- » tree-like memory structure with dynamic management
- » data transmission to PC via USB or Bluetooth[®],
- » replaceable microSD memory card,
- » power supply from rechargeable battery, built-in quick charger,
- » capability of charging from the power grid or 12 V car lighter socket.

Other technical specifications:

- » type of insulation double, as per EN 61010-1 and EN 61557
- » power supply Li-Ion battery 11.1 V 3.4 Ah 37.7 Wh
- » operating temperature range 0...+50 $^{\circ}$ C



Choose the best set for your needs

F-3A flexible coils

solar radiation measurement set



MPI-540-PV Solar
includes flexible coils and solar radiation measurement set



MPI-540-PV
includes flexible coils



MPI-540-PV Start
does not include flexible coils



MPI-540
includes flexible coils



MPI-540 Start
does not include flexible coils



Standard accessories:

		MPI-540-PV Solar	MPI-540-PV	MPI-540-PV Start	MPI-540	MPI-540 Start
		WMGBMPI540PVIRM1	WMGBMPI540PV	WMGBMPI540PVNC	WMGBMPI540	WMGBMPI540NC
Solar radiation measurement set	WMGBIRM1MPI	✓				
PVM-1 adapter	WAADAPVM1	✓	✓	✓		
C-PV clamp	WACEGCPVOKR	✓	✓	✓		
Adapter for C-PV clamp	WAADACPV	✓	✓	✓		
MC4-banana sockets adapter (set of 2 pcs.)	WAADAMC4	✓	✓	✓		
Carrying case M13	WAFUTM13	✓	✓	✓		
F-3A flexible coil (Ø120 mm)	WACEGF3AOKR	✓	✓		✓	
WS-03 adapter with START button with UNI-Schuko plug	WAADAWS03	✓	✓	✓	✓	✓
Test lead 1.2 m, red, 1 kV (banana plugs)	WAPRZ1X2REBB	✓	✓	✓	✓	✓
Test lead 1.2 m, blue, 1 kV (banana plugs)	WAPRZ1X2BUBB	✓	✓	✓	✓	✓
Test lead 1.2 m, yellow, 1 kV (banana plugs)	WAPRZ1X2YEBB	✓	✓	✓	✓	✓
Test lead 1.2 m, black, 1 kV (banana plugs)	WAPRZ1X2BLBBN	✓	✓	✓	✓	✓
Test lead 15 m, blue (on a reel)	WAPRZ015BUBBSZ	✓	✓	✓	✓	✓
Test lead 30 m, red (banana plugs, on a reel)	WAPRZ030REBBSZ	✓	✓	✓	✓	✓
USB cable	WAPRZUSB	✓	✓	✓	✓	✓
Crocodile clip, red, 1 kV, 20 A	WAKRORE20K02	✓	✓	✓	✓	✓
Crocodile clip, blue, 1 kV, 20 A	WAKROBU20K02	✓	✓	✓	✓	✓
Crocodile clip, yellow, 1 kV, 20 A	WAKROYE20K02	✓	✓	✓	✓	✓
Crocodile clip, black, 1 kV, 20 A	WAKROBL20K01	✓	✓	✓	✓	✓
Pin probe, red 1 kV (banana socket)	WASONREOGB1	✓	✓	✓	✓	✓
Pin probe, blue 1 kV (banana socket)	WASONBUOGB1	✓	✓	✓	✓	✓
Pin probe, yellow 1 kV (banana socket)	WASONYE0GB1	✓	✓	✓	✓	✓
2x earth contact test probe (rod), 30 cm	WASONG30	✓	✓	✓	✓	✓
Voltage adapter with M4/M6 thread (5 pcs.)	WAADAM4M6	✓	✓	✓	✓	✓
Z7 power supply	WAZASZ7	✓	✓	✓	✓	✓
Mains cable with IEC C7 plug	WAPRZLAD230	✓	✓	✓	✓	✓
Cable for battery charging from car cigarette lighter socket (12 V)	WAPRZLAD12SAM	✓	✓	✓	✓	✓
L2 carrying case	WAFUTL2	✓	✓	✓	✓	✓
L2 hanging straps (set)	WAPOZSZEKPL	✓	✓	✓	✓	✓
Li-Ion battery 11.1 V 3.4 Ah	WAAKU15	✓	✓	✓	✓	✓
MicroSD card		✓	✓	✓	✓	✓
Factory calibration certificate		✓	✓	✓	✓	✓



Solar radiation measurement set

index: WMGBIRM1MPI

Features

- » Measurement of solar radiation and temperature.
- » The LoRa interface for communication with the meter - offers a larger range than the Bluetooth technology!
- » Automatic data synchronization with the meter.
- » Built-in compass and inclination sensor.
- » Built-in recorder that can be used to record solar radiation before constructing PV systems, as well as to measure the shading of existing systems.
- » Large measurement memory: 999 cache memory cells and 5000 recorder records available (one-time recording) with the option of overwriting them (continuous recording).

Measured parameters

- » Solar radiation intensity (irradiance) in W/m² or BTU/ft²h.
- » PV panel temperature in °C or °F.
- » Ambient temperature in °C or °F.
- » Inclination angle of panels
- » Orientation of the panels with the built-in compass.

Standard accessories:

IRM-1 solar radiation and temperature meter	WMGBIRM1
IRM-1 mounting&measuring set	WAPOZUCHPV
5 V power supply with USB 2.0 output and a detachable micro-USB cable	WASONTPVCKPL
LORA-S1 USB adapter for data transmission	WAADAUSBLORA
M14 carrying case	WAFUTM14

Factory calibration certificate

Measurement of fault loop impedance Z_{L-PE} , Z_{L-N} , Z_{L-L} in 23/40 A mode

Measurement with 23/40 A current - measuring range according to EN 61557: 0.130 ...1999 Ω (for 1.2 m test lead):

Display range	Resolution	Accuracy
0.00...19.999 Ω	0.001 Ω	$\pm(5\% \text{ m.v.} + 0.03 \Omega)$
20.00...199.99 Ω	0.01 Ω	$\pm(5\% \text{ m.v.} + 0.3 \Omega)$
200.00...1999.9 Ω	0.1 Ω	$\pm(5\% \text{ m.v.} + 3 \Omega)$

- Nominal voltage: 95...270 V (for Z_{L-PE} and Z_{L-N}) or 95...440 V (for Z_{L-L} - only mode 23/40 A). Frequency: 45...65 Hz.

Measurement of the Z_{L-PE} fault loop impedance in the RCD mode

Measurement with 15 mA current - measuring range according to EN 61557: 0.50...1999 Ω

Display range	Resolution	Accuracy
0.00...19.99 Ω	0.01 Ω	$\pm(6\% \text{ m.v.} + 10 \text{ digits})$
20.00...199.99 Ω	0.1 Ω	$\pm(6\% \text{ m.v.} + 5 \text{ digits})$
200...1999 Ω	1 Ω	

- Nominal voltage: 95...270 V
- Frequency: 45...65 Hz

Earthing resistance measurement with two clamps

Display range	Resolution	Accuracy
0.00...9.99 Ω	0.01 Ω	$\pm(10\% \text{ m.v.} + 4 \text{ digits})$
10.0...19.9 Ω	0.1 Ω	
20.0...99.9 Ω		$\pm(20\% \text{ m.v.} + 4 \text{ digits})$

Measurement of insulation resistance

Measuring range according to EN 61557-2:

- for $U_n = 50 \text{ V}$: 50 k Ω ...250 M Ω
- for $U_n = 100 \text{ V}$: 100 k Ω ...500 M Ω
- for $U_n = 250 \text{ V}$: 250 k Ω ...99 M Ω
- for $U_n = 500 \text{ V}$: 500 k Ω ...2 G Ω
- for $U_n = 1000 \text{ V}$: 1000 M Ω ...9.99 G Ω

Display range	Resolution	Accuracy
0...1999 k Ω	1 k Ω	$\pm(3\% \text{ m.v.} + 8 \text{ digits})$
2.00...19.99 M Ω	0.01 M Ω	
20.0...199.9 M Ω		
200...999 M Ω	1 M Ω	$\pm(4\% \text{ m.v.} + 6 \text{ digits})$
1.00...4.99 G Ω	0.01 G Ω	
5...9.99 G Ω		

Indication of phase sequence

- Indication of phase sequence: compliant, non-compliant, display of phase-to-phase voltages
- U_{L-L} power system voltage range: 95...500 V (45...65 Hz)

AC current measurement (True RMS) with clamp

Clamp	Display range	Resolution	Accuracy
F-1A, F-2A, F-3A	0...3000 A (10 kA _{pp} @ 50Hz)	0.01% I_{nom}	$\pm 0.1\%$
C-4A	0...1000 A (3600 A _{pp})	0.01% I_{nom}	0.1...10 A: $\pm(3\% + 0.1 \text{ A})$ 10 A: $\pm 3\%$ 50 A: $\pm 1.5\%$ 200 A: $\pm 0.75\%$ 1000...1200 A: $\pm 0.5\%$
C-5A	0...1000 A (3600 A _{pp})	0.01% I_{nom}	0.5...100 A: $\leq(1.5\% + 1 \text{ A})$ 100...800 A: $\leq 2.5\%$ 800...1000 A AC: $\leq 4\%$ 800...1400 A DC: $\leq 4\%$
C-6A	0...10 A (36 A _{pp})	0.01% I_{nom}	0.01...0.1 A: $\pm(3\% + 1 \text{ mA})$ 0.1...1 A: $\pm 2.5\%$ 1...12 A: $\pm 1\%$
C-7A	0...100 A (360 A _{pp})	0.01% I_{nom}	0...100 A: $\pm(0.5\% + 0.02 \text{ A})$ (45...65 Hz) 0...100 A: $\pm(1.0\% + 0.04 \text{ A})$ (40...1000 Hz)

Illuminance measurement*

Display range [lx]	Resolution [lx]	Spectral uncertainty	Accuracy
0...3.999	0.001	f1 < 2%	$\pm(2\% \text{ m.v.} + 5 \text{ digits})$
4.00...39.99	0.01		
40.0...399.9	0.1		
400...3999	1		
4.00 k...39.99 k	0.01 k		
40.0 k...399.9 k	0.1 k		

*) for the LP-10A measuring probe

Measurements of RCD parameters (working voltage range 95...270V):

RCD trip test and measurement of tripping time t_A (for t_A measurement function)

RCD type	Factor	Range	Resolution	Accuracy
• General • Short-time delay • AC module in EV type	0.5 $I_{\Delta n}$	0...300 ms	1 ms	$\pm(2\% \text{ m.v.} + 2 \text{ digits})$ for RCD of $I_{\Delta n} = 10 \text{ mA}$ of the measurement with 0.5 $I_{\Delta n}$ accuracy: $\pm(2\% \text{ m.v.} + 3 \text{ digits})$
	1 $I_{\Delta n}$			
	2 $I_{\Delta n}$			
Selective	5 $I_{\Delta n}$	0...40 ms	0.1 s	$\pm(2\% \text{ m.v.} + 3 \text{ digits})$
	0.5 $I_{\Delta n}$	0...500 ms		
	1 $I_{\Delta n}$	0...200 ms		
• EV 6 mA DC • RCM	2 $I_{\Delta n}$	0...150 ms	1 ms	$\pm(2\% \text{ m.v.} + 3 \text{ digits})$
	5 $I_{\Delta n}$	0...150 ms		
	1 $I_{\Delta n}$	0.0...10.0 s		
	10 $I_{\Delta n}$	0...300 ms		
	33 $I_{\Delta n}$	0...100 ms		
	50 $I_{\Delta n}$	0...40 ms		

- Residual current input accuracy: for 0.5 $I_{\Delta n}$ 8...0%
for 1 $I_{\Delta n}$, 2 $I_{\Delta n}$, 5 $I_{\Delta n}$ 0...8%

Measurement of RCD trip current I_A for sinusoidal residual current (AC type)

Nominal current	Measuring range	Resolution	Measurement current	Accuracy
10 mA	3.0...10.0 mA	0.1 mA	0.3 $I_{\Delta n}$...1.0 $I_{\Delta n}$	$\pm 5\% I_{\Delta n}$
30 mA	9.0...30.0 mA			
100 mA	30...100 mA	1 mA	0.3 $I_{\Delta n}$...1.4 $I_{\Delta n}$	$\pm 10\% I_{\Delta n}$
300 mA	90...300 mA			
500 mA	150...500 mA			
1000 mA	300...1000 mA			

- Measurement can be started from the positive or negative half-period of the input leakage current (AC)

Measurement of RCD trip current I_A for uni-directional residual current and uni-directional current with 6 mA direct current offset (type A)

Nominal current	Measuring range	Resolution	Measurement current	Accuracy
10 mA	3.5...20.0 mA	0.1 mA	0.35 $I_{\Delta n}$...2.0 $I_{\Delta n}$	$\pm 10\% I_{\Delta n}$
30 mA	10.5...42.0 mA			
100 mA	35...140 mA	1 mA	0.35 $I_{\Delta n}$...1.4 $I_{\Delta n}$	$\pm 10\% I_{\Delta n}$
300 mA	105...420 mA			
500 mA	175...700 mA			

- Measurement can be started from the positive or negative half-period of the input leakage current (AC)

Measurement of RCD trip current I_A for residual direct current (type B)

Nominal current	Measuring range	Resolution	Measurement current	Accuracy
6 mA	1.0...6.0 mA	0.1 mA	1.0...6.0 mA	$\pm 6\% I_{\Delta n}$
10 mA	2.0...20.0 mA	0.1 mA	0.2 $I_{\Delta n}$...2.0 $I_{\Delta n}$	$\pm 10\% I_{\Delta n}$
30 mA	6...60 mA	1 mA		
100 mA	20...200 mA			
300 mA	60...600 mA			
500 mA	100...1000 mA			

- Measurement is possible for positive or negative input leakage current
- $I_{\Delta n}$ - nominal value of residual current

Measurement of R_E earth resistance using 3-lead, 4-lead, or 3-lead + clamp technical method

Measuring range according to EN 61557-5: 0.50 Ω ...1.99 k Ω for $U = 50 \text{ V}$ (3-lead, 4-lead):

Display range	Resolution	Accuracy 3p, 4p	Accuracy 3-lead with clamp
0.00...9.99 Ω	0.01 Ω	$\pm(2\% \text{ m.v.} + 4 \text{ digits})$	$\pm(8\% \text{ m.v.} + 4 \text{ digits})$
10.0...99.9 Ω	0.1 Ω		
100...999 Ω	1 Ω		
1.00...1.99 k Ω	0.01 k Ω	$\pm(2\% \text{ m.v.} + 3 \text{ digits})$	

"m.v." = "measured value"

The instrument meets the requirements set forth in the standards:

- EN 61010-1 (general and particular requirements related to safety)
- EN 61010-031 (general and particular requirements related to safety)
- EN 61326 (electromagnetic compatibility)
- EN 61557 (requirements for measurement instruments)
- HD 60364-6 (performance of measurements - checking)
- HD 60364-4-41 (performance of measurements - shock protection)
- PN-E 04700 (performance of measurements - commissioning tests)
- EN 12464 (lighting workplaces)
- EN 62446 (testing of PV panels) (MPI-540-PV only)

Three-phase power network data logger

» Measured parameters:

- voltages L1, L2, L3, N (four measurement inputs), minimum and maximum values within the range up to 550 V, interoperability with voltage transformers,
- currents L1, L2, L3 (three measurement inputs), average, minimum and maximum values, current measurement within the range up to 3 kA (depends on used clamps), interoperability with current transformers,
- frequency within the range of 40 Hz...70 Hz,
- active power (P), reactive power (Q), apparent power (S), inactive power Sn
- power registration: IEEE 1459,
- active energy (E_p), reactive energy (E_q), apparent energy (E_s),
- power factor (PF), cosφ,
- harmonics up to the 40th in voltage and current, total harmonic distortion THD for current and voltage,
- unbalance of voltages (in compliance with IEC 61000-4-30 class S) and currents,
- energy cost calculator,
- energy losses calculator.

» The instrument is intended for operation in networks:

- with rated frequency 50/60 Hz,
- with rated voltages: 64/110 V; 110/190 V; 115/200 V; 127/220 V; 220/380 V; 230/400 V; 240/415 V; 254/440 V; 290/500 V,
- with direct current.

» Supported network configurations:

- single-phase,
- two-phase with common N,
- three-phase - star with and without N conductor,
- three-phase - delta.



MPI-540 / MPI-540-PV meter enables estimation of power losses and related costs of poor power quality, through built-in energy loss calculator.

Recorder parameters

Parameter		Measuring range	Max. resolution	Accuracy
Alternating voltage (TRMS)	–	0.0...500 V	0.01% U _{nom}	±0.5% U _{nom}
Alternating voltage TRMS	–	depending on clamp*	0.01% I _{nom}	±2% m.v. if m.v. ≥ 10% I _{nom} ±2% I _{nom} if m.v. < 10% I _{nom} error does not account for clamp error)
Frequency	–	40.00...70.00 Hz	0.01 Hz	±0.05 Hz
Active, reactive, apparent and distortion power	–	depending on configuration (instrument transformers, clamp)	up to four places after the decimal point	depending on configuration (instrument transformers, clamp)
Active, reactive apparent energy	–	depending on configuration (instrument transformers, clamp)	up to four places after the decimal point	as power error
cosφ and power factor (PF)	–	0.00...1.00	0.01	±0.03
Harmonics	Voltage	as for alternating voltage True RMS	as for alternating voltage True RMS	±5% m.v. if m.v. ≥ 3% U _{nom} ±0.15% U _{nom} if m.v. < 3% U _{nom}
	Current	as for alternating voltage True RMS	as for alternating voltage True RMS	±5% m.v. if m.v. ≥ 10% I _{nom} ±0.5% I _{nom} if m.v. < 10% I _{nom}
THD	Voltage	0.0...100.0%	0.1%	±5%
	Current	(relative to RMS value)		
Unbalance factor	Voltage and current	0.0...10.0%	0.1%	±0.15% (absolute error)

*Clamp F-1A, F-2A, F-3A: 0...3000 AAC (10 000 A_{pp}) • Clamp C-4A: 0...1000 AAC (3600 A_{pp}) • Clamp C-5A: 0...1000 AAC/DC (3600 A_{pp}) • Clamp C-6A: 0...100 AAC (36 A_{pp}) • Clamp C-7A: 0...100 AAC (36 A_{pp})

MPI-540-PV | Specifications – photovoltaic installation parameters

Open circuit voltage U_{OC} measurement

Display range	Resolution	Accuracy
0.0 V...299.9 V	0.1 V	±(3% m.v. + 5 digits)
300 V...1000 V	1 V	±(3% m.v. + 2 digits)

Short circuit current I_{SC} measurement

Display range	Resolution	Accuracy
0.00 A...20.00 A	0.01 A	±(3% m.v. + 0.10 A)



Selected features of the Sonel MPI-540 / MPI-540-PV meter

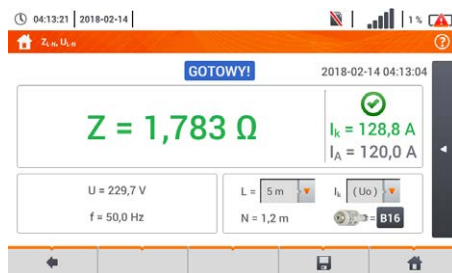

Fault loop impedance measurement



Network parameters recorder

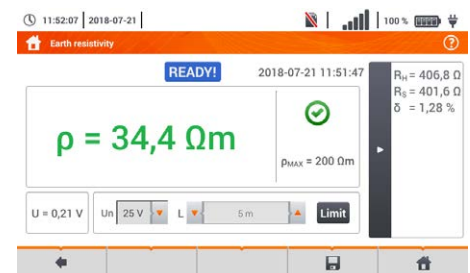

Ground resistivity measurement

Multi-function meter of electrical system parameters

SONEL MPI-536 / MPI-535

index: WMGBMPI536 / WMGBMPI535

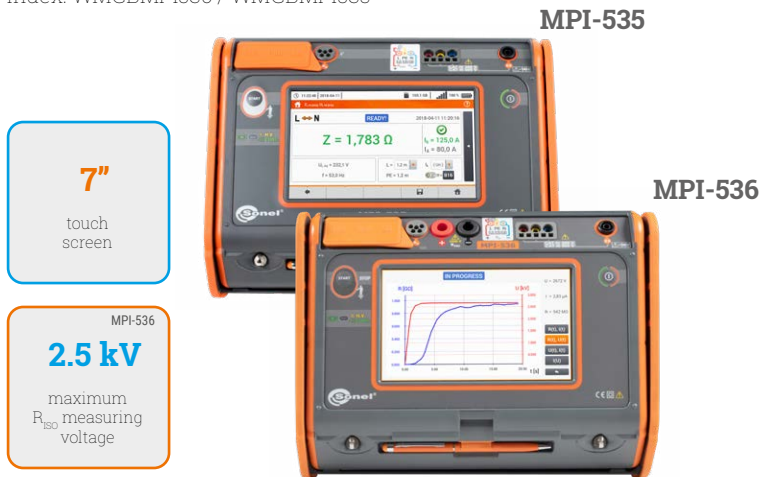

Fault loop impedance measurements:

- › impedance measurement with 23 A current (40 A for phase-to-phase voltage), max. resolution 0.001 Ω,
- › fault current-limiting resistor: 10 Ω,
- › range of measurement voltages: 95...440 V, frequencies 45...65 Hz,
- › **fast fault loop impedance measurement with resolution up to 0.01 Ω in systems protected with RCDs not tripping at $I_{\Delta n} \geq 30$ mA**,
- › automatic calculation of fault current on the basis of nominal or measured voltage; differentiation of phase-to-neutral and phase-to-phase voltage,
- › measurements using UNI-Schuko plug with measurement triggering button (including for swapped L and N leads) or 1.2 m, 5 m, 10 m, 20 m test leads, with optional use of three-phase socket adapters (AGT),
- › selection of installation protections and automatic evaluation of measurement results.

Testing of AC, A, F, B, B+ and EV residual current devices:

- › measurement of general, short-time delay and selective RCDs with rated residual currents of 10, 30, 100, 300, 500 and 1000 mA,
- › function of automatic measurement of all RCD parameters (after pressing the "START" button once, the meter performs the entire defined cycle of measurements, including the capability of earth fault loop impedance measurement with 15 mA current),
- › shape of the input leakage current selected by the user: sinusoidal (start from rising or falling edge), unidirectional pulsating (positive or negative), unidirectional pulsating with direct current offset (positive or negative), constant (positive or negative),
- › measurement of tripping current I_A with rising current,
- › measurement of tripping time t_A with currents $0.5 I_{\Delta n}$, $1 I_{\Delta n}$, $2 I_{\Delta n}$ and $5 I_{\Delta n}$,
- › measurement of touch voltage U_B and protective conductor resistance R_E without tripping the RCD,
- › detection of L and N phase swapping in a socket; does not affect measurements,
- › capability of measuring tripping current I_A as well as actual tripping time t_A with just one RCD trip,
- › voltage measurements within the range of 95...270 V.

Insulation resistance measurement:

- › measurement voltages:
 - MPI-535 | 50 V, 100 V, 250 V, 500 V, 1000 V,
 - MPI-536 | 10 V, 50 V, 100 V, 250 V, 500 V, 1000 V, 1500 V, 2500 V,
- › measurement of insulation resistance up to:
 - MPI-535 | 5 GΩ,
 - MPI-536 | 10 GΩ,
- › capability measurement in-socket by means of UNI-Schuko adapter,
- › sound signalling of five-second time intervals, facilitating capture of time characteristics,
- › meter protected against the presence of voltage on the object and the appearance of voltage during measurement,
- › automatic discharge of the measured object's capacitance after completion of measurement,
- › **automatic measurement of all resistance combinations of 3-, 4- and 5-core cords by means of the optional adapter:**
 - MPI-535 | AutoISO-1000C,
 - MPI-536 | AutoISO-2500.

Earth resistance measurements:

- › according to 3- or 4-lead technical method with 2 auxiliary electrodes,
- › according to 3-lead method with additional clamp,
- › according to double-clamp method,
- › internal power source with frequency appropriate for 50 Hz or 60 Hz power network.

Standard accessories:

MPI-536 MPI-535

WS-03 adapter with START button with UNI-Schuko plug	WAADAWS03	1	1
Test lead 1.2 m, red, 1 kV (banana plugs)	WAPRZ1X2REBB	1	1
Test lead 1.2 m, blue, 1 kV (banana plugs)	WAPRZ1X2BUBB	1	1
Test lead 1.2 m, yellow, 1 kV (banana plugs)	WAPRZ1X2YEBB	1	1
Test lead 1.8 m, red, 5 kV (banana plugs)	WAPRZ1X8REBB	1	
Test lead 1.8 m, black, 5 kV (banana plugs)	WAPRZ1X8BLBB	1	
Test lead 15 m, blue (on a reel)	WAPRZ015BUBBSZ	1	1
Test lead 30 m, red (banana plugs, on a reel)	WAPRZ030REBBSZ	1	1
USB cable	WAPRZUSB	1	1
Crocodile clip, red, 1 kV, 20 A	WAKRORE20K02	1	1
Crocodile clip, blue, 1 kV, 20 A	WAKROBU20K02	1	1
Crocodile clip, yellow, 1 kV, 20 A	WAKROYE20K02	1	1
Crocodile clip, black, 11 kV, 32 A	WAKROBL32K09	1	
Pin probe, red 1 kV (banana socket)	WASONREOGB1	1	1
Pin probe, blue 1 kV (banana socket)	WASONBUOGB1	1	1
Pin probe, yellow 1 kV (banana socket)	WASONYEGB1	1	1
Pin probe, red 5 kV (banana socket)	WASONYEGB2	1	
Earth contact test probe (rod), 30 cm	WASONG30	2	2
Z7 Power supply	WAZASZ7	1	1
Mains cable with IEC C7 plug	WAPRZLAD230	1	1
Cable for battery charging from car cigarette lighter socket (12 V)	WAPRZLAD12SAM	1	
L2 carrying case	WAFUTL2	1	1
L2 hanging straps (set)	WAPOZSZEKPL	1	1
Li-Ion battery 11.1 V 3.4 Ah	WAAKU15	1	1
Factory calibration certificate		1	1

Soil resistivity measurements according to the Wenner method:

- › measuring range: 0.5 Ωm...9.99 kΩm,
- › distances between electrodes can be set in meters (1...30 m) or feet (1...90 ft).

Low-voltage continuity testing of protective conductors and equipotential bonding:

- › measuring range according to EN 61557-4: 0.12...400 Ω,
- › max. resolution 0.01 Ω,
- › measurement of protective conductor continuity with current ≥ 200 mA in two directions,
- › low-current measurement with sound signalling,
- › voltage on open terminals: 4...9 V,
- › automatic calibration of test leads - leads of any length can be used.

Illuminance measurement:

- › display range: 0.001/0.01/0.1 lx...399.9 klx,
- › measurement in lux (lx) or foot-candles (fc),
- › measurement by means of external photodetectors (optional)

Additional functions of the meter:

- › autotests - pre-programmed measurement sequences,
- › quick check of correct connection of PE conductor by means of contact electrode,
- › check of phase sequence and direction of motor rotation,
- › tree-like memory structure with dynamic management
- › data transmission to PC via USB or Bluetooth®,
- › replaceable microSD memory card,
- › power supply from rechargeable battery, built-in quick charger,
- › capability of charging from the power grid or 12 V car lighter socket.

Other technical specifications:

- › type of insulation double, as per EN 61010-1 and EN 61557
- › power supply Li-Ion rechargeable battery 11.1 V 3.4 Ah 37.7 Wh
- › operating temperature range 0...+50°C

Measurement of fault loop impedance Z_{L-PE} , Z_{L-N} , Z_{L-L} in 23/40 A mode

Measurement with 23/40 A current - measuring range according to EN 61557: 0.130 ...1999 Ω (for 1.2 m test lead):

Display range	Resolution	Accuracy
0.00...19.999 Ω	0.001 Ω	$\pm(5\% \text{ m.v.} + 0.03 \Omega)$
20.00...199.99 Ω	0.01 Ω	$\pm(5\% \text{ m.v.} + 0.3 \Omega)$
200.00...1999.9 Ω	0.1 Ω	$\pm(5\% \text{ m.v.} + 3 \Omega)$

- » Nominal voltage: 95...270 V (for Z_{L-PE} and Z_{L-N}) or 95...440 V (for Z_{L-L} - only mode 23/40 A). Frequency: 45...65 Hz.

Measurement of the Z_{L-PE} fault loop impedance in the RCD mode

Measurement with 15 mA current - measuring range according to EN 61557: 0.50...1999 Ω

Display range	Resolution	Accuracy
0.00...19.99 Ω	0.01 Ω	$\pm(6\% \text{ m.v.} + 10 \text{ digits})$
20.00...199.99 Ω	0.1 Ω	$\pm(6\% \text{ m.v.} + 5 \text{ digits})$
200...1999 Ω	1 Ω	

- » Nominal voltage: 95...270 V
- » Frequency: 45...65 Hz

Earthing resistance measurement with two clamps

Display range	Resolution	Accuracy
0.00...9.99 Ω	0.01 Ω	$\pm(10\% \text{ m.v.} + 4 \text{ digits})$
10.0...19.9 Ω	0.1 Ω	
20.0...99.9 Ω		$\pm(20\% \text{ m.v.} + 4 \text{ digits})$

Measurement of insulation resistance

Measuring range according to EN 61557-2:

- » MPI-536 | for $U_n = 10 \text{ V}$: 10 k Ω ...99.9 M Ω
- » for $U_n = 50 \text{ V}$: 50 k Ω ...250 M Ω
- » for $U_n = 100 \text{ V}$: 100 k Ω ...500 M Ω
- » for $U_n = 250 \text{ V}$: 250 k Ω ...999 M Ω
- » for $U_n = 500 \text{ V}$: 500 k Ω ...2.00 G Ω
- » MPI-535 | for $U_n = 1000 \text{ V}$: 1000 k Ω ...4.99 G Ω
- » MPI-536 | for $U_n = 1000 \text{ V}$: 1000 k Ω ...3.00 G Ω
- » MPI-536 | for $U_n = 1500 \text{ V}$: 1500 k Ω ...5.00 G Ω
- » MPI-536 | for $U_n = 2500 \text{ V}$: 2500 k Ω ...9.99 G Ω

Display range	Resolution	Accuracy
0...1999 k Ω	1 k Ω	$\pm(3\% \text{ m.v.} + 8 \text{ digits})$
2.00...19.99 M Ω	0.01 M Ω	
20.0...199.9 M Ω		
200...999 M Ω	1 M Ω	
MPI-535 1.00...4.99 G Ω MPI-536 1.00...9.99 G Ω	0.01 G Ω	$\pm(4\% \text{ m.v.} + 6 \text{ digits})$

Indication of phase sequence

- » Indication of phase sequence: compliant, non-compliant, display of phase-to-phase voltages
- » U_{L-L} power system voltage range: 95...500 V (45...65 Hz)

Measurements of RCD parameters (operating voltage range 95...270 V):

RCD trip test and measurement of tripping time t_A (for t_A measurement function)

RCD type	Factor	Range	Resolution	Accuracy
• General • Short-time delay • AC module in EV type	0.5 $I_{\Delta n}$	0...300 ms	1 ms	$\pm(2\% \text{ m.v.} + 2 \text{ digits})$
	1 $I_{\Delta n}$			
	2 $I_{\Delta n}$			
Selective	5 $I_{\Delta n}$	0...40 ms	1 ms	for RCD of $I_{\Delta n} = 10 \text{ mA}$ of the measurement with 0.5 $I_{\Delta n}$ accuracy: $\pm(2\% \text{ m.v.} + 3 \text{ digits})$
	0.5 $I_{\Delta n}$	0...500 ms		
	1 $I_{\Delta n}$	0...200 ms		
• EV 6 mA DC • RCM	2 $I_{\Delta n}$	0...150 ms	1 ms	$\pm(2\% \text{ m.v.} + 3 \text{ digits})$
	5 $I_{\Delta n}$	0...150 ms		
	1 $I_{\Delta n}$	0.0...10.0 s		
	10 $I_{\Delta n}$	0...300 ms		
	33 $I_{\Delta n}$	0...100 ms		
	50 $I_{\Delta n}$	0...40 ms		

- » Residual current input accuracy:
for 0.5 $I_{\Delta n}$ 8...0%
for 1 $I_{\Delta n}$, 2 $I_{\Delta n}$, 5 $I_{\Delta n}$ 0...8%

Measurement of RCD trip current I_A for sinusoidal residual current (AC type)

Nominal current	Measuring range	Resolution	Measurement current	Accuracy
10 mA	3.0...10.0 mA	0.1 mA	0.3 $I_{\Delta n}$... 1.0 $I_{\Delta n}$	$\pm 5\% I_{\Delta n}$
30 mA	9.0...30.0 mA			
100 mA	30...100 mA			
300 mA	90...300 mA	1 mA		
500 mA	150...500 mA			
1000 mA	300...1000 mA			

- » Measurement can be started from the positive or negative half-period of the input leakage current (AC)

Measurement of RCD trip current I_A for uni-directional residual current and uni-directional current with 6 mA direct current offset (type A)

Nominal current	Measuring range	Resolution	Measurement current	Accuracy
10 mA	3.5...20.0 mA	0.1 mA	0.35 $I_{\Delta n}$... 2.0 $I_{\Delta n}$	$\pm 10\% I_{\Delta n}$
30 mA	10.5...42.0 mA			
100 mA	35...140 mA			
300 mA	105...420 mA	1 mA		
500 mA	175...700 mA			

- » Measurement can be started from the positive or negative half-period of the input leakage current (AC)

Measurement of RCD trip current I_A for residual direct current (type B)

Nominal current	Measuring range	Resolution	Measurement current	Accuracy
6 mA	1.0...6.0 mA	0.1 mA	1.0...6.0 mA	$\pm 6\% I_{\Delta n}$
10 mA	2.0...20.0 mA	0.1 mA		
30 mA	6...60 mA	1 mA		
100 mA	20...200 mA			
300 mA	60...600 mA			
500 mA	100...1000 mA			
			0.2 $I_{\Delta n}$... 2.0 $I_{\Delta n}$	$\pm 10\% I_{\Delta n}$

- » Measurement is possible for positive or negative input leakage current
- » $I_{\Delta n}$ - nominal value of residual current

Measurement of R_E earth resistance using 3-lead, 4-lead or 3-lead + clamp technical method

Measuring range according to EN 61557-5:
0.50 Ω ...1.99 k Ω for $U = 50 \text{ V}$ (3-lead, 4-lead):

Display range	Resolution	Accuracy 3p, 4p	Accuracy 3-lead with clamp
0.00...9.99 Ω	0.01 Ω	$\pm(2\% \text{ m.v.} + 4 \text{ digits})$	$\pm(8\% \text{ m.v.} + 4 \text{ digits})$
10.0...99.9 Ω	0.1 Ω		
100...999 Ω	1 Ω		
1.00...1.99 k Ω	0.01 k Ω	$\pm(2\% \text{ m.v.} + 3 \text{ digits})$	

"m.v." = "measured value"

The instrument meets the requirements set forth in the standards:

- » EN 61010-1 (general and particular requirements related to safety)
- » EN 61010-031 (general and particular requirements related to safety)
- » EN 61326 (electromagnetic compatibility)
- » EN 61557 (requirements for measurement instruments)
- » HD 60364-6 (performance of measurements - checking)
- » HD 60364-4-41 (performance of measurements - shock protection)
- » PN-E 04700 (performance of measurements - commissioning tests)
- » EN 12464 (lighting workplaces)



SONEL MPI-530 / MPI-530-IT

index: WMGBMPI530 / WMGBMPI530IT



Fault loop impedance measurements:

- › impedance measurement with 23 A current (40 A for phase-to-phase voltage), max. resolution 0.001 Ω,
- › fault current-limiting resistor: 10 Ω,
- › range of measurement voltages: 95...440 V, frequencies 45...65 Hz,
- › **fault loop impedance measurement with resolution up to 0.01 Ω in systems protected with RCDs not tripping at $I_{\Delta n} \geq 30$ mA,**
- › automatic calculation of fault current on the basis of nominal or measured voltage; differentiation of phase-to-neutral and phase-to-phase voltage,
- › measurements using UNI-Schuko plug with measurement triggering button (including for swapped L and N leads) or 1.2 m, 5 m, 10 m or 20 m test leads, with optional use of three-phase socket adapters (AGT),
- › selection of installation protections and automatic evaluation of measurement results.

Testing of AC, A, F, B and B+ residual current devices:

- › MPI-530-IT also enables measurements in IT networks,
- › measurement of general, short-time delay and selective RCDs with rated residual currents of 10, 30, 100, 300, 500 and 1000 mA,
- › function of automatic measurement of all RCD parameters (after pressing the "START" button once, the meter performs the entire defined cycle of measurements, including the capability of earth fault loop impedance measurement with 15 mA current),
- › shape of the input leakage current selected by the user: sinusoidal (start from rising or falling edge), unidirectional pulsating (positive or negative), unidirectional pulsating with direct current offset (positive or negative), constant (positive or negative),
- › measurement of tripping current I_A with rising current,
- › measurement of tripping time t_A with currents $0.5 I_{\Delta n}$, $1 I_{\Delta n}$, $2 I_{\Delta n}$ and $5 I_{\Delta n}$,
- › measurement of touch voltage U_B and protective conductor resistance R_E without tripping the RCD,
- › detection of L and N phase swapping in a socket; does not affect measurements,
- › capability of measuring tripping current I_A as well as actual tripping time t_{A1} with just one RCD trip,
- › voltage measurements within the range of 95...270 V.

Insulation resistance measurement:

- › measurement voltages: 50 V, 100 V, 250 V, 500 V, 1000 V,
- › measurement of insulation resistance up to 10 GΩ,
- › capability measurement in-socket by means of UNI-Schuko adapter,
- › sound signaling of five-second time intervals, facilitating capture of time characteristics,
- › meter protected against the presence of voltage on the object and the appearance of voltage during measurement,
- › automatic discharge of the measured object's capacitance after completion of measurement,
- › **automatic measurement of all resistance combinations of 3-, 4- and 5-core cords by means of the optional AutoISO-1000C adapter**

Earth resistance measurements:

- › according to 3- or 4-lead technical method with 2 auxiliary electrodes,
- › according to 3-lead method with additional clamp,
- › **according to double-clamp method,**
- › internal power source with frequency appropriate for 50 Hz or 60 Hz power network.

SONEL MPI MOBILE

A mobile version of the program cooperating with a multifunctional Sone! instrument: MPI-530-IT / MPI-530 meters of electrical system parameters. It can be downloaded from Google Play.

Standard accessories:

WS-03 adapter with START button with UNI-SCHUKO plug	WAADAWS03
NiMH battery 4.8 V 4.2 Ah	WAAKU07
L2 carrying case	WAFUTL2
Crocodile clip, red, 1 kV, 20 A	WAKRORE20K02
Crocodile clip, blue, 1 kV, 20 A	WAKROBU20K02
Crocodile clip, yellow, 1 kV, 20 A	WAKROYE20K02
Test lead 1.2 m, red, 1 kV (banana plugs)	WAPRZ1X2REBB
Test lead 1.2 m, blue, 1 kV (banana plugs)	WAPRZ1X2BUBB
Test lead 1.2 m, yellow, 1 kV (banana plugs)	WAPRZ1X2YEBB
Test lead 15 m, blue (on a reel)	WAPRZ015BUBBSZ
Test lead 30 m, red (banana plugs, on a reel)	WAPRZ030REBBSZ
Cable for battery charging from car cigarette lighter socket (12 V)	WAPRZLAD12SAM
USB cable	WAPRZUSB
Mains cable with IEC C7 plug	WAPRZLAD230
2x earth contact test probe (rod), 30 cm	WASONG30
Pin probe, red 1 kV (banana socket)	WASONREOGB1
Pin probe, blue 1 kV (banana socket)	WASONBUOGB1
Pin probe, yellow 1 kV (banana socket)	WASONYE OGB1
L2 hanging straps (set)	WAPOZSZEKPL
Z7 Power supply	WAZASZ7
Factory calibration certificate	

Soil resistivity measurements according to the Wenner method:

- › measuring range: 0.5 Ωm...9.99 kΩm,
- › distances between electrodes can be set in meters (1...30 m) or feet (1...90 ft).

Low-voltage continuity testing of protective conductors and equipotential bonding:

- › measuring range according to EN 61557-4: 0.12...400 Ω, max. resolution 0.01 Ω,
- › measurement of protective conductor continuity with current ≥ 200 mA in two directions,
- › low-current measurement with sound signaling,
- › voltage on open terminals: 4...9 V,
- › automatic calibration of test leads - leads of any length can be used.

Illuminance measurement:

- › display range: 0.001/0.01/1 lx...399.9 klx,
- › measurement in lux (lx) or foot-candles (fc),
- › measurement by means of external photodetectors (optional).

Additional functions of the meter:

- › Analysis and registration of single-phase network parameters (U, I, cosφ, P, PF, Q, S, Sn),
- › THD of voltage and current harmonics up to the 40th,
- › Quick check of correct connection of PE conductor by means of contact electrode,
- › Check of phase sequence and direction of motor rotation,
- › Power supply from rechargeable battery or batteries (optional), built-in quick charger,
- › Capability of charging from the power grid or 12 V car lighter socket,
- › Tree-structure memory with dynamic management (max. 10,000 entries for each type of measurement),
- › Data transmission to PC via USB or Bluetooth®.

Other technical specifications:

- › type of insulation double, as per EN 61010-1 and EN 61557
- › power supply of the meter Ni-MH rechargeable battery
- › LR14 alkaline batteries (4 pcs.) (optional)
- › operating temperature range 0...+50°C

Measurement of fault loop impedance Z_{L-PE} , Z_{L-N} , Z_{L-L} in 23/40A mode

Measurement with 23/40 A current - measuring range according to EN 61557: 0.130 ...1999 Ω (for 1.2 m lead):

Display range	Resolution	Accuracy
0.00...19.999 Ω	0.001 Ω	$\pm(5\% \text{ m.v.} + 0.03 \Omega)$
20.00...199.99 Ω	0.01 Ω	$\pm(5\% \text{ m.v.} + 0.3 \Omega)$
200.00...1999.9 Ω	0.1 Ω	$\pm(5\% \text{ m.v.} + 3 \Omega)$

- » Nominal voltage: 95...270 V (for Z_{L-PE} and Z_{L-N}) or 95...440 V (for Z_{L-L} - only mode 23/40 A). Frequency: 45...65 Hz.

Measurement of the Z_{L-PE} fault loop impedance in the RCD mode

Measurement with 15 mA current - measuring range acc. to EN 61557: 0.50...1999 Ω

Display range	Resolution	Accuracy
0.00...19.99 Ω	0.01 Ω	$\pm(6\% \text{ m.v.} + 10 \text{ digits})$
20.00...199.9 Ω	0.1 Ω	$\pm(6\% \text{ m.v.} + 5 \text{ digits})$
200...1999 Ω	1 Ω	

- » Rated voltage: 95...270 V; frequency: 45...65 Hz

Earthing resistance measurement with two clamps

Display range	Resolution	Accuracy
0.00...9.99 Ω	0.01 Ω	$\pm(10\% \text{ m.v.} + 4 \text{ digits})$
10.0...19.9 Ω	0.1 Ω	
20.0...99.9 Ω	0.1 Ω	$\pm(20\% \text{ m.v.} + 4 \text{ digits})$

Measurement of insulation resistance

Measuring range according to EN 61557-2:

- » for $U_n = 50 \text{ V}$: 50 k Ω ...250 M Ω
- » for $U_n = 100 \text{ V}$: 100 k Ω ...500 M Ω
- » for $U_n = 250 \text{ V}$: 250 k Ω ...99 M Ω
- » for $U_n = 500 \text{ V}$: 500 k Ω ...2 G Ω
- » for $U_n = 1000 \text{ V}$: 1000 M Ω ...9.99 G Ω

Display range	Resolution	Accuracy
0...1999 k Ω	1 k Ω	$\pm(3\% \text{ m.v.} + 8 \text{ digits})$
2.00...19.99 M Ω	0.01 M Ω	
20.0...199.9 M Ω	1 M Ω	
200...999 M Ω	1 M Ω	$\pm(4\% \text{ m.v.} + 6 \text{ digits})$
1.00...9.99 G Ω	0.01 G Ω	

Indication of phase sequence

- » Indication of phase sequence: compliant, non-compliant, display of phase-to-phase voltages
- » U_{L-L} power system voltage range: 95...500 V (45...65 Hz)

Analysis and recording of single-phase system

- » Measurement of voltage U_{L-N} : 0...500 V, power measurement P, Q, S: 0...1.5 M (W, var, VA).
- » Frequency range of measured voltages: 45...65 Hz.
- » Frequency measurement within range 45.0...65.0 Hz for voltages 50...500 V (Accuracy within a maximum of $\pm 0.1\% \text{ m.v.} + 1 \text{ digit}$).
- » $\cos\phi$ measurement: 0.00...1.00 (resolution 0.01).
- » Measurement of current and voltage harmonics (up to the 40th).
- » THD measurement relative to first harmonic (for U and I).
- » AC current measurement (True RMS) with clamp:

Clamp	Display range	Resolution	Accuracy
C-3, C-6	0.0...99.9 mA	0.1 mA	$\pm(5\% \text{ m.v.} + 3 \text{ digits})$
	100...999 mA	1 mA	
	1.00...9.99 A	0.01 A	$\pm(5\% \text{ m.v.} + 5 \text{ digits})$
C-3, C-6, F-2, F-3	10.0...99.9 A	0.1 A	(C-3, C-6)
	100...999 A	1 A	$\pm(0,1\% \text{ In} + 2 \text{ digits})$
F-1, F-2, F-3	1.00...3.00 kA	0.01 kA	(F-1, F-2, F-3)

Illuminance measurement*

Display range [lx]	Resolution [lx]	Spectral uncertainty	Accuracy
0...3.999	0.001	$f_1 < 2\%$	$\pm(2\% + 5 \text{ digits})$
4.00...39.99	0.01		
40.0...399.9	0.1		
400...3999	1		
4.00 k...39.99 k	0.01 k		
40.0 k...399.9 k	0.1 k		

*) for LP-10A measuring probe.



MPI-530 / MPI-530-IT meters enable accurate measurement of fault loop impedance, including in L-PE loops in networks equipped with RCDs, as well as measurements in sockets with swapped L and N conductors.

Measurements of RCD parameters (working voltage range 95...270 V):

RCD trip test and measurement of tripping time t_A (for t_A measurement function)

RCD type	Factor	Range (general and short-time delay)	Range (selective)	Resolution	Accuracy
General, short-time delay and selective	0.5 $I_{\Delta n}$	0...300 ms	0...500 ms	1 ms	$\pm(2\% \text{ m.v.} + 2 \text{ digits})$ (for RCD of $I_{\Delta n} = 10 \text{ mA}$ and the measurement with 0.5 $I_{\Delta n}$ error: $\pm(2\% \text{ m.v.} + 3 \text{ digits})$)
	1 $I_{\Delta n}$				
	2 $I_{\Delta n}$	0...150 ms	0...200 ms		
	5 $I_{\Delta n}$	0...40 ms	0...150 ms		

- » Residual current input accuracy: for 0.5 $I_{\Delta n}$ 8...0%, for 1 $I_{\Delta n}$, 2 $I_{\Delta n}$, 5 $I_{\Delta n}$ 0...8%

Measurement of RCD trip current I_A for sinusoidal residual current (AC type)

Nominal current	Measuring range	Resolution	Measurement current	Accuracy
10 mA	3.3...10.0 mA	0.1 mA	0.3 $I_{\Delta n}$...1.0 $I_{\Delta n}$	$\pm 5\% I_{\Delta n}$
30 mA	9.0...30.0 mA			
100 mA	33...100 mA			
300 mA	90...300 mA	1 mA		
500 mA	150...500 mA			
1000 mA	330...1000 mA			

- » Measurement can be started from the positive or negative half-period of the input leakage current (AC)

Measurement of RCD trip current I_A for uni-directional residual current and uni-directional current with 6mA direct current offset (type A)

Nominal current	Measuring range	Resolution	Measurement current	Accuracy
10 mA	3.5...20.0 mA	0.1 mA	0.35 $I_{\Delta n}$...2.0 $I_{\Delta n}$	$\pm 10\% I_{\Delta n}$
30 mA	10.5...42.0 mA			
100 mA	35...140 mA	1 mA	0.35 $I_{\Delta n}$...1.4 $I_{\Delta n}$	
300 mA	105...420 mA			
500 mA	175...700 mA			

- » Measurement can be started from a positive or negative half-period of the input leakage current



MPI-530 / MPI-530-IT meters enable automatic insulation resistance measurement of 3-, 4- and 5-core cords with optional AutoISO-1000C adapter.

Measurement of RCD trip current I_A for residual direct current (type B)

Nominal current	Measuring range	Resolution	Measurement current	Accuracy
10 mA	2.0...20.0 mA	0.1 mA	0.2 $I_{\Delta n}$...2.0 $I_{\Delta n}$	$\pm 10\% I_{\Delta n}$
30 mA	6...60 mA	1 mA		
100 mA	20...200 mA			
300 mA	60...600 mA			
500 mA	100...1000 mA			

- » Measurement is possible for positive or negative input leakage current
- » $I_{\Delta n}$ - nominal value of residual current

Measurement of RE earth resistance using 3-lead, 4-lead, or 3-lead + clamp technical method

Measuring range according to EN 61557-5: 0.50 Ω ...1.99 k Ω for $U = 50 \text{ V}$ (3-lead, 4-lead):

Display range	Resolution	Accuracy 3-lead, 4-lead	Accuracy 3-lead with clamp
0.00...9.99 Ω	0.01 Ω	$\pm(2\% \text{ m.v.} + 4 \text{ digits})$	$\pm(8\% \text{ m.v.} + 4 \text{ digits})$
10.0...99.9 Ω	0.1 Ω		
100...999 Ω	1 Ω		
1.00...1.99 k Ω	0.01 k Ω	$\pm(2\% \text{ m.v.} + 3 \text{ digits})$	

"m.v." = "measured value"



MPI-530 / MPI-530-IT meters enable measurement of the actual tripping time and trip current of an RCD with just one trip.

The instrument meets the requirements set forth in the standards:

- » EN 61010-1 (general and particular requirements related to safety)
- » EN 61010-031 (general and particular requirements related to safety)
- » EN 61326 (electromagnetic compatibility)
- » EN 61557 (requirements for measurement instruments)
- » HD 60364-6 (performance of measurements - checking)
- » HD 60364-4-41 (performance of measurements - shock protection)
- » PN-E 04700 (performance of measurements - commissioning tests)
- » EN 12464 (lighting workplaces)

Multi-function meter of electrical system parameters

SONEL MPI-525

index: WMGBMPI525



CAT III **CAT IV** **IP54**
600 V **300 V**

2.5 kV
 maximum R_{iso} measuring voltage

Fault loop impedance measurements:

- › impedance measurement with 23 A current (40 A for phase-to-phase voltage),
- › fault current-limiting resistor: 10 Ω ,
- › range of measurement voltages: 95...440 V, frequencies 45...65 Hz,
- › **fault loop impedance measurement with resolution up to 0.01 Ω in systems protected with RCDs not tripping at $I_{\Delta n} \geq 30$ mA,**
- › **automatic fault current calculation; differentiation of phase and phase-to-phase voltage,**
- › measurements using UNI-Schuko plug with measurement triggering button (including for swapped L and N leads) or 1.2 m, 5 m, 10 m, 20 m test leads, with optional use of three-phase socket adapters (AGT).

Testing of AC, A, F, B and B+ residual current devices:

- › measurement of general, short-time delay and selective RCDs with rated residual currents of 10, 30, 100, 300, 500 and 1000 mA,
- › **function of automatic measurement of all RCD parameters (after pressing the "START" button once, the meter performs the entire defined cycle of measurements, including the capability of earth fault loop impedance measurement with 15 mA current),**
- › shape of the input leakage current selected by the user: sinusoidal (start from rising or falling edge), unidirectional pulsating (positive or negative), unidirectional pulsating with direct current offset (positive or negative), constant (positive or negative),
- › measurement of tripping current I_{Δ} with rising current,
- › measurement of tripping time t_{Δ} for currents: $0.5I_{\Delta n}$, $1I_{\Delta n}$, $2I_{\Delta n}$ and $5I_{\Delta n}$,
- › measurement of touch voltage U_B and protective conductor resistance R_E without tripping the RCD,
- › detection of L and N phase swapping in a socket; does not affect measurements,
- › capability of measuring tripping current I_{Δ} as well as actual tripping time t_{Δ} with just one RCD trip,
- › voltage measurements within the range of 95...270 V.

Insulation resistance measurement:

- › measurement voltages: 50 V, 100 V, 250 V, 500 V, 1000 V and 2500 V,
- › measurement of insulation resistance up to 10 G Ω ,
- › sound signaling of five-second time intervals, facilitating capture of time characteristics,
- › measurement of 2 absorption coefficients (DAR, PI or Ab1, Ab2)
- › timing of T_1 , T_2 , T_3 within the range of 1...600 s,
- › meter protected against the presence of voltage on the object and the appearance of voltage during measurement,
- › automatic discharge of the measured object's capacitance after completion of measurement,
- › **automatic measurement of all resistance combinations of 3-, 4- and 5-core cords and power cords by means of the optional AutoISO-2500 adapter.**

Earth resistance measurements:

- › measurement according to 3- or 4-lead technical method with 2 auxiliary electrodes,
- › internal power source with frequency appropriate for 50 Hz or 60 Hz power network (selected in the meter).

Standard accessories:

WS-03 adapter with START button with UNI-SCHUKO plug	WAADAWS03
NiMH battery 4.8 V 4.2 Ah	WAAKU07
L2 carrying case	WAFUTL2
Crocodile clip, black, 11 kV, 32 A	WAKROBL32K09
Crocodile clip, yellow, 1 kV, 20 A	WAKROYE20K02
Crocodile clip, black, 1 kV, 20 A	WAKROBL20K01
Test lead 1.2 m, red, 1 kV (banana plugs)	WAPRZ1X2REBB
Test lead 1.2 m, blue, 1 kV (banana plugs)	WAPRZ1X2BUBB
Test lead 1.2 m, yellow, 1 kV (banana plugs)	WAPRZ1X2YEBB
Test lead 1.8 m, black, 5 kV (banana plugs, shielded)	WAPRZ1X8BLBB
Test lead 1.8 m, red, 5 kV (banana plugs)	WAPRZ1X8REBB
Test lead 15 m, blue (on a reel)	WAPRZ015BUBBSZ
Test lead 30 m, red (banana plugs, on a reel)	WAPRZ030REBBSZ
USB cable	WAPRZUSB
Mains cable with IEC C7 plug	WAPRZLAD230
2x earth contact test probe (rod), 30 cm	WASONG30
Pin probe, red 1 kV (banana socket)	WASONREOGB1
Pin probe, red 5 kV (banana socket)	WASONREOGB2
Pin probe, blue 1 kV (banana socket)	WASONBUOGB1
Pin probe, yellow 1 kV (banana socket)	WASONYEOGB1
L2 hanging straps (set)	WAPOZSZEKPL
Z7 Power supply	WAZASZ7
Factory calibration certificate	



The MPI-525 meter is one of the few multi-function meters capable of measuring insulation resistance with 2500 V voltage.

Low-voltage resistance measurement of protective conductors and equipotential bonding:

- › measurement of protective conductor continuity with current ≥ 200 mA in two directions (according to standard EN 61557-4),
- › low-current measurement with sound and light signaling,
- › automatic calibration of test leads - leads of any length can be used.

Additional functions of the meter:

- › Quick check of correct connection of PE conductor by means of contact electrode,
- › Check of phase sequence,
- › Memory storing up to 990 records (57,500 individual results), data transmission to PC via USB,
- › Power supply from rechargeable battery or battery (optional), built-in quick charger,
- › Real-time clock (RTC) - time of measurement saved to memory.



MPI-525 enables measurements in sockets with swapped L and N conductors.

Other technical specifications:

- › type of insulation double, as per EN 61010-1 and EN 61557
- › power supply of the meter Ni-MH battery or LR14 alkaline batteries (4 pcs. - optional)
- › operating temperature range 0...+50°C

Measurement of fault loop impedance Z_{L-PE} , Z_{L-N} , Z_{L-L}

Measurement with 23 / 40 A current - measuring range according to EN 61557-3: 0.13...1999 Ω (for 1.2 m test lead):

Display range	Resolution	Accuracy
0.00...19.99 Ω	0.01 Ω	$\pm(5\% \text{ m.v.} + 3 \text{ digits})$
20.0...199.9 Ω	0.1 Ω	
200...1999 Ω	1 Ω	

- » Nominal voltage: 95...270V (for Z_{L-PE} and Z_{L-N}) or 95...440 V (for Z_{L-L})
- » Frequency: 45...65Hz

Measurement of the Z_{L-PE} fault loop impedance in the RCD mode

Measurement with 15 mA current, measuring range according to EN 61557-3: 0.50...1999 Ω

Display range	Resolution	Accuracy
0.00...19.99 Ω	0.01 Ω	$\pm(6\% \text{ m.v.} + 10 \text{ digits})$
20.0...199.9 Ω	0.1 Ω	$\pm(6\% \text{ m.v.} + 5 \text{ digits})$
200...1999 Ω	1 Ω	

- » Rated voltage: 95...270 V
- » Frequency: 45...65 Hz

Earth resistance R_E measurement

Measuring range according to EN 61557-5:
 0.50 Ω ...1.99 k Ω for 50 V measurement voltage
 0.56 Ω ...1.99 k Ω for 25 V measurement voltage

Display range	Resolution	Accuracy
0.00...9.99 Ω	0.01 Ω	$\pm(2\% \text{ m.v.} + 4 \text{ digits})$
10.0...99.9 Ω	0.1 Ω	$\pm(2\% \text{ m.v.} + 3 \text{ digits})$
100...999 Ω	1 Ω	
1.00...1.99 k Ω	0.01 k Ω	

Measurement of insulation resistance

Measuring range according to EN 61557-2:
 for $U_n = 50 \text{ V}$: 50 k Ω ...250 M Ω for $U_n = 500 \text{ V}$: 500 k Ω ...2.00 G Ω
 for $U_n = 100 \text{ V}$: 100 k Ω ...500 M Ω for $U_n = 1000 \text{ V}$: 1000 k Ω ...3.00 G Ω
 for $U_n = 250 \text{ V}$: 250 k Ω ...999 M Ω for $U_n = 2500 \text{ V}$: 2.50 M Ω ...9.99 G Ω

Display range *)	Resolution	Accuracy
0...1999 k Ω	1 k Ω	$\pm(3\% \text{ m.v.} + 8 \text{ digits})$
2.00...19.99 M Ω	0.01 k Ω	
20.0...199.9 M Ω	0.1 k Ω	
200...999 M Ω	1 k Ω	
1.00...9.99 G Ω	0.01 G Ω	$\pm(4\% \text{ m.v.} + 6 \text{ digits})$

**) no greater than the measuring range for a given voltage.



The MPI-525 meter enables automatic insulation resistance measurement of cables and 3-, 4- and 5-core cords by means of the optional AutoISO-2500 adapter.

Indication of phase sequence

- » Indication of phase sequence: compliant, non-compliant
- » U_{L-L} power system voltage range: 95...500 V (45...65 Hz)
- » Display of phase-to-phase voltage values

Low-voltage measurement of circuit continuity and resistance

Testing of protective conductor continuity with $\pm 200 \text{ mA}$ current measuring range according to EN 61557-4: 0.12...400 Ω

Display range	Resolution	Accuracy
0.00...19.99 Ω	0.01 Ω	$\pm(2\% \text{ m.v.} + 3 \text{ digits})$
20.0...199.9 Ω	0.1 Ω	
200...400 Ω	1 Ω	

- » voltage on open terminals: 4...9 V
- » Output current at $R < 2 \Omega$: min. 200 mA
- » Automatic calibration of test leads
- » Measurements for both current polarities



The MPI-525 meter is one of the few meters capable of accurately measuring fault loop impedance, including in L-PE loops, in networks equipped with residual current devices (measurement with 15 mA current).

Measurements of RCD parameters (working voltage range 95...270 V):

RCD trip test and measurement of tripping time t_A (for t_A measurement function)

RCD type	Factor	Range	Resolution	Accuracy
General and short-time delay	0.5 $I_{\Delta n}$	0...300 ms	1 ms	$\pm(2\% \text{ m.v.} + 2 \text{ digits})$ (for RCD of $I_{\Delta n} = 10 \text{ mA}$ and the measurement 0.5 $I_{\Delta n}$ error: $\pm(2\% \text{ m.v.} + 3 \text{ digits})$)
	1 $I_{\Delta n}$			
	2 $I_{\Delta n}$			
Selective	5 $I_{\Delta n}$	0...150 ms		
	0.5 $I_{\Delta n}$	0...400 ms		
	1 $I_{\Delta n}$	0...500 ms		
	2 $I_{\Delta n}$	0...200 ms		
	5 $I_{\Delta n}$	0...150 ms		

- » Residual current input accuracy: for 0.5 $I_{\Delta n}$ 8...0%
for 1 $I_{\Delta n}$, 2 $I_{\Delta n}$, 5 $I_{\Delta n}$ 0...8%

Measurement of RCD trip current I_A for sinusoidal residual current (AC type)

Nominal current	Measuring range	Resolution	Measurement current	Accuracy
10 mA	3.3...10.0 mA	0.1 mA	0.3 $I_{\Delta n}$...1.0 $I_{\Delta n}$	$\pm 5\% I_{\Delta n}$
30 mA	9.0...30.0 mA			
100 mA	30...100 mA	1 mA		
300 mA	90...300 mA			
500 mA	150...500 mA			
1000 mA	300...1000 mA			

- » Measurement can be started from the positive or negative half-period of the input leakage current (AC)

Measurement of RCD trip current I_A for uni-directional residual current and uni-directional current with 6 mA direct current offset (type A, F)

Nominal current	Measuring range	Resolution	Measurement current	Accuracy
10 mA	3.5...20.0 mA	0.1 mA	0.35 $I_{\Delta n}$...2.0 $I_{\Delta n}$	$\pm 10\% I_{\Delta n}$
30 mA	10.5...42.0 mA			
100 mA	35...140 mA	1 mA		
300 mA	105...420 mA			
500 mA	175...700 mA			

- » Measurement can be started from a positive or negative half-period of the input leakage current

Measurement of RCD trip current I_A for residual direct current (type B, B+)

Nominal current	Measuring range	Resolution	Measurement current	Accuracy
10 mA	2.0...20.0 mA	0.1 mA	0.2 $I_{\Delta n}$...2.0 $I_{\Delta n}$	$\pm 10\% I_{\Delta n}$
30 mA	6...60 mA	1 mA		
100 mA	20...200 mA			
300 mA	60...600 mA			
500 mA	100...1000 mA			

- » Measurement is possible for both a positive or negative input leakage current
- » $I_{\Delta n}$ - nominal value of residual current

"m.v." = "measured value"



The MPI-525 meter enables measurement of the actual tripping time and trip current of an RCD with just one trip.

The instrument meets the requirements set forth in the standards:

- » EN 61010-1 (general and particular requirements related to safety)
- » EN 61010-031 (general and particular requirements related to safety)
- » EN 61326 (electromagnetic compatibility)
- » EN 61557 (requirements for measurement instruments)
- » HD 60364-6 (performance of measurements - checking)
- » HD 60364-4-41 (performance of measurements - shock protection)
- » PN-E 04700 (performance of measurements - commissioning tests)

SONEL MPI-520



CAT III **CAT IV** **IP54**
600 V **300 V**

Fault loop impedance measurements:

- » impedance measurement with 23 A current (40 A for phase-to-phase voltage),
- » fault current-limiting resistor: 10 Ω,
- » range of measurement voltages: 95...440 V, frequencies 45...65 Hz,
- » **fault loop impedance measurement with resolution up to 0.01 Ω in systems protected with RCDs not tripping at $I_{\Delta n} \geq 30$ mA,**
- » automatic fault current calculation; differentiation of phase and phase-to-phase voltage,
- » measurements using UNI-Schuko plug with measurement triggering button (including for swapped L and N leads) or 1.2 m, 5 m, 10 m, 20 m test leads, with optional use of three-phase socket adapters (AGT).

Testing of AC, A, F, B and B+ residual current devices:

- » measurement of general, short-time delay and selective RCDs with rated residual currents of 10, 30, 100, 300, 500 and 1000 mA,
- » function of automatic measurement of all RCD parameters (after pressing the "START" button once, the meter performs the entire defined cycle of measurements, including the capability of earth fault loop impedance measurement with 15 mA current),
- » shape of the input leakage current selected by the user: sinusoidal (start from rising or falling edge), unidirectional pulsating (positive or negative), unidirectional pulsating with direct current offset (positive or negative), constant (positive or negative),
- » measurement of tripping current I_{Δ} with rising current,
- » measurement of tripping time t_{Δ} for currents: $0.5 I_{\Delta n}$, $1 I_{\Delta n}$, $2 I_{\Delta n}$ and $5 I_{\Delta n}$,
- » measurement of touch voltage U_B and protective conductor resistance R_E without tripping the RCD,
- » detection of L and N phase swapping in a socket; does not affect measurements,
- » capability of measuring tripping current I_{Δ} as well as actual tripping time t_{Δ} with just one RCD trip,
- » voltage measurements within the range of 95...270 V.

Insulation resistance measurement:

- » measurement voltages: 50 V, 100 V, 250 V, 500 V, 1000 V,
- » measurement of insulation resistance up to 3 GΩ,
- » capability of in-socket measurement by means of UNI-Schuko adapter,
- » sound signaling of five-second time intervals, facilitating capture of time characteristics,
- » meter protected against the presence of voltage on the object and the appearance of voltage during measurement,
- » automatic discharge of the measured object's capacitance after completion of measurement,
- » automatic measurement of all resistance combinations of 3-, 4- and 5-core cords by means of the optional AutoISO-1000C adapter.

Earth resistance measurements:

- » measurement according to 3-lead technical method with 2 auxiliary electrodes,
- » internal power source with frequency appropriate for 50 Hz or 60 Hz power network (selected in the meter).

Choose the best set for your needs

MPI-520

Multi-function meter of electrical system parameters
 index: WMGBMPI520

MPI-520 Start

Multi-function meter of electrical system parameters
without accessories for earth resistance measurement
 index: WMGBMPI520S

Standard accessories:

WS-03 adapter for triggering measurement (UNI-Schuko plug)	WAADAWS03
L-2 carrying case (only MPI-520)	WAFUTL2
L-4 carrying case (only MPI-520 Start)	WAFUTL4
Red "crocodile" clip 1 kV 20 A	WAKRORE20K02
Yellow "crocodile" clip 1 kV 20 A	WAKROYE20K02
Battery container	WAPOJ1
Test lead with banana plugs; 1 kV; 1.2 m; red	WAPRZ1X2REBB
Test lead with banana plugs; 1 kV; 1.2 m; blue	WAPRZ1X2BUBB
Test lead with banana plugs; 1 kV; 1.2 m; yellow	WAPRZ1X2YEBB
Earthing measurement test lead with banana plugs on reel; 15 m; blue (only MPI-520)	WAPRZ015BUBBSZ
Earthing measurement test lead with banana plugs on reel; 30 m; red (only MPI-520)	WAPRZ030REBBSZ
USB data transmission cable	WAPRZUSB
2x earth contact test probe (30 cm) (only MPI-520)	WASONG30
Test probe with banana socket; 1 kV; red	WASONREOGB1
Test probe with banana socket; 1 kV; blue	WASONBUOGB1
Test probe with banana socket; 1 kV; yellow	WASONYE OGB1
Meter strap (type L-2)	WAPOZSZEKPL
Factory calibration certificate	



The MPI-520 and MPI-520 Start meters enable automatic insulation resistance measurement of 3-, 4- and 5-core cords with optional AutoISO-1000C adapter.

Low-voltage resistance measurement of protective conductors and equipotential bonding:

- » measurement of protective conductor continuity with current ≥ 200 mA in two directions (according to standard EN 61557-4),
- » low-current measurement with sound signaling,
- » automatic calibration of test leads - leads of any length can be used.

Additional functions of the meters:

- » measurement of voltage, frequency and - additionally with a clamp - alternating current, $\cos\phi$ and power (active, reactive, apparent).
- » quick check of correct connection of PE conductor by means of contact electrode.
- » check of phase sequence.
- » memory storing up to 990 records (57,500 individual results), data transmission to PC via USB,
- » power supply from batteries or rechargeable batteries (optional), built-in quick charger.

Other technical specifications:

- » type of insulation double, as per EN 61010-1 and EN 61557
- » power supply of the meter alkaline batteries (4 pcs.) or Ni-MH rechargeable battery (optional)
- » operating temperature range 0...+50°C



MPI-520 and MPI-520 Start enable measurements in sockets with swapped L and N conductors.

Measurement of fault loop impedance Z_{L-PE} , Z_{L-N} , Z_{L-L}

Measurement with 23/40 A current - measuring range according to EN 61557-3: 0.13...1999 Ω (for 1.2 m test lead):

Display range	Resolution	Accuracy
0.00...19.99 Ω	0.01 Ω	$\pm(5\% \text{ m.v.} + 3 \text{ digits})$
20.0...199.9 Ω	0.1 Ω	
200...1999 Ω	1 Ω	

- » Nominal voltage: 95...270 V (for Z_{L-PE} and Z_{L-N}) or 95...440 V (for Z_{L-L})
- » Frequency: 45...65 Hz

Measurement of the Z_{L-PE} fault loop impedance in the RCD mode

Measurement with 15 mA current, measuring range according to EN 61557-3: 0.50...1999 Ω

Display range	Resolution	Accuracy
0.00...19.99 Ω	0.01 Ω	$\pm(6\% \text{ m.v.} + 10 \text{ digits})$
20.0...199.9 Ω	0.1 Ω	$\pm(6\% \text{ m.v.} + 5 \text{ digits})$
200...1999 Ω	1 Ω	

- » Rated voltage: 95...270 V
- » Frequency: 45...65 Hz

Earth resistance R_E measurement

Measuring range according to EN 61557-5:
0.50 Ω ...1.99 k Ω for 50 V measurement voltage
0.56 Ω ...1.99 k Ω for 25 V measurement voltage

Display range	Resolution	Accuracy
0.00...9.99 Ω	0.01 Ω	$\pm(2\% \text{ m.v.} + 4 \text{ digits})$
10.0...99.9 Ω	0.1 Ω	$\pm(2\% \text{ m.v.} + 3 \text{ digits})$
100...999 Ω	1 Ω	
1.00...1.99 k Ω	0.01 k Ω	

Measurement of insulation resistance

Measuring range according to EN 61557-2:
 for $U_n = 50 \text{ V}$: **50 k Ω ...250 M Ω** for $U_n = 500 \text{ V}$: **500 k Ω ...2.00 G Ω**
 for $U_n = 100 \text{ V}$: **100 k Ω ...500 M Ω** for $U_n = 1000 \text{ V}$: **1000 k Ω ...3.00 G Ω**
 for $U_n = 250 \text{ V}$: **250 k Ω ...999 k Ω**

Display range *	Resolution	Accuracy
0...1999 k Ω	1 k Ω	$\pm(3\% \text{ m.v.} + 8 \text{ digits})$
2.00...19.99 M Ω	0.01 M Ω	
20.0...199.9 M Ω	0.1 M Ω	
200...999 M Ω	1 M Ω	$\pm(4\% \text{ m.v.} + 6 \text{ digits})$
1.00...3.00 G Ω	0.01 G Ω	

- ** no greater than the measuring range for a given voltage.
 ** an additional error of $\pm 2\%$ is present in measurements when the UNI-Schuko plug is used.

Low-voltage measurement of circuit continuity and resistance

Testing of protective conductor continuity with $\pm 200 \text{ mA}$ current measuring range according to EN 61557-4: **0.12...400 Ω**

Display range	Resolution	Accuracy
0.00...19.99 Ω	0.01 Ω	$\pm(2\% \text{ m.v.} + 3 \text{ digits})$
20.0...199.9 Ω	0.1 Ω	
200...400 Ω	1 Ω	

- » Voltage on open terminals: 4...9 V
- » Output current at $R < 2 \Omega$: min. 200 mA
- » Automatic calibration of test leads
- » Measurements for both current polarities

Indication of phase sequence

- » Indication of phase sequence: compliant, non-compliant
- » U_{L-L} power system voltage range: 95...500 V (45...65 Hz)
- » Display of phase-to-phase voltage values

Measurement of alternating voltage and current, $\cos\phi$ and power

- » Power measurement P, Q, S: 0...200k (W, var, VA).
- » Measurement of alternating current (True RMS) using clamp (0...400 A), max. resolution 0.1 mA
- » Measurement of voltage U_{L-N} : 0...500 V
- » Frequency range of measured voltages: 45.0...65.0 Hz
- » Frequency measurement for voltages 50...500 V within the range of 45.0...65.0 Hz (Accuracy to a maximum of $\pm 0.1\% \text{ m.v.} + 1 \text{ digit}$)
- » $\cos\phi$ measurement: 0.00...1.00 (resolution 0.01)



The MPI-520 and MPI-520 Start meters are two of the few meters capable of accurately measuring fault loop impedance, including in L-PE loops, in networks equipped with residual current devices (measurement with 15 mA current).

Measurements of RCD parameters (working voltage range 95...270 V):

RCD trip test and measurement of tripping time t_A (for t_A measurement function)

RCD type	Factor	Range	Resolution	Accuracy
General and short-time delay	0.5 $I_{\Delta n}$	0...300 ms	1 ms	$\pm(2\% \text{ m.v.} + 2 \text{ digits})$ (for RCD of $I_{\Delta n} = 10 \text{ mA}$ and the measurement 0.5 $I_{\Delta n}$ error: $\pm(2\% \text{ m.v.} + 3 \text{ digits})$)
	1 $I_{\Delta n}$			
	2 $I_{\Delta n}$			
Selective	0.5 $I_{\Delta n}$	0...500 ms		
	1 $I_{\Delta n}$			
	2 $I_{\Delta n}$			
	5 $I_{\Delta n}$	0...200 ms		
	5 $I_{\Delta n}$	0...150 ms		

- » Residual current input accuracy: for 0.5 $I_{\Delta n}$ 8...0%
for 1 $I_{\Delta n}$, 2 $I_{\Delta n}$, 5 $I_{\Delta n}$ 0...8%

Measurement of RCD trip current I_A for sinusoidal residual current (AC type)

Nominal current	Measuring range	Resolution	Measurement current	Accuracy
10 mA	3.3...10.0 mA	0.1 mA	0.3 $I_{\Delta n}$...1.0 $I_{\Delta n}$	$\pm 5\% I_{\Delta n}$
30 mA	9.0...30.0 mA			
100 mA	30...100 mA			
300 mA	90...300 mA	1 mA		
500 mA	150...500 mA			
1000 mA	300...1000 mA			

- » Measurement can be started from the positive or negative half-period of the input leakage current (AC)

Measurement of RCD trip current I_A for uni-directional residual current and uni-directional current with 6 mA direct current offset (type A, F)

Nominal current	Measuring range	Resolution	Measurement current	Accuracy
10 mA	3.5...20.0 mA	0.1 mA	0.35 $I_{\Delta n}$...2.0 $I_{\Delta n}$	$\pm 10\% I_{\Delta n}$
30 mA	10.5...42.0 mA			
100 mA	35...140 mA			
300 mA	105...420 mA	1 mA		
500 mA	175...700 mA			

- » Measurement can be started from a positive or negative half-period of the input leakage current

Measurement of RCD trip current I_A for residual direct current (type B, B+)

Nominal current	Measuring range	Resolution	Measurement current	Accuracy
10 mA	2.0...20.0 mA	0.1 mA	0.2 $I_{\Delta n}$...2.0 $I_{\Delta n}$	$\pm 10\% I_{\Delta n}$
30 mA	6...60 mA			
100 mA	20...200 mA			
300 mA	60...600 mA	1 mA		
500 mA	100...1000 mA			

- » Measurement is possible for both a positive or negative input leakage current
- » $I_{\Delta n}$ - nominal value of residual current



The MPI-520 and MPI-520 Start meters enable measurement of the actual tripping time and trip current of an RCD with just one trip.

"m.v." = "measured value"

The instrument meets the requirements set forth in the standards:

- » EN 61010-1 (general and particular requirements related to safety)
- » EN 61010-031 (general and particular requirements related to safety)
- » EN 61326 (electromagnetic compatibility)
- » EN 61557 (requirements for measurement instruments)
- » HD 60364-6 (performance of measurements - checking)
- » HD 60364-4-41 (performance of measurements - shock protection)
- » PN-E 04700 (performance of measurements - commissioning tests)

Multi-function meter of electrical system parameters

SONEL MPI-507 / MPI-506 / MPI-502F

index: WMGBMPI507 / WMGBMPI506 / WMGBMPI502F



CAT III

600 V

CAT IV

300 V

IP67

BLUETOOTH

Measurement of short circuit loop parameters:

- » measurement of short circuit loop impedance in networks with rated voltage: 220/380 V, 230 V/400 V, 240/415 V and frequency 45...65 Hz, operating voltage range: 180...460 V
- » indication of short circuit loop resistance R and short circuit loop reactance X
- » **measurements of short circuit loop impedance with 15 mA current, without tripping the RCD circuit breaker**
- » maximum test current: 7.6 A (at 230 V), 13.3 A (at 400 V).

Testing RCD breakers of AC, A types:

- » testing of prompt, short-delay and selective RCDs with rated current values: 10 mA, 15 mA, 30 mA, 100 mA, 300 mA, 500 mA,
- » measurement of I_A trip current and tripping time t_A for currents $0.5 I_{\Delta n}$, $1 I_{\Delta n}$, $2 I_{\Delta n}$, $5 I_{\Delta n}$
- » R_E and U_B measurement without RCD tripping,
- » extended AUTO function of RCD measurement, with the possibility of measuring Z_{L-PE} with low current,
- » measurement of I_A and t_A during one RCD tripping.

MPI-506 • MPI-507 | Insulation resistance measurement:

- » test voltage 100 V, 250 V, 500 V.

MPI-507 | Earth resistance measurements:

- » measurement according to 3-lead technical method with 2 auxiliary electrodes,
- » internal power source with frequency appropriate for 50 Hz or 60 Hz power network (selected in the meter).

Measurement of resistance of earth connection and equipotential bondings:

- » measurement of protective connections continuity with a ± 200 mA current in accordance with EN 61557-4,
- » autocalibration of test leads - any leads can be used,
- » low current resistance measurement with sound signaling.

MPI-506 • MPI-507 | Phase sequence indication:

- » phase sequence indication: compliant, not compliant,
- » network voltage range: 100...440 V,
- » displaying the values of phase-to-phase voltages.

Additional functions of the meter:

- » Detection of L and N phase swapping in a socket and automatic unswapping.
- » Check of correct connection of PE conductor by means of contact electrode.
- » Measurement of network voltage (0...500 V) and frequency.
- » Power supply from LR6 batteries, NiMH rechargeable batteries can optionally be applied.
- » Memory storing up to 990 results, wireless data transmission to computer.
- » Backlit keyboard.

Standard accessories:

WS-03 adapter with START button with UNI-Schuko plug	WAADAWS03
M-6 carrying case	WAFUTM6
Red "crocodile" clip 1 kV 20 A (only MPI-506, MPI-507)	WAKRORE20K02
Yellow "crocodile" clip 1 kV 20 A	WAKROYE20K02
Test lead with banana plugs; 1 kV; 1.2 m; red	WAPRZ1X2REBB
Test lead with banana plugs; 1 kV; 1.2 m; blue	WAPRZ1X2BUBB
Test lead with banana plugs; 1 kV; 1.2 m; yellow	WAPRZ1X2YEBB
Test lead 30 m, red (banana plugs, on H-frame reel) (only MPI-507)	WAPRZ030REBBN
Test lead 15 m, blue (banana plugs, on H-frame reel) (only MPI-507)	WAPRZ015BUBBN
Test probe with banana socket; 1 kV; red	WASONREOGB1
Test probe with banana socket; 1 kV; blue	WASONBUOGB1
Test probe with banana socket; 1 kV; yellow (only MPI-506, MPI-507)	WASONYEOGB1
2x earth contact test probe (rod), 25 cm (only MPI-507)	WASONG25
Meter strap (type M-1)	WAPOZSZE4
M-1 housing holder - hanger	WAPOZUCH1
4x LR6 1,5 V battery	
Factory calibration certificate	



The instrument meets the requirements set forth in the standards:

- » EN 61010-1 (general and particular requirements related to safety)
- » EN 61010-031 (general and particular requirements related to safety)
- » EN 61326 (electromagnetic compatibility)
- » EN 61557 (requirements for measurement instruments)
- » HD 60364-6 (performance of measurements - checking)
- » HD 60364-4-41 (performance of measurements - shock protection)
- » PN-E 04700 (performance of measurements - commissioning tests)

Measurement of fault loop impedance Z_{L-PE} , Z_{L-N} , Z_{L-L}

Measurement with 7.6/13.3 A current - measuring range according to EN 61557-3: 0.13...1999 Ω :

Display range	Resolution	Accuracy
0.00...19.99 Ω	0.01 Ω	$\pm(5\% \text{ m.v.} + 3 \text{ digits})$
20.0...199.9 Ω	0.1 Ω	
200...1999 Ω	1 Ω	

Measurement of earth fault loop impedance Z_{L-PE} in RCD mode

Measurement with 15 mA current, measuring range according to EN 61557-3: 0.50...1999 Ω

Display range	Resolution	Accuracy
0.00...19.99 Ω	0.01 Ω	$\pm(6\% \text{ m.v.} + 10 \text{ digits})$
20.0...199.9 Ω	0.1 Ω	$\pm(6\% \text{ m.v.} + 5 \text{ digits})$
200...1999 Ω	1 Ω	

MPI-507 | Earth resistance R_E measurement

Measuring range according to EN 61557-5:
0.63 Ω ...1999 Ω for 50 V measurement voltage

Display range	Resolution	Accuracy
0.00...19.99 Ω	0.01 Ω	$\pm(3\% \text{ m.v.} + 5 \text{ digits})$
20.0...199.9 Ω	0.1 Ω	$\pm 5\% \text{ m.v.}$
200...1999 Ω	1 Ω	

MPI-506 • MPI-507 | Insulation resistance measurement

Test range according to IEC 61557-2:

$U_{ISO} = 100 \text{ V: } 100 \text{ k}\Omega \dots 99.9 \text{ M}\Omega$ $U_{ISO} = 250 \text{ V: } 250 \text{ k}\Omega \dots 199.9 \text{ M}\Omega$

$U_{ISO} = 500 \text{ V: } 500 \text{ k}\Omega \dots 599.9 \text{ M}\Omega$

Measurements of RCD parameters (operating voltage range 180...270 V):

RCD trip test and measurement of tripping time t_A
(for t_A measurement function)

RCD type	Factor	Range	Resolution	Accuracy	
General type	0.5 $I_{\Delta n}$	0...300 ms	1 ms	$\pm(2\% \text{ m.v.} + 2 \text{ digits})$	
	1 $I_{\Delta n}$				
	2 $I_{\Delta n}$				
Selective	5 $I_{\Delta n}$	0...40 ms			
	0.5 $I_{\Delta n}$				0...500 ms
	1 $I_{\Delta n}$				
2 $I_{\Delta n}$	0...200 ms				
5 $I_{\Delta n}$		0...150 ms			

Measurement of RCD trip current I_A for sinusoidal residual current

Nominal current	Measuring range	Resolution	Measurement current	Accuracy
10 mA	3.0...10.0 mA	0.1 mA	0.35 $I_{\Delta n}$...1.0 $I_{\Delta n}$	$\pm 5\% I_{\Delta n}$
15 mA	4.5...15.0 mA			
30 mA	9.0...30.0 mA			
100 mA	30...100 mA	1 mA		
300 mA	90...300 mA			
500 mA	150...500 mA			

» Measurement can be started from the positive or negative half-period of the input current

Measurement of RCD trip current I_A for uni-directional pulsating residual current

Nominal current	Measuring range	Resolution	Measurement current	Accuracy
10 mA	3.5...20.0 mA	0.1 mA	0.35 $I_{\Delta n}$...2.0 $I_{\Delta n}$	$\pm 10\% I_{\Delta n}$
15 mA	5.3...21.0 mA			
30 mA	10.5...42.0 mA			
100 mA	35...140 mA	1 mA		
300 mA	105...420 mA			

» Measurement for positive or negative half-periods of the input leakage current

Low-voltage measurement of circuit continuity and resistance

Testing of protective conductor continuity with $\pm 200 \text{ mA}$ current
measuring range according to EN 61557-4: 0.12...400 Ω

Display range	Resolution	Accuracy
0.00...19.99 Ω	0.01 Ω	$\pm(2\% \text{ m.v.} + 3 \text{ digits})$
20.0...199.9 Ω	0.1 Ω	
200...400 Ω	1 Ω	

- » Voltage on open terminals: 4...20 V
- » Output current at $R < 2 \Omega$: min. 200 mA
- » Automatic calibration of test leads
- » Measurements for both current polarities

MPI-506 • MPI-507 | Indication of phase sequence

- » Indication of phase sequence: compliant, non-compliant
- » U_{L-L} power system voltage range: 100...440 V (45...65 Hz)
- » Display of phase-to-phase voltage values



Adapter for testing vehicle charging stations

SONEL EVSE-01

index: WAADAEVSE01



CAT II
300 V
IP40

Capabilities

Adapter allows to perform comprehensive **measurements of electric vehicle charging stations** - quickly and in accordance with applicable regulations. Simulating the charging cable (proximity pilot line - PP) and vehicle connection status (control pilot line - CP), it will bring the station into different operating states. This will enable **measurements in the field of electric shock protection**: Z_s fault loop impedance, R_{ISO} insulation resistance and checking the parameters of RCD residual current devices.

To facilitate diagnostics, one of the EVSE-01 sockets is provided with **pulse width modulation signal (PWM)**.

Application

The EVSE-01 adapter enables measurements of AC electric vehicle charging stations with **type 2 connector**. Tests for 1-phase and 3-phase stations are available - both with and without ventilation.

Standard accessories:

Carrying case	WAFUTM6
---------------	---------

Technical specifications

- » type of insulation according to EN 61010-1 double
- » measurement category according to EN 61010-1 CAT II 300 V
- » ingress protection according to EN 60529 IP40
- » pollution degree 2
- » input voltage 400 V (3-phase)
- » frequency 50 Hz, 60 Hz
- » simulation of charging cable PP open circuit, 13 A, 20 A, 32 A, 63 A
- » vehicle connection simulation CP
 - state A vehicle not connected
 - state B vehicle connected, not charging
 - state C vehicle connected, charging without ventilation
 - state D vehicle connected, charging with ventilation
 - state E error - CP short to PE
- » socket types measuring sockets L1, L2, L3, N, PE
..... 1-phase socket
..... CP signal socket - PWM communication
- » test lead (length)
 - EVSE 1 m
 - MPI 0.5 m
- » operating temperature -5...+45°C
- » storage temperature -20...+60°C
- » dimensions 220 x 100 x 60 mm
- » weight 1.4 kg
- » the product meets EMC requirements acc. to standards EN 61326-1 and EN 61326-2-2

Works with*

MPI-540-PV
MPI-540
MPI-536
MPI-535

MPI-530-IT
MPI-530
MPI-525
MPI-520

MPI-507
MPI-506
MPI-502F



* the scope of measurements depends on the capabilities and technical parameters of each model.

Functional comparison

	MPI-540-PV MPI-540 MPI-536 MPI-535	MPI-530-IT MPI-530 MPI-525 MPI-520	MPI-507 MPI-506	MPI-502F
auto measurements	✓	-	-	-
automatic three-phase measurement via multiprog	✓	-	-	-
visual inspection	✓	-	-	-
fault loop Z_{LPEF} Z_{LN} parameters measurement	✓	✓	✓	✓
6 mA RCD test	✓	-	-	-
RCD test	AC, A, F, B, B+, EV	AC, A, F, B, B+	AC, A	AC, A
insulation resistance R_{ISO} measurement	✓	✓	✓	-
measurements report	✓	✓	✓	✓



SONEL MRP-201

index: WMGBMRP201



- CAT III**
- 600 V**
- CAT IV**
- 300 V**
- IP67**

Testing RCD breakers of AC, A and B types:

- › testing of general, short delay and selective RCDs for the rated current values $I_{\Delta n} = 10, 30, 100, 300, 500$ mA,
- › measurement of triggering current I_A and trip time t_A for currents $0.5 I_{\Delta n}, 1 I_{\Delta n}, 2 I_{\Delta n}, 5 I_{\Delta n}$
- › simultaneous measurement of triggering current I_A and trip time t_A
- › measurement of R_E and U_B without RCD tripping,
- › AUTO RCD test function (automatic measurement of subsequent selected parameters without triggering),
- › automatic measurement for all current shapes for RCDs of type AC, A and B.

MRP-201 measures all kinds of RCDs (general, short delay, selective - type AC, A, B).

Additional functions of the meter:

- › measurement of AC voltage and frequency,
- › checking the correctness of the connection of PE conductor,
- › memory of measurement results (990 cells, 10 000 entries),
- › communication with PC using Bluetooth interface,
- › backlit keyboard.

The instrument meets the requirements set forth in the standards:

- › EN 61010-1 (general and particular requirements related to safety)
- › EN 61010-031 (general and particular requirements related to safety)
- › EN 61326 (electromagnetic compatibility)
- › EN 61557 (requirements for measurement instruments)
- › HD 60364-6 (performance of measurements - checking)
- › HD 60364-4-41 (performance of measurements - shock protection)
- › PN-E 04700 (performance of measurements - commissioning tests)

MRP-201 has two kinds of automatic measurement mode, especially useful when measuring type A and B circuit breakers.

Other technical specifications:

- › type of insulation double, as per EN 61010-1 and EN 61557
- › power supply alkaline batteries (AA, 4 pcs) or rechargeable batteries set (option)
- › weight 0.7 kg
- › dimensions 220 x 102 x 61 mm

Nominal operating conditions:

- › operating temperature -10...+50°C
- › storage temperature -20...+70°C

Standard accessories:

WS-05 adapter with UNI-SCHUKO angular plug	WAADAWS05
M6 carrying case	WAFUTM6
Crocodile clip, yellow, 1 kV, 20 A	WAKROYE20K02
Test lead 1.2 m, red, 1 kV (banana plugs)	WAPRZ1X2REBB
Test lead 1.2 m, blue, 1 kV (banana plugs)	WAPRZ1X2BUBB
Test lead 1.2 m, yellow, 1 kV (banana plugs)	WAPRZ1X2YEBB
Pin probe, red 1 kV (banana socket)	WASONREOGB1
Pin probe, blue 1 kV (banana socket)	WASONBUOGB1
M1 hanging straps	WAPOZSZE4
4x R6 battery	
Factory calibration certificate	

RCD trigger test and response time measurement t_A

Measurement range according to IEC 61557:

0 ms...to the upper limit of the displayed value

RCD type	Rated current multiplication factor	Range	Resolution	Accuracy
General or short delay	0.5 $I_{\Delta n}$	0...300 ms	1 ms	$\pm(2\% \text{ m.v.} + 2 \text{ digits})$
	1 $I_{\Delta n}$			
	2 $I_{\Delta n}$			
Selective	5 $I_{\Delta n}$	0...40 ms	1 ms	$\pm(2\% \text{ m.v.} + 2 \text{ digits})$
	0.5 $I_{\Delta n}$			
	1 $I_{\Delta n}$			
	2 $I_{\Delta n}$	0...200 ms		
	5 $I_{\Delta n}$	0...150 ms		

- › residual current setting accuracy: for 1 $I_{\Delta n}, 2 I_{\Delta n}$ and 5 $I_{\Delta n}$: 0...8%; for 0.5 $I_{\Delta n}$: -8...0%,
- › operating voltage range: 180...270 V
- › operating frequency range: 45...65 Hz

RCD tripping current I_A for sine AC current

Measurement range acc. to IEC 61557-6: (0.3...1.0) $I_{\Delta n}$

Selected rated RCD current	Range	Resolution	Measuring current	Accuracy
10 mA	3.0...10.0 mA	0.1 mA	0.3 $I_{\Delta n}$...1.0 $I_{\Delta n}$	$\pm 5\% I_{\Delta n}$
30 mA	9.0...30.0 mA			
100 mA	30...100 mA	1 mA	0.3 $I_{\Delta n}$...1.0 $I_{\Delta n}$	$\pm 5\% I_{\Delta n}$
300 mA	90...300 mA			
500 mA	150...500 mA			

- › start of the measurement from the positive or negative half sine period of the test current
- › test current flow time at $f = 50.0$ Hz max. 7510 ms

Measurement of RCD tripping current I_A for unidirectional pulsed residual current and unidirectional pulsed current with a 6 mA DC offset

Measurement range acc. to IEC 61557-6:

(0.15...1.4) $I_{\Delta n}$ for $I_{\Delta n} > 30$ mA

(0.15...2) $I_{\Delta n}$ for $I_{\Delta n} = 10$ mA

Selected rated RCD current	Range	Resolution	Measuring current	Accuracy
10 mA	1.5...20.0 mA	0.1 mA	0.15 $I_{\Delta n}$...2.0 $I_{\Delta n}$	$\pm 10\% I_{\Delta n}$
30 mA	4.5...42.0 mA			
100 mA	15...140 mA	1 mA	0.15 $I_{\Delta n}$...1.4 $I_{\Delta n}$	$\pm 10\% I_{\Delta n}$
300 mA	45...420 mA			

- › start of the measurement from the positive or negative half sine period of the test current
- › test current flow time at $f = 50.0$ Hz max. 14 710 ms

RCD tripping current I_A for the residual DC current

Measurement range acc. to IEC 61557-6: (0.2...2) $I_{\Delta n}$

Selected rated RCD current	Range	Resolution	Measuring current	Accuracy
10 mA	2.0...20.0 mA	0.1 mA	0.2 $I_{\Delta n}$...2.0 $I_{\Delta n}$	$\pm 10\% I_{\Delta n}$
30 mA	6...60 mA	1 mA		
100 mA	20...200 mA			
300 mA	60...600 mA			

- › Measurement possible for positive or negative residual current
- › test current flow time at $f=50.0$ Hz max. 4500 ms.

SONEL PVM-1020 KIT / PVM-1020 / IRM-1



PVM-1020 KIT

Features

PVM-1020

- » It can be used for category 1 measurements according to IEC 62446-1.
- » **AUTO mode** for performing a sequence of measurements after one press of the **START** button.
- » It converts measured parameters into **STC conditions according to IEC 60891 by cooperation with the IRM-1 solar radiation and temperature meter.**
- » **reSYNC function** – automatic completion of results with environmental parameters and their conversion to STC conditions after restoring connection with IRM-1.
- » The built-in LoRa radio interface ensures cooperation with the IRM-1 meter over long distances.
- » Built-in Bluetooth module for communication with a computer.
- » Large measurement memory: 100 objects with 40 cells each.
- » Backlit display and buttons.

IRM-1

- » Measurement of solar radiation and temperature.
- » The LoRa interface for communication with the PVM-1020 meter - offers a larger range than the Bluetooth technology!
- » Automatic data synchronization with the PVM-1020 meter.
- » Built-in compass and inclination sensor.
- » Built-in recorder that can be used to record solar radiation before constructing PV systems, as well as to measure the shading of existing systems.
- » Large measurement memory: 999 cache memory cells and 5000 recorder records available (one-time recording) with the option of overwriting them (continuous recording).

Measured parameters

PVM-1020

- » The open circuit voltage of the PV panel or a chain of panels, up to 1000V DC.
- » RMS voltage of the AC network up to 600 V with frequency measurement.
- » Short circuit current of a PV panel or chain of panels - up to 20 A DC.
- » Insulation resistance of PV panels - measuring voltage of 250, 500 or 1000 V, simultaneous measurement of two values: R_{ISO+} and R_{ISO-} .
- » Insulation resistance of AC circuits - measuring voltage 250, 500 or 1000 V.
- » Resistance of protective conductors and equipotential bonding with ± 200 mA current. Low-current resistance measurement, audible and visual signalling.
- » Measurement of PV panels operating current and AC current - all with external clamp.
- » AC/DC power Measurement.
- » Diode test with 200 mA current, automatic polarity detection. Test of blocking diodes with 1000V DC voltage.

IRM-1

- » Solar radiation intensity (irradiance) in W/m^2 or BTU/ft^2h .
- » PV panel temperature in $^{\circ}C$ or $^{\circ}F$.
- » Ambient temperature in $^{\circ}C$ or $^{\circ}F$.
- » Inclination angle of panels
- » Orientation of the panels with the built-in compass.

Choose the best set for your needs

PVM-1020 KIT

Photovoltaic meter and solar radiation and temperature meter

index: WMGBPVM1020KIT

PVM-1020

Photovoltaic meter

index: WMGBPVM1020

IRM-1

Solar radiation and temperature meter

index: WMGBIRM1

PVM-1020: great capabilities in a small casing

PVM-1020 meter is probably the world's smallest photovoltaic system meter with such a substantial number of measurement functions. The functions are selected with a rotary switch. Additional parameters are set with buttons located on the housing. All buttons and the graphic display are backlit, which greatly facilitates operation in shaded places, e.g. when taking measurements under ground-mounted PV systems. Large memory significantly shortens preparation of documents after the measurement.

IRM-1: simple and compact

IRM-1, small, but indispensable for testing PV systems. By measuring solar radiation values, as well as panel and ambient temperatures, it provides the necessary data to convert the results into STC conditions. A built-in recorder with a memory of 5000 records enables the instrument to be used as a tool in the PV plant design process, as well as to diagnose panel shading problems.

Tightness and durability

Light meters perform well in harsh environmental conditions. Protection against the ingress of dust and water is provided by the housing rated at **IP65**. This is especially important for measurements on photovoltaic systems, which are outdoor installations.

Communication and software

Measurement data from the IRM-1 can be transferred to a computer via the USB port. In addition, the device has a built-in wireless **LoRa interface** (Long Range) for automatic data exchange with the PVM-1020 meter - even over long distances.

Measurement data from the PVM-1020 can be transferred to a computer via Bluetooth wireless communication. Saving the downloaded data to popular formats and printing ensured by **Sonei Reader**. In order to generate a report on electric shock protection use the optional software: **Sonei Reports Plus**.

PVM-1020: trouble? reSYNC!

It may happen that in the course of measurements the PVM-1020 moves away from the IRM-1 so far, that communication between them is lost. If the measurements are continued, then after the connection is restored, the results will be automatically **supplemented with environmental parameters**, which in the meantime were recorded by the IRM-1 in its **temporary memory**, and converted into STC conditions.

MPI / MRP / PVM

Set of standard and optional accessories

1, 2, 4 - number of standard accessories
- - optional accessories

Photo	Name	Index	MPI-540-PV Solar	MPI-540-PV	MPI-540-PV Start	MPI-540	MPI-540 Start	MPI-536	MPI-535	MPI-530/530-IT	MPI-525	MPI-520	MPI-520 Start	MPI-507	MPI-506	MPI-502F	MRP-201	PVM-1020 KIT	PVM-1020	IRM-1
	PVM-1020 photovoltaic meter	WMGBPVM1020																1	1	•
	IRM-1 solar radiation and temperature meter	WMBIRM1	•	•	•													1	•	1
	AC-16 line splitter	WAADAAC16	•	•	•	•	•			•		•	•						•	•
	AGT-16C three-phase socket adapter 16 A	WAADAAGT16C	•	•	•	•	•	•	•	•	•	•	•	•	•	•	•	•	•	•
	AGT-16P three-phase socket adapter 16 A	WAADAAGT16P	•	•	•	•	•	•	•	•	•	•	•	•	•	•	•	•	•	•
	AGT-16T industrial socket adapter 16 A	WAADAAGT16T	•	•	•	•	•	•	•	•	•	•	•	•	•	•	•	•	•	•
	AGT-32C three-phase socket adapter 32 A	WAADAAGT32C	•	•	•	•	•	•	•	•	•	•	•	•	•	•	•	•	•	•
	AGT-32P three-phase socket adapter 32 A	WAADAAGT32P	•	•	•	•	•	•	•	•	•	•	•	•	•	•	•	•	•	•
	AGT-32T industrial socket adapter 32 A	WAADAAGT32T	•	•	•	•	•	•	•	•	•	•	•	•	•	•	•	•	•	•
	AGT-63P three-phase socket adapter 63 A	WAADAAGT63P	•	•	•	•	•	•	•	•	•	•	•	•	•	•	•	•	•	•
	AutoISO-1000C adapter	WAADA AIS010C	•	•	•	•	•		•	•		•	•							
	AutoISO-2500 adapter	WAADA AIS025						•			•									
	EVSE-01 adapter	WAADA EVSE01	•	•	•	•	•	•	•	•	•	•	•	•	•	•	•			
	PVM-1 adapter	WAADAPVM1	1	1	1															
	IRM-1 mounting&measuring set (solar radiation meter mounting kit for PV panels + probe for measuring the temperature of PV panels and the ambient temperature)	WASONTPVCKPL	•	•	•													1		1
	Solar radiation measurement set (IRM-1 solar radiation and temperature meter + IRM-1 mounting&measuring set + Z24 power supply + LORA-S1 adapter for data transmission + M14 carrying case)	WMBIRM1MPI	1	•	•															
	TWR-1J - RCD breaker testing adapter	WAADATWR1J	•	•	•	•	•	•	•	•	•	•	•	•	•	•	•			
	WS-01 adapter with START button with UNI-Schuko plug	WAADAWS01															•	•		
	WS-03 adapter with START button with UNI-Schuko plug	WAADAWS03	1	1	1	1	1	1	1	1	1	1	1	1	1	1				
	WS-04 adapter with UNI-Schuko plug	WAADAWS04	•	•	•	•	•	•	•	•	•	•	•	•	•	•				
	WS-05 adapter with UNI-Schuko plug	WAADAWS05													•	•	•	1		
	WS-06 adapter (miniDIN-4P plug)	WAADAWS06	•	•	•	•	•	•	•	•										

MPI / MRP / PVM

Set of standard and optional accessories

1, 2, 4 - number of standard accessories
 - - optional accessories

Photo	Name	Index	MPI-540-PV Solar	MPI-540-PV	MPI-540-PV Start	MPI-540	MPI-540 Start	MPI-536	MPI-535	MPI-530/530-IT	MPI-525	MPI-520	MPI-520 Start	MPI-507	MPI-506	MPI-502F	MRP-201	PVM-1020 KIT	PVM-1020	IRM-1	
	WS-07 adapter for measuring Z(L-N)	WAADAWS07																			
	WS-09 adapter (pin probe)	WAADAWS09	•	•	•	•	•	•	•												
	Voltage adapters with M4/M6 thread (set of 4 pcs.)	WAADAM4M64	1	1	1	1	1														
	MC4-banana sockets adapter (set of 2 pcs.)	WAADAMC4	1	1	1														1	1	
	MC4 splitter for power measurement in PV systems - set of 2 pcs.	WAADAMC4SKPL	•	•	•															•	•
	Adapter for C-PV clamp	WAADACPV	1	1	1																
	Double-wire test lead 2 m, for N-1 clamps (banana plugs)	WAPRZ002DZBB	•	•	•	•	•	•	•	•											
	F-1A flexible coil (Ø360 mm)	WACEGF1AOKR	•	•	•	•	•				•										
	F-2A flexible coil (Ø235 mm)	WACEGF2AOKR	•	•	•	•	•				•										
	F-3A flexible coil (Ø120 mm)	WACEGF3AOKR	3	3	•	3	•				•										
	N-1 transmitting clamp (Ø52 mm)	WACEGN1BB	•	•	•	•	•	•	•	•											
	C-3 current clamp (Ø52 mm)	WACEGC3OKR	•	•	•	•	•	•	•	•		•	•								
	C-4A current clamp (Ø52 mm)	WACEGC4AOKR	•	•	•	•	•														
	C-5A current clamp (Ø39 mm)	WACEGC5AOKR	•	•	•	•	•														
	C-6A current clamp (Ø20 mm)	WACEGC6AOKR	•	•	•	•	•			•											
	C-7A current clamp (Ø24 mm)	WACEGC7AOKR	•	•	•	•	•														
	C-PV clamp	WACEGCPVOKR	1	1	1														1	1	
	Crocodile clip, black, 1 kV, 20 A	WAKROBL20K01	1	1	1	1	1					1							1	1	
	Crocodile clip, red, 1 kV, 20 A	WAKRORE20K02	1	1	1	1	1	1	1	1	•	1	1	1	1	•	•		1	1	
	Crocodile clip, blue, 1 kV, 20 A	WAKROBU20K02	1	1	1	1	1	1	1	1	•	•	•	•	•	•	•				
	Crocodile clip, yellow, 1 kV, 20 A	WAKROYE20K02	1	1	1	1	1	1	1	1	1	1	1	1	1	1	1	1	1	1	
	Crocodile clip, black, 11 kV, 32 A	WAKROBL32K09						1			1										
	Crocodile clip, red, 11 kV, 32 A	WAKRORE32K09						•		•											
	Test lead 1.2 m, black, 1 kV (banana plugs)	WAPRZ1X2BLBB																	1	1	

MPI / MRP / PVM

Set of standard and optional accessories

1, 2, 4 - number of standard accessories
- - optional accessories

Photo	Name	Index	MPI-540-PV Solar	MPI-540-PV	MPI-540-PV Start	MPI-540	MPI-540 Start	MPI-536	MPI-535	MPI-530/530-IT	MPI-525	MPI-520	MPI-520 Start	MPI-507	MPI-506	MPI-502F	MRP-201	PVM-1020 KIT	PVM-1020	IRM-1	
	Test lead 1.2 m, black, 1 kV with markers (banana plugs)	WAPRZ1X2BLBNN	1	1	1	1	1														
	Test lead 1.2 m, red, 1 kV (banana plugs)	WAPRZ1X2REBB	1	1	1	1	1	1	1	1	1	1	1	1	1	1	1	1	1	1	1
	Test lead 1.2 m, blue, 1 kV (banana plugs)	WAPRZ1X2BUBB	1	1	1	1	1	1	1	1	1	1	1	1	1	1	1				
	Test lead 1.2 m, yellow, 1 kV (banana plugs)	WAPRZ1X2YEBB	1	1	1	1	1	1	1	1	1	1	1	1	1	1	1	1	1	1	1
	Test lead 5 m, red, 1 kV (banana plugs)	WAPRZ005REBB
	Test lead 10 m, red, 1 kV (banana plugs)	WAPRZ010REBB
	Test lead 20 m red 1 kV (banana plugs)	WAPRZ020REBB
	Test lead 30 m, red, 1 kV (banana plugs)	WAPRZ030REBBN												1							
	Test lead 15 m, blue, 1 kV (banana plugs)	WAPRZ015BUBBN												1							
	Test lead 15 m, blue (on a reel)	WAPRZ015BUBBSZ	1	1	1	1	1	1	1	1	1	1	.	.							
	Test lead 25 m, red (banana plugs, on a reel)	WAPRZ025REBBSZ
	Test lead 25 m, blue (banana plugs, on a reel)	WAPRZ025BUBBSZ
	Test lead 30 m, red (banana plugs, on a reel)	WAPRZ030REBBSZ	1	1	1	1	1	1	1	1	1	1	.	.							
	Test lead 50 m, yellow (banana plugs, on a reel)	WAPRZ050YEBBSZ
	Test lead 1.8 m, black, 5 kV (banana plugs, shielded)	WAPRZ1X8BLBB						1			1										
	Test lead 1.8 m, red, 5 kV (banana plugs)	WAPRZ1X8REBB						1			1										
	PRS-1 resistance test probe	WASONPRS1
	LP-1 light meter probe (miniDIN-4P plug)	WAADALP1
	LP-1 light meter probe for MPI (set, WS-06 plug)	WAADALP1KPL
	LP-10A light meter probe (miniDIN-4P plug)	WAADALP10A
	LP-10A light meter probe for MPI (set, WS-06 plug)	WAADALP10AKPL
	LP-10B light meter probe (miniDIN-4P plug)	WAADALP10B
	LP-10B light meter probe (set, WS-06 plug)	WAADALP10BKPL
	Foldable pin probe, 1 kV, 2 m (banana socket)	WASONSP2M

MPI / MRP / PVM

Set of standard and optional accessories

1, 2, 4 - number of standard accessories
 - - optional accessories

Photo	Name	Index	MPI-540-PV Solar	MPI-540-PV	MPI-540-PV Start	MPI-540	MPI-540 Start	MPI-536	MPI-535	MPI-530/530-IT	MPI-525	MPI-520	MPI-520 Start	MPI-507	MPI-506	MPI-502F	MRP-201	PVM-1020 KIT	PVM-1020	IRM-1		
	Pin probe, black 1 kV (banana socket)	WASONBLOGB1																			•	•
	Pin probe, red 1 kV (banana socket)	WASONREOGB1	1	1	1	1	1	1	1	1	1	1	1	1	1	1	1	1	1	1	1	1
	Pin probe, blue 1 kV (banana socket)	WASONBUOGB1	1	1	1	1	1	1	1	1	1	1	1	1	1	1	1	1	1	1	1	•
	Pin probe, yellow 1 kV (banana socket)	WASONYEOGB1	1	1	1	1	1	1	1	1	1	1	1	•	1	1	•	•	•	•	•	•
	Pin probe, black 5 kV (banana socket)	WASONBLOGB2							•		•											
	Pin probe, red 5 kV (banana socket)	WASONREOGB2							1		1											
	Probe for measuring the temperature of PV panels and the ambient temperature	WASONT PVC	•	•	•																•	•
	Earth contact test probe (rod), 25 cm	WASONG25													2							
	Earth contact test probe (rod), 30 cm	WASONG30	2	2	2	2	2	2	2	2	2	2	•	•								
	Earth contact test probe (rod), 80 cm	WASONG80V2	•	•	•	•	•	•	•	•	•	•	•	•								
	Cramp (banana socket)	WAZACIMA1	•	•	•	•	•	•	•	•	•	•	•	•								
	CS-1 cable simulator	WAADACS1	•	•	•	•	•	•	•	•	•	•	•									
	CS-5kV calibration box	WAADACS5KV						•		•												
	NiMH battery 4.8 V 4.2 Ah	WAAKU07								1	1	•	•									
	Li-Ion battery 11.1 V 3.4 Ah	WAAKU15	1	1	1	1	1	1	1													
	Battery container	WAP0J1								•	•	1	1									
	Z7 power supply	WAZASZ7	1	1	1	1	1	1	1	1	1	•	•									
	Z24 5 V power supply with USB 2.0 output and a detachable micro-USB cable	WAZASZ24																			1	1
	Mains cable with IEC C7 plug	WAPRZLAD230	1	1	1	1	1	1	1	1	1	•	•									
	MPI charging set (charger + battery)	WAKPLLADMPI520								•	•	•	•									
	AZ-2 power supply adapter (IEC C7 plug/banana connectors)	WAADAAZ2	•	•	•	•	•	•	•													
	Cable for battery charging from car cigarette lighter socket (12 V)	WAPRZLAD12SAM	1	1	1	1	1	1	1	1	1	•	•	•								
	Test wire reel	WAP0ZSZP1	•	•	•	•	•	•	•	•	•	•	•									
	L2 hanging straps (set)	WAP0ZSZEKPL	1	1	1	1	1	1	1	1	1	1	1									

MPI / MRP / PVM

Set of standard and optional accessories

1, 2, 4 - number of standard accessories
- - optional accessories

Photo	Name	Index	MPI-540-PV Solar	MPI-540-PV	MPI-540-PV Start	MPI-540	MPI-540 Start	MPI-536	MPI-535	MPI-530/530-IT	MPI-525	MPI-520	MPI-520 Start	MPI-507	MPI-506	MPI-502F	MRP-201	PVM-1020 KIT	PVM-1020	IRM-1
	M1 hanging straps	WAPOZSZE4												1	1	1	1	1	1	
	M1 hanging hook straps	WAPOZUCH1												1	1	1				
	Magnetic hanging strap	WAPOZUCH6																		
	Cover (universal)	WAPOZUCH12																		
	Solar radiation meter mounting kit for PV panels	WAPOZUCHPV																	1	1
	Clamp for mounting the solar radiation meter to the solar panels	WAZACPV																		
	L2 carrying case	WAFUTL2	1	1	1	1	1	1	1	1	1	1								
	L3 carrying case for a 80 cm rods	WAFUTL3																		
	L4 carrying case	WAFUTL4																		
	M6 carrying case	WAFUTM6																		
	M13 carrying case	WAFUTM13	1	1	1															
	M14 carrying case	WAFUTM14																		1
	XL12 hard carrying case	WAWALXL12																		
	XL13 hard carrying case	WAWALXL13																		
	S4 armband case for mini Bluetooth keyboard	WAFUTS4																		
	USB cable	WAPRZUSB	1	1	1	1	1	1	1	1	1	1	1							
	LORA-S1 USB adapter for data transmission	WAADAUSBLORA																		
	OR-1 USB wireless receiver	WAADAUSBOR1																	1	
	PC software: Sonei Reports Plus	WAPROREPORTSPPLUS																		
	PC software: Sonei Reader	WAPROREADER	1	1	1	1	1	1												

SONEL MPI MOBILE



A mobile version of the program cooperating with a multifunctional Sonei instrument: MPI-530-IT / MPI-530 meters of electrical system parameters. It can be downloaded from [Google Play](#).

With the application you can **connect directly to the device** via Bluetooth and download the measurement data from the meter. After reading the measurements from the instrument, they can be easily and quickly **viewed**, but also **sent from the measurement place** to a person who can help interpret the data or perform a measurements documentation.

To each measurement we can add, voice memo, note, GPS data, or photo. From the application level we also have **access to the meter's user manual**.

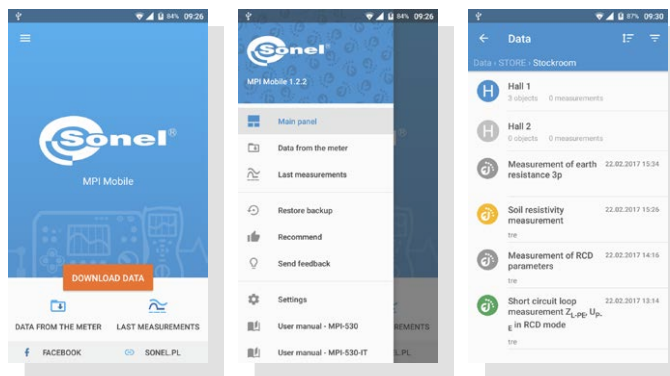

Insulation resistance meters

MIC-15k1
MIC-10k1
MIC-5050

MIC-5010
MIC-5005
MIC-5001

MIC-2511
MIC-2501

MIC-30
MIC-10

MIC-5

Comparison of insulation resistance meters

	MIC-15k1	MIC-10k1	MIC-5050	MIC-5010	MIC-5005	MIC-5001	MIC-2511	MIC-2501
Measurement voltage [V]	50...15 000	50...10 000	50...5000	50...5000	50...5000	50...5000	10...2500	100...2500
Measuring range	50 kΩ...40 TΩ	10 kΩ...40 TΩ	20 kΩ...20 TΩ	20 kΩ...15 TΩ	20 kΩ...15 TΩ	50 kΩ...5 TΩ	50 kΩ...2 TΩ	50 kΩ...2 TΩ
Short-circuit current I _{sc}	1.2/3/5/7 mA	1.2/3/6 mA	1.2/3/6 mA	1.2/3 mA	1.2/3 mA	1.5 mA	≤2 mA	1 mA
Setting of 3 measurement times for calculation of Ab1, Ab2, Pi, DAR	1...600 s	1...600 s	1...600 s	1...600 s	1...600 s	1...600 s	1...600 s	1...600 s
Maximum setting of measurement time	99'59"	99'59"	99'59"	99'59"	99'59"	10'	60'	10'
Measurement of insulation resistance using the three-terminal method	✓	✓	✓	✓	✓	✓	✓	✓
Measurement of 2 absorption coefficients	✓	✓	✓	✓	✓	✓	✓	✓
Measurement of leakage current during insulation resistance measurement	✓	✓	✓	✓	✓	✓	✓	✓
Automatic discharging of object after measurement	✓	✓	✓	✓	✓	✓	✓	✓
Built-in quick charger	✓	✓	✓	✓	✓	✓	✓	✓
Power supply	rechargeable battery	rechargeable battery	rechargeable battery	rechargeable battery	rechargeable battery	rechargeable battery	rechargeable battery	rechargeable battery
Low-voltage resistance measurement	–	–	–	–	–	–	✓	–
Continuity test with current ≥200mA (resolution 0.01Ω)	–	–	–	✓	–	–	✓	✓
Automatic measurement of 3-, 4- and 5-core cords by means of AutoISO adapters	–	AutoISO-5000	AutoISO-5000	–	–	–	AutoISO-2511	–
Voltage measurement	0...600 V	0...750 V	0...750 V	0...600 V	0...600 V	0...750 V	0...1500 V	0...750 V
Temperature measurement	–	✓	✓	–	–	–	✓	–
Plotting of insulation resistance and leakage current characteristics	in mobile application	✓	✓	in mobile application	in mobile application	✓	✓	✓
Automatic in-socket measurement	–	–	–	–	–	–	–	–
Capacitance measurement	✓	✓	✓	✓	✓	–	✓	–
Memory (number of records)	990 autosave	10 000	10 000	990	990	990	9999	990
Data transmission	USB, Bluetooth	USB, Bluetooth	USB, Bluetooth	USB, Bluetooth	USB, Bluetooth	USB	USB	USB
Dimensions [mm]	390 x 308 x 172	390 x 308 x 172	390 x 308 x 172	390 x 308 x 172	390 x 308 x 172	200 x 180 x 77	234 x 169 x 70	200 x 180 x 77
Weight [kg]	6.6	6.1	6.1	6.0	6.0	1.0	1.3	1.0

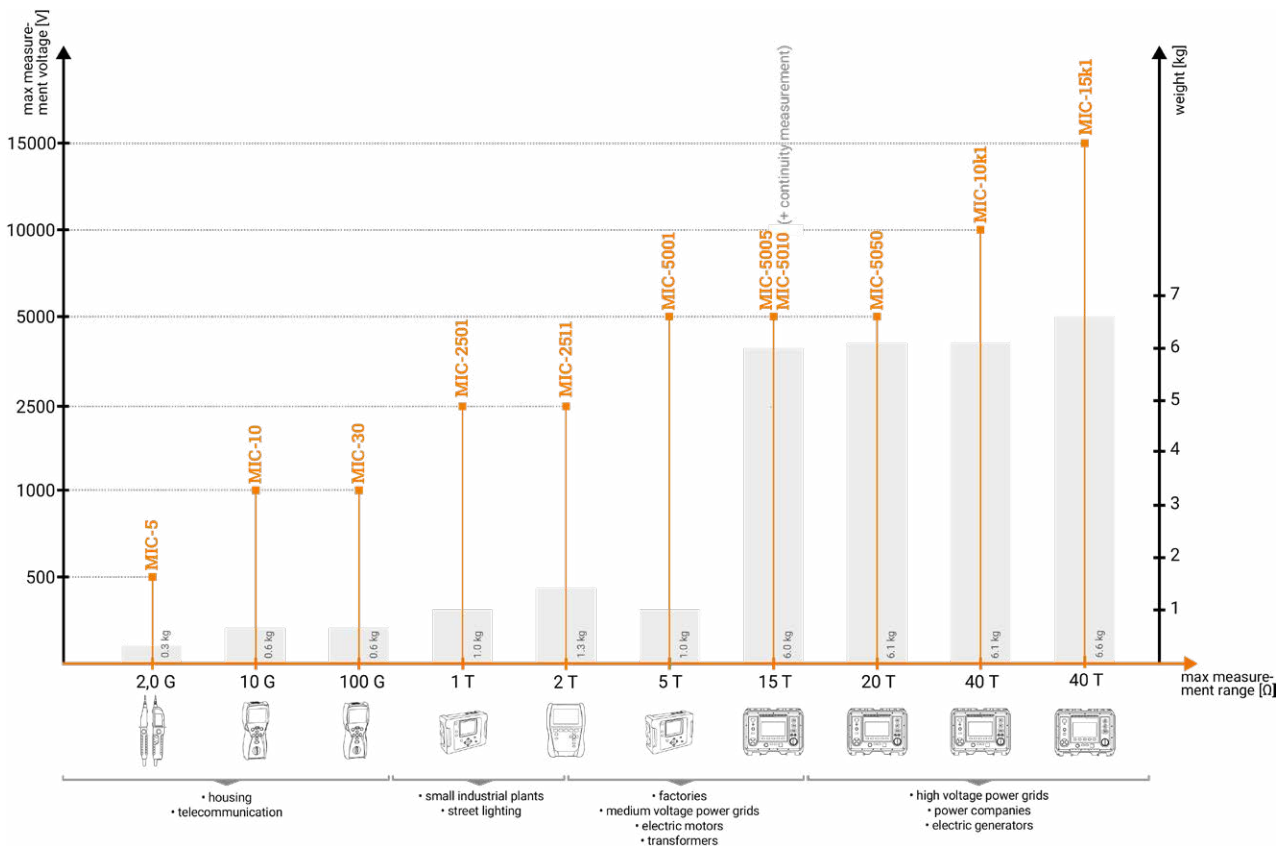



MIC-30	MIC-10	MIC-5	MPI-540-PV MPI-540 MPI-535	MPI-536	MPI-530-IT MPI-530	MPI-525	MPI-520	MPI-507 MPI-506	
50...1000	50, 100, 250, 500, 1000	250, 500	50, 100, 250, 500, 1000	10, 50, 100, 250, 500, 1000, 1500, 2500	50, 100, 250, 500, 1000	50, 100, 250, 500, 1000, 2500	50, 100, 250, 500, 1000	100, 250, 500	Measurement voltage [V]
50 kΩ...100 GΩ	50 kΩ...10 GΩ	250 kΩ...1.999 GΩ	50 kΩ...9.99 GΩ	10 kΩ...9.99 GΩ	50 kΩ...9.99 GΩ	50 kΩ...9.99 GΩ	50 kΩ...3 GΩ	100 kΩ...600 MΩ	Measuring range
1 mA	1 mA	<1.4 mA	<2 mA	<2 mA	<2 mA	<2 mA	<2 mA	<2 mA	Short-circuit current I _{sc}
1...600 s	–	–	–	1...600 s	–	1...600 s	–	–	Setting of 3 measurement times for calculation of Ab1, Ab2, Pi, DAR
10'	–	–	–	5'	–	5'	–	–	Maximum setting of measurement time
√	√	–	–	–	–	–	–	–	Measurement of insulation resistance using the three-terminal method
√	–	–	–	√	–	√	–	–	Measurement of 2 absorption coefficients
√	–	–	–	–	–	–	–	–	Measurement of leakage current during insulation resistance measurement
√	√	√	√	√	√	√	√	√	Automatic discharging of object after measurement
–	–	–	√	√	√	√	√	–	Built-in quick charger
AA batteries or rechargeable batteries	AA batteries or rechargeable batteries	AAA batteries or rechargeable batteries	rechargeable battery	rechargeable battery	rechargeable battery or batteries	rechargeable battery or batteries	batteries or rechargeable batteries	batteries or rechargeable batteries	Power supply
√	√	√	√	√	√	√	√	√	Low-voltage resistance measurement
√	√	–	√	√	√	√	√	√	Continuity test with current ≥200mA (resolution 0.01Ω)
–	–	–	–	AutoISO-2500	–	AutoISO-2500	–	–	Automatic measurement of 3-, 4- and 5-core cords by means of AutoISO adapters
0...600 V	0...600 V	0...600 V	0...500 V	0...500 V	0...500 V	0...500 V	0...500 V	0...500 V	Voltage measurement
–	–	–	–	–	–	–	–	–	Temperature measurement
–	–	–	–	√	–	–	–	–	Plotting of insulation resistance and leakage current characteristics
√	–	–	√	–	√	–	√	√	Automatic in-socket measurement
√	√	–	–	–	–	–	–	–	Capacitance measurement
990	–	–	UNLIMITED	UNLIMITED	10 000	990	990	990	Memory (number of records)
Bluetooth	–	–	USB, Bluetooth	USB, Bluetooth	USB, Bluetooth	USB, Bluetooth	USB, Bluetooth	USB, Bluetooth	Data transmission
200 x 150 x 60	220 x 100 x 60	275 x 82 x 36	288 x 223 x 75	288 x 223 x 75	295 x 223 x 75	288 x 223 x 75	288 x 223 x 75	220 x 102 x 61 mm	Dimensions [mm]
0.6	0.6	0.3	2.5	2.5	2.2	2.2	2.2	0.8	Weight [kg]

In addition to specific meters you can also purchase:

Adapter for measuring insulation resistance

SONEL AutoISO-2500

index: WAADAAISO25

Insulation resistance measurements:

- » insulation measurement of 3-, 4- and 5-wire cables and wires using test voltage up to 2.5 kV optional for MPI-536, MPI-525



Adapter for measuring insulation resistance

SONEL AutoISO-2511

index: WAADAAISO2511

Insulation resistance measurements:

- » insulation measurement of 3-, 4- and 5-wire cables and wires using test voltage up to 2.5 kV optional for MIC-2511



Adapter for measuring insulation resistance

SONEL AutoISO-5000

index: WAADAAISO50

Insulation resistance measurements:

- » insulation measurement of 3-, 4- and 5-wire cables and wires using test voltage up to 5 kV optional for MIC-10k1, MIC-5050



Probe for measurement of floor and wall resistances

SONEL PRS-1

index: WASONPRS1

- » Sonel PRS-1 tripod measuring probe, with the shape of an equilateral triangle, has been manufactured according to the guidelines given in standards HD 60364-6 and EN 1081
- » optional for MIC and MPI meters



Probe for measuring resistance in zones with ESD protection

SONEL PRS-2 / PRS-2 KIT

index: WASONPRS2 / WASONPRS2KIT

- » 2x double-sized ring-shape measurement probe (counter-electrode)
- » circular probe (counter-electrode)
- » 2x pressure weight
- » insulating plate
- » 3x test lead 1.2 m
- » test lead 10 m on a reel
- » distance line 25 cm
- » PRS-2 KIT | L-7 carrying case
- » optional for MIC-2511



Set for measuring resistance in zones with ESD protection

SONEL PRZ-2

index: WASONPRZ2

- » set: PRS-1 + PRS-2 KIT
- » optional for MIC-2511



Insulation Quality Analyzer

SONEL MIC-15k1

index: WMGBMIC15k1

- CAT IV
- 1000 V
- CAT IV
- 600 V
- IP67
- BLUETOOTH
- 50°C
HEAVY DUTY
-20°C



- 15 kV**
 maximum
 measurement
 voltage
- 40 TΩ**
 maximum
 measurement
 range
- partial
 discharges
 indicator
- remote
 control
 by phone

Measurement of insulation resistance:

- » up to 40 TΩ,
- » measurement voltages selected within the range of 50...15 000 V,
- » remote start and stop of the measurement via Sonei MIC Mobile application,
- » continuous readings of measured insulation resistance and leakage current,
- » sound signaling of five-second time intervals, facilitating capture of time characteristics,
- » measurement time setting - up to 99'59",
- » timing of measurement times T₁, T₂ and T₃ for measurement of one or two absorption coefficients (Ab1, Ab2 or DAR, PI) within the range of 1...600 s,
- » reading of actual measurement voltage during measurement,
- » measurement current 1.2 mA, 3 mA, 5 mA or 7 mA,
- » protection against measurement of live object,
- » digital filters for measurements with strong disturbances (10 s, 30 s, 60 s, 100 s, 200 s).

Measurement functions:

- » insulation resistance measurement:
 - two- or three-lead method,
 - measurements with lead lengths up to 20 m,
 - measurement of capacitance during measurement of R_{ISOV},
 - measurement of leakage current during measurement of R_{ISOV},
- » measurement with step voltage (SV),
- » dielectric discharge (DD) test,
- » measurement with RampTest (RT) method,
- » damage location (burning function, current of 11 mA),
- » measurement of surface and volume resistance (Sr),
- » partial discharge indicator,
- » measurement of polarization and depolarization currents (PDC).

Additional functions of the meters:

- » high immunity to disturbances - in compliance with standard EN 61326,
- » setting the limits of minimal insulation resistance,
- » measurement of direct and alternating voltages within the range of 0...600 V,
- » autosaving the measurement results to the dynamic memory of the device,
- » 990-cell memory (11,880 entries)
- » data transmission to PC via USB connection or Bluetooth®,
- » supports external wireless Bluetooth® keyboard (optional),
- » backlit keyboard and display,
- » power supply from rechargeable battery packs or power grid,
- » charging during measurement,
- » the instrument meets the requirements laid down by standard EN 61557.

VIRTUAL INSTRUMENTS

We invite you to use the **virtual instruments** application. Thanks to it you can familiarize yourself with features of a selected device, its interface and capabilities.

The application gives you the opportunity to change the selected meter's configuration and perform measurements in a way you would in reality.

www.sonei.com > Knowledge Centre > Virtual instrument applications

Standard accessories:

L4 carrying case	WAFUTL4
W1 hanging straps	WAPOZSZE5
Test lead 15 kV 3 m CAT IV 1000 V with crocodile clip, red	WAPRZ003REKRO15KV
Test lead 15 kV 3 m CAT IV 1000 V with crocodile clip, shielded, black	WAPRZ003BLKROE15KV
Test lead 15 kV 3 m CAT IV 1000 V with crocodile clip, blue	WAPRZ003BUKRO15KV
USB cable	WAPRZUSB
Mains cable with IEC C13 plug	WAPRZ1X8BLIEC
Factory calibration certificate	

Measurement of insulation resistance

Measuring range in compliance with EN 61557-2:

$$R_{ISOmin} = \frac{U_{ISONom}}{I_{ISOmax}} = 50 \text{ k}\Omega \dots 40 \text{ T}\Omega \quad (I_{ISOmax} = 1.2 \text{ mA}, 3 \text{ mA}, 5 \text{ mA}, 7 \text{ mA})$$

Display range	Resolution	Accuracy
0...999 kΩ	1 kΩ	±(3% w.m. + 10 digits)
1.00...9.99 MΩ	0.01 MΩ	
10.0...99.9 MΩ	0.1 MΩ	
100...999 MΩ	1 MΩ	
1.00...9.99 GΩ	0.01 GΩ	±(3.5% w.m. + 10 digits)
10.0...99.9 GΩ	0.1 GΩ	
100...999 GΩ	1 GΩ	±(7.5% w.m. + 10 digits)
1.00...9.99 TΩ	0.01 TΩ	
10.0...20.0 TΩ	0.1 TΩ	±(12.5% w.m. + 10 digits)
10.0...40.0 TΩ		

Values of measured resistance depending on measuring voltage

Display range	Measuring range
50 V	200 GΩ
100 V	400 GΩ
250 V	1.00 TΩ
500 V	2.00 TΩ
1000 V	4.00 TΩ
2500 V	10.0 TΩ
5000 V	20.0 TΩ
10000 V	40.0 TΩ
15000 V	40.0 TΩ

Electrical safety:

- » type of insulation double, as per EN 61010-1 and EN 61557
- » measurement category CAT IV 1000 V (operating altitude ≤2000 m) acc. to EN 61010-1
..... CAT IV 600 V (operating altitude ≤3000 m) acc. to EN 61010-1
- » housing protection rating acc. to EN 60529 IP40
..... (IP67 with closed housing cover)

Nominal operating conditions:

- » operating temperature range -20...+50°C
- » storage temperature -25...+70°C
- » humidity 20...90%
- » elevation above sea level ≤3000 m
- » reference temperature +23°C ± 2°C
- » reference humidity 40...60%

Other technical specifications:

- » power supply built-in Li-FePO4 rechargeable battery 13.2 V 5.0 Ah
..... from network: 90 V ÷ 260 V 50/60 Hz
- » weight approx. 6.6 kg
- » dimensions 390 x 308 x 172
- » transmission of results USB link or Bluetooth®

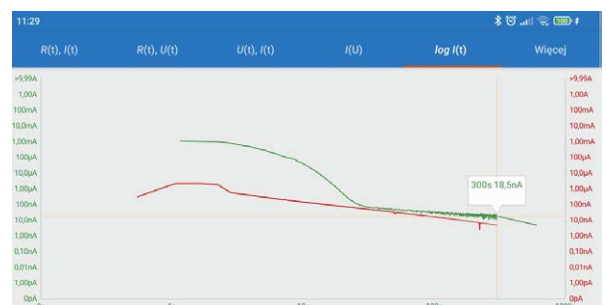

PDC measurements (Sonei MIC Mobile)



For all operating conditions



Supported by a mobile application

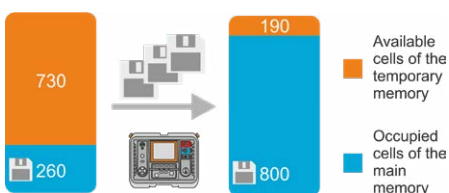

Static and dynamic memory of measurements

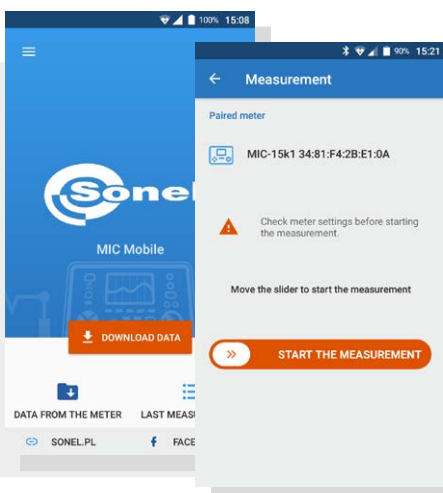

Application

MIC-15k1 meter is designed to measure insulation resistance of power objects, i.e.:

- » single- and multicore cables,
- » transformers,
- » motors and generators,
- » capacitors, switches and other devices installed in power stations.

It is especially recommended for measurements in areas with very high electromagnetic disturbances, e.g. electrical substations with **1200 kV AC** and **500 kV DC**. Thanks to the 15 kV* measuring voltage (in accordance with ANSI / NETA ATS-2009 TABLES 100.1) the meter can be used for measuring objects with a nominal voltage above 34.5 kV.

*The measuring voltage equals 15 kV ± 10%, which gives max. 16,5 kV.

Capabilities of the device

Highly efficient HV inverter, with test voltage of **15 kV** and current **up to 10 mA**,

suitable for measuring the insulation resistance **up to 40 TΩ**. Achieving such a result makes these meters unrivalled devices. Three-wire resistance measurement, performed using a "GUARD" wire, eliminates surface leakage currents caused by contaminated insulation, thereby increasing the reliability of obtained results.

The meter indicates the Dielectric Absorption Ratio **DAR**, Polarization Index **PI** and the value of Dielectric Discharge **DD** (measurement time **60...5999 s**).

The device allows user to assess the condition of the insulation, by applying the test voltage incrementally in steps (SV - Step Voltage) or smoothly (RampTest - RT).

- » SV method ensures that a dielectric in good condition will provide the same results, regardless of the applied voltage.
- » RT method allows to determine the characteristics of the insulating material. The meter smoothly increases the measuring voltage without exposing the object to so-called electrical stress. It records the time and voltage value at which the electrical breakdown of the insulation took place.

Built-in **digital filters**, with averaging time of 10, 30, 60, 100, 200 sec. guarantee stable measurement results in areas of strong electromagnetic interference.

Burnout

A very useful solution is the function that allows to Burnout the damaged object. In case of **exposed cables**, it enables **visual identification** of the fault location. In the case of shielded cables, the method allows to generate a **seismic-acoustic** wave from the place of damage.

In special conditions, an energetic discharge will appear cyclically. By using the geophone it will be possible to precisely pinpoint the place where such a discharge occurs.

Burnout feature allows also locating transient faults (appearing, for example, only during rainfall) with the support of reflectometry, and in case of a short circuit (of a screen or return wire) to the ground - applying the method of measuring voltage drop (the A-frame).

Autosaving the measurement results

The device automatically saves the measurement results. The number of autosave points depends on the amount of data, which is saved within the main memory.

Data analysis

The **Sonel MIC Mobile** mobile app allows to observe the results during the measurement. The application can generate real-time graphs in various configurations. This allows to evaluate the condition of the object already during the tests.

The option of remote start and stop of the measurement is particularly useful. Thanks to it, the tests can be carried out remotely, eg. from a different room or inside the car, when there are difficult weather conditions for the user. Using the phone GPS, it is possible to precisely determine the place of measurement.

Thanks to the mobile application and the **Sonel Reader** software, the user can store previous measurements data and compare them with current results transferred from the meter's extensive memory. This solution allows to prepare a measurement report, track the progress of insulation degradation and plan renovation works.

SONEL MIC MOBILE



Mobile version of the program cooperating with insulation resistance meters: **MIC-15k1**, **MIC-10k1**, **MIC-5050**, **MIC-5010**, **MIC-5005**.

With the application, you can **connect directly to the device** via Bluetooth and download measurement data from the meter. After reading the measurements from the device, they can be easily and quickly **viewed**, and also **sent from the place of measurement** to the person who can help in the interpretation of data or make a measurement report. Additional functionalities will be useful: assigning a photo, text or voice note to a given measurement.

There is a possibility to start and stop the measurement remotely. You can also convert the **k20 temperature coefficient**. The application can be downloaded from **Google Play**.

SONEL MIC-10k1 / MIC-5050

index: WMGBMIC10K1 / WMGBMIC5050



MIC-10k1
40 TΩ
maximum measurement range

Measurement of insulation resistance:

- » MIC-10k1 | up to 40 TΩ,
- » MIC-5050 | up to 20 TΩ,
- » measurement voltages selected within the range of:
 - MIC-10k1 | 50...10 000 V: 50...1000 V in steps of 10 V, 1...10 kV in steps of 25 V,
 - MIC-5050 | 50...5000 V: 50...1000 V in steps of 10 V, 1...5 kV in steps of 25 V,
- » remote start and stop of the measurement via Sonel MIC Mobile application,
- » charts plotted on display during measurements,
- » correction of insulation resistance result to reference temperature,
- » continuous readings of measured insulation resistance and leakage current,
- » automatic discharge of the measured object's capacitance upon completion of insulation resistance measurement,
- » sound signaling of five-second time intervals, facilitating capture of time characteristics,
- » measurement time setting - up to 99'59",
- » timing of measurement times T₁, T₂ and T₃ for measurement of one or two absorption coefficients (Ab1, Ab2 or DAR, PI) within the range of 1...600 s,
- » reading of actual measurement voltage during measurement,
- » measurement current **1.2 mA, 3 mA or 6 mA**,
- » protection against measurement of live object,
- » digital filters for measurements with strong disturbances (**10 s, 30 s, 60 s**).

Measurement functions:

- » insulation resistance measurement:
 - two- or three-lead method,
 - measurements with lead lengths up to 20 m,
 - automatic measurement of all resistance combinations of 3-, 4- and 5-core cords and power cords by means of the optional **AutoISO-5000** adapter (for MIC-10k1 at voltage up to 5 kV),
 - measurement of capacitance during measurement of R_{ISO'},
 - measurement of leakage current during measurement of R_{ISO'},
- » measurement with step voltage (SV),
- » dielectric discharge (DD) test,
- » damage location (burning function, current of **6 mA**),
- » low-voltage measurement of continuity using current of ≥200 mA (R_{CONT}).

Additional functions of the meters:

- » high immunity to disturbances - in compliance with standard EN 61326,
- » stable measurement in 765 kV substations
- » adjustable limits of minimum insulation resistance R_{ISO} and maximum resistance R_{CONT},
- » **temperature measurement (with the use of the optional ST-1 temperature probe)**,
- » measurement of direct and alternating voltages within the range of 0...750 V,
- » memory storing up to 10,000 results of each type of measurement, including descriptions of measurement points, objects, client names,
- » data transmission to PC via USB connection, Bluetooth® or capability of data transfer via USB flash drives,
- » easy-to-read, backlit 5.6" LCD graphic display,
- » backlit keyboard,
- » power supply from rechargeable battery packs or power grid,
- » charging during measurement,
- » the instrument meets the requirements laid down by standard EN 61557.

VIRTUAL INSTRUMENTS

We invite you to use the **virtual instruments** application. Thanks to it you can familiarize yourself with features of a selected device, its interface and capabilities.

The application gives you the opportunity to change the selected meter's configuration and perform measurements in a way you would in reality.

www.sonel.com › Knowledge Centre › Virtual instrument applications

Standard accessories:

L4 carrying case	WAFUTL4
Test lead 15 kV 3 m CAT IV 1000 V with crocodile clip, red	WAPRZ003REKRO15KV
Test lead 15 kV 3 m CAT IV 1000 V with crocodile clip, shielded, black	WAPRZ003BLKROE15KV
Test lead 15 kV 3 m CAT IV 1000 V with crocodile clip, blue	WAPRZ003BUKRO15KV
USB cable	WAPRZUSB
Mains cable with IEC C13 plug	WAPRZ1X8BLIEC
Factory calibration certificate	

Measurement of insulation resistance

Measuring range in compliance with EN 61557-2:

$$R_{ISOmin} = \frac{U_{ISOnom}}{I_{ISOmax}} = 5 \text{ M}\Omega \dots 40 \text{ T}\Omega \quad (I_{ISOmax} = 1.2 \text{ mA, 3 mA or } (6 \pm 15\%) \text{ mA})$$

Display range	Resolution	Accuracy
0...999 kΩ	1 kΩ	±(3% m.v. + 10 digits)
1.00...9.99 MΩ	0.01 MΩ	
10.0...99.9 MΩ	0.1 MΩ	
100...999 MΩ	1 MΩ	
1.00...9.99 GΩ	0.01 GΩ	
10.0...99.9 GΩ	0.1 GΩ	±(3.5% m.v. + 10 digits)
1.00...9.99 TΩ	0.01 TΩ	±(7.5% m.v. + 10 digits)
MIC-5050 10.0...20.0 TΩ	0.1 TΩ	±(12.5% m.v. + 10 digits)
MIC-10k1 10.0...40.0 TΩ		

Values of measured resistance depending on measuring voltage

Display range	Measuring range	Measuring range for AutoISO-5000
50 V	200 GΩ	20.0 GΩ
100 V	400 GΩ	40.0 GΩ
250 V	1.00 TΩ	100 GΩ
500 V	2.00 TΩ	200 GΩ
1000 V	4.00 TΩ	400 GΩ
2500 V	10.0 TΩ	400 GΩ
5000 V	20.0 TΩ	400 GΩ
MIC-10k1 10000 V	40.0 TΩ	-

Electrical safety:

- » type of insulation double, as per EN 61010-1 and EN 61557
- » measurement category CAT IV 600 V (CAT III 1000 V) according to EN 61010-1
- » housing protection rating according to EN 60529 IP40 (IP67 with closed housing cover)

Nominal operating conditions:

- » operating temperature range -20...+50°C
- » storage temperature -25...+70°C
- » humidity 20...90%
- » elevation above sea level ≤3000 m
- » reference temperature +23°C ± 2°C
- » reference humidity 40...60%

Other technical specifications:

- » power supply built-in LiFePO4 rechargeable battery 13.2 V 5.0 Ah from network: 90 V ÷ 260 V 50/60 Hz
- » weight approx. 6.1 kg
- » dimensions 390 x 308 x 172 mm
- » display graphic LCD 5.6"
- » transmission of results USB link or Bluetooth®

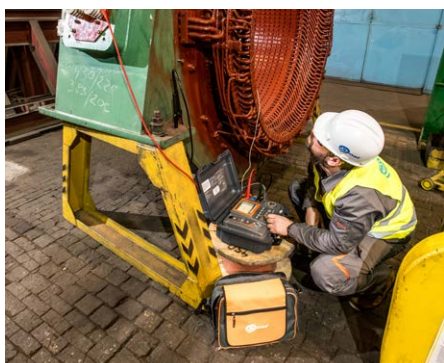

Professional diagnostic tool



Designed for the most demanding objects



Several measurements in one connection

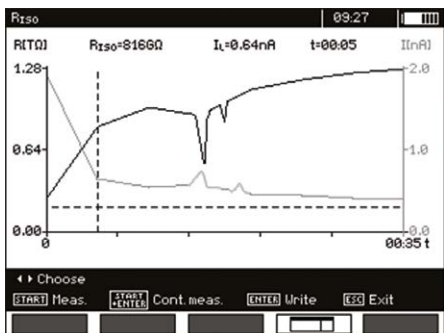

Graphic interpretation of results

Application

MIC-10k1 meter is designed to measure the insulation resistance of electro-power objects, i.e. single- and multi-core cables, transformers, motors and generators, capacitors, switches and other devices installed in power stations. Furthermore, it is dedicated for measurements in areas with very high electromagnetic disturbances, e.g. electrical substations with 765 kV voltage or higher.

Features of the device

Highly efficient HV inverter, with test voltage of 10 kV and current of 6 mA, suitable for measuring the insulation resistance up to 40 TΩ. Achieving such a result makes these meters unrivalled devices. Three-wire resistance measurement, performed using a "GUARD" wire, eliminates surface leakage currents caused by contaminated insulation, thereby increasing the reliability of obtained results.

The meter measures temperature of tested object, which is necessary to determine the temperature correction factor for R_{ISO} . In addition, it indicates the absorption coefficient (DAR - Dielectric Absorption Ratio), Polarization Index (PI) and the value of Dielectric Discharge (DD). The device allows user to assess the condition of the insulation, by applying the test voltage incrementally in steps (SV). This solution ensures that a dielectric in good condition will provide the same results, regardless of the applied voltage. Deviations in obtained resistance values of approx. 25%, observed on the chart in the individual steps, may indicate the potential insulation defects.

MIC-10k1 has the unique ability to perform measurements on multi-core cables, within one connection step, using the AutoISO-5000 adapter. This solution reduces the duration of measurements on repetitive of objects, such as cables of street lighting systems. Inverter with a power of almost 60 W is able to intensify the point of cable damage, which facilitates finding the location of the fault using a reflectometric method e.g. with TDR-420 device.

Built-in digital filters, with averaging time of 10, 30, 60, 100, 200 sec. and "smart" solution guarantee stable measurement results in areas of strong electromagnetic interference.

Data analysis

The device, with its backlight graphical screen may display a waveform of insulation resistance, voltage and current as a function of time. The operator, basing on the trend shown by the waveform, may quickly assess the insulation condition right after starting the measurement. This provides full control over the tested object and clear image of the tested insulation. In addition, with movable tags, the operator may trace the course of the measurement and check resistance values obtained for any time of the current measurement and of measurements made in the past.

After installing mobile application or Sonel Reader software, the user can collect historical data and compare it with current results, transferred from the extensive memory of the meter. This solution helps user to prepare a measurements report, track the insulation degradation and plan the maintenance / repair works.

Comparison of meters

	MIC-10k1	MIC-5050
maximum measuring voltage	10 000 V	5000 V
maximum measuring range	40 TΩ	20 TΩ
resistance to external interference voltages	up to 1550 V	up to 1550 V
advanced, digital interference filtration	10 / 30 / 60 / 100 / 200 seconds and SMART	10 / 30 / 60 / 100 / 200 seconds and SMART
test leads lock	✓	✓



Insulation resistance meters

SONEL MIC-5010 / MIC-5005

index: WMGBMIC5010 / WMGBMIC5005



15 TΩ
maximum
measurement
range

Measurement of insulation resistance:

- » measurement voltage selected within the range of **50...5000 V**: 50...1000 V selected in steps of 10 V, 1000 V...5000 V selected in steps of 25 V,
- » **remote start and stop of the measurement** via Sonel MIC Mobile application,
- » continuous reading of measured insulation resistance or leakage current,
- » automatic discharge of the measured object's capacitance upon completion of insulation resistance measurement,
- » sound signaling of five-second time intervals, facilitating capture of time characteristics,
- » measurement time setting - up to 99'59",
- » timing of measurement times T_1 , T_2 and T_3 for measurement of one or two absorption coefficients (Ab1, Ab2 or DAR, PI) within the range of 1...600 s,
- » reading of actual measurement voltage during measurement,
- » measurement current **1.2 mA** or **3 mA**,
- » protection against measurement of live objects,
- » digital filters for measurements with strong disturbances (**10 s, 30 s, 60 s**).

Measurement functions:

- » insulation resistance measurement:
 - two- or three-lead method,
 - measurements with lead lengths up to 20 m,
 - automatic measurement of all resistance combinations of 3-, 4- and 5-core cords and power cords by means of the optional **AutoISO-5000** adapter (for MIC-10k1 at voltage up to 5 kV),
 - measurement of capacitance during measurement of R_{ISO} ,
 - measurement of leakage current during measurement of R_{ISO} .
- » measurement with step voltage (SV),
- » dielectric discharge (DD) test,
- » **MIC-5010** | low-voltage measurement of continuity using current of ≥ 200 mA (R_{CONT}).

Additional functions of the meters:

- » high immunity to disturbances - in compliance with standard EN 61326,
- » adjustable limits of minimum insulation resistance R_{ISO} and maximum resistance R_{CONT}
- » measurement of direct and alternating voltages within the range of 0...600 V,
- » 990-cell memory (11,880 entries) with the capability of wireless data transmission to a PC (via Bluetooth® or via USB cable),
- » power supply from rechargeable battery packs, built-in quick charger,
- » backlit keyboard and display,
- » instruments meet the requirements laid down by standard EN 61557.

Electrical safety:

- » type of insulation double, as per EN 61010-1 and EN 61557
- » measurement category CAT IV 600 V (CAT III 1000 V) according to EN 61010-1
- » housing protection rating according to EN 60529 IP40 (IP67 with closed housing cover)

Nominal operating conditions:

- » operating temperature range -20...+50°C
- » storage temperature -25...+70°C
- » humidity 20%...90%
- » elevation above sea level ≤ 3000 m
- » reference temperature +23°C \pm 2°C
- » reference humidity 40...60%

Other technical specifications:

- » power supply of the meter built-in LiFePO4 rechargeable battery 13.2 V 5.0 Ah
- » weight approx. 6.0 kg
- » dimensions 390 x 308 x 172 mm
- » display segmented LCD
- » transmission of results USB link or Bluetooth®

Standard accessories:

L4 carrying case	WAFUTL4
Crocodile clip, black, 11 kV, 32 A	WAKROBL32K09
Crocodile clip, red, 11 kV, 32 A	WAKRORE32K09
Crocodile clip, blue, 11 kV, 32 A	WAKROBU32K09
Test lead 1.8 m, black, 11 kV (banana plugs, shielded)	WAPRZ1X8BLBBE10K
Test lead 1.8 m, red, 11 kV (banana plugs)	WAPRZ1X8REBB10K
Test lead 1.8 m, blue, 11 kV (banana plugs)	WAPRZ1X8BUBB10K
USB cable	WAPRZUSB
Mains cable with IEC C13 plug	WAPRZ1X8BLIEC
Pin probe, black 11 kV (banana socket)	WASONBLOGB11
Pin probe, red 11 kV (banana socket)	WASONREOGB11
W1 hanging straps	WAPOZSZE5
Factory calibration certificate	

Measurement of insulation resistance

Measuring range in compliance with EN 61557-2:

$$R_{ISOmin} = U_{ISOnom} / I_{ISOmax} = 50 \text{ k}\Omega \dots 15 \text{ T}\Omega \quad (I_{ISOmax} = 1.2 \text{ mA or } 3 \text{ mA})$$

Display range	Resolution	Accuracy
0...999 kΩ	1 kΩ	±(3% m.v. + 10 digits)
1.00...9.99 MΩ	0.01 MΩ	
10.0...99.9 MΩ	0.1 MΩ	
100...999 MΩ	1 MΩ	
1.00...9.99 GΩ	0.01 GΩ	
10.0...99.9 GΩ	0.1 GΩ	±(3.5% m.v. + 10 digits)
100...999 GΩ	1 GΩ	
1.00...9.99 TΩ	0.01 TΩ	±(7.5% m.v. + 10 digits)
10.0...15.0 TΩ	0.1 TΩ	

- » Temperature stability of voltage better than 0.2% /°C



The MIC-10k1, MIC-5050, MIC-5010 and MIC-5005 meters are capable of operating in the presence of very large disturbances at substations and switching stations.

Values of measured resistance depending on measuring voltage

Voltage	Measured resistance
250 V	500 GΩ
500 V	1.00 TΩ
1000 V	2.00 TΩ
2500 V	5.00 TΩ
5000 V	15.0 TΩ

MIC-5010 | Test of the continuity of protective conductors and equipotential bonding with current >200 mA

Measuring range according to EN 61557-4: 0.12...999 Ω

Display range	Resolution	Accuracy
0.00...19.99 Ω	0.01 Ω	±(2% m.v. + 3 digits)
20.0...199.9 Ω	0.1 Ω	
200...999 Ω	1 Ω	±(4% m.v. + 3 digits)

- » Voltage on open terminals: 4...24 V
- » Output current at $R < 15 \Omega$: $I_{min} > 200$ mA (I_{sc} : 200...250 mA)
- » Compensation of test lead resistance
- » Current flows in two directions, mean resistance value displayed

Capacitance measurement

Display range	Resolution	Accuracy
1...999 nF	1 nF	±(5% m.v. + 5 digits)
1.00...49.99 μF	0.01 μF	

- » Capacitance measurement result displayed after measurement of R_{ISO}

"m.v." = "measured value"

Instruments meet the requirements set forth in the standards:

- » EN 61010-1 (general and particular requirements related to safety)
- » EN 61010-031 (general and particular requirements related to safety)
- » EN 61326 (electromagnetic compatibility)
- » EN 61557 (requirements for measurement instruments)
- » HD 60364-6 (performance of measurements - checking)
- » HD 60364-4-41 (performance of measurements - shock protection)
- » PN-E 04700 (performance of measurements - commissioning tests)

Insulation resistance meter

SONEL MIC-5001

index: WMGBMIC5001



CAT III

600 V

CAT IV

300 V

IP65

Measurement of insulation resistance:

- » measurement voltage within the range of **50...5000 V**: 50...500 V selected in steps of 50 V, 500...5000 V selected in steps of 100 V,
- » continuous reading of measured insulation resistance or leakage current,
- » automatic discharge of the measured object's capacitance upon completion of insulation resistance measurement,
- » sound signaling of five-second time intervals, facilitating capture of time characteristics,
- » timing of measurement times T_1 , T_2 and T_3 for measurement of one or two absorption coefficients (Ab1, Ab2 or DAR, PI) within the range of 1... 600 s,
- » reading of actual measurement voltage during measurement,
- » measurement current **1.5 mA**,
- » protection against measurement of live objects,
- » two- or three-lead method of insulation resistance measurement.

Measurement functions:

- » insulation resistance measurement:
 - two- or three-lead method,
 - measurement of leakage current during measurement of R_{ISO}
- » measurement with RampTest (RT) method.

Additional functions of the meter:

- » measurement of direct and alternating voltages within the range of 0...750 V,
- » 990-cell memory (11,880 entries), data transmission to PC via USB cable,
- » power supplied by rechargeable battery,
- » the meter can be powered and charged from an external power adapter or from a car lighter socket,
- » backlit display,
- » instruments meet the requirements laid down by standard EN 61557.

Electrical safety:

- » type of insulation double, as per EN 61010-1 and IEC 61557
- » measurement category CAT IV 600 V (CAT III 1000 V) according to EN 61010-1
- » housing protection rating according to EN 60529 IP65

Other technical specifications:

- » power supply of the meter SONEL NiMH LSD 9.6 V 2 Ah rechargeable battery pack
..... 12 V, 2.5 A external power supply
- » meter weight approx. 0.9 kg
- » dimensions 200 x 180 x 77 mm
- » display segmented LCD
- » memory 990 cells, 11,880 entries
- » transmission of results insulated USB cable
- » operating humidity 20...90%

Standard accessories:

M-8 carrying case	WAFUTM8
Black "crocodile" clip 11 kV 32 A	WAKROBL32K09
Red "crocodile" clip 11 kV 32 A	WAKRORE32K09
Blue "crocodile" clip 11 kV 32 A	WAKROBU32K09
Shielded test lead with banana plugs; 5 kV; 1.8 m; black	WAPRZ1X8BLBB
Test lead with banana plugs; 5 kV; 1.8 m; red	WAPRZ1X8REBB
Test lead with banana plugs; 5 kV; 1.8 m; blue	WAPRZ1X8BUBB
USB data transmission cable	WAPRZUSB
230 V power cord (IEC C7 plug)	WAPRZLAD230
Test probe with banana socket; 5 kV; black	WASONBLOGB2
Test probe with banana socket; 5 kV; red	WASONREOGB2
Meter power adapter (type Z7)	WAZASZ7
Factory calibration certificate	

Insulation resistance measurement (two-lead)

Measuring range according to IEC 61557-2:

$$R_{ISOmin} = \frac{U_{ISOnom}}{I_{ISOmax}} \leq 5 T \Omega \quad (I_{ISOmax} = 1 \text{ mA})$$

Display range	Resolution	Accuracy
0.0...999.9 kΩ	0.1 kΩ	±(3% m.v. + 20 digits)
1.000...9.999 MΩ	0.001 MΩ	
10.00...99.99 MΩ	0.01 MΩ	
100.0...999.9 MΩ	0.1 MΩ	
1.000...9.999 GΩ	0.001 GΩ	
10.00...99.99 GΩ	0.01 GΩ	±(4% m.v. + 50 digits)
100.0...999.9 GΩ	0.1 GΩ	
1.000...5.000 TΩ	1 GΩ	

Measured resistance values depending on measurement voltage

Voltage U_{ISO}	Measuring range
up to 100 V	50 GΩ
200...400 V	100 GΩ
500...900 V	250 GΩ
1000...2400 V	500 GΩ
2500 V	2500 GΩ
5000 V	5000 GΩ

Insulation resistance measurement in Ramp Test mode

Display range	Resolution	Accuracy
0.0...999.9 kΩ	0.1 kΩ	±(5% m.v. + 40 digits)
1.000...9.999 MΩ	0.001 MΩ	
10.00...99.99 MΩ	0.01 MΩ	
100.0...999.9 MΩ	0.1 MΩ	
1.000...9.999 GΩ	0.001 GΩ	
10.00...99.99 GΩ	0.01 GΩ	
100.0...999.9 GΩ	0.1 GΩ	
1.000...4.999 TΩ	0.001 TΩ	

Breakdown voltage measurement in Ramp Test mode

Range	Resolution	Selected U_{ISO}	Accuracy
25.0...99.0 V	0.1 V	≤600 V	±(5% m.v. + 10 digits)
100 ... 600 V	1 V	≤600 V	±(5% m.v. + 4 digits)
25 ... 999 V	1 V	>600 V	±(5% m.v. + 5 digits)
1.00 ... 5.00 kV	10V	>600 V	±(5% m.v. + 4 digits)

Measurement of direct and alternating voltage

Range	Resolution	Accuracy
0...299.9 V	0.1 V	±(3% m.v. + 2 digits)
300...750 V	1 V	

- » frequency range: 45...65 Hz



Insulation resistance meter

SONEL MIC-2511

index: WMGBMIC2511



5.6"

touch screen

CAT III

1000 V

CAT IV

600 V

IP65

Li-Ion BATTERY

Measurement of insulation resistance:

- » measurement voltage within the range of **10...2500 V**: selected from 10 V, 25 V, 100 V, 250 V, 500 V, 1000 V, 2500 V or 10...2500 V selected in steps of 10 V,
- » insulation resistance measurements with a voltage of 10 V of the supervisory loop of fire alarm systems,
- » **charts plotted on display during measurements,**
- » **correction of insulation resistance result to reference temperature,**
- » continuous reading of measured insulation resistance or leakage current,
- » automatic discharge of the measured object's capacitance upon completion of insulation resistance measurement,
- » sound signaling of five-second time intervals, facilitating capture of time characteristics,
- » timing of measurement times T_1 , T_2 and T_3 for measurement of one or two absorption coefficients (Ab1, Ab2 or DAR, PI) within the range of 1... 600 s,
- » reading of actual measurement voltage during measurement,
- » measurement current ≤ 2 mA,
- » protection against measurement of live objects.

Measurement functions:

- » visual test,
- » insulation resistance measurement:
 - two- or three-lead method,
 - automatic measurement of all resistance combinations of 3-, 4- and 5-core cords and power cords by means of the optional **AutoISO-2511** adapter,
 - capacitance measurement during measurement of R_{ISO} ,
 - measurement of leakage current during measurement of R_{ISO}
- » measurement with step voltage (SV),
- » dielectric discharge (DD) test,
- » measurement with RampTest (RT) method,
- » measurements in electrostatic protected areas (EPA),
- » separate functions for measuring DAR (R_{50} 60 s) and PI (R_{50} 600 s) coefficients,
- » low-voltage measurement of continuity using current of ≥ 200 mA (R_{CONT}),
- » low-voltage measurement of resistance (R_X).

Additional functions of the meter:

- » adjustable limits of minimum and maximum resistance,
- » **temperature measurement (with the use of the optional ST-1 temperature probe),**
- » measurement of direct and alternating voltages within the range of 0...1500 V,
- » 9999-entry memory, data transmission to PC via USB cable,
- » power supplied by rechargeable battery,
- » backlit keyboard,
- » the instrument meets the requirements laid down by standard EN 61557.

Electrical safety:

- » type of insulation double, as per EN 61010-1 and EN 61557
- » measurement category CAT IV 600 V (CAT III 1000 V) according to EN 61010-1
- » housing protection rating according to EN 60529 IP65

Other technical specifications:

- » power supply of the meter Li-Ion 10.8 V 3.5 Ah rechargeable battery
- » weight ca. 1.3 kg
- » dimensions 234 x 169 x 70 mm
- » display LCD TFT 5,6" 800 x 480
- » memory 9999 entries
- » transmission of results USB

Standard accessories:

Li-Ion 10.8 V 3.5 Ah rechargeable battery	WAAKU29
M-6 carrying case	WAFUTM6
Black "crocodile" clip 11 kV 32 A	WAKROBL32K09
Red "crocodile" clip 11 kV 32 A	WAKRORE32K09
Blue "crocodile" clip 11 kV 32 A	WAKROBU32K09
Shielded test lead with banana plugs; 5 kV; 1.8 m; black	WAPRZ1X8BLBB
Test lead with banana plugs; 5 kV; 1.8 m; red	WAPRZ1X8REBB
Test lead with banana plugs; 5 kV; 1.8 m; blue	WAPRZ1X8BUBB
USB data transmission cable	WAPRZUSB
230 V power cord (IEC C7 plug)	WAPRZLAD230
Test probe with banana socket; 5 kV; black	WASONBLOGB2
Test probe with banana socket; 5 kV; red	WASONREOGB2
Hanging strap	WAPOZPAS6
Type C USB cable	WAPRZUSBC
Meter power adapter (type Z32)	WAZASZ32
Factory calibration certificate	

Measurement of insulation resistance

Measuring range acc. to EN 61557-2 for $R_{ISOmin} = \frac{U_{ISOnom}}{I_{ISOmax}} \leq 2 T\Omega$
 $(I_{ISOmax} = 1.6 \text{ mA})$

Display range	Resolution	Accuracy
0.0...999.9 kΩ	0.1 kΩ	±(3% m.v. + 20 digits)
1.000...9.999 MΩ	0.001 MΩ	
10.00...99.99 MΩ	0.01 MΩ	
100.0...999.9 MΩ	0.1 MΩ	
1.000...9.999 GΩ	0.001 GΩ	
10.00...99.99 GΩ	0.01 GΩ	
100.0...999.9 GΩ	0.1 GΩ	
1.000...2.000 TΩ	0.001 TΩ	

Values of measured resistance depending on measuring voltage

Voltage	Measured resistance
10 V	10 GΩ
25 V	20 GΩ
50 V	50 GΩ
100 V	100 GΩ
250 V	250 GΩ
500 V	500 GΩ
1000 V	1,00 TΩ
2500 V	2,00 TΩ

Capacitance measurement

Display range	Resolution	Accuracy
0...999 nF	1 nF	±(5% m.v. + 5 digits)
1.00...9.99 μF	0.01 μF	

Test of the continuity of protective conductors and equipotential bonding with 200 mA current

Measuring range according to EN 61557-4: 0.10...999 Ω

Display range	Resolution	Accuracy
0.00...19.99 Ω	0.01 Ω	±(2% m.v. + 3 digits)
20.0...199.9 Ω	0.1 Ω	
200...999 Ω	1 Ω	±(4% m.v. + 3 digits)

Measurement of direct and alternating voltage

Display range	Resolution	Accuracy
0...1500 V	1 V	±(3% m.v. + 2 digits)

- » frequency range: 45...65 Hz



SONEL MIC-2501

index: WMGBMIC2501



CAT IV	CAT III	IP65
600 V	1000 V	

Measurement of insulation resistance:

- » measurement voltage within the range of **100...2500 V**: 100...2500 V selected in steps of 100 V,
- » continuous reading of measured insulation resistance or leakage current,
- » automatic discharge of the measured object's capacitance upon completion of insulation resistance measurement,
- » sound signaling of five-second time intervals, facilitating capture of time characteristics,
- » timing of measurement times T_1 , T_2 and T_3 for measurement of one or two absorption coefficients (Ab1, Ab2 or DAR, PI) within the range of 1... 600 s,
- » reading of actual measurement voltage during measurement,
- » measurement current **1 mA**,
- » protection against measurement of live objects.

Measurement functions:

- » insulation resistance measurement:
 - two- or three-lead method,
 - measurement of leakage current during measurement of R_{ISO}
- » low-voltage measurement of continuity using current of ≥ 200 mA (R_{CONT}).

Additional functions of the meter:

- » measurement of direct and alternating voltages within the range of 0...750 V,
- » 990-cell memory (11,880 entries), data transmission to PC via USB cable,
- » power supplied by rechargeable battery,
- » the meter can be powered and charged from an external power adapter or from a car lighter socket,
- » backlit display,
- » the instrument meets the requirements laid down by standard EN 61557.

Electrical safety:

- » type of insulation double, as per EN 61010-1 and EN 61557
- » measurement category CAT IV 600 V (CAT III 1000 V) according to EN 61010-1
- » housing protection rating according to EN 60529 IP65

Other technical specifications:

- » power supply of the meter SONEL NiMH LSD 9.6 V rechargeable battery pack external power supply 12 V, 2.5 A
- » meter weight approx. 0.9 kg
- » dimensions 200 x 180 x 77 mm
- » display segmented LCD
- » memory 990 cells, 11,880 entries
- » transmission of results USB

Standard accessories:

M-8 carrying case	WAFUTM8
Black "crocodile" clip 11 kV 32 A	WAKROBL32K09
Red "crocodile" clip 11 kV 32 A	WAKRORE32K09
Blue "crocodile" clip 11 kV 32 A	WAKROBU32K09
Shielded test lead with banana plugs; 5 kV; 1.8 m; black	WAPRZ1X8BLBB
Test lead with banana plugs; 5 kV; 1.8 m; red	WAPRZ1X8REBB
Test lead with banana plugs; 5 kV; 1.8 m; blue	WAPRZ1X8BUBB
USB data transmission cable	WAPRZUSB
230 V power cord (IEC C7 plug)	WAPRZLAD230
Test probe with banana socket; 5 kV; black	WASONBLOGB2
Test probe with banana socket; 5 kV; red	WASONREOGB2
Meter power adapter (type Z7)	WAZASZ7
Factory calibration certificate	

Measurement of insulation resistance

Measuring range acc. to EN 61557-2 for $R_{ISOmin} = \frac{U_{ISOmax}}{I_{ISOmax}} \leq 1 T\Omega$
 ($I_{ISOmax} = 1$ mA)

Display range	Resolution	Accuracy
0.0...999.9 kΩ	0.1 kΩ	±(3% m.v. + 20 digits)
1.000...9.999 MΩ	0.001 kΩ	
10.00...99.99 MΩ	0.01 kΩ	
100.0...999.9 MΩ	0.1 kΩ	
1.000...9.999 GΩ	0.001 GΩ	
10.00...99.99 GΩ	0.01 GΩ	
100.0...999.9 GΩ	0.1 GΩ	

"m.v." = "measured value"

U_{ISO} - measurement voltage.

Values of measured resistance depending on measuring voltage

Voltage	Measured resistance
up to 100 V	50 GΩ
200...400 V	100 GΩ
500...900 V	250 GΩ
1000...2400 V	500 GΩ
2500 V	1000 GΩ



You can charge the meter during the measurement using any Power Bank 12 V / 2 Ah with a 5.5 mm / 2.1 mm power supply.

Test of the continuity of protective conductors and equipotential bonding with 200 mA current

Measuring range according to EN 61557-4: 0.10...999 Ω

Display range	Resolution	Accuracy
0.00...19.99 Ω	0.01 Ω	±(2% m.v. + 3 digits)
20.0...199.9 Ω	0.1 Ω	
200...999 Ω	1 Ω	±(4% m.v. + 3 digits)

- » Voltage on open terminals: 4...24 V
- » Output current at $R < 2 \Omega$: $I_{SC} > 200$ mA
- » Compensation of test lead resistance
- » Current flows in two directions, mean resistance value displayed

Measurement of direct and alternating voltage

Display range	Resolution	Accuracy
0...299.9 V	0.1 V	±(3% m.v. + 2 digits)
300...750 V	1 V	

- » frequency range: 45...65 Hz

Insulation resistance meter

SONEL MIC-30

index: WMGBMIC30



CAT III

1000 V

CAT IV

600 V

IP67

BLUETOOTH

Measurement of insulation resistance:

- » measurement voltage within the range of **50...1000 V**: selected from 50, 100, 250, 500, 1000 V or 50...1000 V selected in steps of 10 V,
- » continuous reading of measured insulation resistance or leakage current,
- » automatic discharge of the measured object's capacitance upon completion of insulation resistance measurement,
- » sound signaling of five-second time intervals, facilitating capture of time characteristics,
- » timing of measurement times T_1 , T_2 and T_3 for measurement of one or two absorption coefficients (Ab1, Ab2 or DAR, PI) within the range of 1... 600 s,
- » readings of actual measurement voltage during measurement,
- » measurement current **1 mA**,
- » protection against measurement of live objects.

Measurement functions:

- » insulation resistance measurement:
 - two- or three-lead method,
 - automatic measurement in sockets by means of UNI-Schuko adapter with the capability of configuring pairs of measured conductors,
 - capacitance measurement during measurement of R_{ISO} ,
 - measurement of leakage current during measurement of R_{ISO} ,
- » low-voltage measurement of continuity using current of ≥ 200 mA (R_{CONT}),
- » low-voltage measurement of resistance (R_X).

Additional functions of the meter:

- » measurement of direct and alternating voltages within the range of 0...600 V,
- » 990-cell memory (11,880 entries) with the capability of wireless data transmission to a PC via Bluetooth®,
- » backlit keyboard and display,
- » the instrument meets the requirements laid down by standard EN 61557.

Other technical specifications:

- » type of insulation double, as per EN 61010-1 and EN 61557
- » power supply of the meter 4 LR6 batteries or Ni-MH AA rechargeable batteries
- » display segmented LCD

The instrument meets the requirements set forth in the standards:

- » EN 61010-1 (general and particular requirements related to safety)
- » EN 61010-031 (general and particular requirements related to safety)
- » EN 61326 (electromagnetic compatibility)
- » EN 61557 (requirements for measurement instruments)
- » HD 60364-6 (performance of measurements - checking)
- » HD 60364-4-41 (performance of measurements - shock protection)
- » PN-E 04700 (performance of measurements - commissioning tests)



MIC-30 makes it possible to perform automatic resistance measurement for all combinations or for any pair of conductors in the socket.

Standard accessories:

M-6 carrying case	WAFUTM6
Blue "crocodile" clip 1 kV 20 A	WAKROBU20K02
Shielded test lead with banana plugs; 1 kV; 1.2 m; black	WAPRZ1X2BLBBE
Test lead with banana plugs; 1 kV; 1.2 m; red	WAPRZ1X2REBB
Test lead with banana plugs; 1 kV; 1.2 m; blue	WAPRZ1X2BUBB
Test probe with banana socket; 1 kV; black	WASONBLOGB1
Test probe with banana socket; 1 kV; red	WASONREOGB1
Meter strap (type M-1)	WAPOZSZE4
M-1 housing holder - hanger	WAPOZUCH1

Factory calibration certificate

Measurement of insulation resistance

Measuring range according to EN 61557-2 for

- » $U_n=50$ V: **50 kΩ...250.0 MΩ**
- » $U_n=100$ V: **100 kΩ...500.0 MΩ**
- » $U_n=250$ V: **250 kΩ...2.000 GΩ**
- » $U_n=500$ V: **500 kΩ...20.00 GΩ**
- » $U_n=1000$ V: **1000 kΩ...100.0 GΩ**

Display range	Resolution	Accuracy
0.0...999.9 kΩ	0.1 kΩ	±(3% m.v. + 8 digits) [±(5% m.v. + 8 digits)]*
1.000...9.999 MΩ	0.001 MΩ	
10.00...99.99 MΩ	0.01 MΩ	
100.0...250.0 MΩ $U_n = 50$ V	0.1 MΩ	±(4% m.v. + 6 digits) [±(6% m.v. + 6 digits)]*
100.0...500.0 MΩ $U_n \geq 100$ V		
100.0...999.9 MΩ $U_n \geq 250$ V	0.001 GΩ	±(4% m.v. + 6 digits) [±(6% m.v. + 6 digits)]*
1.000...2.000 GΩ $U_n = 250$ V		
1.000...9.999 GΩ $U_n \geq 500$ V	0.001 GΩ	±(4% m.v. + 6 digits) [±(6% m.v. + 6 digits)]*
10.00...20.00 GΩ $U_n \geq 500$ V**	0.01 GΩ	
10.00...99.99 GΩ $U_n = 1000$ V		0.1 GΩ
100.0 GΩ $U_n = 1000$ V		

*for WS-04 adapter

**for WS-04 adapter, range up to 10 GΩ

- » measurements with voltage up to 500 V for WS-04 lead

Capacitance measurement

Display range	Resolution	Accuracy
1...999 nF	1 nF	±(5% m.v. + 10 digits)
1.00...9.99 μF	0.01 μF	

- » Capacitance measurement result displayed after measurement of R_{ISO}
- » For measurement voltages below 100 V and measured resistance of less than 10 MΩ, the error of capacitance measurement is unspecified

Test of the continuity of protective conductors and equipotential bonding with 200 mA current

Measuring range according to EN 61557-4: 0.10...1999 Ω

Display range	Resolution	Accuracy
0.00...19.99 Ω	0.01 Ω	±(2% m.v. + 3 digits)
20.0...199.9 Ω	0.1 Ω	
2000...1999 Ω	1 Ω	±(4% m.v. + 3 digits)

SONEL MIC-10

index: WMGBMIC10



- CAT III**
- 1000 V**
- CAT IV**
- 600 V**
- IP67**

Measurement of insulation resistance:

- » measurement voltage within the range of **50...1000 V**: selected from 50, 100, 250, 500, 1000 V,
- » continuous reading of measured insulation resistance,
- » automatic discharge of the measured object's capacitance upon completion of insulation resistance measurement,
- » sound signaling of five-second time intervals, facilitating capture of time characteristics,
- » readings of actual measurement voltage during measurement,
- » measurement current **1 mA**,
- » protection against measurement of live objects.

Measurement functions:

- » insulation resistance measurement:
 - two- or three-lead method,
 - capacitance measurement during measurement of R_{iso}
- » low-voltage measurement of continuity using current of ≥ 200 mA (R_{cont}),
- » low-voltage measurement of resistance (R_x).

Additional functions of the meter:

- » measurement of direct and alternating voltages within the range of 0...600 V,
- » backlit keyboard and display,
- » the instrument meets the requirements laid down by standard EN 61557.



Besides measuring insulation resistance, MIC-10 is capable of performing continuity tests of protective conductors and equipotential bonding in accordance with standard EN 61557.

The instrument meets the requirements set forth in the standards:

- » EN 61010-1 (general and particular requirements related to safety)
- » EN 61010-031 (general and particular requirements related to safety)
- » EN 61326 (electromagnetic compatibility)
- » EN 61557 (requirements for measurement instruments)
- » HD 60364-6 (performance of measurements - checking)
- » HD 60364-4-41 (performance of measurements - shock protection)
- » PN-E 04700 (performance of measurements - commissioning tests)

Other technical specifications:

- » type of insulation double, as per EN 61010-1 and EN 61557
- » power supply of the meter 4 alkaline batteries or Ni-MH rechargeable batteries - size AA
- » display segmented LCD

Standard accessories:

M-6 carrying case	WAFUTM6
Black "crocodile" clip 1 kV 20 A	WAKROBL20K01
Test lead with banana plugs; 1 kV; 1.2 m; black	WAPRZ1X2BLBB
Test lead with banana plugs; 1 kV; 1.2 m; red	WAPRZ1X2REBB
Test probe with banana socket; 1 kV; black	WASONBLOGB1
Test probe with banana socket; 1 kV; red	WASONREOGB1
Meter strap (type M-1)	WAPOZSZE4
M-1 housing holder - hanger	WAPOZUCH1
Factory calibration certificate	

Measurement of insulation resistance

Measuring range according to EN 61557-2 for

- » $U_n = 50$ V: **50 kΩ...250.0 MΩ**
- » $U_n = 100$ V: **100 kΩ...500.0 MΩ**
- » $U_n = 250$ V: **250 kΩ...2.000 GΩ**
- » $U_n = 500$ V: **500 kΩ...5.000 GΩ**
- » $U_n = 1000$ V: **1000 kΩ...10.00 GΩ**

Display range	Resolution	Accuracy
0.0...999.9 kΩ	0.1 kΩ	±(3% m.v. + 8 digits)
1.000...9.999 MΩ	0.001 MΩ	
10.00...99.99 MΩ	0.01 MΩ	
100.0...250.0 MΩ $U_n = 50$ V	0.1 MΩ	±(4% m.v. + 6 digits)
100.0...500.0 MΩ $U_n = 100$ V		
100.0...999.9 MΩ $U_n \geq 250$ V		
1.000...2.000 GΩ $U_n = 250$ V	0.001 GΩ	±(4% m.v. + 6 digits)
1.000...5.000 GΩ $U_n = 500$ V	0.001 GΩ	
1.000...9.999 GΩ $U_n = 1000$ V	0.01 GΩ	
10.00 GΩ $U_n = 1000$ V	0.01 GΩ	

Capacitance measurement

Display range	Resolution	Accuracy
1...999 nF	1 nF	±(5% m.v. + 10 digits)
1.00...9.99 μF	0.01 μF	

- » Capacitance measurement result displayed after measurement of R_{iso}
- » For measurement voltages below 100 V and measured resistance of less than 10 MΩ, the error of capacitance measurement is unspecified.

Test of the continuity of protective conductors and equipotential bonding with 200 mA current

Measuring range according to EN 61557-4: 0.10...1999 Ω

Display range	Resolution	Accuracy
0.00...19.99 Ω	0.01 Ω	±(2% m.v. + 3 digits)
20.0...199.9 Ω	0.1 Ω	
2000...1999 Ω	1 Ω	±(4% m.v. + 3 digits)

Insulation resistance meter

SONEL MIC-5

index: WMGBMIC5



CAT III

1000 V

CAT IV

600 V

IP65

BUILT-IN FLASHLIGHT

Measurement of insulation resistance:

- » measurement voltage within the range of **250...500 V**: selected from 250, 500 V,
- » continuous indication of measured resistance,
- » automatic discharge of tested object's capacitance after measurement of insulation resistance,
- » sound signaling of five-second time intervals, facilitating capture of time characteristics,
- » measurement current **up to 1.4 mA**,
- » protection against measurement of live objects.

Measurement functions:

- » insulation resistance measurement using two-lead method,
- » low-voltage measurement of resistance (R_x).

Additional functions of the meter:

- » measurement of direct and alternating voltages within the range of 0...600 V,
- » backlit display,
- » the instrument meets the requirements laid down by standard EN 61557.

The instrument meets the requirements set forth in the standards:

- » EN 61010-1 (general and particular requirements related to safety)
- » EN 61010-031 (general and particular requirements related to safety)
- » EN 61326 (electromagnetic compatibility)
- » EN 61557 (requirements for measurement instruments)
- » HD 60364-6 (performance of measurements - checking)
- » HD 60364-4-41 (performance of measurements - shock protection)
- » PN-E 04700 (performance of measurements - commissioning tests)

Other technical specifications:

- » type of insulation double, as per EN 61010-1 and EN 61557
- » power supply of the meter ... 2 LR03 alkaline batteries or Ni-MH rechargeable batteries - size AAA
- » display segmented LCD



Standard accessories:

Φ4 mm screw tip (set of 4 pcs.)	WAPOZN4MMK
4 mm applied tip (set of 2 pcs.)	WAPOZO4MMK
2x AAA / LR03 alkaline battery	
Declaration of verification	

Measurement of insulation resistance

Measuring range according to EN 61557-2 for

- » $U_n=250\text{ V}$: **250 kΩ...1.000 GΩ**
- » $U_n=500\text{ V}$: **500 kΩ...1.999 GΩ**

Display range	Resolution	Accuracy
1...249 kΩ $U_n = 250\text{ V}$ 1...499 kΩ $U_n = 500\text{ V}$	1 kΩ	not defined
250...1999 kΩ $U_n = 250\text{ V}$ 500...1999 kΩ $U_n = 500\text{ V}$	1 kΩ	±(3% m.v. + 8 digits)
2.00...19,99 MΩ	0.01 MΩ	
20.0...199,9 MΩ	0.1 MΩ	
200...1000 MΩ $U_n = 250\text{ V}$ 200...1999 MΩ $U_n = 500\text{ V}$	1 MΩ	

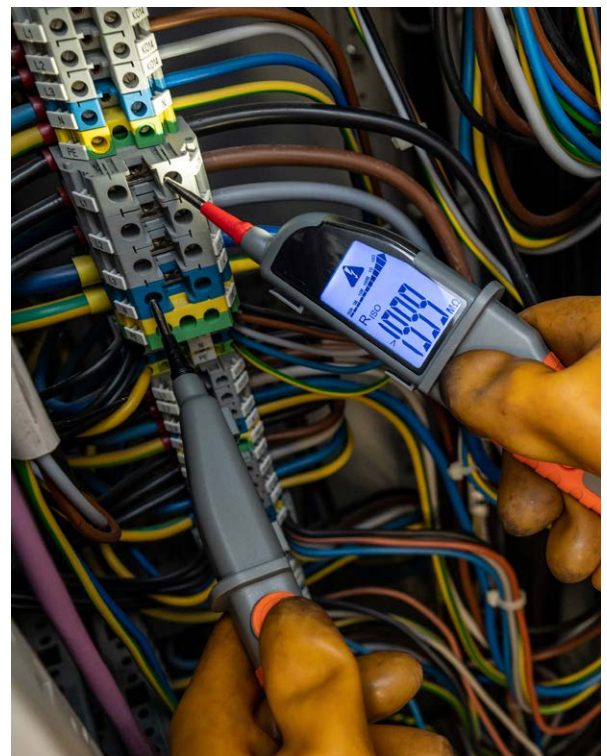

SONEL MIC-RS

index: WMGBMICRS

CAT II

1000 V



Measurement of insulation resistance:

- » measurement voltage within the range of **500...1000 V**: selected from 500, 1000 V,
- » automatic discharge of tested object's capacitance after measurement of insulation resistance,
- » measurement current **up to 2 mA**,
- » protection against measurement of live objects.

Measurement functions:

- » insulation resistance measurement using two-lead method,
- » low-voltage measurement of resistance (R_x).

The instrument meets the requirements set forth in the standards:

- » EN 61010-1 (general and particular requirements related to safety)
- » EN 61010-031 (general and particular requirements related to safety)
- » EN 61326 (electromagnetic compatibility)
- » EN 61557 (requirements for measurement instruments)
- » HD 60364-6 (performance of measurements - checking)
- » HD 60364-4-41 (performance of measurements - shock protection)
- » PN-E 04700 (performance of measurements - commissioning tests)

Other technical specifications:

- » type of insulation basic, as per EN 61010-1 and EN 61557
- » power supply of the meter external, isolated, 24 V DC

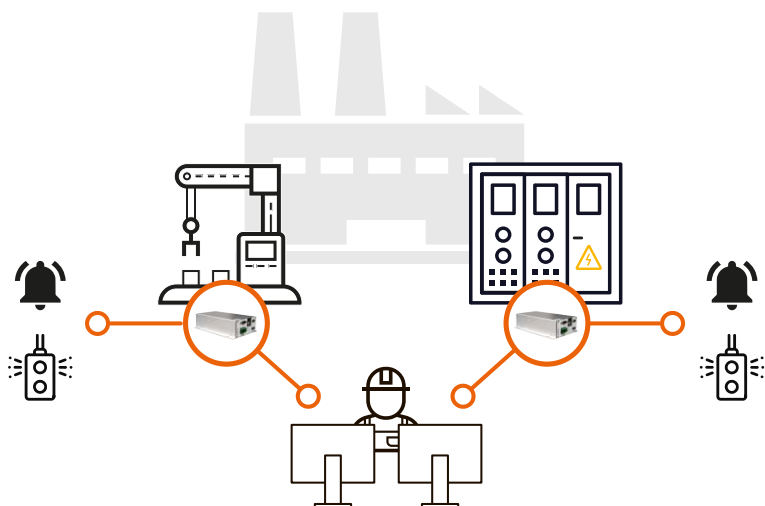

Standard accessories:

Factory calibration certificate	
---------------------------------	--

Application

The instrument is dedicated for companies and sites, in which continuous or random assessment of the insulation resistance is required as part of production. It is also perfect for automated production systems.

The meter can be installed in the distribution board, at the operator's station (assembly or quality control bench), in the control cabinet or even in the rack enclosure. The measurement is performed by means of clamps, used to connect the test leads of the system, in which the instrument is installed.

Features

The meter is designed for building in/permanent installation. It plays a Secondary/Slave role, meaning that it executes the commands issued by the Main/Master control device and it does not initialise the transmission on its own. It enables measuring the insulation resistance with the test voltage of up to 1000 V.

The scope set of functions of the meter is tailored to specialised applications. With the **AutoRange** function, available in two versions, the instrument can switch the test voltage dynamically and adjust it to the current conditions.

There are two measurement modes available: **automatic** (continuous) and **manual** (one-time). Under automated testing, the meter can be programmed to measure the capacity or not. In addition, **the user may define the default function** of the device as the measurement of insulation resistance (R_{iso}), or low resistance (R_x).

Response and communication

The functionality of the instrument is extended by digital input and output. This enables the meter to respond to the events in the system, in which it operates.

The meter is operated from the Main/Master control device by means of the **MIC-RS-SCP serial communication protocol**. It enables, for example, starting and stopping the measurement of resistance, reading the measurement result or changing the configuration of the instrument.

Measurement of insulation resistance

Measuring range according to EN 61557-2 for

- » $U = 500 \text{ V}$: **500 k Ω ...2.00 G Ω**
- » $U_n = 1000 \text{ V}$: **1000 k Ω ...9.99 G Ω**

Display range	Resolution	Accuracy
1.00...9.99 k Ω	0.01 k Ω	not defined
10.0...99.9 k Ω	0.1 k Ω	
100...249 k Ω	1 k Ω	$\pm(3\% \text{ m.v.} + 8 \text{ digits})$
250...999 k Ω	1 k Ω	
1.00...9.9 M Ω	0.01 M Ω	
10.0...99.9 M Ω	0.1 M Ω	
100...2000 M Ω	1 M Ω	

Capacitance measurement

Display range	Resolution	Accuracy
0...9.9 μF	0.1 nF	$\pm(5\% \text{ m.v.} + 6 \text{ digits})$

MIC

Set of standard and optional accessories

1, 2, 4 - number of standard accessories
- - optional accessories

Photo	Name	Index	MIC-15k1	MIC-10k1	MIC-5050	MIC-5010	MIC-5005	MIC-5001	MIC-2511	MIC-2501	MIC-30	MIC-10	MIC-5	Photo	Name	Index	MIC-15k1	MIC-10k1	MIC-5050	MIC-5010	MIC-5005	MIC-5001	MIC-2511	MIC-2501	MIC-30	MIC-10	MIC-5		
	AGT-16C three-phase socket adapter 16 A (PEN)	WAADAAGT16C													Crocodile clip, blue, 11 kV, 32 A	WAKROBU32K09				1	1	1	1	1					
	AGT-16P three-phase socket adapter 16 A	WAADAAGT16P													Test lead 1 kV (banana plugs) black 1.2 m	WAPRZ1X2BLBB											1		
	AGT-16T industrial socket adapter 16 A	WAADAAGT16T													Test lead 1 kV (banana plugs, shielded) black 1.2 m	WAPRZ1X2BLBBE									1				
	AGT-32C three-phase socket adapter 32 A (PEN)	WAADAAGT32C													Test lead 1 kV (banana plugs, shielded) black 5 m	WAPRZ005BLBBE													
	AGT-32P three-phase socket adapter 32 A	WAADAAGT32P													Test lead 1 kV (banana plugs) red 1.2 m	WAPRZ1X2REBB										1	1		
	AGT-32T industrial socket adapter 32 A	WAADAAGT32T													Test lead 1 kV (banana plugs) red 5 m	WAPRZ005REBB													
	AGT-63P three-phase socket adapter 63 A	WAADAAGT63P													Test lead 1 kV (banana plugs) blue 1.2 m	WAPRZ1X2BUBB										1			
	AutoISO-2511 adapter	WAADAISO2511													Test lead 1 kV (banana plugs) blue 5 m	WAPRZ005BUBB													
	AutoISO-5000 adapter	WAADAISO50													Test lead 5 kV (banana plugs, shielded) black 1.8 m	WAPRZ1X8BLBB										1	1	1	
	WS-04 adapter with UNI-Schuko angular plug	WAADAWS04													Test lead 5 kV (banana plugs, shielded) black 5 / 10 m	WAPRZ005BLBBE5K WAPRZ010BLBBE5K													
	AZ-3 power supply adapter (mains plug/ banana sockets)	WAADAAZ3													Test lead 5 kV (banana plugs) red 1.8 m	WAPRZ1X8REBB										1	1	1	
	Crocodile clip, black, 1 kV, 20 A	WAKROBL20K01													Test lead 5 kV (banana plugs) red 5 / 10 m	WAPRZ005REBB5K WAPRZ010REBB5K													
	Crocodile clip, red, 1 kV, 20 A	WAKRORE20K02													Test lead 5 kV (banana plugs) blue 1.8 m	WAPRZ1X8BUBB										1	1	1	
	Crocodile clip, blue, 1 kV, 20 A	WAKROBU20K02													Test lead 5 kV (banana plugs) blue 5 / 10 m	WAPRZ005BUBB5K WAPRZ010BUBB5K													
	Crocodile clip, black, 11 kV, 32 A	WAKROBL32K09													Test lead 11 kV (banana plugs, shielded) black 1.8 m	WAPRZ1X8BLBBE10K													
	Crocodile clip, red, 11 kV, 32 A	WAKRORE32K09													Test lead 11 kV (banana plugs, shielded) black 3 / 5 / 10 / 20 m	WAPRZ003BLBBE10K WAPRZ005BLBBE10K WAPRZ010BLBBE10K WAPRZ020BLBBE10K													

MIC

Set of standard and optional accessories

1, 2, 4 - number of standard accessories
 - optional accessories

Photo	Name	Index	MIC-15k1	MIC-10k1	MIC-5050	MIC-5010	MIC-5005	MIC-5001	MIC-2511	MIC-2501	MIC-30	MIC-10	MIC-5
	Z32 power supply	WAZASZ32						1					
	Mains cable with IEC C7 plug	WAPRZLAD230					1	1					
	Mains cable with IEC C13 plug	WAPRZ1X8BLIEC	1	1	1	1	1						
	Cable for battery charging from car cigarette lighter socket (12 V)	WAPRZLAD12SAM						•	•				
	Hanging strap	WAPOZPAS6						1					
	M1 hanging straps	WAPOZSZE4									1	1	
	W1 hanging straps	WAPOZSZE5	1	•	•	1	1	•					
	M1 hanging hook straps	WAPOZUCH1									1	1	
	Magnetic hanging strap	WAPOZUCH6									•	•	
	L4 carrying case	WAFUTL4	1	1	1	1	1						
	L7 backpack	WAFUTL7	•	•	•	•	•						

Photo	Name	Index	MIC-15k1	MIC-10k1	MIC-5050	MIC-5010	MIC-5005	MIC-5001	MIC-2511	MIC-2501	MIC-30	MIC-10	MIC-5
	M6 carrying case	WAFUTM6						1			1	1	
	M8 carrying case	WAFUTM8					1		1				
	M15 carrying case	WAFUTM15							•				
	S2 carrying case	WAFUTS2											•
	S4 armband case for Mini Bluetooth keyboard	WAFUTS4		•	•								
	L7 carrying case for PRS-2	WAWALL7						•					
	USB cable	WAPRZUSB	1	1	1	1	1	1		1			
	Type C USB cable	WAPRZUSBC							1				
	PC software: Sone! Reports Plus	WAPROREPORTSPPLUS	•	•	•	•	•	•	•	•	•	•	•
	PC software: Sone! Reader	WAPROREADER	•	•	•	•	•	•	•	•	•	•	•

Fault loop impedance meters

MZC-330S
MZC-320S
MZC-310S

MZC-306

MZC-304F
MZC-20E

Comparison of fault loop impedance meters

Rated voltage [V]	110/190 115/200 127/220 220/380 230/400 240/415 290/500 400/690	110/190 115/200 127/220 220/380 230/400 240/415 290/500	220/380 230/400	110/190 115/200 127/220 220/380 230/400 240/415 290/500 400/690	220/380 230/400 240/415	220/380 230/400 240/415	220/380 230/400 240/415	110/190 115/200 127/220 220/380 230/400 240/415	110/190 115/200 127/220 220/380 230/400 240/415	110/190 115/200 127/220 220/380 230/400 240/415	220/380 230/400 240/415						
Operating voltage range [V]	100...750	100...550	187...440	100...750	180...460	180...440	95...440	95...440	95...440	180...460							
Display range [Ω]	0...1999	0...1999	0...199.9	0...1999	0...1999	0...200	0...1999.9	0...1999	0...1999	0...1999							
Maximum resolution [Ω]	0.001	0.001	0.001	0.01	0.01	0.01	0.001	0.001	0.01	0.01							
Maximum resolution for measurement with 15 mA current [Ω]	–	–	–	0.01	0.01	0.01	0.01	0.01	0.01	0.01							
Max. measurement current [A]	130/280	130/280	160/280	12.2...36.7	7.6/13.3	15.3/26.7	23/44	23/44	23/44	7.6/13.3							
Measuring range according to EN 61557 [Ω]	0.0072...1999	0.0072...1999	0.0072...199.9	0.13...1999	0.13...1999	0.24...200	0.50...1999	0.13...1999	0.13...1999	0.13...1999							
Display of fault loop resistance and reactance	✓	✓	✓	✓	✓	✓	✓	✓	✓	✓							
Calculation of prospective fault current on the basis of rated voltage	✓	✓	✓	✓	✓	✓	✓	✓	✓	✓							
Calculation of prospective fault current on the basis of measured voltage	–	–	–	–	✓	–	✓	✓	–	–							
Memory (number of each type of measurement)	990	990	990	990	990	–	UNLIMITED	10 000	990	990							
4-lead method	✓	✓	✓	–	–	–	–	–	–	–							
Measurement of prospective touch and shock voltage	✓	✓	✓	–	–	–	–	–	–	–							
Selection of test lead length	✓	✓	✓	✓	✓	✓	✓	✓	✓	✓							
In-socket measurement by means of adapter - plug	–	–	–	Option	✓	–	✓	✓	✓	✓							
Triggering of measurements by adapter	–	–	–	Option	Option	–	✓	✓	✓	Option							
Triggering of measurements via Wi-Fi	✓	✓	–	–	–	–	–	–	–	–							
Alternating voltage measurement	✓	✓	✓	✓	✓	✓	✓	✓	✓	✓							
Dimensions [mm]	390 x 308 x 172	390 x 308 x 172	295 x 222 x 95	288 x 223 x 75	220 x 102 x 61	220 x 102 x 61	288 x 223 x 75	288 x 223 x 75	288 x 223 x 75	220 x 102 x 61							
Weight [kg]	6.5	6.5	2.2	2.2	0.6	0.5	2.5	2.2	2.2	0.6							

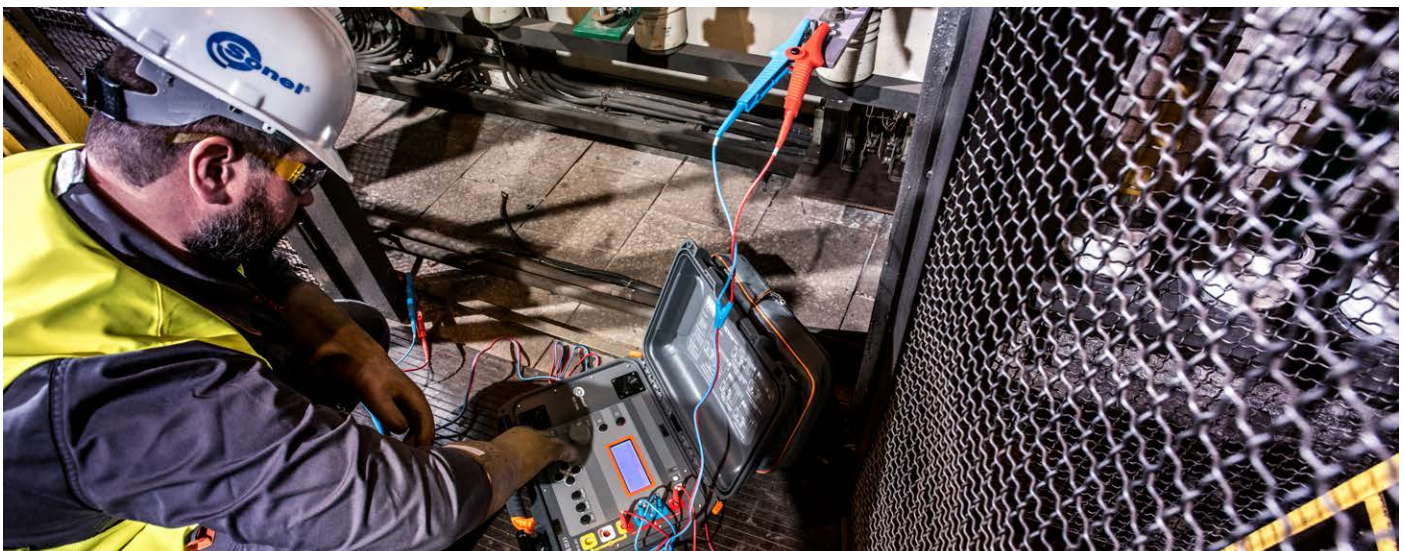

SONEL MZC-330S / MZC-320S



MZC-330S
750 V
maximum network voltage

0.1 mΩ
maximum resolution

CAT IV
600 V
IP67

Fault loop impedance measurement:

- » measurement of very low short circuit loop impedances (with resolution 0,1 mΩ) with a current of 130 A at 230 V; maximum 300 A at 690 V (500 V in MZC-320S),
- » measurement with a current of 24 A at 230 V, maximum 37 A at 690 V (maximum 27 A at 500 V in MZC-320S) with resolution 0,01 Ω,
- » measurements in installations with rated voltages: 110/190 V, 115/200 V, 127/220 V, 220/380 V, 230/400 V, 240/415 V, 290/500 V and 400/690 V (MZC-330S only) and frequencies 45...65 Hz,
- » ability to perform measurements in short circuit system: phase-phase, phase-PE, phase-N,
- » differentiation between the phase voltage and the inter-phase voltage while calculating the short circuit current,
- » ability to change the length of test lead (measurement with 2p method),
- » 4p (four-pole) method, test leads do not require calibration (measurement with current up to 300 A),
- » measurement of resistance (R_s) and reactance (X_s) components.

Additional functions of the meter:

- » remote control via Wi-Fi: triggering the measurement, saving the result to the meter's memory, downloading the results from the instrument's memory,
- » touch voltage and touch shock voltage measurement with resistor 1 kΩ),
- » AC voltage measurement in range 0...750 V (0...550 V in MZC-320S),
- » frequency measurement 45.0...65.0 Hz,
- » memory of 990 measurement results, ability to transfer the data to a PC via USB and Wi-Fi,
- » power supply: rechargeable battery,
- » the device meets the requirements of EN 61557 standard.

Electric security:

- » type of insulation double, according to EN 61010-1 and IEC 61557
- » measurement category IV 600 V acc. to EN 61010-1
- » protection class acc. EN 60529 IP67 (IP20 with front cover open)

Other technical specifications:

- » power supply built in Li-Ion 7.2 V / 8.8 Ah rechargeable battery
- » resistor limiting the current:
 - for 4 pole method (4p) 1.8 Ω for U≤550 V
 - 2.5 Ω for U>550 V (MZC-330S)
 - for two pole method (2p) 9.4 Ω for U≤253 V
 - 19 Ω for U>253 V
- » number of short circuit loop measurements min. 4000 (2/min)
- » temperature coefficient ±0,1% of measured value/°C
- » dimensions 390 x 308 x 172 mm
- » weight 6.5 kg

Nominal operating conditions:

- » operating temperature range -10...+40°C

Standard accessories:

Test lead 1.2 m, black, 1 kV (banana plugs)	WAPRZ1X2BLBB
Test lead 1.2 m, yellow, 1 kV (banana plugs)	WAPRZ1X2YEBB
Pin probe, black 1 kV (banana socket)	WASONBLOGB1
Pin probe, yellow 1 kV (banana socket)	WASONYEOGB1
Doble-wire test lead 3 m (10 A / 25 A) U1/I1	WAPRZ003DZBBU11
Doble-wire test lead 3 m (10 A / 25 A) U2/I2	WAPRZ003DZBBU212
4x crocodile clip, black, 1 kV, 32 A	WAKROBL30K03
2x Kelvin clamp, 1 kV, 25 A	WAKROKELK06
2x high-current pin probe 1 kV (banana sockets)	WASONSPGB1
Mains cable with IEC C7 plug	WAPRZLAD230
Power supply adaptor Z19	WAZASZ19
L-14 carrying case	WAFUTL14
USB cable	WAPRZUSB

Factory calibration certificate

High-current measurement of fault loop parameters (4-lead $I_{max} = 300 A$)

High-current measurement of fault loop impedance Z_s :
measuring range according to EN 61557-3: 7.2 mΩ...1999 mΩ

Display range	Resolution	Accuracy
0...199.9 mΩ	0.1 mΩ	±(2% m.v. + 2 mΩ)
200...1999 mΩ	1 mΩ	

Short circuit current indication

Measuring range according to IEC 61557

for $U_n = 230 V$ 115.0 A...32.9 kA for $U_n = 400 V$ 200 A...55.5 kA
for $U_n = 500 V$ 250 A...69.4 kA for $U_n = 690 V$ 345 A...95.8 kA (MZC-330S)

Display range	Resolution	Accuracy
115.0...199.9 A	0.1 A	Calculated on the basis of error for fault loop
200...1999 A	1 A	
2.00...19.99 kA	0.01 kA	
20.0...199.9 kA	0.1 kA	
200 kA... *	1 kA	

*max 690 kA for MZC-330S, max 500 kA for MZC-320S

Touch voltage measurements U_{st} and shock voltage U_T

Display range	Resolution	Accuracy
0...100 V	1 V	±(10% m.v. + 2 digits)

Short circuit loop parameters measurement using standards current (2p, $I_{max} = 37 A$)

Measuring range according to IEC61557: 0,13 Ω...199,9 Ω for test leads length 1,2 m

Display range	Resolution	Accuracy
0.00...19.99 Ω	0.01 Ω	±(2% m.v. + 3 digits)
20.0...199.9 Ω	0.1 Ω	±(3% m.v. + 3 digits)

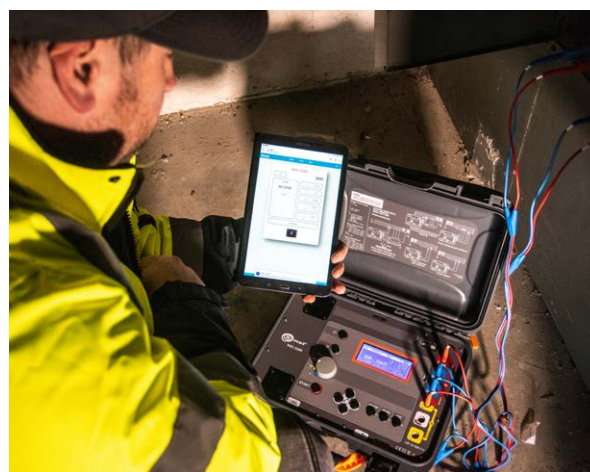

The MZC-310S, 320S and 330S meters are the only meters on the market that also enable touch voltage or shock voltage measurement, which can be employed during safety assessment of a tested system.

SONEL MZC-310S

CAT III

600 V

CAT IV

300 V

IP20

0.1 mΩ

maximum resolution



Standard accessories:

L1 carrying case	WAFUTL1
4x crocodile clip, black, 1 kV, 32 A	WAKROBL30K03
2x Kelvin clamp, 1 kV, 25 A	WAKROKELK06
Test lead 1.2 m, black, 1 kV (banana plugs)	WAPRZ1X2BLBB
Test lead 1.2 m, yellow, 1 kV (banana plugs)	WAPRZ1X2YEBB
Double-wire test lead 3 m (10 A / 25 A) U1/I1	WAPRZ003DZBBU11
Double-wire test lead 3 m (10 A / 25 A) U2/I2	WAPRZ003DZBBU212
RS-232 serial transmission cable	WAPRZR232
Pin probe, black 1 kV (banana socket)	WASONBLOGB1
Pin probe, yellow 1 kV (banana socket)	WASONYEOGB1
2x high-current pin probe 1 kV (banana sockets)	WASONSPGB1
UNI-SONEL hanging straps	WAPOZSZE1
Factory calibration certificate	

High-current measurement of fault loop parameters (4-lead, I_{max} = 280 A)

High-current measurement of fault loop impedance Z_S:
measuring range according to EN 61557-3: 7.2 mΩ...1999 mΩ

Display range	Resolution	Accuracy
0...199.9 mΩ	0.1 mΩ	±(2% m.v. + 2 mΩ)
200...1999 mΩ	1 mΩ	

Fault current readings

Measuring range according to EN 61557-3:
for U_n = 230 V 115.0 A...32.0 kA
for U_n = 400 V 200 A...55.7 kA

Display range	Resolution	Accuracy
115.0...199.9 A	0.1 A	Calculated on the basis of error for fault loop
200...1999 A	1 A	
2.00...19.99 kA	0.01 kA	
20.0...199.9 kA	0.1 kA	
200kA... *	1 kA	

*230 kA for U_{L-N} 400 kA for U_{L-L}

Measurement of touch voltage U_{ST} and shock voltage U_T

Display range	Resolution	Accuracy
0...100 V	1 V	±(10% m.v. + 2 digits)

Measurement of fault loop impedance Z_S with standard current (2-lead, I_{max} = 42 A)

measuring range for 1.2 m test leads according to EN 61557: 0.13 Ω...199.9 Ω

Display range	Resolution	Accuracy
0.00...19.99 Ω	0.01 Ω	±(2% m.v. + 3 digits)
20.0...199.9 Ω	0.1 Ω	±(3% m.v. + 3 digits)



The MZC-310S, 320S and 330S meters are the only meters on the market that also enable touch voltage or shock voltage measurement, which can be used during safety assessment of a tested system.

Fault loop impedance measurement:

- » measurement of very low short circuit loop impedances (with resolution 0,1 mΩ) with a current of 150 A at 230 V; maximum 280 A at 440 V,
- » measurement with a current of 23 A at 230 V, maximum 42 A at 440 V with resolution 0,01 Ω,
- » measurements in installations with rated voltages: 220/380 V and 230/400 V and frequencies 45...65 Hz,
- » ability to perform measurements in short circuit system: phase-phase, phase-PE, phase-N,
- » differentiation between the phase voltage and the inter-phase voltage while calculating the short circuit current,
- » ability to change the length of test lead (measurement with 2p method),
- » 4p (four-pole) method, test leads do not require calibration (measurement with current up to 280 A),
- » measurement of resistance (R_s) and reactance (X_s) components.

Additional functions of the meter:

- » touch voltage and touch shock voltage measurement with resistor 1 kΩ),
- » AC voltage measurement in range 0...440 V,
- » frequency measurement 45.0...65.0 Hz,
- » memory of 990 measurement results, ability to transfer the data to a PC via RS-232,
- » power supply: rechargeable battery (5x LR14).

The instrument meets the requirements set forth in the standards:

- » EN 61010-1 (general and particular requirements related to safety)
- » EN 61010-031 (general and particular requirements related to safety)
- » EN 61326 (electromagnetic compatibility)
- » EN 61557 (requirements for measurement instruments)
- » HD 60364-6 (performance of measurements - checking)
- » HD 60364-4-41 (performance of measurements - shock protection)
- » PN-E 04700 (performance of measurements - commissioning tests)

Other technical specifications:

- » type of insulation double, as per EN 61010-1 and EN 61557
- » power supply of the meter LR14 alkaline batteries (size C) (5 pcs.)
- » current-limiting resistor for 4-lead measurement: 1.5 Ω, for 2-lead measurement: 10 Ω
- » number of fault loop measurements (alkaline batteries) at least 4000 (2/min.)
- » temperature coefficient ±0,1% of measured value/°C

Nominal operating conditions:

- » operating temperature range 0...+40°C

Fault loop impedance meter

SONEL MZC-306

index: WMGBMZC306

750 V

maximum network voltage

Z_{L-PE}
RCD

measurements without tripping RCDs

CAT IV

600 V

CAT III

1000 V

IP54



Standard accessories:

WS-05 adapter with UNI-SCHUKO angular plug	WAADAWS05
NiMH battery 4.8 V 4.2 Ah	WAAKU07
L4 carrying case	WAFUTL4
Crocodile clip, red, 1 kV, 20 A	WAKRORE20K02
Crocodile clip, blue, 1 kV, 20 A	WAKROBU20K02
Test lead 1.2 m, red, 1 kV (banana plugs)	WAPRZ1X2REBB
Test lead 1.2 m, blue, 1 kV (banana plugs)	WAPRZ1X2BUBB
Test lead 1.2 m, yellow, 1 kV (banana plugs)	WAPRZ1X2YEBB
USB cable	WAPRZUSB
Mains cable with IEC C7 plug	WAPRZLAD230
Pin probe, red 1 kV (banana socket)	WASONREOGB1
Pin probe, blue 1 kV (banana socket)	WASONBUOGB1
Pin probe, yellow 1 kV (banana socket)	WASONYEOGB1
L2 hanging straps (set)	WAPZOSZEKPL
Z7 Power supply	WAZASZ7

Factory calibration certificate

Measurement of fault loop impedance Z_{L-PE} , Z_{L-N} , Z_{L-L}

Measuring range acc. to EN 61557-3 for 1.2 m test leads: **0.13...1999 Ω**

Display range	Resolution	Accuracy
0.00...19.99 Ω	0.01 Ω	±(5% m.v. + 3 digits)
20.0...199.9 Ω	0.1 Ω	±(4% m.v. + 3 digits)
200...1999 Ω	1 Ω	

Nominal voltage: 100...440 V (for Z_{L-PE} and Z_{L-N}) or 100...750 V (for Z_{L-L})

Measurement of earth fault loop impedance Z_{L-PE} in RCD mode

Measuring range according to EN 61557-3 for 1,2 m leads: **0.43...1999 Ω**

Display range	Resolution	Accuracy
0.00...19.99 Ω	0.01 Ω	±(6% m.v. + 10 digits)
20.0...199.9 Ω	0.1 Ω	±(6% m.v. + 5 digits)
200...1999 Ω	1 Ω	

Fault loop impedance measurement:

- » fault loop impedance measurement with 0.01 Ω resolution,
- » low-current impedance measurement in circuits protected by RCD ≥ 30mA with 0.01 Ω resolution (range of 100...440 V),
- » operates in networks with voltages 110/190 V, 115/200 V, 127/220 V, 220/380 V, 230/400 V, 240/415 V, 290/500 V and 400/690 V (operating range 100...750 V),
- » operating frequency 45...65 Hz,
- » calculation of I_k fault current,
- » automatic differentiation between phase and phase-to-phase voltage,
- » possibility of applying an adapter terminated by a power network plug or 1.2, 5, 10, 20 m test leads,
- » measurement with swapped L and N conductors,
- » measurement of resistance (R_s) and reactance (X_s) components.

Additional functions of the meter:

- » contact electrode - quick testing of proper connection of PE conductor,
- » voltage measurement 0...750 V AC (0...250 V with resolution of 0,1 V),
- » memory of 990 measurement results, ability to transfer the data to a PC via USB,
- » power supply: batteries (4 x LR14) or rechargeable batteries.

Instruments meet the requirements set forth in the standards:

- » EN 61010-1 (general and particular requirements related to safety)
- » EN 61010-031 (general and particular requirements related to safety)
- » EN 61326 (electromagnetic compatibility)
- » EN 61557 (requirements for measurement instruments)
- » HD 60364-6 (performance of measurements - checking)
- » HD 60364-4-41 (performance of measurements - shock protection)
- » PN-E 04700 (performance of measurements - commissioning tests)



Meter calculates the value of prospective fault current in compliance with standard HD 60364-6.

Electrical safety:

- » type of insulation double, as per EN 61010-1 and EN 61557
- » test leads EN 61010-2-031

Other technical specifications:

- » meter power supply rechargeable battery pack or (optional) alkaline batteries
- » rechargeable battery or alkaline battery performance at least 5000 measurements (2/min)
- » display backlit LED

Nominal operating conditions:

- » operating temperature range 0...+45°C
- » humidity 20...80%



MZC-306 meter performs fault loop impedance measurements in industrial networks of any voltage up to 750 V.



Fault loop impedance meter

SONEL MZC-304F

index: WMGBMZC304F

**Z_{L-PE}
RCD**
measurements
without tripping
RCDs



- CAT III**
- 600 V**
- CAT IV**
- 300 V**
- IP67**
- BLUETOOTH**

Fault loop impedance measurement:

- » fault loop impedance measurement with 0.01 Ω resolution,
- » low-current impedance measurement in circuits protected by RCD ≥ 30mA with 0.01 Ω resolution (range of 180...270 V),
- » operates in networks with voltages 220/380 V, 230 V/400 V, 240/415 V (operating range 180...460 V),
- » operating voltage range: 180...270 V (for Z_{L-PE} and Z_{L-N}) and 180...460 V (for Z_{L-L}),
- » maximum measuring current: 7.6 A for 230 V (3x10 ms), 13.3 A for 400 V (3x10 ms),
- » operating frequency 45...65 Hz,
- » calculation of I_k fault current,
- » measurement with swapped L and N conductors,
- » measurement of resistance (R_s) and reactance (X_s) components,
- » low-voltage measurement of continuity of circuit and resistance.

Additional functions of the meter:

- » contact electrode - quick testing of proper connection of PE conductor,
- » voltage measurement 0...500 V,
- » frequency measurement 45.0...65.0 Hz,
- » memory of 990 measurement results, ability to transfer the data to a PC via Bluetooth,
- » power supply: batteries (4 x LR14) or rechargeable batteries (4 x NiMH).

Electrical safety:

- » type of insulation double, as per EN 61010-1 and EN 61557
- » test leads EN 61010-2-031
- » measurement category CAT III 600 V (CAT IV 300 V) according to EN 61010-1
- » housing protection rating according to EN 60529 IP67

Other technical specifications:

- » power supply of the meter ... pack of rechargeable batteries or alkaline batteries (size AA, 4 pcs.)
- » rechargeable battery life at least 5000 measurements (2/min)

Nominal operating conditions:

- » operating temperature range 0...+50°C
- » humidity 20...80%



The MZC-304F meter calculates the value of prospective fault current in compliance with standard HD 60364-6.

Standard accessories:

WS-05 adapter with UNI-Schuko angular plug	WAADAWS05
M6 carrying case	WAFUTM6
Crocodile clip, yellow, 1 kV, 20 A	WAKROYE20K02
Test lead 1,2 m, red, 1 kV (banana plugs)	WAPRZ1X2REBB
Test lead 1,2 m, blue, 1 kV (banana plugs)	WAPRZ1X2BUBB
Test lead 1,2 m, yellow, 1 kV (banana plugs)	WAPRZ1X2YEBB
Pin probe, red 1 kV (banana socket)	WASONREOGB1
Pin probe, blue 1 kV (banana socket)	WASONBUOGB1
M1 hanging straps	WAPOZSZE4
M1 hanging hook straps	WAPOZUCH1
Factory calibration certificate	



The MZC-304F meter measures fault loop impedance with 0.01 Ω resolution, including in circuits protected by RCDs, without tripping them.

Measurement of fault loop impedance Z_{L-PE}, Z_{L-N}, Z_{L-L}, fault loop resistance and reactance

Measuring range for 1.2 m test leads according to EN 61557-3: 0.13 Ω...1999 Ω

Display range	Resolution	Accuracy
0.00...19.99 Ω	0.01 Ω	±(5% m.v. + 3 digits)
20.0...199.9 Ω	0.1 Ω	
200...1999 Ω	1 Ω	

Measurement of earth fault loop impedance Z_{L-PE} in RCD mode (without tripping RCD)

Measuring range for 1.2 m leads according to EN 61557-3: 0.51 Ω...1999 Ω

Display range	Resolution	Accuracy
0.00...19.99 Ω	0.01 Ω	±(6% m.v. + 10 digits)
20.0...199.9 Ω	0.1 Ω	
200...1999 Ω	1 Ω	

- » does not trip RCDs with I_{Δn} ≥ 30 mA



The instrument meets the requirements set forth in the standards:

- » EN 61010-1 (general and particular requirements related to safety)
- » EN 61010-031 (general and particular requirements related to safety)
- » EN 61326 (electromagnetic compatibility)
- » EN 61557 (requirements for measurement instruments)
- » HD 60364-6 (performance of measurements - checking)
- » HD 60364-4-41 (performance of measurements - shock protection)
- » PN-E 04700 (performance of measurements - commissioning tests)



MZC-304F always measures total fault loop impedance as well as its components – resistance and reactance – regardless of the phase shift value.

Fault loop impedance meter

SONEL MZC-20E

index: WMGBMZC20E



CAT III

300 V

IP67

Fault loop impedance measurement:

- » fault loop impedance measurement with 0.01 Ω resolution,
- » operates in networks with voltages 220/380 V, 230/400 V, 240/415 V (operating range 180...440 V),
- » operating frequency 45...65 Hz,
- » calculation of I_k fault current,
- » automatic differentiation between phase and phase-to-phase voltage,
- » possibility of applying test leads: 1.2 m, 5 m and longer,
- » measurement with swapped L and N conductors,
- » measurement of resistance (R_s) and reactance (X_s) components.

Additional functions of the meter:

- » voltage measurement 0...440 V AC,
- » power supply: batteries (4 x LR6) or rechargeable batteries (4 x NiMH).

Other technical specifications:

- » type of insulation double, as per EN 61010-1 and IEC 61557
- » measurement category CAT III 300 V according to EN 61010-1
- » housing protection rating according to EN 60529 IP67

Other technical specifications:

- » power supply of the meter LR6 alkaline batteries or AA Ni-MH rechargeable batteries (4 pcs.)
- » dimensions 220 x 102 x 61 mm
- » meter weight with battery pack 509 g
- » storage temperature -20...+70 °C
- » operating temperature range -10...+50 °C
- » humidity 20...80%
- » reference temperature +23...± 2 °C
- » reference humidity 40...60%
- » elevation above sea level <2000 m
- » time until Auto-OFF max. 900 seconds
- » number of Z measurements (for rechargeable batteries) >5000 (2 measurements/minute)
- » display segmented LCD
- » quality standard development, design and production in compliance with ISO 9001
- » the instrument meets the requirements set forth in the standards IEC 61557
- » the instrument is compliant with standards EN 61326-1 and EN 61326-2-2

Standard accessories:

M13 carrying case	WAFUTM13
Crocodile clip, red, 1 kV, 20 A	WAKRORE20K02
Test lead 1,2 m, red, 1 kV (banana plugs)	WAPRZ1X2REBB
Test lead 1,2 m, blue, 1 kV (banana plugs)	WAPRZ1X2BUBB
Pin probe, red 1 kV (banana socket)	WASONREOGB1
Pin probe, blue 1 kV (banana socket)	WASONBUOGB1
M1 hanging straps	WAPOZSZE4
M1 hanging hook straps	WAPOZUCH1
Factory calibration certificate	

Measurement of fault loop impedance Z_s within the range of 0.24...200 Ω

Fault current I_k : 0.115÷1769 A ($U_n=230$ V)

AC voltage measurement: 0÷440 V

Display range	Resolution	Accuracy
0.00...19.99 Ω	0.01 Ω	±(2.5% m.v. + 5 digits)
20.0...99.9 Ω	0.1 Ω	±(2.5% m.v. + 3 digits)
100...200 Ω	1 Ω	±(3% m.v. + 3 digits)

- » Nominal operating voltage $U_{n,L-N}/U_{n,L-L}$: 220/380 V, 230/400 V, 240/415 V
- » Operating voltage range: 180...270 V (for Z_{L-PE} and Z_{L-N}) and 180...440 V (for Z_{L-L})
- » Nominal network frequency f_n : 50 Hz, 60 Hz
- » Operating frequency range: 45...65 Hz
- » Maximum measurement current: 15.3 A for 230 V (10 ms) and 26.7 A for 400 V (10 ms)

Readings of fault loop resistance R_s and fault loop reactance X_s :

Display range	Resolution	Accuracy
0.00...9.99 Ω	0.01 Ω	±(5% m.v. + 5 digits) of Z_s value

- » Calculated and displayed for $Z_s < 10$ Ω

Readings of fault current I_k

Measuring ranges according to EN 61557 can be calculated on the basis of Z_s measurement ranges and nominal voltages

Display range	Resolution	Accuracy
1.15...9.99 A	0.01 A	Calculated on the basis of uncertainty for fault loop
10.0...99.9 A	0.1 A	
100...999 A	1 A	
1.00...9.99 kA	0.01 kA	
10.0...40.0 kA	0.1 kA	

Voltage measurement

Display range	Resolution	Accuracy
0...440 V	1 V	±(2.5% m.v. + 3 digits)

Measurement of fault loop impedance Z_s

Test lead	Z_s measuring range
1.2 m	0.24...200 Ω
5 m	0.26...200 Ω
10 m	0.28...200 Ω
20 m	0.35...200 Ω



MZC

Set of standard and optional accessories

1, 2, 4 - number of standard accessories
 - - optional accessories

Photo	Name	Index	MZC-330S	MZC-320S	MZC-310S	MZC-306	MZC-304F	MZC-20E
	AGT-16C three-phase socket adapter 16 A (PEN)	WAADAAGT16C			•	•	•	•
	AGT-16P three-phase socket adapter 16 A	WAADAAGT16P			•	•	•	•
	AGT-16T industrial socket adapter 16 A	WAADAAGT16T			•	•	•	•
	AGT-32C three-phase socket adapter 32 A (PEN)	WAADAAGT32C			•	•	•	•
	AGT-32P three-phase socket adapter 32 A	WAADAAGT32P			•	•	•	•
	AGT-32T industrial socket adapter 32 A	WAADAAGT32T			•	•	•	•
	AGT-63P three-phase socket adapter 63 A	WAADAAGT63P			•	•	•	•
	WS-01 adapter with START button with UNI-Schuko plug	WAADAWS01				•		
	WS-03 adapter with START button with UNI-Schuko plug	WAADAWS03					•	
	WS-04 adapter with UNI-Schuko plug	WAADAWS04					•	
	WS-05 adapter with UNI-Schuko angular plug	WAADAWS05				1	1	
	WS-07 adapter for measuring Z(L-N)	WAADAWS07					•	
	Kelvin clamp, 1 kV, 25 A	WAKROKELK06	2	2	2			
	Crocodile clip, black, 1 kV, 32 A	WAKROBL30K03	4	4	4			
	Crocodile clip, red, 1 kV, 20 A	WAKRORE20K02				1		1
	Crocodile clip, blue, 1 kV, 20 A	WAKROBU20K02				1	•	
	Crocodile clip, yellow, 1 kV, 20 A	WAKROYE20K02				•	1	
	Test lead 1.2 m, black, 1 kV (banana plugs)	WAPRZ1X2BLBB	1	1	1			
	Test lead 1.2 m, red, 1 kV (banana plugs)	WAPRZ1X2REBB				1	1	1

Photo	Name	Index	MZC-330S	MZC-320S	MZC-310S	MZC-306	MZC-304F	MZC-20E
	Test lead 1.2 m, blue, 1 kV (banana plugs)	WAPRZ1X2BUBB						1
	Test lead 1.2 m, yellow, 1 kV (banana plugs)	WAPRZ1X2YEBB	1	1	1	1	1	1
	Test lead 5 m, red, 1 kV (banana plugs)	WAPRZ005REBB					•	•
	Test lead 5 m, yellow, 1 kV (banana plugs)	WAPRZ005YEBB	•	•	•			
	Test lead 10 m, red, 1 kV (banana plugs)	WAPRZ010REBB					•	•
	Test lead 10 m, yellow, 1 kV (banana plugs)	WAPRZ010YEBB	•	•	•			
	Test lead 20 m, red, 1 kV (banana plugs)	WAPRZ020REBB					•	•
	Test lead 20 m, yellow, 1 kV (banana plugs)	WAPRZ020YEBB	•	•	•			
	Doble-wire test lead 3 m (10 A / 25 A) U1/I1	WAPRZ003DZBBU1I1	1	1	1			
	Doble-wire test lead 3 m (10 A / 25 A) U2/I2	WAPRZ003DZBBU2I2	1	1	1			
	Doble-wire test lead 6 m (10 A / 25 A) U1/I1	WAPRZ006DZBBU1I1	•	•				
	Doble-wire test lead 6 m (10 A / 25 A) U2/I2	WAPRZ006DZBBU2I2	•	•				
	Foldable pin probe, 1 kV, 2 m (banana socket)	WASONSP2M					•	•
	High-current pin probe 1 kV (banana sockets)	WASONSPGB1	2	2	2			
	Pin probe, black 1 kV (banana socket)	WASONBLOGB1	1	1	1			
	Pin probe, red 1 kV (banana socket)	WASONREOGB1					1	1
	Pin probe, blue 1 kV (banana socket)	WASONBUOGB1					1	1
	Pin probe, yellow 1 kV (banana socket)	WASONYEGB1	1	1	1	1		•
	Pin probe, red 11 kV (banana socket)	WASONREOGB11				•		

MZC

Set of standard and optional accessories

1, 2, 4 - number of standard accessories
 - - optional accessories

Photo	Name	Index	MZC-330S	MZC-320S	MZC-310S	MZC-306	MZC-304F	MZC-20E
	NiMH battery 4.8 V 4.2 Ah	WAAKU07				1		
	Battery container	WAPOJ1				•		
	Mains cable with IEC C7 plug	WAPRZLAD230				1		
	Z7 Power supply	WAZASZ7				1		
	Power supply adaptor Z19	WAZASZ19	1	1				
	Cable for battery charging from car cigarette lighter socket (12V)	WAPRZLAD12SAM				•		
	Reel for long test lead	WAPOZSZP1			•			
	UNI-SONEL hanging straps	WAPOZSZE1			1			
	L2 hanging straps (short)	WAPOZSZE2						
	M1 hanging straps	WAPOZSZE4			•		1	1
	L2 hanging straps (set)	WAPOZSEKPL				1		
	M1 hanging hook straps	WAPOZUCH1					1	1
	Magnetic hanging strap	WAPOZUCH6					•	

Photo	Name	Index	MZC-330S	MZC-320S	MZC-310S	MZC-306	MZC-304F	MZC-20E
	Cover (universal)	WAPOZUCH12				•		
	L1 carrying case	WAFUTL1			1			
	L2 carrying case	WAFUTL2			•			
	L4 carrying case	WAFUTL4	•	•		1		
	L7 backpack	WAFUTL7	•	•				
	L14 carrying case	WAFUTL14	1	1				
	M6 carrying case	WAFUTM6					1	
	M13 carrying case	WAFUTM13						1
	USB cable	WAPRZUSB	1	1		1		
	RS-232 serial transmission cable	WAPRZRS232				1		
	USB/RS-232 converter	WAADAUSBRS232				•		
	PC software: Sonel Reports Plus	WAPROREPORTSPLUS	•	•	•	•	•	
	PC software: Sonel Reader	WAPROREADER	•	•	•	•	•	



Earth resistance meters

A person wearing a yellow hard hat and a dark jacket is using an earth resistance meter in a field. The meter is connected to a metal rod in the ground. The background shows tall grass and a clear sky.

MRU-200-GPS
MRU-200
MRU-120HD
MRU-120

A close-up shot of a hand holding an earth resistance meter. The meter is a rugged, rectangular device with a screen and several buttons. It is connected to a metal rod. The background is a blurred outdoor setting.

MRU-30

A person is using an earth resistance meter on a brick wall. The meter is connected to a metal rod that is being inserted into the wall. The person is wearing a dark jacket and a hard hat. The background shows a brick wall and some construction equipment.

MRU-21
MRU-11
MRU-10

Set of instruments for earth measurements



	MRU-200-GPS MRU-200	MRU-120HD	MRU-120	MRU-30	MRU-21	MRU-11	MRU-10	MPI-540-PV MPI-540 MPI-536 MPI-535	MPI-530-IT MPI-530	MPI-525 MPI-520
Earth resistance measurement according to 3-pole method	✓	✓	✓	✓	✓	✓	✓	✓	✓	✓
Earth resistance measurement according to 4-lead method	✓	✓	✓	✓	–	–	–	✓	✓	–
Measurement current in measurements of earthing resistance [mA]	200	200	200	20	20	20	20	20	20	20
Maximum resolution [Ω]	0.001	0.01	0.01	0.01	0.01	0.01	0.01	0.01	0.01	0.01
Earth resistance measurement according to 3-pole method with additional clamp	✓	✓	✓	✓	–	–	–	✓	✓	–
Earth impedance measurement according to impulse method	✓	–	–	–	–	–	–	–	–	–
Earth resistance measurement according to two-clamp method	✓	✓	✓	✓	–	–	–	✓	✓	–
Leakage current measurement with hard clamp	✓	–	–	✓	–	–	–	✓	✓	MPI-520
Leakage current measurement with flexible coil	✓	–	–	–	–	–	–	✓	✓	✓
Measurement of resistance of earth connection and equipotential bonding according to standard EN 61557-4	✓	✓	✓	✓	✓	–	–	✓	✓	✓
Soil resistivity measurement	✓	✓	✓	✓	–	✓	–	✓	✓	–
Earth resistance measurement according to 2-lead method	–	–	–	✓	✓	✓	✓	–	–	–
Power supply	rechargeable battery / batteries	rechargeable battery	rechargeable battery / batteries	rechargeable battery	rechargeable battery / batteries	rechargeable batteries / batteries	rechargeable batteries / batteries	rechargeable battery	rechargeable battery / batteries	rechargeable battery / batteries
Charging from car lighter socket	✓	✓	✓	✓	–	–	–	✓	✓	OPTIONAL
Memory (records)	990	990	990	990	990	–	–	UNLIMITED	10 000	990
Measurement of disturbance voltages	✓	✓	✓	✓	✓	✓	✓	✓	✓	✓
Resistance measurement of auxiliary electrodes	✓	✓	✓	✓	✓	✓	✓	✓	✓	✓
Dimensions [mm]	288 x 223 x 75	390 x 310 x 180	288 x 223 x 75	200 x 180 x 74	288 x 223 x 75	220 x 102 x 61	220 x 102 x 61	288 x 223 x 75	288 x 223 x 75	288 x 223 x 75
Weight [kg]	2	4	2	1.1	1.4	0.7	0.7	2.5	2.2	2.2

Earth resistance measurements adapter

SONEL ERP-1

index: WAADAERP1 / WAADAERP1V2 / WAADAERP1V3



The adapter is compatible with meters:

- » MRU-200-GPS
- » MRU-200
- » MRU-120HD
- » MRU-120

The SONEL ERP-1 adapter, in combination with meters that can generate measurement current of 200 mA, serves for measuring of resistance of multiple groundings without disconnecting control connection clamps. The flexible, big diameter coil allows to measure earth resistance of e.g. transmission towers - including lattice poles - without shutting down the power line.

Ergonomic design of the adapter, its convenient housing and simple operation make earth resistance measurements on transmission towers and pylons quick and problem-free. The protection degree of the adapter is IP67, which makes it

Standard accessories:

	WAADAERP1	WAADAERP1V2	WAADAERP1V3
FS-2 flexible coil (Ø 1260 mm)	WACEGFS20KR	✓	
FSX-3 flexible coil (Ø 630 mm)	WACEGFSX30KR		✓
M6 carrying case	WAFUTM6	✓	✓
3x AA (LR6) 1.5 V battery		✓	✓
Factory calibration certificate		✓	✓

Optional accessories:

XL8 hard carrying case	WAWALXL8
------------------------	----------

suitable for operation in muddy and rain conditions.

Electrical specifications:

- » measuring range up to 5 A
- » operating frequency 125 Hz (in 50 Hz networks)
150 Hz (in 60 Hz networks)
- » power supply 3 x LR6 1.5 V battery or 3 x Ni-MH LR6 1.2 V rech. battery
- » measurement category CAT IV 300 V according to EN 61010-1

Other specifications:

- » protection rating IP67
- » storage temperature -20...+80°C
- » relative humidity of storage 20...90%
- » operating temperature range -10...+50°C
- » operating humidity 20...85%
- » exterior dimensions 146 x 88 x 33 mm
- » weight with batteries / without batteries 340 g / 270 g

Application	Distinguishing feature	MRU-200-GPS	MRU-200	MRU-120HD	MRU-120	MRU-30	MRU-21	MRU-11	MRU-10
Hard-to-reach measuring points • cataloguing the coordinates of measurement locations	Coordinates of the measurement points added to the measurement results	✓							
Military facilities • comprehensive measurements	Operation in 400 Hz networks	✓	✓						
Airport areas • comprehensive measurements	Operation in 400 Hz networks	✓	✓						
Lightning protection • earthing impedance measurements	Impulse method	✓	✓						
Gas stations • earthing impedance measurements • other earthing measurements	Impulse method	✓	✓						
Railway electric traction • comprehensive measurements for all types of earthing	Operation in 16 2/3 Hz networks	✓	✓						
Power poles • multiple earthing points • pole base measurements	• Measurement current: 200 mA • Using ERP-1	✓	✓	✓	✓				
Power stations • high disruptions • multiple lattice earthing	Measurement current: 200 mA	✓	✓	✓	✓				
Urban areas • system consisting of horizontal and vertical earth electrodes • impossible to insert auxiliary electrodes	2-clamp method	✓	✓	✓	✓	✓			
Soil tests • earthing design	Soil resistivity	✓	✓	✓	✓	✓		✓	
Commercial buildings • ring, foundation, lattice earthing	3-pole method	✓	✓	✓	✓	✓	✓	✓	✓
Residential buildings • ring, foundation earth electrodes • vertical earth electrode systems	3-pole method	✓	✓	✓	✓	✓	✓	✓	✓
Difficult measuring conditions • dust in the air • rain, snow	Casing resistant to weather conditions and mechanical damage			✓					

Measurement current 200 mA



SONEL MRU-200 / MRU-200-GPS

index: WMGBMRU200 (with L2 case) / WMGBMRU200GPS (with L2 case)
WMGBMRU200XL3 (with XL3 case) / WMGBMRU200GPSXL3 (with XL3 case)



Earthing resistance measurements:

- » impulse method (without the need to disconnect measured earth electrodes) - three types of measurement impulse (4/10 μs, 8/20 μs, 10/350 μs),
- » 3-pole method,
- » 4-lead method,
- » 3-pole method with additional clamp,
- » 3-pole method with ERP-1 adapter,
- » two-clamp method.

Soil resistivity measurements (Wenner method):

- » distances between electrodes can be input in meters (m) or feet (ft),
- » displaying the soil resistivity value in Ωm or Ωft.

Measurement of resistance of earth connection and equipotential bonding:

- » with auto-zeroing function - with current ≥200 mA,
- » according to EN 61557-4.

Additional functions of the meter:

- » measurement of auxiliary electrode resistances R_S and R_{HH} ,
- » measurement of voltage and frequency of interference signal,
- » measurement in the presence of disturbance voltages in networks with frequency 16 2/3 Hz, 50 Hz and 60 Hz as well as 400 Hz (with automatic or manual selection of relevant measurement signal frequency),
- » selection of maximum measurement voltage (25 V and 50 V),
- » calibration of applied clamp,
- » full interoperability with ERP-1 adapter,
- » memory storing 990 measurements (10 banks with 99 cells each),
- » MRU-200-GPS | built-in GPS receiver,
- » real-time clock (RTC),
- » data transmission to computer (USB, Bluetooth).
- » reading of battery charge state, built-in quick charger.



MRU-200-GPS is the only earthing resistance and impedance meter with the function of determining the geographical coordinates of the location of measurement.



SONEL MRU MOBILE

Mobile version of the program supports ground resistance and ground resistivity meters MRU-200 and MRU-200-GPS. It can be downloaded from Google Play.

Standard accessories:

NiMH battery 4.8 V 4.2 Ah	WAAKU07
L2 carrying case (only WMGBMRU200, WMGBMRU200GPS)	WAFUTL2
XL3 carrying case (only WMGBMRU200XL3, WMGBMRU200GPSXL3)	WAWALXL3
Crocodile clip, black, 1 kV, 20 A	WAKROBL20K01
Crocodile clip, red, 1 kV, 20 A	WAKRORE20K02
Test lead 1.2 m, red, 1 kV (banana plugs)	WAPRZ1X2REBB
Test lead 2.2 m, black, 1 kV (banana plugs)	WAPRZ2X2BLBB
Test lead 25 m, red (banana plugs, on a reel)	WAPRZ025REBBSZ
Test lead 25 m, blue (banana plugs, on a reel)	WAPRZ025BUBBSZ
Test lead 50 m, yellow (banana plugs, on a reel, shielded)	WAPRZ050YEBBSZE
Cable for battery charging from car cigarette lighter socket (12 V)	WAPRZLAD12SAM
USB cable	WAPRZUSB
Mains cable with IEC C7 plug	WAPRZLAD230
4x earth contact test probe (rod), 30 cm	WASONG30
L2 hanging straps (set)	WAPZOZSZEKPL
Cramp (banana socket)	WAZACIMA1
Z7 Power supply	WAZASZ7

Factory calibration certificate

Earthing resistance measurement - 3-pole and 4-lead method

measuring range according to EN 61557-5: 0.100 Ω...19.99 kΩ

Display range	Resolution	Accuracy
0.000...3.999 Ω	0.001 Ω	±(2% m.v. + 4 digits)
4.00...39.99 Ω	0.01 Ω	±(2% m.v. + 2 digits)
40.0...399.9 Ω	0.1 Ω	
400...3999 Ω	1 Ω	±(5% m.v. + 2 digits)
4.00 kΩ...19.99 kΩ	0.01 kΩ	

Resistance measurement of multiple earthing systems - 3-pole method with additional clamp

Display range	Resolution	Accuracy
0.000...3.999 Ω	0.001 Ω	±(8% m.v. + 4 digits)
4.00...39.99 Ω	0.01 Ω	±(8% m.v. + 3 digits)
40.0...399.9 Ω	0.1 Ω	
400...1999 Ω	1 Ω	

Measurement of multiple earthing systems - two-clamp method

Display range	Resolution	Accuracy
0.00...19.99 Ω	0.01 Ω	±(10% m.v. + 3 digits)
20.0...149.9 Ω	0.1 Ω	±(20% m.v. + 3 digits)

Measurement of earthing impedance - impulse method

Display range	Resolution	Accuracy
0.0...99.9 Ω	0.1 Ω	±(2.5% m.v. + 3 digits)
100...300 Ω	1 Ω	

The instrument meets the requirements set forth in standards:

- » EN 62305-1 (lightning protection)
- » EN 61010-1 (general and particular requirements related to safety)
- » EN 61010-031 (general and particular requirements related to safety)
- » EN 61326 (electromagnetic compatibility)
- » EN 61557 (requirements for measurement instruments)
- » HD 60364-6 (performance of measurements - checking)
- » HD 60364-4-41 (performance of measurements - shock protection)
- » PN-E 04700 (performance of measurements - commissioning tests)

Other technical specifications:

- » type of insulation double, as per EN 61010-1 and EN 61557
- » measurement category ... CAT IV 300 V (CAT III 600 V) acc. to EN 61010-1
- » number of measurements provided by set of batteries >1500

Nominal operating conditions:

- » operating temperature range -10...+50°C
- » storage temperature -20...+80°C
- » humidity 20...90%

SONEL MRU-120HD

index: WMGBMRU120HD



- CAT IV**
- 300 V**
- IP67**
closed cover
- IP54**
open cover
- 50°C**
HEAVY DUTY
10°C

200 mA
measurement current

soil resistivity without manual conversion

Earthing resistance measurements:

- » 3-pole method,
- » 4-lead method,
- » 3-pole method with additional clamp,
- » two-clamp method.

Soil resistivity measurements (Wenner method):

- » distances between electrodes can be input in meters (m) or feet (ft),
- » displaying the soil resistivity value in Ωm or Ωft .

Measurement of resistance of earth connection and equipotential bonding:

- » with auto-zeroing function - with current ≥ 200 mA
- » in compliance with EN 61557-4.

Additional functions of the meter:

- » measurement of auxiliary electrode resistances R_s and R_H ,
- » measurement of voltage and frequency of interference signal,
- » measurement in the presence of disturbance voltages in networks with frequencies of 50 Hz and 60 Hz,
- » selection of maximum measurement voltage (25 V or 50 V),
- » interoperability with ERP-1 adapter,
- » memory storing 990 measurements (10 banks with 99 cells each),
- » real-time clock (RTC),
- » data transmission to computer (USB),
- » reading of battery charge status, built-in quick charger.

MRU-120HD makes it possible to measure earthings, even without the use of auxiliary probes, by means of the double-clamp method.

The instrument meets the requirements set forth in the standards:

- » EN 61010-1 (general and particular requirements related to safety)
- » EN 61010-031 (general and particular requirements related to safety)
- » EN 61326 (electromagnetic compatibility)
- » EN 61557 (requirements for measurement instruments)
- » HD 60364-6 (performance of measurements - checking)
- » HD 60364-4-41 (performance of measurements - shock protection)
- » PN-E 04700 (performance of measurements - commissioning tests)

Other technical specifications:

- » type of insulation double, as per EN 61010-1 and EN 61557
- » measurement category CAT IV 300 V (CAT III 600 V) acc. to EN 61010-1
- » number of measurements provided by set of batteries >1100

Nominal operating conditions:

- » operating temperature range -10...+50°C
- » storage temperature -20...+80°C
- » humidity 20...85%

Standard accessories:

L4 carrying case	WAFUTL4
Test lead 4 m black 1 kV (banana plugs)	WAPRZ4X0BLBB
Test lead 4 m blue 1 kV (banana plugs)	WAPRZ4X0BUBB
Test lead 25 m, red (banana plugs, on a reel)	WAPRZ025REBBSZ
Test lead 25 m, blue (banana plugs, on a reel)	WAPRZ025BUBBSZ
Test lead 50 m, yellow (banana plugs, on a reel)	WAPRZ050YEBBSZ
USB cable	WAPRZUSB
Mains cable with IEC C7 plug	WAPRZLAD230
4x earth contact test probe (rod), 30 cm	WASONG30
2x clamp (banana socket)	WAZACIMA1
W1 hanging straps	WAPOZSZE5
Z7 Power supply	WAZASZ7
Factory calibration certificate	

Earthing resistance measurement - 3-pole and 4-lead method

measuring range according to EN 61557-5: 0.30 Ω ...19.9 k Ω

Display range	Resolution	Accuracy
0.00...19.99 Ω	0.01 Ω	±(2% m.v. + 2 digits)
20.0...199.9 Ω	0.1 Ω	
200...1999 Ω	1 Ω	
2.0...9.99 k Ω	0.01 k Ω	±(5% m.v. + 2 digits)
10.0...19.9 k Ω	0.1 k Ω	

Resistance measurement of multiple earthing systems - 3-pole method with additional clamp

Display range	Resolution	Accuracy
0.00...19.99 Ω	0.01 Ω	±(8% m.v. + 3 digits)
20.0...199.9 Ω	0.1 Ω	
200...1999 Ω	1 Ω	

Measurement of multiple earthing systems - two-clamp method

Display range	Resolution	Accuracy
0.00...19.99 Ω	0.01 Ω	±(10% m.v. + 3 digits)
20.0...149.9 Ω	0.1 Ω	±(20% m.v. + 3 digits)

MRU-120HD allows for measurements of multiple earthing systems without disconnection of test connections, by means of the 3-pole method with additional clamp or two-clamp method.



Earthing resistance and soil resistivity meter

SONEL MRU-120

index: WMGBMRU120 (with L2 case) / WMGBMRU120XL3 (with XL3 case)



CAT III
600 V

CAT IV
300 V

IP54

200 mA
measurement current



Earthing resistance measurements:

- » 3-pole method,
- » 4-lead method,
- » 3-pole method with additional clamp,
- » two-clamp method.

Soil resistivity measurements (Wenner method):

- » distances between electrodes can be input in meters (m) or feet (ft),
- » displaying the soil resistivity value in Ωm .

Measurement of resistance of earth connection and equipotential bonding:

- » with auto-zeroing function - with current ≥ 200 mA
- » in compliance with EN 61557-4.

Additional functions of the meter:

- » measurement of auxiliary electrode resistances R_S and R_H ,
- » measurement of voltage and frequency of interference signal,
- » measurement in the presence of disturbance voltages in networks with frequencies of 50 Hz and 60 Hz,
- » selection of maximum measurement voltage (25 V or 50 V),
- » interoperability with ERP-1 adapter,
- » memory storing 990 measurements (10 banks with 99 cells each),
- » real-time clock (RTC),
- » data transmission to computer (USB),
- » reading of battery charge status, built-in quick charger.



MRU-120 makes it possible to measure earthings, even without the use of auxiliary probes, by means of the double-clamp method.

The instrument meets the requirements set forth in the standards:

- » EN 61010-1 (general and particular requirements related to safety)
- » EN 61010-031 (general and particular requirements related to safety)
- » EN 61326 (electromagnetic compatibility)
- » EN 61557 (requirements for measurement instruments)
- » HD 60364-6 (performance of measurements - checking)
- » HD 60364-4-41 (performance of measurements - shock protection)
- » PN-E 04700 (performance of measurements - commissioning tests)

Other technical specifications:

- » type of insulation double, as per EN 61010-1 and EN 61557
- » measurement category CAT IV 300 V (CAT III 600 V) acc. to EN 61010-1
- » number of measurements provided by set of batteries >1100

Nominal operating conditions:

- » operating temperature range -10...+50°C
- » storage temperature -20...+80°C
- » humidity 20...85%

Standard accessories:

NiMH battery 4.8 V 3.2 Ah	WAAKU08
L2 carrying case (only WMGBMRU120)	WAFUTL2
XL3 carrying case (only WMGBMRU120XL3)	WAWALXL3
Crocodile clip, black, 1 kV, 20 A	WAKROBL20K01
Test lead 1.2 m, red, 1 kV (banana plugs)	WAPRZ1X2REBB
Test lead 2.2 m, black, 1 kV (banana plugs)	WAPRZ2X2BLBB
Test lead 25 m, red (banana plugs, on a reel)	WAPRZ025REBBSZ
Test lead 25 m, blue (banana plugs, on a reel)	WAPRZ025BUBBSZ
Test lead 50 m, yellow (banana plugs, on a reel)	WAPRZ050YEBBSZ
USB cable	WAPRZUSB
Mains cable with IEC C7 plug	WAPRZLAD230
4x earth contact test probe (rod), 30 cm	WASONG30
Pin probe, red 1 kV (banana socket)	WASONREOGB1
L2 hanging straps (set)	WAPOZSZEKPL
Cramp (banana socket)	WAZACIMA1
Z7 Power supply	WAZASZ7
Factory calibration certificate	

Earthing resistance measurement - 3-pole and 4-lead method

measuring range according to EN 61557-5: 0.30 Ω ...19.9 k Ω

Display range	Resolution	Accuracy
0.00...19.99 Ω	0.01 Ω	$\pm(2\% \text{ m.v.} + 2 \text{ digits})$
20.0...199.9 Ω	0.1 Ω	
200...1999 Ω	1 Ω	
2.0...9.99 k Ω	0.01 k Ω	$\pm(5\% \text{ m.v.} + 2 \text{ digits})$
10.0...19.9 k Ω	0.1 k Ω	

Resistance measurement of multiple earthing systems - 3-pole method with additional clamp

Display range	Resolution	Accuracy
0.00...19.99 Ω	0.01 Ω	$\pm(8\% \text{ m.v.} + 3 \text{ digits})$
20.0...199.9 Ω	0.1 Ω	
200...1999 Ω	1 Ω	

Measurement of multiple earthing systems - two-clamp method

Display range	Resolution	Accuracy
0.00...19.99 Ω	0.01 Ω	$\pm(10\% \text{ m.v.} + 3 \text{ digits})$
20.0...149.9 Ω	0.1 Ω	$\pm(20\% \text{ m.v.} + 3 \text{ digits})$



MRU-120 allows for measurements of multiple earthing systems without disconnection of test connections, by means of the 3-pole method with additional clamp or two-clamp method.



Earthing resistance and soil resistivity meter

SONEL MRU-30

index: WMGBMRU30



CAT III
300 V
IP65



Standard accessories:

L10 carrying case	WAFUTL10
M9 carrying case	WAFUTM9
Crocodile clip, black, 1 kV, 20 A	WAKROBL20K01
Test lead 1.2 m, red, 1 kV (banana plugs)	WAPRZ1X2REBB
Test lead 2.2 m, black, 1 kV (banana plugs)	WAPRZ2X2BLBB
Test lead 25 m, red (banana plugs, on a reel)	WAPRZ025REBBSZ
Test lead 50 m, yellow (banana plugs, on a reel)	WAPRZ050YEBBSZ
USB cable	WAPRZUSB
Mains cable with IEC C7 plug	WAPRZLAD230
2x earth contact test probe (rod), 30 cm	WASONG30
Pin probe, red 1 kV (banana socket)	WASONREOGB1
Cramp	WAZACIMA1
Z7 Power supply	WAZASZ7
Factory calibration certificate	

Earthing resistance measurements:

- » 3-pole method,
- » 4-lead method,
- » 3-pole method with additional clamp,
- » two-clamp method.

Soil resistivity measurements (Wenner method):

- » distances between electrodes can be input in meters (m) or feet (ft),
- » displaying the soil resistivity value in Ωm or Ωft.

Measurement of resistance of earth connection and equipotential bonding:

- » with auto-zeroing function - with current ≥200 mA
- » in compliance with EN 61557-4.

Additional functions of the meter:

- » measurement of auxiliary electrode resistances R_s and R_H ,
- » measurement of interference voltage,
- » measurement in the presence of disturbance voltages in networks with frequencies of 50 Hz and 60 Hz,
- » selection of maximum measurement voltage (25 V or 50 V),
- » memory storing 990 measurements (10 banks with 99 cells each),
- » data transmission to computer (USB),
- » reading of battery charge status.

Other technical specifications:

- » type of insulation double, as per EN 61010-1 and EN 61557
- » measurement category CAT III 300V according to EN 61010-1
- » housing protection rating according to EN 60529 IP65
- » LCD display segmented, with backlight
- » dimensions 200 x 150 x 73 mm

Nominal operating conditions:

- » operating temperature range -10...+50°C
- » storage temperature -20...+60°C
- » humidity 20...90%

Earthing resistance measurement - 3-pole and 4-lead method

measuring range according to EN 61557-5:2007: 0.53 Ω...9999 Ω for 50 V

Display range	Resolution	Accuracy
0.00...19.99 Ω	0.01 Ω	±(3% m.v. + 3 digits)
20.0...199.9 Ω	0.1 Ω	
200...1999 Ω	1 Ω	±5% m.v.
2000...9999 Ω	1 Ω	±8% m.v.

Resistance measurement of multiple earthing systems - 3-pole method with additional clamp

Display range	Resolution	Accuracy
0.00...19.99 Ω	0.01 Ω	±(3% m.v. + 3 digits)
20.0...199.9 Ω	0.1 Ω	
200...1999 Ω	1 Ω	±5% m.v.
2000...9999 Ω	1 Ω	±8% m.v.

Measurement of multiple earthing systems - two-clamp method

Display range	Resolution	Accuracy
0.00...19.99 Ω	0.01 Ω	±(10% m.v. + 8 digits)
20.0...99.9 Ω	0.1 Ω	±(20% m.v. + 3 digits)



Earthing resistance meter

SONEL MRU-21

index: WMGBMRU21



Earthing resistance measurement:

- » 3-pole method,
- » 2-pole method.

Resistance measurement - 2-pole method:

- » auto-zeroing of test leads

Measurement of resistance of earth connection and equipotential bonding:

- » meeting the requirements of EN 61557-4, with auto-zeroing function - with ≥ 200 mA current.

Additional functions of the meter:

- » measurement of auxiliary electrode resistances R_s and R_H ,
- » measurement of interference voltage,
- » measurement in the presence of disturbance voltages in the network,
- » selection of maximum measurement voltage (25 V or 50 V),
- » memory storing up to 990 results, data transmission to computer via USB cable,
- » reading of battery or rechargeable battery charge status,
- » power supply from batteries or rechargeable batteries,
- » automatic power down.

The instrument meets the requirements set forth in the standards:

- » EN 61010-1 (general and particular requirements related to safety)
- » EN 61010-031 (general and particular requirements related to safety)
- » EN 61326 (electromagnetic compatibility)
- » EN 61557 (requirements for measurement instruments)
- » HD 60364-6 (performance of measurements - checking)
- » HD 60364-4-41 (performance of measurements - shock protection)
- » PN-E 04700 (performance of measurements - commissioning tests)

Other technical specifications:

- » type of insulation double, as per EN 61010-1 and EN 61557
- » measurement category CAT IV 300V according to EN 61010-1
- » LCD display segmented, with backlight
- » number of measurements provided by set of alkaline batteries >1000 (5 Ω , 2/min)
- » dimensions 260 x 190 x 60 mm
- » weight including batteries 1.4 kg
- » this product meets EMC requirements in compliance with standards EN 61326-1 and EN 61326-2-2
- » power supply of the meter 4 x 1.5 V batteries or type C rechargeable batteries

Nominal operating conditions:

- » operating temperature range -10...+55°C
- » storage temperature -20...+70°C
- » humidity 20...90%

Standard accessories:

L4 carrying case	WAFUTL4
Crocodile clip, black, 1 kV, 20 A	WAKROBL20K01
Crocodile clip, blue, 1 kV, 20 A	WAKROBU20K02
Battery container	WAPOJ1
Test lead 1.2 m, blue, 1 kV (banana plugs)	WAPRZ1X2BUBB
Test lead 15 m, blue (on a reel)	WAPRZ015BUBBSZ
Test lead 2.2 m, black, 1 kV (banana plugs)	WAPRZ2X2BLBB
Test lead 30 m, red, (banana plugs, on a reel)	WAPRZ030REBBSZ
USB cable	WAPRZUSB
2x earth contact test probe (rod), 30 cm	WASONG30
L2 hanging straps (set)	WAPOZSZEKPL
Factory calibration certificate	

Earthing resistance measurement - 3-pole method

measuring range according to EN 61557-5:

0.50 Ω ...1.99 k Ω for 50 V; 0.68 Ω ...1.99 k Ω for 25 V

Display range	Resolution	Accuracy
0.00...9.99 Ω	0.01 Ω	$\pm(2\% \text{ m.v.} + 3 \text{ digits})$
10.0...99.9 Ω	0.1 Ω	
100...999 Ω	1 Ω	
1.00...1.99 k Ω	0.01 k Ω	

- » measurement current: >20 mA upon closing of circuit
- » frequency of measurement current: 125 Hz

Measurement of resistance of earth connection and equipotential bonding:

measuring range according to EN 61557-4: 0.13 Ω ...199 Ω

Display range	Resolution	Accuracy
0.00...9.99 Ω	0.01 Ω	$\pm(2\% \text{ m.v.} + 3 \text{ digits})$
10.0...99.9 Ω	0.1 Ω	
100...199 Ω	1 Ω	

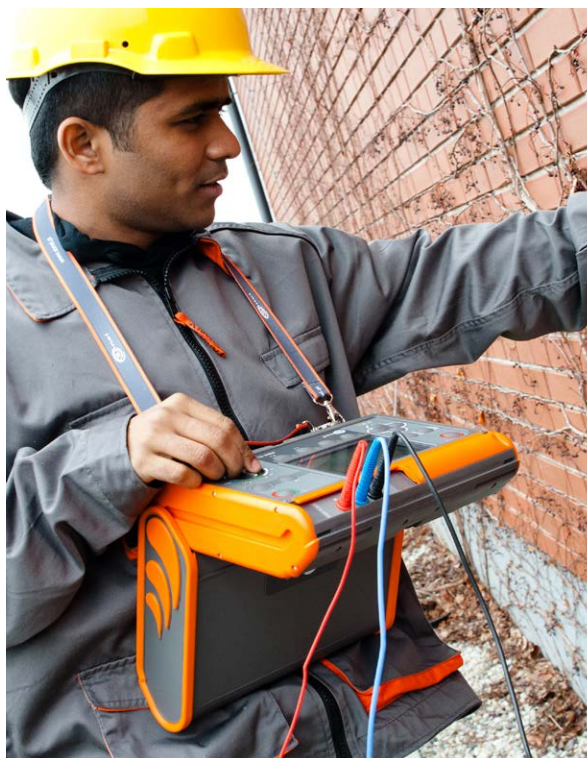

SONEL MRU-11

index: WMGBMRU11



CAT IV
150 V

CAT III
300 V

IP67



Standard accessories:

M6 carrying case	WAFUTM6
Crocodile clip, black, 1 kV, 20 A	WAKROBL20K01
Crocodile clip, blue, 1 kV, 20 A	WAKROBU20K02
Test lead 15 m, blue (banana plugs, on H-frame reel)	WAPRZ015BUBBN
Test lead 15 m, red (banana plugs, on H-frame reel)	WAPRZ015REBBN
Test lead 30 m, yellow (banana plugs, on H-frame reel)	WAPRZ030YEBBN
Test lead 2,2 m, black, 1 kV (banana plugs)	WAPRZ2X2BLBB
Test lead 2,2 m, blue, 1 kV (banana plugs)	WAPRZ2X2BUBB
4x earth contact test probe (rod), 25 cm	WASONG25
M1 hanging straps	WAPOZSZE4
M1 hanging hook straps	WAPOZUCH1
4x AA battery, LR6	
Factory calibration certificate	

Earthing resistance measurement - 3-pole and 4-lead method

measurement range to IEC 61557-5:2007: 0.53 Ω...9999 Ω for 50 V

Display range	Resolution	Accuracy
0.00...19.99 Ω	0.01 Ω	±(3% m.v. + 3 digits)
20.0...199.9 Ω	0.1 Ω	
200...1999 Ω	1 Ω	±5% m.v.
2000...9999 Ω	1 Ω	±8% m.v.

- » Measurement current: under short circuit >20 mA, frequency 125 Hz or 150 Hz, voltage selectable 25 V or 50 V.
- » Maximum interference voltage, at which R_E measurement is performed, equals 24 V.

Earthing resistance measurement - 2-pole method

Display range	Resolution	Accuracy
0.00...19.99 Ω	0.01 Ω	±(3% m.v. + 3 digits)
20.0...199.9 Ω	0.1 Ω	
200...1999 Ω	1 Ω	±5% m.v.
2000...9999 Ω	1 Ω	±8% m.v.

- » Measurement current: under short circuit >20 mA, frequency 125 Hz or 150 Hz, voltage selectable 25 V or 50 V.
- » Maximum interference voltage, at which R_E measurement is performed, equals 24 V.

Earthing resistance measurement:

- » 3-pole method,
- » 4-lead method,
- » 2-pole method.

Soil resistivity measurements (Wenner method):

- » distances between electrodes can be input in meters (m) or feet (ft),
- » displaying the soil resistivity value in Ωm or Ωft.

Additional functions of the meter:

- » measurement of auxiliary electrode resistances R_S and R_H ,
- » measurement of interference voltage,
- » selection of maximum measurement voltage (25 V or 50 V),
- » reading of battery or rechargeable battery charge status,
- » automatic power down.

Other technical specifications:

- » type of insulation double, as per EN 61010-1 and EN 61557
- » measurement category CAT IV 150 V (III 300 V) according to EN 61010-1
- » housing protection rating according to EN 60529 IP67
- » power supply of the meter alkaline batteries or NiMH AA rechargeable batteries (4 pcs.)
- » LCD display segment, backlit
- » the meter meets the EMC requirements acc. to standards EN 61326-1 and EN 61326-2-2
- » dimensions 221 x 102 x 62 mm
- » weight with batteries approx. 660 g

Nominal operating conditions:

- » operating temperature -10...+50°C
- » storage temperature -20...+60°C
- » reference temperature +23±2°C
- » humidity 20...90%



Earthing resistance meter

SONEL MRU-10

index: WMGBMRU10



CAT IV

150 V

CAT III

300 V

IP67

Earthing resistance measurement:

- » 3-pole method,
- » 2-pole method.

Additional functions of the meter:

- » measurement of auxiliary electrode resistances R_s and R_H ,
- » measurement of interference voltage,
- » selection of maximum measurement voltage (25 V or 50 V),
- » reading of battery or rechargeable battery charge status,
- » automatic power down.

Other technical specifications:

- » type of insulation double, as per EN 61010-1 and EN 61557
- » measurement category CAT IV 150 V (III 300 V) according to EN 61010-1
- » housing protection rating according to EN 60529 IP67
- » power supply of the meter alkaline batteries or NiMH AA rechargeable batteries (4 pcs.)
- » LCD display segment, backlit
- » the meter meets the EMC requirements acc. to standards EN 61326-1 and EN 61326-2-2
- » dimensions 221 x 102 x 62 mm
- » weight with batteries approx. 660 g

Nominal operating conditions:

- » operating temperature -10...+50°C
- » storage temperature -20...+60°C
- » reference temperature +23±2°C
- » humidity 20...90%

Standard accessories:

M6 carrying case	WAFUTM6
Crocodile clip, black, 1 kV, 20 A	WAKROBL20K01
Test lead 15 m, red (banana plugs, on H-frame reel)	WAPRZ015REBBN
Test lead 30 m, yellow (banana plugs, on H-frame reel)	WAPRZ030YEBBN
Test lead 2,2 m, black, 1 kV (banana plugs)	WAPRZ2X2BLBB
2x earth contact test probe (rod), 25 cm	WASONG25
M1 hanging straps	WAPOZSZE4
M1 hanging hook straps	WAPOZUCH1
4x AA battery, LR6	
Factory calibration certificate	

Earthing resistance measurement - 3-pole method

measurement range to IEC 61557-5:2007: 0.53 Ω...9999 Ω for 50 V

Display range	Resolution	Accuracy
0.00...19.99 Ω	0.01 Ω	±(3% m.v. + 3 digits)
20.0...199.9 Ω	0.1 Ω	
200...1999 Ω	1 Ω	±5% m.v.
2000...9999 Ω	1 Ω	±8% m.v.

- » Measurement current: under short circuit >20 mA, frequency 125 Hz or 150 Hz, voltage selectable 25 V or 50 V.
- » Maximum interference voltage, at which R_E measurement is performed, equals 24 V.

Earthing resistance measurement - 2-pole method

Display range	Resolution	Accuracy
0.00...19.99 Ω	0.01 Ω	±(3% m.v. + 3 digits)
20.0...199.9 Ω	0.1 Ω	
200...1999 Ω	1 Ω	±5% m.v.
2000...9999 Ω	1 Ω	±8% m.v.

- » Measurement current: under short circuit >20 mA, frequency 125 Hz or 150 Hz, voltage selectable 25 V or 50 V.
- » Maximum interference voltage, at which R_E measurement is performed, equals 24 V.



MRU

Set of standard and optional accessories

1, 2, 4 - number of standard accessories
 . - optional accessories

Photo	Name	Index	MRU-200-GPS (L2)	MRU-200-GPS (XL3)	MRU-200 (L2)	MRU-200 (XL3)	MRU-120HD	MRU-120 (L2)	MRU-120 (XL3)	MRU-30	MRU-21	MRU-11	MRU-10	ERP-1
	ERP-1 adapter for earth resistance measurements	WAADAERP1					
	ERP-1 adapter for earth resistance measurements with FS-2 flexible coil	WAADAERP1V2					
	ERP-1 adapter for earth resistance measurements with FSX-3 flexible coil	WAADAERP1V3					
	F-1A flexible coil (Ø360 mm)	WACEGF1AOKR
	F-2A flexible coil (Ø235 mm)	WACEGF2AOKR
	F-3A flexible coil (Ø120 mm)	WACEGF3AOKR
	F-4A flexible coil (Ø630 mm)	WACEGF4OKR
	FS-2 flexible coil (Ø1260 mm)	WACEGFS2OKR
	FSX-3 flexible coil (Ø630 mm)	WACEGFSX3OKR
	N-1 transmitting clamp (Ø52 mm)	WACEGN1BB				
	C-3 current clamp (Ø52 mm)	WACEGC3OKR				
	Crocodile clip, black, 1 kV, 20 A	WAKROBL20K01	1	1	1	1	.	1	1	1	1	1	1	
	Crocodile clip, red, 1 kV, 20 A	WAKRORE20K02	1	1	1	1	
	Crocodile clip, blue, 1 kV, 20 A	WAKROBU20K02	1	1	.	
	Crocodile clip, yellow, 1 kV, 20 A	WAKROYE20K02	
	Test lead 1.2 m, black, 1 kV (banana plugs)	WAPRZ1X2BLBB	
	Test lead 1.2 m, red, 1 kV (banana plugs)	WAPRZ1X2REBB	1	1	1	1	.	1	1	1	.	.	.	
	Test lead 1.2 m, blue, 1 kV (banana plugs)	WAPRZ1X2BUBB	1	.	.	
	Test lead 1.2 m, yellow, 1 kV (banana plugs)	WAPRZ1X2YEBB	
	Double-wire test lead 2 m, for N-1 clamps (banana plugs)	WAPRZ002DZBB	
	Test lead 2.2 m, black, 1 kV (banana plugs)	WAPRZ2X2BLBB	1	1	1	1	.	1	1	1	1	1	1	
	Test lead 2.2 m, red, 1 kV (banana plugs)	WAPRZ2X2REBB	

Photo	Name	Index	MRU-200-GPS (L2)	MRU-200-GPS (XL3)	MRU-200 (L2)	MRU-200 (XL3)	MRU-120HD	MRU-120 (L2)	MRU-120 (XL3)	MRU-30	MRU-21	MRU-11	MRU-10	ERP-1
	Test lead 2.2 m, blue, 1 kV (banana plugs)	WAPRZ2X2BUBB	1	.	
	Test lead 2.2 m, yellow, 1 kV (banana plugs)	WAPRZ2X2YEBB	
	Test lead 4 m black 1 kV (banana plugs)	WAPRZ4X0BLBB	1	
	Test lead 4 m blue 1 kV (banana plugs)	WAPRZ4X0BUBB	1	
	Test lead 15 m, blue (on a reel)	WAPRZ015BUBBSZ	1	.	.	
	Test lead with banana plug; 15 m; red	WAPRZ015REBBN	1	1	
	Test lead with banana plug; 15 m; blue	WAPRZ015BUBBN	1	.	
	Test lead 25 m, red (banana plugs, on a reel)	WAPRZ025REBBSZ	1	1	1	1	.	1	1	1	.	.	.	
	Test lead 25 m, blue (banana plugs, on a reel)	WAPRZ025BUBBSZ	1	1	1	1	1	1	1	
	Test lead 30 m, red (banana plugs, on a reel)	WAPRZ030REBBSZ	1	.	.	
	Test lead with banana plugs; 30 m; yellow	WAPRZ030YEBBN	1	1	
	Test lead 50 m, yellow (banana plugs, on a reel)	WAPRZ050YEBBSZ	1	1	1	1	.	.	.	
	Test lead 50 m, yellow (banana plugs, on a reel, shielded)	WAPRZ050YEBBSZE	1	1	1	1								
	Test lead 75 m, red (banana plugs, on a reel)	WAPRZ075REBBSZ	
	Test lead 75 m, blue (banana plugs, on a reel)	WAPRZ075BUBBSZ	
	Test lead 75 m, yellow (banana plugs, on a reel)	WAPRZ075YEBBSZ	
	Test lead 75 m, yellow (banana plugs, on a reel, shielded)	WAPRZ075YEBBSZE								
	Test lead 100 m, red (banana plugs, on a reel)	WAPRZ100REBBSZ	
	Test lead 100 m, blue (banana plugs, on a reel)	WAPRZ100BUBBSZ	
	Test lead 100 m, yellow (banana plugs, on a reel)	WAPRZ100YEBBSZ	
	Test lead 100 m, yellow (banana plugs, on a reel, shielded)	WAPRZ100YEBBSZE								
	Test lead 200 m, red, (banana plugs, on a reel)	WAPRZ200REBBSZ	

MRU

Set of standard and optional accessories















1, 2, 4 - number of standard accessories
 - - optional accessories

Photo	Name	Index	MRU-200-GPS (L2)	MRU-200-GPS (XL3)	MRU-200 (L2)	MRU-200 (XL3)	MRU-120HD	MRU-120 (L2)	MRU-120 (XL3)	MRU-30	MRU-21	MRU-11	MRU-10	ERP-1
	Test lead 200 m, blue, (banana plugs, on a reel)	WAPRZ200BUBBSZ	•	•	•	•	•	•	•	•	•	•	•	
	Test lead 200 m, yellow (banana plugs, on a reel)	WAPRZ200YEBBSZ	•	•	•	•	•	•	•	•	•	•	•	
	Test lead 200 m, yellow (banana plugs, on a reel, shielded)	WAPRZ200YEBBSZE	•	•	•	•								
	Pin probe, black 1 kV (banana socket)	WASONBLOGB1	•	•	•	•	•	•	•	•	•	•	•	
	Pin probe, red 1 kV (banana socket)	WASONREOGB1	•	•	•	•	•	1	1	1	•	•	•	
	Pin probe, blue 1 kV (banana socket)	WASONBUOGB1	•	•	•	•	•	•	•	•	•	•	•	
	Pin probe, yellow 1 kV (banana socket)	WASONYEGB1	•	•	•	•	•	•	•	•	•	•	•	
	Earth contact test probe (rod), 25 cm	WASONG25	•	•	•	•	•	•	•	•	•	4	2	
	Earth contact test probe (rod), 30 cm	WASONG30	4	4	4	4	4	4	4	2	2	•	•	
	Earth contact test probe (rod), 80 cm	WASONG80V2	•	•	•	•	•	•	•	•	•	•	•	
	Cramp	WAZACIMA1	1	1	1	1	2	1	1	1	•	•	•	
	NiMH battery 4.8 V 4.2 Ah	WAAKU07	1	1	1	1		•	•					
	NiMH battery 4.8 V 3.2 Ah	WAAKU08						1	1					
	NiMH battery 4.8 V 4.2 Ah (replaceable in the SONEI S.A. service)	WAAKU28					1							
	Battery pack	WAP0J1	•	•	•	•		•	•		1			
	Z7 power supply	WAZASZ7	1	1	1	1	1	1	1	1				
	Mains cable with IEC C7 plug	WAPRZLAD230	1	1	1	1	1	1	1	1				
	Cable for battery charging from car cigarette lighter socket (12 V)	WAPRZLAD12SAM	1	1	1	1	•	•	•	•				
	Test wire reel	WAP0ZSZP1	•	•	•	•	•	•	•	•	•	•	•	
	L2 hanging straps (set)	WAP0ZSZEKPL	1	1	1	1		1	1		1			
	M1 hanging straps	WAP0ZSZE4										1	1	
	W1 hanging straps	WAP0ZSZE5					1							

MRU

Set of standard and optional accessories

1, 2, 4 - number of standard accessories
 · - optional accessories

Photo	Name	Index	MRU-200-GPS (L2)	MRU-200-GPS (XL3)	MRU-200 (L2)	MRU-200 (XL3)	MRU-120HD	MRU-120 (L2)	MRU-120 (XL3)	MRU-30	MRU-21	MRU-11	MRU-10	ERP-1
	M1 hanging hook straps	WAPOZUCH1										1	1	
	Cover (universal)	WAPOZUCH12	·	·	·	·		·	·		·			
	L2 carrying case	WAFUTL2	1	·	1	·		1	·					
	L3 carrying case for a 80 cm rods	WAFUTL3	·	·	·	·	·	·	·	·	·	·	·	
	L4 carrying case	WAFUTL4					1				1			
	L7 backpack	WAFUTL7					·							
	L10 carrying case	WAFUTL10								1				
	M6 carrying case	WAFUTM6										1	1	
	M9 carrying case	WAFUTM9								1				
	XL3 carrying case (accessories not included)	WAWALXL3	·	1	·	1		·	1					
	XL8 carrying case	WAWALXL8												·
	USB cable	WAPRZUSB	1	1	1	1	1	1	1	1	1			
	PC software: Sonel Reports Plus	WAPROREPORTSPUS	·	·	·	·	·	·	·	·	·			
	PC software: Sonel Reader	WAPROREADER	·	·	·	·	·	·	·	·	·			

SONEL MRU MOBILE



Mobile version of the program cooperating with ground resistance and ground resistivity meters **MRU-200** and **MRU-200-GPS**. It can be downloaded from **Google Play**.

Thanks to the application, you can **connect directly to the device** via Bluetooth and download measurement data from the meter. After reading the measurements from the device, they can be easily and quickly **viewed**, and also **sent from the place of measurement** to a person who can help in interpretation of data or make a measurement report.

Thanks to the application, you can enrich the measurement with a photo, comments or voice memo. From the application level, we also have **access to the meter's manual** and help regarding various measurement methods.

Users who do not have a meter can use the set of **sample data** implemented in demo mode.

SONEL REPORTS PLUS



Sonel Reports Plus supports creation of documentation after testing of electrical installation. The software communicates with Sonel test instruments, downloads data from memory of the devices and creates necessary documentation. Many useful functions are included in order to help creating documentation of the measurements. Sonel Reports Plus supports **MPI-540-PV**, **MPI-540**, **MPI-536**, **MPI-535**, **MPI-530-IT** and **MPI-530** by reading, downloading and uploading test structure from/to test instrument.

- » Every report can contain description page.
- » Tree structure presents a clear picture of the tested building and its rooms. Test structure can be uploaded to the meter and downloaded from it together with test results.
- » User can print labels for test points.
- » For every room user can add picture or scheme of electrical installation.
- » Software contains library of fuses.
- » For every room user can create separate table with test results.

Measurement sets



Set for installation and grounding measurements in photovoltaic systems

SONEL WME-8

index: WMGBWME8



PVM-1020
Photovoltaic meter



IRM-1
Solar radiation
and temperature meter



MRU-10
Earth resistance meter

Capabilities

- » **PVM-1020** | It can be used for category 1 measurements according to IEC 62446-1.
- » **PVM-1020** | It converts measured parameters into STC conditions according to IEC 60891 by cooperation with the IRM-1 solar radiation and temperature meter.
- » **IRM-1** | Measurement of solar radiation and temperature.
- » **IRM-1** | The LoRa interface for communication with a master meter – offers a larger range than the Bluetooth technology!
- » **MRU-10** | Earthing resistance measurements of photovoltaic installations using the 3-pole method.

	PVM-1020	IRM-1	MRU-10
Safety and work conditions			
Measuring category according to EN 61010	IV 300 V, III 600 V, II 1000 V DC	-	III 300 V
Ingress protection	IP65	IP65	IP67
Dimensions	228 x 102 x 61 mm	134 x 79 x 28 mm	220 x 102 x 61 mm
Weight	ca. 1.0 kg	ca. 0.2 kg	ca. 0.7 kg
Memory and communication			
Memory of measurement results	4 059 records	user measurement memory: 999 records recorder: 5000 records	-
Data transmission	Bluetooth	USB	-
Communication with IRM-1	LoRa	-	-
Communication with a master meter	-	LoRa	-

Standard accessories:

PVM-1020 meter	WMGBPVM1020
IRM-1 meter	WMGBIRM1
MRU-10 meter	WMGBMRU10
MC4-banana sockets adapter (set of 2 pcs.)	WAADAMC4
C-PV clamp	WACEGCPVOKR
Test lead 1.2 m, black, 1 kV (banana plugs)	WAPRZ1X2BLBB
Test lead 1.2 m, red, 1 kV (banana plugs)	WAPRZ1X2REBB
Test lead 1.2 m, yellow, 1 kV (banana plugs)	WAPRZ1X2YEBB
Test lead 2.2 m black 1 kV (banana plugs)	WAPRZ2X2BLBB
Test lead 15 m red on a reel (banana plugs)	WAPRZ015REBBSZ
Test lead 30 m yellow on a reel (banana plugs)	WAPRZ030YEBBSZ
Test probe with banana socket; 1 kV; red	WASONREOGB1
2x earth contact test probe (rod), 25 cm	WASONG25
Yellow "crocodile" clip 1 kV 20 A	WAKROYE20K02
Red "crocodile" clip 1 kV 20 A	WAKRORE20K02
2x black "crocodile" clip 1 kV 20 A	WAKROBL20K01
5 V power supply with USB 2.0 output and a detachable micro-USB cable	WAZASZ24
8x AA 1.5 V battery	
2x AAA 1.5 V battery	
IRM-1 mounting&measuring set	WASONTPVCKPL
XL-14 hard case	WAWALXL14
2x meter strap (type M-1)	WAPOZSZE4
Factory calibration certificate - PVM-1020	
Factory calibration certificate - IRM-1	
Factory calibration certificate - MRU-10	



Temperature measurements

Fever detection

KT-800M
KT-120M

Industry

KT-1K
KT-670
KT-650
KT-560

KT-400
KT-200
KT-256F
KT-256
KT-128

DIT-500
DIT-200
DIT-130
DIT-120

Contactless temperature measurements



Thermal imaging is a process based on **processing infrared radiation**, that is the heat emitted by objects, **into a visible image**, making possible to assess temperature distribution on the surface of the observed object without contact.

This is important wherever it is necessary to measure temperature at inaccessible or hazardous locations and also allows for:

- » quick temperature measurement on surfaces of any size,
- » or lightning-fast location of heat escape points invisible to the naked eye related to failures in buildings' insulation and construction errors (thermal bridges for example).

In thermographic analysis, **contactless measurement in the infrared spectrum** is used to determine the temperature of a surface from a distance. Since all objects with a temperature above absolute zero emit thermal radiation of similar characteristics (called black-body radiation), by measuring the radiation and with knowledge of the emissivity coefficient of a given object, its temperature can be determined.

Professional radiometric thermal imaging cameras register temperature separately for each point of the image. For example, in the case of a camera with a 640 x 480 resolution, temperature is registered simultaneously for each of the 307200 points. This makes it possible to conduct detailed analysis of saved thermal images, which display different temperatures as different colors.

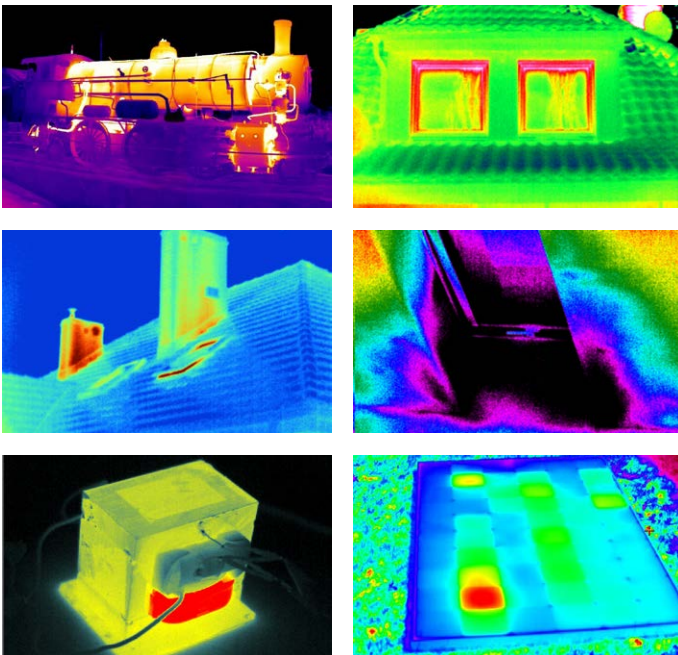

All information saved in a thermogram can be used by specialized software delivered with the thermal imaging camera. During analysis of a thermogram, points with maximum or minimum temperature can be determined, the emissivity coefficient of the whole thermogram or a part of it can be corrected, temperature can be read at any point of the thermogram, mean temperature can be calculated, temperature distribution can be presented in the form of histograms or isotherms, the thermal image can be combined with the real image, just as on the screen of the

camera, which makes it possible to precisely locate places with a specific temperature, and the color palette can be changed arbitrarily to best represent the temperature distribution.

One useful function of thermal imaging cameras is the **capability of taking real-life photographs** as well as **combined image modes** enabling combination of the real-life image with the thermal image and displaying an image in which the thermal image overlaps with the real-life image.

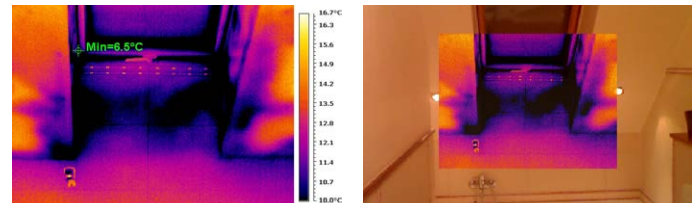

A thermal image is presented on-screen in the color palette selected by the user that best represents individual temperature ranges:

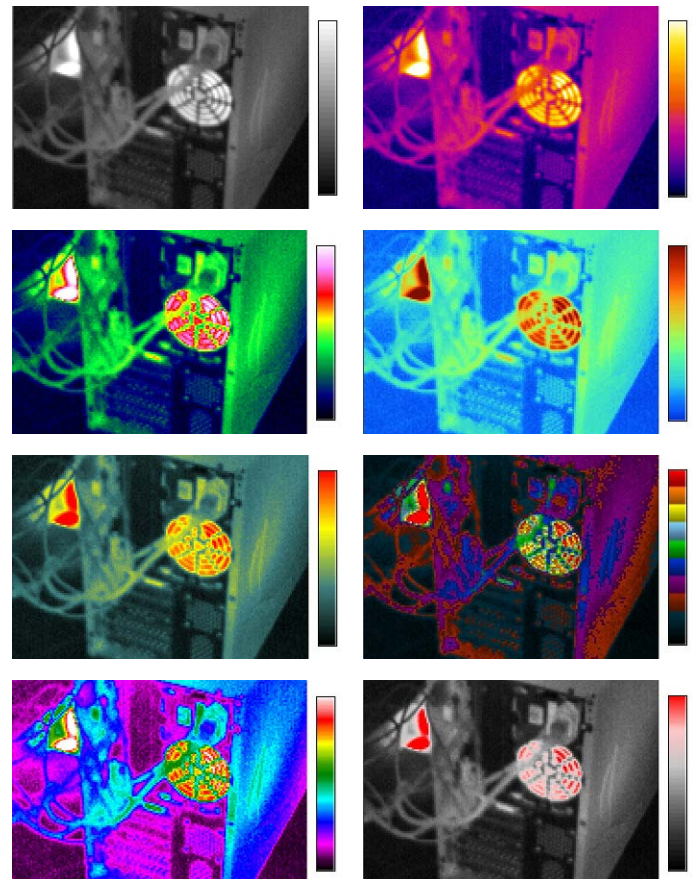

Infrared thermometers are also devices that serve for contactless temperature measurement, and they operate on the basis of **analysis of the thermal radiation** emitted by the tested object. These devices are applied whenever it is required to measure wide range of temperatures.

The main **parameters** characterizing an infrared thermometer are: measured temperature ranges, accuracy and **D:S ratio**, which is the ratio of the distance from the object to the diameter of the field for which the measurement is made.

Thanks to their design, pyrometers allow to measure temperature of small objects, also from great distance. The bigger D:S ratio is, the smaller objects can be measured from big distance.



THERMAL IMAGERS

BODY TEMPERATURE MEASUREMENTS
 » the highest accuracy
 » narrow range

INDUSTRIAL APPLICATION
 » high accuracy
 » wide range

IR THERMOMETERS

INDUSTRIAL APPLICATION
 » high accuracy
 » wide range

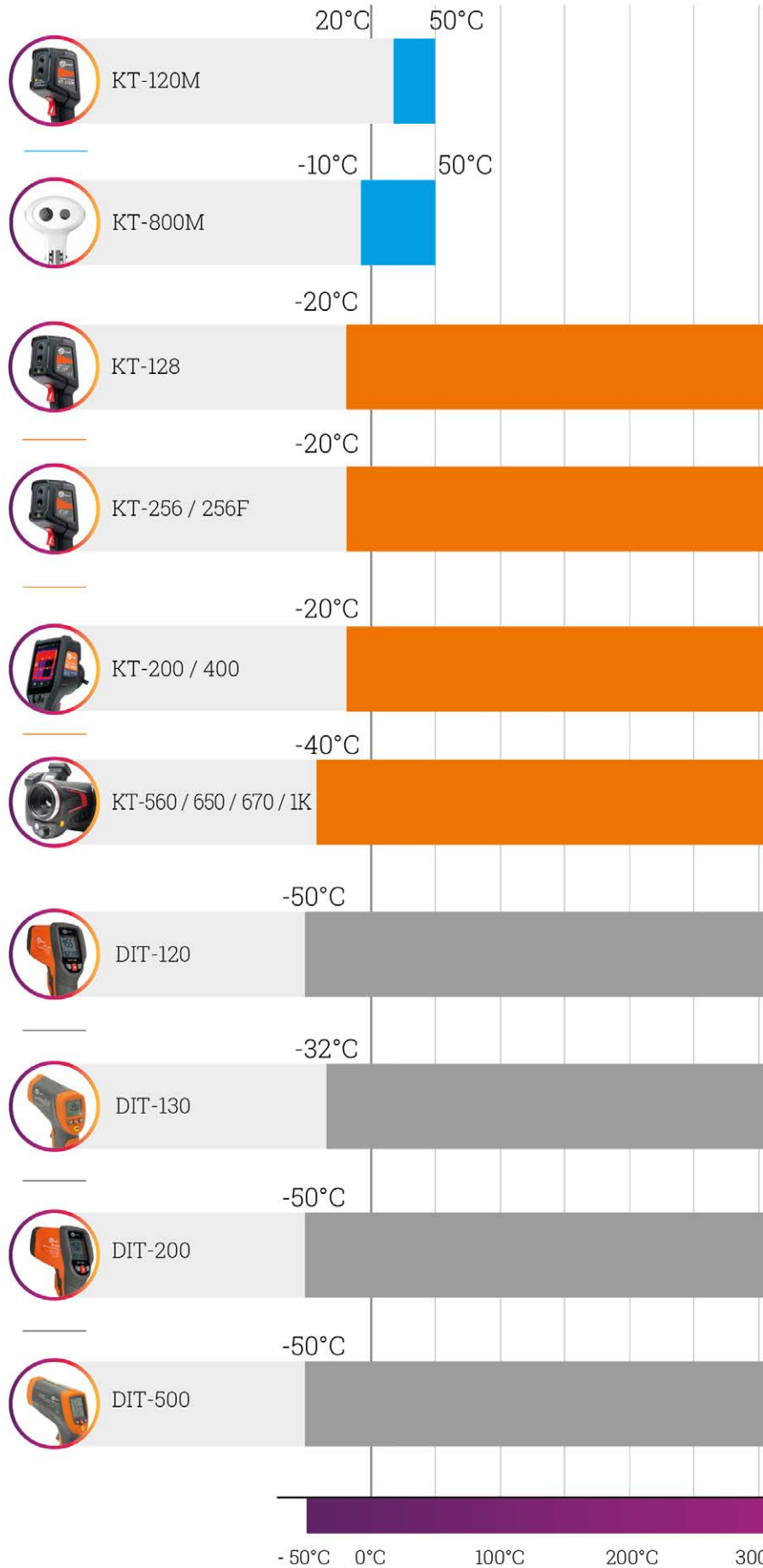

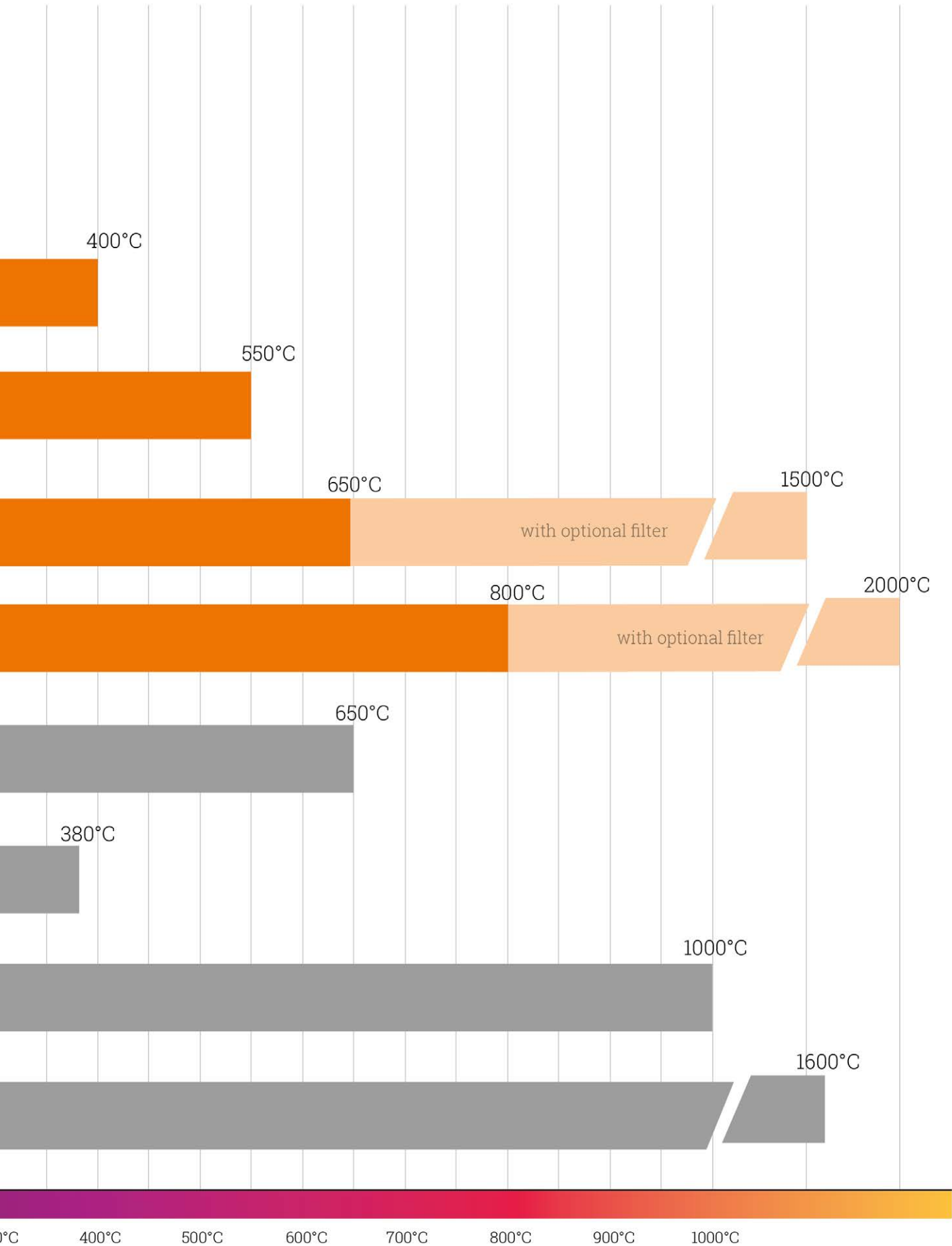

SONEL KT-800M

index: WMGBKT800M



Thermal imager	
Detector resolution	400 x 300 / 17 μ m
Frame rate	25 Hz
Sensitivity	≤ 40 mK
Lens (field of view / focal distance)	38° x 28° / 9.7 mm
Accuracy	$\leq \pm 0.3^{\circ}\text{C}$ (ambient temperature 16...32°C)
Measurement range	-10...+50°C
Calibration	Built-in shutter and external black body, automatic calibration mode
Visual camera	
Resolution	2 MPix
Frame rate	25 Hz
Functions	
Parameter settings	Warning switch and warning threshold value, number of warning targets, warning photos automatic clearing, shielding fixed high temperature objects
Face tracking	Intelligent face tracking
Real-time preview	Real-time preview of visible and thermal image
Real-time spot temperature detection	Real-time temperature monitoring at any point in the field of view
Automatic tracking	Support automatic tracking for elevated temperatures
Automatic warning	Automatic tracking, warning and photo capturing for storage when person with fever is detected. Warning while the blackbody is blocked
Historical records	Support query, classification and deletion of historical warning screenshots
Video recording	Supported. The software needs to be upgraded to V1.1.0.9, and equipped with NVR (NVR standard 4T hard disk). Supports GB28181 protocol to access third-party platforms
Network communication protocol	HTTP, RTSP
Environmental conditions	
Operating temperature	-10...+50°C (ambient temperature 16...32°C)
Storage temperature	-20...+60°C
Humidity	<90% (non-condensing)
Shock	30g 11 ms, IEC 60068-2-27
Vibration	10 Hz ~ 150 Hz ~ 10 Hz 0.15 mm, IEC60068-2-6
Black body	
Blackbody target surface uniformity	$\leq 0.1^{\circ}\text{C}$
Temperature stability	$\leq \pm 0.2^{\circ}\text{C}$ (single point)
Camera head interface	
Network interface	Two-way, visible light 100M, infrared 1000M
Camera head power	
Input voltage	DC 12 V
Input power	≤ 12 W
Camera head size	173 x 184 x 212 mm
Total height (incl. stand)	2200 mm

Overview

Sone! KT-800M IR Fever Warning System can be applied to mass fever screening in crowded public places, which helps detect people with potential fever. It may contain or limit the spread of diseases through identification of infected individuals showing fever symptoms. Sone! KT-800M combines advanced technology such as thermographic human temperature detection and AI intelligent face tracking which makes the equipment accurate and easy to use.

Sone! KT-800M is equipped with various powerful functions. Multi-target tracking ensures that no target is missed. Custom warning zones and high-temperature shielding settings help avoiding interference from other high-temperature objects. When a feverish person is detected, the system supports automatic warning, tracking and photo taking for storage. It also supports video recording. Convenient for query and classify management.

Application

Large-scale temperature screening at airports, railway stations, subway stations, hospitals, supermarkets, factories, schools and other places with large flow of people to control and reduce the spread of diseases and viruses with fever symptoms.

Features

- » 400 x 300 px infrared uncooled Vox detector
- » Automatic focus on a person's face
- » Warning sound alarm when a person with fever is detected
- » Accurate single-point and multi-point high temperature tracking and warning
- » AI deep learning algorithm based on neural network provides more accurate temperature detection and lower false warning rate
- » Real-time temperature calibration with blackbody ensures high accuracy
- » Stand-type, easy to deploy, equipped with PC with powerful analysis software

Standard accessories:

Black Body	WAADABBK800M
Tripod	WAADASTATYWKT800M
Cable set	WAPRZKPLKT800M
Computer set	WAZESTAWKOMPKT800M
Factory calibration certificate	



SONEL KT-120M

index: WMGBKT120M



 IP54

Detector resolution	120 x 90 / 17 µm
Spectral range	7.5~14 µm
Frame rate	25 Hz
Sensitivity	60 mK
Lens (field of vision / focal distance)	50° x 38°/2.28 mm
Spatial resolution (IFOV)	7.6 mrad
Display	2.4", 240 x 320, LCD
Image mode	IR
Temperature range	20°C...50°C
Accuracy	±0.5°C (ambient temperature 23°C ± 2°C, humidity ≤80%, target distance 0.8 m, target temperature 32°C...42°C)
Image analysis mode	Temperature indication, temperature alarm
Image file format	JPG
Interfaces	microSD card slot (max. 32 GB), USB type C, tripod
Memory	SD card (max. 32 GB)
Power supply	Li-Ion battery (operating time >8 hours), built-in charger (charging time <2.5 hour), AC adapter 110-230 V, 50/60 Hz
Operating temperature	-10°C...+50°C
Storage temperature	-40°C...+70°C
Housing	IP54
Weight	ca. 0.35 kg

Simple thermography

KT-120M is a special camera. Economical, practical and handy, it is a powerful tool in preventing or limiting epidemics. The user can measure the temperature with 0.5°C accuracy. The exceeding of the threshold value is signalled by an alarm. All this in order to quickly and efficiently detect people with fever - e.g. infected with a virus giving such symptoms.

Application

KT-120M is used wherever many people need to be tested for body temperature. Particularly useful in:

- » factories,
- » schools,
- » shopping malls,
- » office buildings.

Features

- » measuring range 20°C...50°C
- » accuracy up to ±0.5°C
- » fast temperature measurement
- » automatic signalling of fever detection
- » saving IR images to SD card
- » built-in Li-Ion battery with 8-hour working time
- » interfaces: USB type C, SD slot
- » can be set up on a tripod

Standard accessories:

USB charger	WAZASZ20
Type C USB cable	WAPRZUSBC
16 GB microSD card	WAPOZMSD16
Wristband	WAPOZPAS1
Declaration of verification	

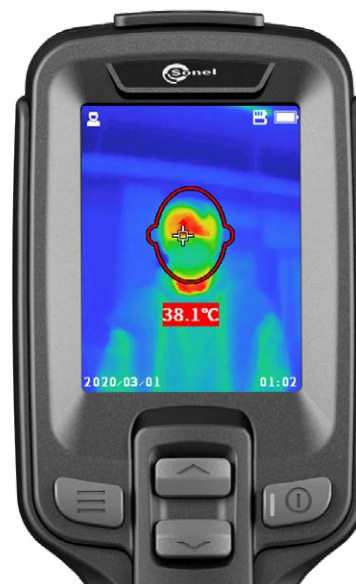

SONEL KT-1K / KT-670 / KT-650 / KT-560

index: WMGBKT1K / WMGBKT6701 / WMGBKT6501 / WMGBKT5601



- IP54
- GPS
- WiFi
- BLUETOOTH
- TOUCH SCREEN
- LASER RANGEFINDER



	KT-560	KT-650	KT-670	KT-1K
Detector type	384 x 288 / 17 μm		640 x 480 / 17 μm	1024 x 768 / 12 μm
Spectral range			7.5~14 μm	
Sensitivity	45 mK	40 mK	35 mK	≤30 mK
Lens (field of view / focal length / instantaneous field of view / min. focus distance)				
• standard	24.9° x 18.7° / 15 mm / 1.13 mrad / 0.4 m	24.6° x 18.5° / 25 mm / 0.68 mrad / 0.3 m		24.6° x 18.5° / 28 mm / 0.43 mrad / 0.3 m
• wide angle	48.1° x 35.9° / 7.78 mm / 2.19 mrad / 0.15 m	45.4° x 34.8° / 13 mm / 1.31 mrad / 0.15 m		-
• telephoto	11.2° x 8.4° / 33 mm / 0.52 mrad / 2 m	11.3° x 8.5° / 55 mm / 0.31 mrad / 1.5 m		-
• ultra-telephoto	7.3° x 5.5° / 50.7 mm / 0.34 mrad / 4 m	7.3° x 5.5° / 85 mm / 0.2 mrad / 4 m		-
• macro	23.3 mm x 17.5 mm / 67 mm / - / 60.7 μm	23.3 mm x 17.5 mm / 67 mm / - / 37.5 μm		-
• high temp	24.9° x 18.7° / - / -	24.6° x 18.5° / - / - / -		24.6° x 18.5° / - / - / -
Display		5", 1280 x 720 high brightness, LCD touchscreen		
Viewfinder		1280 x 960 LCOS		
Image mode		IR / Visual / Infrarufusion MIF/ PiP		
Zoom	1...10		1...35	
Temperature range		Range 1: -40°C...150°C Range 2: 100°C...800°C Optional: 700°C...2000°C		
Accuracy	±2°C or 2% of reading		±1°C or ±1% of reading	
Image analysis mode	12 points, 12 lines, 12 areas. Temperature readings: min., max., average. Isotherms. Temperature alarm. Smart stroke	16 points, 16 lines, 16 areas. Temperature readings: min., max., average. Isotherms. Temperature alarm. Smart stroke	12	30 points, 30 lines, 30 areas. Temperature indication: min, max, average. Isotherm. Temperature alarm. Smart stroke.
Palettes	8	10		12
Super-resolution	4x, 768 x 576	4x, 1280 x 960		2048 x 1536
Panoramic images			√	
Emissivity coefficient	Set from 0.01 to 1.00			
Measurement correction	Auto-adjustable distance, relative humidity, ambient temperature (reflected)			
Image file format	JPG			
Notes on IR images	Additional visual photos, voice, text recognition, text typing			
Reports module	PDF reports			
Video file format	MP4 (without temp. information), IRGD (including temp. information)			
Built-in functions	Visual camera 13 MPix, LED flashlight, GPS, laser pointer, laser rangefinder, mi-crophone, speaker, digital compass, light sensor.			
Wireless communication	Wi-Fi, Bluetooth			
Storage	Built-in memory (64 GB), SD card, cloud service			
Interfaces	SD card slot (max. 64 GB), LAN 1 Gb/s, micro HDMI, USB type C (data transfer only), tripod			
Power supply	Li-ion battery (4 h of continuous operation), built-in charger, AC adapter 110-230 V, 50/60 Hz			Li-ion battery (3 h of continuous operation), built-in charger, AC adapter 110-230 V, 50/60 Hz
Operating temperature range	-20°C...+50°C			
Storage temperature	-40°C...+70°C			
Humidity	≤95%			
Resistance to shocks / vibrations	30g 11 ms (IEC 60068-2-27)			
Housing	IP54			
Weight	approx. 1.4 kg (with battery)			approx. 1.5 kg (with battery)

Overview

Behold the **highest class of thermal imagers** that offers temperature measurements of substantial accuracy. Robustly designed and constructed, they are ideally suited for:

- » troubleshooting electrical installations, wiring, panels, motors, breakers, transformers, switchgear, and electrical equipment,
- » monitoring the thermal performance of industrial manufacturing processes,
- » identifying overheating of mechanical and electro-mechanical components,
- » inspecting buildings for insulation leaks, energy audits, HVAC/R equipment, water damage, and pests,
- » locating hidden heat sources (of people, animals, objects) in dark or low-light conditions.

The touchscreen as well as the lens swivel independently to view objects of interest that are difficult to access from any angle. The large number of functions, intuitive handling and excellent ergonomics make the KT-560/650/670/1K imagers perfect for **every advanced thermographer**.

Features

- » image files saved in JPG format (complete image data)
- » recording of IR videos (on SD memory card or computer hard disk)
- » built-in reports module
- » MIF image combining mode
- » extensive image analysis tools
- » built-in camera for capturing images within the visible light spectrum
- » built-in: GPS, digital compass, LED flashlight, laser pointer, laser rangefinder
- » interfaces: USB type C, Wi-Fi, Gigabit Ethernet, micro HDMI, SD memory card slot, Bluetooth
- » digital zoom
- » interchangeable lenses that do not require calibration by the manufacturer



Imagers have built-in tools for analysis and generating reports on-site.

Standard accessories:

		KT-560	KT-650	KT-670	KT-1K
2x Li-Ion battery 10.8 V 3.35 Ah	WAAKU18	✓	✓	✓	✓
Power supply adaptor Z13	WAZASZ13	✓	✓	✓	✓
External battery charger Z14	WAZASZ14			✓	
Type C USB cable	WAPRZUSBC	✓	✓	✓	✓
LAN cable (RJ45)	WAPRZRJ45	✓	✓	✓	✓
Micro HDMI cable	WAPRZMIKROHDMI	✓	✓	✓	✓
SD card 64 GB	WAPOZSD64	✓	✓	✓	✓
Shoulder harness	WAPOZPAS3	✓	✓	✓	✓
XL9 carrying case	WAWALXL9	✓	✓	✓	✓
Factory calibration certificate		✓	✓	✓	✓

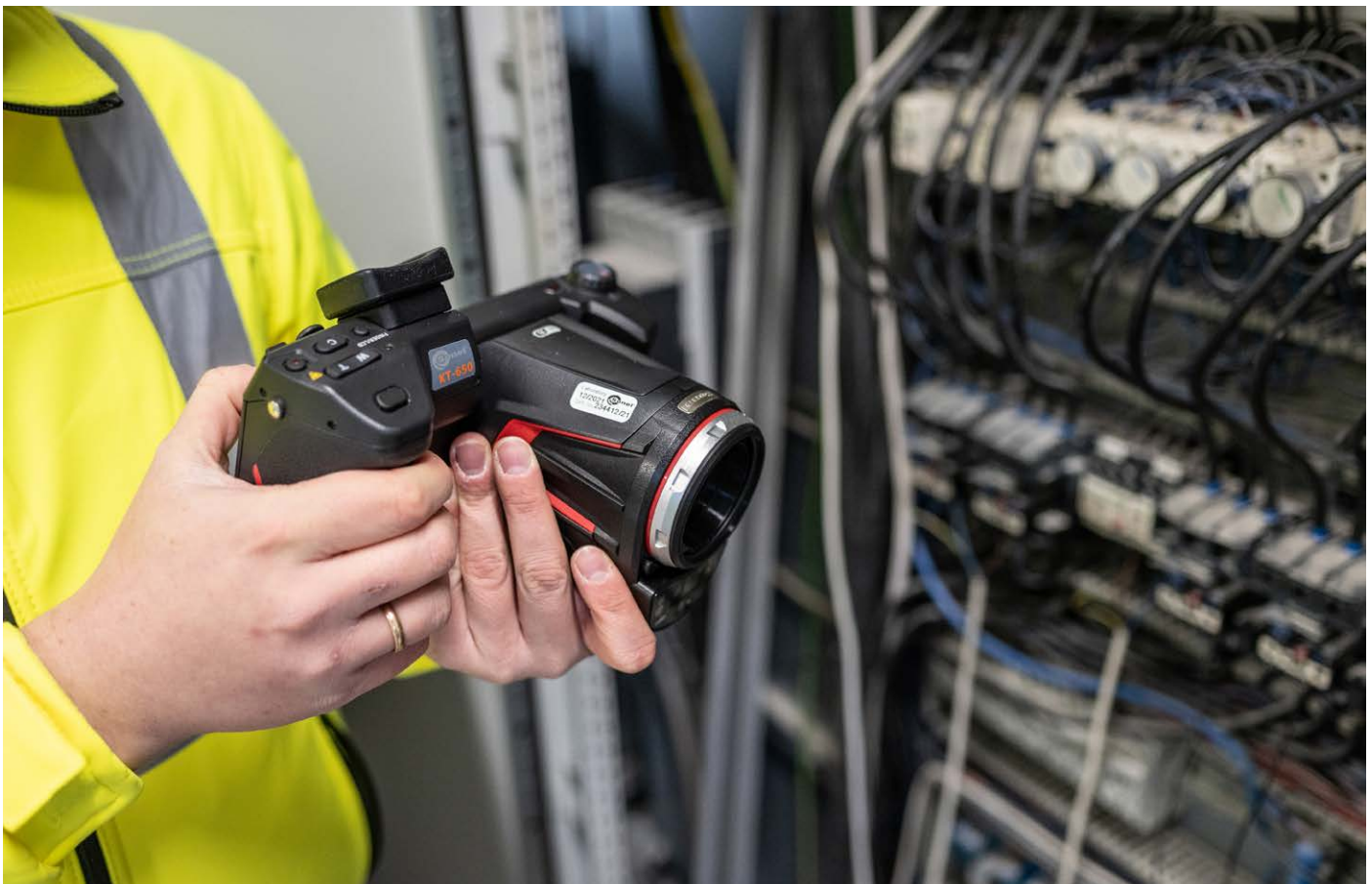

SONEL KT-400 / KT-200

index: WMGBKT400V19 / WMGBKT200V19



	KT-200	KT-400
Detector resolution	192 x 144 / 25 µm VOx	384 x 288 / 25 µm VOx
Spectral range	7.5~14 µm	
Frame rate	25 Hz	
Thermal sensitivity	50 mK	45 mK
Focusing	manual	
IFOV (standard lens)	3.45 mrad	1.29 mrad
Lens (field of view/focal length)	37.8° x 28.8°/7 mm optional: 14.4° x 10.8°/19 mm	28.4°x21.5°/19 mm optional: 57.0° x 45.0°/8.8 mm 13.7° x 10.3°/40 mm
Display	4", 480 x 800 px, high-quality LCD touchscreen	
Imaging mode	IR / Visual / Infrarufusion MIF / PiP	
Zoom	1.1...4	
Temperature range	range 1: -20°C...150°C range 2: 150°C...650°C range 3: 650°C...1500°C (optional)	
Accuracy	±2°C or 2% of reading (for ambient temperatures between 15°C and 35°C and object temperature above 0°C)	
Image analysis mode	5 points, 2 lines, 5 areas. Temp. readings: min., max., mean. Isotherms. Temp. difference Alarm temp. Dew point.	
Palettes	8	
Emissivity coefficient	adjustable from 0.01 to 1.00 or taken from material list	
Measurement correction	settable distance, relative humidity, ambient temperature (reflected)	
Photo image format	JPG	
Notes to IR photos	audio (60 seconds), text, graphic, photo	
Report module	PDF reports, report printing through Wi-Fi	
Video file format	AVI, IRV (including information on temperature)	
Built-in functions	visual camera 5 MPix, LED torch, laser pointer, microphone, speaker.	
Wireless communication	Wi-Fi	
Interfaces	microSD card port, microHDMI, microUSB 2.0	
Power supply	Li-Ion battery (operating time >4 hours), built-in charger, AC 110-230 V (50/60 Hz) / 12V power supply adapter	
Operating temperature	-10°C...+50°C	
Storage temperature	-40°C...+70°C	
Humidity	10%...95%	
Shock/vibration resistance	30g 11 ms (IEC 60068-2-27) / 10 Hz~150 Hz~10 Hz 0.15 mm (IEC 60068-2-6)	
Housing	IP54	
Weight	approx. 0.84 kg (with battery)	
Dimensions (with standard lens and battery)	274 x 106 x 78 mm	274 x 110 x 78 mm

Characteristic

Regardless of whether you take photos or record videos, the newest cameras supplied by Sonel, equipped with **modern detectors**, a **wide range of temperature measurement** and high-quality lenses, ensure highly detailed images and accurate measurements. The cameras are available in several versions, thus enabling the appropriate configuration for the user's needs.

More to see, less to hold

A **large display** combined with innovative data processing electronics is placed in a **compact housing**, thus ensuring a perfect balance between high performance and small dimensions – the best choice for everyday use. Moreover, due to the centrally located navigation button supported by a menu on the touchscreen, this model ensures simple and intuitive operation.

Thermal imaging is not everything

Cameras are additionally equipped with visual lenses and related image mixing technologies: PIP, MIF. Support from the built-in LED torch and laser improves operational quality by facilitating photography and then image interpretation.

The picture is just the beginning

The built-in report module allows for the preparation and printing out of reports directly from the camera. Built-in communication interfaces ensure constant communication between the camera and the computer or mobile device, also over a wireless network.

Thanks to **state-of-the-art technologies and solutions**, the cameras ensure **full control and flexibility** in various situations, and are an **ideal tool for both novice users and professional thermographic inspectors**.

Features

- » high sensitivity of detectors and a wide temperature range
- » **panoramic photos (only KT-400)**
- » **photos in increased resolution (only KT-400)**
- » comprehensive image analysis tools
- » intuitive user interface
- » IR video recording (on the SD card or computer disc)
- » built-in report module
- » different imaging modes: IR, Visual, PIP, MIF
- » built-in visual camera: 5 MPix
- » built-in: LED torch, laser pointer
- » interfaces: Micro USB 2.0, Wi-Fi, microHDMI, microSD slot

Standard accessories:

		KT-200	KT-400
IR 19 mm tele lens for KT-200 (14.4°x10.8°)	WAADA019	✓	
IR 19 mm tele lens for KT-400 (28.4°x21.5°)	WAADA019V400		✓
2x 7.4 V 3.2 Ah Li-Ion rechargeable battery	WAAKU24	✓	✓
Micro-USB data transfer cable	WAPRZUSBMICRO	✓	✓
Wrist strap	WAPOZPAS4	✓	✓
MicroHDMI cable	WAPRZMIKROHDMI	✓	✓
Touchscreen work gloves	WAREK1	✓	✓
MicroSD 16 GB card	WAPOZMSD16	✓	✓
Z13 battery charger	WAZASZ13	✓	✓
Hard carrying case	WAWALL6		✓
Stiffened case	WAFUTL16	✓	
Factory calibration certificate		✓	✓



SONEL KT-256F / KT-256 / KT-128

index: WMGBKT256F / WMGBKT256 / WMGBKT128

-  IP54
-  LASER POINTER
-  VISUAL CAMERA



KT-128 • KT-256

Trigger
Temperature measurement with a single press



KT-256F

Autofocus trigger Sharp image with a single press
Trigger Temperature measurement with a single press

Simple thermography

KT-128 / 256 / 256F is a special camera. Economical, practical and handy, it is a powerful tool in everyday work. The camera is used for basic diagnostics. It is equipped with a matrix having a resolution of:

- » **KT-128** | 120 x 90 pixels,
 - » **KT-256 • KT-256F** | 256 x 192 pixels,
- supported by visual camera, laser pointer and additional features to fully meet the needs of users.

KT-256F | Autofocus

KT-256F is equipped with an automatic focus which ensures that your IR measurement pictures will always be sharp and crisp, no matter the distance.

Application

KT-128 / 256 / 256F is used always when the temperature of objects is important and may affect the operation of the equipment. Particularly useful in:

- » power engineering,
- » construction sector,
- » industry
- » HVAC.

Features

- » measuring range:
 - **KT-128** | -20°C...400°C
 - **KT-256 • KT-256F** | -20°C...550°C
- » quick start
- » fast temperature measurement
- » automatic signalling of exceeded alarm threshold
- » **KT-256F** | autofocus
- » saving IR images to SD card
- » built-in Li-Ion battery with:
 - **KT-128** | 5-hour working time
 - **KT-256 • KT-256F** | 16-hour working time
- » interfaces: USB type C, SD slot
- » can be set up on a tripod

Standard accessories:

		KT-128	KT-256	KT-256F
USB charger	WAZASZ20	✓	✓	✓
Type C USB cable	WAPRZUSBC	✓	✓	✓
16 GB microSD card	WAPOZMSD16	✓	✓	
32 GB microSD card	WAPOZMSD32			✓
Wristband	WAPOZPAS1	✓	✓	✓
Declaration of verification		✓	✓	✓



	KT-128	KT-256	KT-256F
Detector resolution	120 x 90 / 17 µm VOx		256 x 192 / 12 µm VOx
Spectral range		7.5~14 µm	
Frame rate		25 Hz	
Sensitivity	60 mK		45 mK
Focus		Fixed	Auto
Lens (field of vision / focal distance)	50° x 38°/2.28 mm	56° x 48°/3.2 mm	25° x 19°/7 mm
Spatial resolution (IFOV)	7.6 mrad	3.75 mrad	1.71 mrad
Display		2.4", 240 x 320 px, LCD	
Image mode	IR / Visual / PiP	IR / Visual / Infrafusion MIF / PiP	
Temperature range	Range 1: -20°C...+150°C Range 2: 100°C...+400°C		Range 1: -20°C...+150°C Range 2: 100°C...+550°C
Accuracy		±2°C or ±2% of reading (for ambient temperature 15°C...30°C, object temp. ≥0°C)	
Image analysis mode		Point. 3 areas. Temperature indication: min, max. Temp. alarm	
Palettes		6	
Emissivity		Selectable from 0.01 to 1.00 or from the list	
Measurement adjustment		Adjustable distance, ambient temperature (reflected)	
Image file format		JPG	
Built-in features		Visual camera 2 MPix, LED flashlight, laser pointer	
Interfaces		microSD card slot (max. 32 GB), USB type C, tripod	
Power supply	Li-Ion battery (operating time >5 hours), built-in charger (charging time <2.5 hour), AC adapter 110-230 V, 50/60 Hz		Li-Ion battery (operating time >16 hours), built-in charger (charging time <2.5 hour), AC adapter 110-230 V, 50/60 Hz
Operating temperature		-10°C...+50°C	-15°C...+50°C
Storage temperature		-40°C...+70°C	
Housing		IP54	
Weight	ca. 0.35 kg		ca. 0.38 kg

SONEL THERMOANALYZE 3

index: WAPROTHERMOANALYZE3



Software for analyses and reports, included with the set of thermal imagers.

Capability of correcting the emissivity coefficient throughout the entire thermogram or part of it – the coefficient can be corrected individually for each selected area.

Analyzed areas selection – drawing of a rectangular area, oval area, area of any shape.

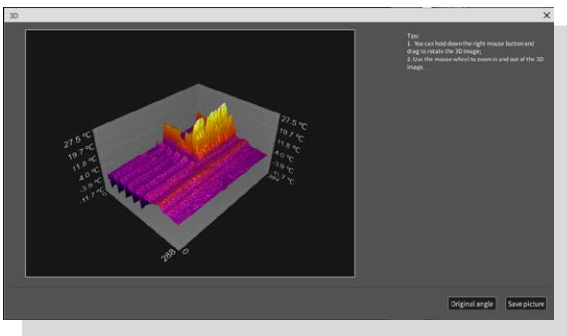

Temperature reading at any point – after scrolling the cursor over to the "Information" window, temperature readouts are displayed continuously along with current coordinates, and other recorded information is also available (maximum temperature, humidity, emissivity).

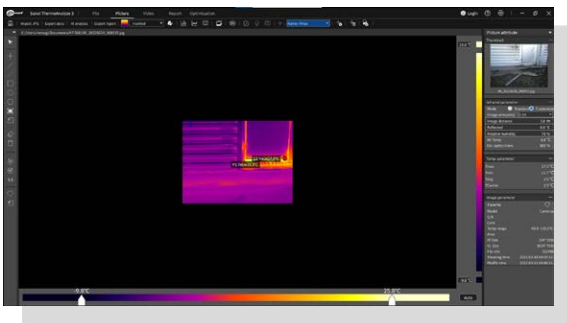

Infra Fusion technology – a thermogram is superimposed onto a part of the visible image, in any palette selected by the user. The thermogram is applied with the selected transparency, making it possible to optimally display and mark areas of interest, particularly when it is difficult to visually compare points on the thermogram with details on the visible image of the observed object.

Determination and reading of minimum, maximum and mean temperature for the entire area and in every marked area of interest. Selection of segment (straight line or polyline).

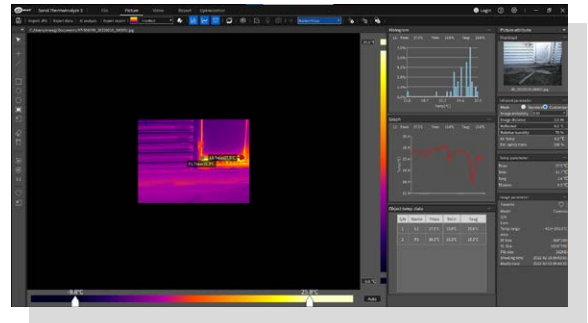

Easy report creation, "drag-and-drop" desired elements into the report – thermograms and the visible images corresponding to them.

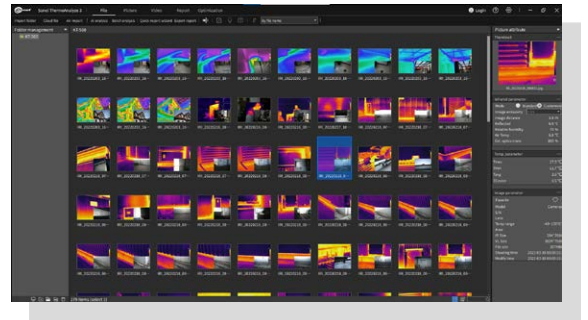

All corrections applied and characteristic points are saved for further analysis at a later time. Selection of the visually optimal color palette (among 9 available in the application) for the best visualization of temperature changes. Configuration of the temperature range for the best imaging of temperature distribution (manual or automatic mode available).

The software has an unlimited license - it can be used simultaneously on multiple devices.

The software is available on the website: www.sonel.com.

SONEL KT MOBILE



A mobile version of the program supporting Sonel thermal imaging cameras. With the application, you can get a preview of the actual image on your phone, and remotely perform a series of other activities by managing the camera from a mobile device. It can be downloaded from **Google Play**.

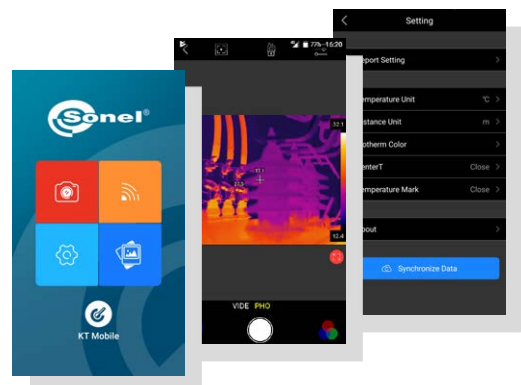

SONEL DIT-500 / DIT-130

index: WMGBDIT500 / WMGBDIT130



Measurements

- » Precise non-contact temperature measurement.
- » Emissivity digitally adjustable from 0.10 to 1.00.
- » Resolution from 0.1°C and 0.1°F.
- » Laser pointer:
 - DIT-130 | single,
 - DIT-500 | double.
- » Input for type K temperature probe.

Additional functions

- » Displaying MAX, MIN, AVG, DIF temperatures.
- » Automatic Data Hold
- » Temperature unit selection: °C / °F.
- » High and Low alarm.
- » Backlit LCD display.
- » Auto power off.

Description

Professional and compact infrared (IR) thermometers are a solution for problems in every area where specific thermal conditions are required. The intuitive one-hand operation of the devices and the ergonomically designed gun-type housing allow for trouble-free daily work.

Applications

- » HVACR areas.
- » Electrical areas.
- » Mechanical areas.
- » Industry areas.

Special features

DIT-500

- » Temperature measurements in the range of **-50°C...1600°C**.
- » Operation with an external temperature probe - temperature measurement range **-50°C...1370°C**.
- » D:S ratio of **50:1**.
- » Data memory (LOG) for **100 measurements**.
- » Double laser pointer (marking the measurement area).
- » Transmission of current readings to computer via USB cable.

DIT-130

- » Temperature measurements in the range of **-32°C...380°C**.
- » D:S ratio of **13:1**.
- » Data memory (LOG) for **20 measurements**.
- » Single laser pointer (marking the measurement area).
- » A specially designed holster for storing the equipment with the possibility of attaching it to the belt in standard.



SONEL IR THERMOMETER

A program dedicated for the PC. It is used to download results from the memory of the **DIT-500** pyrometer and to supervise continuous temperature measurements by downloading the results in real time.

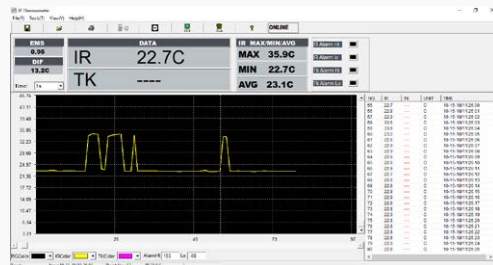

Standard accessories - DIT-500:

Mini-USB data transmission cable	WAPRZUSBMNIB5
Temperature measurement probe (type K)	WASONTEMK
Mini tripod	WAPOZSTATYW
Carrying case	
9 V battery	
Factory calibration certificate	

Standard accessories - DIT-130:

Temperature measurement probe (type K)	WASONTEMK
Holster	WAFUTS5
9 V battery	
Factory calibration certificate	

Technical specification

	DIT-500	DIT-130
LCD display	segmented, with backlight	
Spectral sensitivity	8~14 μm	
Emissivity	digitally adjusted from 0.10 to 1.00	
Semi-conductor laser diode	output power	<1 mW
	wavelength	630~670 nm
	class	class 2 (II) laser
Power supply	9 V alkaline battery NEDA 1604A or IEC 6LR61	
Operating temperature range	0...50°C 32...122°F	
Storage temperature	-20...+60°C -4...+140°F	
Humidity	10...90%	
Indication of range overflow	symbol "----"	symbols "-0L", "0L"
Response time	150 ms	<1 s
Weight	350 g	290 g
Dimensions	230 x 155 x 54 mm	190 x 111 x 48 mm



SONEL DIT-200 / DIT-120

index: WMGBDIT200 / WMGBDIT120



Measurements

- » Precise non-contact temperature measurement.
- » Emissivity digitally adjustable from 0.10 to 1.00.
- » Resolution from 0.1°C and 0.1°F.
- » Laser pointer:
 - DIT-200 | circular,
 - DIT-120 | dual.
- » DIT-200 | Input for type K temperature probe.

Additional functions

- » Displaying MAX, MIN, AVG, DIF temperatures.
- » Automatic Data Hold
- » Temperature unit selection: °C / °F.
- » High and Low alarm.
- » Backlit LCD display.
- » Auto power off.

Description

DIT-120 and DIT-200 are pyrometers for professionals. Durable housing, ergonomic grip, buttons accessible with one finger - all this contributes to the comfort of the user. Technical parameters speak for themselves. The advanced laser pointer will precisely and unambiguously indicate the area of the performed measurement.

Applications

- » Temperature measurement of transformers.
- » Temperature control of busbars and connections.
- » Monitoring the condition of heating and cooling devices.
- » Temperature control of materials in metallurgical processes.
- » Checking the heating of rollers and bearings in transport conveyors.
- » ...and many others.

Special features

DIT-200

- » Temperature measurements in the range of -50°C...1000°C.
- » Operation with an external temperature probe - temperature measurement range -50°C...1370°C.
- » D:S ratio of 20:1.
- » Circular laser pointer (marking the measurement area).

DIT-120

- » Temperature measurements in the range of -50°C...650°C.
- » D:S ratio of 12:1.
- » Double laser pointer (marking the measurement area).

Standard accessories - DIT-200:

Temperature measurement probe (type K)	WASONTEMK
Holster	WAFUTS5
2x AAA 1.5 V battery	
Factory calibration certificate	

Standard accessories - DIT-120:

Holster	WAFUTS5
2x AAA 1.5 V battery	
Factory calibration certificate	

Technical specification

	DIT-200	DIT-120
LCD display	segmented, with backlight	
Spectral sensitivity	8~14 μm	
Emissivity	digitally adjusted from 0.10 to 1.00	
Semi-conductor laser diode	output power	<1 mW
	wavelength	630~670 nm
	class	class 2 (II) laser
Power supply	2x AAA 1.5 V battery	
Operating temperature range	0...50°C 32...122°F	
Storage temperature	-10...+60°C 14...+140°F	
Humidity	10...90%	
Indication of range overflow	symbol "----"	
Response time	150 ms	
Weight	242 g	231 g
Dimensions	170 x 50 x 95 mm	170 x 50 x 85 mm



KT / DIT

Set of standard and optional accessories

1, 2, 4 - number of standard accessories
 - optional accessories

Photo	Name	Index	KT-800M	KT-120M	KT-1K	KT-670	KT-650	KT-560	KT-400	KT-200	KT-256F	KT-256	KT-128	DIT-500	DIT-130	DIT-200	DIT-120
	Adapter – converter HDMI / RCA	WAADAHDMIXRCP				•	•	•									
	Li-Ion battery 10.8 V 3.35 Ah	WAAKU18			2	2	2	2									
	Rechargeable Li-Ion battery 7.2 V 3.2 Ah	WAAKU24							2	2							
	Rechargeable Li-Ion battery 7.4 V 2.3 Ah	WAAKU26															
	Black body	WAADABBKT800M	1														
	MicroSD card 16 GB	WAPOZMSD16		1					1	1		1	1				
	MicroSD card 32 GB	WAPOZMSD32									1						
	SD card 8 GB	WAPOZSD1															
	SD card 16 GB	WAPOZSD16															
	SD card 64 GB	WAPOZSD64			1	1	1	1									
	Wi-Fi SD card 4 GB	WAPOZSDWIFI4															
	Wi-Fi SD card 8 GB	WAPOZSDWIFI8															
	High temperature filter (up to 1500°C)	WAADA0F2							•	•							
	High temperature filter (up to 2000°C)	WAADA0F1				•	•	•									
	IR lens 7 mm (37.8°x28.8°)	WAADA07								•							
	Wide-angle IR lens 8.8 mm (57.0°x45.0°)	WAADA08X8							•								
	Tele IR lens 19 mm (14.4°x10.8°)	WAADA019								1							
	Tele IR lens 19 mm (28.4°x21.5°)	WAADA019V400								1							
	Tele IR lens 40 mm (13.7°x10.3°)	WAADA040								•							
	Wide-angle IR lens 7.78 mm (48.1°x35.9°)	WAADA08V560						•									
	Wide-angle IR lens 13 mm (45.4°x34.8°)	WAADA013V6701				•	•										
	Tele IR lens 33 mm (11.2°x8.4°)	WAADA033V560						•									
	Tele IR lens 55 mm (11.3°x8.5°)	WAADA055V6701				•	•										
	Wristband	WAPOZPAS1		1					1		1	1	1				
	Shoulder harness	WAPOZPAS3			1	1	1	1									
	Wristband	WAPOZPAS4								1							

KT / DIT

Set of standard and optional accessories

1, 2, 4 - number of standard accessories
 - optional accessories

Photo	Name	Index	KT-800M	KT-120M	KT-1K	KT-670	KT-650	KT-560	KT-400	KT-200	KT-256F	KT-256	KT-128	DIT-500	DIT-130	DIT-200	DIT-120
	MicroUSB cable	WAPRZUSBMICRO							1	1							
	Type C USB cable	WAPRZUSBC		1	1	1	1	1			1	1	1				
	USB cable MINI-B 5	WAPRZUSBMNIB5												1			
	MicroHDMI cable	WAPRZMIKROHDMI			1	1	1	1	1	1							
	LAN cable (RJ45)	WAPRZRJ45			1	1	1	1									
	Cable set	WAPRZKPLKT800M	1														
	Type K Temperature Probe	WASONTEMK												1	1	1	
	Temperature probe (type K, metal)	WASONTEMK2												•	•	•	
	Additional Pin Probe with banana plugs	WASONTEMP												•	•	•	
	L16 stiffened case	WAFUTL16							•	1							
	M11 carrying case	WAFUTM11				•	•	•	•	•							
	M13 carrying case	WAFUTM13												•			
	S1 carrying case	WAFUTS1									•	•	•		•	•	•
	L6 hard carrying case	WAWALL6							1	•							
	XL9 carrying case	WAWALXL9			1	1	1	1									
	Power supply adaptor Z13	WAZASZ13			1	1	1	1	1	1							
	Power supply adaptor Z20	WAZASZ20		1							1	1	1				
	External battery charger Z12	WAZASZ12															
	External battery charger Z14	WAZASZ14			1	1	•	•									
	External battery charger Z18	WAZASZ18							•	•							
	Mini tripod	WAPOZSTATYW												1			
	Tripod	WAADASTATYWKT800M	2														
	Protective gloves (for operating the touchscreen)	WAREK1							1	1							
	Computer set	WAZESTAWKOMPKT800M	1														

High voltage measurements

S-120 DC / S-110 DC / S-80 DC / S-50 DC / S-25 DC
S-57 VLF / S-44 VLF / S-36 VLF / S-24 VLF

UV-260

SONEL S-120 DC / S-110 DC / S-80 DC / S-50 DC / S-25 DC

index: WMGBS25DC / WMGBS50DC / WMGBS80DC / WMGBS110DC / WMGBS120DC

S-50 DC / S-80 DC / S-110 DC / S-120 DC

S-25 DC



Features

- » Easy operation
- » Robust construction, low weight
- » Integrated timer:
 - S-25 DC | max. 30 min (standard)
 - S-50 / 80 / 110 / 120 DC | max. 60 min (option)
- » Discharge device:
 - S-25 DC | integrated (S-25 DC),
 - S-50 / 80 / 110 / 120 DC | external ground-discharge rod
- » S-25 DC | Internal battery charger with deep discharge protection
- » Voltage measurement direct at HV output
- » Short-circuit-proof output:
 - S-25 DC | electronically limited output current
 - S-50 / 80 / 110 / 120 DC | protection by overcurrent tripping
- » Protective ground connection
- » S-25 DC | Mains-independent by internal rechargeable battery

Overview

The S-xx DC series devices are universal high voltage testers. They are extremely robust, but also lightweight, compact and easily portable thanks to a transport case on wheels (only for S-50 / 80 / 110 / 120 DC).

Capacitive loads, such as shielded power cables, will be properly and automatically discharged in case of an error or at the end of testing time by the integrated discharge device. Key switch, switch-on interlock and a protective ground circuit ensure maximum safety. S-25 DC stands out in particular. Not just with modest dimensions. Thanks to an internal rechargeable battery it enables mains-independent testing.

Fields of application

- » Testing at recommissioning of cable systems after maintenance and repair
- » Testing of newly installed cables and cable joints before commissioning
- » S-25 DC | Voltage testing at cable sheath
- » S-50 DC / 80 DC / 110 DC / 120 DC | Regular preventive cable testing
- » Testing of electrical equipment

Standard accessories - S-25 DC:

Protective bag	
Power cable	
Connection cables for external DC power supply	
Protective ground cable, 3 m	
Operation ground cable, 3 m	
High voltage connecting cable (shielded), 3 m	
Service pack	
Start keys	

Standard accessories - S-50 DC / S-80 DC / S-110 DC / S-120 DC:

Protective bag	
Discharge rod	
Protective ground cable, 3 m	
Operation ground cable, 3 m	
High voltage connecting cable, 2 m	
Service pack	
Start keys	
Transport case with wheels	WAWALXXL2

Optional accessories - S-25 DC:

Transport case	
Transport case with wheels	WAWALXXL1

Optional accessories - S-50 DC / S-80 DC / S-110 DC / S-120 DC:

Transport case	
----------------	--



	S-25 DC	S-50 DC	S-80 DC	S-110 DC	S-120 DC
Power supply	internal rechargeable battery mains, switchable 115 / 230 V, 50-60 Hz external DC voltage source 11...15 V DC			mains 230 V / 50 Hz (optional: 115 V / 60 Hz)	
Power consumption	max. 120 VA			max. 900 VA	
Output voltage	0...25 kV DC infinitely adjustable negative polarity ripple < 0,25%	0...50 kV DC infinitely adjustable negative polarity	0...80 kV DC infinitely adjustable negative polarity	0...110 kV DC infinitely adjustable negative polarity	0...120 kV DC infinitely adjustable negative polarity
Rated output current at max. output voltage	1.5 mA electronically limited	6 mA	5 mA	4 mA	3.5 mA
Battery operation at full load	45 min			-	
Discharge - integrated automatic discharge device	3000 J 9.6 μ F at 25 kV	7500 J 6 μ F at 50 kV	12 250 J 4 μ F at 75 kV 3.5 μ F at 80 kV	15 000 J 3 μ F at 100 kV 2.5 μ F at 110 kV	18 750 J 2.4 μ F at 125 kV 2.6 μ F at 120 kV
Voltage measuring range	0...30 kV	0...50 kV	0...80 kV	0...110 kV	0...130 kV
Current measuring ranges	0...200 μ A / 0...2 mA manual or automatic switching between ranges			0...100 μ A / 1 mA / 10 mA manual switching between ranges	
Operating temperature			-25...+55°C		
Storage temperature			-40...+70°C		
Weight	Operating unit	13.5 kg		13 kg	
	High voltage unit	-	17 kg	18.5 kg	20 kg
Dimensions	Operating unit	473 x 152 x 275 mm		370 x 200 x 280 mm	
	High voltage unit	-	210 x 380 x 310 mm	210 x 400 x 310 mm	210 x 420 x 310 mm



SONEL S-57 VLF / S-44 VLF / S-36 VLF / S-24 VLF

index: WMGBS57VLF / WMGBS44VLF (230 V) / WMPAS44VLF (110 V) / WMGBS36VLF / WMGBS24VLF



Features

- » Extremely compact high-power VLF test device
- » Easily portable for 1-2 people
- » Simple operation: menu-assisted control with industrial class OLED display
- » Fully automatic test sequence
- » Integrated timer 1-300 min with automatic tripping
- » Integrated breakdown detection
- » Integrated fault time detection
- » Voltage measurement direct at HV output
- » Protective ground connection
- » High voltage start key interlock
- » Protective circuit / indication in accord. with EN 50191
- » Leakage current measurement during VLF test

Standard accessories:

High voltage connecting cable (shielded) 5 m	
Bridging cables	
Connecting cable between high voltage unit and station ground	
Connecting cable between operation unit and protective ground	
Service pack	
Start keys	

Overview

The compact, robust and portable S VLF cable test sets are used for testing of medium voltage cables in accordance to the standards IEEE400, IEC 60502-2, CENELEC HD 620 & 621 and DIN VDE 0276/620 & 621. The test is carried out with a low strain practice with VLF (very low frequency) test voltage at 0.1 Hz frequency.

VLF test enables detection of damages of the insulation within shortest test time. The S VLF series device can test cables with extruded insulation (XLPE, PE-, EPR-insulation) as well as cables with paper-oil insulation (PILC). Cable sheath testing with direct voltage is also possible.

Optional accessories:

USB stick for data logging	WAADAHVVLFDL
Case	WAWALVLF
Case with wheels	WAWALVLF2
Frequency extension 0.05 Hz + 0.02 Hz	WAADAHVVLFFE

Optional features

- » Data logging (USB stick) for VLF test sets
- » Frequency extension: 0.05 + 0.02 Hz
- » Customized test cables
- » Transport case



	S-24 VLF	S-36 VLF	S-44 VLF (230 V)	S-44 VLF (110 V)	S-57 VLF
Power supply	230 V (±10%) 10 A, 50/60 Hz	230 V (±10%) 10 A, 50/60 Hz	230 V (±10%) 10 A, 50/60 Hz	110 V (100 V...127 V) 15 A, 50/60 Hz	230 V (±10%) 10 A, 50/60 Hz
Output voltage	0...24 kV _{RMS} VLF 0.1 Hz (option: 0.05 Hz + 0.02 Hz) ± 0...34 kV DC	0...36 kV _{RMS} VLF 0.1 Hz (option: 0.05 Hz + 0.02 Hz) ± 0...52 kV DC	0...44 kV _{RMS} VLF 0.1 Hz (option: 0.05 Hz + 0.02 Hz) ± 0...62 kV DC	0...44 kV _{RMS} VLF 0.1 Hz (option: 0.05 Hz + 0.02 Hz) ± 0...62 kV DC	0...57 kV _{RMS} VLF 0.1 Hz (option: 0.05 Hz + 0.02 Hz) ± 0...62 kV DC
Voltage waveshape	VLF	similar sine-wave, symmetrical, with True RMS measurement			
	DC	direct voltage, negative and positive polarity			
Overcurrent trip (DC)	10 mA				
Max. testable cable length, max. capacitance (VLF)	up to 60 km (15 µF at 24 kV _{RMS} 0.02 Hz)*	up to 60 km (15 µF at 18 kV _{RMS} 0.02 Hz)*	up to 60 km (15.0 µF at 18 kV _{RMS} 0.02 Hz)*	up to 60 km (15.0 µF at 6 kV _{RMS} 0.02 Hz)*	up to 60 km (15.0 µF at 18 kV _{RMS} 0.02 Hz)*
	*at a cable capacitance of approx. 0.25 µF/km				
Max. load at max. output voltage (VLF) and 0.1 Hz	5 µF at 24 kV _{RMS}	2.4 µF at 36 kV _{RMS}	1.6 µF at 44 kV _{RMS}	1.0 µF at 44 kV _{RMS}	0.55 µF at 57 kV _{RMS}
Discharge - integrated automatic discharge device	max. 9000 J	max. 12500 J	max. 12500 J	max. 12500 J	max. 12500 J
Voltage measuring range	-40...0...40 kV accuracy ±1%	-60...0...60 kV accuracy ±1%	-70...0...70 kV accuracy ±1%	-70...0...70 kV accuracy ±1%	-70...0...70 kV accuracy ±1%
Current measuring ranges	±0...100 µA / 1 mA / 10 mA				
Operating temperature	-20...+45°C				
Storage temperature	-25...+70°C				
Duty	continuous operation				
PC interface	USB stick				
Construction	in two parts: operation unit and high voltage unit				
Dimensions and weight	Operation unit		37 x 34 x 20 cm 17 kg		
	High voltage unit	40 x 41 x 24 cm 38 kg	40 x 44 x 24 cm 48 kg	40 x 44 x 24 cm 49 kg	40 x 44 x 24 cm 49 kg



SONEL UV-260

index: WMGBV260



Specifications of UV section

Image type	Monochromatic
Minimum UV sensitivity	2.2×10^{-18} W/cm ²
Minimum detectable discharge	1 pC from a distance of 10 meters
Spectral range	UV 240 ... 280 nm
Field of vision (WxS)	5.5°x 4.0°
Sharpness setting	Automatic and manual (UV and visible spectrum)
Sharpness range	2 m ... ∞
Detector life	Non-consumable
Frequency:	50 Hz

Specifications of visible spectrum section

Image type	Full color
Accuracy of UV/visible image superposition	Better than 1 milliradian
Minimum sensitivity	0.1 lux
Zoom	25x optical and 12x digital

Display

Type	Unfolding 5.7" VGA touch LCD
Video standard	PAL/NTSC
Imaging modes	Combined (UV & visible) / only UV / only visible
Discharge color	White, red, blue

Processing and communication

Video standard	H.264
Alarm	Audio, LED
Operation	Buttons and touch LCD
Audio module	Microphone input for audio notes
GPS module	✓

Data storage

Memory type	SD memory card
Image file format	JPG
Video file format	AVI
Memory capacity	8000 images or >4 hours of video (for 2 GB card)
File transfer	USB, card reader

Power supply

Power consumption	10 W
Battery type	Li-Ion (2 pcs. in set)
Operating time on battery power	2 hours
Charging	External or internal charger
External power supply	9-12 V, 10 VA
Power adapter	110-240 V AC, 50/60 Hz / 12 V DC 3.8 A

Other specifications

Operating temperature range	-10°C ... +50°C
Storage temperature	-25°C ... +60°C
Relative Humidity	95% without condensation
Dimensions	238 x 165 x 91 mm
Weight	2.5 kg
Power input	✓
SD card slot	✓
Video output	CVBS
Audio input / output	Microphone / headphones

Standard accessories:

Power supply	
2x Li-Ion rechargeable battery 7.2 V 2.2 Ah	WAAKU22
External battery charger	WAADALB220
RCA/RCA video cable	WAPRZVIDRCA
Battery charging cable for 12 V car sockets	WAPRZLAD12SAM1
Camera strap	WAPOZSZEUV260
Headphone set with microphone	WAPOZSLU2
Hard briefcase	WAWALXL11
SD memory card	

Description of the device:

The UV-260 is a high-class, professional, and simultaneously lightweight and intuitive device enabling quick and simple remote diagnostics of a system without interfering in its operation. Its design, placing emphasis on high functionality, allows for detection and monitoring of corona, arc and surface discharges in power engineering. This is a way to continuously analyze the technical condition of equipment, e.g. an HV power line, and locate problems before damage or serious failure occurs.



UV-260 is an innovative solution in the field of UV radiation detection!

Additional features:

- » precise location of discharge sources,
- » recording and playback of videos and images,
- » high UV sensitivity,
- » automatic sharpness for UV and visible image,
- » automatic noise reduction,
- » 5.7" touch LCD,
- » no sensitivity to sunlight during operation in full daylight,
- » additional LED alarm in the event of UV radiation detection,
- » built-in GPS,
- » PC software for data transmission and generating reports.

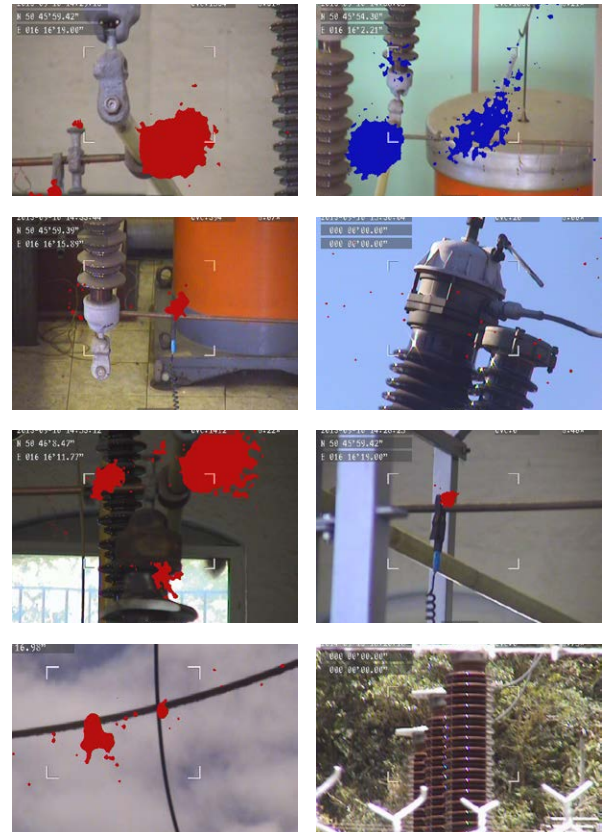

Low resistance meters

MMR-6700
MMR-6500



MMR-650



MMR-630
MMR-620

Low resistance measurements

Low resistance measurements are made when testing the resistance of the following connections: welded, equipotential, contacts, cable connections and coils of low resistance. Meters for low resistance measurement are also used to test motor and transformer windings. These tests also include testing the quality of solder joints or continuity of earthing cables.

Low resistance measurements may be performed by several methods. The most popular is the **technical method**.

For small resistance values (microohms), the wiring and contact resistances in connection points are of significant importance. Therefore, the design of the bridge provides separate current and voltage terminals at the R and R resistors. It is recommended that all other resistors have a resistivity 1000 times greater than the resistance of the leads.

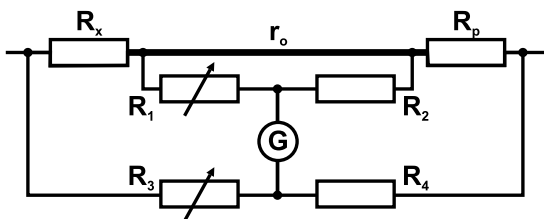

Circuit diagram of Thomson bridge

At the balanced state of the bridge, the current flowing in the branch of the galvanometer is equal to zero. The formula for the measured resistance is as follows:

$$R_x = \frac{R_p R_1}{R_2}$$

The accuracy of the measurement with Thomson bridge is affected insensitivity deviation, which for low resistances of $R_x = 10^{-6} \dots 10^{-5} \Omega$ order is particularly evident. The accuracy also depends on the error in recreating the model, which is related to the quality of particular elements of the bridge. During the measurement, there may be additional errors due to current overloads of the tested and reference resistors, temperature changes and the presence of additional electromotive forces in the system.

Due to defectiveness and limitations of traditional technical bridges, currently we witness a tendency to construct electronic meters for the measurement of low resistances in the range from single micro-ohms to several hundred ohms. Instruments can measure very small resistances even with a resolution of $0.1 \mu\Omega$. An important feature of modern micro-ohm meters is ease of use, application of different measurement modes and the option to cooperate with a computer. These devices measure the resistance using the technical method. Any conductive element may be described by the formula according to Ohm's law:

$$R_x = \frac{U_x}{I}$$

U_x - voltage drop in tested object,
 I - intensity of flowing current,
 R_x - measured resistance.

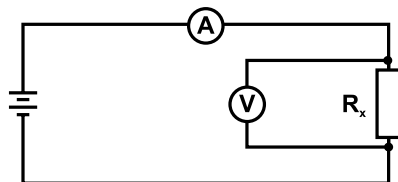

Resistance measurement using technical method (circuit with correctly measured voltage)

The circuit with correctly measured voltage is used for small resistances, when the current flowing through the tested object is several times greater than the current of the voltmeter, which measures the voltage drop on the object. The resistance obtained by the measurement is calculated from the formula:

$$R_x = \frac{U_x}{I - I_v}$$

I_v - current flowing through the voltmeter.



Measurements with MMR-650

With a voltmeter of very high resistance, the current flowing in its circuit is negligibly low, so the measurement result is not affected by the resistance of test leads. This is so called 4-pole method. This type of measurement, which eliminates the impact of the resistance of wires, is used in low resistance meters of MMR series.

Due to very low values of the measured resistance, the four-wire method is used, which allows user to perform accurate measurements without taking into account the impact of the resistance of test leads. Therefore, the manual calibration of the meter and test leads is not necessary, but it is possible (e.g. when using other type of test probes). In addition, it is always possible to restore the factory calibration settings of the device.

Before starting the measurement, select the maximum measurement current (range: from 0.1 mA to 10 A). The measuring range (and thus the current) is selected manually or automatically. In some cases (e.g. exceeding the allowable power generated at the object), it may be desirable to limit the maximum current flowing through the tested object. MMR devices have a lock that allows user to set the upper limit of the measuring current.

The device measures the resistance by causing a current to flow through the tested object (using current leads), at the same time controlling the voltage drop across the terminals of the voltage lines. A break in any circuit will be adequately signalled and the resistance measurement will not be possible.

Operating mode

The user selects the measurement method in one of available modes:

- » in manual mode, each measurement must be triggered by the operator by pressing "Start" button;
- » in automatic mode, the measurement starts at the moment of connecting the last measurement terminal
- » for the continuous mode, measurements are performed every three seconds (resistive mode) or continuously (inductive mode).

The measurements may be performed using the current:

- » flowing only in one direction or
- » flowing in two opposite directions.

Testing with unidirectional current makes the measurements faster, whereas using bidirectional current eliminates errors resulting caused by the presence of internal voltages and electrothermal forces in the tested object. The main result of measurements using the bidirectional current is the average of two measurements of the resistance with the currents flowing in opposite directions. In addition, supplemental results are displayed, i.e. R_f resistance with the current flowing in theoretical "forward" direction and R_b resistance with the current flowing in theoretical "backward" direction.

The normal duration of the measurement is 3 seconds. In order to measure an inductive object, the extended measurement time may be selected. For objects with a high inductance, the measurement time is extended to a few minutes and after completed measurement, the tested object is discharged.

There is an option of using fast measurement mode for inductive devices/objects (FAST mode), which at a slightly lower accuracy accelerates the measurement procedure.

Another operation mode is the window mode, which allows the user to set the upper and lower limits for the measurement result. Results outside this range are additionally signalled by the meter.

The limits of the acceptable range of variability of results are determined by the user.

When using the automatic and continuous mode, exceeding the pre-set range limits will interrupt a series of measurements and the meter will wait for a reaction of the user.

Contact resistance meters

SONEL MMR-6700 / MMR-6500

index: WMGBMMR6700 / WMGBMMR6500

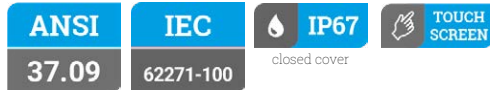

Application

MMR-6xxx micrometers series are devices with a **state of art design** with unprecedented approach to measuring small resistances. The instruments allow to **measure resistive objects with a high current** and have a unique in his measurement class module for inductive current objects **up to 10 A**.

Device capabilities

Sonel microohmmeter MMR-6xxx series thanks to the use of special algorithms, measuring functions and a stabilized, non-pulsing measurement current allow user to work in difficult conditions. Possibility of use measurement current **up to 200 A** and a high power source allows you to measure the contacts of the HV switch with basic uncertainty from 0.25%.

Simplicity of readings

The MMR-6700 microcontroller is equipped with readable, touch screen, 5 inch color display with a resolution of 800x480 pixels for convenience of readings measurement results.

Help system

The use of a large, readable display allowed for use helpful appetent drawings how to use the meter.

Product features

- » measurements of resistive objects with current up to **100/200 A**
- » measurements of induction objects **up to 10 A**
- » measurements of objects earthed on both sides (i.e. main joints of HV switches)
- » measurement with one- or both-way current flow
- » high immunity to outside interference
- » measurements temperature of windings
- » automatic compensation temperature of objects measured
- » a state of the art interface with a touch screen and expanded memory
- » work with a printer and a 2D barcode reader
- » Wi-Fi, USB and LAN communication
- » IP67

Measurements of contact resistance using high current

Range	Resolution	Accuracy	Test current
0.0...999.9 μΩ	0.1 μΩ	±(0.25% + 2 digits)	100 A < I ≤ 200 A*
0.0...999.9 μΩ	0.1 μΩ		50 A < I ≤ 100 A
1.0000...1.9999 mΩ	0.0001 mΩ		20 A < I ≤ 50 A
0.0...999.9 μΩ	0.1 μΩ		10 A < I ≤ 20 A
1.0000...3.9999 mΩ	0.0001 mΩ		
0.0...999.9 μΩ	0.1 μΩ		
1.0000...7.9999 mΩ	0.0001 mΩ		

* MMR-6700 only

Measurements of resistance and inductive objects using low current

Range	Resolution	Accuracy	Test current
0...999.9 μΩ	0.1 μΩ	±(0.25% + 2 digits)	10 A
1.0000...1.9999 mΩ	0.0001 mΩ		10 A
2.000...19.999 mΩ	0.001 mΩ		10 A / 1 A
20.00...199.99 mΩ	0.01 mΩ		1 A / 0.1 A
200.0...999.9 mΩ	0.1 mΩ		0.1 A
1.0000...1.9999 Ω	0.0001 Ω		10 mA
2.000...19.999 Ω	0.001 Ω		1 mA
20.00...199.99 Ω	0.01 Ω		
200.0...1999.9 Ω	0.1 Ω		

Standard accessories:

2x crocodile clip, black, 1 kV, 32 A	WAKROBL30K03
2x Kelvin clamp, 1 kV, 25 A	WAKROKELK06
Current carrying test lead 3 m black I1 (200 A, 25 mm ²)	WAPRZ003BLI1
Current carrying test lead 3 m black I2 (200 A, 25 mm ²)	WAPRZ003BLI2
Test lead 3 m blue 1 kV U1 (banana plug)	WAPRZ003BUBBU1
Test lead 3 m blue 1 kV U2 (banana plug)	WAPRZ003BUBBU2
Doble-wire test lead 3 m (10 A / 25 A) U1/I1	WAPRZ003DZBBU1I1
Doble-wire test lead 3 m (10 A / 25 A) U2/I2	WAPRZ003DZBBU2I2
USB cable	WAPRZUSB
Mains cable with IEC C19 plug	WAPRZZAS1
ST-3 temperature probe	WASONT3
Case L12	WAFUTL12
Factory calibration certificate	

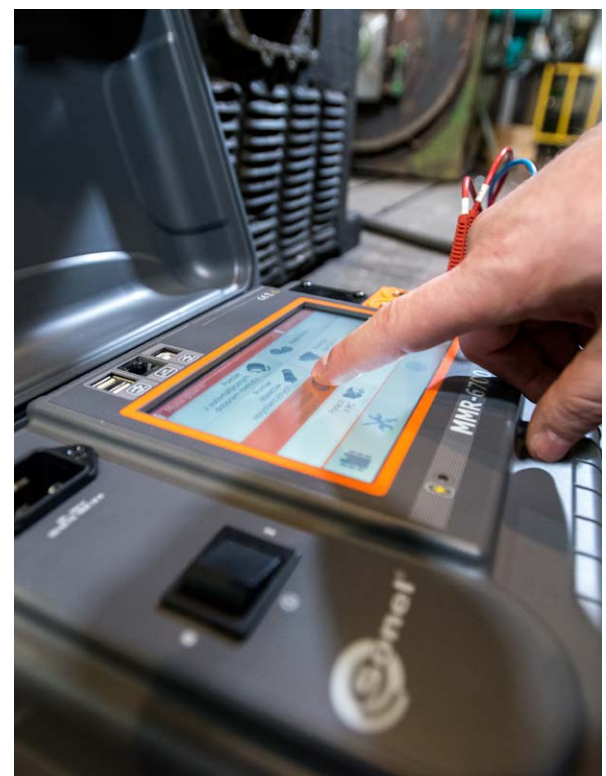

Winding and low resistance meter

SONEL MMR-650

index: WMGBMMR650



CAT IV

300 V

IP67

closed cover

IP54

open cover

TOUCH SCREEN

Product features

- » measurement of winding resistance (including amorphous core transformers)
- » transformer core demagnetization function
- » automatic temperature compensation function (temperature probe)
- » function of determining the temperature of a motor under load
- » high immunity to disturbances
- » measurement of resistant objects using bipolar current

Application

The MMR-650 winding resistance and low resistance meter is designed to measure very low very low resistance of both windings - including amorphous core transformers - and resistive objects. This product is made to be used in power plants, railways and maintenance companies to measure:

- » windings of power transformers and motors,
- » breakers, contacts,
- » earthing conductors, equipotential bondings,
- » welded and soldered connections,
- » bolted connections,
- » and other resistive and inductive objects.

MMR-650 can be also utilized on production lines (eg. at the final production control stage).

Device capabilities

The MMR-650 winding resistance and low resistance meter provides an innovative combination of a **high-performance measuring device** with a **modern user interface** and advanced **data management system**. Wireless data transmission, enhanced system of 2D codes and ability to print labels to identify test items, all contribute to bringing new quality of work and allow the user to perform a wide range of measurements.

Easy readout

The MMR-650 winding resistance and low resistance meter is equipped with a readable colour touchscreen that, due to its 800 x 480 pixel resolution, provides both high comfort of interacting with the interface and high readability of the measurement results.

Durable and practical casing

In response to the customers needs the MMR-650 microohmmeter has been designed to operate in difficult environmental conditions. A unique casing with the IP67 ingress protection rating ensures that the device is both waterproof and dustproof.



The MMR-650 allows single-channel measurement resistance of transformer windings with amorphous cores.

Resistance measurement

Range [Ω]	Resolution [Ω]	Accuracy*	Test current
0...999.9 μ	0.1 μ	±(0.2% + 2 digits)	10 A
1.0000...1.9999 m	0.0001 m		10 A
2.000...19.999 m	0.001 m		10 A/1 A
20.00...199.9 m	0.01 m		1 A/0.1 A
200.0...999.9 m	0.1 m		0.1 A
1.0000...1.9999	0.0001		10 mA
2.000...19.999	0.001		1 mA
20.00...199.99	0.01		
200.0...1999.9	0.1		

*for resistive objects

Standard accessories:

L11 carrying case	WAFUTL11
2x Kelvin clamp, 1 kV, 25 A	WAKROKELK06
Doble-wire test lead 3 m (10 A / 25 A) U1/I1	WAPRZ003DZBBU111
Doble-wire test lead 3 m (10 A / 25 A) U2/I2	WAPRZ003DZBBU212
Mains cable with IEC C13 plug	WAPRZ1X8BLIEC
USB cable	WAPRZUSB
2x double-tip Kelvin probe (banana sockets)	WASONKEL20GB
ST-3 temperature probe	WASONT3
Li-Ion 7.2 V rechargeable battery	WAAKU27
Factory calibration certificate	

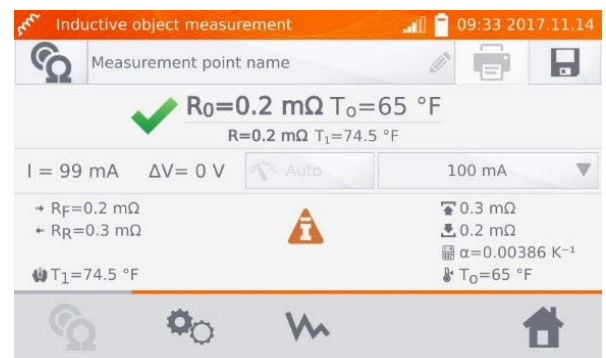

SONEL MMR-630 / MMR-620

index: WMGBMMR630 / WMGBMMR620



CAT III

300 V

IP54

Measurements of objects resistive in nature:

- » welded and soldered connections, equipotential bondings, earthing conductors,
- » contacts, welds of rails, conductors and cables,
- » measurement according to the four-lead method.

Measurements of objects inductive in nature:

- » motor windings,
- » low-resistance coils.

Additional functions of the meters:

Automatic or manual selection of measuring range (measurement of objects of an inductive nature).

Selection of measurement mode according to the type of measured object:

- » fast measurement (3 seconds) for measurement of objects of a resistive nature,
- » extended measurement for testing of objects of an inductive nature (accelerated mode, with slightly worse accuracy, available); with automatic discharging of the object after measurement.

Selection of measurement mode depending on application (including control of product series):

- » measurement in **normal** mode - triggered when the "START" button is pressed,
- » measurement in **automatic** mode - the instrument awaits connection of all four test leads to the object, after which it automatically start measurement in one or both directions and calculates the mean resistance value,
- » measurement in **continuous** mode - the meter repeats successive measurement cycles with breaks every 3 seconds (for objects of a resistive nature) or performs measurement continuously (for objects of an inductive nature).

Window mode:

- » makes possible to set an upper and lower limit within the measurement result should remain; sound signal triggered when the result is beyond set range,
- » capability of performing measurements even under disturbances of a value five times greater than the measured signal.

Instruments meet the requirements set forth in the standards:

- » EN 61010-1 (general and particular requirements related to safety)
- » EN 61010-031 (general and particular requirements related to safety)
- » EN 61326 (electromagnetic compatibility)
- » HD 60364-6 (performance of measurements - checking)
- » HD 60364-4-41 (performance of measurements - shock protection)



MMR-630/620 microohmmeters enable accurate measurements of both connections resistance (welded, soldered, bolted) and winding resistance of electrical motors and power transformers.

Standard accessories:

NiMH rechargeable battery 4.8 V 3 Ah	WAAKU03
L-1 carrying case	WAFUTL1
4x black "crocodile" clip 1 kV 32 A	WAKROBL30K03
2x Kelvin clamp 1 kV 25 A	WAKROKELK06
Two-core cord; 3 m (10 / 25 A) U1/I1	WAPRZ003DZBBU111
Two-core cord; 3 m (10 / 25 A) U2/I2	WAPRZ003DZBBU212
230 V power cord (IEC C7 plug) (MMR-630)	WAPRZLAD230
RS-232 serial transmission cable	WAPRZRS232
2x double-tip Kelvin probe (banana sockets)	WASONKEL20GB
Meter strap (Unisonel type)	WAPOZSZE1
Factory calibration certificate	

Resistance measurement

MMR-620		MMR-630		Test current
Range	Resolution	Range	Resolution	
0...999 μΩ*	1 μΩ	0...999.9 μΩ	0.1 μΩ	10 A
1.000...1.999 mΩ	0.001 mΩ	1.0000...1.9999 mΩ	0.0001 mΩ	
2.00...19.99 mΩ	0.01 mΩ	2.000...19.999 mΩ	0.001 mΩ	
20.0...199.9 mΩ	0.1 mΩ	20.00...199.99 mΩ	0.01 mΩ	1 A
200...999 mΩ	1 mΩ	200...999.9 mΩ	0.1 mΩ	0.1 A
1.000...1.999 Ω	0.001 Ω	1.0000...1.9999 Ω	0.0001 Ω	
2.00...19.99 Ω	0.01 Ω	2.000...19.999 Ω	0.001 Ω	
20.0...199.9 Ω	0.1 Ω	20.00...199.99 Ω	0.01 Ω	1 mA
200...1999 Ω	1 Ω	200.0...1999.9 Ω	0.1 Ω	0.1 mA

Accuracy ±(0.25% m.v. + 2 digits)

"m.v." = "measured value"

Other technical specifications:

- » type of insulation double, as per EN 61010-1 and IEC 61557
- » meter power supply SONEL/Ni-MH 4.8 V rechargeable battery pack
- » charger built-in
- » battery charging time approx. 2.5 hours
- » number of measurements with 10 A current 300
- » time until auto-OFF 120 seconds
- » electric hum immunity additional error ≤1% for 50 Hz voltage
..... ≤100 mV RMS
- » maximum lead resistance for 10A current 100 mΩ
- » measurement current input accuracy ±10%
- » time of resistance measurement:
 - resistance mode, with two-directional current flow 3 seconds
 - induction mode max 10 min (depends on R and L of the object)
- » dimensions 295 x 222 x 95 mm
- » meter weight approx. 1.7 kg
- » operating temperature range 0...+40°C



MMR

Set of standard and optional accessories

1, 2, 4 - number of standard accessories
 - - optional accessories

Photo	Name	Index						Photo	Name	Index										
			MMR-6700	MMR-6500	MMR-650	MMR-630	MMR-620				MMR-6700	MMR-6500	MMR-650	MMR-630	MMR-620					
	USB / RS-232 converter	WAADAUSBRS232																		
	C-5A current clamp (Φ39 mm)	WACEGC5AOKR	•	•																
	Barcode scanner 2D (USB)	WAADACK2D	•	•	•	•	•													
	D2 portable USB report / barcode printer (Sato)	WAADAD2	•	•	•	•	•													
	L1 carrying case	WAFUTL1																		
	L7 backpack	WAFUTL7	•	•																
	L11 carrying case	WAFUTL11																		
	L12 carrying case	WAFUTL12																		
	Crocodile clip, black, 1 kV, 32 A	WAKROBL30K03	2	2																
	Kelvin clamp, 1 kV, 25 A	WAKROKELK06	2	2	2	2	2													
	Double-wire test lead 10 m (Kelvin crocodile clip / banana plug)	WAPRZ010DZBKEL																		
	Double-wire test lead 25 m (Kelvin crocodile clip / banana plug)	WAPRZ025DZBKEL																		
	Doble-wire test lead 3 m (10 A / 25 A) U1/I1	WAPRZ003DZBBU111	1	1	1	1	1													
	Doble-wire test lead 3 m (10 A / 25 A) U2/I2	WAPRZ003DZBBU212	1	1	1	1	1													
	Doble-wire test lead (10 A / 25 A) U1/I1	WAPRZ006DZBBU111																		
	Doble-wire test lead (10 A / 25 A) U2/I2	WAPRZ006DZBBU212																		
	Current carrying test lead 3 m black I1 (200 A, 25 mm²)	WAPRZ003BLI1																		
	Current carrying test lead 3 m black I2 (200 A, 25 mm²)	WAPRZ003BLI2																		
	Current carrying test lead black I1 (6 m / 10 m / 15 m)	WAPRZ006BLI1 WAPRZ010BLI1 WAPRZ015BLI1																		
	Current carrying test lead black I2 (6 m / 10 m / 15 m)	WAPRZ006BLI2 WAPRZ010BLI2 WAPRZ015BLI2																		
	Test lead 3 m blue 1 kV U1 (banana plug)	WAPRZ003BUBBU1																		
	Test lead 3 m blue 1 kV U2 (banana plug)	WAPRZ003BUBBU2																		
	Test lead blue 1 kV U1 (banana plug) 6 m / 10 m / 15 m	WAPRZ006BUBBU1 WAPRZ010BUBBU1 WAPRZ015BUBBU1																		
	Test lead blue 1 kV U2 (banana plug) 6 m / 10 m / 15 m	WAPRZ006BUBBU2 WAPRZ010BUBBU2 WAPRZ015BUBBU2																		
	USB cable	WAPRZUSB																		
	RS-232 serial transmission cable	WAPRZRS232																		
	Mains cable with IEC C13 plug	WAPRZ1X8BLIEC																		
	Mains cable with IEC C19 plug	WAPRZZAS1																		

MMR

Set of standard and optional accessories

1, 2, 4 - number of standard accessories
 - - optional accessories





Photo	Name	Index	MMR-6700	MMR-6500	MMR-650	MMR-630	MMR-620
	Mains cable with IEC C7 plug	WAPRZLAD230				1	
	LAN cable (RJ45)	WAPRZRJ45	•	•	•		
	Protective gloves (for operating the touchscreen)	WAREK1	•	•			
	Temperature probe ST-1	WASONT1	•	•	•		
	ST-3 temperature probe	WASONT3	1	1	1		
	Double pin Kelvin probe with banana connector	WASONKEL20GB	•	•	2	2	2
	UNI-SONEL hanging straps	WAPOZSZE1				1	1

Photo	Name	Index	MMR-6700	MMR-6500	MMR-650	MMR-630	MMR-620
	Label Roll – Black on White for D2 printer (SATO)	WANAKD2	•	•	•	•	•
	Ribbon for D2 printer (SATO)	WANAKD2BAR	•	•	•	•	•
	Kelvin vice with cables	WAZACKEL1	•	•	•	•	•
	NiMH battery 4.8 V 3.2 Ah for MMR-620/630	WAAKU03				1	1
	Li-Ion battery Li-Ion 7.2 V	WAAKU27			1		
	PC software: Sonel Reader	WAPROREADER	•	•	•	•	•



Location of hidden infrastructure and faults

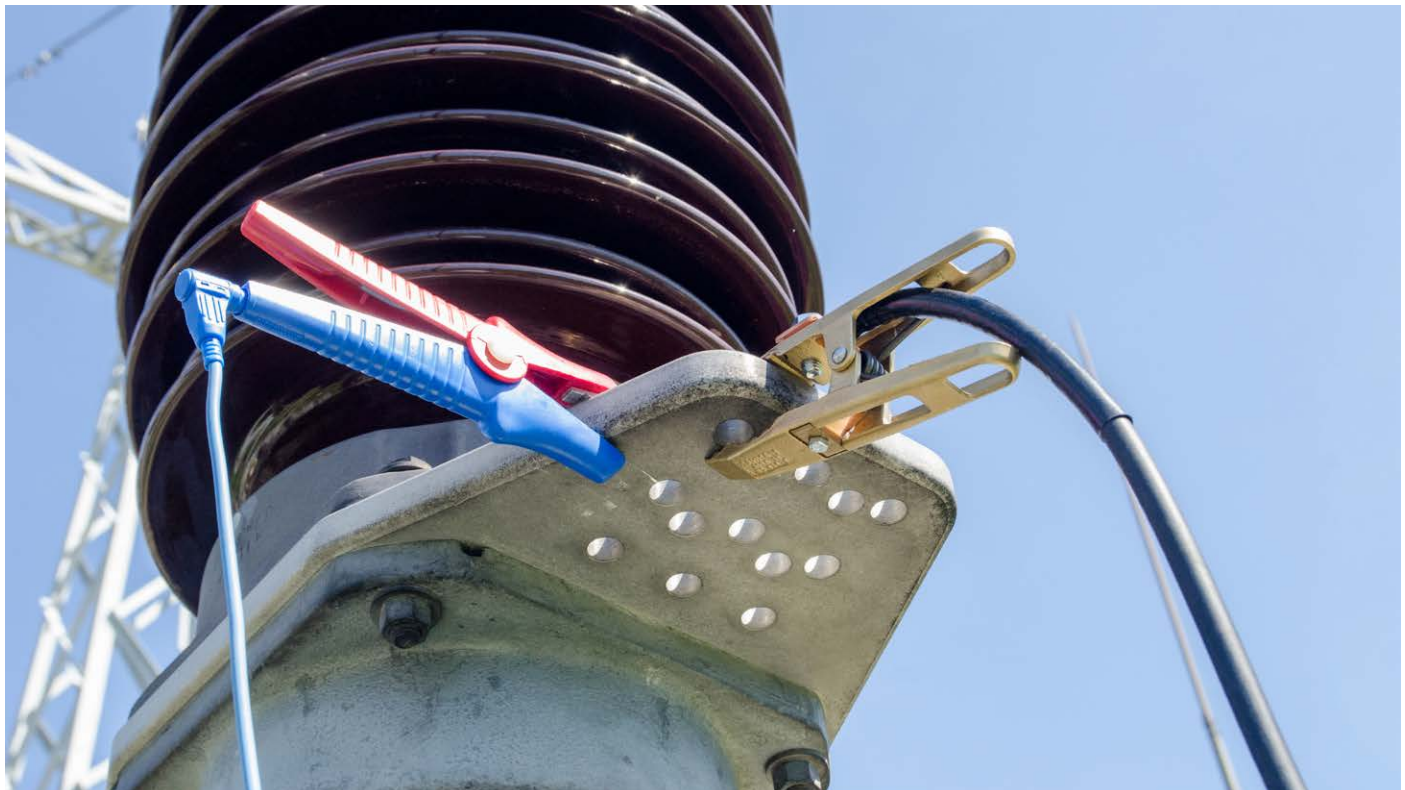

LKZ-2500
LKZ-2000
LKZ-1000

LKZ-720



TDR-420
TDR-410



Detecting cables and underground infrastructures



Earthworks that include various types of excavation, but also installation of sewer and water pipes or cables - are associated with a **high risk of damage to underground systems**, which could lead to a dangerous accident. European Union law requires from the contractor of such works to ensure safety to employees, third parties and private property. In order to reduce the risk of accidents, a number of activities are carried out, including the mandatory detection of existing underground installations and systems. The contractors are never absolutely sure whether all underground utilities are shown on the maps. Therefore, in order to identify all potentially hazardous installations and systems, **additional checks are necessary**, which may be performed with cable locators.

LKZ-1000 is a set for locating wires and pipes, **which precisely determine the depth and direction** of conductive systems (power and telecommunications cables, metal pipes) and with additional probes it is able to detect plastic and concrete pipes. Earthworks are carried out in difficult conditions (moisture, dirt), so both devices meet the requirements of IP54, while the transmitter with closed cover provides ingress protection of IP67.

Location and tracking underground infrastructure elements is performed in a wide range of conditions. LKZ-1000 can operate in several different modes, adapted to different situations:

Power - used to locate electric cables. It is a **passive mode**, where the transmitter is not required: the signal is generated by the live cable itself.

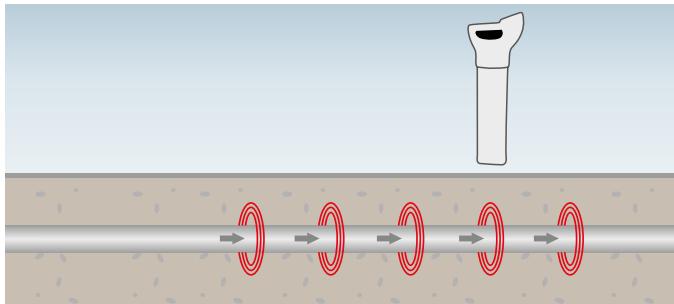

Radio - used to locate metal objects (pipes, reinforcement elements), which re-emit radio signals. It is also a **passive method**: the signal is present in the tested object, which re-emits radio waves.

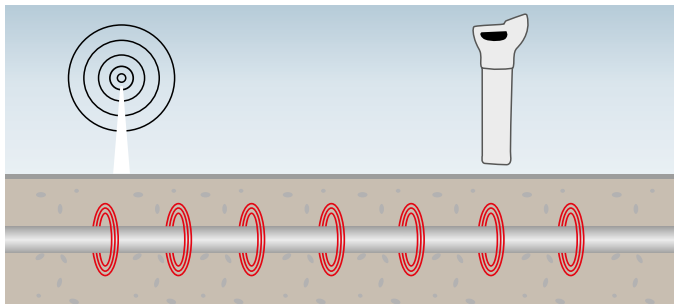

8 kHz - used for precise location of a particular type of systems (cables, pipes, etc.). The frequency of the generated signal (8 kHz) has better range than 33 kHz and lower tendency to transfer the signal to other objects. This is an active method, because it requires the use of a signal generator.

33 kHz - used for location of a particular type of systems (cables, pipes, etc.). This frequency is most often used to locate underground installations. It ensures the highest efficiency, but it has a greater tendency to transfer the signal to other systems/installations. This method also requires the use of a signal generator (**active method**).

LKN-1000 generator (transmitter) generates a signal which is tracked in the detected system. Depending on the situation, in active modes, the transmitter may be connected as shown in one of the following images.

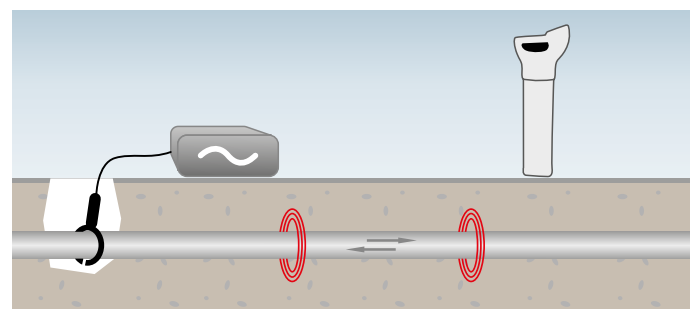
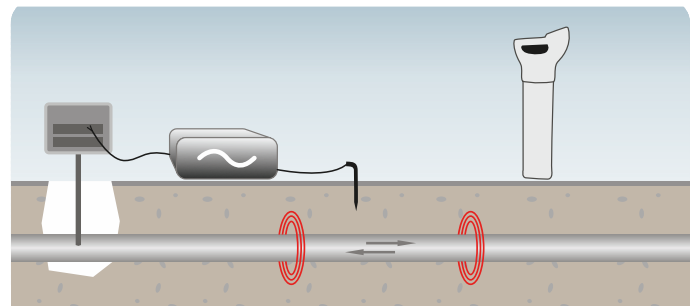
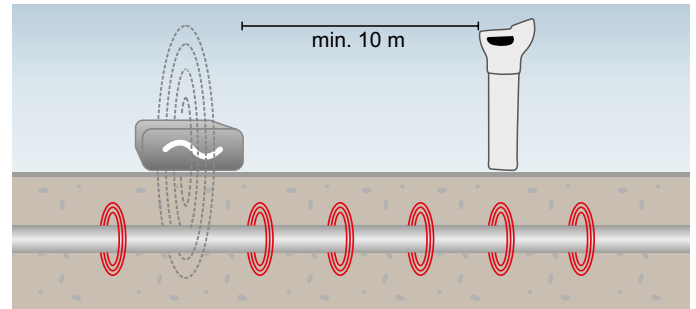

Auto Mode combines the advantages of Radio and Power mode. It is very convenient for initial screening of the area.

Additionally, LKZ-1000 set allows the user to precisely determine the depth of a particular system within 3 meters. In such detection, the device must operate in active modes of 8 kHz or 33 kHz, which use the transmitter and receiver.

In metal systems, the signal may be generated without wires by induction or by direct connection of test leads or by using transmitting clamps. In non-conductive systems, the signal may be generated by introducing a transmitting probe (in the form of a coiled cable or "floating" probe) directly to the detected system (plastic, concrete pipes etc.). In addition to determining the direction and depth of pipes, the user may also locate their blockages by using additional probes.

With the intuitive menu and transparent graphic display, LKO-1000 receiver is very user-friendly. It also has a number of options and features designed to improve safety and comfortable use.

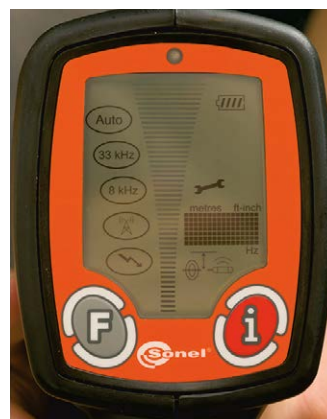

SONEL LKZ-2500

LKN-2500
transmitter



The LKZ locator set consists of a LKN transmitter and LKD detector. It allows for location, identification and tracking of the route of objects buried in the earth. The user will be able to trace:

- » power cords and cables, control cables, telecommunications cables,
- » underground elements of lightning protection systems, cathodic protection systems,
- » water and sewage systems,
- » fuel transmission systems (pipelines, gas pipelines)
- » heating systems and pre-insulated pipes.

The sets of LKZ series are an invaluable support in earthworks carried out for various industries, including energy, installation, construction, railway, telecommunications, water and sanitary, heating, geodetic and many others.

The **LKN-2500 transmitter** is used to inject a locating signal into the object being traced. The **LKD-2500 detector** placed along the object to be traced detects the signal and informs the user about it through the **Sonel LKZ Mobile application**. Determination of the object's route is possible based on observation of compass readings and the level of the detected signal. The system has the ability to trace cables and record trails via the mobile application. Such files can be exported and shared with other users - including those who do not have the LKN-2500 / LKD-2500 device.

The system is capable of operating in passive mode (without the participation of the LKN-2500 transmitter) and active mode (with the participation of the LKN-2500 transmitter). The active mode allows to introduce the signal in three different ways:

- » **galvanic** - consists in introducing the signal to the object in a galvanic way, using wires,
- » **clamp** - involves introducing the signal into the object in an inductive way, using clamps,
- » **inductive** - involves introducing a signal into the object in an inductive manner, using the instrument's internal antenna.

LKN-2500 transmitter:

- » ingress protection IP67
- » power supply Li-ion 7.2 V 9.8 Ah rechargeable battery
- » operating temperature -10...+50°C
- » dimensions 318 x 257 x 152 mm
- » weight 3.4 kg

LKD-2500 detector:

- » ingress protection IP65
- » power supply Li-ion 3.6 V 6.7 Ah rechargeable battery
- » operating temperature -10...+50°C
- » dimensions 290 x 275 x 100 mm
- » weight 1.2 kg

Choose the best set for your needs

LKZ-2500

Location set **with transmitter, detector, tablet and long handle**
index: WMGBLKZ2500

LKZ-2500 Lite

Location set **with transmitter, detector and short handle**
index: WMGBLKZ2500LITE

LKD-2500

Location set **with detector and short handle**
index: WMGBLKD2500

LKD-2500
detector



LKN-2500 transmitter

- » Operation in direct galvanic or inductive connection mode - internal transmitting antenna
- » Compatible with transmitting clamps
- » Case housing

LKD-2500 detector

- » **Active mode**
 - work with LKN-2500 transmitter at the frequencies of 8 kHz, 32 kHz (Signal mode)
- » **Passive mode** – work at the frequencies of:
 - 50 Hz, 60 Hz (Power mode)
 - 2...65 kHz (Radio mode)



SONEL LKZ MOBILE

index: WAPROLKZMOBILE

The application works with the **Sonel LKD-2500 detector**. It enables tracing of objects, recording of routes in the memory of the mobile device along with GPS positions of waypoints and additional readings.

The application additionally enables:

- » live positioning preview,
- » measuring the distance to a specific waypoint,
- » export of routes to other mobile devices,
- » reading routes from the mobile device's memory,
- » preview of stored readout values of all parameters,
- » merging routes,
- » adding notes to routes and measurement points.



Choose the best set for your needs

transmitter

detector

tablet

long handle

short handle

LKZ-2500

includes transmitter, detector, tablet and long handle



LKZ-2500 Lite

includes transmitter, detector and short handle



LKD-2500

includes detector and short handle

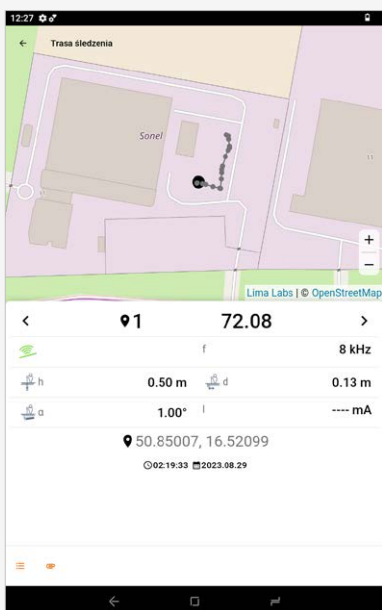

Standard accessories:

		LKZ-2500	LKZ-2500 Lite	LKD-2500
		WMGBLKZ2500	WMGBLKZ2500LITE	WMGBLKD2500
LKN-2500 transmitter	WMGBLKN2500	✓	✓	
LKD-2500 detector	WMGBLKD2500	✓	✓	✓
Tablet	WAPOZTAB10	✓		
2x test lead 5 m, red, 1 kV (banana plugs)	WAPRZ005REBB	✓	✓	
Test lead 5 m, blue, 1 kV (banana plugs)	WAPRZ005BUBB	✓	✓	
2x earth contact test probe (rod), 30 cm	WASONG30	✓	✓	
2x crocodile clip, red, 1 kV, 20 A	WAKRORE20K02	✓	✓	
Crocodile clip, blue, 1 kV, 20 A	WAKROBU20K02	✓	✓	
Z7 power supply	WAZASZ7	✓	✓	
Meter power adapter (type Z32)	WAZASZ32	✓	✓	✓
L10 carrying case	WAFUTL10		✓	✓
XL-1 carrying case	WAFUTXL1	✓		
Short handle	WAPOZUCH14		✓	✓
Long handle	WAPOZUCH15	✓		
Declaration of verification		✓	✓	✓

SONEL LKZ-2000

index: WMGBLKZ2000



LKO-2000 enables remote control and configuration of the transmitter.

LKN-2000 transmitter

- » **Operating frequencies:** 512 Hz, 3140 Hz, 8192 Hz, 32768 Hz, 83,1 kHz, 200 kHz
- » **Output power control:** 5 levels
- » **Power in induction mode (max):** 3 W
- » **Power for galvanic connection (max):** 12 W (for impedance of connected object: 100 Ω)
- » **Batteries:** up to 100 hours (level 2 output power at 20°C)
- » **Auto-OFF:** Capability of selecting auto-OFF time, after 1, 2, 3, 4, 5, 6, 7, 8 hours

LKO-2000 receiver

- » **Mode / Frequency:**
 - POWER passive mode: 50 Hz, 100 Hz, 450 Hz / 60 Hz, 120 Hz, 540 Hz
 - RADIO passive mode: 15 kHz to 60 kHz
 - Active mode (with transmitter): 512 Hz, 3140 Hz, 8192 Hz, 32768 Hz, 83.1 kHz
- » **Antenna configuration:** Single peak value, double peak value, neutral point, full field
- » **Depth measurement range:**
 - POWER mode up to 3 m
 - RADIO mode up to 2 m
 - modes with active transmitter up to 4.6 m
 - probe mode up to 6 m
- » **Accuracy of measurement (error):**
 - 5% depth in linear or probe mode (from 0.2 m to 4.6 m)
 - 10% depth in probe mode (from 4.6 m to 6 m)
- » **Bluetooth:** for remote transmitter control
- » **Operating time with battery power for LKO:** up to 60 hours (at 20°C)
- » **Auto-OFF:** Capability of selecting auto-OFF time after 5, 10, 20 or 30 minutes



Using the A-frame, a cable earth fault can be located.

The diversity and concentration of underground infrastructure are still growing. Identifying underground systems was never as difficult and important a task as it is today. Location allows us to infer the actual position of an underground system and determine the proper location for current works, as well as to prevent accidents caused by damage to the underground objects.

The Sone! LKZ-2000 locator set has a series of unique functions that assist in selecting the appropriate location mode. The most important feature distinguishing this instrument from the competition is its capability of analyzing disturbances present at the place where location is performed, facilitating selection of the best frequency under difficult conditions. This makes it possible to avoid selection of an ineffective frequency, significantly accelerating and facilitating work with the locator.

The best system under the most demanding conditions:

- » power engineering
- » construction
- » railway
- » telecommunications
- » refineries
- » sanitary infrastructure
- » heat distribution networks
- » transmission pipelines

Standard accessories:

LKN-2000 transmitter	WMGBLKN2000
LKO-2000 receiver	WMGBLKO2000
L9 carrying case	WAFUTL9
12x 1.5 V battery	
Declaration of verification	

LKN-2000 transmitter:

- » ingress protection IP65
- » power supply 10x LR20 battery
Li-Ion rechargeable battery pack
- » operating temperature -20...+50°C
- » dimensions 255 x 190 x 305 mm
- » weight ca. 3.5 kg

LKO-2000 receiver:

- » ingress protection IP65
- » power supply 2x LR20 battery
- » operating temperature -20...+50°C
- » dimensions 700 x 325 x 122 mm
- » weight ca. 2.2 kg



SONEL LKZ-1000

LKO-1000
receiver



LKZ-1000

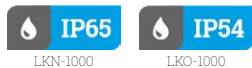

Capabilities:

- » tracking of underground systems over longer distances,
- » better detection of underground systems under adverse conditions with strong disturbances,
- » easier depth determination,
- » better detectability of multiple underground systems simultaneously,
- » four adjustable output signal power levels, up to 1 W,
- » durable, water-resistant housing with IP65 protection rating, more compact and lightweight, designed for work under difficult conditions,
- » three operating modes to choose from: **passive**, **active**, **automatic** (passive+active),
- » easy-to-read visual and sound signals facilitating operation,
- » additional built-in test function enabling independent checking of all functions before starting work,
- » control buttons found on the housing's exterior, allowing for control while the housing is closed, affording better protection against mechanical and water damage.

Functions of the set:

- » passive or active tracing modes,
- » detection of live underground cables,
- » detection of underground cables not carrying current (radio mode),
- » detection of underground cables not carrying current using the transmitter (galvanic or inductive connection, or by means of clamp),
- » tracing of metal or non-conducting pipes by means of additional probe,
- » tracing of non-conducting pipelines by means of "floating" probe,
- » tracing of a specific cable,
- » determination of cable depth,
- » automatic detection sensitivity regulation,
- » 5 operating modes,
- » shallow cable warning,
- » cable depth measurement up to 3 m,
- » determination of direction of cable route,
- » contrast display, automatic LCD backlit.

LKN-1000 transmitter:

- » ingress protection IP54
- » power supply 4x LR20 battery
- » operating temperature -20...+50°C
- » dimensions 180 x 280 x 260 mm
- » weight ca. 2.4 kg

LKO-1000 receiver:

- » ingress protection IP54
- » power supply 6x LR6 battery
- » operating temperature -20...+50°C
- » dimensions 760 x 250 x 85 mm
- » weight ca. 2.9 kg

Standard accessories:

LKN-1000 transmitter	WMGBLKN1000
LKO-1000 receiver	WMGBLKO1000
L6 carrying case	WAFUTL6
Earth contact pin probe	WASONG15
10x 1.5 V battery	

Declaration of verification

Work modes:

- » passive 50 Hz and 60 Hz - enables location of live conductors and cables (POWER)
- » passive RADIO (15...30 kHz) - enables quick, non-selective location of underground infrastructure of a minimum length of 100 m (metal installations)
- » active (with transmitter) (8 kHz and 33 kHz) enables:
 - location in induction mode (it is enough to place the transmitter above the located object)
 - location by means of direct connection of the transmitter to an object not carrying electrical current
 - location by means of transmission clamp (the clamp is to be fastened onto the tested object)
 - location with the use of a transmission lead or transmission probes (enables location of non-metal objects)
 - location by means of splitting adapter (direct connection of LKN-1000 transmitter to a 230 V network socket).

The set also has a series of options and functions that improve safety and convenience of work:

- » **Hazard zone** – this function generates an alarm signal indicating the proximity (within a radius of approx. 30 cm) of cables being located. It works in Power, 8 kHz or 33 kHz operating modes, as well as in automatic mode.
- » **Auto-test** – allows for independent receiver control. After the test is passed, the receiver's display will read PAS, if the test is not passed, ERR will be displayed.
- » **Automatic mode** - combines the benefits of simultaneous detection in Power and Radio mode. Makes it possible to confirm the presence of underground infrastructure in the initial phase of location, making detection easier and safer.
- » **Automatic display backlighting** – the installed lighting sensor automatically activates display backlighting when it is necessary.
- » **Digital signal strength reading** – this function additionally activates digital reading of signal strength on the display, facilitating location of underground installations.



Automatic mode - combines the benefits of simultaneous detection in power and radio mode, making it possible to confirm the presence of underground infrastructure in the initial location phase.



Wire tracer

SONEL LKZ-720 / LKZ-720 KIT

index: WMGBLKZ720 / WMGBLKZ720KIT



LKN-720 transmitter:

- » type of insulation double, as per EN 61010-1
- » measurement category CAT III 600 V according to EN 61010-1
- » ingress protection IP67
- » power supply 4x 1.5 AA alkaline battery or 4x 1.2 Ni-MH rechargeable battery
- » maximum operating voltage 500 V (RMS)
- » operating temperature -10...+50°C
- » dimensions 221 x 102 x 62 mm
- » weight ca. 0.7 kg

LKO-720 receiver:

- » ingress protection IP40
- » maximum depth of the analysed object ("I" mode) 2 m
- » maximum range of contactless neon probe 50 cm (in air)
5 cm (in concrete)
- » power supply 9 V 6LR61 alkaline battery
- » operating temperature -10...+50°C
- » dimensions 245 x 77 x 52 mm
- » weight ca. 0.4 kg

Standard accessories:

		LKZ-720	LKZ-720 KIT	LKO-720	LKN-720	LKN-720 KIT
		WMGBLKZ720	WMGBLKZ720KIT	WMGBLK0720	WMGBLK720	WMGBLK720KIT
LKN-720 transmitter	WMGBLK720	1	4		1	3
LKN-720 receiver	WMGBLK0720	1	1	1		
L2 carrying case	WAFUTL2		1			1
M6 carrying case	WAFUTM6			1		
Test lead 1.2 m, red, 1 kV (banana plugs)	WAPRZ1X2REBB	1	4		1	3
Test lead 1.2 m, blue, 1 kV (banana plugs)	WAPRZ1X2BUBB	1	4		1	3
Crocodile clip, red, 1 kV, 20 A	WAKRORE20K02	1	5		1	4
Crocodile clip, blue, 1 kV, 20 A	WAKROBU20K02	1	4		1	3
Pin probe, red 1 kV (banana socket)	WASONREOGB1	1	4		1	3
Pin probe, blue 1 kV (banana socket)	WASONBUOGB1	1	4		1	3
Test lead 20 m, red, 1 kV (on a reel, banana plugs)	WAPRZ020REBBSZ	1	1		1	
Earth contact test probe (rod), 25 cm	WASONG25	1	2		1	1
Non-contact probe	WASONBDOT	1	1	1		
Mini-USB cable	WAPRZUSBMNIB5	1	1	1		
M1 hanging straps	WAPOZSZE4	1	1		1	1
1.5 V battery		4	16		4	12
9 V battery		1	1	1		
Declaration of verification		1	1	1	1	1

Description

The Sonel LKZ-720 cable and wire locator is a device consisting of the LKN-720 transmitter and the LKO-720 receiver. This instrument is dedicated to finding cables and other underground infrastructures. The LKZ-720 allows the location of both metallic objects (cables) and non-conductive objects (PVC pipes, concrete, etc.). The locator is mainly dedicated to use in the energy and installation industry, among others.

Features

- » Detection of wires and cables (live or not).
- » Tracing underground cables.
- » Tracing conductive water and heating pipelines.
- » Flow and accurate locating the object.
- » Phase detection mode.
- » Operation in wide range of rated voltage, up to 500 V RMS.
- » Five modes of wire tracer operation: voltage, current, current-voltage, power and clamp.
- » Additional accessories enable precise localization - such as contact or non-contact probes and measurement clamp.

Special features

LKO-720

- » Receiver operation with max. 4 transmitters at the same time to locate interruptions or distinguish wires.
- » Receiving status information from the LKN-720 transmitter.
- » The function 3D - detecting the direction of current.
- » A LED torch.
- » Headphone socket.
- » Software upgrade via USB.
- » Screen backlight for work in dark.

LKN-720

- » 4 codes of the transmitted signal.
- » Transmission of information about the transmitter settings and battery charge level.
- » Measurement of voltage at the object to 500 V RMS.
- » Three levels of amplification.
- » Automatic or manual selection of operation modes.
- » Screen backlight for work in dark.

See the video tutorials available on YouTube.





LKZ

Set of standard and optional accessories

1, 2, 4 - number of standard accessories
 - - optional accessories

Photo	Name	Index	LKZ-2500	LKZ-2500 Lite	LKZ-2000	LKZ-1000	LKZ-720 KIT	LKZ-720	Photo	Name	Index	LKZ-2500	LKZ-2500 Lite	LKZ-2000	LKZ-1000	LKZ-720 KIT	LKZ-720	
	LKN-720 transmitter	WMGBLKN720					4	1		N-2 transmitting clamp (Ø100 mm)	WACEGN2XLR						•	
	LKO-720 receiver	WMGBLKO720					1	1		N-3 transmitting clamp (Ø125 mm)	WACEGN3			•				
	LKN-1000 transmitter	WMGBLKN1000				1				N-4 transmitting clamp (Ø110 mm)	WACEGN4	•	•					
	LKO-1000 receiver	WMGBLKO1000				1				N-5 transmitting clamp (Ø125 mm)	WACEGN5	•	•					
	LKN-2000 transmitter	WMGBLKN2000			1					C-8 clamp probe (Ø52 mm)	WASONCEGC8						•	•
	LKO-2000 receiver	WMGBLKO2000			1					L2 carrying case	WAFUTL2						1	
	LKN-2500 transmitter	WMGBLKN2500	1	1						L6 carrying case	WAFUTL6				1			
	LKD-2500 detector	WMGBLKD2500	1	1						L9 carrying case	WAFUTL9			1				
	Tablet	WAPOZTAB10	1	•						L10 carrying case	WAFUTL10	1						
	A-frame	WAADALKZRA			•					M6 carrying case	WAFUTM6						1	
	C-3 clamp adapter	WAADALKOC8						•		Futeral XL-1	WAFUTXL1	1	•					
	Magnetic voltage adapter, black	WAADAUMAGKBL						•		Li-Ion battery 3.6 V 4.5 Ah	WAAKU14			•				
	Magnetic voltage adapter, blue	WAADAUMAGKBU						•		Crocodile clip, red, 1 kV, 20 A	WAKRORE20K02	2	2			5	1	
	AS-1 Separating adapter	WAADAAS1PL						•		Crocodile clip, blue, 1 kV, 20 A	WAKROBU20K02	1	1			4	1	
	N-1 transmitting clamp (Ø52 mm)	WACEGN1BB	•	•				•		Test lead 2,0 m black CAT IV 1000 V (banana plugs with 10 A fuse)	WAPRZ002BLBBF10						•	•

LKZ

Set of standard and optional accessories

1, 2, 4 - number of standard accessories
 - - optional accessories

Photo	Name	Index	LKZ-2500	LKZ-2500 Lite	LKZ-2000	LKZ-1000	LKZ-720 KIT	LKZ-720
	Test lead 2,0 m blue CAT IV 1000 V (banana plugs with 10 A fuse)	WAPRZ002BUBBF10					•	•
	Test lead 2,0 m green CAT IV 1000 V (banana plugs with 10 A fuse)	WAPRZ002GRBBF10					•	•
	Test lead 2,0 m red CAT IV 1000 V (banana plugs with 10 A fuse)	WAPRZ002REBBF10					•	•
	Test lead 2,0m yellow CAT IV 1000 V (banana plugs with 10 A fuse)	WAPRZ002YEBBF10					•	•
	Test lead 1.2 m, red, 1 kV (banana plugs)	WAPRZ1X2REBB					4	1
	Test lead 1.2 m, blue, 1 kV (banana plugs)	WAPRZ1X2BUBB					4	1
	Double-wire test lead 2 m, for N-1 clamp (banana plugs)	WAPRZ002DZBB					•	•
	Test lead 5 m, red, 1 kV (banana plugs)	WAPRZ005REBB	2	2				
	Test lead 5 m, blue, 1 kV (banana plugs)	WAPRZ005BUBB	1	1				
	Test lead 20 m, red, 1 kV (on a reel, banana plugs)	WAPRZ020REBBSZ					1	1
	PN-50 wire to locate non- metallic installations 50 m	WAPRZPN50	•	•	•	•		
	PN-80 wire to locate non- metallic installations 80 m	WAPRZPN80	•	•	•	•		
	USB cable MINI-B 5	WAPRZUSBMNIB5					1	1
	Non-contact probe	WASONBDOT					1	1
	BIK probe for wireless identification of cables	WASONBIK		•				

Photo	Name	Index	LKZ-2500	LKZ-2500 Lite	LKZ-2000	LKZ-1000	LKZ-720 KIT	LKZ-720
	Earth contact test probe (rod), 15 cm	WASONG15			•		1	
	Earth contact test probe (rod), 25 cm	WASONG25					2	1
	Earth contact test probe (rod), 30 cm	WASONG30	2	2				
	Contact probe	WASONDOT					•	•
	NAD-1 Transmission probe	WASONNAD1			•	•		
	Pin probe, black 11 kV (banana socket)	WASONBLOGB11					•	•
	Pin probe, red 1 kV (banana socket)	WASONREOGB1					4	1
	Pin probe, blue 1 kV (banana socket)	WASONBUOGB1					4	1
	M1 hanging hook straps	WAPOZUCH1					•	•
	Magnetic hanging strap	WAPOZUCH6					•	•
	Short handle	WAPOZUCH14	•	1				
	Long handle	WAPOZUCH15	1	•				
	M1 hanging straps	WAPOZSZE4					1	1
	Z7 power supply	WAZASZ7	1	1				
	Z32 power supply	WAZASZ32	1	1				

SONEL TDR-420 / TDR-410

index: WMGBTDR420 / WMGBTDR410



IP67

IP54

Diagnose faults with instruments from the TDR series

- » fault location in power and telecommunication cables
- » **TDR-420** | two independent cursors to indicate two fault locations and the distance between them
- » **TDR-420** | trace hold and compare feature allows displaying and comparing two traces
- » fault location in coaxial cables
- » fault location in infrastructure cables
- » detection of breaks, short-circuits, damage caused by moisture and other changes in cable impedance
- » graphic presentation of cable faults with an indication of the distance to the fault on the display

Application

TDR-410 and TDR-420 time-domain reflectometers are designed for faults locating in metal wires. These products are designed for electrical wholesalers and cable dealers, electrical installation companies, maintenance personnel at manufacturing plants and building personnel. These devices meet the expectations of all those who have to accurately locate a fault and wire end in either power or telecommunication cables.

Device capabilities

SONEL reflectometers are distinguished for their long operating range (**up to 6,000 m for TDR-420**), very low margin of error in measurement (in the order of 1%) and the ability to adjust both the velocity of propagation and the impedance of the cable which is under investigation. By using **two cursors** there should be no problem with determining both the distance to two faults and the distance between them.

Easy readout

The **TDR-420** reflectometer is equipped with a readable **colour display** that, due to its 320 x 240 pixel resolution, allows the fault location to be indicated even more accurately.

Integrated Help

In the **TDR-420** device a **handy help** function has been added to facilitate the interpretation of the result obtained during measurement. Thanks to this function, a user can quickly determine the type of anomaly that is present in the cable segment which is being examined, by comparing the displayed reflectogram with typical fault shapes.

Durable and practical casing

In response to the customers needs the **new model of TDR-420** has been designed to operate in difficult environmental conditions. A unique **casing with the IP67 ingress protection rating** ensures that the device is both waterproof and dustproof. An additional advantage is the elastomer coating of the casing that prevents the device from slipping out of the hands and provides protection if accidentally dropped.

Standard accessories:

		TDR-420	TDR-410
Double-wire test lead 0.6 m	WAPRZ0X6DZBB	✓	✓
Crocodile clip, red, 1 kV, 20 A	WAKRORE20K02	✓	✓
Crocodile clip, black, 1 kV, 20 A	WAKROBL20K01	✓	✓
M6 carrying case	WAFUTM6	✓	
M13 carrying case	WAFUTM13		✓
M1 hanging straps	WAP0ZSZE4	✓	
4x alkaline 1.5 V AA battery		✓	✓
Declaration of verification		✓	✓

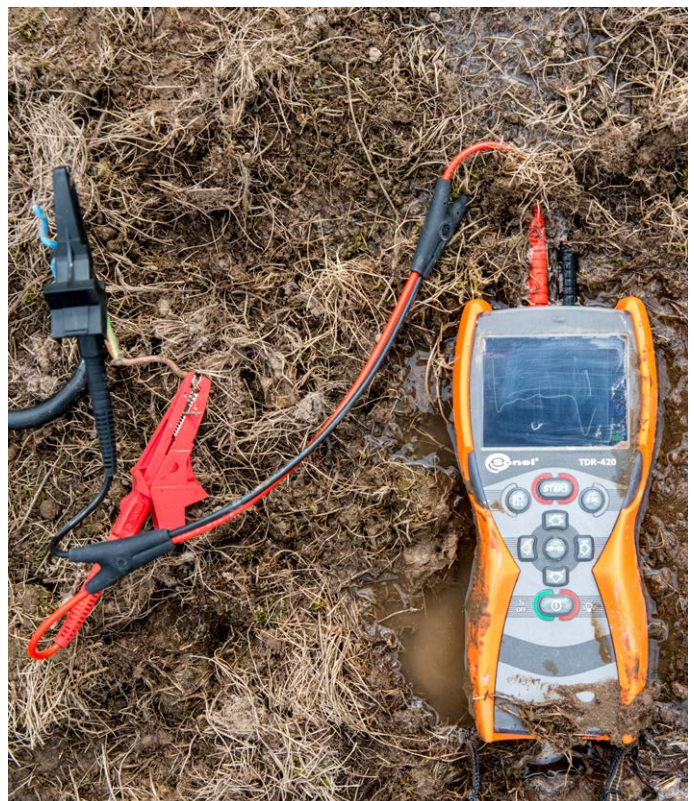

Parameters	TDR-420	TDR-410
	Advanced reflectometric measurements in all fields	Basic cable faults measurements
measuring ranges	7 m, 15 m, 30 m, 60 m, 120 m, 250 m, 500 m, 1 km, 2 km, 3 km, 6 km 20, 45, 90, 180, 360, 750, 1500, 3000, 6000, 10000, 20000 [ft]	7 m, 15 m, 30 m, 60 m, 120 m, 250 m, 500 m, 1 km, 2 km, 3 km, 4 km 20, 45, 90, 180, 360, 750, 1500, 3000, 6000, 10000, 14000 [ft]
accuracy	1% of selected range	
resolution	approx. 1% of range	
minimum cable length	4 m	
velocity of propagation	within 10...99% or 15...148.5 m/μs	within 1...99% or 1...148 m/μs
output impulse	5 V _{pp} for an open circuit	
output impedance	25, 50, 75, 100, 125, 200 Ω	25, 50, 75, 100 Ω
impulse width	3 ns...3 μs (depending on the range)	
scanning type	up to 3 scans/s or a single scan (ONCE mode)	2 scans/s or a single scan
tone generator	810 – 1100 Hz	
operating time on a full battery	up to 8 hours of continuous scanning	up to 30 hours of continuous scanning
power supply	4 x alkaline batteries 1.5 V AA type or 4 x NiMH AA rechargeable batteries	4 x alkaline batteries 1.5 V AA type
auto-off function	1, 3, 5, 10, 15 minutes or deactivated	1, 2, 3, 5 minutes or deactivated
display	colour 3.5" LCD TFT, 320 x 240 pixels	graphical, backlit, 128 x 64 pixels
overvoltage protection	400 V DC / 250 V AC	
operating temperature	-20...+70°C	-10...+50°C
storage temperature	-30...+80°C	-20...+70°C
dimensions	220 x 102 x 61 mm	165 x 90 x 37 mm
weight	487 g	350 g
electromagnetic compatibility standards (EMC)	EN 61326-1	
ingress protection	IP67	IP54



TDR

Set of standard and optional accessories

1, 2, 4 - number of standard accessories
- - optional accessories

Photo	Name	Index	TDR-420	TDR-410
	Magnetic adapter, black	WAADAUMAGKBL	•	•
	Magnetic adapter, blue	WAADAUMAGKBU	•	•
	Voltage adapter with M4 / M6 thread, black	WAADAM4M6BL	•	•
	Voltage adapter with M4 / M6 thread, blue	WAADAM4M6BU	•	•
	Crocodile clip, black 1 kV 20 A	WAKROBL20K01	1	1
	Crocodile clip, red 1 kV 20 A	WAKRORE20K02	1	1
	Test lead 2,0 m black CAT IV 1000 V (banana plugs with 10 A fuse)	WAPRZ002BLBBF10	•	•
	Test lead 2,0 m blue CAT IV 1000 V (banana plugs with 10 A fuse)	WAPRZ002BUBBF10	•	•
	Test lead 2,0 m red CAT IV 1000 V (banana plugs with 10 A fuse)	WAPRZ002REBBF10	•	•
	Double-wire test lead 0.6 m	WAPRZ0X6DZBB	1	1
	M1 hanging straps	WAPOZSZE4	1	
	Magnetic hanging strap	WAPOZUCH6	•	
	M6 carrying case	WAFUTM6	1	
	M13 carrying case	WAFUTM13		1

Illuminance measurements

Our perceptive capability and psychophysical condition depend to a very large extent on the surrounding environment. Light stimuli are decisive factors in the psychological comfort. Prolonged exposure to artificial light may accelerate fatigue and contribute to eyesight defects and other diseases. Negative **impact of improper lighting** on people is particularly important in terms of safety and **work efficiency**. The perception of light stimuli, although dependent on the individual characteristics of a person, is in general similar for majority of people. Therefore, regulations have been defined to define values and types of lighting in places where people live and work. The light visible to humans is an electromagnetic wave with a length from approx. 380 nm to approx. 780 nm. The sensitivity of a human eye is not the same in all conditions - it results from its structure and location of receptors, as well as from the nature of the light. In daylight conditions the eye is most sensitive to green colour, whereas at night or in poor lighting, the eye sensitivity shifts to blue colour - this is why we have a subjective impression that at night everything is grey.

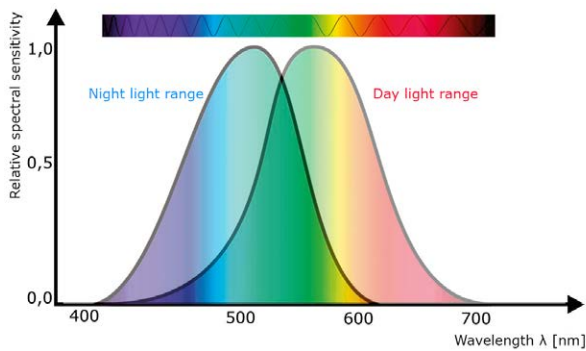

Fig. 1. Visible range of electromagnetic waves during the day and night

Despite the adaptability of the eye to changing light intensity, the measurements require to set the measuring device to have a sensitivity similar to an eye adapted to bright daylight. Spectral curve that corresponds to this sensitivity is called the photopic curve $V(\lambda)$. It is useful to calculate photometric values. In determining the criteria for proper lighting parameters, consider the following:

- » recommendations of the International Commission on Illumination (CIE) (determination of optimal conditions for the illumination of rooms, depending on their use)
- » local regulations (i.e. GB 50034, JIES-008, CIE S 008/E-2001, SNiP 23-05-95, AS 1680.1-2006).

For testing workplace lighting, it is recommended to observe guidelines defined in **binding standard EN 12464**. When discussing illuminance measurements, it is useful to define the illuminance. It is the ratio of luminous flux on a specified area and the surface of this area. The unit of illuminance is lux (lx) [lm/m^2]. In addition, CIE provides recommended **illuminance uniformity E_m** in the field of view, i.e. the way of lighting the workplace. High irregularity of illumination (e.g. exposed light sources in the field of view) creates a risk of glare which may reduce the ability to recognize details or cause a discomfort. In addition, due to the time needed for eyes to adapt to changes, the illumination uniformity should be maintained over time. Therefore, the level of ripple is important and this relates to flicker.

The light colour is another factor that has a significant impact on the well-being of people present in the room. For a man the most optimal lighting has the spectral composition most similar to daylight. Light sources are classified according to the colour temperature into warm, cool and neutral light. The colour temperature may be determined based on **colour rendering index Ra**, which reflects the difference between the colour of object illuminated by natural light and the object illuminated by tested light. Light sources with relatively high Ra index include standard bulbs, halogen bulbs or LEDs. Sources with Ra below 70 include sodium and mercury lamps. Measurements of parameters that help to assess lighting conditions should be carried out during the acceptance of new lighting devices and during the modernization of existing devices or periodically every 5 years. **It is recommended to carry out the tests at least every two years.** The tests shall be carried out:

- » after dark or with curtains drawn
- » in operating conditions - the test area shall not be specially prepared (creating unrealistic conditions) for the tests.

Luminaires with discharge lamps must be switched on at least 30 minutes before testing. Other types of light sources such as halogen bulbs or LEDs, may be examined directly after switching on. Discharge lamps must not be new; they should operate at least 100 hours before measurements; in case light bulbs and halogen lighting this operation period is only one hour. The person performing the measurements can not affect the results. Therefore, it is advisable to wear dark clothing, and the distance from the measuring device should be as large as possible. Measurements should be performed in the plane of the task (e.g. desk surface) with the photometer head set in parallel and directly on the test surface.

Measurements should be performed in the plane of the task (e.g. desk surface) with the photometer head set in parallel and directly on the test surface.

EN 12464-1:2012 introduces a new term: **illuminance of the immediate surrounding area**. It depends on illuminance in the task area and it shall provide an even distribution of luminance in the field of view. This standard recommends minimum dimensions of the task area and related dimensions of the immediate surrounding area (a strip with a width of at least 0.5 m around the task area) and a background area (a strip with a width of at least 3 m adjacent to immediate surrounding area).

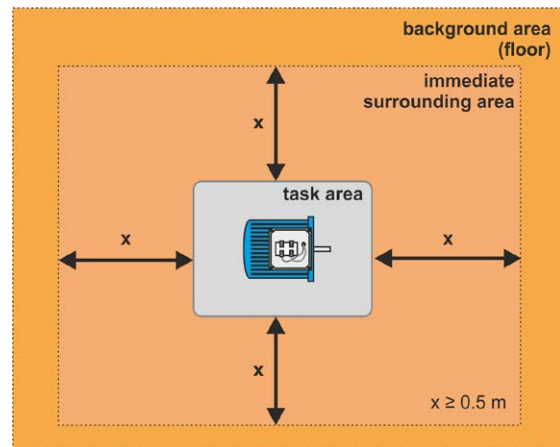

Fig. 2. Visual task, immediate surrounding area and background area

In order to determine the measuring points of all three areas, create grid with a mesh of approximately square shape. The ratio of length to width of the mesh should be between 0.5 and 2. The measurement points should be located inside the mesh of the lighting grid. The maximum grid size shall be:

$$p = 0,2 \cdot 5^{\log_{10} d}$$

where:

p - maximum dimension of the grid [m],

d - longer dimension of the calculated area [m].

Basing on the measurements, **lighting uniformity U_0** may be calculated for a given workplace.

To **measure lighting in interiors with daylight**, carry out the measurements that determine the daylight index. For this purpose, use two luxmeters to perform measurements simultaneously outside and inside the rooms lit via windows or skylights. On the other hand, when **measuring emergency lighting** the illuminance values are very low. The requirements in this matter are defined in standard **EN 1838:2013**. It should be mentioned that for escape routes with a width of 2 meters, the minimum value of illuminance measured at the floor is **1 lux**, which affects the selection of an appropriate measuring device. In recent years, LED illumination sources become more and more popular. Their measurements are currently based on the same requirements as other types of light sources. In case of **measurements on white LED light**, consider the guidelines of CIE concerning parameter f_1' , i.e. the size of mismatch between luxmeter sensitivity and curve $V(\lambda)$. The Commission recommends the use of luxmeter with f_1' **not exceeding 3%**.

Sonei LXP-10A light meter of Class A meets this condition. In case of light meters LXP-10B and LXP-2 of Class B, having the declared error value of spectral correction $f_1' < 6\%$, the error value f_1' must be also taken into account, which results from differences in spectral distribution of the measured and calibration light source. The illuminance measurement formula requires taking into account the correction factors for the LED light. As in luxmeters of Class A and B, the correction factors k take values close to 1, they do not have a significant impact on the measured illuminance value.

When selecting the measuring instrument, **attention should be paid to a valid calibration certificate, which confirms its efficiency and the fact that it meets declared levels of basic and spectral uncertainty. The photoelectric cell, which is used as a sensor, is ageing over time**, so it should be subject to metrological periodic checks.

Illuminance meter

SONEL LXP-10A / LXP-10B / LXP-2

index: WMGBLXP10A / WMGBLXP10B / WMGBLXP2



LXP-10A

Device of the highest class A according to DIN 5032-7 thanks to cooperation with LP-10A measuring probe. LXP-10A has all advantages that can be found in LXP-10B. Furthermore, it allows to make the most accurate measurements in industrial zones and public facilities. In addition, the instrument has the ability to wirelessly send data to Sonel Reader PC software.

LXP-10B

Model with resolution 0.01 lx allows to accurate lighting measurements in workplaces and emergency lighting in escape routes. It works with LP-10B measuring probe (class B according to DIN 5032-7). The device has internal memory of 999 measurements and additional logger for recording data with a selectable sampling rate.

LXP-2

Model for everyone who makes basic lighting measurements of indoor and outdoor workplaces. The device works with LP-1 measuring probe (class B according to DIN 5032-7) which allows to proceed with measurements in a reliable way. The non-integrated probe eliminates the influence of the user to the measurement result.

Main features

- » measurements of all types of light - also LED lighting
- » no need to using correction factors
- » displaying results in lux and foot-candle
- » measurements of emergency lighting

Product functions

- » data HOLD
- » PEAK HOLD
- » MAX and MIN results save
- » measurements of relative (REL) values
- » data logger with memory
- » auto power off



LXP-10B and LXP-10A enable wireless data transfer to a PC via the OR-1 adapter

Basic technical specifications:

	LXP-10A	LXP-10B	LXP-2
	the most recommended for professionals	for measurements of emergency lighting	basic measurements of workplaces
class	A	B	B
measurement range	0.000...399.9k lx 0.000...39.99k fc	0.00...399.9k lx 0.000...39.99k fc	0.0...19.99k lx 0.00...1999 fc
resolution (lx/fc)	up to 0.001	up to 0.01 / 0.001	up to 0.1 / 0.01
accuracy	±(2% + 5 digits)	±(5% + 5 digits)	
spectral uncertainty f_1'	±2%	±6%	
cosine matching error f_2	±1.6%	±3%	
number of ranges	6	5	3
sampling rate	1.3 Hz		
spectral sensitivity	CIE spectral sensitivity (CIE human eye sensitivity)		
photodetector	one silicon photodiode and spectral sensitivity filter		

Other technical specifications:

- » memory 99 results (LXP-2), 999 results (LXP-10)
- » memory of recorder 16,000 results
- » communication interface USB and radio link (only LXP-10B, LXP-10A)
- » display 3½ digits, LCD with 40-segment bar indicator
- » power source 9 V battery or 8.4 V rechargeable battery
- » exceeding of range „OL“ symbol
- » operating temperature 0...50°C
- » storage temperature -20...+70°C
- » relative humidity 0...80%
- » photodetector lead length approx. 150 cm
- » photodetector dimensions 115 × 60 × 20 mm
- » meter dimensions 170 × 80 × 40 mm
- » weight 390 g

Standard accessories:

LP-1 light meter probe (miniDIN-4P) (only LXP-2)	WAADALP1
LP-10A light meter probe (miniDIN-4P) (only LXP-10A)	WAADALP10A
LP-10B light meter probe (miniDIN-4P) (only LXP-10B)	WAADALP10B
USB cable MINI-B 5	WAPRZUSBMNIB5
9 V battery	

Factory calibration certificate

LXP

Set of standard and optional accessories

1, 2, 4 - number of standard accessories
• - optional accessories

Photo	Name	Index	LXP-10A	LXP-10B	LXP-2
	LP-1 light meter probe (miniDIN-4P plug)	WAADALP1			1
	LP-10A light meter probe (miniDIN-4P plug)	WAADALP10A	1	•	
	LP-10B light meter probe (miniDIN-4P plug)	WAADALP10B	•	1	
	Light meter probe holder (stick)	WAPOZUCH9	•	•	•
	Light meter probe holder (trolley)	WAPOZUCH10	•	•	•
	LP-1 light meter probe (miniDIN-4P plug)	WAPRZUSBMNIB5	1	1	1
	OR-1 USB wireless receiver	WAADAUSBOR1	•	•	
	Free software to transfer data from meters	WAPROREADER	•	•	•

A close-up photograph of the PQM-711 mains network analyzer. The device is white with a control panel featuring a small LCD screen, several buttons, and a prominent red emergency stop button. Multiple colored cables are plugged into the front panel. A person's hand is visible in the upper right, interacting with a tablet computer that displays a software interface for the analyzer.

**Top class of mains network analyzer
with transients capture**

PQM-711

A photograph showing the PQM-710 mains network analyzer installed in a rack. The device is a large, grey, rack-mountable unit. The background is filled with a dense array of colorful network cables plugged into the front panel's ports.

**Class A high accuracy
mains network analyzer**

PQM-710

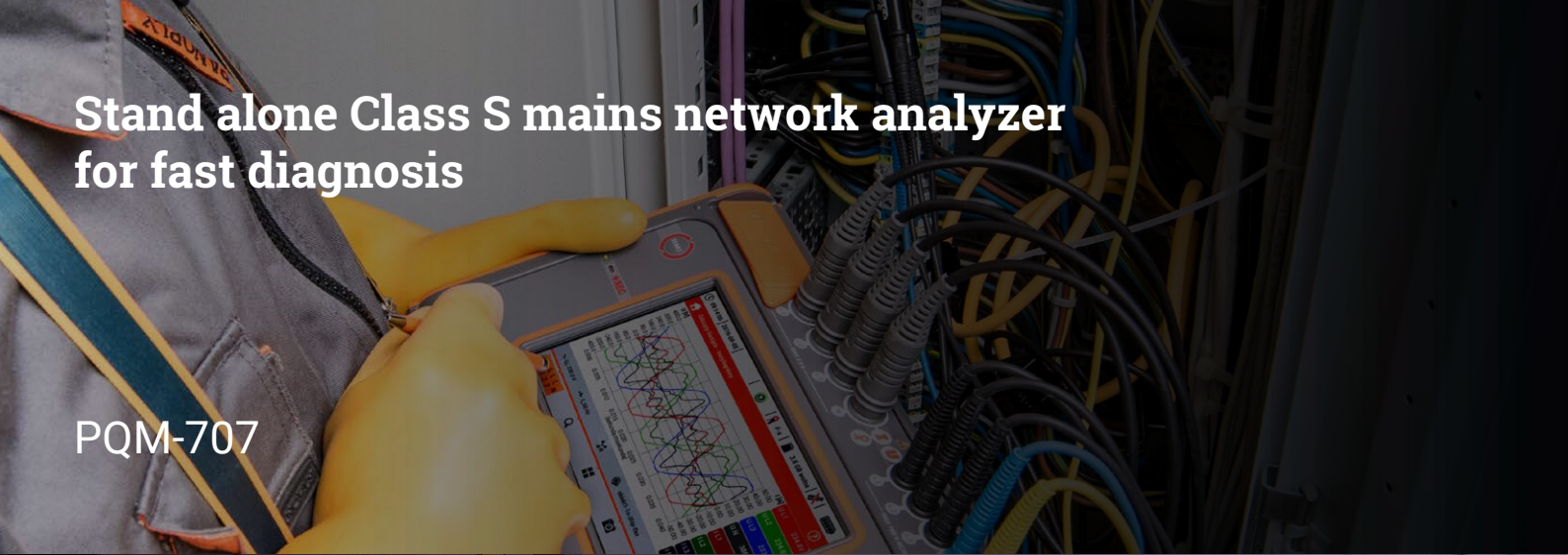
A photograph of a person wearing yellow safety gloves using the PQM-707 mains network analyzer. The device is a rugged, handheld unit with a large color LCD screen displaying a waveform graph. The person is holding the device in front of a rack of network equipment with many cables.

**Stand alone Class S mains network analyzer
for fast diagnosis**

PQM-707

A photograph of the PQM-700 mains network analyzer. It is a compact, orange, ruggedized device mounted on a metal surface. Several cables are connected to its front panel. The background shows a blurred outdoor scene with trees.

**Portable Class S analyzer
for basic and long term analysis**

PQM-700

Power quality analysis

Electricity produced in electric power industry is a typical commercial product. Therefore, it is subject to the same rules as all goods available on the market, taking into account the fact that both the provider and the receiver use the same power grid, which affects the final quality of the power supply. The industry clearly defined power quality parameters, criteria and conditions for their evaluation and rules of distribution and control. Power distribution requires the control of power quality parameters, conditions of receiving process and recording all incidents of exceeded tolerance values. Data gathered in the control process is used for statistical evaluation of the compliance of recorded parameters with applicable standards, legal requirements and contracts. The final result is a confirmation of correctness which ends the assessment or a non-compliance statement, which is related to further analysis of the problem to indicate the responsibility for exceeding limits, which may result in financial consequences.

Wide availability of electricity means that the public networks supply industrial facilities, public buildings, and the vast majority of households. Rapid technological progress resulted in a situation, where typical electric line machines, such as motors, light bulbs, resistive heaters are provided with additional power electronics that ensure easy control of the energy flow, power control and improved efficiency. The consequences of this progress, supported by the need to minimize costs, are significantly simpler solutions that cause higher levels of current and voltage distortion and interference. Power networks are now exposed to new types of impacts that deteriorate power quality, causing additional losses, which is particularly visible with increasing use of new devices.

Consumer electronics involves small power devices, but a very large number of them may significantly affect the quality of power supply in public networks.

Power electronics in industry is related to much higher values of active and passive power, systematically repeated changes of load and type of reactive power, asymmetries of single-phase and two-phase loads, current distortion, voltage dips caused by temporary network overloads and equipment failures. Therefore, the industry supply networks experience troublesome voltage fluctuations causing light flickering lights, short voltage dips, higher levels of harmonic voltages and currents as well as dangerous resonance phenomena. Other adverse incidents include discontinuities and interruptions of power supply that cause losses in production or even hazards to the life of employees. The increased amount of negative impacts causes faster and unpredictable wear of machine parts, making it difficult to plan maintenance activities. Moreover, the risk of losses due to unforeseen failures also significantly increases.

Instruments for analysing and diagnosing power quality are required to provide two basic functionalities. The first one is to assess the conformity or non-conformity of power supply parameters with binding standards and law requirements. This function is provided by all instruments offered on the market. The second functionality is to capture the phenomena that deteriorate power quality and those, which disturb proper and efficient operation of power equipment, providing flexibility to diagnose different types of networks with different nominal voltages. Presence of this feature in offered devices depends mainly on the initiative of producers of measuring equipment.

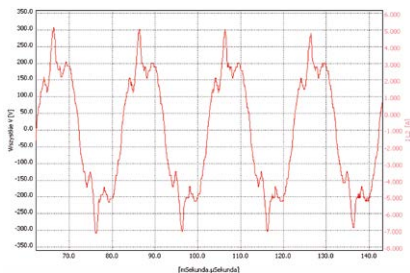

Example of the deformed current waveform

The offer of our company includes a wide range of products tailored to the needs of users:

- » Class S: **PQM-700, PQM-707,**
- » Class A: **PQM-710, PQM-711.**

The main tasks of PQM-7xx analyzers, equipped with a wide range of accessories, include the use of a high-speed memory to simultaneously record up to 4500 network parameters, including: average values, MIN and MAX values, waveforms of voltages and currents at the end of each averaging cycle. Monitored parameters include voltage increases, dips and interruptions with recorded waveforms and RMS (1/2) graphs. In addition, instruments check for exceeding tolerance values, acceptable levels or other parameters. PQM-711 analysers offer also quick waveform recording of transient currents up to 8000 V. Smart solutions used in the analyzers enable them to operate continuously **with power supply from the tested network, up to 1000 V AC for CAT IV 600 V** of overvoltage resistance over a wide temperature range. The analyzers also maintain full functionality for a few hours on their own battery power. Class A devices have a **built-in GPS**, which provides high time accuracy and a GSM modem for distant remote communication.

For close communication, the analyzers use USB connection and some types have built-in Wi-Fi module.

The measurement results provided by PQM analyzers may be used for the following purposes:

Assessment of the quality of power supply in relation to the regulations binding in Poland or to EN 50160 standard. The conformity assessment report indicates which parameters are exceeded in relation to their threshold values, showing percentage values on the observation period scale. The assessment covers average values of voltages and frequencies, asymmetry, flicker factor P_{ST} , THD U, voltage harmonics and additionally the maximum average active power of 15 min and tg, when necessary.

Diagnosis and identification of voltage dips to indicate their cause. Basing on simultaneous recording of average and limit values, as well as RMS (1/2) of voltages and currents, it is possible to indicate whether the dips were caused by outside factors or by own operation of devices. Recording the oscillograms helps to capture transients during power outages, returns or high voltage surges.

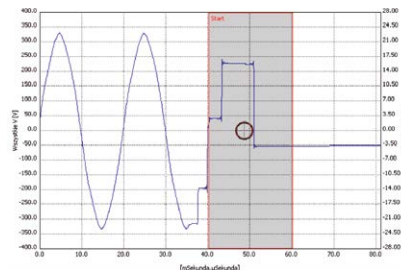

Example of power supply failure

Diagnosis of voltage fluctuations and flicker that presents the levels of voltage fluctuations and the degree of flicker nuisance, indicating the relation with the turbulent operation of

own devices. Relating the high level of changes in active and reactive power to the waveform of the P_{ST} factor and propagation of changes with synchronous recording in several points of the network allows identifying the direction leading to the source of disturbed loads.

Diagnosis of active and reactive power helps to select parameters of the compensator that eliminate penalties for exceeding the reactive power limits and to verify the effectiveness and conditions of operating the battery compensating the reactive power, ensuring trouble-free operation.

Diagnosis of voltages and currents, used for assessing the operational conditions for electrical machines with rotating field, basing on the behaviour of symmetrical components of voltages and currents. Uneven operation of three-phase motors powered directly from the network, interferences in the work of transformers with the risk of ferro-resonances may be identified basing on the interdependence of the various parameters in combination with the waveforms of symmetrical components. The detection of these phenomena may reduce the risk of failure, increasing operational reliability of machines.

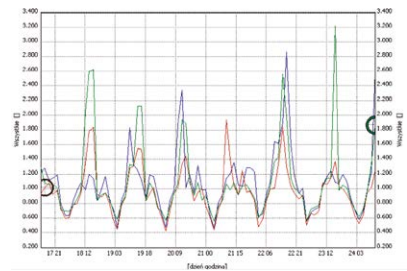

Example of exceeded P_{12} indicator

Diagnosis of harmonics based on the behaviour of voltage, current and power harmonics, which enables the user to evaluate the effects of power supply to non-line devices and their impact on the parameters of the power grid and power quality. High level of harmonics causes additional heat losses of the energy system elements, endangering the operation of these devices and generating additional costs. It is also possible to assess these risks for other power equipment supplied from the network that increase the risk of unexpected failure.

Diagnosis of interharmonics allows user to identify transients and dangerous behaviour of the grid that may threaten the operation of other devices. These phenomena may occur at any frequency. Interharmonics complement the harmonics in the analysis of 0 - 2500 Hz band.

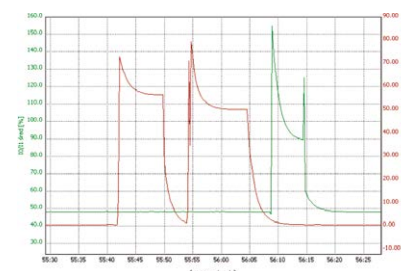

Example of asymmetry caused by connection process

Diagnosis of transients based on high-speed recording of voltage, sampled at a frequency up to 10 MHz in the voltage range of +/- 8000 V. It is possible to detect quick surges threatening the power electronics devices, and insulating elements. Their presence may indicate the absence or failure of surge protection or device malfunction, which in turn can lead to breakdowns and unnecessary loss.

Comparison of power quality analyzers



PQM-711



PQM-710



PQM-707



PQM-700

	PQM-711	PQM-710	PQM-707	PQM-700
STANDARDS				
Compliance class acc. IEC 61000-4-30	A	A	S	S
Certificate from independent laboratory	√	√	-	√
EN 50160	√	√	√	√
GOST 32144	√	√	√	√
AS 61000.3.100	√	√	√	√
MEASUREMENT INPUTS				
Number of voltage inputs	5	5	5	4
Number of current inputs	4	4	4	4
GPS input	1	1	-	-
MEASUREMENTS				
1-phase, split-phase, 3-phase system	√	√	√	√
Frequency	√	√	√	√
TRMS voltage	√	√	√	√
Crest factor U	√	√	√	√
voltage THD and harmonics	√	√	√	√
voltage TID and interharmonics	√	√	-	-
voltage unbalance	√	√	√	√
voltage transients (10 MHz sampling)	√	-	-	-
Short term flicker	√	√	√	√
Long term flicker	√	√	√	√
TRMS current	√	√	√	√
Crest factor I	√	√	√	√
Current THD and harmonics	√	√	√	√
Current TID and interharmonics	√	√	-	-
Current unbalance	√	√	√	√
Inrush	√	√	√	√
Harmonic power	√	√	√	-
Angles between harmonics	√	√	-	-
K-factor	√	√	-	-
Mains signalling	√	√	-	-
Power (P, Q, D, S) acc. to IEEE 1459 or Budeanu method	√	√	√	√
Power factor	√	√	√	√
Cos(φ)	√	√	√	√
Tan(φ)	√	√	√	√
Energy (E _p , E _q , E _s)	√	√	√	√
4-quadrants energy measurements	√	√	√	√
PV inverter efficiency	-	-	√	-
Maximal number of parameters measurements at the same time	3655	3655	1300	1200
Maximal recording time	100 years	100 years	18 years	18 years
Integration period	half cycle ... 120 min	half cycle ... 120 min	1 s ... 30 min	half cycle ... 30 min
SAFETY				
Measurement category	CAT IV 600 V CAT III 1000 V	CAT IV 600 V CAT III 1000 V	CAT IV 600 V CAT III 760 V	CAT IV 300 V CAT III 600 V
EN 61010	√	√	√	√
EN 61326	√	√	√	√
Anti-theft function	√	√	-	-
ENVIRONMENTAL CONDITIONS				
Working temperature [°C]	-20...+55	-20...+55	-10...+50	-20...+55
Built-in heater	√	√	-	√
Ingress protection	IP65	IP65	IP51	IP65
All-weather measurements	√	√	-	√
Pole mounting	√	√	-	√
DIN rail mounting	√	√	-	√



PQM-711



PQM-710



PQM-707



PQM-700

MEMORY AND COMMUNICATION

	PQM-711	PQM-710	PQM-707	PQM-700
Memory	8 GB (max. 32 GB)	8 GB (max. 32 GB)	4 GB (max. 32 GB)	4 GB (max. 32 GB)
Replaceable memory card	-	-	✓	✓
USB	-	-	✓	✓
USB 2.0 High Speed	✓	✓	-	-
Wi-Fi	✓	✓	-	-
GSM (UMTS) modem	✓	✓	-	-

POWER SUPPLY

Built-in Li-Ion battery	✓	✓	-	✓
Replaceable Li-Ion battery	-	-	✓	-
Battery operating time	min. 2 h	min. 2 h	min. 6 h	min. 6 h
Battery charger	internal	internal	external	internal
USB charging	-	-	✓	-

GENERAL

LCD display	✓	✓	-	-
LCD touch screen	-	-	✓	-
GPS time synchronisation	✓	✓	-	-
Multilanguage Sonel Analysis software	✓	✓	✓	✓
Paper and PDF user manual	✓	✓	✓	✓
Weight	1.6 kg	1.6 kg	1.75 kg	1.6 kg
Dimensions	200x175x75 mm	200x175x75 mm	216x111x45 mm	200x175x75 mm

PQM-711



PQM-710



PQM-707



PQM-700



Portable Class S analyzer for basic and long term analysis

Stand alone Class S mains network analyzer for fast diagnosis

Class A high accuracy mains network analyzer

Top class of mains network analyzer with transients capture

SONEL PQM-711 / PQM-710

index: WMGBPQM711BTW / WMGBPQM710BTW



The instrument is intended for operation in networks:

- » with rated frequency 50/60 Hz,
- » with rated voltages: 64/110 V, 110/190 V, 115/200 V, 120/208 V, 127/220 V, 220/380 V, 230/400 V, 240/415 V, 254/440 V, 277/480 V, 290/500 V, 400/690 V, 480/830 V (for systems with N conductor),
- » with direct current,
- » in the following configurations:
 - single-phase,
 - two-phase with common N,
 - three-phase - star with and without N conductor,
 - three-phase - delta.
- » A built-in rechargeable battery allows for max. two hours of operation in the event of a power failure.

Measured parameters:

- » voltages L1, L2, L3, N-PE (five measurement inputs) – mean, minimum and maximum values, instant values within the range up to 1000 V, interoperability with voltage transformers,
- » currents L1, L2, L3, N (four measurement inputs) - mean, minimum and maximum values, instant values within the range up to 6 kA (depending on applied current clamp), interoperability with current transformers,
- » crest factors for current (CFI) and voltage (CFU),
- » frequency within the range of 40 Hz – 70 Hz,
- » active power (P), reactive power (Q), distortion power (D), apparent power (S) with identification of the nature of reactive power (capacitive, inductive),
- » calculation of reactive power using the:
 - Budeanu method,
 - IEEE 1459,
- » active energy (E_p), reactive energy (E_q), apparent energy (E_s),
- » power factor (PF), $\cos\phi$, $\text{tg}\phi$,
- » K factor (transformer overload due to harmonics),
- » harmonics up to the 50th in voltage and current,
- » interharmonics measured as groups,
- » total harmonic distortion THD for current and voltage,
- » short-term (P_{ST}) and long-term (P_{LT}) light flicker index (in compliance with IEC 61000-4-15 class A),
- » unbalance of voltages and currents,
- » registration of overvoltages, voltage dips and breaks along with oscillograms,
- » event logging for current along with oscillograms (up to 1 s) as well as 10 ms RMS charts with maximum registration time of 30 s,
- » registration of current and voltage oscillograms after every averaging period,
- » measurement of control signals up to 3000 Hz,
- » measurement of transients up to ± 8000 V with maximum sampling frequency of 10 MHz. The minimum transient time that can be registered is 650 ns (only PQM-711),
- » sampling frequency: 10.24 kHz,
- » all parameters in compliance with Class A of IEC 61000-4-30.



SONEL ANALYSIS MOBILE

Mobile version of the program supports PQM-711 and PQM-710 power quality analyzers. It can be downloaded from Google Play.

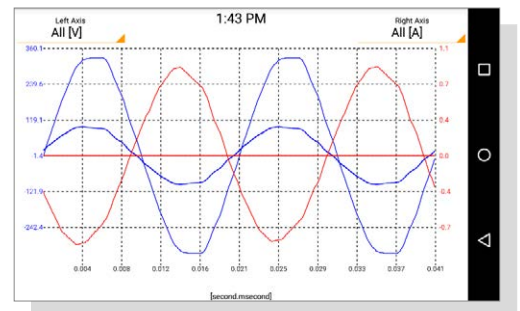

Standard accessories:

3x crocodile clip, black, 1 kV, 20 A	WAKROBL20K01
2x crocodile clip, red, 1 kV, 20 A	WAKRORE20K02
Crocodile clip, blue, 1 kV, 20 A	WAKROBU20K02
Crocodile clip, yellow, 1 kV, 20 A	WAKROYE20K02
AC-16 line splitter	WAADAAC16
AZ-3 power supply adapter (mains plug/ banana inputs)	WAADAAZ3
Voltage adapter with M4/M6 thread (5 pcs.)	WAADAM4M6
Magnetic voltage adapter (4 pcs.)	WAADAUMAGKPL
Straps for mounting on the pole for PQM (set)	WAPOZOPAKPL
DIN rail mounting bracket with positioning catches	WAPOZUCH3
2x fastener and bands for mounting the analyzer on a pole	WAPOZUCH4
XL-2 hard case	WAWALXL2
USB cable	WAPRZUSB
Sonel Analysis 4 PC software	WAPROANALIZA4
Factory calibration certificate	

The instrument meets the requirements set forth in the standards:

- » IEC 61000-4-30 (class A) (electromagnetic compatibility - measurement methods)
- » IEC 61000-4-7 (class I) (measurements of harmonics)
- » IEC 61000-4-15 (class A) (light flicker)
- » IEC 50160 (supply voltage measurements)
- » IEC 61010-1 (safety of measuring instruments)



PQM-711/710 have an independent power source, making them particularly suited for measurements with voltage transducers.



PQM-711 enables measurement of transients up to ± 8000 V with maximum sampling frequency of 10 MHz.



It is possible to wirelessly configure the measurements and analyze measurement data using Sonel Analysis PC software.

Parameters of PQM-711, PQM-710 analyzers

Parameter		Measuring range	Max. resolution	Accuracy
Alternating voltage (TRMS)	–	0.0...1000.0 V	4 significant digits	$\pm 0.1\% U_{nom}$
Crest factor	Voltage	1.00...10.00 (≤ 1.65 for 690 V voltage)	0.01	$\pm 5\%$
	Current	1.00...10.00 ($\leq 3.6 I_{nom}$)	0.01	$\pm 5\%$
Alternating current (TRMS)	–	depending on clamp*	4 significant digits	$\pm 0.1\% I_{nom}$ (error does not account for clamp error)
Frequency	–	40.00...70.00 Hz	0.01 Hz	± 0.01 Hz
Active, reactive, apparent and distortion power	–	depending on configuration (instrument transformers, clamp)	4 significant digits	depending on configuration (instrument transformers, clamp)
Active, reactive apparent energy	–	depending on configuration (instrument transformers, clamp)	4 significant digits	as power error
cos ϕ and power factor (PF)	–	-1.00...1.00	0.01	± 0.03
tg ϕ	–	-10.00...10.00	0.01	depends on error of active and reactive power
Harmonics and inter-harmonics	Voltage	DC, 1...50	as for alternating voltage True RMS	$\pm 0.05\% U_{nom}$ for m.v. < 1% U_{nom} $\pm 5\%$ m.v. for m.v. $\geq 1\% U_{nom}$
	Current	DC, 1...50	as for alternating current True RMS	$\pm 0.15\% I_{nom}$ for m.v. < 3% I_{nom} $\pm 5\%$ m.v. for m.v. $\geq 3\% I_{nom}$
THD	Voltage	0.0...100.0% (relative to RMS value)	0.1%	$\pm 5\%$
	Current			$\pm 5\%$
Active and reactive power of harmonics	–	depending on configuration (instrument transformers, clamp)	depends on minimum current and voltage values	–
Angle between current and voltage harmonics	–	-180.0...+180.0°	0.1°	$\pm(n \times 1^\circ)$
K-Factor	–	1.0...50.0	0.1	$\pm 10\%$
Flicker index	–	0.20...10.00	0.01	$\pm 5\%$
Voltage unbalance	Voltage and current	0.0...20.0%	0.1%	$\pm 0.15\%$ (absolute error)
Measurement of control signals	Voltage	up to 15% U_{nom} at 5.00...3000.00 Hz	4 significant digits	unspecified for <1% U_{nom} $\pm 0.15\%$ for 1...3% U_{nom} $\pm 5\%$ for 3...15% U_{nom}
PQM-711 Measurement of transients	Voltage	± 8000 V	4 significant digits	$\pm(5\% + 25$ V)

*F-1A1, F-2A1, F-3A1 clamp: 0...1500 A AC (10 000 A_{pp}) • F-1A, F-2A, F-3A clamp: 0...3000 A AC (10 000 A_{pp}) • F-1A6, F-2A6, F-3A6 clamp: 0...6000 A AC (10 000 A_{pp})
C-4A clamp: 0...1000 A AC (3600 A_{pp}) • C-5A clamp: 0...1000 A AC/DC (3600 A_{pp}) • C-6A clamp: 0...10 A AC (36 A_{pp}) • C-7A clamp: 0...100 A AC(360 A_{pp})



Power quality analyzers

SONEL PQM-707

index: WMGBPQM707 / WMGBPQM707NC (without F-3A coils)

- 7" TOUCH SCREEN
- IP51
- CAT IV
- 600 V
- CLASS S
- IEC 61000-4-30
- EVENTS



Measured parameters:

- » voltages L1, L2, L3, N-PE (five measurement inputs) – mean, minimum and maximum values within the range up to 760 V, interoperability with voltage transformers,
- » Currents L1, L2, L3, N (four measurement inputs) - mean, minimum and maximum values, current measurement within the range up to 6 kA (depending on applied current clamp), interoperability with current transformers,
- » Crest factors for current (CFI) and voltage (CFV),
- » Frequency within the range of 40 Hz – 70 Hz,
- » Active power (P), reactive power (Q), distortion power (D), apparent power (S) with identification of the nature of reactive power (capacitive, inductive),
- » Power registration: Budeanu method, IEEE 1459,
- » Active energy (E_p), reactive energy (E_q), apparent energy (E_s),
- » Power factor (PF), cosφ, tgφ,
- » Harmonics up to the 50th in voltage and current,
- » Total harmonic distortion THD for current and voltage,
- » Short-term (P_{st}) and long-term (P_{lt}) light flicker index (in compliance with IEC 61000-4-15 class S),
- » Unbalance of voltages (in compliance with IEC 61000-4-30 class S) and currents,
- » Event logging for current and voltage along with oscillograms and half-period RMS charts,
- » Inrush current,
- » Energy cost calculator,
- » Testing the efficiency of PV inverters,
- » sampling frequency: 10.24 kHz,
- » **All parameters are registered in compliance with class S acc. to standard IEC 61000-4-30.**

Parameters of PQM-707

Parameter		Measuring range	Max. resolution	Accuracy
Alternating voltage (TRMS)	–	0.0...760.0 V	4 significant digits	±0.5% U _{nom}
Crest factor	Voltage	1.00...10.00 (≤1.65 for 690 V voltage)	0.01	±5%
	Current	1.00...10.00 (≤3.6 I _{nom})	0.01	±5%
Alternating current TRMS	–	depending on clamp*	0.01% I _{nom}	±0.2% I _{nom} (error does not account for clamp error)
Frequency	–	40.00...70.00 Hz	0.01 Hz	±0.05 Hz
Active, reactive, apparent and distortion power	–	depending on configuration (instrument transformers, clamp)	4 significant digits	depending on configuration (instrument transformers, clamp)
Active, reactive apparent energy	–	depending on configuration (instrument transformers, clamp)	4 significant digits	as power error
cosφ and power factor (PF)	–	0.00...1.00	0.01	±0.03
tg φ	–	0.00...10.00	0.01	depends on error of active and reactive power
Harmonics	Voltage	DC, 1...50	as for alternating voltage True RMS	±0.15% U _{nom} for m.v. < 3% U _{nom} ±5% m.v. for m.v. ≥ 3% U _{nom}
	Current	DC, 1...50	as for alternating current True RMS	±0.5% I _{nom} for m.v. < 10% I _{nom} ±5% m.v. for m.v. ≥ 10% I _{nom}
THD	Voltage	0.0...100.0%	0.1%	±5%
	Current	(relative to RMS value)		
Flicker index	–	0.40...10.00	0.01	±10%
Unbalance factor	Voltage and current	0.0...10.0%	0.1%	±0.15% (absolute error)
Inrush current	Current	depending on clamp*	0.01% I _{nom}	±4% m.v. for m.v. ≥ 10% I _{nom} ±4% I _{nom} for m.v. < 10% I _{nom} (RMS1/2)

*F-1A1, F-2A1, F-3A1 clamp: 0...1500 A AC (10 000 A_{pp}) • F-1A, F-2A, F-3A clamp: 0...3000 A AC (10 000 A_{pp}) • F-1A6, F-2A6, F-3A6 clamp: 0...6000 A AC (10 000 A_{pp})
C-4A clamp: 0...1000 A AC (3600 A_{pp}) • C-5A clamp: 0...1000 A AC/DC (3600 A_{pp}) • C-6A clamp: 0...10 A AC (36 A_{pp}) • C-7A clamp: 0...100 A AC(360 A_{pp})

Standard accessories:

3x crocodile clip, black, 1 kV, 20 A	WAKROBL20K01
2x crocodile clip, red, 1 kV, 20 A	WAKRORE20K02
Crocodile clip, blue, 1 kV, 20 A	WAKROBU20K02
Crocodile clip, yellow, 1 kV, 20 A	WAKROYE20K02
4x F-3A flexible coil (Ø120 mm)	WACEGF3AOKR
Test lead 2.2 m, black, 1 kV with L1 marker (banana plugs)	WAPRZ2X2BLBBL1
Test lead 2.2 m, black, 1 kV with L2 marker (banana plugs)	WAPRZ2X2BLBBL2
Test lead 2.2 m, black, 1 kV with L3 marker (banana plugs)	WAPRZ2X2BLBBL3
Test lead 2.2 m, blue, 1 kV (banana plugs)	WAPRZ2X2BUBBB
Test lead 2.2 m, yellow / green, 1 kV (banana plugs)	WAPRZ2X2GRYEBB
Magnetic voltage adapter (set - 4 pcs)	WAADAUMAGKPL
AC-16 line splitter	WAADAAC16
Li-Ion battery 11.1 V 3.4 Ah	WAAKU15
AZ-2 power supply adapter (IEC C7 plug/ banana connectors)	WAADAAZ2
Mains cable with IEC C7 plug	WAPRZLAD230
Cable for battery charging from car cigarette lighter socket (12 V)	WAPRZLAD12SAM
Z7 Power supply	WAZASZ7
L2 hanging straps (set)	WAPOZSZSEKPL
L4 carrying case	WAFUTL4
USB cable	WAPRZUSB
Sonei Analysis PC software	WAPROANALIZA4

Factory calibration certificate

The instrument is intended for operation in networks:

- » with rated frequency 50/60 Hz,
- » with rated voltages: 58/100 V; 64/110 V; 110/190 V; 115/200 V; 120/208 V; 127/220 V; 133/230 V; 220/380 V; 230/400 V; 240/415 V; 254/440 V; 290/500 V; 400/690 V,
- » with direct current.

Supported network configurations:

- » single-phase,
- » two-phase with common N,
- » three-phase - star with and without N conductor,
- » three-phase - triangle.

SONEL PQM-700

index: WMGBPQM700

CLASS S

IEC 61000-4-30

CAT IV

300 V

IP65



The instrument is intended for operation in networks:

- » with rated frequency 50/60 Hz,
- » with rated voltages: 64/110 V; 110/190 V; 115/200 V; 120/208 V; 127/220 V; 220/380 V; 230/400 V; 240/415 V; 254/440 V; 277/480 V; 290/500 V; 400/690 V,
- » with direct current,
- » in the following configurations:
 - single-phase,
 - two-phase with common N,
 - three-phase - star with and without N conductor,
 - three-phase - triangle.

The device conforms to class S according to IEC 61000-4-30

- » IEC 61000-4-30 (electromagnetic compatibility - measurement methods)
- » IEC 61000-4-7 (measurements of harmonics)
- » IEC 61000-4-15 (light flicker)
- » IEC 50160 (supply voltage measurements)
- » IEC 61010-1 (safety of measuring instruments)
- » IEC 61326 (electromagnetic compatibility - electrical equipment for measurement)



PQM-700 has an independent power source, making it particularly suited for measurements with voltage transducers.

Parameters of PQM-700

Parameter		Measuring range	Max. resolution	Accuracy
Alternating voltage (TRMS)	–	0.0...760.0 V	4 significant digits	$\pm 0.5\% U_{nom}$
Crest factor	Voltage	1.00...10.00 (≤ 1.65 for 690 V voltage)	0.01	$\pm 5\%$
	Current	1.00...10.00 ($\leq 3.6 I_{nom}$)	0.01	$\pm 5\%$
Alternating current TRMS	–	depending on clamp*	4 significant digits	$\pm 0.2\% I_{nom}$ (error does not account for clamp error)
Frequency	–	40.00...70.00 Hz	0.01 Hz	± 0.05 Hz
Active, reactive, apparent and distortion power	–	depending on configuration (instrument transformers, clamp)	4 significant digits	depending on configuration (instrument transformers, clamp)
Active, reactive apparent energy	–	depending on configuration (instrument transformers, clamp)	4 significant digits	as power error
cosφ and power factor (PF)	–	0.00...1.00	0.01	± 0.03
tg φ	–	0.00...10.00	0.01	depends on error of active and reactive power
Harmonics	Voltage	DC, 1...40	as for alternating voltage True RMS	$\pm 0.15\% U_{nom}$ for m.v. < 3% U_{nom} $\pm 5\%$ m.v. for m.v. $\geq 3\% U_{nom}$
	Current	DC, 1...40	as for alternating current True RMS	$\pm 0.5\% I_{nom}$ for m.v. < 10% I_{nom} $\pm 5\%$ m.v. for m.v. $\geq 10\% I_{nom}$
THD	Voltage	0.0...100.0% (relative to RMS value)	0.1%	$\pm 5\%$
	Current			$\pm 5\%$
Flicker index	–	0.40...10.00	0.01	$\pm 10\%$
Unbalance factor	Voltage and current	0.0...10.0%	0.1%	$\pm 0.3\%$ (absolute error)

*F-1A1, F-2A1, F-3A1 clamp: 0...1500 A AC (10 000 A_{pp}) • F-1A, F-2A, F-3A clamp: 0...3000 A AC (10 000 A_{pp}) • F-1A6, F-2A6, F-3A6 clamp: 0...6000 A AC (10 000 A_{pp})
C-4A clamp: 0...1000 A AC (3600 A_{pp}) • C-5A clamp: 0...1000 A AC/DC (3600 A_{pp}) • C-6A clamp: 0...10 A AC (36 A_{pp}) • C-7A clamp: 0...100 A AC (360 A_{pp})

Standard accessories:

3x crocodile clip, black, 1 kV, 20 A	WAKROBL20K01
2x crocodile clip, red, 1 kV, 20 A	WAKRORE20K02
Crocodile clip, blue, 1 kV, 20 A	WAKROBU20K02
AZ-3 power supply adapter (mains plug/ banana inputs)	WAADAAZ3
4x magnetic voltage adapter (set - 4 pcs)	WAADAUMAGKPL
Straps for mounting on the pole for PQM (set)	WAPOZOPAKPL
DIN rail mounting bracket with positioning catches	WAPOZUCH3
2x fasteners and bands for mounting the analyzer on a pole	WAPOZUCH4
L5 carrying case	WAFUTL5
USB cable	WAPRZUSB
Sonel Analysis 4 software	WAPROANALIZA4
Factory calibration certificate	

Measured parameters (EN 50160-4-30, class S):

- » voltages L1, L2, L3 (four measurement inputs) – mean, minimum and maximum values, instant values within the range up to 760 V, interoperability with voltage transformers,
- » currents L1, L2, L3, N (four measurement inputs) - mean, minimum and maximum values, instant values, current measurement within the range up to 6 kA (depending on applied current clamp), interoperability with current transformers,
- » crest factors for current (CFI) and voltage (CFV),
- » frequency within the range of 40 Hz – 70 Hz,
- » active power (P), reactive power (Q), distortion power (D), apparent power (S) with identification of the nature of reactive power (capacitive, inductive),
- » calculation of reactive power using the:
 - Budeanu method,
 - IEEE 1459,
- » active energy (E_p), reactive energy (E_Q), apparent energy (E_S),
- » power factor (PF), cosφ, tgφ,
- » harmonics up to the 40th in voltage and current,
- » total harmonic distortion THD for current and voltage,
- » short-term (P_{ST}) and long-term (P_{LT}) light flicker index (in compliance with EN 61000-4-15 class S),
- » unbalance of voltages (in compliance with EN 61000-4-30 class S) and currents,
- » event logging for current and voltage along with oscillograms and half-period RMS charts,
- » sampling frequency: 10.24 kHz,
- » all parameters are registered in compliance with class S according to standard EN 61000-4-30.

Optional accessories for analyzers



C-4A

WACEGC4AOKR



C-5A

WACEGC5AOKR



C-6A

WACEGC6AOKR



C-7A

WACEGC7AOKR

	C-4A WACEGC4AOKR	C-5A WACEGC5AOKR	C-6A WACEGC6AOKR	C-7A WACEGC7AOKR
Rated current	1000 A AC	1000 A AC 1400 A DC	10 A AC	100 A AC
Frequency	30 Hz...10 kHz	DC...5 kHz	40 Hz...10 kHz	40 Hz...1 kHz
Max. diameter of measured conductor	52 mm	39 mm	20 mm	24 mm
Minimum accuracy	≤0.5%	≤1.5%	≤1%	0,5%
Battery power	–	✓	–	–
Lead length	2.2 m	2.2 m	2.2 m	3 m
Measurement category	IV 300 V	IV 300 V	IV 300 V	III 300 V
Ingress protection	IP40			



F-1A1 / F-1A / F-1A6

WACEGF1A1OKR
WACEGF1AOKR
WACEGF1A6OKR



F-2A1 / F-2A / F-2A6

WACEGF2A1OKR
WACEGF2AOKR
WACEGF2A6OKR



F-3A1 / F-3A / F-3A6

WACEGF3A1OKR
WACEGF3AOKR
WACEGF3A6OKR



F-2AHD

WACEGF2AHDOKR



F-3AHD

WACEGF3AHDOKR

























	F-1A1 / F-1A / F-1A6 WACEGF1A1OKR WACEGF1AOKR WACEGF1A6OKR	F-2A1 / F-2A / F-2A6 WACEGF2A1OKR WACEGF2AOKR WACEGF2A6OKR	F-3A1 / F-3A / F-3A6 WACEGF3A1OKR WACEGF3AOKR WACEGF3A6OKR	F-2AHD WACEGF2AHDOKR	F-3AHD WACEGF3AHDOKR
Rated current	1500 / 3000 / 6000 A AC	1500 / 3000 / 6000 A AC	1500 / 3000 / 6000 A AC	3000 A AC	
Frequency	40 Hz...10 kHz			10 Hz...20 kHz	
Max. diameter of measured conductor	380 mm	250 mm	140 mm	290 mm	145 mm
Minimum accuracy	1%			0.5%	
Battery power	–			–	
Lead length	2.5 m			2.5 m	
Measurement category	IV 600 V			IV 600 V	
Stopień ochrony obudowy	IP67			IP65	



PQM

Set of standard and optional accessories

1, 2, 4 - number of standard accessories
 . - optional accessories

Photo	Name	Index	PQM-711	PQM-710	PQM-707	PQM-700
	AGT-16C adapter (for 3-phase outlets)	WAADAAGT16C	•	•	•	•
	AGT-16P adapter (for 3-phase outlets)	WAADAAGT16P	•	•	•	•
	AGT-16T adapter (for industrial outlets)	WAADAAGT16T	•	•	•	•
	AGT-32C adapter (for 3-phase outlets)	WAADAAGT32C	•	•	•	•
	AGT-32P adapter (for 3-phase outlets)	WAADAAGT32P	•	•	•	•
	AGT-32T adapter (for industrial outlets)	WAADAAGT32T	•	•	•	•
	AGT-63P adapter (for 3-phase outlets)	WAADAAGT63P	•	•	•	•
	Cable adapter for control terminals CAT II / 1000 V (5 pcs.)	WAADAPRKPL1	•	•	•	•
	Voltage adapter for energy measuring terminal block (5 pcs)	WAADASKA	•	•	•	•
	Magnetic adapter (4 pcs.)	WAADAUMAGKPL	1	1	1	1
	Magnetic adapter, black	WAADAUMAGKBL	•	•	•	•
	Magnetic adapter, blue	WAADAUMAGKBU	•	•	•	•
	Voltage adapter with M4 / M6 thread	WAADAM4M6	1	1	•	•
	Voltage adapter with M4 / M6 thread, black	WAADAM4M6BL	•	•	•	•
	Voltage adapter with M4 / M6 thread, blue	WAADAM4M6BU	•	•	•	•
	Voltage adapter with M4 / M6 thread, yellow	WAADAM4M6YE	•	•	•	•
	AC-16 line splitter adapter	WAADAAC16	1	1	1	•
	AZ-2 power supply adapter (IEC C7 plug / banana sockets)	WAADAAZ2			1	
	AZ-3 power supply adapter (mains plug / banana sockets)	WAADAAZ3	1	1		1
	Li-Ion 3.6 V 4.5 Ah battery (replaceable in the SONEL S.A. service)	WAAKU11	1	1		1
	Li-Ion 11.1 V 3.4 Ah battery	WAAKU15			1	
	GPS antenna	WAPOZANT10GPS	•	•		
	GSM signal repeater	WAPOZANTREPEATER	•	•		
	Flexible clamp F-1A (Ø 380 mm) 3 kA	WACEGF1AOKR	•	•	•	•

PQM

Set of standard and optional accessories























1, 2, 4 - number of standard accessories
 - - optional accessories

Photo	Name	Index	PQM-711	PQM-710	PQM-707	PQM-700
	Flexible clamp F-2A (Ø 255 mm) 3 kA	WACEGF2AOKR	•	•	•	•
	Flexible clamp F-3A (Ø 140 mm) 3 kA	WACEGF3AOKR	•	•	4	•
	Flexible clamp F-1A1 (Ø 380 mm) 1.5 kA F-1A6 (Ø 380 mm) 6 kA	WACEGF1A1OKR WACEGF1A6OKR	•	•	•	•
	Flexible clamp F-2A1 (Ø 250 mm) 1.5 kA F-2A6 (Ø 250 mm) 6 kA	WACEGF2A1OKR WACEGF2A6OKR	•	•	•	•
	Flexible clamp F-3A1 (Ø 140 mm) 1.5 kA F-3A6 (Ø 140 mm) 6 kA	WACEGF3A1OKR WACEGF3A6OKR	•	•	•	•
	Flexible clamp F-2AHD (Ø 290 mm) 3 kA	WACEGF2AHDOKR	•	•	•	•
	Flexible clamp F-3AHD (Ø 145 mm) 3 kA	WACEGF3AHDOKR	•	•	•	•
	C-4A current clamp (Ø 52 mm) 1000 A AC	WACEGC4AOKR	•	•	•	•
	C-5A current clamp (Ø 39 mm) 1000 A AC/DC	WACEGC5AOKR	•	•	•	•
	C-6A current clamp (Ø 20 mm) 10 A AC	WACEGC6AOKR	•	•	•	•
	C-7A current clamp (Ø 24 mm) 100 A AC	WACEGC7AOKR	•	•	•	•
	L-4 carrying case	WAFUTL4			1	
	L-5 carrying case	WAFUTL5				1
	Crocodile clip, black 1 kV 20 A	WAKROBL20K01	3	3	3	3
	Crocodile clip, red 1 kV 20 A	WAKRORE20K02	2	2	2	2
	Crocodile clip, blue 1 kV 20 A	WAKROBU20K02	1	1	1	1
	Crocodile clip, yellow 1 kV 20 A	WAKROYE20K02	1	1	1	
	Lead 2.2 m, black 1 kV with L1 marker (banana plugs)	WAPRZ2X2BLBBL1			1	
	Lead 2.2 m, black 1 kV with L2 marker (banana plugs)	WAPRZ2X2BLBBL2			1	
	Lead 2.2 m, black 1 kV with L3 marker (banana plugs)	WAPRZ2X2BLBBL3			1	
	Lead 2.2 m, blue 1 kV (banana plugs)	WAPRZ2X2BUBB			1	
	Lead 2.2 m, yellow-green 1 kV (banana plugs)	WAPRZ2X2GRYEBO			1	
	USB data transmission cable	WAPRZUSB	1	1	1	1
	Pin probe, black 1 kV (banana socket)	WASONBLOGB1			•	

PQM

Set of standard and optional accessories

1, 2, 4 - number of standard accessories
 . - optional accessories

Photo	Name	Index	PQM-711	PQM-710	PQM-707	PQM-700
	Pin probe, red 1 kV (banana socket)	WASONREOGB1			•	
	Pin probe, blue 1 kV (banana socket)	WASONBUOGB1			•	
	Pin probe, yellow 1 kV (banana socket)	WASONYEGB1			•	
	Voltage probe with grasper (5 pcs.)	WASONKGB1KPL	•	•	•	•
	Flat test clip for busbars (5 pcs.)	WASONCGB1KPL	•	•	•	•
	Flat test clip for busbars black	WASONBLCGB1	•	•	•	•
	Flat test clip for busbars blue	WASONBUCGB1	•	•	•	•
	Flat test clip for busbars green	WASONGRCGB1	•	•	•	•
	ASX-1 piercing adapter (4 pcs.)	WAADAPRZASX1KPL	•	•	•	•
	Hanging straps (type L-2)	WAPOZSZEKPL			1	
	Strap for mounting on the pole (set)	WAPOZOPAKPL	1	1		1
	DIN rail mounting bracket with positioning catches	WAPOZUCH3	1	1		1
	Plates for pole mounting	WAPOZUCH4	2	2		2
	Magnetic holder for mounting the meter (2 pcs.)	WAPOZUCH5	•	•		•
	Case for hanging with a magnetic strap (universal)	WAPOZUCH8			•	
	Cover (universal)	WAPOZUCH12			•	
	Hard carrying case for clamps	WAWALL2	•	•	•	•
	XL-2 hard case	WAWALXL2	1	1		•
	XL-12 hard case	WAWALXL12			•	
	Cable for battery charging from the car lighter socket 12 V	WAPRZLAD12SAM			1	
	Mains cable 230 V (IEC C7 plug)	WAPRZLAD230			1	
	Z7 power supply adaptor	WAZASZ7			1	

SONEL ANALYSIS

index: WAPROANALIZA4



“SONEL Analysis” software - application delivered as standard accessory, indispensable for working with PQM-series analyzers. It enables:

- » analyzer configuration,
- » data reading from logger,
- » preview of network parameters in real time (with capability of reading via GSM modem),
- » deletion of data in the analyzer,
- » data presentation in tables,
- » data presentation in charts,
- » data analysis and generating reports in compliance with standard EN 50160 (reports) and other user defined reference conditions - also for PV micro-installations up to 50 kW, a breakdown for active power states $P > 0$, $P < 0$ and $P = 0$ and taking into account the graphs $Q_1 = f(U_1/U_n)$ and $\cos\phi = f(P/P_n)$,
- » independent support of multiple analyzers,
- » analyzer firmware updates.

Analyzer configuration

The application enables configuration of all analyzer settings. Configuration is performed on a computer and then sent to the analyzer. A configuration can also be saved on a hard disk or other data carriers for later use.

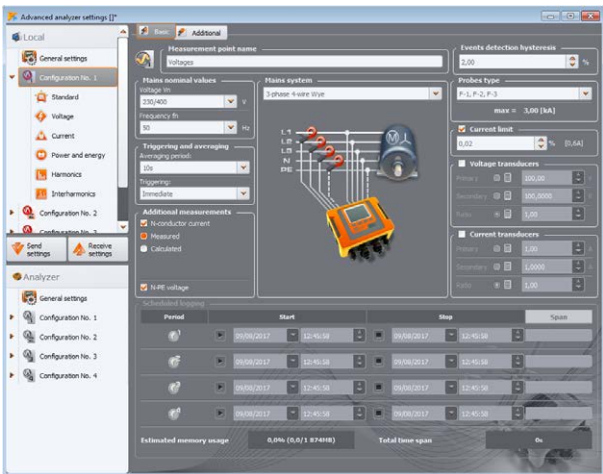

The application enables configuration of, among other things:

- » selection of measurement points and arbitrary memory assignment to individual measurement points,
- » configurable analyzer time,
- » button blockade,
- » PIN code protection against unauthorized access by third parties,
- » configurable averaging time,
- » selection of current and voltage transformers,
- » selection of triggering mode (instant after an event occurs or according to set time schedule),
- » selection of clamp type, selection of additional parameters to be registered in N and PE conductors,
- » selection of the network type for which the analyzer will register all parameters set by the user.

The analyzer has four, mutually independent measurement points. Each measurement point can be configured separately so that four different registrations can be performed later without the need for reprogramming the analyzer in each instance.

The following can be configured for each measurement point:

- » whether the analyzer is to perform registration in terms of compliance with standard EN 50160 and/or according to user-defined parameters,
- » the user may define whether the logger will save instant, mean, maximum or minimum values for each parameter,
- » limits can be defined for most parameters, and the analyzer will log an event if these limits are crossed.

Readout of current data

Sonei Analysis software enables readout of selected parameters and their visualization on the computer screen in real time. These parameters are measured independently from the registration saved on the memory card. The user can view:

- » charts of voltage and current progression (oscilloscope),
- » charts of voltage and current over time,
- » phasor diagrams,
- » measurements of multiple parameters,
- » harmonics and harmonic powers (estimating the direction of harmonics),
- » interharmonics.

Data analysis

Using the application, the user can read and analyze data saved on the memory card. Read data can also be saved on the computer's hard disk for later processing. Thanks to this, archiving of data from successive registrations is possible.

After data reading, the user can conduct analysis. There are three windows to choose from:

- » **General** – all individual types of data are displayed in the form of dots (Measurements, Events and Oscillograms),
- » **Measurements** – all measurement types registered are displayed in the form of dots according to averaging time (voltage, frequency, etc.),
- » **Events** – all types of detected events are displayed in the form of dots (dips, overvoltages, breaks, etc.),
- » **Configuration** – all settings with which data was registered are displayed.

Various types of charts are available in the application, enabling the user to view data registered by the analyzer in a simple way:

- » **Time chart** – displays the progressions of selected parameters over time,
- » **Oscillogram** – instant progressions of voltages and currents during events or at the end of an averaging cycle,
- » **Harmonics chart** – bar graph presenting the level of harmonics of orders 1..50,
- » **value/Time chart** – displays events in the form of dots as a function of the duration of these events.

User-defined reports can be generated using data read from the analyzer, which can then be saved to a hard disk in PDF, HTML, CSV or TXT file format. The application enables generation of a report on compliance with standard EN 50160 and the systems regulation.

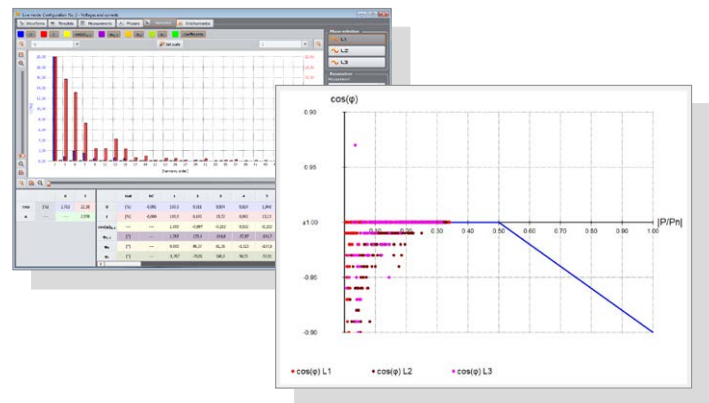

SONEL ANALYSIS MOBILE



Mobile version of the program cooperating with PQM-711 and PQM-710 from Sonei company. With the application, you can connect directly to your device via the Wi-Fi interface and check of current readings of network parameters to which the analyzer is connected.

Useful for users can be remotely start/stop recording, and to change the measurement point (configuration) in the analyzer.

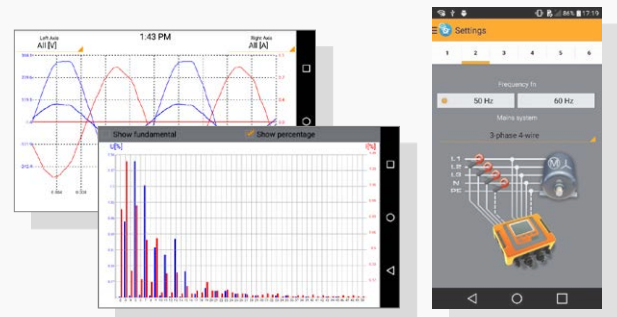

Portable appliance testers



PAT-86
PAT-85
PAT-80



PAT-10
PAT-2E
PAT-2

Safety of electrical equipment

The rules and obligations concerning use of various types of electrical equipment, in both private and professional life, are defined by a broad range of regulations, which, besides imposing the obligation of creating products compliant with the relevant standards on the manufacturer, also **impose responsibility for the technical condition of this equipment and tools on their owners**. These regulations additionally define proper performance of regular tests and inspections as well as checks of equipment after repairs. Therefore, it is worth inspecting the technical condition of owned electrical equipment in the proper manner and with the appropriate frequency. Defective equipment, often damaged without the user's knowledge, poses a great threat to the user, but it can also be the cause of serious financial loss, e.g. in the event of a fire. In such a case, if it is proven that equipment was not fully operational (e.g. damaged insulation), **the manufacturer's liability for the incident is transferred to the owner**. In addition, this may constitute grounds for the insurer's refusal to pay damages.

In 2020, CENELEC (European Committee for Electrotechnical Standardization) published EN 50678 standard on the protective measures of electrical equipment after repair and EN 50699 standard on periodic testing. Both standards (EN 50678 and EN 50699) have been implemented as national standards in many countries – e.g. In Germany and Slovakia – whereas other countries are planning to implement these standards in the near future.

Every tester who uses a safety meter for electrical equipment assumes great responsibility for the both the health and life of users, as well as for their property, when making the decision on whether or not to approve tested equipment for use. Such a person should have a professional meter at their disposal, guaranteeing high accuracy and correct results.

The functions and technical specifications of testers for electrical equipment should allow for complete inspection of the technical condition of electrical equipment and tools, including checks of basic parameters of three-phase equipment. In addition, to ensure the user's work safety and proper measurement results, instruments should be capable of measuring the parameters of the power network (i.e. voltage, frequency, continuity resistance and voltage on protective conductor) immediately after start-up. The capability of performing tests is very useful considering:

- » **automatic mode** – with configuration of custom measurement sequences of parameters selected by the user,
- » **manual mode I** – due to the diversity of tests and standards for different equipment.

Preliminary test (visual) – the meter checks the continuity of L-N conductor and then it shows on the screen the moment when the (visual) inspection the device should take place. Then the tested object should be checked for:

- » condition of the housing,
- » operation of switches,
- » power cord and mains plug,
- » mechanical components,
- » condition of warning and safety elements.

Measurement of protective conductor (PE) resistance – it is carried out with 200 mA current, 10 A or 25 A depending on the requirements and regulations. Resistance of the measurement cable must not affect the measurement result, therefore autozeroing should be performed on the wire measurement cable using the four-wire method.

Insulation resistance measurement – typically required measuring voltage is 500 V DC, but some of the equipment (especially IT) requires a reduced voltage of 250 V or even 100 V. In contrast, industrial machinery and equipment may be tested in some cases with a higher voltage – up to 1000 V.

Measurement of leakage currents – the ability to measure equivalent leakage current, differential leakage current, touch leakage current and PE leakage current. The device should provide testing in a wide frequency band.

Functional test – consists in measuring the parameters of power supply while the tested device is activated. The following parameters are measured/tested: power values, voltage, current, factors of cosφ PF and THD.

Test of IEC cables and extension cords – automatic check of basic parameters of IEC cables and additionally (when a suitable adapter is used) tests on extension cords and cables with IEC 60320-C5 plug. The measurement sequence is performed automatically, and consists of:

- » measurement of PE core insulation resistance,
- » measurement of PE core resistance (continuity),
- » continuity test of L and N conductors and a check for short circuit between them,
- » polarity check.

After setting the measurement duration, programming limit values and completing the measurement, the meter is able to assess the condition of the tested device. With the option of creating measurement sequences, the meter may automatically perform measurements and assess the test results (a positive/negative).

A very important safety element is the documentation and records of tested devices. The system of QR codes that may be printed immediately after the measurements, helps in keeping the records. Data stored in the code, by referring to the device and performed test, will accelerate the operational tests and facilitate the maintenance work.

PC software Sonei PAT Analysis allows user to read and store data from PAT meters, including the settings of devices. Basing on measurement data, the device generates test reports and a measurement schedule is kept, whereas a cloud-based solution provides:

- » smooth data management and transfer in real time,
- » work in a web browser,
- » work in the task ordering mode,
- » protection of staff and fleet,
- » and many more.

	First start-up and modifications	Tests after repair	Periodical tests	Type tests / procedural tests
Equipment tested in compliance with standards	DIN VDE 0751:2001	DIN VDE 0701-0702 DIN VDE 0751:2001 EN 62353 IEC 60601 EN 50678:2020	DIN VDE 0701-0702 E-08:400:1988 DIN VDE 0751:2001 British standards EN 62353 IEC 60601 EN 60974-4 EN 50699	DIN EN 60950/50116 EN 61010 DIN EN 60335/50106 EN 60745-1 IEC 60601
Laboratory instruments		•	•	•
Measuring and inspection instruments		•	•	•
Voltage-generating equipment		•	•	•
Electric tools		•	•	•
Heating equipment		•	•	•
Equipment with electrical drive		•	•	•
Lighting lamps		•	•	•
Multimedia and telecommunications devices		•	•	•
Cable reels, extension cords, connector cables		•	•	•
Data processing devices and office appliances		•	•	•
Electrical equipment for medical applications, components of applications	•	•	•	•
Welding equipment			•	



PAT-86



PAT-85



PAT-80



PAT-10



PAT-2E



PAT-2

MEASUREMENT FUNCTIONS

measurement of resistance of protective conductor (PE) using test current of 200 mA	•	•	•	•	•	•
measurement of resistance of protective conductor (PE) using test current of 10 A	•	•		•		
measurement of resistance of protective conductor (PE) using test current of 25 A	•	•				
measurement of insulation resistance using test voltage of 100 V	•	•				
measurement of insulation resistance using test voltage of 250 V	•	•	•	•	•	
measurement of insulation resistance using test voltage of 500 V	•	•	•	•	•	•
measurement of insulation resistance using test voltage of 1000 V	•	•				
measurement of substitute leakage current	•	•	•	•	•	•
measurement of PE leakage current	•	•	•			
measurement of differential leakage current	•	•	•	•	•	
measurement of touch leakage current	•	•	•	•	•	
power test	•	•	•			
test of IEC power cord	•	•	•	•	•	•
checking the resistance of L-N circuit	•	•	•			
measurement of voltage and frequency in networks	•	•	•	•	•	•
measurement of current consumption	•	•	•	•	•	•
autoranging	•	•	•	•	•	•
autotests	•	•	•	•	•	•
autotests with the option of describing them with the name of the standards or name set by user	•	•	•			
function of automatic measurement of RCD and PRCD parameters	•	•	•	PRCD	PRCD	
measurement of current using clamps	•	•	•			
SELV/PELV measurement	•	•	•			

MEASUREMENTS OF WELDING APPLIANCES

measurement of rated voltage of welding appliances in unloaded state	•					
measurement of leakage current of welding circuit I_L	•					
measurement of primary leakage current I_p	•					
automatic three-lead insulation resistance measurement	•					

COMMUNICATION WITH COMPUTER

communication with computer via USB	•	•	•	•	•	•
cooperation with software: Sonel Reader and Sonel PAT Analysis (optional)	•	•	•	•	•	•
configuration of measurements and meter settings using computer and the meter's interface	•	•	•	•	•	•
Wi-Fi	•	•	•	•	•	•
Bluetooth	•	•	•			
LAN	•	•	•			

MEMORY

internal memory	•	•	•	•	•	•
cooperation with USB memory stick	•	•	•			
saving to memory along with initial description of examined appliances, location of measurements and data of client, assigning serial number and index to the measured appliance, capability of adding notes to the tested appliance, damage description	•	•	•	in mobile application	in mobile application	in mobile application
operation in Sonel QR system	•	•	•			

USABLE FUNCTIONS

operating of QWERTY keyboard on a big and readable touchscreen with backlit	•	•	•			
possibility of adding several PAT users with the option of logging in	•	•	•			
help available on the screen - containing instructions on how to connect the tested appliance and perform the measurement	•	•	•			
cooperation with barcode scanner	•	•	•			
cooperation with printer	•	•	•	•	•	•
operation using internal battery	•	•	•	•	•	•

SONEL PAT-86 / PAT-85 / PAT-80

index: WMGBPAT86 / WMGBPAT85 / WMGBPAT80



Basic functions of the tester:

- » PAT-86 | safety measurements of welding equipment
- » resistance measurement of protective conductor (protection class I) with current:
 - PAT-80 | 200 mA,
 - PAT-85 • PAT-86 | 200 mA, 10 A, 25 A,
- » insulation resistance measurement - four measurement voltages:
 - PAT-80 | 250 V, 500 V,
 - PAT-85 • PAT-86 | 100 V, 250 V, 500 V, 1000 V,
- » measurement of equivalent leakage current,
- » measurement of differential leakage current,
- » measurement of touch leakage current,
- » power measurement,
- » measurement of electricity consumption,
- » IEC cable test,
- » measurement of network voltage and frequency,
- » testing of RCD / PRCD parameters,
- » current measurement with clamp.

Additional features:

- » remote measurement enabling ordering the measurement sequence via computer and re-sending the result,
- » automatic measurement procedures,
- » professional software for data processing and report generation,
- » supports barcode reader and printer,
- » supports USB flash drive storage devices,
- » ergonomic operation,
- » battery operation up to 1 hour.

Electrical safety:

- » this product meets EMC requirements in compliance with standard EN 61326-1 and EN 61326-2-2
- » type of insulation CAT II 300 V according to EN 61010-1
- » housing protection rating according to EN 60529 IP40

Other technical specifications:

- » power supply of the meter network: 195...265 V, 50 Hz
..... battery: 7.2 V 2 Ah
- » load current max. 16 A (230 V)
- » data transmission to PC computer Wi-Fi, LAN, USB
- » dimensions 318 x 257 x 152 mm
- » meter weight approx. 5 kg
- » elevation above sea level <2000 m
- » display LCD TFT 5.6" 800 x 480

Nominal operating conditions:

- » operating temperature range -10...+50°C
- » storage temperature -20...+70°C
- » humidity 20...80%

Standard accessories:

Fuse 16 A, 250 V AC, 5 x 20 mm (2 pcs.)	WAPOZB16PAT
Crocodile clip, red, 1 kV, 20 A (only PAT-86)	WAKRORE20K02
Crocodile clip, blue, 1 kV, 20 A (only PAT-86)	WAKROBU20K02
Test lead 1.8 m, orange (10 A / 25 A, terminated in a crocodile clip)	WAPRZ1X8ORKS
Double-wire test lead 1.5 m (PAT/banana plug) (only PAT-86)	WAPRZ1X5DZBB
USB cable	WAPRZUSB
Mains cable with IEC C19 plug	WAPRZZAS1
L-11 carrying case	WAFUTL11
Factory calibration certificate	

PAT-86 | Safety measurements of welding equipment

Measurement of primary circuit leakage current I_p

Display range	Resolution	Accuracy
0.00...14.99 mA	0.01 mA	±(5% w.m. + 5 digits)

- » measurement meets the requirements of EN 60974-4

Measurement of welding circuit leakage current I_L

Display range	Resolution	Accuracy
0.00...14.99 mA	0.01 mA	±(5% w.m. + 2 digits)

- » measurement meets the requirements of EN 60974-4

Measurement of welding circuit voltage in a no-load state U_0

Display range	Resolution	Accuracy
5.0...240.0 V	0.1 V	±(2.5% w.m. + 5 digits)

- » voltage root mean square U_{RMS} measurement
- » voltage peak value U_{PEAK} measurement

Resistance measurement of protective earth conductor $I=200$ mA (protection class I)

Display range	Resolution	Accuracy
0.00...0.99 Ω	0.01 Ω	±(4% w.m. + 2 digits)
1.00...19.99 Ω		±(4% w.m. + 3 digits)

- » measurement current: ≥ 200 mA for $R = 0.2...1.99 \Omega$

Resistance measurement of protective earth conductor $I=10$ A (protection class I)

Display range	Resolution	Accuracy
0...999 m Ω	1 m Ω	±(3% w.m. + 4 digits)
1.00...1.99 Ω	0.01 Ω	

- » technical method of measurement ensuring high accuracy of obtained results
- » measurement current: ≥ 10 A for $R \leq 0.5 \Omega$

Resistance measurement of protective earth conductor $I=25$ A (protection class I)

Display range	Resolution	Accuracy
0...999 m Ω	1 m Ω	±(3% w.m. + 4 digits)
1.00...1.99 Ω	0.01 Ω	

- » technical method of measurement ensuring high accuracy of obtained results
- » measurement current: ≥ 25 A for $R \leq 0.2 \Omega$

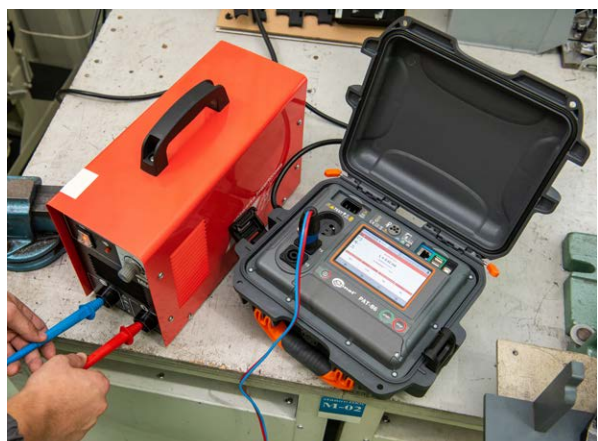

Measurement of insulation resistance

Measuring range according to IEC 61557-2 for:

Un=100 V: 100 kΩ...99.9 MΩ (only PAT-85, PAT-86)

Un=250 V: 250 kΩ...199.9 MΩ

Un=500 V: 500 kΩ...599.9 MΩ

Un=1000 V: 1 MΩ...599.9 MΩ

U _a displayed	Display range	Resolution	Accuracy
100 V	0...1999 kΩ	1 kΩ	±(5% w.m. + 8 digits)
	2.00...19.99 MΩ	0.01 MΩ	
	20.0...99.9 MΩ	0.1 MΩ	
250 V	0...1999 kΩ	1 kΩ	
	2.00...19.99 MΩ	0.01 MΩ	
	20.0...199.9 MΩ	0.1 MΩ	
500 V	0...1999 kΩ	1 kΩ	
	2.00...19.99 MΩ	0.01 MΩ	
	20.0...599.9 MΩ	0.1 MΩ	
1000 V	0...1999 kΩ	1 kΩ	
	2.00...19.99 MΩ	0.01 MΩ	
	20.0...599.9 MΩ	0.1 MΩ	

- » automatic discharge of the measured object's capacitance upon completion of measurement
- » protection against measurement of live objects
- » max. output current 1.4 mA

Measurement of leakage current

PE leakage current and differential leakage current

Display range	Resolution	Accuracy
0.00...3.99 mA	0.01 mA	±(5% w.m. + 2 digits)
4.0...19.9 mA	0.1 mA	

- » at half of the measurement time, the meter automatically changes the polarity of the measuring network socket and displays a greater value

Equivalent leakage current

Display range	Resolution	Accuracy
0.00...3.99 mA	0.01 mA	±(5% w.m. + 2 digits)
4.0...19.9 mA	0.1 mA	

- » open-circuit voltage: 25...50 V

Touch leakage current

Display range	Resolution	Accuracy
0.000...4.999 mA	0.001 mA	±(5% w.m. + 3 digits)

Testing of RCD / PRCD parameters

RCD trip test and measurement of tripping time t_A

RCD type	Factor	Range	Resolution	Accuracy
General	0.5 I _{Δn}	0...300 ms	1 ms	±(2% w.m. + 2 digits)*
	1 I _{Δn}			
	2 I _{Δn}	0...150 ms		
	5 I _{Δn}	0...40 ms		

*for RCD of I_{Δn} = 10 mA and the measurement 0.5 I_{Δn} error: ± (2% m.v. + 3 digits)

Measurement of RCD trip current I_A for sinusoidal residual current

Measuring range according to IEC 61557: (0.3...1.0)I_{Δn}

Nominal current	Measuring range	Resolution	Measurement current	Accuracy
10 mA	3.0...10.0 mA	0.1 mA	0.3 I _{Δn} ...1.0 I _{Δn}	± 5% I _{Δn}
15 mA	4.5...15.0 mA			
30 mA	9.0...30.0 mA			

- » measurement can be started from a positive or negative half-period of the input leakage current
- » max. measurement current flow time 3200 ms

Power test

Apparent power S measurement

Display range	Resolution	Accuracy
0...999 VA	1 VA	±(5% w.m. + 3 digits)
1...3.99 kVA	0.01 kVA	

Active power P measurement

Display range	Resolution	Accuracy
0...999 W	1 W	±(5% w.m. + 3 digits)
1.00 k...3.99 kW	0.01 kW	

Reactive power Q measurement

Display range	Resolution	Accuracy
0...999 Var	1 Var	±(5% w.m. + 3 digits)
1.00 k...3.99 kvar	0.01 kvar	

PF power factor

Display range	Resolution	Accuracy
0.00...1.00	0.01	±(10% w.m. + 5 digits)

Cosφ factor

Display range	Resolution	Accuracy
0.00i...1.00i	0.01	±(5% w.m. + 5 digits)
0.00c...1.00c		

Current measurement

Display range	Resolution	Accuracy
0.00...15.99 A	0.01 A	±(2% w.m. + 3 digits)

Voltage measurement

Display range	Resolution	Accuracy
195.0...265.0 V	0.1 V	±(2% w.m. + 2 digits)

Current measurement with clamp

Display range	Resolution	Accuracy
100 mA...999 mA	1 mA	±(5% w.m. + 5 digits)
1.00 A...9.99 A	0.01 A	
10.0 A...24.9 A	0.1 A	

- » The accuracy given in the table does not account for the accuracy of the measuring clamp

THD of voltage and current

Display range	Resolution	Accuracy
0.0...99.9%	0.1%	±(5% w.m. + 5 digits)

The instruments enable measurements in compliance with:

- » EN 50678:2020 General requirements for safety testing of electrical equipment after repair.
- » EN 50699:2021 Recurrent tests of electrical equipment.
- » EN 60745-1 Hand-held motor-operated electric tools. Safety. Part 1: General requirements.
- » EN 61029 Safety of transportable motor-operated electric tools. General requirements.
- » EN 60335-1 Household and similar electrical appliances. Safety. General requirements.
- » EN 60950 Safety of information technology equipment.
- » EN 61557-6 Electrical safety in low voltage distribution systems up to 1000 V a.c. and 1500 V d.c. - Equipment for testing, measuring or monitoring of protective measures - Part 6: Effectiveness of residual current devices (RCD) in TT, TN and IT systems.
- » VDE 0404-1 Prüf- und Messeinrichtungen zum Prüfen der elektrischen Sicherheit von elektrischen Geräten. Teil 1: Allgemeine Anforderungen.
- » VDE 0404-2 Prüf- und Messeinrichtungen zum Prüfen der elektrischen Sicherheit von elektrischen Geräten. Teil 2: Prüfeinrichtungen für Prüfungen nach Instandsetzung, Änderung oder für Wiederholungsprüfungen.
- » VDE 0701-0702 Prüfung nach Instandsetzung, Änderung elektrischer Geräte. Wiederholungsprüfung elektrischer Geräte. Allgemeine Anforderungen für die elektrische Sicherheit.
- » AS/NZS 3760:2010 In-service safety inspection and testing of electrical equipment.

SONEL PAT-10 / PAT-2E / PAT-2

index: WMGBPAT10 / WMGBPAT2E / WMGBPAT2



- CAT II
- 300 V
- IP40

Features

Innovative combination of **small overall dimensions** (and the transportability of the device related to this) with **advanced measurement systems** allowing for complete performance of automatic measurements for electrical devices as well as IEC cables and extension cords (including those with PRCD).

Complete set of tests performed after just one press of the START button. The meter's configuration capabilities allow for modification of the method of the instrument's operation, which makes it **even better adapted to the user's needs**. In situations where it is necessary to perform unit measurements without the need to perform the entire, complex measurement procedure, PATs from Sonel enable **operation in single measurement mode** (of a given type - so-called manual measurements).

All meters in this series additionally enable performance of **basic measurements without an external power source**, in emergency situations where there is no network power, simplified test sets can be initiated in battery operating mode.

Small overall dimensions, light weight and a specially designed carrying case for the meter and accessories provide **convenience** of use and **high mobility of the instrument**. Wireless communication with a printer allows for organization of the location where measurements are performed without a tangle of unnecessary cables. Saving of results to memory and integration of results in PC software additionally broaden the instrument's functionality.

Basic functions of the PAT-10 instrument

- » diode indicating result assessment,
- » quick access to measurement procedures,
- » compact housing, ergonomic carrying case,
- » automatic selection of measuring ranges,
- » resistance measurement of protective conductor with current: 200 mA, 10 A.
- » measurement of insulation resistance.
- » measurement of PRCD trip time.
- » measurement of equivalent, differential and touch leakage current,
- » IEC cable test,
- » saving of results to memory,
- » compatibility with Sonel Reader and Sonel PAT Analysis software (optional),
- » cooperation with the Sonel PAT Analysis Mobile application.



Standard accessories

Fuse 16 A, 250 V AC, 5 x 20 mm (2 pcs.) <small>(only PAT-10, PAT-2E)</small>	WAPOZB16PAT
M12 carrying case	WAFUTM12
Test lead 1.2 m, red, 1 kV (terminated in a crocodile clip)	WAPRZ1X2REBK
USB cable	WAPRZUSB
Mains cable with IEC C19 plug	WAPRZZAS1
Factory calibration certificate	

The instrument can be used for tests of equipment, including tests compliant with standards:

- » EN 50699:2021 Recurrent tests of electrical equipment
- » EN 60745 - 1: Hand-held motor-operated electric tools. Safety. Part 1: General requirements.
- » EN 61029: Safety of transportable motor-operated electric tools. General requirements.
- » EN 60335 - 1: Household and similar electrical appliances. General requirements.
- » EN 60950: Safety of information technology equipment.
- » EN 61557-6 Electrical safety in low voltage distribution systems up to 1000 V a.c. and 1500 V d.c. - Equipment for testing, measuring or monitoring of protective measures - Part 6: Effectiveness of residual current devices (RCD) in TT, TN and IT systems.
- » VDE 0701-0702 Prüfung nach Instandsetzung, Änderung elektrischer Geräte. Wiederholungsprüfung elektrischer Geräte. Allgemeine Anforderungen für die elektrische Sicherheit.

Model	PAT-10	PAT-2E	PAT-2
Visual assessment	✓	✓	✓
Resistance measurement of protective earth conductor I = 200 mA	0.01...19.99 Ω	0.01...19.99 Ω	0.01...19.99 Ω
Resistance measurement of protective earth conductor I = 10 A	0.01...1.99 Ω	-	-
Insulation resistance measurement U = 250 V	0.25...99.9 MΩ	0.25...99.9 MΩ	-
Insulation resistance measurement U = 500 V	0.50...99.9 MΩ	0.50...99.9 MΩ	0.50...99.9 MΩ
Measurement of substitute leakage current	0.01...19.9 mA	0.01...19.9 mA	0.01...19.9 mA
Measurement of touch leakage current	0.001...4.999 mA	0.001...4.999 mA	-
Measurement of differential leakage current	0.10...19.9 mA	0.10...19.9 mA	-
IEC cable test (R _{iso} , R _{pe} , polarity)	✓	✓	✓
PRCD test (tripping time for I _{Δn} ; x1/x5; 0° and 180°)	10 mA, 30 mA	10 mA, 30 mA	-
Built-in memory for results / transmission to computer	✓	✓	✓
Wi-Fi	✓	✓	✓
Compatible with printer	✓	✓	✓
Meter configuration from computer	✓	✓	✓
Power supply	Network power supply: 220 V; 230 V; 240 V 50/60 Hz Built-in rechargeable battery	Network power supply: 220 V; 230 V; 240 V 50/60 Hz Built-in rechargeable battery	Built-in rechargeable battery (measurements can be performed during charging)
Measurement category CAT II 300V	✓	✓	✓
Weight	approx. 1.40 kg	approx. 1.40 kg	approx. 1.40 kg
Dimensions	200 x 180 x 77 mm	200 x 180 x 77 mm	200 x 180 x 77 mm

SONEL PAT ANALYSIS MOBILE



The **mobile application** extends the capabilities of SoneL PAT-10, PAT-2E, PAT-2 test-ers series. SoneL PAT Mobile is available on Android system.

SoneL PAT Analysis Mobile:

- » connects wirelessly to the selected tester
- » downloads measurement results,
- » saves results to PAT structure (client, appliances and measurement data),
- » prints reports,
- » reads QR codes of the PAT system,
- » ensures full compatibility with the SoneL QR code system and the object-oriented memory structure
- » sends data via internet.

In addition, the application allows you to read QR codes.

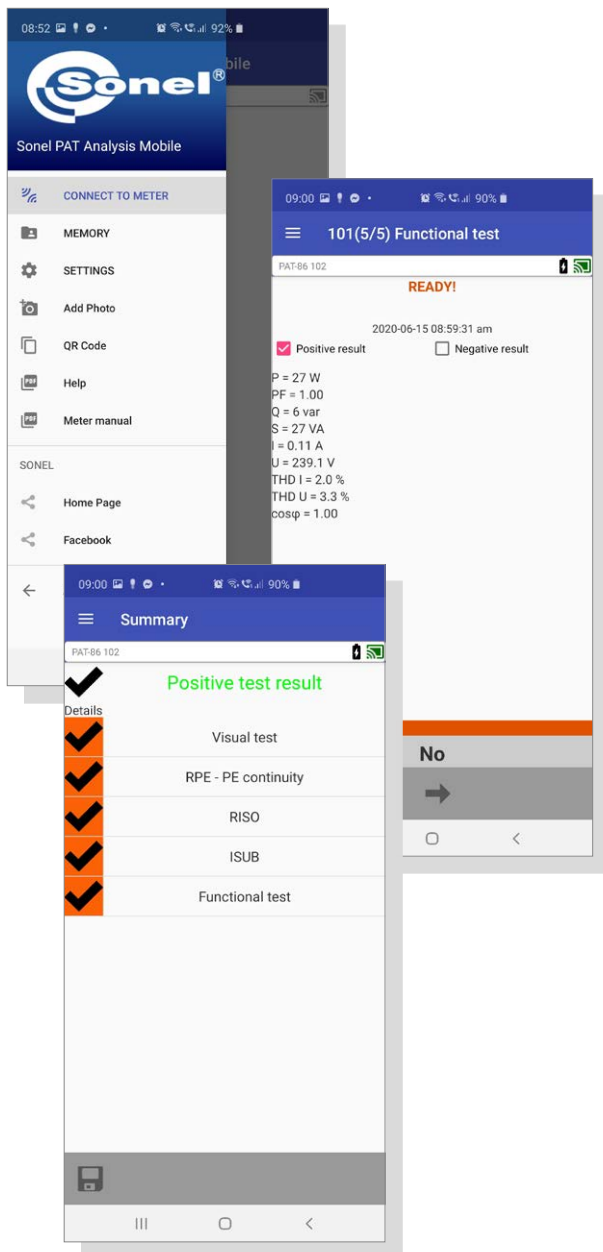

SONEL PAT ANALYSIS

index: WAPROSONPAT3

This software is intended for companies that perform safety measurements of electrical equipment.

Applications are compatible with SoneL PAT-series testers. Data saved by the meter is entered into the test report for the selected item of equipment.

- » Perfect for production plants, electrical tool rental services, repair and maintenance services, etc.
- » Hierarchical data entry structure - a device is assigned to a specific company or department.
- » Capability of gathering information about a given piece of equipment.
- » Tracking the test history of a device.
- » Capability of advanced meter configuration via software.
- » Label printing on standard adhesive papers.
- » Capability of creating a custom measurement standard using the report editor.
- » Capability of scheduling measurements - every device contains a "Measurement cycle" list - the application automatically displays devices whose testing deadline is approaching or has expired.
- » It enables remote sending a measurement procedure to the PAT-8x meter.

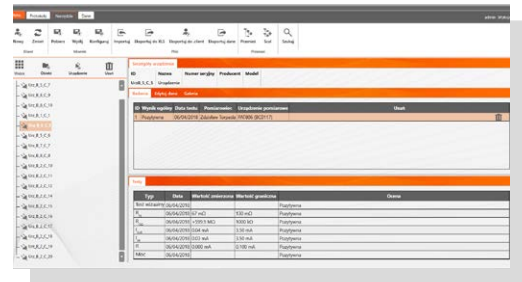

Available report forms:

- » full report on one test - on an A4 page, with complete data about the device and a complete series of tests,
- » test history for device - all measurement results are printed according to defined criteria (from a given period),
- » abbreviated report/record sheet - prints the test history with basic information about the device and information on approval for use.

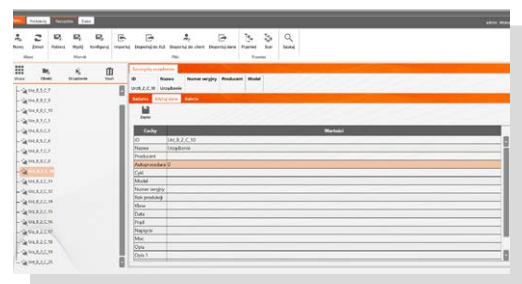

Report printing according to the following standards:

VDE 0701:1, VDE 0701:200, VDE 0701:240, VDE 0701:260, DIN VDE 0702, EN 61010, EN 60335, EN 60950, IEC 60601, EN62353

System requirements:

- » Operating system: Windows 10
- » Minimum resolution: 1024x768
- » Recommended resolution: 1920x1080

SONEL PAT SERVER

This software:

- » allows for smooth data management,
- » enables work through a web browser,
- » enables work in the task ordering mode,
- » stores a copy of data on the server.

Using PAT Server, the user may:

- » work with a permanent connection to the system,
- » have unlimited access to the software,
- » have immediate access to reporting,
- » look after the crew and fleet,
- » control access.

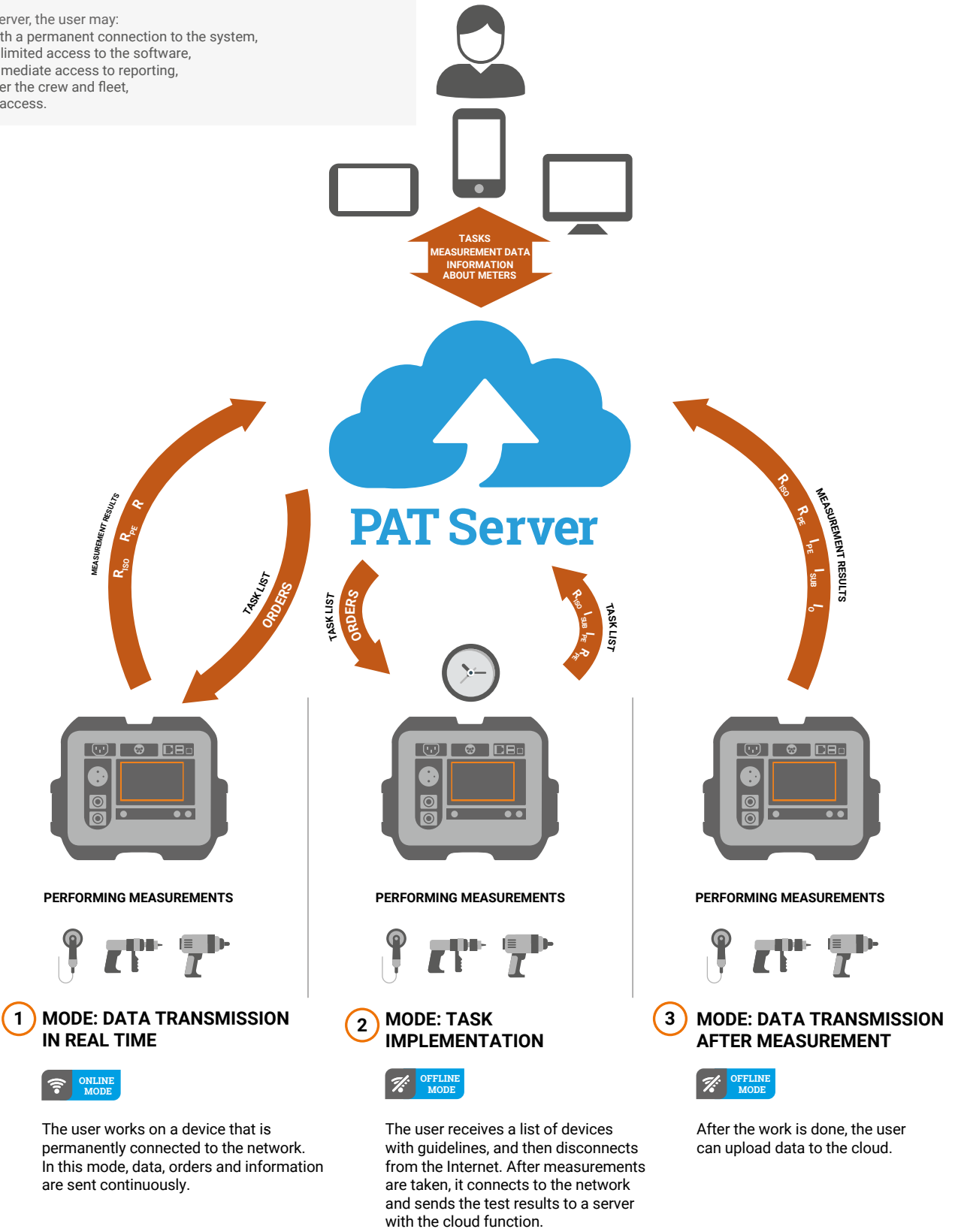

1 MODE: DATA TRANSMISSION IN REAL TIME



The user works on a device that is permanently connected to the network. In this mode, data, orders and information are sent continuously.

2 MODE: TASK IMPLEMENTATION



The user receives a list of devices with guidelines, and then disconnects from the Internet. After measurements are taken, it connects to the network and sends the test results to a server with the cloud function.

3 MODE: DATA TRANSMISSION AFTER MEASUREMENT



After the work is done, the user can upload data to the cloud.

PAT

Set of standard and optional accessories

1, 2, 4 - number of standard accessories
 - - optional accessories

Photo	Name	Index	PAT-86	PAT-85	PAT-80	PAT-10	PAT-2E	PAT-2	Photo	Name	Index	PAT-86	PAT-85	PAT-80	PAT-10	PAT-2E	PAT-2	
	PAT-3F-PE adapter for leakage current testing	WAADAPAT3FPE	•	•	•					Barcode scanner 2D (USB)	WAADACK2D	•	•	•				
	Adapter for an industrial socket 16 A	WAADAPAT16F1	•	•	•	•	•	•		D2 portable USB report / barcode printer (Sato)	WAADAD2	•	•	•				
	Adapter for an industrial socket 32 A	WAADAPAT32F1	•	•	•	•	•	•		D3 portable Wi-Fi / USB report / barcode printer (Brother)	WAADAD3	•	•	•	•	•	•	
	Adapter for three-phase socket 16 A (5P)	WAADAPAT16P	•	•	•	•	•	•		L11 carrying case	WAFUTL11	1	1	1				
	Adapter for three-phase socket 16 A Switchable (5P)	WAADAPAT16PR	•	•	•	•	•	•		M12 carrying case	WAFUTM12				1	1	1	
	Adapter for three-phase socket 32 A (5P)	WAADAPAT32P	•	•	•	•	•	•		Crocodile clip red 1 kV 20 A	WAKRORE20K02	1	•	•	•	•	•	
	Adapter for three-phase socket 32 A switchable (5P)	WAADAPAT32PR	•	•	•	•	•	•		Crocodile clip blue 1 kV 20 A	WAKROBU20K02	1	•	•				
	Adapter for three-phase socket 16 A (4P)	WAADAPAT16C	•	•	•	•	•	•		Kelvin clamp 1 kV, 25 A	WAKROKELK06	•	•	•				
	Adapter for three-phase socket 16 A switchable (4P)	WAADAPAT16CPR	•	•	•	•	•	•		IEC Test adapter (Shuko)	WAADAPATIEC1	•	•	•	•	•	•	
	Adapter for three-phase socket 32 A (4P)	WAADAPAT32C	•	•	•	•	•	•		IEC C6 to C13 adapter	WAADAPATIEC2	•	•	•	•	•	•	
	Adapter for three-phase socket 32 A switchable (4P)	WAADAPAT32CPR	•	•	•	•	•	•		Test lead 1.2 m, red, 1 kV (2.5 mm2, banana plugs)	WAPRZ1X2REBB2X5					•	•	•
	Battery for Brother printer	WAAKU19	•	•	•	•	•	•		Test lead 1.2 m, red, 1 kV (terminated in a crocodile clip)	WAPRZ1X2REBK				1	1	1	
	Fuse 5 x 20 mm, 16 A (2 pcs.)	WAPOZB16PAT	1	1	1	1	1			Test lead 1.8 m, orange, (10 A / 25 A, terminated in a crocodile clip)	WAPRZ1X8ORKS	1	1	1				
	C-3 current clamp (Ø52 mm)	WACEGC30KR	•	•	•					Double-wire test lead 2.1 m (IEC C13 / banana plug)	WAPRZ2X1DZIECB	1	•	•				

PAT

Set of standard and optional accessories

1, 2, 4 - number of standard accessories
 • - optional accessories

Photo	Name	Index	PAT-86	PAT-85	PAT-80	PAT-10	PAT-2E	PAT-2
	Double-wire test lead 1.5 m (PAT/banana plug)	WAPRZ1X5DZBB	1	•	•			
	USB cable	WAPRZUSB	1	1	1	1	1	1
	Mains cable with IEC C19 plug	WAPRZZAS1	1	1	1	1	1	1
	Pin probe, red 1 kV (banana socket)	WASONREOGB1	•	•	•	•	•	•
	Pin probe, blue 1 kV (banana socket)	WASONBUOGB1	•	•	•			
	Brush probe	WASONSZ1				•	•	•
	High-current pin probe 1 kV (banana sockets)	WASONSPGB1	•	•	•			
	Ribbon for printer Brother D1 (with glue)	WANAKD1	•	•	•			
	Label Roll - Black on White for D2 printer SATO (with glue)	WANAKD2	•	•	•			
	Label Roll - Black on White for Brother D3 (with glue)	WANAKD3	•	•	•	•	•	•
	Ribbon for D2 printer (SATO)	WANAKD2BAR	•	•	•			
	PC software: Sonel PAT Analysis	WAPROSONPAT3	•	•	•	•	•	•
	PC software: Sonel Reader	WAPROREADER	1	1	1	1	1	1

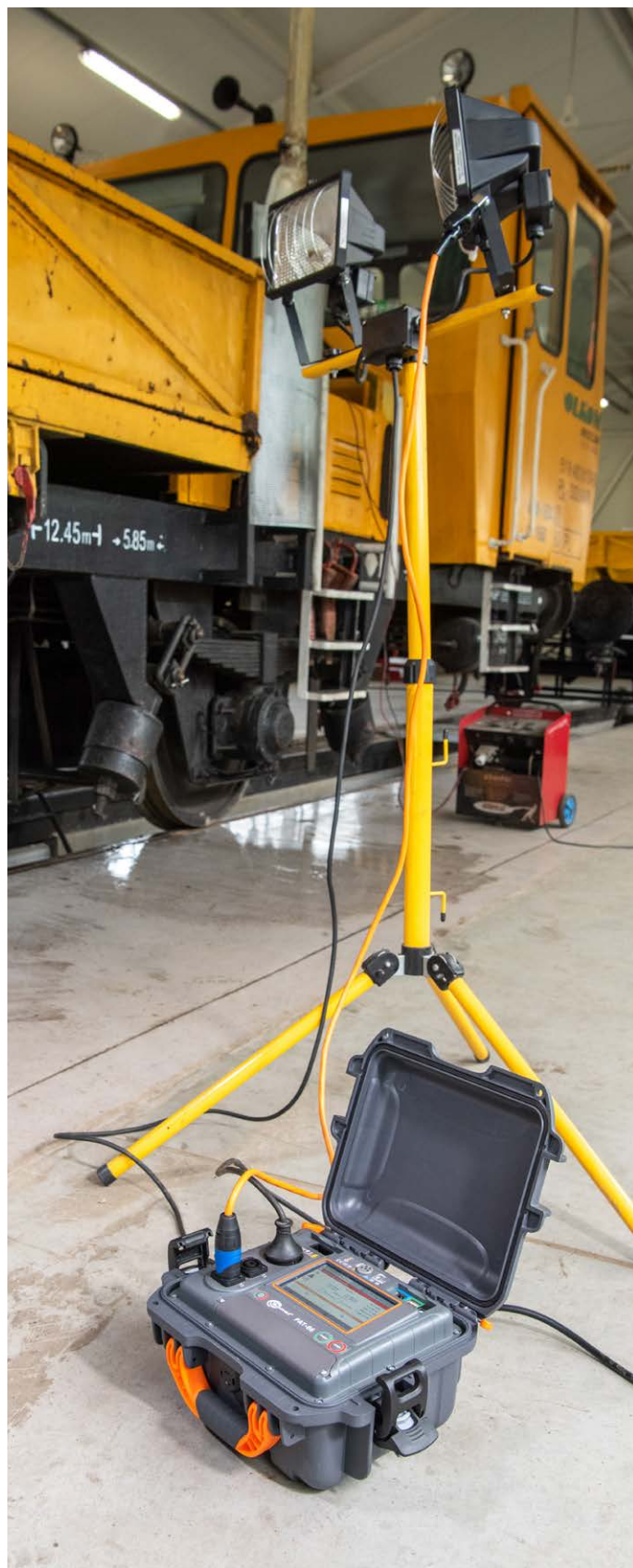

Clamp meters

- CMP-3000
- CMP-2000
- CMP-1015-PV
- CMP-1010
- CMP-1006
- CMP-403
- CMP-402
- CMP-401
- CMP-400
- CMP-3kR
- CMP-200F
- CMP-200



Digital multimeters

- CMM-60
- CMM-40
- CMM-30
- CMM-11
- CMM-10



Voltage testers

- P-6
- P-5
- P-4
- VT-3
- VT-2



...and much more
distance meter
phase rotation testers

Voltage adapter

SONEL AHV-3

index: WAADAAHV3



The Sonel AHV-3 adapter enables high voltage measurement in accordance with CAT III 3000 V DC in combination with the dedicated Sonel CMP-1015-PV clamp meter or compatible CMM and CMP series meters.

Standard accessories:

- » 2x pin probe 3 kV DC (banana socket) black
- » test leads set for CMM/CMP (banana plugs)
- » M13 carrying case



Mounting adapter for AHV-3

index: WAPOZUCH13



It is used to attach the AHV-3 adapter to the clamps of the CMP-1015-PV meter.

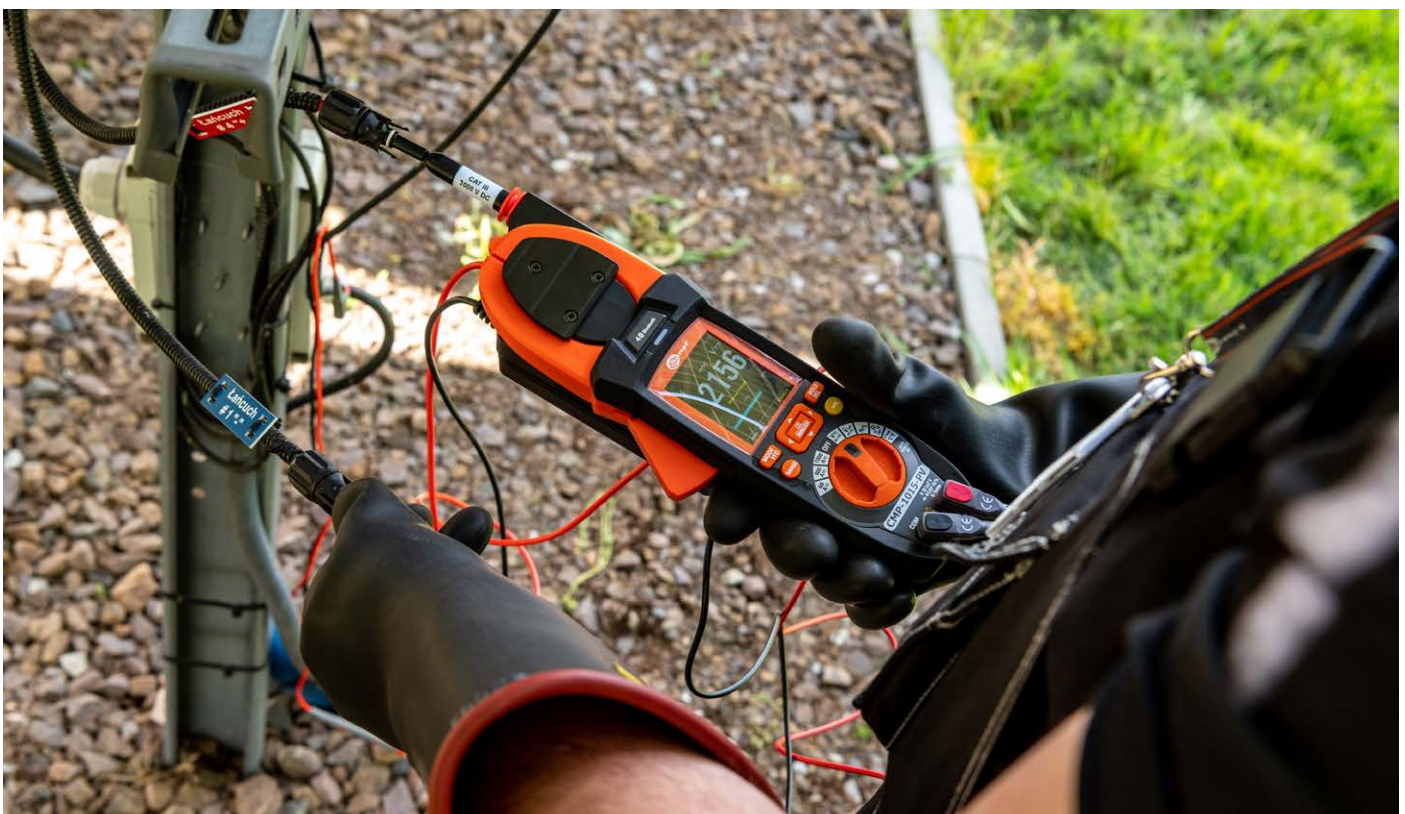



Line splitter

SONEL AC-16

index: WAADAAC16

- » ratio x1, x10
- » maximum voltage: 230 V AC
- » maximum current: 16 A
- » the adapter can be applied with any type of clamp meter



Universal magnetic hanging strap

index: WAPOZUCH6

Universal magnetic holder for mounting the meter to metal surfaces, e.g. switchgear doors.



Crocodile clip mini, set, 1 kV 10 A

index: WAKROKPL10MINI

Crocodile clips for mounting on the probe's blades with a diameter of 2 mm, used in CMM and CMP multimeters.



SONEL MULTIMETER MOBILE



Sonel Multimeter Mobile application is intended for reading measurement values in live mode, as well as for transferring and storing measurement results in the memory of mobile devices based on the Android system. Currently the application supports **CMP-3000**, **CMP-1015-PV**, **CMP-3kR**, **CMM-60**, **CMM-30** and **CMM-11** multimeters. It can be downloaded from **Google Play**.

The application enables:

- » reading the multimeter's measurement results in live mode, thanks to Bluetooth wireless data transfer,
- » saving results as a project and complete it with notes and photos from measurement places,
- » reading saved results in two forms: list with date and hour of the measurement, as well as in form of a chart for easier analysis of changes and distortions.

Additional application features i.a.:

- » setting sampling rate and duration of the measurement,
- » setting upper and lower limit with acoustic signal in case of exceeding the set limits,
- » controlling measurement subfunctions, i.e. MAX/MIN, REL or RANGE,
- » fast access to the instrument's website,
- » sending data via e-mail,
- » possibility of saving data to .csv file.

Comparison of clamp multimeters



	CMP-3000 High-end model for industry area	CMP-2000 High-end model for industry area	CMP-1015-PV High-end model for photovoltaics and industry area	CMP-1010 Various applications in industry	CMP-1006 Various applications in industry	CMP-403 For general use
Measurement functions						
AC/DC voltage	1000 V / 1000 V	750 V / 1000 V	1000 V / 1500 V	1000 V / 1000 V	600.0 V / 600.0 V	1000 V / 1000 V
AC/DC current	3000 A / 1000 A	1500 A / 2000 A	1000 A / 1000 A	1000 A / 1000 A	1000 A / 1000 A	400.0 A / 400.0 A
Resistance	40.000 MΩ	60.00 MΩ	60.00 MΩ	60.00 MΩ	66.00 MΩ	40.00 MΩ
Frequency	50.000 MHz	1.000 MHz	10.00 MHz	99.99 kHz	15.00 kHz	current: 999.9 Hz voltage: 99.99 kHz
Capacitance	5.0000 mF	6.599 mF	100.0 mF	100.0 mF	-	99.99 mF
Temperature	1000°C	1000°C	1000°C	1000°C	760°C	1000°C
Non-contact voltage indication	✓	-	✓	✓	-	✓
Duty cycle (%)	✓	✓	✓	✓	✓	✓
Continuity / diode test	✓ / ✓	✓ / ✓	✓ / ✓	✓ / ✓	✓ / ✓	✓ / ✓
Current and voltage measurements downstream the inverter, frequency converter or in the VFD system	-	-	✓	✓	-	✓
High voltage DC measurement (HVDC)	-	-	✓	-	-	-
Inrush current	✓	✓	✓	✓	✓	✓
Low Z	-	-	✓	✓	-	-
Basic features						
True RMS measurement	✓	✓	✓	✓	✓	✓
Automatic / manual range selection	✓ / ✓	✓ / ✓	✓ / ✓	✓ / ✓	✓ / ✓	✓ / ✓
Maximum diameter of measured conductor	hard clamp: 48 mm flexible clamp: 160 mm	57 mm (conductor) 70 x 18 mm (bus bar)	48 mm	35 mm	34 mm	30 mm
Input impedance	10 MΩ	10 MΩ	9 MΩ (AC) 10 MΩ (DC)	10 MΩ	10 MΩ	10 MΩ
Advanced features						
MAX / MIN / AVG measurement	✓ / ✓ / -	✓ / ✓ / -	✓ / ✓ / -	-	✓ / ✓ / -	- / - / -
HOLD	✓	✓	✓	✓	✓	✓
PEAK HOLD	-	-	✓	-	-	-
PEAK MIN / PEAK MAX	-	-	-	✓ / ✓	-	✓ / ✓
AC+DC	-	-	✓	-	-	-
Relative measurement	✓	✓	✓	✓	✓	✓
Recorder	-	-	✓	-	-	-
Memory	in mobile app	-	✓	-	-	-
Bluetooth	✓	-	✓	-	-	-
Sonei Multimeter Mobile	✓	-	✓	-	-	-
Other features						
Automatic power down	✓	✓	✓	✓	✓	✓
Battery indicator	✓	✓	✓	✓	✓	✓
Beeper	✓	✓	✓	✓	✓	✓
Dimensions	230 x 76 x 40 mm	281 x 108 x 53 mm	273 x 96 x 48 mm	250 x 90 x 40 mm	229 x 80 x 49 mm	220 x 80 x 39 mm
Weight	501 g	570 g	490 g	329 g	303 g	270 g
Display						
Graphical	-	-	✓	-	-	-
Segmented	✓	✓	-	✓	✓	✓
Counting	50000, 4 4/5 digits	6600, 3 4/5 digits	6000	6000	6600, 3 4/5 digits	4000
Screen backlit	✓	✓	✓	✓	✓	✓
Safety and conditions of use						
Measurement category (EN 61010)	CAT IV 600 V CAT III 1000 V	CAT IV 600 V CAT III 1000 V	CAT IV 600 V CAT III 1000 V	CAT IV 600 V III 1000 V	CAT IV 300 V CAT III 600 V	CAT III 600 V CAT II 1000 V
Ingress protection	IP40	IP20	IP40	IP30	IP40	IP30
Operating temperature	5...40°C	0...50°C	5...40°C	5...40°C	5...40°C	5...40°C



	CMP-402	CMP-401	CMP-400	CMP-3kR	CMP-200F	CMP-200	
	For general use	For general use	For general use	Recording currents	For general use	Leakage current	
Measurement functions							
	1000 V / 1000 V	600 V / 600 V	600 V / 600 V	-	1000 V / 1000 V	- / -	AC/DC voltage
	400.0 A / -	400.0 A / 400.0 A	400.0 A / -	3000 A / -	200.0 A / -	200 A / -	AC/DC current
	40.00 MΩ	40.00 MΩ	40.00 MΩ	-	60.00 MΩ	-	Resistance
	current: 999.9 Hz voltage: 99.99 kHz	10 kHz	10 kHz	100.0 Hz	-	-	Frequency
	99.99 mF	100.0 μF	-	-	4000 μF	-	Capacitance
	1000°C	760°C	760°C	-	-	-	Temperature
	✓	✓	✓	-	✓	-	Non-contact voltage indication
	✓	✓	✓	-	-	-	Duty cycle (%)
	✓ / ✓	✓ / ✓	✓ / ✓	-	✓ / ✓	-	Continuity / diode test
	✓	-	-	-	-	-	Current and voltage measurements downstream the inverter, frequency converter or in the VFD system
	-	-	-	-	-	-	High voltage DC measurement (HVDC)
	✓	-	-	✓	-	-	Inrush current
	-	-	-	-	✓	-	Low Z
Basic features							
	✓	-	-	✓	✓	-	True RMS measurement
	✓ / ✓	✓ / ✓	✓ / ✓	✓ / ✓	✓ / ✓	- / ✓	Automatic / manual range selection
	30 mm	30 mm	30 mm	flexible clamp: 160 mm	16 mm	30 mm	Maximum diameter of measured conductor
	10 MΩ	10 MΩ	10 MΩ	-	10 MΩ	-	Input impedance
Advanced features							
	- / - / -	- / - / -	- / - / -	- / - / -	✓ / ✓ / -	✓ / - / -	MAX / MIN / AVG measurement
	✓	✓	✓	✓	✓	✓	HOLD
	-	-	-	-	-	-	PEAK HOLD
	✓ / ✓	-	-	-	-	-	PEAK MIN / PEAK MIN
	-	-	-	-	-	-	AC+DC
	✓	✓	✓	-	-	-	Relative measurement
	-	-	-	✓	-	-	Recorder
	-	-	-	✓	-	-	Memory
	-	-	-	✓	-	-	Bluetooth
	-	-	-	✓	-	-	Sonel Multimeter Mobile
Other features							
	✓	✓	✓	✓	✓	✓	Automatic power down
	✓	✓	✓	✓	✓	✓	Battery indicator
	✓	✓	✓	-	✓	-	Beeper
	220 x 80 x 39 mm	197 x 70 x 40 mm	197 x 70 x 40 mm	150 x 65 x 35 mm	230 x 44 x 66 mm	182 x 61 x 34 mm	Dimensions
	266 g	183 g	183 g	240 g	270 g	225 g	Weight
Display							
	-	-	-	-	-	-	Graphical
	✓	✓	✓	✓	✓	✓	Segmented
	4000	4000, 3 3/4 digits	4000, 3 3/4 digits	3000, 3 digits	6000, 3 4/5 digits	1999, 3 1/2 digits	Counting
	✓	✓	✓	✓	✓	✓	Screen backlight
Safety and conditions of use							
	CAT III 600 V CAT II 1000 V	CAT IV 300 V CAT III 600 V	CAT IV 300 V CAT III 600 V	CAT IV 600 V CAT III 1000 V	CAT IV 600 V CAT III 1000 V	CAT II 600 V	Measurement category (EN 61010)
	IP30	IP40	IP40	IP40	IP40	IP40	Ingress protection
	5...40°C	5...40°C	5...40°C	5...40°C	5...40°C	0...50°C	Operating temperature

Clamp meter

SONEL CMP-3000

index: WMGBCMP3000



- INRUSH CURRENT**
- CAT IV 600 V**
- CAT III 1000 V**
- IP40**
- FLEXIBLE CLAMP**
- BUILT IN FLASHLIGHT**
- BLUETOOTH**

Standard accessories:

Flexible clamp F-16	WACEGF16
Set of test leads (CAT IV, M)	WAPRZCMM2
Type K temperature probe adapter	WAADATEMK
Temperature measurement probe (type K)	WASONTEMK
9 V battery	
Carrying case	
Factory calibration certificate	

Product features

- » True RMS AC voltage and current measurement for accurate and reliable readings of non-sinusoidal signals
- » **INRUSH** function for measuring current drawn by an electrical device when first turned on
- » **flexible clamp** allow the measurement of conductors up to **160 mm** in diameter
- » **large clamp** allows the measurement of conductors up to **48 mm** in diameter
- » current measurement up to **1000 A DC** and **3000 A AC**
- » temperature measurement in **Fahrenheit and Celsius**
- » non-contact voltage indication
- » automatic selection of measuring ranges
- » **HOLD** function, allowing for freezing the result on the display
- » holding of **MAX/MIN** results
- » automatic power down - **Auto-OFF** function

Direct current measurement

Display range	Resolution	Accuracy
0.0...1000.0 A	0.1 A	±(2.5% m.v. + 5 digits)

Alternating current measurement (True RMS)

Display range	Resolution	Accuracy
0.0...1000.0 A	0.1 A	±(2.8% m.v. + 8 digits) for 50...400 Hz
0.0...3000.0 A*		

*measurement with the use of flexible clamp

Direct voltage measurement

Display range	Resolution	Accuracy
0.000...500.00 mV	0.01 mV	±(0.1% m.v. + 4 digits)
0.5001...5.0000 V	0.0001 V	
5.001...50.000 V	0.001 V	
50.01...500.00 V	0.01 V	
500.1...1000.0 V	0.1 V	±(0.2% m.v. + 5 digits)

MULTIMETER MOBILE

Sonel Multimeter Mobile application is intended for reading measurement values in live mode, as well as for transferring and storing measurement results in the memory of mobile devices based on the Android system. It can be downloaded from **Google Play**.

Alternating voltage measurement (True RMS)

Display range	Resolution	Accuracy
0.000...500.00 mV	0.01 mV	±(0.1% m.v. + 9 digits)
0.5001...5.0000 V	0.0001 V	
5.001...50.000 V	0.001 V	
50.01...500.00 V	0.01 V	
500.1...1000.0 V	0.1 V	

Resistance measurement

Display range	Resolution	Accuracy
0.0...400.00 Ω	0.01 Ω	±(1.0% m.v. + 9 digits)
0.4001...4.0000 kΩ	0.0001 kΩ	±(1.0% m.v. + 4 digits)
4.001...40.000 kΩ	0.001 kΩ	
40.01...400.00 kΩ	0.01 kΩ	±(2.0% m.v. + 9 digits)
0.4001...4.0000 MΩ	0.0001 MΩ	
4.001...40.000 MΩ	0.001 MΩ	

Capacitance measurement

Display range	Resolution	Accuracy
0.0...500.00 nF	0.01 nF	±(3.5% m.v. + 40 digits)
0.5001...5.0000 μF	0.0001 μF	±(3.5% m.v. + 9 digits)
5.001...50.000 μF	0.001 μF	
50.01...500.00 μF	0.01 μF	±(5.0% m.v. + 9 digits)
0.5001...5.0000 mF	0.0001 mF	

Frequency measurement

Display range	Resolution	Accuracy
10...50.000 Hz	0.001 Hz	±(0.3% m.v. + 2 digits)
50.01...500.00 Hz	0.01 Hz	
0.5001...5.0000 kHz	0.0001 kHz	
5.001...50.000 kHz	0.001 kHz	
50.01...500.00 kHz	0.01 kHz	
0.5001...5.0000 MHz	0.0001 MHz	
5.001...50.000 MHz	0.001 MHz	

Duty cycle measurement

Display range	Resolution	Accuracy
5...95%	0.1%	±(1.0% m.v. + 2 digits)

» frequency range: 10 Hz...10 kHz.

Temperature measurement

Display range	Resolution	Accuracy
-100.0...+1000.0°C	1°C or 1°F	±(1.0% m.v. + 2°C)
-148...+1832°F	1°C or 1°F	±(1.0% m.v. + 3.6°F)

"m.v." = "measured value"

Other technical specifications:

- » display segment LCD, readout of 50000 readings, 4 4/5 digits, backlit
- » power supply 9 V battery, type 6LR61
- » indication of range overflow 'OL' symbol is displayed
- » maximal wire diameter 160 mm
- » maximal busbar diameter 500 mm
- » continuity test threshold 50 Ω
- » diode test I = 0.3 mA, U₀ = 2.8 V DC
- » sampling rate nominal: 2 Hz
- » input impedance approx. 10 MΩ
- » auto-off timeout 30 min
- » operating temperature 5...40°C
- » storage temperature -20...+60°C
- » storage humidity <80%
- » dimensions 230 x 76 x 40 mm
- » flexible clamp dimensions 140 x 180 mm
- » weight 501 g
- » measurement category CAT III 1000 V (CAT IV 600 V)
- » compliance with standards EN 61010-1, EN 61010-2-032
- » quality standard ISO 9001

Clamp meter

SONEL CMP-2000

index: WMGBCMP2000



Standard accessories:

Set of test leads for CMM/CMP	WAPRZCMP1
Temperature measurement probe (type K)	WASONTEMK
9 V battery	
Carrying case	
Factory calibration certificate	

Product features

- » True RMS AC voltage and current measurement for accurate and reliable readings of non-sinusoidal signals
- » INRUSH function for measuring current drawn by an electrical device when first turned on
- » large clamps allow the measurement of conductors up to 57 mm in diameter
- » current measurement up to 2000 A DC and 1500 A AC
- » temperature measurement in Fahrenheit and Celsius
- » automatic selection of measuring ranges
- » HOLD function, allowing for freezing the result on the display
- » holding of MAX/MIN results
- » Delta ZERO function, relative measurement mode for direct current - capability of zeroing the instrument at any time and returning to measurement in absolute mode
- » double LCD to display more than one value at the same time
- » automatic power down - Auto-OFF function

Direct current measurement

Display range	Resolution	Accuracy (AC)
0.0...659.9 A	0.1 A	±(2.0% m.v. + 5 digits)
660...2000 A	1 A	(3.0% m.v. + 5 digits) for 660...1000 A ±(5.0% m.v. + 5 digits) for 1000...2000 A

Alternating current measurement (True RMS)

Display range	Resolution	Accuracy
0.0...659.9 A	0.1 A	±(2.0% m.v. + 10 digits) for 50...60 Hz ±(3.0% m.v. + 10 digits) for 61...400 Hz
660...1500 A	1 A	±(2.5% m.v. + 10 digits) for 50...60 Hz and 660...1000 A ±(3.5% m.v. + 10 digits) for 61...400 Hz and 660...1000 A ±(5.0% m.v. + 10 digits) for 50...400 Hz and 1000...1500 A

Direct voltage measurement

Display range	Resolution	Accuracy
0.000...6.599 V	0.001 V	±(0.5% m.v. + 2 digits)
6.60...65.99 V	0.01 V	
66.0...659.9 V	0.1 V	
660...1000 V	1 V	

Alternating voltage measurement (True RMS)

Display range	Resolution	Accuracy
0.000...6.599 V	0.001 V	±(1.5% m.v. + 8 digits) for 50...500 Hz
6.60...65.99 V	0.01 V	
66.0...659.9 V	0.1 V	
660...750 V	1 V	

Resistance measurement

Display range	Resolution	Accuracy
0.0...659.9 Ω	0.1 Ω	±(1.0% m.v. + 5 digits)
0.660...6.599 kΩ	0.001 kΩ	
6.60...65.99 kΩ	0.01 kΩ	
66.0...659.9 kΩ	0.1 kΩ	
0.660...6.599 MΩ	0.001 MΩ	±(2.0% m.v. + 5 digits)
6.60...66.00 MΩ	0.01 MΩ	±(3.5% m.v. + 5 digits)

Capacitance measurement

Display range	Resolution	Accuracy
0.0...6.599 nF	0.001 nF	±(3.0% m.v. + 30 digits)
6.60...65.99 nF	0.01 nF	±(3.0% m.v. + 10 digits)
66.0...659.9 nF	0.1 nF	±(3.0% m.v. + 30 digits)
6.660...6.599 μF	0.001 μF	±(3.0% m.v. + 10 digits)
6.60...65.99 μF	0.01 μF	
66.0...659.9 μF	0.1 μF	
0.660...6.599 mF	0.001 mF	
		±(5% m.v. + 10 digits)

Frequency measurement

Display range	Resolution	Accuracy
10.00...65.99 Hz	0.01 Hz	±(0.1% m.v. + 5 digits)
66.0...659.9 Hz	0.1 Hz	
0.660...6.599 kHz	0.001 kHz	
6.60...65.99 kHz	0.01 kHz	
66.0...659.9 kHz	0.1 kHz	
0.660...1.000 MHz	0.001 MHz	

Duty cycle measurement

Display range	Resolution	Accuracy
5...95%	0.1%	±(3.0% m.v. + 30 digits)

- » frequency range: 40 Hz...20 kHz.

Temperature measurement

Display range	Resolution	Accuracy
0...400°C	1°C	±(1.0% m.v. + 2°C)
-20...0°C, 400...1000°C	1°C	±(2.0% m.v. + 3°C)
32...750°F	1°F	±(1.0% m.v. + 4°F)
-4...32°F, 750...1832°F	1°F	±(2.0% m.v. + 6°F)

"m.v." = "measured value"

Other technical specifications:

- » display segment LCD, readout of 6600 readings, 3 4/5 digits, backlit
- » power supply 9 V battery, type 6LR61
- » indication of range overflow 'OL' symbol is displayed
- » maximal wire diameter 57 mm
- » maximal busbar dimensions 70 x 18 mm
- » continuity test threshold 30 Ω
- » diode test I = 0.8 mA, U₀ = 3.2 V DC
- » sampling rate nominal: 2.8 Hz
analog bar graph: 28 Hz
- » input impedance approx. 10 MΩ
- » auto-off timeout 30 minutes
- » operating temperature range 0...+50°C
- » storage temperature -20...+60°C
- » storage humidity <80%
- » dimensions 281 x 108 x 53 mm
- » weight with battery 570 g
- » compliance with standards EN 61010-1, EN 61010-2-032
- » quality standard ISO 9001

Clamp meter

SONEL CMP-1015-PV

index: WMGBCMP1015PV

- HVDC
- RECORDER
- INRUSH CURRENT
- CAT IV
600 V
- CAT III
1000 V
- IP40
- BUILT-IN FLASHLIGHT
- BLUETOOTH



Standard accessories:

Set of test leads (CAT IV, M)	WAPRZCMM2
Type K temperature probe adapter	WAADATEMK
Temperature measurement probe (type K)	WASONTEMK
Li-Pol battery 7.4 V 1200 mAh	WAAKU30
Battery charger	WAZASZ25
Battery charger power supply	WAZASZ26
M-3 carrying case	WAWALM3
Factory calibration certificate	

Product features

- » current and voltage measurements downstream the inverter, frequency converter or in the VFD system
- » high voltage DC measurement (HVDC)
- » INRUSH function for measuring current drawn by an electrical device when first turned on
- » elimination of interference and induced voltages - Low Z
- » recorder, possibility of continuous recording
- » large clamp allows the measurement of conductors up to 48 mm in diameter
- » current measurement up to 1000 A AC/DC
- » temperature measurement in Fahrenheit and Celsius
- » non-contact voltage indication
- » automatic selection of measuring ranges
- » HOLD function, allowing for freezing the result on the display
- » built-in Bluetooth module for sending data to mobile devices with Android system
- » holding of MAX/MIN results
- » automatic power down - Auto-OFF function

Direct current measurement

Display range	Resolution	Accuracy
60.00 A	0.01 A	±(2.0% m.v. + 8 digits)
600.0 A	0.1 A	
1000 A	1 A	

Alternating current measurement (True RMS)

Display range	Resolution	Accuracy
60.00 A	0.01 A	±(2.5% m.v. + 5 digits)
600.0 A	0.1 A	
1000 A	1 A	

Direct voltage measurement

Display range	Resolution	Accuracy
600.0 mV	0.1 mV	±(0.8% m.v. + 8 digits)
6.000 V	0.001 V	
60.00 V	0.01 V	±(0.5% m.v. + 5 digits)
600.0 V	0.1 V	
1500 V	1 V	±(0.8% m.v. + 5 digits)



SONEL MULTIMETER MOBILE

Sonel Multimeter Mobile application is intended for reading measurement values in live mode, as well as for transferring and storing measurement results in the memory of mobile devices based on the Android system. It can be downloaded from **Google Play**.

Alternating voltage measurement (True RMS)

Display range	Resolution	Accuracy
0.000...6.000 V	0.001 V	f = 50...60 Hz ±(1.2% m.v. + 5 digits)
6.01...60.00 V	0.01 V	f = 61...1000 Hz ±(2.5% m.v. + 5 digits)
60.1...600.0 V	0.1 V	
601...1000 V	1 V	

Resistance measurement

Display range	Resolution	Accuracy
0.0...600.0 Ω	0.1 Ω	±(1.0% m.v. + 10 digits)
0.601...6.000 kΩ	0.001 kΩ	
6.01...60.00 kΩ	0.01 kΩ	±(0.8% m.v. + 5 digits)
60.1...600.0 kΩ	0.1 kΩ	
0.601...6.000 MΩ	0.001 MΩ	±(2.5% m.v. + 10 digits)
6.01...60.00 MΩ	0.01 MΩ	

Capacitance measurement

Display range	Resolution	Accuracy
0.00...60.00 nF	0.01 nF	±(3.0% m.v. + 20 digits)
60.1...600.0 nF	0.1 nF	
0.601...6.000 μF	0.001 μF	±(3.0% m.v. + 8 digits)
6.01...60.00 μF	0.01 μF	
60.1...600.0 μF	0.1 μF	±(3.5% m.v. + 20 digits)
601...6000 μF	1 μF	
6.01...60.00 mF	0.01 mF	unspecified
60.1...100.0 mF	0.1 mF	

Frequency measurement

Display range	Resolution	Accuracy
0.00...60.00 Hz	0.01 Hz	±(0.2% m.v. + 5 digits)
60.1...600.0 Hz	0.1 Hz	
0.601...6.000 kHz	0.001 kHz	
6.01...60.00 kHz	0.01 kHz	
60.1...600.0 kHz	0.1 kHz	
0.601...6.000 MHz	0.001 MHz	
6.01...10.00 MHz	0.01 MHz	

Duty cycle measurement

Display range	Resolution	Accuracy
10...90%	0.1%	±(1.2% m.v. + 8 digits)

- » frequency range: 40 Hz...10 kHz.

Temperature measurement

Display range	Resolution	Accuracy
-40.0...+1000°C	1°C or 1°F	±(1.5% m.v. + 3°C)
-40.0...+1832°F	1°C or 1°F	

"m.v." = "measured value"

Other technical specifications:

- » display graphical LCD, backlight
- » power supply Li-Pol 7.4 V 1200 mAh rechargeable battery
- » indication of range overflow "OL" symbol
- » maximal wire diameter 48 mm
- » continuity test threshold 50 Ω
- » diode test I = 1.5 mA, U₀ < 3.3 V DC
- » sampling rate nominal: 3 Hz
- » input impedance 9 MΩ (V AC), 10 MΩ (V DC)
- » recorder memory
 - capacity 100 000 samples
 - sampling frequency from 1 Hz
- » auto-off timeout 15...60 min
- » operating temperature 5...40°C
- » storage temperature -20...+60°C
- » storage humidity <80%
- » dimensions 230 x 76 x 40 mm
- » weight 490 g with battery
- » measurement category CAT III 1000 V (CAT IV 600 V)
- » compliance with standards EN 61010-1, EN 61010-2-032
- » quality standard ISO 9001

Clamp meter

SONEL CMP-1010

index: WMGBCMP1010



Standard accessories:

Set of test leads (CAT IV, M)	WAPRZCMP2
Type K temperature probe adapter	WAADATEMK
Temperature measurement probe (type K)	WASONTEMK
3x AA 1.5 V battery	
Carrying case	
Factory calibration certificate	

Product features

- » current and voltage measurements downstream the inverter, frequency converter or in the VFD system
- » INRUSH function for measuring current drawn by an electrical device when first turned on
- » elimination of interference and induced voltages - LoZ
- » clamp allows the measurement of conductors up to 35 mm in diameter
- » current measurement up to 1000 A AC/DC
- » temperature measurement in Fahrenheit and Celsius
- » non-contact voltage indication
- » automatic selection of measuring ranges
- » HOLD function, allowing for freezing the result on the display
- » display of Peak MAX/Peak MIN extreme values
- » automatic power down - Auto-OFF function
- » shock resistant rugged case

Direct and alternating (True RMS) current measurement

Display range	Resolution	Accuracy (DC)	Accuracy (AC)
600.0 A	0.1 A	±(2.5% m.v. + 5 digits)	±(2.5% m.v. + 8 digits)
1000 A	1 A	±(2.8% m.v. + 5 digits)	±(2.8% m.v. + 8 digits)

Direct voltage measurement

Display range	Resolution	Accuracy
600.0 mV	0.1 mV	±(0.5% m.v. + 5 digits)
6.000 V	0.001 V	±(1.5% m.v. + 2 digits)
60.00 V	0.01 V	
600.0 V	0.1 V	
1000 V	1 V	

Alternating (True RMS) voltage measurement

Display range	Resolution	Accuracy
6.000 V	0.001 V	±(1.5% m.v. + 5 digits)
60.00 V	0.01 V	
600.0 V	0.1 V	
1000 V	1 V	

LoZ measurement

Display range	Resolution	Accuracy
6.000 V	0.001 V	±(3.0% m.v. + 40 digits)
60.00 V	0.01 V	
300.0 V	0.1 V	

Resistance measurement

Display range	Resolution	Accuracy
600.0 Ω	0.1 Ω	±(1.0% m.v. + 4 digits)
6.000 kΩ	0.001 kΩ	±(1.5% m.v. + 2 digits)
60.00 kΩ	0.01 kΩ	
6.000 MΩ	0.001 MΩ	±(2.5% m.v. + 3 digits)
60.00 MΩ	0.01 MΩ	±(3.5% m.v. + 5 digits)

Capacitance measurement

Display range	Resolution	Accuracy
60.00 nF	0.01 nF	±(4.0% m.v. + 20 digits)
600.0 nF	0.1 nF	±(3.0% m.v. + 5 digits)
6.000 μF	0.001 μF	
60.00 μF	0.01 μF	±(5.0% m.v. + 5 digits)
600.0 μF	0.1 μF	
6.000 mF	0.001 mF	±(5.0% m.v. + 8 digits)
60.00 mF	0.01 mF	±(5.0% m.v. + 15 digits)
100.0 mF	0.1 mF	

Frequency measurement

Display range	Resolution	Accuracy
9.999 Hz	0.001 Hz	±(1.2% m.v. + 5 digits)
99.99 Hz	0.01 Hz	
999.9 Hz	0.1 Hz	
9.999 kHz	0.001 kHz	
99.99 kHz	0.01 kHz	

Duty cycle measurement

Display range	Resolution	Accuracy
10.0...90.0%	0.1%	±(1.2% m.v. + 2 digits)

- » frequency range: 40 Hz...10 kHz.

Temperature measurement

Display range	Resolution	Accuracy
-20.0...+1000°C	0.1 or 1°C	±(3% m.v. + 5°C)
-4.0...+1832°F	0.1 or 1°F	±(3% m.v. + 9°F)

"m.v." = "measured value"

Other technical specifications:

- » display segment LCD, readout of 6000 readings, backlight
- » power supply of the meter 3x 1.5 V battery, type LR6
- » indication of range overflow 'OL' symbol
- » maximal wire diameter 35 mm
- » continuity test threshold 50 Ω; measurement current < 0.5 mA
- » diode test I = 0.3 mA, U₀ < 3.2 V DC
- » sampling rate 2 Hz
- » input impedance 10 MΩ (V DC and V AC)
- » auto-off timeout 30 min
- » operating temperature +5...+40°C
- » storage temperature -20...+60°C
- » storage humidity <80%
- » dimensions 250 x 90 x 40 mm
- » weight 329 g
- » measuring category CAT IV 600 V (CAT III 1000 V)
- » compliance with standards EN 61010-1, EN 61010-2-032
- » quality standard ISO 9001

Clamp meter

SONEL CMP-1006

index: WMGBCMP1006



INRUSH CURRENT

CAT IV
300 V

CAT III
600 V

IP40

Standard accessories:

Set of test leads for CMM/CMP	WAPRZCMP1
Temperature measurement probe (type K)	WASONTEMK
9 V battery	
Carrying case	
Factory calibration certificate	

Product features

- » True RMS AC voltage and current measurement for accurate and reliable readings of non-sinusoidal signals
- » INRUSH function for measuring current drawn by an electrical device when first turned on
- » clamps allow the measurement of conductors up to 34 mm in diameter
- » current measurement up to 1000 A AC/DC
- » temperature measurement in Fahrenheit and Celsius
- » automatic selection of measuring ranges
- » HOLD function, allowing for freezing the result on the display
- » holding of MAX/MIN values
- » relative measurement mode for direct current - DCA ZERO function
- » automatic power down
- » shock resistant rugged case

Direct and alternating (True RMS) current measurement

Display range	Resolution	Accuracy (DC)	Accuracy (AC)
0...659.9 A	0.1 A	±(2.5% m.v. + 5 digits)	±(2.5% m.v. + 8 digits) for f = 45...65 Hz
660...1000 A	1 A	±(2.8% m.v. + 8 digits)	±(2.8% m.v. + 8 digits) for f = 45...65 Hz

Direct and alternating (True RMS) voltage measurement

Display range	Resolution	Accuracy (DC)	Accuracy (AC)
0...6.599 V	0.001 V	±(1.5% m.v. + 3 digits)	±(1.8% m.v. + 5 digits) for f = 45...65 Hz
6.60...65.99 V	0.01 V		
66.0...600.0 V	0.1 V		

Frequency measurement

Display range	Resolution	Accuracy
30.0...659.9 Hz	0.1 Hz	±(1.2% m.v. + 2 digits)
0.660...6.599 kHz	0.001 kHz	
6.60...15.00 kHz	0.01 kHz	

- » sensitivity:
 - 30...5 kHz: 10 V RMS min.
 - 5 kHz...15 kHz: 40 V RMS min. for 20%...80% of duty cycle

Resistance measurement

Display range	Resolution	Accuracy
0.0...659.9 Ω	0.1 Ω	±(1.0% m.v. + 4 digits)
0.660...6.599 kΩ	0.001 kΩ	±(1.5% m.v. + 2 digits)
6.60...65.99 kΩ	0.01 kΩ	
66.0...659.9 kΩ	0.1 kΩ	
0.660...6.599 MΩ	0.001 MΩ	±(2.5% m.v. + 3 digits)
6.6...66.0 MΩ	0.1 MΩ	±(3.5% m.v. + 5 digits)

Temperature measurement

Display range	Resolution	Accuracy
-20...760°C	1°C	±(3% m.v. + 5°C)
-4...1400°F	1°F	±(3% m.v. + 9°F)

"m.v." = "measured value"

Other technical specifications

- » display segment LCD, readout of 6600 readings, 3 4/5 digits, backlight
- » power supply of the meter 9 V battery, type 6LR61
- » indication of range overflow 'OL' symbol
- » maximal wire diameter 34 mm
- » continuity test threshold 40 Ω; measurement current < 0.5 mA
- » diode test I = 0.3 mA, U₀ < 3 V DC
- » sampling rate 2 Hz
- » input impedance 10 MΩ (V DC and V AC)
- » auto-off timeout 25 min
- » operating temperature +5...+40°C
- » storage temperature -20...+60°C
- » storage humidity <80%
- » dimensions 229 x 80 x 49 mm
- » weight 303 g
- » measuring category CAT III 600 V (CAT IV 300 V)
- » compliance with standards EN 61010-1, EN 61010-2-032
- » quality standard ISO 9001



Clamp meters

SONEL CMP-403 / CMP-402

index: WMGBCMP403 / WMGBCMP402



Standard accessories:

Test leads set (CAT IV, S)	WAPRZCMM1
Type K temperature probe adapter	WAADATEMK
Temperature measurement probe (type K)	WASONTEMK
3x AA 1.5 V battery	
Carrying case	
Factory calibration certificate	

Product features

- » Current and voltage measurements downstream the inverter, frequency converter or in the VFD system
- » INRUSH function for measuring current drawn by an electrical device when first turned on
- » clamp allows the measurement of conductors up to 30 mm in diameter
- » current measurement:
 - CMP-403 | up to 400 A AC and DC
 - CMP-402 | up to 400 A AC
- » temperature measurement in Fahrenheit and Celsius
- » non-contact voltage indication
- » automatic selection of measuring ranges
- » relative measurement function
- » display of Peak MAX/Peak MIN extreme values
- » relative measurement function
- » automatic power down - Auto-OFF function
- » shock resistant rugged case

Other technical specifications:

- » display segment LCD, readout of 4000 readings, backlit
- » power supply of the meter 3x 1.5 V battery, type LR6
- » indication of range overflow 'OL' symbol
- » maximal wire diameter 30 mm
- » continuity test threshold 50 Ω, measurement current <1.5 mA
- » diode test I = 1.0 mA, U₀ = 3.0 V DC
- » sampling rate 3 Hz
- » input impedance 10 MΩ
- » auto-off timeout 15 min
- » operating temperature +5...+40°C
- » storage temperature -20...+60°C
- » storage humidity <80%
- » dimensions 220 x 80 x 39 mm
- » weight
 - CMP-402 266 g
 - CMP-403 270 g
- » measuring category CAT III 600 V (CAT II 1000 V)
- » compliance with standards EN 61010-1, EN 61010-2-032
- » quality standard ISO 9001

CMP-403 | Direct current measurement

Display range	Resolution	Accuracy
40.0 A	0.01 A	±(2.0% m.v. + 8 digits)
400.0 A	0.1 A	±(2.5% m.v. + 8 digits)

Alternating current measurement

Display range	Resolution	Accuracy
40.00 A	0.01 A	±(2.0% m.v. + 8 digits)
400.0 A	0.1 A	±(2.5% m.v. + 8 digits)

» frequency range: 50 Hz...60 Hz

Direct voltage measurement

Display range	Resolution	Accuracy
4.000 V	0.001 V	±(1.0% m.v. + 3 digits)
40.00 V	0.01 V	
400.0 V	0.1 V	±(1.2% m.v. + 5 digits)
1000 V	1 V	

Alternating voltage and VFD measurement (True RMS)

Display range	Resolution	Accuracy for f = 50 Hz...60 Hz (all waveforms)	Accuracy for f = 50 Hz...1 kHz (sine waveforms)
4.000 V	0.001 V	±(1.2% m.v. + 5 digits)	±(1.2% m.v. + 5 digits)
40.00 V	0.01 V		
400.0 V	0.1 V		
1000 V	1 V	±(1.5% m.v. + 5 digits)	±(1.5% m.v. + 5 digits)

» frequency range: 50...1000 Hz

Resistance measurement

Display range	Resolution	Accuracy
400.0 Ω	0.1 Ω	±(1.0% m.v. + 4 digits)
4.000 kΩ	0.001 kΩ	
40.00 kΩ	0.01 kΩ	±(1.5% m.v. + 2 digits)
400.0 kΩ	0.1 kΩ	
4.000 MΩ	0.001 MΩ	±(2.0% m.v. + 5 digits)
40.00 MΩ	0.01 MΩ	

Capacitance measurement

Display range	Resolution	Accuracy
9.999 nF	0.001 nF	unspecified
99.99 nF	0.01 nF	±(4.5% m.v. + 20 digits)
999.9 nF	0.1 nF	
9.999 μF	0.001 μF	±(3.0% m.v. + 5 digits)
99.99 μF	0.01 μF	
999.9 μF	0.1 μF	
9.999 mF	0.001 mF	±(5.0% m.v. + 5 digits)
99.99 mF	0.01 mF	

Frequency measurement - current

Display range	Resolution	Accuracy
99.99 Hz	0.01 Hz	±(1.0% m.v. + 5 digits)
999.9 Hz	0.1 Hz	

Frequency measurement - voltage

Display range	Resolution	Accuracy
99.99 Hz	0.01 Hz	±(1.0% m.v. + 5 digits)
999.9 Hz	0.1 Hz	
9.999 kHz	0.001 kHz	
99.99 kHz	0.01 kHz	

Duty cycle measurement

Display range	Resolution	Accuracy
20.0...80.0%	0.1%	±(1.2% m.v. + 10 digits)

» frequency range: 45 Hz...10 kHz.

Temperature measurement

Display range	Resolution	Accuracy
-20.0...+1000°C	0.1 or 1°C	±(3% m.v. + 5°C)
-4.0...+1832°F	0.1 or 1°F	±(3% m.v. + 5°F)

"m.v." = "measured value"

Clamp meters

SONEL CMP-401 / CMP-400

index: WMGBCMP401 / WMGBCMP400



CAT IV

300 V

CAT III

600 V

IP40

Standard accessories:

Set of test leads for CMM/CMP	WAPRZCMP1
Temperature measurement probe (type K)	WASONTEMK
9 V battery	
Carrying case	
Factory calibration certificate	

Product features

- » clamps allow the measurement of conductors up to 30 mm in diameter
- » current measurement:
 - CMP-401 | up to 400 A AC and DC
 - CMP-400 | up to 400 A AC
- » temperature measurement in Fahrenheit and Celsius
- » non-contact voltage indication
- » automatic selection of measuring ranges
- » **HOLD function**, allowing for freezing the result on the display
- » relative measurement function
- » automatic power down - **Auto-OFF** function
- » **shock resistant rugged case**

Other technical specifications:

- » display segment LCD, readout of 4000 readings, 3 3/4 digits, backlight
- » power supply of the meter 9 V battery, type 6LR61
- » indication of range overflow 'OL' symbol is displayed
- » maximal wire diameter 30 mm
- » continuity test threshold 50 Ω, measuring current <0.5 mA
- » diode test I = 0.3 mA, U₀ = 1.5 V DC
- » sampling rate 2 Hz
- » input impedance 10 MΩ
- » auto-off timeout approx. 30 minutes
- » operating temperature range +5...+40°C
- » storage temperature -20...+60°C
- » storage humidity <80%
- » dimensions 197 x 70 x 40 mm
- » weight 183 g
- » measuring category CAT III 600 V (CAT IV 300 V)
- » compliance with standards EN 61010-1, EN 61010-2-032
- » quality standard ISO 9001

Direct and alternating voltage measurement

Display range	Resolution	Accuracy		Accuracy
		CMP-400 (AC)	CMP-401 (AC)	CMP-400, -401 (DC)
400.0 mV	0.1 mV	±(1.5% m.v. + 30 digits)	±(1.5% m.v. + 30 digits)	±(0.8% m.v. + 2 digits)
4.000 V	0.001 V	±(1.8% m.v. + 8 digits)	±(1.5% m.v. + 5 digits)	±(1.5% m.v. + 2 digits)
40.00 V	0.01 V			
400.0 V	0.1 V	±(2.5% m.v. + 8 digits)	±(2% m.v. + 5 digits)	±(2% m.v. + 2 digits)

» frequency range: 50 Hz...400 Hz

Alternating current measurement

Display range	Resolution	Accuracy CMP-400	Accuracy CMP-401
4.000 A	0.001 A	±(2.5% m.v. + 12 digits)	no range
40.00 A	0.01 A	±(2.5% m.v. + 8 digits)	±(2.5% m.v. + 8 digits)
400.0 A	0.1 A	±(2.8% m.v. + 8 digits)	±(2.8% m.v. + 5 digits)

» frequency range: 50 Hz...60 Hz

CMP-401 | Direct current measurement

Display range	Resolution	Accuracy
4.00 A	0.01 A	±(2.5% m.v. + 5 digits)
400.0 A	0.1 A	±(2.8% m.v. + 5 digits)

Resistance measurement

Display range	Resolution	Accuracy
400.0 Ω	0.1 Ω	±(1% m.v. + 4 digits)
4.000 kΩ	0.001 kΩ	±(1.5% m.v. + 2 digits)
40.00 kΩ	0.01 kΩ	
400.0 kΩ	0.1 kΩ	±(2.5% m.v. + 3 digits)
4.000 MΩ	0.001 MΩ	
40.00 MΩ	0.01 MΩ	±(3.5% m.v. + 5 digits)

Temperature measurement

Display range	Resolution	Accuracy
-20.0...760.0°C	0.1°C	±(3% m.v. + 5°C)
-4.0...1400°F	0.1°F	±(3% m.v. + 9°F)

"m.v." = "measured value"



AC digital clamp meter with data logger

SONEL CMP-3kR

index: WMGBCMP3KR

- INRUSH CURRENT**

- RECORDER**

- CAT IV**
600 V
- CAT III**
1000 V
- IP40**
- FLEXIBLE CLAMP**
- BLUETOOTH**



Standard accessories:

Flexible clamp F-16	WACEGF16
2x AA 1,5 V battery	
Carrying case	
Factory calibration certificate	

Product features

- » **True RMS AC current measurement** for accurate and reliable readings of non-sinusoidal signals
- » **INRUSH** function for measuring current drawn by an electrical device when first turned on
- » **recorder** with sampling every 1 s, possibility of continuous recording for 24 hours
- » **real-time clock** that allows adding date and time of measurement to each stored result
- » data export to the **Sonel Multimeter Mobile** application, viewing the recording results in the application, data export to external files for reading on a PC
- » **flexible clamp** allow the measurement of conductors up to **160 mm** in diameter
- » current measurement **up to 3000 A AC**
- » automatic selection of measuring ranges
- » **HOLD** function, allowing for freezing the result on the display
- » auto-off function

Other technical specifications:

- » display segment LCD, readout of 3000, 4 digits, backlight
- » power supply 2x 1.5 V battery, type LR6
- » indication of range overflow 'OL' symbol is displayed
- » maximal wire diameter 160 mm
- » maximal busbar diameter 500 mm
- » sampling rate nominal: 3 Hz
- » recorder memory
 - capacity 86 400 samples
 - sampling frequency 1 Hz
 - maximum recording time 24 h
- » auto-off timeout 15 min
- » operating temperature 5...40°C
- » storage temperature -20...+60°C
- » storage humidity <80%
- » dimensions 150 x 65 x 35 mm
- » flexible clamp dimensions 140 x 180 mm
- » weight 240 g
- » measurement category CAT III 1000 V (CAT IV 600 V)
- » compliance with standards EN 61010-1, EN 61010-2-032
- » quality standard ISO 9001



SONEL MULTIMETER MOBILE

Sonel Multimeter Mobile application is intended for reading measurement values in live mode, as well as for transferring and storing measurement results in the memory of mobile devices based on the Android system. It can be downloaded from Google Play.

Alternating current measurement (True RMS)

Display range	Resolution	Accuracy
0.0...30.00 A	0.01 A	±(3.0% m.v. + 8 digits) for 50...400 Hz
30.1...300.0 A	0.1 A	±(3.0% m.v. + 5 digits) for 50...400 Hz
301...3000 A	1 A	

Frequency measurement

Display range	Resolution	Accuracy
0.0...400.0 Hz	0.1 Hz	±(0.5% m.v. + 5 digits)

"m.v." = "measured value"



Fork clamp meter

SONEL CMP-200F

index: WMGBCMP200F



Product features

- » fork-style clamp
- » AC current and AC voltage measurement
- » DC voltage measurement
- » low-impedance voltage measurement - **Low Z**
- » current measurement up to **200 A AC**
- » automatic selection of measuring ranges
- » **HOLD** function, allowing for freezing the result on the display
- » function **MAX MIN** for displaying extreme values
- » **Auto-OFF** function

Standard accessories:

Set of test leads (CAT IV, M)	WAPRZCMM2
2x 1,5 V battery	
Carrying case	
Factory calibration certificate	

Alternating current measurement (True RMS)

Display range	Resolution	Accuracy
200,0 A	0,1 A	±(3% m.v. + 5 digits)

Alternating and direct voltage measurement

Display range	Resolution	Accuracy AC	Accuracy DC
6,000 V	0,001 V	±(1,2% m.v. + 5 digits)	±(0,9% m.v. + 5 digits)
60,00 V	0,01 V	±(1,2% m.v. + 2 digits)	±(1,0% m.v. + 2 digits)
600,0 V	0,1 V		
1000 V	1 V	±(1,5% m.v. + 2 digits)	±(1,2% m.v. + 2 digits)

- » frequency range: 50...1000 Hz

Low Z measurement

Display range	Resolution	Accuracy
6,000 V	0,001 V	±(3,0% m.v. + 40 digits)
60,00 V	0,01 V	
600,0 V	0,1 V	

- » frequency range: 50 Hz...1000 Hz

Resistance measurement

Display range	Resolution	Accuracy
600,0 Ω	0,1 Ω	±(1,0% m.v. + 4 digits)
6,000 kΩ	0,001 kΩ	
60,00 kΩ	0,01 kΩ	±(1,5% m.v. + 4 digits)
600,0 kΩ	0,1 kΩ	
6,000 MΩ	0,001 MΩ	±(2,5% m.v. + 4 digits)
60,00 MΩ	0,01 MΩ	±(3,5% m.v. + 4 digits)

Capacitance measurement

Display range	Resolution	Accuracy
60,00 nF	0,01 nF	±(3,0% m.v. + 5 digits)
600,0 nF	0,1 nF	
6,000 μF	0,001 μF	
60,00 μF	0,01 μF	±(3,5% m.v. + 10 digits)
600,0 μF	0,1 μF	
4000 μF	1 μF	±(5,0% m.v. + 10 digits)

"m.v." = "measured value"



Leakage current clamp meter

SONEL CMP-200

index: WMGBCMP200



Measurement of alternating current up to 200 A:

- » high resolution (0.1 mA),
- » 3 measuring subranges: 200 mA, 2 A, 200 A.

Additional functions of the meter:

- » segment LCD, readout of 1999 readings, 3 1/2 digits, backlight,
- » maximal wire diameter 30 mm,
- » **HOLD** function, allowing for freezing the measurement result on the display,
- » **MAX** function, freezing of maximum values,
- » automatic power down of instrument when not in use,
- » reinforced, impact resistant enclosure.

Current measurement

Display range	Resolution	Accuracy
199.9 mA	0.1 mA	±(5% m.v. + 8 digits)
1.999 A	0.001 A	±(5% m.v. + 10 digits)
199.9 A	0.1 A	±(2.5% m.v. + 10 digits)

Comparison of multimeters

CMM-60	CMM-40	CMM-30	CMM-11	CMM-10
High-end industrial meter	Industrial area meter	Meter for industry	Compact meter for general purpose	Pocket meter for basic measurements

Measurement functions					
AC/DC voltage	1000.0 V	1000.0 V	1000.0 V	600 V	600 V
AC/DC current	10.000 A	10.000 A	10.00 A	10.00 A	10.00 A
Resistance	50.000 MΩ	40.000 MΩ	60.00 MΩ	40.00 MΩ	40.00 MΩ
Frequency	10.000 MHz	100.00 MHz	10 kHz	100.0 kHz	10.00 MHz
Capacitance	10.00 mF	40.000 mF	6000 μF	4000 μF	100.0 μF
Temperature	1000.0°C	1200.0°C	760°C	-	760°C
dB	✓	-	-	-	-
Duty cycle (%)/ impulse width (ms)	✓/✓	✓/-	✓/-	✓/-	✓/-
Continuity / diode test	✓/✓	✓/✓	✓/✓	✓/✓	✓/✓
4-20 mA% current loop measurement	✓	✓	-	-	-
Low Z	-	-	✓	-	-
Low-pass filter	✓	-	-	-	-
Basic features					
True RMS measurement	✓	✓	✓	✓	-
Automatic / manual range selection	✓/✓	✓/✓	✓/✓	✓/✓	✓/✓
Advanced features					
MAX / MIN / AVG measurement	✓/✓/✓	✓/✓/-	✓/✓/✓	✓/✓/-	-/-/-
HOLD	✓	✓	✓	✓	✓
PEAK HOLD	✓	✓	✓	-	-
Crest factor	✓	-	-	-	-
AC + DC	✓	✓	✓	-	-
Relative measurement	✓	✓	✓	-	✓
Recorder	✓	-	-	-	-
Trend capture function	✓	-	-	-	-
Memory	✓	✓	in mobile app	in mobile app	-
Bluetooth	✓	-	✓	✓	-
Sonei Multimeter Mobile	✓	-	✓	✓	-
Other features					
Clock	✓	-	-	-	-
Easy access to fuses A / mA	-/✓	-/-	✓/✓	✓/✓	✓/✓
Automatic shutdown	✓	✓	✓	✓	✓
Battery indicator	✓	✓	✓	✓	✓
Built-in flashlight	-	-	✓	✓	-
Beeper	✓	✓	✓	✓	✓
Display					
Graphical	✓	-	-	-	-
Segmented	-	✓	✓	✓	✓
Counting	50.000	40.000	6.000	4.000	4.000
Backlit	✓	✓	✓ / auto	✓	✓
Safety and conditions of use					
Measurement category (EN 61010)	CAT IV 600 V CAT III 1000 V	CAT IV 600 V CAT III 1000 V	CAT IV 600 V CAT III 1000 V	CAT III 600 V	CAT II 600 V
Ingress protection	IP67	IP67	IP67	IP65	IP40
Operating temperature	5...40°C	0...40°C	0...40°C	5...40°C	0...50°C

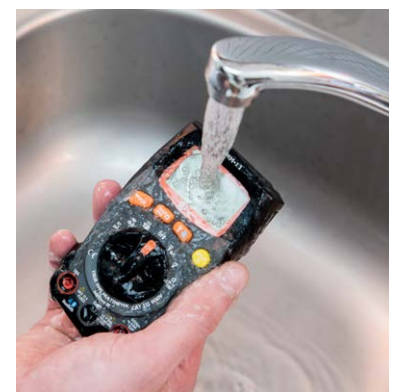
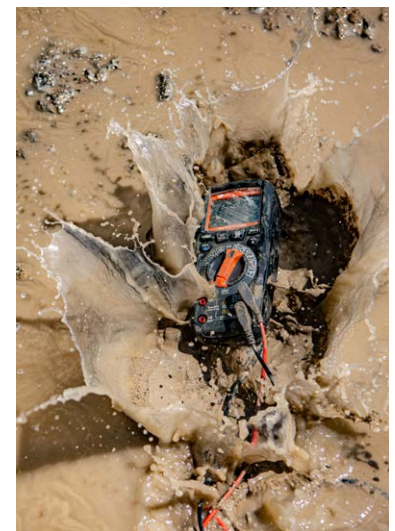

SONEL CMM-60

index: WMGBCMM60

- CAT III
- 1000 V
- CAT IV
- 600 V
- RECORDER
- IP67
- BLUETOOTH



Measurements

- » AC & DC voltage
- » AC & DC current
- » resistance
- » capacitance
- » temperature
- » duty cycle & impulse width
- » frequency
- » current loop 4-20 mA%
- » ...and much more

Additional functions

- » the **AC + DC function** allows you to simultaneously display the value of the constant and variable component or the sum of both components during voltage measurement
- » **True RMS for AC voltage and current** for measuring the effective value of distorted waveforms
- » **4~20 mA** function used for, among others, measurement of the analogue control circuits of temperature, pressure, pH or flow sensors
- » fast and easy reading is provided by a **colour display** with a resolution 320 x 240 pixels and a diagonal of 3.5", enabling reading the result under wide angle and in dark locations
- » built-in **low-pass filter**, thanks to which the voltage measurements will be more accurate by eliminating the influence of interference generated by machines and electronic devices
- » displaying **PEAK** values
- » the relative **REL** measurement
- » **real-time clock** that allows adding date and time of measurement to each stored result
- » **built-in memory for 2000 measurements**
- » possibility of quick detection of irregularities due to the registration of measurement results in graphical form of the trend, thanks to the **Trend Capture function** and the built-in recorder with the possibility of recording up to 10,000 samples
- » built-in **Bluetooth module** for sending live measurement results to **Android mobile devices** and - for PCs - **CMM-60 Multimeter Software**
- » registration of maximum and minimum values and calculation of the average of current measurements
- » integrated **HELP** function
- » manual and automatic range selection
- » freezing the measurement result thanks to **HOLD and Auto HOLD function**
- » auto power-off thanks to **Auto-OFF function** after selecting of a specific idle period
- » extremely hermetic (**IP67**) and reinforced, shock-protected housing **covered with elastomer**

Direct and alternating (True RMS) voltage measurement

Display range	Resolution	Accuracy (DC)	Accuracy (AC)
50.000 mV	0.001 mV	±(0.05% m.v. + 20 digits)	f = 50/60 Hz
500.00 mV	0.01 mV		±(0.3% m.v. + 25 digits)
5.0000 V	0.0001 V	±(0.025% m.v. + 5 digits)	f < 1 kHz
50.000 V	0.001 V		±(0.5% m.v. + 25 digits)
500.00 V	0.01 V	±(0.05% m.v. + 5 digits)	f < 5 kHz
1000.0 V	0.1 V		±(3% m.v. + 25 digits)

- » frequency range 50...10 kHz

Direct and alternating (True RMS) current measurement

Display range	Resolution	Accuracy (DC)	Accuracy (AC)
500.00 μA	0.01 μA	±(0.1% m.v. + 20 digits)	f = 50/60 Hz
5000.0 μA	0.1 μA		±(0.6% m.v. + 25 digits)
50.000 mA	0.001 mA	±(0.15% m.v. + 20 digits)	f < 1 kHz
500.00 mA	0.01 mA		±(1.5% m.v. + 25 digits)
10.000 A	0.001 A	±(0.3% m.v. + 20 digits)	f < 5 kHz
20 A			±(3% m.v. + 25 digits)

maximum 30 seconds with reduced accuracy



SONEL MULTIMETER MOBILE

Sonel Multimeter Mobile application is intended for reading measurement values in live mode, as well as for transferring and storing measurement results in the memory of mobile devices based on the Android system. It can be downloaded from **Google Play**.

Standard accessories:

Test leads set (CAT IV, M)	WAPZCMM2
Temperature probe (type K, metal)	WASONTEMK2
Type K temperature probe adapter	WAADATEMK
Battery charger	WAZASZ21
Charging adapter	WAADALAD1
CMM-RR radio receiver	WAADACMMRR
Li-Pol battery 7.4 V, 2400 mAh	WAAKU25
2x socket protective plug	
Factory calibration certificate	

Resistance measurement

Display range	Resolution	Accuracy
50.000 Ω	0.001 Ω	±(0.5% m.v. + 20 digits)
500.00 Ω	0.01 kΩ	
5.0000 kΩ	0.0001 kΩ	±(0.05% m.v. + 10 digits)
50.000 kΩ	0.001 kΩ	
500.00 kΩ	0.01 kΩ	±(0.1% m.v. + 10 digits)
5.0000 MΩ	0.0001 MΩ	
50.000 MΩ	0.001 MΩ	±(2% m.v. + 20 digits)

Capacitance measurement

Display range	Resolution	Accuracy
5.000 nF	0.001 nF	±(2% m.v. + 40 digits)
50.00 nF	0.01 nF	
500.0 nF	0.1 nF	
5.000 μF	0.001 μF	±(5% m.v. + 40 digits)
50.00 μF	0.01 μF	
500.0 μF	0.1 μF	
10.00 mF	0.01 mF	

Electronic frequency measurement

Display range	Resolution	Accuracy
50.000 Hz	0.001 Hz	±(0.01% m.v. + 10 digits)
500.00 Hz	0.01 Hz	
5.0000 kHz	0.0001 kHz	
50.000 kHz	0.001 kHz	
500.00 kHz	0.01 kHz	
5.0000 MHz	0.0001 MHz	
10.000 MHz	0.001 MHz	

Temperature measurement

Display range	Resolution	Accuracy
-50.0...1000°C	0.1°C	±(1.0% m.v. + 2.5°C)
-58...1832°F	0.1°F	±(1.0% m.v. + 4.5°F)

Other technical specifications

- » display 3.5" colour TFT LCD 320 x 240 pixels
- » power supply Li-Pol 7.2 V 2400 mAh rechargeable battery
- » indication of range overflow "OL" symbol
- » crest factor ≤3 for full 500 V range
decreasing linearly to ≤1.5 at 1000 V
- » continuity test I < 0.35 mA, sound signal for R < 25 Ω
- » diode test I = 0.9 mA, U₀ = 3.2 V DC
- » sampling rate 20 Hz
- » input impedance >10 MΩ (V DC), >9 MΩ (V AC)
- » recorder memory
capacity 10 000 samples
sampling frequency from 1 Hz
- » auto-off timeout 15 min
- » fuses
mA, μA range 0.8 A/1000 V fast-acting ceramic
A range 10 A/1000 V fast-acting ceramic
- » operating temperature range +5...+40°C
- » storage temperature -20...+60°C
- » dimensions 220 x 97 x 58 mm
- » weight 342 g
- » measurement category CAT III 1000 V (CAT IV 600 V)
- » compliance with standards EN 61010-1, EN 61010-2-032

SONEL CMM-40

index: WMGBCMM40

- CAT III**
- 1000 V**
- CAT IV**
- 600 V**
- IP67**



Measurements

- » AC & DC voltage
- » AC & DC current
- » resistance
- » capacitance
- » temperature
- » duty cycle
- » frequency
- » current loop 4-20 mA%
- » diode test and continuity

Additional functions

- » the **AC + DC function** allows you to simultaneously display the value of the constant and variable component or the sum of both components during voltage measurement
- » **True RMS for AC voltage and current** allows to measure the effective value of distorted waveforms
- » the **4~20 mA function** used for, among others, measurement of the control circuits of temperature, pressure, pH or flow sensors
- » displaying **PEAK** values
- » the **relative REL measurement function**
- » dual display to show several results at the same time
- » built-in memory for 2000 measurements
- » registration of maximum and minimum values
- » **automatic and manual range selection**
- » HOLD function
- » auto power-off thanks to **Auto-OFF function** after selecting of a specific idle period
- » extremely hermetic (**IP67**) and reinforced, shock-protected housing covered with elastomer

Direct and alternating (True RMS) voltage measurement

Display range	Resolution	Accuracy (DC)	Accuracy (AC)
400.00 mV	0.01 mV	±(0.06% m.v. + 4 digits)	±(1% m.v. + 40 digits)
4.0000 V	0.0001 V		
40.000 V	0.001 V		
400.00 V	0.01 V	±(0.1% m.v. + 5 digits)	±(1% m.v. + 30 digits)
1000.0 V	0.1 V		

- » frequency range 50...1000 Hz.

Direct and alternating (True RMS) current measurement

Display range	Resolution	Accuracy (DC)	Accuracy (AC)
400.00 μA	0.01 μA	±(1.0% m.v. + 3 digits)	±(1.5% m.v. + 30 digits)
4000.0 μA	0.1 μA		
40.000 mA	0.001 mA		
400.00 mA	0.01 mA		
10.000 A	0.001 A		

20 A maximum 30 seconds with reduced accuracy.

Standard accessories:

Test leads set (CAT IV, M)	WAPRZCMM2
Temperature measurement probe (type K)	WASONTEMK
Type K temperature probe adapter	WAADATEMK
2x socket protective plug	
Carrying case	
9 V battery	
Factory calibration certificate	

Resistance measurement

Display range	Resolution	Accuracy
400.00 Ω	0.01 Ω	±(0.3% m.v. + 9 digits)
4.0000 kΩ	0.0001 kΩ	
40.000 kΩ	0.001 kΩ	±(0.3% m.v. + 4 digits)
400.00 kΩ	0.01 kΩ	
4.0000 MΩ	0.0001 MΩ	±(2.0% m.v. + 10 digits)
40.000 MΩ	0.001 MΩ	

Capacitance measurement

Display range	Resolution	Accuracy
40.000 nF	0.001 nF	±(3.5% m.v. + 40 digits)
400.00 nF	0.01 nF	
4.0000 μF	0.0001 μF	±(3.5% m.v. + 10 digits)
40.000 μF	0.001 μF	
400.00 μF	0.01 μF	±(5.0% m.v. + 10 digits)
4000.0 μF	0.1 μF	
40.000 mF	0.001 mF	

Electronic frequency measurement

Display range	Resolution	Accuracy
40.000 Hz	0.001 Hz	±(0.1% m.v. + 1 digit)
400.00 Hz	0.01 Hz	
4.0000 kHz	0.0001 kHz	
40.000 kHz	0.001 kHz	
400.00 kHz	0.01 kHz	
4.0000 MHz	0.0001 MHz	
40.000 MHz	0.001 MHz	
100.00 MHz	0.01 MHz	

Temperature measurement

Display range	Resolution	Accuracy
-50.0...1200°C	0.1°C	±(1.0% m.v. + 2.5°C)
-58...2192°F	0.1°F	±(1.0% m.v. + 4.5°F)

Other technical specifications:

- » display segment LCD, readout of 40,000 readings, 4 4/5 digits, backlight
- » power supply of the meter 9 V battery, type 6LR61
- » indication of range overflow "OL" symbol
- » crest factor ≤ 3 for full 500 V range
decreasing linearly to ≤ 1.5 at 1000 V
- » continuity test threshold 35 Ω , measuring current <0.35 mA
- » diode test I=0.9 mA, U₀=2.8 V DC
- » sampling rate 2 Hz
- » input impedance >10 MΩ (V DC), >9 MΩ (V AC)
- » auto-off timeout 15 min
- » fuses mA, μA range: 0.5 A / 1000 V fast-acting ceramic
A range: 10 A / 1000 V fast-acting ceramic
- » operating temperature range 0...+40°C
- » storage temperature -20...+60°C
- » dimensions 187 x 81 x 55 mm
- » weight 342 g
- » measurement category CAT III 1000 V (CAT IV 600 V)
- » type of insulation double, as per EN 61010-1, EN 61010-2-032



SONEL CMM-30

index: WMGBCMM30

CAT III

1000 V

CAT IV

600 V

IP67

BLUETOOTH

AUTO BACKLIGHT

BUILT-IN FLASHLIGHT



Measurements

- » AC & DC voltage
- » AC & DC current
- » resistance
- » capacitance
- » duty cycle
- » frequency
- » diode and continuity test
- » Low Z

Additional functions

- » the **AC + DC function** allows you to simultaneously display the value of the constant and variable component or the sum of both components during voltage measurement
- » **True RMS** for AC voltage and current allows to measure the effective value of distorted waveforms
- » function **MAX MIN** for displaying extreme values
- » function **AVG** for displaying average value
- » the relative **REL** measurement
- » automatic and manual range selection
- » **HOLD** function
- » built-in **Bluetooth module** for sending data to mobile devices with Android system
- » **automatic backlight** of the display, buttons and rotary switch
- » built-in **flashlight** for illuminating dark measurement places
- » **Auto-OFF** function
- » hermetic (**IP67**) and reinforced housing resistant to shocks, covered with elastomer

Direct and alternating (True RMS) voltage measurement

Display range	Resolution	Accuracy (DC)	Accuracy (AC)
600.0 mV	0.1 mV	±(0.5% m.v. + 8 digits)	-
6.000 V	0.001 V	±(0.8% m.v. + 5 digits)	±(1.0% m.v. + 5 digits)
60.00 V	0.01 V		
600.0 V	0.1 V	±(1.0% m.v. + 3 digits)	±(1.2% m.v. + 5 digits)
1000 V	1 V		

- » input impedance: 10 MΩ
- » frequency range: 45...1000 Hz

Direct and alternating (True RMS) current measurement

Display range	Resolution	Accuracy (DC)	Accuracy (AC)
600.0 μA	0.1 μA	±(1.0% m.v. + 3 digits)	±(1.0% m.v. + 3 digits)
6000 μA	1 μA		
60.00 mA	0.01 mA	±(1.5% m.v. + 3 digits)	±(2.0% m.v. + 8 digits)
600.0 mA	0.1 mA		
10.00 A	0.01 A		



SONEL MULTIMETER MOBILE

Sonel Multimeter Mobile application is intended for reading measurement values in live mode, as well as for transferring and storing measurement results in the memory of mobile devices based on the Android system. It can be downloaded from **Google Play**.

Standard accessories:

Test leads set (CAT IV, M)	WAPRZCMM2
Type K temperature probe adapter	WAADATEMK
Temperature probe (type K)	WASONTEMK
Carrying case	
4x AAA 1.5 V battery	
Factory calibration certificate	

Resistance measurement

Display range	Resolution	Accuracy
600.0 Ω	0.1 Ω	±(1.5% m.v. + 5 digits)
6.000 kΩ	0.001 kΩ	
60.00 kΩ	0.01 kΩ	
600.0 kΩ	0.1 kΩ	
6.000 MΩ	0.001 MΩ	
60.00 MΩ	0.01 MΩ	±(2.0% m.v. + 10 digits)

Capacitance measurement

Display range	Resolution	Accuracy
60.00 nF	0.01 nF	±(5.0% m.v. + 35 digits)
600.0 nF	0.1 nF	
6.000 μF	0.001 μF	±(3.0% m.v. + 5 digits)
60.00 μF	0.01 μF	
600.0 μF	0.1 μF	
6000 μF	1 μF	±(5.0% m.v. + 5 digits)

Frequency measurement

Display range	Resolution	Accuracy
9.999 Hz	0.001 Hz	±(1.0% m.v. + 5 digits)
99.99 Hz	0.01 Hz	
999.9 Hz	0.1 Hz	
9.999 kHz	0.001 kHz	

Duty cycle measurement

Display range	Resolution	Accuracy
20.0...80.0%	0.1%	±(1.2% m.v. + 2 digits)

Temperature measurement

Display range	Resolution	Accuracy
-20...760°C	0.1°C or 1°C	±(1.0% m.v. + 5°C)
-4...1400°F	0.1°F or 1°F	±(1.0% m.v. + 9°F)

Other technical specifications:

- » display segment LCD, readout of 6000, 4 digits, backlit
- » power supply 4 x AAA 1.5 V battery
or 4x AAA NiMH 1.2 V rechargeable battery
- » indication of range overflow „OL” symbol
- » continuity test threshold 30 Ω, measuring current <0.35 mA
- » diode test I=1 mA, U₀<3 V DC
- » sampling rate 3 Hz
- » input impedance 10 MΩ (V AC/DC)
- » auto-off timeout 15 min
- » fuses mA, μA range: 0,8 A / 1000 V fast-acting
A range: 10 A / 1000 V fast-acting
- » operating temperature range 0...+40°C at humidity <75%
- » storage temperature -20...+60°C at humidity <80%
- » dimensions 170 x 75 x 48 mm
- » weight 418 g
- » measurement category CAT III 1000 V (CAT IV 600 V)
- » compliance with standards EN 61010-1
EN 61010-2-031, EN 61010-2-033
EN 61326-1, EN 61326-2-2

SONEL CMM-11

index: WMGBCMM11

CAT III
600 V

IP65

BUILT-IN FLASHLIGHT

BLUETOOTH



Measurements

- » AC & DC voltage
- » AC & DC current
- » resistance
- » capacitance
- » duty cycle
- » frequency
- » diode and continuity test

Additional functions

- » **True RMS** for AC voltage and current allows to measure the effective value of distorted waveforms
- » function **MAX MIN** for displaying extreme values
- » automatic and manual range selection
- » **HOLD** function
- » built-in **Bluetooth module** for sending data to mobile devices with Android system
- » built-in **flashlight** for illuminating dark measurement places
- » **Auto-OFF** function
- » hermetic (IP65) and reinforced housing resistant to shocks, covered with elastomer

Direct and alternating (True RMS) voltage measurement

Display range	Resolution	Accuracy (DC)	Accuracy (AC)
400.0 mV	0.1 mV	±(1.0% m.v. + 8 digits)	-
4.000 V	0.001 V	±(1.0% m.v. + 3 digits)	±(1.0% m.v. + 5 digits)
40.00 V	0.01 V		
400.0 V	0.1 V	±(1.2% m.v. + 3 digits)	±(1.2% m.v. + 5 digits)
600 V	1 V		

- » input impedance: 10 MΩ
- » frequency range: 50...60 Hz

Direct and alternating (True RMS) current measurement

Display range	Resolution	Accuracy (DC)	Accuracy (AC)
400.0 μA	0.1 μA	±(1.0% m.v. + 3 digits)	±(2.0% m.v. + 5 digits)
4000 μA	1 μA	±(1.5% m.v. + 3 digits)	±(2.5% m.v. + 5 digits)
40.00 mA	0.01 mA		
400.0 mA	0.1 mA	±(2.5% m.v. + 5 digits)	±(3.0% m.v. + 7 digits)
10.00 A	0.01 A		



SONEL MULTIMETER MOBILE

SoneI Multimeter Mobile application is intended for reading measurement values in live mode, as well as for transferring and storing measurement results in the memory of mobile devices based on the Android system. It can be downloaded from **Google Play**.

Standard accessories:

Test leads set (CAT IV, S)	WAPRZCMM1
2x AAA 1.5 V battery	
Factory calibration certificate	

Resistance measurement

Display range	Resolution	Accuracy
400.0 Ω	0.1 Ω	±(1.0% m.v. + 4 digits)
4.000 kΩ	0.001 kΩ	
40.00 kΩ	0.01 kΩ	
400.0 kΩ	0.1 kΩ	±(1.5% m.v. + 5 digits)
4.000 MΩ	0.001 MΩ	
40.00 MΩ	0.01 MΩ	

Capacitance measurement

Display range	Resolution	Accuracy
40.00 nF	0.01 nF	±(5.0% m.v. + 35 digits)
400.0 nF	0.1 nF	
4.000 μF	0.001 μF	±(3.0% m.v. + 5 digits)
40.00 μF	0.01 μF	
400.0 μF	0.1 μF	±(4.0% m.v. + 5 digits)
4000 μF	1 μF	

Electronic frequency measurement

Display range	Resolution	Accuracy
9.999 Hz	0.001 Hz	±(1.0% m.v. + 5 digits)
99.99 Hz	0.01 Hz	
999.9 Hz	0.1 Hz	
9.999 kHz	0.001 kHz	
99.99 kHz	0.01 kHz	

Duty cycle measurement

Display range	Resolution	Accuracy
0.1...99.9%	0.1%	±(1.2% m.v. + 2 digits)

Other technical specifications:

- » display segment LCD, readout of 9999 readings, 4 digits, backlit
- » power supply 2 x AAA 1.5 V battery or 2 x AAA NiMH 1.2 V rechargeable battery
- » indication of range overflow "OL" symbol
- » continuity test threshold 50 Ω, measuring current <0.5 mA
- » diode test I=0.3 mA, U₀<3.3 V DC
- » sampling rate 2 Hz
- » input impedance 10 MΩ (V AC/DC)
- » auto-off timeout 15 min
- » fuses mA, μA range: 0.5 A/600 V fast-acting A range: 10 A/600 V fast-acting
- » operating temperature range +5...+40°C at humidity <80%
- » storage temperature -20...+60°C at humidity <80%
- » dimensions 121 x 67 x 45 mm
- » weight 204 g
- » measurement category CAT III 600 V
- » compliance with standards EN 61010-1 EN 61010-2-031, EN 61010-2-033 EN 61326-1, EN 61326-2-2

SONEL CMM-10

index: WMGBCMM10



CAT II
600 V
IP40

Measurements

- » AC & DC voltage
- » AC & DC current
- » resistance
- » capacitance
- » temperature
- » duty cycle
- » frequency
- » diode and continuity test

Additional functions

- » automatic and manual range selection
- » freezing the measurement result thanks to **HOLD** function
- » **REL** function enabling performance of relative measurement
- » **Auto-OFF** function
- » resistant to impacts strengthened housing, covered with elastomer

Direct and alternating voltage measurement

Display range	Resolution	Accuracy (DC)	Accuracy (AC)
400.0 mV	0.1 mV	±(0.5% m.v. + 2 digits)	±(1.5% m.v. + 70 digits)
4.000 V	0.001 V	±(1.2% m.v. + 2 digits)	±(1.2% m.v. + 3 digits)
40.00 V	0.01 V		
400.0 V	0.1 V	±(1.5% m.v. + 3 digits)	±(1.5% m.v. + 3 digits)
600 V	1 V	±(1.5% m.v. + 2 digits)	±(2.0% m.v. + 4 digits)

- » input impedance: 7.8 MΩ
- » frequency range: 50...400 Hz

Direct and alternating current measurement

Display range	Resolution	Accuracy (DC)	Accuracy (AC)
400.0 μA	0.1 μA	±(1.0% m.v. + 3 digits)	±(1.5% m.v. + 30 digits)
4000 μA	1 μA	±(1.5% m.v. + 3 digits)	±(1.8% m.v. + 5 digits)
40.00 mA	0.01 mA		
400.0 mA	0.1 mA	±(1.5% m.v. + 2 digits)	±(3.0% m.v. + 7 digits)
4.000 A	0.001 A	±(1.5% m.v. + 2 digits)	±(3.0% m.v. + 7 digits)
10.00 A	0.01 A		

Standard accessories:

Set of test leads for CMM/CMP	WAPRZCMP1
Temperature measurement probe (type K)	WASONTEMK
Type K temperature probe adapter	WAADATEMK
9 V battery	
Declaration of verification	

Resistance measurement

Display range	Resolution	Accuracy
400.0 Ω	0.1 Ω	±(1.2% m.v. + 4 digits)
4.000 kΩ	0.001 kΩ	±(1.0% m.v. + 2 digits)
40.00 kΩ	0.01 kΩ	
400.0 kΩ	0.1 kΩ	±(1.2% m.v. + 2 digits)
4.000 MΩ	0.001 MΩ	±(2.0% m.v. + 3 digits)
40.00 MΩ	0.01 MΩ	

Capacitance measurement

Display range	Resolution	Accuracy
40.00 nF	0.01 nF	±(5.0% m.v. + 7 digits)
400.0 nF	0.1 nF	±(3.0% m.v. + 5 digits)
4.000 μF	0.001 μF	
40.00 μF	0.01 μF	±(5.0% m.v. + 5 digits)
100.0 μF	0.1 μF	

Electronic frequency measurement

Display range	Resolution	Accuracy
5.000 Hz	0.001 Hz	±(1.5% m.v. + 5 digits)
50.00 Hz	0.01 Hz	
500.0 Hz	0.1 Hz	±(1.2% m.v. + 3 digits)
5.000 kHz	0.001 kHz	
50.00 kHz	0.01 kHz	±(1.5% m.v. + 4 digits)
500.0 kHz	0.1 kHz	
5.000 MHz	0.001 MHz	±(1.5% m.v. + 4 digits)
10.00 MHz	0.01 MHz	

» sensitivity: minimum effective voltage value 8 V.

Duty cycle measurement

Display range	Resolution	Accuracy
0.1...99.9%	0.1%	±(1.2% m.v. + 2 digits)

Temperature measurement

Display range	Resolution	Accuracy
-20...760°C	1°C	±(3% m.v. + 5°C)
-4...1400°F	1°F	±(3% m.v. + 9°F)

Other technical specifications:

- » display segment LCD, readout of 5000 readings, 3 5/6 digits, backlight
- » power supply of the meter 9 V battery, type 6LR61
- » indication of range overflow "OL" symbol
- » continuity test threshold 50 Ω, measuring current <0.3 mA
- » diode test I=0.3 mA, U₀=1.5 V DC
- » sampling rate 2 Hz
- » input impedance 7.8 MΩ (V AC/DC)
- » auto-off timeout 30 min
- » fuses mA, μA range: 0.5 A/1000 V fast-acting
..... arange: 10 A/1000 V fast-acting
- » operating temperature 0...+50°C at humidity <70%
- » storage temperature -20...+60°C at humidity <80%
- » dimensions 138 x 68 x 37 mm
- » weight 210 g
- » measurement category CAT II 600 V
- » compliance with standards EN 61010-1, EN 61010-2-032



CMM

Set of standard and optional accessories

1, 2, 4 - number of standard accessories
 - - optional accessories

Photo	Name	Index						Photo	Name	Index					
			CMM-60	CMM-40	CMM-30	CMM-11	CMM-10				CMM-60	CMM-40	CMM-30	CMM-11	CMM-10
	AHV-3 voltage adapter	WAADAAHV3		•											
	Test lead with probe for CMM/CMP (set)	WAPRZCMP1	•	•	•	•	1								
	Test lead with probe for CMM/CMP (set)	WAPRZCMP2	•	•	•	•	•								
	Test leads set for CMM (CAT IV, S)	WAPRZCMM1	•	•	•	•	1	•							
	Test leads set for CMM (CAT IV, M)	WAPRZCMM2	1	1	1	•	•								
	Test lead for CMM/CMP (set)	WAPRZCMX1	•	•	•	•	•								
	Test lead 2,0 m black CAT IV 1000 V (banana plugs with 10 A fuse)	WAPRZ002BLBBF10	•	•	•	•	•								
	Test lead 2,0 m blue CAT IV 1000 V (banana plugs with 10 A fuse)	WAPRZ002BUBBF10	•	•	•	•	•								
	Test lead 2,0 m green CAT IV 1000 V (banana plugs with 10 A fuse)	WAPRZ002GRBBF10	•	•	•	•	•								
	Test lead 2,0 m red CAT IV 1000 V (banana plugs with 10 A fuse)	WAPRZ002REBBF10	•	•	•	•	•								
	Test lead 2,0 m yellow CAT IV 1000 V (banana plugs with 10 A fuse)	WAPRZ002YEBBF10	•	•	•	•	•								
	Crocodile clip mini, 1 kV 10 A (set)	WAKROKPL10MINI	•	•	•	•	•								
	Type K temperature probe adapter	WAADATEMK	1	1	1		1								
	Temperature probe (type K)	WASONTEMK	•	1	1		1								
	Temperature probe (type K, metal)	WASONTEMK2	1	•	•		•								
	Temperature probe (type K, bayonet)	WASONTEMP	•	•	•		•								
	M1 hanging hook straps	WAPOZUCH1	•												
	Magnetic hanging strap	WAPOZUCH6	•				•								
	Battery charger	WAZASZ21	1												
	Charging adapter	WAADALAD1	1												
	CMM-RR radio receiver	WAADACMMRR	1												
	Li-Pol battery 7.4 V, 2400 mAh	WAAKU25	1												
	M13 carrying case	WAFUTM13	•	•											
	S1 carrying case	WAFUTS1												•	•

Two-pole voltage testers

SONEL P-6 / P-5 / P-4

index: WMGBP6 / WMGBP5 / WMGBP4

- CAT III**
- 1000 V**
- CAT IV**
- 600 V**
- IP65**



Product description

Sonel P-6, P-5 and P-4 are reliable, particularly durable and safe 2-pole testers, which enable testing voltage, circuit continuity and phase sequence. They have been designed for use in extreme conditions both in industry and commercial applications. Advanced technology, a high level of safety and user-friendliness are the key features of the P-line voltage testers.

Main functions and attributes of the P-line instruments

- » P-6 | phase identification - unique feature in voltage indicators worldwide
- » automatic voltage test up to 1000 V AC/DC
- » optical indication by a LED bar
- » P-6 • P-5 | optical indication by an additional LCD display
- » sound indication when dangerous voltage levels of 50 V AC and 120 V DC are exceeded
- » RCD trip test with switchable load
- » automatic continuity test upon connection to the object
- » 2-pole test of phase rotation direction
- » single-pole indication of 100 V presence
- » P-6 • P-5 | resistance measurement up to 1999 Ω
- » HOLD function for freezing the measurement results
- » robust, two-component housing protecting from mechanical damages and impacts
- » P-6 • P-5 | integrated torch light and backlit display for tests in poorly lit areas
- » IP65 ingress protection guarantees protection against dust and water
- » safety provided by measuring class compliant with CAT IV 600 V and CAT III 1000 V standards

Technical specifications:

- » measurement category acc. to EN 61010-1 III 1000 V / IV 600 V
- » protection class acc. to EN 60529 IP65
- » insulation type acc. to EN 61010-1 double-insulation, class II
- » instrument power supply 2 x LR03 AAA 1.5 V (recommended alkaline cells)
- » operating frequency range 16...400 Hz
- » continuity test: light and sound signal for R ≤ 400 kΩ
- » P-6 • P-5 | range of resistance measurement 1...1999 Ω
- » input impedance approx. 300 kΩ
- » range for single-pole phase indicator 100...1000 V
- » minimum activation voltage ±6 V AC/DC
- » operating / storage temperature -15...+55°C / -20...+70°C
- » auto-off time 10 s / 30 s (HOLD mode)
- » display LCD, 3½ digits, 1999 read-out with function indicators
- » dimensions 275 x 82 x 36 mm
- » weight incl. batteries / excl. batteries 291 g / 267 g
- » electromagnetic compatibility in accordance with standards EN 61326-1, EN 61326-2-2
- » conformance with the requirements of standards EN 61010-1, EN 61243-3

Standard accessories:

Φ4 mm screw tip (set of 4 pcs.)	WAPOZN4MMK
4 mm applied tip (set of 2 pcs.)	WAPOZO4MMK
2x AAA / LR03 alkaline battery	
Declaration of verification	

Optional accessories:

S2 case	WAFUTS2
---------	---------



Residual-current device trip testing

In response to the needs of clients, our new P-line voltage testers allow to check the RCD in a fully controllable way. With buttons on both probes, the user can reduce the internal impedance of the instrument, which makes it possible to trip the RCD. Additionally, pressing both buttons activates an additional loadpoint - a vibration motor. In this way, voltage can be measured in a tested circuit with no impact of stray currents on the result.



Durability and comfort of use

The housing has been designed for use in harsh industrial environments, where the application of personal protection equipment, such as voltage insulation safety gloves, is required. At the same time, the instrument's ergonomic shape allows for one hand use.



Versatility and safety

Voltage testers are provided with a set of test probes. The probes reduce metal exposure to 4 mm length, which eliminates the risk of accidental contact with the wrong conductor when performing measurements on a wire harness. Additional screw-on metal adapters are used for applications where tips with 4 mm diameter are required. It is particularly important for tests in electrical sockets, where the user must be sure that contact between the probe and the conductor is kept. All elements of the set are stored in a special case so the probe tips can be replaced when needed. The case also includes an adapter that is helpful for unlocking the UK-type sockets.

Parameter	P-6	P-5	P-4
measurement category	CAT III 1000 V / IV 600 V		
range of voltage	6.0 ... 1000 V AC/DC		12 ... ≥690 V AC/DC
LED bar	7 segments		
backlit LCD display	✓	✓	-
continuity test	✓	✓	✓
10 mA / 30 mA RCD trip test	✓	✓	✓
built-in torch light	✓	✓	✓
single-pole phase tester	✓	✓	✓
2-pole phase rotation tester	✓	✓	✓
IP65 protection class	✓	✓	✓
resistance test	✓	✓	-
freeze display	✓	✓	-
phase identification	✓	-	-

Distance meter

SONEL LMW-100

index: WMGBLMW100



Description

The LMW-100 is an invaluable measurement assistant for users working in the construction industry, but also for electricians. It will help you to determine:

- » the measurement grid for illuminance measurements,
- » the distance to the probes when measuring earth resistance,
- » the distance to cable damage indicated by the reflectometer.

The 100-meter range facilitates the work in many industry branches. Functions for calculating the area, volume and height, help the user to accelerate the execution of tasks.

Features

Advanced

The rangefinder has a range of up to **100 m**. With the built-in algorithms, the device helps the user by calculating the **area, cubature** and - on the basis of 2 or 3 indirect measurements - **height**.

Handy

A pocket device with a handy shape.

Durable

This compact device is equipped with the latest technologies to operate in challenging conditions. The rubberised housing protects the device against damage.

Measurement functions

- » Single mode measurements
- » Continuous measurements
- » Automatic continuous determination of extreme values
- » Summing up the results
- » Surface measurement
- » Volume measurement
- » Determining the distance with 2 measurements
- » Determining the distance with 3 measurements

Non-contact AC voltage detector

SONEL VT-3

index: WMGBVT3



- » signaling: light and sound
- » voltage range: 12~1000 V AC (50/60 Hz)
- » measurement category: IV 1000 V
- » power supply: 2x 1.5 V (LR03) battery



Non-contact AC voltage detector

SONEL VT-2

index: WMGBVT2



- » signaling: light and sound
- » voltage range: 90~1000 V AC (50/60 Hz)
- » measurement category: III 1000 V
- » power supply: 2x 1.5 V (LR03) battery

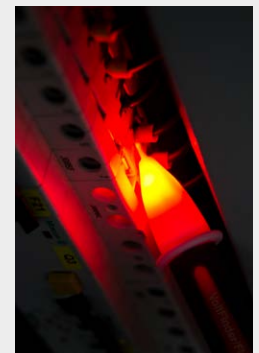

Standard accessories:

Screwdriver	WAPOZSRU1
S6 carrying case	WAFUTS6
2x AAA 1,5 V battery	
Declaration of verification	

Optional accessories:

S1 carrying case	WAFUTS1
------------------	---------



Technical specifications:

» degree of housing protection acc. to EN 60529	IP54
» range	0.05...100 m
» measurement accuracy at a distance of ≤10 m	from ±1.5 mm
» unit of measurement	meters / inches / feet
» memory of measurement results	20 records
» operating temperature	-10...50°C
» storage temperature	-20...60°C
» operating humidity	<95%
» storage humidity	30...50%
» power supply	2x AAA 1.5 V battery
» inactivity time for triggering Auto-Off function	
laser	0.5 min
device	3 min
» weight	100 g
» dimensions	110 x 46 x 28 mm

Phase sequence testers

SONEL TKF-13 / TKF-12 / TKF-12L

index: WMGBTKF13 / WMGBTKF12 / WMGBTKF12L

TKF-13



TKF-12



TKF-12L



Features

- » indication of phase sequence in networks with voltage 35...690 V AC
- » operation in networks with 2...70 Hz frequency
- » voltage indication light
- » wired and wireless indication of motor rotation
- » magnetic field detection

Purpose

The unique TKF-12, TKF-12L and TKF-13 testers are designed to control 3-phase electrical installations in a wide range of phase-to-phase voltages (35... 690 V, frequency up to 70 Hz) in distribution circuits. The indication of the rotating field and the direction of motor shaft rotation is performed, among others, with a non-contact method.

Application

Versality

Measure easily and accurately 16-, 32- and 63-amps industrial sockets with optional AGT-16, AGT-32 and AGT-63 adapters.

Prevention

Standard accessories, included in the kits, allow for quick verification whether the shaft rotates in the correct direction after the motor is connected. Otherwise, the engine or the equipment driven by it may be damaged.

Non-contact check of motor shaft rotation direction

Non-contact verification of motor shaft rotation direction is possible only in the TKF-13, which includes a function dedicated to this type of measurement.

Intuitive, trouble-free connection

Various colored cables, crocodile clips and test probes allow you to connect the device to the tested object - quickly and without any problems.

Sensitive indication

Thanks to the innovative technology in the TKF-12L, we have achieved a record range of nominal phase-to-phase voltages: indication of voltage presence is displayed from 29 V AC.

Parameter	TKF-13 Professional model with motor testing	TKF-12 Basic model for rotation field measurement	TKF-12L Basic model for rotation field measurement
Basic technical data			
nominal phase-to-phase voltage range	120...690 V AC	160...690 V AC	35...690 V AC
maximum phase-to-phase operating voltage		760 V AC	
range of motor electromotive force voltages	1...760 V AC		–
frequency range	2...70 Hz		10...70 Hz
Other data			
work temperature		-10...+45°C	
storage temperature		-20...+60°C	
work humidity		20...80%	
power supply	6LR61 alkaline battery (9 V)	from the tested network up to 15 min for maximum voltage	
battery status LED blinking period	ca. 1 s		–
automatic shutdown time	ca. 5 min		–
dimensions (with holster and without test leads)	130 x 72 x 31 mm		
weight without test leads	ca. 150 g		ca. 200 g
measurement category in accordance with EN 61010 and EN 61557	CAT III 600 V		
insulation type	double in accordance with EN 61010-1		

Standard accessories:

Crocodile clip, black, 1 kV, 20 A	WAKROBL20K01
Test lead 1.2 m, black, 1 kV (banana plugs)	WAPRZ1X2BLBB
Test lead 1.2 m, red, 1 kV (banana plugs)	WAPRZ1X2REBB
Test lead 1.2 m, yellow, 1 kV (banana plugs)	WAPRZ1X2YEBB
Pin probe, black 1 kV (banana socket)	WASONBLOGB1
Pin probe, red 1 kV (banana socket)	WASONREOGB1
Pin probe, yellow 1 kV (banana socket)	WASONYEOGB1
Declaration of verification	

Optional accessories:

AGT-16C three-phase socket adapter 16 A (PEN)	WAADAAGT16C
AGT-16P three-phase socket adapter 16 A	WAADAAGT16P
AGT-32C three-phase socket adapter 32 A (PEN)	WAADAAGT32C
AGT-32P three-phase socket adapter 32 A	WAADAAGT32P
AGT-63P three-phase socket adapter 63 A	WAADAAGT63P
Test lead 2,0 m black CAT IV 1000 V (banana plugs, fused 10 A)	WAPRZ002BLBBF10
Test lead 2,0 m blue CAT IV 1000 V (banana plugs, fused 10 A)	WAPRZ002BUBBF10
Test lead 2,0 m green CAT IV 1000 V (banana plugs, fused 10 A)	WAPRZ002GRBBF10
Test lead 2,0 m red CAT IV 1000 V (banana plugs, fused 10 A)	WAPRZ002REBBF10
Test lead 2,0 m yellow CAT IV 1000 V (banana plugs, fused 10 A)	WAPRZ002YEBBF10
S3 carrying case	WAFUTS3
Crocodile clip, red, 1 kV, 20 A	WAKRORE20K02
Crocodile clip, yellow, 1 kV, 20 A	WAKROYE20K02



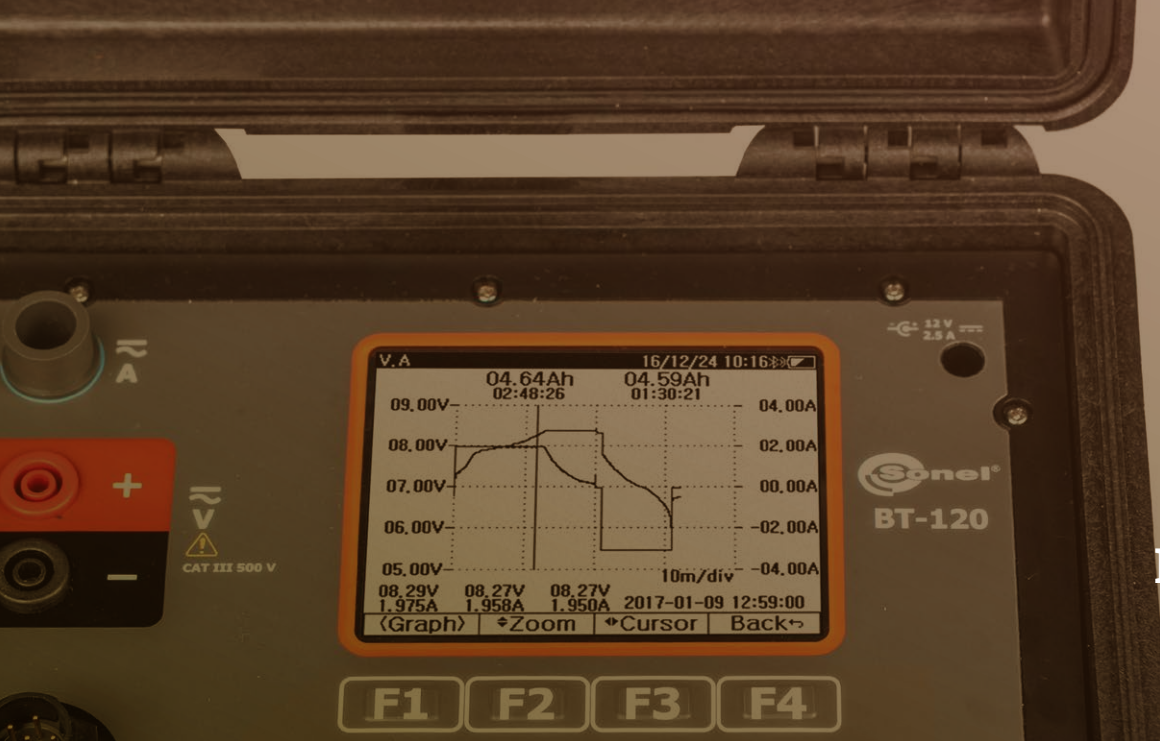

Battery testing
BT-120



Leakage current detection
MPU-1



Demonstration boards
DB-1
DB-THERMO

Battery tester

SONEL BT-120

index: WMGBBT120



Features

The Sonel BT-120 tester is a measurement tool intended for precise testing of many battery parameters, thus ensuring their optimal performance. Designed for both professionals and home users, the BT-120 tester is an irreplaceable support for keeping batteries in excellent condition.

Sonel BT-120 tester is a reliable tool that provides accurate measurements and precise information about the battery condition. With this tool you can:

- » monitor the performance of batteries and avoid unpleasant surprises related to their improper operation,
- » make conscious decisions about continuing to use batteries or replacing them, based on internal impedance measurements,
- » provide reliable power in a wide range of applications, from vehicles to emergency power systems,
- » identify potential problems, such as incorrect charging or cell damage, by measuring the ripple voltage.

Sonel BT-120 tester ensures that your batteries are working at full capacity, providing energy when you need it. Find optimal power solutions for your devices with a tester that provides reliable measurements and precise information.

AC/DC current measurements

The tester can precisely measure AC and DC current up to 500 A. This is crucial to assess the battery's ability to provide energy and identify any problems with current flow.

AC/DC voltage measurements

BT-120 allows you to measure both alternating and direct voltage, up to 400 V. It is important to monitor voltage stability and adjust the battery voltage to the requirements of the powered devices.

Internal impedance measurement

Internal impedance is an indicator of battery health. The tester allows you to measure this value, in order to assess the condition of the battery and make informed decisions regarding its further use.

Ripple voltage measurement

Measurements of ripple voltage up to 5 V allow you to identify potential problems, such as cell damage or incorrect charging. This is crucial to maintaining battery performance.

Versatility in many industries

BT-120 is suitable for many applications, from the automotive and electrical industries to renewable energy and telecommunications. This is a tool for professionals who care about power reliability and efficiency.

Standard accessories:

Set of cables for measuring internal impedance	WAPRZBT120ZS
Set of cables for voltage measurement	WAPRZBT120U
Adapter for data transmission (USB)	WAADABTUSB1
BD-120 measuring clamp	WACE130BE
L-17 carrying case	WAFUTL17
Z-34 power supply	WAZASZ34
Calibration resistor	WAADARK1
Declaration of verification	

Internal resistance

Display range	Resolution	Accuracy
3 mΩ	1 μΩ	±(0.8% m.v. + 10 digits)
30 mΩ	10 μΩ	
300 mΩ	100 μΩ	
3 Ω	1 mΩ	±(0.5% m.v. + 10 digits)
30 Ω	10 mΩ	
300 Ω	100 mΩ	

DC voltage

Display range	Resolution	Accuracy
5 V	0.001 V	±(0.5% m.v. + 5 digits)
50 V	0.01 V	
500 V	0.1 V	

AC voltage

Display range	Resolution	Accuracy
500 V (50/60 Hz)	0.1 V	±(0.75% m.v. + 5 digits)

- » frequency range: 40 Hz...100 Hz

DC current

Display range	Resolution	Accuracy
4 A	0.001 A	±(0.5% m.v. + 5 digits)
40 A	0.01 A	
400 A	0.1 A	

AC current

Display range	Resolution	Accuracy
4 A	0.001 A	±(0.75% m.v. + 10 digits)
40 A	0.01 A	
400 A	0.1 A	

Temperature

Display range	Resolution	Accuracy
-10°C...100°C	0.1°C	±(1% m.v. + 2 digits)

Ripple voltage

Display range	Resolution	Accuracy
0 V...5 V	0.001 V	±(2.5% m.v. + 10 digits)

- » frequency range: 40 Hz...10 kHz

Technical data:

- » insulation type acc. to EN 61010-1 and EN IEC 61557 double
- » measurement category acc. to EN IEC 61010-2-030 CAT III 500 V
- » protection class acc. to EN 60529 IP54
- » power supply
 - mains AC 100 V...240 V, 50 Hz / 60 Hz
 - rechargeable battery Li-Ion >5.4 Ah
- » dimensions 232 x 192 x 111 mm
- » weight 1.4 kg
- » operating temperature 0...+50°C
- » storage temperature -20...+50°C
- » relative humidity 10...85%
- » display graphical LCD
- » altitude a.s.l. <2000 m
- » quality standard development, design and production acc. to ISO 9001
- » the product meets the EMC requirements according to standards ... EN 61326-1
..... EN 61326-2-2

SONEL MPU-1

index: WMGBMPU1



IP67

Features:

MPU-1 is intended for monitoring (measurement) of leakage current in power networks of alternating current, low and medium voltage, and serves for performing measurements whose results determine the safety status of the monitored system from the perspective of flowing leakage current. The instrument enables setting of the safe threshold value of flowing leakage current, above which a visual and sound alarm is activated.

The most important features of the MPU-1 instrument include:

- » continuous monitoring of alternating current flowing through earthing,
- » measurement on one or two clamps simultaneously, in the case of measurement using two clamps, the current value is summed, and this provides the capability of measuring spun poles with independent clamps for each component pole,
- » diode indicator of operating mode,
- » alarm in the event of flow of current higher than the alarm threshold (factory setting 1 A), sound and visual alarm (speaker built into the housing),
- » measurement with flexible Sonel F-series coil (Rogowski coil) with a max. length of 2 m,
- » measurements in low- and medium-voltage networks with frequency of 50 Hz or 60 Hz,
- » automatic selection of measuring range,
- » monitoring of battery level,
- » ergonomic operation.

Measurement of leakage currents flowing through clamp:

Display range	Resolution	Accuracy
0.1...9.9 A	0.1 A	±(5% m.v. + 2 digits)
10...299 A	1 A	

- » frequency range: 50 Hz or 60 Hz
- » flexible current coil – F-1A



Operation in medium-voltage mode - the display reads the value of the set alarm threshold and indicates the battery charge status

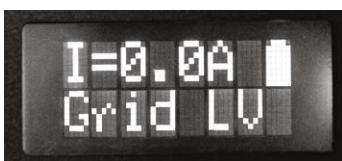

Operation in low-voltage mode - the display reads the value of the measured current flowing through the clamp and indicates the battery charge state

Standard accessories:

Straps for mounting on the pole for PQM (set)	WAPZOPAKPL
Mains cable with IEC C7 plug	WAPRZLAD230
L5 carrying case for MPU-1	WAWALL5
Power supply adaptor Z11	WAZASZ11
Factory calibration certificate	

Optional accessories:

F-1A flexible coil (Ø360 mm)	WACEGF1AOKR
F-2A flexible coil (Ø235 mm)	WACEGF2AOKR
F-3A flexible coil (Ø120 mm)	WACEGF3AOKR
F-4 flexible coil (Ø630 mm)	WACEGF4OKR
Cable for battery charging from car cigarette lighter socket (12 V)	WAPRZLAD12V2



The standard kit includes a transport briefcase for the signaler, standard and additional accessories

Technical data:

- » housing protection rating according to EN 60529 IP67
- » instrument power supply NiMH 9.4 V 2.1 Ah rechargeable battery pack
- » parameters of battery charger power adapter 100...240 V
- 50...60 Hz
- » operating time for standby mode >18 h
- » operating time for alarm mode 3 h
- » alarm threshold setting range 0.5 ... 9.9 A
- » dimensions 125 x 150 x 95 mm
- » weight of instrument with rechargeable batteries approx. 1.1 kg
- » operating temperature range -10...+50°C
- » charger operating temperature range +10...+35°C
- » reference temperature 23 ± 2°C
- » storage temperature -20...+80°C
- » relative humidity 20...90%
- » nominal relative humidity 40...60%
- » elevation above sea level <2000 m
- » quality standard development, design and production in compliance with ISO 9001
- » this product meets EMC requirements in compliance with standards EN 613261 and EN 61326-2-2



Demonstration board

SONEL DB-1

index: WMGBDB1



Features

The DB-1 board makes it possible to demonstrate the method of performing the following tests:

- » fault loop impedance for assessment of the automatic power cutoff condition,
- » RCD parameters,
- » earthing resistance,
- » soil resistivity,
- » continuity test of equipotential bonding,
- » insulation resistance,
- » power network voltage.

It is possible to simulate typical failures and irregularities in the electrical network.

Measurements

Technical specifications of DB-1 board and features of individual functions:

- » Fault loop impedance:
 - measurement of L-N short-circuit with impulse currents up to 25 A and 60 ms,
 - measurement of L-PE earth fault loop with impulse currents up to 20 mA.
- » RCD parameters (30 mA RCD):
 - measurement of RCD trip time,
 - measurement of RCD trip current,
 - earth resistance measurement,
 - touch voltage measurement.
- » Soil resistivity:
 - resistivity measurement for three soil types (31 Ωm, 295 Ωm, 5.9 kΩm).
- » Earthing resistance.

Measurement by:

 - 2-pole method,
 - 3-pole method,
 - 4-wire method,
 - 3-pole method with clamp,
 - two-clamp method,
 - with the use of fault loop meter.
- » Continuity of connections:
 - measurement of equipotential bonding and connections of accessible parts.
- » Insulation resistance:
 - measurement of L-N insulation,
 - measurement of L-PE insulation,
 - measurement of N-PE insulation.
- » Voltage measurement:
 - voltage measurement in power socket.
- » Simulation of irregularities:
 - no continuity of earth conductor (R_E),
 - safe voltage exceeded during RCD measurement (U_B),
 - permissible RCD tripping current (I_a) exceeded,
 - permissible RCD tripping time (t_a) exceeded,
 - insufficient L-N insulation resistance ($R_{iso}(L-N)$),
 - insufficient L-PE insulation resistance ($R_{iso}(L-PE)$),
 - excessive fault loop impedance (Z_L).
- » 230 V network socket.

Standard accessories:

Test lead 0.7 m, black (banana plugs)	WAPRZX7BLBB
Mains cable with IEC C13 plug	WAPRZ1X8BLIEC
4x configuration jumper	WAPOZZW1
Declaration of verification	

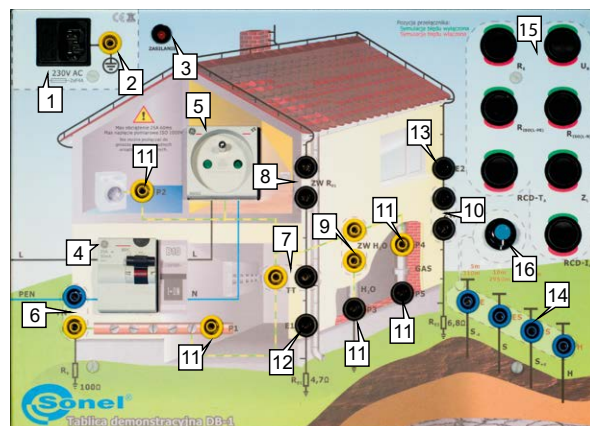

- 1 Power socket 230 V
- 2 Additional PE socket
- 3 230 V power indicator lamp
- 4 Residual current device (RCD)
- 5 Measurement socket
- 6 TN network clamp
- 7 TT network clamp
- 8 Socket of earth electrode R_{E1} (ZW R_{E1})
- 9 Socket of equipotential bonding of H₂O pipe (ZW H₂O)
- 10 Socket of earth electrode R_{E2} (ZW R_{E2})
- 11 Measurement points P1, P2, P3, P4, P5
- 12 Measurement point of earth electrode R_{E1} (E1)
- 13 Measurement point of earth electrode R_{E2} (E2)
- 14 Measuring electrode sockets
- 15 Irregularity selection switches
- 16 Soil type switch for soil resistivity measurements

Basic technical data:

- » RCD type 30 mA type AC
- » power supply from network 230 V
- » power consumption approx. 15 mW
- » protection 2 x T3 14A 250 V
or 2 x F 4 A 250 V

Safety and work conditions:

- » measuring category according to EN 61010 II 300 V
- » ingress protection IP40
- » type of insulation according to EN 61010-1 and IEC 61557 single
- » operating temperature 10...+40°C
- » storage temperature -20...+60°C
- » humidity 20...80%
- » dimensions 405 x 300 x 140 mm
- » weight ca. 3.6 kg

Other information

- » Quality standard – development, design and production ISO 9001



The DB-1 demonstration board makes it possible to simulate various faults and irregularities in an electrical network.

Demonstration board

SONEL DB-THERMO

index: WMGBDBTHERMO



Standard accessories:

Heating panel protective plate	WAPOZSL3
Power supply 24 V DC / 4 A	WAZASZ31

The DB-THERMO board is an indispensable device during any training on contactless temperature measurements and thermal imaging with the use of thermographic cameras. DB-THERMO helps to understand the phenomena related to the emissivity of different materials and the influence of surface type on temperature measurement.

The DB-THERMO set includes instructions describing all topics concerning thermal imaging.

The device is enclosed in a solid briefcase housing with a detachable cover.

DB-THERMO has a heating panel with an emissivity of 0.98 as well as plates made of various typical materials, with matte and polished surfaces. A programmable controller keeps watch over the temperature of the heating panel. The user may select a temperature from within the range of 40...60°C. The LED display reads the current panel temperature.

Emissivity of main plate (110 x 110 mm)

Material	Polished	Matte
Blackened aluminium	-	0.98

Emissivity of materials (70 x 30 mm plates):

Material	Polished	Matte
Copper	0.03	0.20
Aluminium	0.10	0.30
Brass	0.04	0.33
Polycarbonate	0.88	0.91
Glass	0.84	0.90
Stainless steel	0.12	0.39



The DB-THERMO demonstration board has a built-in programmable controller that stands vigil over the temperature of the heating panel.

Basic technical data:

- » plate temperature regulation range 40°C...60°C
- » plate temperature reading accuracy ±2%
- » resolution of temperature readings 0.1°C
- » resolution of temperature settings 1°C
- » hysteresis ±1.5°C
- » temperature stabilization time <5 min
- » heating panel dimensions 275 x 110 mm
- » display LED
- » power supply 24 V DC
- » power consumption max. 100 W
- » thermal protection 85°C

Safety and work conditions:

- » ingress protection IP20
- » type of insulation according to EN 61010-1 CAT II 300 V
- » operating temperature 10...+40°C
- » storage temperature -20...+70°C
- » dimensions 330 x 260 x 140 mm
- » weight of device ca. 0.5 kg

Other information

- » quality standard – development, design and production ISO 9001



SMT AND THT ASSEMBLY

Our meters are manufactured based on the latest SMT and THT electronics assembly technologies. Besides manufacturing measuring instruments, we also render comprehensive surface mounting and through-hole assembly.

Designing

The creation of a new product depends on the designing process. For this purpose, we have picked a specialized team of designers, who will create the perfect solution for you needs through their determination and enormous potential.

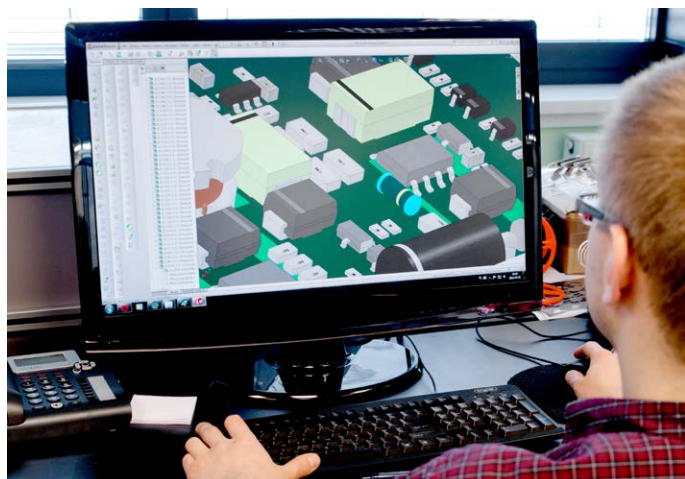

Tester construction

In order to dispel all doubts as to the proper functioning of our electronic systems, they undergo tests individually designed by us.

Production

We understand production to be the process of product creation. In our book, production means quality, precision, time, and above all, a perfectly filled order, in which we apply modern technology combined with a vast pool of knowledge.



Production line

SMT

- » MPM MOMENTUM screen printer
- » FUJI NXT automatic mounter, 6 modules
- » ERSA HOTFLOW 2/20 reflow soldering furnace (soldering in nitrogen atmosphere with residual oxygen analyzer)
- » ASYS conveyor line
- » DEK 265 screen printer
- » FUJI GL2 dispenser
- » FUJI FCP-III-4000 high speed chip placer
- » FUJI FIP-III universal automatic chip placer (additionally featuring a coplanarity check)

THT

- » ERSA-WAVE 330 wave soldering system (soldering in nitrogen atmosphere)
- » 70 stations of manual and supplementary assembly

Inspection and testing

- » AOI ORBOTECH S-22 automatic optical tester, equipped with nine cameras
- » Electrical testing of printed circuits
- » AOI (Automatic Optical Inspection)
- » Ionic cleanliness test (Ionograph)
- » Function tests

Protective coatings

Programmable selective casting (capability of selecting any area on a circuit board's surface) with lacquer or resin protective coating is performed automatically. Because of this, we achieve better productivity and save valuable time in the entire production process.

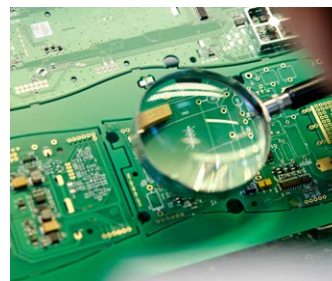
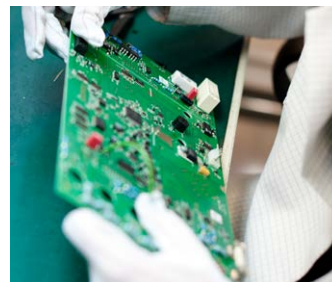

Repair and maintenance

We offer assembly and disassembly, repair and maintenance of elements as an additional service.

Quality and environment

We perform every order with the appropriate accuracy in the proper environment (ionic cleanliness tests), and thus, we ensure that your product is of the highest quality.

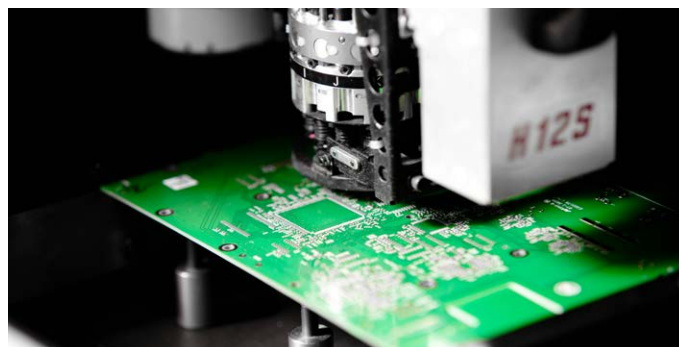

LABORATORY

What do we do?

The Testing and Calibration Laboratory of SONEL S.A. offers calibration services for measuring instruments of both electrical and non-electrical values. Apart from standard calibration procedures, the laboratory is distinguished by the knowledge of Sonel products products in the scope of construction, time drift, etc. It enables the development of an optimal process of metrological verification, allowing to check the instrument in the wider possible range of its functionality and in the typical points for a given measurement.

To provide a high quality of services, we have implemented a management system compliant with the requirements of EN ISO/IEC 17025 standard "General requirements for the competence of testing and calibration laboratories." We confirmed compliance with all the requirements of the standard by obtaining the Accreditation Certificate of Calibration Laboratory No. AP 173 issued by the Polish Centre for Accreditation in 2017. In the following years, we successively extended the scope of our accreditation to other areas. In terms of the number of performed calibration procedures, we are one of the largest laboratories of its kind in Poland. Over 25 years of experience and development allowed us to introduce to our offer services unique on the market. As one of the few laboratories, we can calibrate multifunction meters in a full range of functionality with accreditation.

We are distinguished by the implementation of calibration of measuring instruments in the scope of accreditation of:

- » impedance and short-circuit loop resistance meters from the value of 100 mΩ (including high-current fault loop impedance meters). As one of a few companies, we have a **test power network with a dedicated transformer**. Measurements are performed the power network, which allows omitting imperfections and limitations of methods based on simulations.
- » insulation resistance meters and standards in the range up to 15 kV and 20 TΩ and standards up to 40 TΩ at voltage up to 1 kV. This service is unique in the world.
- » small resistance meters for measuring currents from fractions of mA to several hundred amperes.

Our Laboratory forms a team of qualified specialists, for whom the quality of provided services is of the highest value.

USE OUR KNOWLEDGE AND EXPERIENCE!

Our offer

We calibrate devices:

- » for measuring electrical values and parameters of power networks
 - **meters:** voltage, current, residual current protection, insulation resistance, earth resistance, short circuit loop impedance measurement, resistance, network parameters, multimeters
- » electrical standards
 - calibrators, resistance standards
- » for measurements of non-electrical values
 - pyrometers, lux meters, thermal imaging cameras

When to calibrate?

SONEL S.A. recommends performing calibrations at least every 12 months for its instruments.

Why regular calibration?

For brand new instruments put into service, the next performance confirmation is recommended to be carried out within 12 months from the date of entry into service (date of purchase), but no later than 24 months from the date of the first check. The next inspection is carried out by the Testing and Calibration Laboratory of Sonel S.A., and the issued document is called Calibration Certificate (instruments having the character of a standard) or Declaration of Verification (indicators, testers without the character of a standard).

The meters are calibrated at SONEL S.A. headquarters, at str. Wokulskiego 11, 58-100 Świdnica, Poland.

Only an actual calibration certificate certifies the metrological properties of a calibrated measuring meter!!

In the case of meters used for testing relating to protection against electric shock, the person carrying out the measurements shall have all confidence in the performance of the device used. Measurements made with an inoperative meter may contribute to an incorrect assessment of the effectiveness of protection health and even human life.

CALIBRATION CERTIFICATES with PCA accreditation are recognized worldwide

This document defines the relationship between a standard and an indication of a meter and states the uncertainty of measurement.

The competence of the Testing and Calibration Laboratory of SONEL S. A. has been confirmed by an independent third party. Calibrations are performed according to standard procedures or based on individual customer requirements. The laboratory shall use methods of direct or indirect comparison to a standard, which are described in internal instructions.

WE ARE ACCREDITED BY THE POLISH CENTRE FOR ACCREDITATION



SONEL S.A.
Wokulskiego 11
58-100 Świdnica
Poland

Customer Service

+48 74 884 10 53
customerservice@sonel.com

www.sonel.com

© Copyright SONEL S.A. 2023. All rights reserved.
SONEL S.A. reserves the right to introduce changes
to the described products without prior notification.
The present catalogue does not constitute
a commercial offer under the Civil Code, and is published
with no legal responsibility and for informational purpose only.

Your distributor: