

BUYER'S GUIDE



COLLECTIONS OF YEAR 2023-2025

MINIMALISM

It Is Simple, High-quality, Iconic Clothing

INFLUENCE

Clothing Designed To Make Everyone's Life Better

INSPIRATION

Practical Sense Of Beauty Ingenious In Detail



Köré

AUTHORIZED
DISTRIBUTOR OF

GILDAN[®]

NORTH HARBOUR[®]

COMFORT COLORS[®]

CROSSRUNNER[®]

PANBASIC

★ STATESIDE[™]

American Apparel[®]

ANVIL[®]
BY GILDAN

SARRA[®]

CONTENTS

T-SHIRT

North Harbour	
NHR 1100	05
NHR 11400	07
NHR 1100B	09
NHO 1100	11
Gildan Premium Cotton	
76000	13
76000L	15
76000B	17
Gildan Softstyle	
63000	19
Gildan Hammer	
HA00	21
HA40	23
Panbasic	
P-901	24
Gildan Premium Cotton	
76400	25
76500	26
76600	27
Gildan Heavy Cotton	
5000	28
Gildan Ultra Cotton	
2000	29
2400	31
2200	32
Comfort Colors	
1717	33
American Apparel	
2001W	35
Anvil	
939	36
Stateside	
MAINE	37
TEXAS	38

POLO

North Harbour Soft-Touch Polo	
NHB 2400	39
NHB 24400	41
North Harbour Signature Polo	
NHB 2100	43
NHB 2200	44
NHB 2300	45
NHB 2500	46
NHB 2700	47
NHB 2800	49
NHB 2900	50
NHB 3200	51
NHB 3300	52

ACTIVE POLO

Crossrunner Performance Polo	
CRP 7200	53
Panbasic AIRtec Polo	
P-703	55
Crossrunner Athletic Polo	
CRP 1300	57
CRP 1500	58
CRP 1600	59
CRP 2300	60
CRP 2500	61
CRP 2700	62
CRP 2800	63
CRP 2900	64
CRP 3100	65
CRP 3200	66

ACTIVE TEE

Crossrunner DRYtec Tee	
CRR 7000	67
CRR 70400	69
CRR 7000B	70
Crossrunner Performance Tee	
CRR 3600	71
CRR 36400	73
CRR 3600B	74
Panbasic AIRtec Tee	
P-903	75
Crossrunner Plus Tee	
CRR 3900	77
Crossrunner Athletic Tee	
CRR 1100	79
CRR 1300	80
Crossrunner Sublimated Jersey	
CRR 1900	81
CRR 2000	82
Crossrunner Singlet	
CRV 1600	83
CRV 1700	84

PANTS

Track Pants	
CRS 1100	85
CRT 1100P	86
P-501	87
P-502	88

OUTERWEAR

North Harbour Jacket	
NHJ 1100	89
NHJ 2100	91
NHOH 1100	93
NHH 1100B	95
NHH 1200B	97
Gildan Heavy Blend	
88000	99
88500	101
88600	103
18800	105
Crossrunner Jacket	
CRJ 1100	107
CRJ 1100B	109

PREMIUM WORKWEAR

North Harbour Dress Shirt	
NHB 1400	111
NHB 1500	113
NHB 2000	115
North Harbour Denim Shirts	
NHB 3100	117
North Harbour Imagewear	
NHB 1700	119
NHB 1800	120
NHB 1900	121
NHB 2600	122
NHB 3000	123
NHB 3400	124

ETHNIC WEAR

Sarra Muslimah Collection	
SMW 1300	125
SMW 1300M	126
SMW 1500	127
SMW 1500M	128
SMW 1600	129
SMW 1800	130

HOMESTEAD & ACCESSORIES

North Harbour Baseball Cap	
NHC 1100	131
North Harbour Snapback	
NHC 1200	133
Crossrunner Sport Towel	
CRST 1100	135
CRST 2100	137
North Harbour Towel	
NHT 1100	139
NHT 2100	141
North Harbour Apron	
NHA 1100	143
North Harbour Tote Bag	
NHTB 1100	145
NHTB 2100	147
While Stock Last	149
Decorating Techniques	153
Pattern Reviews	155

NORTH HARBOUR®



18 colors



NHR 1100 Adult Crew Neck T-Shirt

160 g/m² (4.7 oz/yd²)
 100% ring spun cotton preshrunk jersey knit
 Fiber content varies by color, see color list for details
 2cm rib collar
 Tubular construction
 Taped neck and shoulders
 Double needle sleeve and bottom hems
 Tear away label
 18 colors
 XS - 7XL (White, Black, Navy, Red, Royal)
 XS - 3XL (All the rest colors)
 RRP : 24.90 MYR / 9.90 SGD

Size	XS	S	M	L	XL	2XL	3XL	5XL	7XL
Width	18	19	20	21	22	23	24	26	28
Length	25.5	26.5	27.5	28	29	30	31	33	35
Shoulder	16	17	18	18	20	21	22	24	26
Sleeve	6.5	7	7.5	8	8.5	9	9.5	10	10.5

Measurements may vary +/- 5% from actual product
 Measurements are presented in inches



NORTH HARBOUR®



NHR 11400

Long Sleeve T-shirt

T-shirts may be simple, but with the right colour and styling tricks, you can turn something simple into a statement piece! A basic item that goes with any look. Deliver amazing long-lasting comfort in a package that's ideal for any printing.



160 g/m² (4.7 oz/yd²)
 100% ring spun cotton preshrunk jersey knit
 Fiber content varies by color, see color list for details
 2cm rib collar
 Tubular construction
 Taped neck and shoulders
 Double needle sleeve and bottom hems
 Tear away label
 Sizes : S - 3XL
 RRP : 27.90 MYR / 11.90 SGD



NHR 11402
White



NHR 11401
Black



NHR 11405
Navy



NHR 11413
Red



NHR 11418
RS Sport Grey
(90C/10P)



NHR 11404
Royal



NHR 11420
Irish Green

Size	S	M	L	XL	2XL	3XL
Width	19	20	21	22	23	24
Length	26.5	27.5	28	29	30	31
Shoulder	17	18	19	20	21	22
Sleeve	21.5	22	22.5	23	23.5	24

Measurements may vary +/- 5% from actual product
 Measurements are presented in inches



7 colors



NHR 1102B
White



NHR 1118B
RS Sport Grey
(90C/10P)



NHR 1104B
Royal



NHR 1113B
Red



NHR 1105B
Navy



NHR 1101B
Black



NHR 1120B
Irish Green

NORTH HARBOUR®



NHR 1100B YOUTH T-SHIRT

Simple and Natural

Youth Crew Neck T-Shirt
 160 g/m² (4.7 oz/yd²)
 100% ring spun cotton preshrunk jersey knit
 Fiber content varies by color, see color list for details
 1.5cm rib collar
 Sideseamed
 Taped neck and shoulders
 Double needle sleeve and bottom hems
 Tear away label
 7 colors
 Sizes : YXS - Y2XL
 RRP : 24.90 MYR / 10.90 SGD

Size Chart

Size	YXS	YS	YM	YL	YXL	Y2XL
Width	12	13	14	15	16	17
Length	15.5	18	20	21.5	23.5	25
Shoulder	11	12	13	14	15	16
Sleeve	4.5	5	5.5	6	6.5	7

Measurements may vary +/- 5% from actual product
 Measurements are presented in inches



NORTH HARBOUR®



NHO 1100 Dynamite Oversized Crew Neck T-Shirt

Tetron cotton single jersey
 Round neckline, solid-toned tee
 Extreme soft handfeel
 Durable and breathable
 Long lasting color
 Anti-collapse, opaque
 Anti-pilling and wrinkle-resistant
 Double-needle sleeve and bottom hems
 Fashionable half-sleeve
 Oversized cut for a relaxed feel
 Tear away label
 Sizes : S - 2XL
 RRP : 35.90 MYR / 14.90 SGD

Size	S	M	L	XL	2XL
Width	21	22.5	24	25.5	27
Length	27	28	29	30	31
Shoulder	20	21	21.5	22	23
Sleeve	9.5	10	10.5	11	11

Measurements may vary +/- 5% from actual product
 Measurements are presented in inches



Elevate your style to a whole new level. Comfy, loose-fitting, stylish oversized cut. Suitable for multiple occasions.

8 colors



NHO 1101
Black



NHO 1102
Sport Grey



NHO 1103
Navy



NHO 1104
Bright Rose



NHO 1105
Sand



NHO 1106
Elderberry



NHO 1107
Tan



NHO 1108
Basil



76000 Adult T-Shirt

180 g/m² (5.3 oz/yd²)
 100% ring spun cotton preshrunk jersey knit
 Fiber content varies by color, see color list for details
 2 cm rib collar
 Taped neck and shoulders
 Double needle sleeve and bottom hems
 Quarter-turned to eliminate center crease
 Tear away label
 XS - 5XL (Black, Navy, Red, RS Sport Grey, White)
 XS - 3XL (All the rest colors)
 RRP : 29.90 MYR / 11.90 SGD



Size	XS	S	M	L	XL	2XL	3XL	4XL	5XL
Width	17	18.5	19.5	21	22	23	25	26	28
Length	25	26	27.5	28.5	29.5	30	31.5	32.5	33.5
Shoulder	15.5	17	17.5	18	19.5	20.5	21.5	22.5	23.5
Sleeve	7.5	7.5	7.5	8	8	8	8.5	8.5	8.5

Measurements may vary +/- 5% from actual product
 Measurements are presented in inches



Premium Cotton

35 colors



30 N
White



38 C
Sand



93 H
Ash Grey
(99C/1P)



295 H
RS Sport Grey
(90C/10P)



42 C
Charcoal



105 C
Dark Chocolate



108 C
Dark Heather
(50C/50P)



36 C
Black



20 C
Light Pink



263 C
Safety Pink
(50C/50P)



71 C
Azalea



10 C
Heliconia



234 C
Heather Red
(50C/50P)



40 C
Red



83 C
Maroon



37 C
Orange



193 C
Safety Orange
(50C/50P)



24 C
Gold



98 C
Daisy



188 C
Safety Green
(50C/50P)



12 C
Lime



215 C
Heather Irish Green
(50C/50P)



167 C
Irish Green



029 C
Jade Dome



106 C
Military Green



33 C
Forest Green



69 C
Light Blue



109 C
Carolina Blue



26 C
Sapphire



51 C
Royal



765 C
Sport Royal
(50C/50P)



445 C
Cobalt



232 C
Heather Purple
(50C/50P)



81 C
Purple



32 C
Navy



76000L LADIES T-SHIRT

180 g/m² (5.3 oz/yd²)
 100% ring spun cotton preshrunk jersey knit
 Fiber content varies by color
 Semi-fitted contoured silhouette with side seam
 1.3 cm rib collar
 Taped neck and shoulders
 Double needle sleeve and bottom hems
 Tear away label
 22 colors
 Sizes : LS - LXL
 RRP : 29.90 MYR / 11.90 SGD

Size	LS	LM	LL	LXL
Width	16	17	18	19
Length	23	24	25	26
Shoulder	13	13.5	14	14.5
Sleeve	5	5.5	5.5	6

Measurements may vary +/- 5% from actual product
 Measurements are presented in inches





Premium Cotton

BASIC FOR HER



ADORABLE YET COMFORTABLE

make children's everyday better



Fun t-shirts for boys & girls,
ideal for every occasion;
comfort to complete any outfit
for more relaxed days.



98 C
Daisy

24 C
Gold

37 C
Orange

12 C
Lime

167 C
Irish Green

20 C
Light Pink

71 C
Azalea

10 C
Heliconia

40 C
Red

83 C
Maroon

76000B Youth T-Shirt

180 g/m² (5.3 oz/yd²)
 100% ring spun cotton preshrunk jersey knit
 Fiber content varies by color, see color list for details
 1.5 cm rib collar
 Sideseamed
 Taped neck and shoulders
 Double needle sleeve and bottom hems
 CPSIA tracking label compliant
 Tear away label
 20 colors
 Sizes : YXS - YXL
 RRP : 26.90 MYR / 10.90 SGD

Size	YXS	YS	YM	YL	YXL
Width	13	14	15	16	17
Length	17.5	19	20	21	22.5
Shoulder	11	12	13	14	15
Sleeve	5	5.5	6	6.5	7

Measurements may vary +/- 5% from actual product
 Measurements are presented in inches





150 g/m² (4.5 oz/yd²)

100% ring spun cotton preshrunk jersey knit

Fiber content varies by color, see color list for details

Taped neck and shoulders

Double needle sleeve and bottom hems

Quarter-turned to eliminate center crease

2 cm rib collar

Tear away label

Sizes : XS - 2XL

RRP : 25.90 MYR / 10.90 SGD

Size	XS	S	M	L	XL	2XL
Width	17.5	19	20	21	22	23
Length	25	26	27	28	29	30
Shoulder	15	17	18.5	19	20	21
Sleeve	7.5	7.5	8	8	8.5	8.5

Measurements may vary +/- 5% from actual product
Measurements are presented in inches

63000

Adult Crew Neck T-Shirt



GILDAN®
 Softstyle®





Heavyweight Adult T-Shirt - HA00

210 g/m² (6.1 oz/yd²)
 100% combed ring spun cotton preshrunk jersey knit
 High stitch density for smoother printing surface
 2.3 cm rib collar, Classic Fit
 Taped neck and shoulders
 2 cm double-needle sleeve and bottom hems
 Quarter-turned to eliminate center crease
 Tear away label
 XS - 3XL (White, Black, Navy, Red, RS Sport Grey)
 XS - 2XL (All the rest colors)
 RRP : 34.90 MYR / 13.90 SGD

Size	XS	S	M	L	XL	2XL	3XL
Width	17	18.5	19.5	21	22	23	25
Length	25	26	27.5	28.5	29.5	30	31.5
Shoulder	15.5	17	17.5	18	19.5	20.5	21.5
Sleeve	7.5	7.5	7.5	8	8	8	8.5

Measurements may vary +/- 5% from actual product
 Measurements are presented in inches

14 colors



36 C
Black



30 N
White



38 C
Sand



167 C
Irish Green



98 C
Daisy



37 C
Orange



40 C
Red



83 C
Maroon



268 C
Berry



765 C
Sport Royal
(50C/50P)



32 C
Navy



24 G
Seafoam



80 C
Indigo Blue



295 H
RS Sport Grey
(90C/10P)



Perfect for daily types! A heavyweight T-shirt with a slightly fitted look.
Fiber content varies by color, see color list for details.



HA40 Adult Long Sleeve T-Shirt

210 g/m² (6.1 oz/yd²)
 100% combed ring spun cotton preshrunk jersey knit
 Fiber content varies by color, see color list for details
 High stitch density for smoother printing surface
 2.3 cm rib collar, Rib cuffs
 Taped neck and shoulders
 2 cm double needle bottom hem
 Quarter-turned to eliminate center crease
 Tear away label
 4 colors
 Sizes : XS - 2XL
 RRP : 39.90 MYR / 16.90 SGD

Size	XS	S	M	L	XL	2XL
Width	17	18.5	19.5	21	22	23
Length	25	26	27.5	28.5	29.5	30
Shoulder	15.5	17	17.5	18	19.5	20.5
Sleeve	21	22	23	23.5	24.5	25

Measurements may vary +/- 5% from actual product
 Measurements are presented in inches



30 N
White



295 H
RS Sport Grey
(90C/10P)



32 C
Navy



36 C
Black

P-901

Adult Round Neck T-Shirt

Lightweight and breathable T-shirt that will keep you feeling cool and comfortable all day. Perfect for the summer and hot weather. 100% cotton fabrics provide a soft, natural fabric that is fully breathable.



Weight: 160 Grams
 Material : 100% Premium Cotton
 100% ring-spun cotton preshrunk jersey knit
 1.3 cm rib collar
 Tape neck and shoulders
 Quarter-turned to eliminate center crease
 Double-needle sleeve and bottom hems
 Adult Unisex
 Fabric : Jersey Knit
 Size : XS – 7XL
 RRP : 24.90 MYR / 10.90 SGD



Size	XS	S	M	L	XL	2XL	3XL	5XL	7XL
Width	18	19	20	21	22	23	24	26	28
Length	25	26	20	28	29	30	31	34	36
Shoulder	16	17	18	19	20	21	22	24	25
Sleeve	7.5	8	8.5	9	9.5	10	10.5	11.5	11.5

Measurements may vary +/- 5% from actual product
 Measurements are presented in cm

GILDAN
PREMIUM
Cotton[™]



180 g/m² (5.3 oz/yd²)
 100% ring spun cotton preshrunk jersey knit
 Fiber content varies by color
 2 cm rib collar
 Taped neck and shoulders
 Double needle sleeve and bottom hems
 Quarter-turned to eliminate center crease
 5 colors
 Tear away label
 Sizes : XS - 2XL
 RRP : 32.90 MYR / 13.90 SGD



295 H
RS Sport Grey
*(90C/10P)



36 C
Black



30 N
White



40 C
Red



32 C
Navy

Size	XS	S	M	L	XL	2XL
Width	17	18.5	19.5	21	22	23
Length	25	26	27	28	29	30
Shoulder	15.5	17	17.5	18	19.5	21
Sleeve	22.5	23	23.5	24	24.5	25

Measurements may vary +/- 5% from actual product
 Measurements are presented in inches

76400

ADULT LONG SLEEVE T-SHIRT

GILDAN®
 PREMIUM
Cotton™



76500 - ADULT RAGLAN T-SHIRT

180 g/m² (5.3 oz/yd²)
 100% ring spun cotton preshrunk jersey knit
 Fiber content varies by color
 Raglan short sleeves
 Contrast color 2 cm seamed collar
 Double needle sleeve and bottom hems
 Quarter-turned to eliminate center crease
 Tear away label
 Sizes : S -2XL
 RRP : 32.90 MYR / 13.90 SGD



FB 030
 White / Black



FC 030
 White / Red



FE 030
 White / Royal



FH 030
 White /
 Irish Green



FB 295
 RS Sport Grey* / Black
 (90C/10P)



FS 036
 Black / White

Size	S	M	L	XL	2XL
Width	18.5	19.5	21	22	23
Length	26	27.5	28.5	29.5	30
Sleeve	13	13.5	14	14.5	15

Measurements may vary +/- 5% from actual product
 Measurements are presented in inches

76600

Adult Ringer T-Shirt

180 g/m² (5.3 oz/yd²)
 100% ring spun cotton preshrunk jersey knit
 Double needle bottom hem
 Contrast neck and sleeve bands
 Quarter-turned to eliminate center crease
 Tear away label
 7 colors combinations
 Sizes : XS -2XL
 RRP : 32.90 MYR / 13.90 SGD

Size	XS	S	M	L	XL	2XL
Width	17	18.5	19.5	21	22	23
Length	25	26	27.5	28.5	29.5	30
Shoulder	15.5	17	17.5	18	19.5	20.5
Sleeve	7.5	7.5	8	8	8.5	8.5

Measurements may vary +/- 5% from actual product
 Measurements are presented in inches



FC 030
White / Red



FE 030
White / Royal



FA 030
White / Navy



FA 109
Carolina Blue / Navy



FC 295
RS Sport Grey*/ Red
*(90C/10P)



FA 295
RS Sport Grey*/ Navy
*(90C/10P)



FB 295
RS Sport Grey*/ Black
*(90C/10P)

GILDAN
Heavy Cotton

OEKO-TEX®
CONFIDENCE IN TEXTILES
STANDARD 100
68255 OeTI
Tested for harmful substances
www.oeko-tex.com/standard100



180 g/m² (5.3 oz/yd²)
50% Cotton 50% Polyester
Preshrunk jersey knit
Classic Fit
Seamless double-needle 2cm collar
Quarter-turned to eliminate center crease
Taped neck and shoulders
Double needle sleeve and bottom hems
Tear away label
Sizes : S - 2XL
RRP : 34.90 MYR / 13.90 SGD



284 C
Lilac

276 C
Tweed

274 C
Russet

516 C
Graphite Heather

286 C
Midnight

Size	S	M	L	XL	2XL
Width	18	20	22	24	26
Length	28	29	30	30.5	31
Shoulder	16	18	21	22	23.5
Sleeve	6	6.5	7	7.5	8

Measurements may vary +/- 5% from actual product
Measurements are presented in inches

5000 Heavy Cotton ADULT T-SHIRT

ULTRA COTTON

simple made better

OEKO-TEX®
CONFIDENCE IN TEXTILES
STANDARD 100
68255 OeTI
Tested for harmful substances
www.oeko-tex.com/standard100



12
colors



30 N
White



36 C
Black



40 C
Red



295 H
RS Sport Grey
(90C/10P)



108 C
Dark Heather
(50C/50P)



42 C
Charcoal



106 C
Military Green



32 C
Navy



170 C
Heather Navy
(50C/50P)



173 C
Heather Indigo
(50C/50P)



51 C
Royal



217 C
Heather Sapphire
(50C/50P)

2000 Adult T-Shirt

203 g/m² (6.0 oz/yd²)

100% cotton preshrunk jersey knit

Fiber content varies by color, see color list for details

Quarter-turned to eliminate center crease

Tear away label

Seamless double-needle 2.2 cm collar

Taped neck and shoulders

Double needle sleeve and bottom hems

S - 2XL (Heather Series)

S - 3XL (Red, Charcoal, Royal, Military Green)

S - 5XL (White, Black, Navy, Sport Grey)

RRP : 34.90 MYR / 13.90 SGD



Size Chart

Size	S	M	L	XL	2XL	3XL	4XL	5XL
Width	18	20	22	24	26	28	30	32
Length	28	29	30	31	32	33	34	35
Shoulder	16	18	21	22	24	26	28	29
Sleeve	6	6.5	7	7.5	7.5	8	8.5	9

Measurements may vary +/- 5% from actual product
Measurements are presented in inches



GILDAN
Ultra Cotton

2400 Adult T-Shirt

Long Sleeve



203 g/m² (6.0 oz/yd²)
 100% cotton preshrunk jersey knit
 Fiber content varies by color
 Seamless double-needle 2.2 cm collar
 Rib cuffs
 Double-needle bottom hem
 Taped neck and shoulders
 Quarter-turned to eliminate center crease
 Tear away label
 Sizes : S - 2XL
 RRP : 39.90 MYR / 16.90 SGD

Size	S	M	L	XL	2XL
Width	18	20	22	24	26
Length	28	29	30	31	32
Shoulder	17	18.5	20	22.5	24
Sleeve	23	24	25	26	26.5

Measurements may vary +/- 5% from actual product
 Measurements are presented in inches





2200 ADULT TANK TOP

Ultra Cotton

203 g/m² (6. oz/yd²)
 Preshrunk jersey knit
 Fiber content varies by color
 Banded neck and armholes
 Double-needle bottom hem
 Quarter-turned to eliminate center crease
 Tear away label
 Classic Fit
 Sizes : S - XL
 RRP : 29.90 MYR / 11.90 SGD



295 H
 RS Sport Grey
 *(90C/10P)



36 C
 Black



32 C
 Navy

GILDAN®
Ultra Cotton®

Size	S	M	L	XL
Width	18	20	22	24
Length	27	28	29	30
Shoulder	12.5	12.5	12.5	12.5

Measurements may vary +/- 5% from actual product
 Measurements are presented in inches

COMFORT COLORS®



210 g/m² (6.1 oz/yd²)
 100% ring spun cotton
 Soft washed garment dyed fabric
 Double needle collar
 Twill taped neck and shoulders
 Twill label / Joker label
 Double needle armhole, sleeve and bottom hems
 Sizes : S - XL
 RRP : 72.90 MYR / 28.90 SGD

Size	S	M	L	XL
Width	18	20	22	24
Length	26.5	28	30	31.5
Shoulder	17	18.5	20.5	22
Sleeve	6.5	7	7.5	8

Measurements may vary +/- 5% from actual product
 Measurements are presented in inches





1717 Adult T-Shirt



26 R
Orchid



41 P
Watermelon



12 P
Crimson



08 P
Butter



06 D
Celadon



10 D
Island Reef



46 P
Charcoal



09 R
Midnight



American Apparel

2001W Crewneck T-Shirt

FINE JERSEY

146 g/m² (4.3 oz/yd²)
 100% combed ringspun cotton
 Incredibly soft
 Medium-weight fabric
 Classic Fit
 2cm seamed collar
 Shoulder-to-shoulder taping
 1" double-needle sleeve and bottom hems
 Double-satin razor label
 Sizes : S - XL
 RRP : 69.90 MYR / 27.90 SGD



Z 00
White



Z 36
Black

Size	S	M	L	XL
Width	18	20	22	24
Length	29	30	31	31.5
Shoulder	16	17	18.5	9
Sleeve	7.5	8	8.5	9

Measurements may vary +/- 5% from actual product
 Measurements are presented in inches

Adult Midweight Camouflage Tee - 939

Camouflage or military print is one such print that is always in trend. From the newest looks to fresh takes on classic styles, ANVIL have all the bases covered. It fuses the mystery and abstraction into style and fashion.



ANVIL
BY GILDAN

170 g/m² (4.9 oz/yd²)
Preshrunk jersey knit
100% Cotton, Ring Spun
Fabric 26/1
Classic Fit
Side seam construction
Shoulder-to-shoulder tape and seamed collar
Twin-needle neck, sleeve and bottom hem
Oeko-Tex® Standard 100 Certified
Tear away label
Sizes : S - 2XL
RRP : 39.90 MYR / 16.90 SGD



ANV 9391
Camouflage Green



ANV 9392
Camouflage Sand

Size Chart

Size	S	M	L	XL	2XL
Width	18	20	22	24	26
Length	28	29	30	31	32
Shoulder	16	18	20	22	24
Sleeve	7.5	8	8.5	9	9.5

Measurements may vary +/- 5% from actual product
Measurements are presented in inches

7 colors



036
Black



030
White



295
RS Sport Grey
(90C/10P)



032
Navy



040
Red



051
Royal



098
Daisy

Size	XS	S	M	L	XL	2XL
Width	17.5	18.5	19	20	21.5	22.5
Length	25	26	26.5	28	29	30

Measurements may vary +/- 5% from actual product
Measurements are presented in inches



STATESIDE



MAINE Men's Crew Neck T-shirt

180 g/m² (5.3 oz/yd²)
100% Premium Ring Spun Cotton
Pre-Shrunk Fine Jersey Knit
Contemporary Retail Fit, Side-Seamed
Rolled Forward Shoulder, Fitted
Shoulder to Shoulder Neck Taping
1.5cm Low Profile Elastane Neck Rib
Double Needle Sleeve & Bottom Hems
Tear Away Labels
Sizes : XS - 2XL
RRP : 32.90 MYR / 13.90 SGD

TEXAS

Men's Crew Neck T-shirt

205 g/m² (6.1 oz/yd²)

100% Premium Ring Spun Cotton

Pre-Shrunk Fine Jersey Knit

Contemporary Fashion Fit, Side-Seamed

Rolled Forward Shoulder, Fitted

Shoulder to Shoulder Neck Taping

1.5cm Low Profile Elastane Neck Rib

Double Needle Sleeve & Bottom Hems

Tear Away Labels

Sizes : XS - 2XL

RRP : 37.90 MYR / 15.90 SGD

Size	XS	S	M	L	XL	2XL
Width	17.5	18.5	19	20	21.5	22.5
Length	25	26	26.5	28	29	30

Measurements may vary +/- 5% from actual product
Measurements are presented in inches

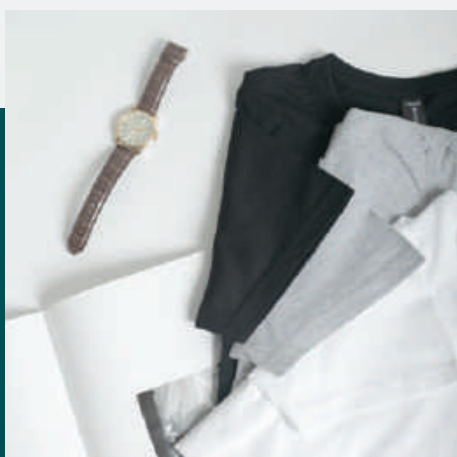

7 colors



036
Black



030
White



295
RS Sport Grey
(90C/10P)



032
Navy



040
Red



051
Royal



098
Daisy



NORTH HARBOUR®

NHB 2400 SOFT-TOUCH POLO

60% Cotton 40% Polyester Lacoste
 Ribbed polo collar
 Three-button placket
 Short sleeves with ribbed armbands
 Double-needle bottom hem
 Laser engraved buttons
 Fiber content varies by color, see color list for details
 Classic Fit
 Woven Label
 23 colors
 Sizes : XS - 3XL
 RRP : 49.90 MYR / 19.90 SGD

Size	XS	S	M	L	XL	2XL	3XL
Width	18	19	20	21	22	23	24
Length	26	27	28	29	30	31	32
Shoulder	16	17	18	19	20	21	22
Sleeve	7	7.5	8	8.5	9	9.5	10

Measurements may vary +/- 5% from actual product
 Measurements are presented in inches





THE POLO SHIRT



NORTH HARBOUR®



7 colors



NHB 24401
Black



NHB 24402
White



NHB 24405
Navy



NHB 24407
Forest Green



NHB 24413
Red



NHB 24414
Maroon



NHB 24418
Sport Grey

NHB 24400

LONG SLEEVE SOFT-TOUCH POLO



60% Cotton 40% Polyester Lacoste
Ribbed polo collar
Three-button placket
Long sleeves with ribbed cuffs
Double-needle bottom hem
Laser engraved buttons
Woven Label
Sizes : XS - 3XL
RRP : 49.90 MYR / 19.90 SGD

Size	XS	S	M	L	XL	2XL	3XL
Width	18	19	20	21	22	23	24
Length	26	27	28	29	30	31	32
Shoulder	16	17	18	19	20	21	22
Sleeve	22	22.5	23	23.5	24	24.5	25

Measurements may vary +/- 5% from actual product
Measurements are presented in inches



NORTH HARBOUR®



NHB 2101
Gold / Navy



NHB 2102
Red / White



NHB 2103
Charcoal / Royal



NHB 2104
Navy / White



NHB 2105
Sport Grey / Black

NHB 2100 GEORGIA POLO

65% Cotton 35% Polyester Lacoste
 Ribbed polo collar
 Pearlized buttons
 Short sleeves with ribbed armbands
 Double-needle bottom hem
 Bold diagonal panel design
 Woven label
 Sizes : S - 3XL
 RRP : 49.90 MYR / 19.90 SGD

Size	S	M	L	XL	2XL	3XL
Width	19	20	21	22	23	24
Length	27	28	29	30	31	32
Shoulder	17	18	19	20	21	22
Sleeve	7.5	8	8.5	9	9.5	10

Measurements may vary +/- 5% from actual product
 Measurements are presented in inches



NORTH HARBOUR®

65% Cotton 35% Polyester Lacoste
 Sleek tipping collar design
 Front button closure
 Pearlized buttons
 Contrasting ribbed armbands
 Mandarin collar
 Double-needle bottom hem
 Side vents at hem
 Casual, meet smart
 Regular fit
 Woven Label
 Sizes : S - 3XL
 RRP : 49.90 MYR / 19.90 SGD



NHB 2201
Black / Gold



NHB 2202
Red / Black



NHB 2203
Navy / Red



NHB 2204
Charcoal / Royal



NHB 2205
Royal / Sapphire



NHB 2206
Sport Grey / Navy, Red

Size	S	M	L	XL	2XL	3XL
Width	19	20	21	22	23	24
Length	27	28	29	30	31	32
Shoulder	17	18	19	20	21	22
Sleeve	7.5	8	8.5	9	9.5	10

Measurements may vary +/- 5% from actual product
 Measurements are presented in inches

NHB 2200 YORK POLO



NHB 2300 MURPHY POLO

65% Cotton 35% Polyester Lacoste
 Ribbed polo collar
 Pearlized buttons
 Bold color matching sleeve
 Short sleeves with ribbed armbands
 Double-needle bottom hem
 Side vents at hem
 Woven Label
 Sizes : S - 3XL
 RRP : 49.90 MYR / 19.90 SGD

Size	S	M	L	XL	2XL	3XL
Width	19	20	21	22	23	24
Length	27	28	29	30	31	32
Shoulder	17	18	19	20	21	22
Sleeve	7.5	8	8.5	9	9.5	10

Measurements may vary +/- 5% from actual product
 Measurements are presented in inches



NHB 2301
White
Red / Navy

NHB 2302
Navy
White / Red

NHB 2303
Red
White / Black

NHB 2304
Royal
Charcoal / Navy



NHB 2305
Sapphire
Navy / White

NHB 2306
Navy
Forest Green / Royal

NHB 2307
Forest Green
Charcoal / Black

NHB 2308
Sport Grey
Black / Daisy

NHB 2500 MULLER POLO

65% Cotton 35% Polyester Lacoste
 Knitted tipping collar and placket
 Stripes on front placket
 Pearlized buttons
 Contrast color shoulder panel
 Double-needle sleeve and bottom hems
 Side vents at hem
 Woven Label
 Sizes : S - 3XL
 RRP : 49.90 MYR / 19.90 SGD



NORTH HARBOUR®



NHB 2501
Navy / Sapphire



NHB 2502
Royal / Navy



NHB 2503
Red / Navy



NHB 2504
Black / Daisy

Size	S	M	L	XL	2XL	3XL
Width	19	20	21	22	23	24
Length	27	28	29	30	31	32
Sleeve	12.5	13.5	14.5	15.5	16.5	17.5

Measurements may vary +/- 5% from actual product
 Measurements are presented in inches



NORTH HARBOUR®



65% Cotton 35% Polyester Lacoste
 Knitted tipping collar & cuffs
 Pearlized buttons
 Double-needle bottom hem
 Side vents at hem
 Casual, meet smart
 Woven Label
 Sizes : S - 3XL
 RRP : 49.90 MYR / 19.90 SGD

Size	S	M	L	XL	2XL	3XL
Width	19	20	21	22	23	24
Length	27	28	29	30	31	32
Shoulder	17	18	19	20	21	22
Sleeve	7.5	8	8.5	9	9.5	10

Measurements may vary +/- 5% from actual product
 Measurements are presented in inches





NHB 2700 | SAFFRON POLO





65% Cotton 35% Polyester Lacoste
 Double layer woven collar
 Pearlized buttons
 Short sleeves with ribbed armbands
 Double-needle bottom hem
 Side vents at hem
 Casual, meet smart
 Regular fit
 Woven Label
 Sizes : S - 3XL
 RRP : 49.90 MYR / 19.90 SGD



NHB 2801
White / Light blue



NHB 2802
Red / Charcoal



NHB 2803
Royal / Charcoal



NHB 2804
Navy / Charcoal



NHB 2805
Black / Light Blue

Size	S	M	L	XL	2XL	3XL
Width	19	20	21	22	23	24
Length	27	28	29	30	31	32
Shoulder	17	18	19	20	21	22
Sleeve	7.5	8	8.5	9	9.5	10

Measurements may vary +/- 5% from actual product
 Measurements are presented in inches

NHB 2800 GLANCE POLO

NHB 2900 ADLEY POLO

65% Cotton 35% Polyester Lacoste
 V shape sliding design across sleeves
 Ribbed Polo collar
 Pearlized buttons
 Three-button placket
 Short sleeves with ribbed armbands
 Double-needle bottom hem
 Side vents at hem
 Classic Fit
 Casual, meet smart
 Woven Label
 Sizes : S - 3XL
 RRP : 59.90 MYR / 23.90 SGD



NORTH HARBOUR®



NHB 2901
Maroon /
Charcoal / White



NHB 2902
Royal /
Charcoal / White



NHB 2903
Forest Green /
Charcoal / White



NHB 2904
Navy /
Royal / White



NHB 2905
Navy /
Forest Green / White

Size	S	M	L	XL	2XL	3XL
Width	19	20	21	22	23	24
Length	27	28	29	30	31	32
Shoulder	17	18	19	20	21	22
Sleeve	7.5	8	8.5	9	9.5	10

Measurements may vary +/- 5% from actual product
 Measurements are presented in inches





NORTH HARBOUR®



NHB 3200 | MOJO POLO



NHB 3201
Black /
White / Black



NHB 3202
White /
Black / White



NHB 3203
Navy /
Yellow / White



NHB 3204
Black /
Red / White

65% Cotton 35% Polyester Lacoste
Knitted tipping collar, cuffs & pocket
Pearlized buttons
Welt chest pocket
Double-needle bottom hem
Side vents at hem
Woven Label
Sizes : S - 3XL
RRP : 49.90 MYR / 19.90 SGD

Size	S	M	L	XL	2XL	3XL
Width	19	20	21	22	23	24
Length	27	28	29	30	31	32
Shoulder	17	18	19	20	21	22
Sleeve	7.5	8	8.5	9	9.5	10

Measurements may vary +/- 5% from actual product
Measurements are presented in inches

NHB 3300

COLLINS POLO

65% Cotton 35% Polyester Lacoste
 Ribbed polo collar
 Half zip pullover
 Contrast color shoulder panel design
 Short sleeves with ribbed armbands
 Double-needle bottom hem
 Side vents at hem
 Casual, meet smart
 Woven Label
 Sizes : S - 3XL
 RRP : 49.90 MYR / 19.90 SGD



NHB 3301
 Black /
 Sapphire / Charcoal



NHB 3302
 White /
 Red / Navy



NHB 3303
 Red /
 Charcoal / White



NHB 3304
 Yellow /
 Forest Green / White

Size Chart

Size	S	M	L	XL	2XL	3XL
Width	19	20	21	22	23	24
Length	27	28	29	30	31	32
Sleeve	12.5	13.5	14.5	15.5	16.5	17.5

Measurements may vary +/- 5% from actual product
 Measurements are presented in inches



NORTH HARBOUR®

CROSSRUNNER®





25
colors



CRP 7200 COLtec Performance Polo

100% Performance Dry Pique
 Moisture-wicking performance fabric
 Polo neck, Solid-toned
 Soft feel, Antimicrobial, Anti-odor
 Greater stretch and recovery
 Extra mobility & range of motion
 Quick-dry, lightweight material
 Tear away label
 Sizes : XS - 6XL
 RRP : 39.90 MYR / 16.90 SGD

Size	XS	S	M	L	XL	2XL	3XL	4XL	5XL	6XL
Width	18	19	20	21	22	23	24	25	26	27
Length	26	27	28	29	30	31	32	33	34	35
Shoulder	16	17	18	19	20	21	22	23	24	25
Sleeve	7	7.5	8	8.5	9	9.5	10	10.5	11	11.5

Measurements may vary +/- 5% from actual product
 Measurements are presented in inches



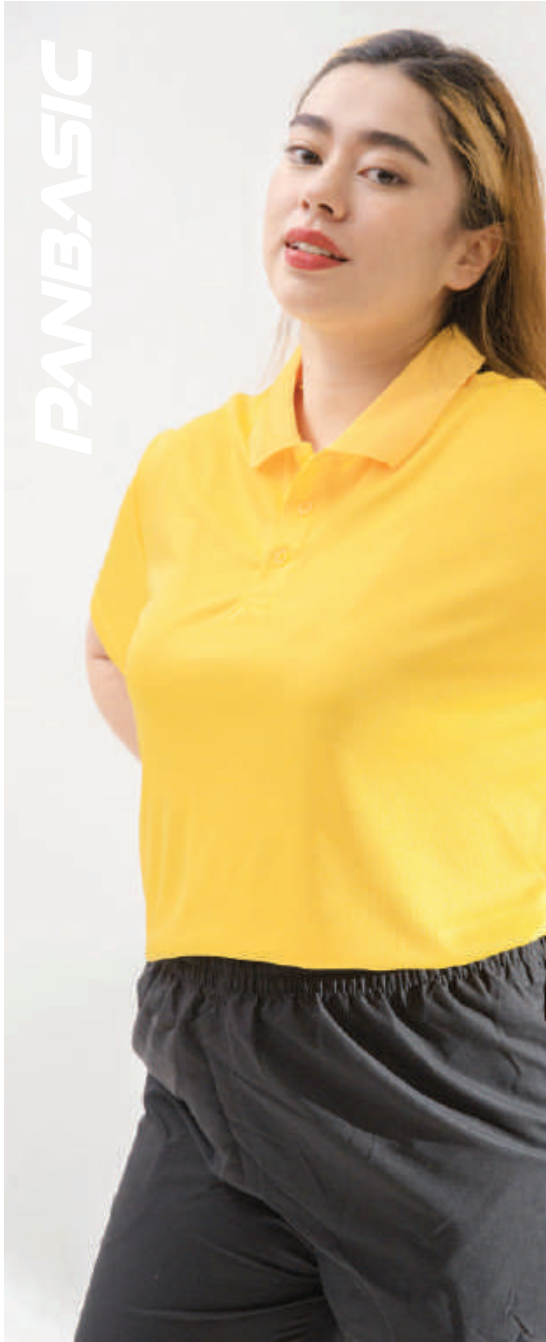

PANBASIC P-703

Flow through rounds and sets in comfort. Wicks moisture to keep you dry and extra cool so you finish even the most grueling sessions with ease.

P - 703

AIRtec Quick Dry Polo - Microfiber Mini Mesh

Made with high-quality, lightweight, quick-drying microfiber fabric, these shirts are suitable for casual hangouts with friends or as sports jerseys for athletic events.



100% Microfiber Jersey

Adult Unisex

Fiber content varies by color

Quick-dry, lightweight material

Double-needle sleeve and bottom hems

Material: 100% Microfiber

Fabric: Microfiber Mini Mesh

Weight: 150 grams

Size: XS - 7XL

RRP : 34.90 MYR / 15.90 SGD



Size	XS	S	M	L	XL	2XL	3XL	5XL	7XL
Width	18	19	20	21	22	23	24	26	28
Length	25	26	27	28	29	30	31	34	36
Shoulder	16	17	18	19	20	21	22	24	25
Sleeve	7.5	8	8.5	9	9.5	10	10.5	11.5	11.5

Measurements may vary +/- 5% from actual product
Measurements are presented in inches



CRP 1300 DELTA POLO

Quick-drying

100% Performance Dry Pique
 Contrast color waist panel & piping design
 Pearlized buttons
 Antimicrobial, Anti-odor
 Quick-dry, lightweight material
 Extra mobility & range of motion
 Greater stretch and recovery
 Soft feel, breathable performance
 Moisture-wicking performance fabric
 Satin label
 Sizes : S - 3XL
 RRP : 49.90 MYR / 19.90 SGD



CRP 1304
Charcoal / Black



CRP 1305
Sapphire / Black



CRP 1301
Orange / Charcoal



CRP 1302
Red / Black



CRP 1303
White / Black

Size	S	M	L	XL	2XL	3XL
Width	19	20	21	22	23	24
Length	27	28	29	30	31	32
Shoulder	17	18	19	20	21	22
Sleeve	7.5	8	8.5	9	9.5	10

Measurements may vary +/- 5% from actual product
 Measurements are presented in inches

CROSSRUNNER®



CRP 1500 FINISHER POLO

100% Performance Dry Pique
 Contrast color piping design
 Pearlized buttons
 Antimicrobial, Anti-odor
 Quick-dry, lightweight material
 Extra mobility & range of motion
 Greater stretch and recovery
 Soft feel, breathable performance
 Moisture-wicking performance fabric
 Best for training & lifestyle
 Satin label
 Sizes : S - 3XL
 RRP : 49.90 MYR / 19.90 SGD



CRP 1501
White / Navy



CRP 1502
Maroon / White



CRP 1503
Purple / White



CRP 1504
Royal / White



CRP 1505
Tiffany Blue / Charcoal

Size	S	M	L	XL	2XL	3XL
Width	19	20	21	22	23	24
Length	27	28	29	30	31	32
Shoulder	17	18	19	20	21	22
Sleeve	7.5	8	8.5	9	9.5	10

Measurements may vary +/- 5% from actual product
 Measurements are presented in inches

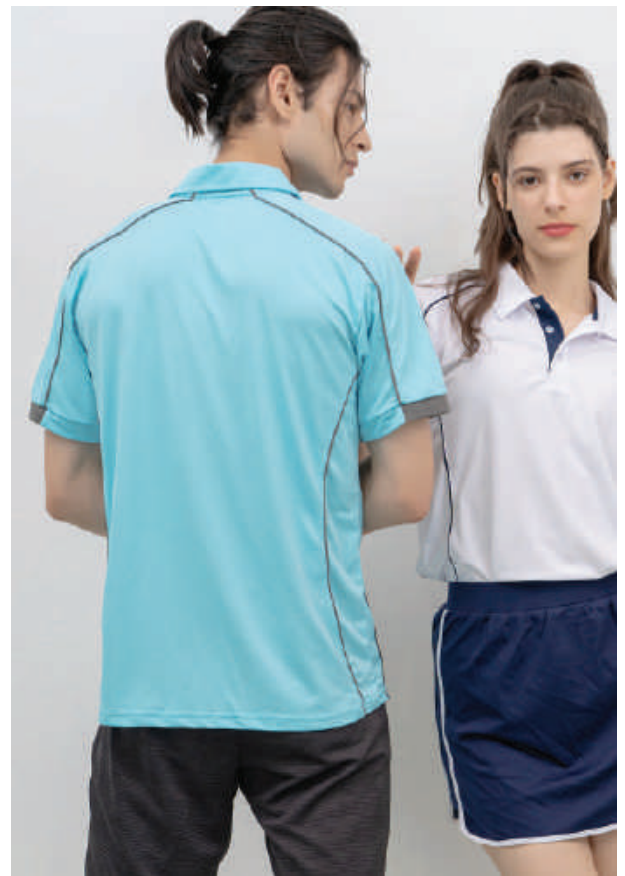

CROSSRUNNER®



CRP 1600 RACER POLO

Light & Stretchy



CRP 1601
Navy
Red / White



CRP 1602
Forest Green
Gold / White



CRP 1603
White
Neon Green / Charcoal



CRP 1604
Maroon
Heliconia / White



CRP 1605
Black
Daisy / Charcoal

100% Performance Dry Pique
 Contrast color shoulder panel design
 Pearlized buttons
 Antimicrobial, Anti-odor
 Quick-dry, lightweight material
 Extra mobility & range of motion
 Greater stretch and recovery
 Soft feel, breathable performance
 Moisture-wicking performance fabric
 Satin label
 Sizes : S - 3XL
 RRP : 49.90 MYR / 19.90 SGD

Size	S	M	L	XL	2XL	3XL
Width	19	20	21	22	23	24
Length	27	28	29	30	31	32
Shoulder	17	18	19	20	21	22
Sleeve	7.5	8	8.5	9	9.5	10

Measurements may vary +/- 5% from actual product
 Measurements are presented in inches



CRP 2300 OXLEY POLO

100% Performance Dry Pique
 Classic elegant shoulder piping
 Pearlized buttons
 Antimicrobial, Anti-odor
 Quick-dry, lightweight material
 Extra mobility & range of motion
 Greater stretch and recovery
 Soft feel, breathable performance
 Moisture-wicking performance fabric
 Satin label
 Sizes : S - 3XL
 RRP : 49.90 MYR / 19.90 SGD



CRP 2301
Black / Neon Green



CRP 2302
Red / Charcoal



CRP 2303
White / Black



CRP 2304
Sapphire / Charcoal



CRP 2305
Royal / White

Size	S	M	L	XL	2XL	3XL
Width	19	20	21	22	23	24
Length	27	28	29	30	31	32
Shoulder	17	18	19	20	21	22
Sleeve	7.5	8	8.5	9	9.5	10

Measurements may vary +/- 5% from actual product
 Measurements are presented in inches



CROSSRUNNER®

CROSSRUNNER®



CRP 2500 OCEAN POLO

Quick-drying



CRP 2501
White / Charcoal



CRP 2502
Red / Charcoal



CRP 2503
Navy / Charcoal



CRP 2504
Charcoal / Black



CRP 2505
Royal / Charcoal



CRP 2506
Jade Dome / Charcoal

100% Performance Dry Pique
 Classic tapping shoulder design
 Pearlized buttons
 Antimicrobial, Anti-odor
 Quick-dry, lightweight material
 Extra mobility & range of motion
 Greater stretch and recovery
 Soft feel, breathable performance
 Moisture-wicking performance fabric
 Satin label
 Sizes : S - 3XL
 RRP : 49.90 MYR / 19.90 SGD

Size	S	M	L	XL	2XL	3XL
Width	19	20	21	22	23	24
Length	27	28	29	30	31	32
Shoulder	17	18	19	20	21	22
Sleeve	7.5	8	8.5	9	9.5	10

Measurements may vary +/- 5% from actual product
 Measurements are presented in inches



CROSSRUNNER®



CRP 2700 PHANTOM POLO

Sublimated Jersey
 Performance Interlock
 Pearlized buttons
 Raglan classic styling
 Antimicrobial, Anti-odor
 Quick-dry, lightweight material
 Soft feel, breathable performance
 Moisture-wicking performance fabric
 Tagless heat transfer label
 Sizes : XS - 3XL
 RRP : 49.90 MYR / 19.90 SGD

Size	XS	S	M	L	XL	2XL	3XL
Width	18	19	20	21	22	23	24
Length	26	27	28	29	30	31	32
Sleeve	11.5	12.5	13.5	14.5	15.5	16.5	17.5

Measurements may vary +/- 5% from actual product
 Measurements are presented in inches

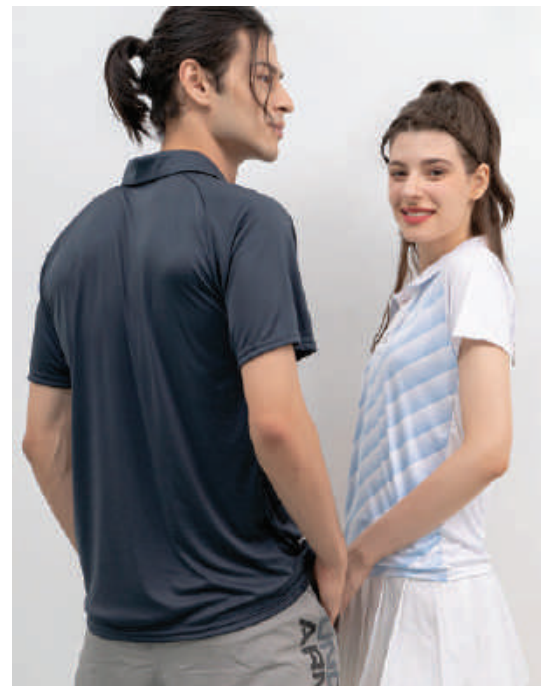

CRP 2701
White



CRP 2702
Charcoal



CRP 2703
Royal



CRP 2704
Daisy

CROSSRUNNER®



CRP 2800

Genotype Polo

Quick-drying

- Sublimated Jersey
- Performance Flat Knit
- Pearlized buttons
- Raglan classic styling
- Antimicrobial, Anti-odor
- Quick-dry, lightweight material
- Extra mobility & range of motion
- Greater stretch and recovery
- Soft feel, breathable performance
- Moisture-wicking performance fabric
- Tagless heat transfer label
- Sizes : XS - 3XL
- RRP : 49.90 MYR / 19.90 SGD



CRP 2801
Light Grey



CRP 2802
Daisy



CRP 2803
Lime



CRP 2804
Royal

Size	XS	S	M	L	XL	2XL	3XL
Width	18	19	20	21	22	23	24
Length	26	27	28	29	30	31	32
Sleeve	11.5	12.5	13.5	14.5	15.5	16.5	17.5

Measurements may vary +/- 5% from actual product
Measurements are presented in inches



100% Performance Jacquard Pique
 Contrast piping design
 Stand collar half zip pullover
 Antimicrobial, Anti-odor
 Quick-dry, lightweight material
 Extra mobility & range of motion
 Greater stretch and recovery
 Soft hand feel, breathable performance
 Moisture-wicking performance fabric
 Satin label
 Sizes : S - 3XL
 RRP : 49.90 MYR / 19.90 SGD



CRP 2901
Red / White



CRP 2902
Sapphire / White



CRP 2903
Navy / White



CRP 2904
Black / White

Size	S	M	L	XL	2XL	3XL
Width	19	20	21	22	23	24
Length	27	28	29	30	31	32
Shoulder	17	18	19	20	21	22
Sleeve	7.5	8	8.5	9	9.5	10

Measurements may vary +/- 5% from actual product
 Measurements are presented in inches

CRP 2900 PARAGON POLO



CRP 3100 HARLEY POLO

Light & Stretchy

100% Performance Dry Pique
 Contrast color lower chest panel design
 Ribbed Polo collar
 Pearlized buttons
 Antimicrobial, Anti-odor
 Short sleeves with ribbed armbands
 Extra mobility & range of motion
 Greater stretch and recovery
 Soft feel, breathable performance
 Moisture-wicking performance fabric
 Satin label
 Sizes : XS - 3XL
 RRP : 49.90 MYR / 19.90 SGD



CRP 3101
Black
Red / White



CRP 3102
White
Jade Dome / Navy



CRP 3103
Gold Yellow
Charcoal / Navy



CRP 3104
Charcoal
Navy / Forest Green



Size	XS	S	M	L	XL	2XL	3XL
Width	18	19	20	21	22	23	24
Length	26	27	28	29	30	31	32
Shoulder	15.5	16.5	17.5	18.5	19.5	20.5	21.5
Sleeve	7	7.5	8	8.5	9	9.5	10

Measurements may vary +/- 5% from actual product
 Measurements are presented in inches

CROSSRUNNER®



CRP 3200 DYNAMIC POLO

100% Performance Dry Pique
 Knitted tipping collar & half zip pullover
 Contrast color shoulder panel design
 Special shape sliding design across sleeves
 Quick-dry, lightweight material
 Antimicrobial, Anti-odor
 Soft feel, breathable performance
 Moisture-wicking performance fabric
 Satin label
 Sizes : XS - 3XL
 RRP : 49.90 MYR / 19.90 SGD

Size	XS	S	M	L	XL	2XL	3XL
Width	18	19	20	21	22	23	24
Length	26	27	28	29	30	31	32
Sleeve	11.5	12.5	13.5	14.5	15.5	16.5	17.5

Measurements may vary +/- 5% from actual product
 Measurements are presented in inches

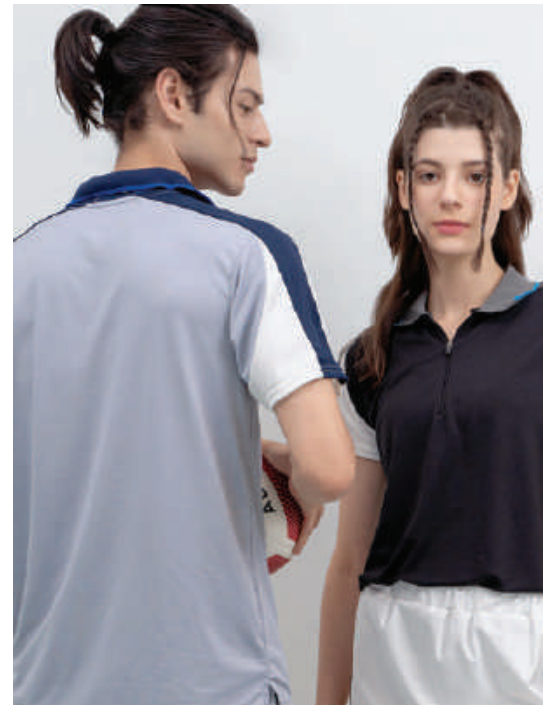

CRP 3201
Black
Charcoal / White



CRP 3202
Light Grey
Navy / White



CRP 3203
Royal
Navy / White



CRP 3204
Light Grey
Red / White

AIR SUPPLY ACTIVE TEE

keeps air flowing during your moves

New Drytech Series
from Crossrunner Comfort's calling!
Ultra breathable. Super lightweight.
Unique Stretch Sensation.



CRR 7031
Mint



CRR 7028
Midnight



CRR 7016
Lime



CRR 7017
Daisy



CRR 7029
Peach



CRR 7011
Orange



CRR 7013
Red



CRR 7014
Maroon



CRR 7026
Sand



CRR 7030
Blackberry



CRR 7000

DRYtec Performance Tee

130 g/m² - colour tee
 150 g/m² - white tee
 Pindot 75D/72F
 Anti UV 30+
 DRYtec technology
 Lightweight, Quick dry
 1.5 cm self fabric collar
 Sideseamed
 Double needle sleeve and bottom hems
 Tear away label
 15 colors available
 Sizes : XS - 7XL
 RRP : 25.90 MYR / 9.90 SGD

Size	XS	S	M	L	XL	2XL	3XL	5XL	7XL
Width	17.5	18.5	20	21	22	23	24.5	27	29
Length	25.5	27	28	29	30	30.5	31.5	33	34.5
Shoulder	15	17	17.5	18	19.5	21.5	21.5	23.5	25.5
Sleeve	7.5	8	8	8.5	9	9	9.5	10	10

Measurements may vary +/- 5% from actual product
 Measurements are presented in inches



CRR 7002
White















CRR 7027
Castlerock

CRR 7001
Black

CRR 7004
Royal

CRR 7005
Navy

15 colors

	CRR 70431 Mint
	CRR 70402 White
	CRR 70428 Midnight
	CRR 70427 Castlerock
	CRR 70416 Lime
	CRR 70401 Black
	CRR 70417 Daisy
	CRR 70404 Royal
	CRR 70429 Peach
	CRR 70405 Navy
	CRR 70411 Orange
	CRR 70430 Blackberry
	CRR 70413 Red
	CRR 70426 Sand
	CRR 70414 Maroon



CRR 70400 DRYtec Long Sleeve Tee

130 g/m² - colour tee
 150 g/m² - white tee
 Pindot 75D/72F
 Anti UV 30+
 DRYtec technology
 Lightweight, Quick dry
 1.5 cm self fabric collar
 Rib cuffs
 Sideseamed
 Double needle bottom hems
 Tear away label
 Sizes : XS - 7XL
 RRP : 29.90 MYR / 11.90 SGD

Size Chart

Size	XS	S	M	L	XL	2XL	3XL	5XL	7XL
Width	17.5	18.5	20	21	22	23	24.5	27	29
Length	25.5	27	28	29	30	30.5	31.5	33	34.5
Shoulder	15	17	17.5	18	19.5	21.5	21.5	23.5	25.5
Sleeve	22.5	23	23.5	24	24.5	25	25.5	26.5	27.5

Measurements may vary +/- 5% from actual product
 Measurements are presented in inches

CRR 7000B

DRYtec Youth Tee

130 g/m² - colour tee
 150 g/m² - white tee
 Pindot 75D/72F
 Anti UV 30+
 DRYtec technology
 Lightweight, Quick dry
 Self fabric collar
 Sideseamed
 Double needle sleeve and bottom hems
 15 colors available
 Tear away label
 Sizes : 2XS - XL
 RRP : 20.90 MYR / 8.90 SGD

Size	2XS	XS	S	M	L	XL
Width	12	13	14	15	16	17
Length	17	18	19	20	21	22
Shoulder	10	11	12	13	14	15
Sleeve	4.5	5	5.5	6	6.5	7

Measurements may vary +/- 5% from actual product
 Measurements are presented in inches

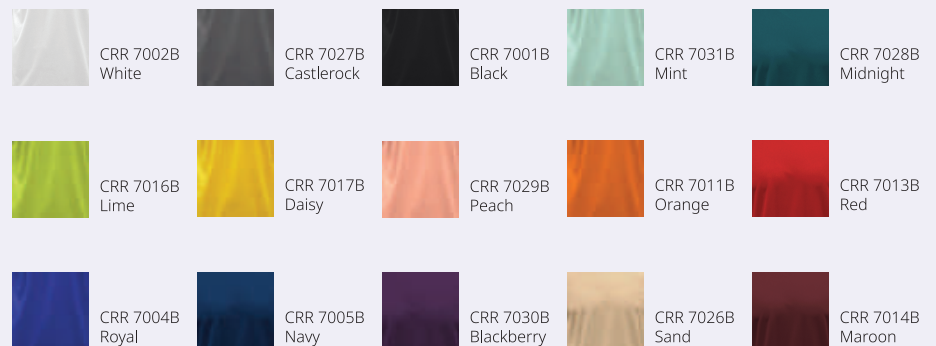

CROSSRUNNER®



CRR 3600

COLtec Performance Tee

100% Performance Dry Pique
 Round neckline, Solid-toned tee
 Moisture-wicking performance fabric
 Antimicrobial, Anti-odor
 Soft feel, breathable performance
 Extra mobility & range of motion
 Quick-dry, lightweight material
 Tear away label
 Sizes : XS - 6XL
 RRP : 29.90 MYR / 11.90 SGD

Size	XS	S	M	L	XL	2XL	3XL	4XL	5XL	6XL
Width	18	19	20	21	22	23	24	25	26	27
Length	26	27	28	29	30	31	32	33	34	35
Shoulder	16	17	18	19	20	21	22	23	24	25
Sleeve	7	7.5	8	8.5	9	9.5	10	10.5	11	11.5

Measurements may vary +/- 5% from actual product
 Measurements are presented in inches



25
colors





CRR 36400

Performance Long Sleeve Tee

100% Performance Dry Pique
 Moisture-wicking performance fabric
 Round neckline, Solid-toned tee
 Antimicrobial, Anti-odor
 Greater stretch and recovery
 Extra mobility & range of motion
 Best for training & lifestyle
 Soft feel, breathable performance
 Quick-dry, lightweight material
 Tagless heat transfer label
 Sizes : XS - 3XL
 RRP : 32.90 MYR / 13.90 SGD



CRR 36401
Black



CRR 36402
White



CRR 36403
Sapphire



CRR 36404
Royal



CRR 36405
Navy



CRR 36406
Charcoal



CRR 36407
Forest Green



CRR 36413
Red



CRR 36414
Maroon

Size	XS	S	M	L	XL	2XL	3XL
Width	18	19	20	21	22	23	24
Length	26	27	28	29	30	31	32
Shoulder	16	17	18	19	20	21	22
Sleeve	22	22.5	23	23.5	24	24.5	25

Measurements may vary +/- 5% from actual product
 Measurements are presented in inches

CRR 3600B

Youth Performance Tee

Comfort & Quick dry

100% Performance Dry Pique
 Round neckline, Solid-toned tee
 Moisture-wicking performance fabric
 Antimicrobial, Anti-odor
 Soft feel, breathable performance
 Tear away label
 Sizes : YM - YL
 RRP : 29.90 MYR / 11.90 SGD

Size	YM	YL
Width	14	15
Length	21	22
Shoulder	12	13
Sleeve	5.5	6

Measurements may vary +/- 5% from actual product
 Measurements are presented in inches



- 

CRR 3612B
Heliconia
- 

CRR 3614B
Maroon
- 

CRR 3613B
Red
- 

CRR 3611B
Orange
- 

CRR 3610B
Neon Orange
- 

CRR 3617B
Daisy
- 

CRR 3609B
Neon Green
- 

CRR 3616B
Lime
- 

CRR 3607B
Forest Green
- 

CRR 3606B
Charcoal
- 

CRR 3604B
Royal
- 

CRR 3615B
Purple
- 

CRR 3605B
Navy
- 

CRR 3618B
Tiffany Blue
- 

CRR 3603B
Sapphire
- 

CRR 3602B
White
- 

CRR 3601B
Black



P - 903

AIRtec Quick Dry

- Microfiber Mini Mesh

100% Microfiber Jersey
 Lightweight, breathable, and quick-dry
 Double-needle sleeve and bottom hems
 Fiber content varies by color
 Weight: 150 grams
 Adult Unisex
 Size: XS - 7XL
 RRP : 24.90 MYR / 10.90 SGD

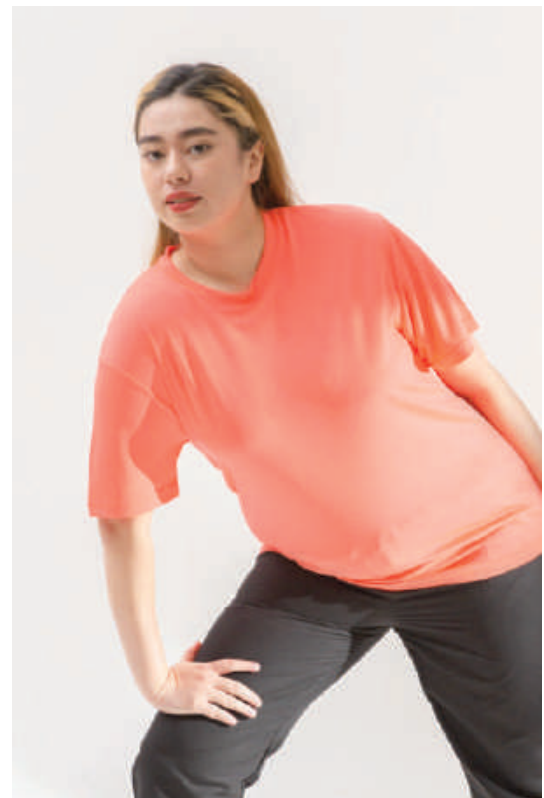

Size	XS	S	M	L	XL	2XL	3XL	5XL	7XL
Width	18	19	20	21	22	23	24	26	28
Length	25	26	27	28	29	30	31	34	36
Shoulder	16	17	18	19	20	21	22	24	25
Sleeve	7.5	8	8.5	9	9.5	10	10.5	11.5	11.5

Measurements may vary +/- 5% from actual product
 Measurements are presented in inches



Size	XS	S	M	L	XL	2XL	3XL
Width	18	19	20	21	22	23	24
Length	26	27	28	29	30	31	32
Shoulder	16	17	18	19	20	21	22
Sleeve	7	7.5	8	8.5	9	9.5	10

Measurements may vary +/- 5% from actual product
Measurements are presented in inches



CROSSRUNNER®

CRR 3900 Crossrunner Plus Performance Tee

100% Performance Jacquard Pique
Round neckline, Solid-toned tee
Soft and smooth handfeel
Moisture-wicking performance fabric
Antimicrobial, Anti-odor
Greater stretch and recovery
Extra mobility & range of motion
Double-needle sleeve and bottom hems
Best for training & lifestyle
Quick-dry, breathable, lightweight material
Tagless heat transfer label
Sizes : XS - 3XL
RRP : 39.90 MYR / 16.90 SGD

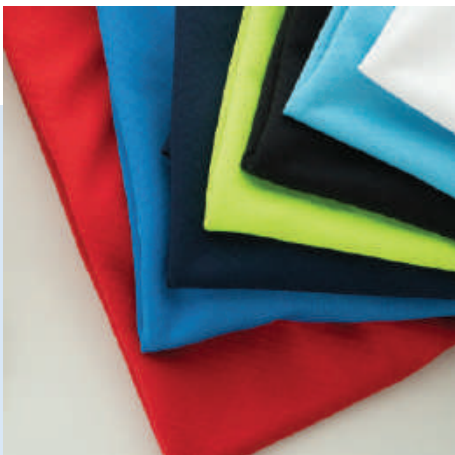

CRR 3901
Black

CRR 3902
Neon Green

CRR 3903
Aqua

CRR 3904
Sapphire

CRR 3905
White

CRR 3906
Navy

CRR 3907
Red



100% Performance Dry Pique
 Contrast color panel & stitching
 Best for training & lifestyle
 Antimicrobial, Anti-odor
 Quick-dry, lightweight material
 Extra mobility & range of motion
 Soft feel, breathable performance
 Moisture-wicking performance fabric
 Tagless heat transfer label
 Sizes : S - 3XL
 RRP : 39.90 MYR / 16.90 SGD



CRR 1101
Black / White



CRR 1102
Neon Green / Black



CRR 1103
Navy / Red



CRR 1104
Charcoal / Orange

CRR 1100 STORM TEE

Size	S	M	L	XL	2XL	3XL
Width	19	20	21	22	23	24
Length	27	28	29	30	31	32
Sleeve	12.5	13.5	14.5	15.5	16.5	17.5

Measurements may vary +/- 5% from actual product
 Measurements are presented in inches



CRR 1300 ZEN TEE

Quick-drying



CRR 1301
Navy / Red



CRR 1302
Black / White



CRR 1303
Sapphire / White



CRR 1304
Neon Green / Black



CRR 1305
Jade Dome / Charcoal

100% Performance Dry Pique
 Contrast color panel design
 Antimicrobial, Anti-odor
 Quick-dry, lightweight material
 Extra mobility & range of motion
 Greater stretch and recovery
 Soft feel, breathable performance
 Moisture-wicking performance fabric
 Best for training & lifestyle
 Tagless heat transfer label
 Sizes : S - 3XL
 RRP : 39.90 MYR / 16.90 SGD

Size	S	M	L	XL	2XL	3XL
Width	19	20	21	22	23	24
Length	27	28	29	30	31	32
Sleeve	12.5	13.5	14.5	15.5	16.5	17.5

Measurements may vary +/- 5% from actual product
 Measurements are presented in inches





CRR 1900 TRIMOSAIC TEE

Sublimated Jersey
 Performance Interlock
 Raglan classic styling
 Urban geometric mosaic pattern
 Antimicrobial, Anti-odor
 Quick-dry, lightweight material
 Extra mobility & range of motion
 Greater stretch and recovery
 Soft feel, breathable performance
 Moisture-wicking performance fabric
 Tagless heat transfer label
 Sizes : XS - 3XL
 RRP : 39.90 MYR / 16.90 SGD

CROSSRUNNER®



CRR 1901
Milo Green



CRR 1902
Daisy



CRR 1903
Sapphire



CRR 1904
Heliconia

Size Chart

Size	XS	S	M	L	XL	2XL	3XL
Width	18	19	20	21	22	23	24
Length	26	27	28	29	30	31	32
Sleeve	11.5	12.5	13.5	14.5	15.5	16.5	17.5

Measurements may vary +/- 5% from actual product
 Measurements are presented in inches

CROSSRUNNER®



Sublimated Jersey
 Performance Interlock
 Raglan classic styling
 Modern abstract chevron pattern
 Antimicrobial, Anti-odor
 Quick-dry, lightweight material
 Extra mobility & range of motion
 Greater stretch and recovery
 Soft feel, breathable performance
 Moisture-wicking performance fabric
 Tagless heat transfer label
 Sizes : XS - 3XL
 RRP : 39.90 MYR / 16.90 SGD



CRR 2001
Daisy



CRR 2002
Royal



CRR 2003
Purple



CRR 2004
Sapphire

Size Chart

Size	XS	S	M	L	XL	2XL	3XL
Width	18	19	20	21	22	23	24
Length	26	27	28	29	30	31	32
Sleeve	11.5	12.5	13.5	14.5	15.5	16.5	17.5

Measurements may vary +/- 5% from actual product
 Measurements are presented in inches

CRR 2000 FOXCHARM TEE



CRV 1600 Flex Running Vest

Quick-drying

100% Performance Dry Pique
 Running vest styling
 Contrast color panel design
 Antimicrobial, Anti-odor
 Greater stretch and recovery
 Quick-dry, lightweight material
 Extra mobility & range of motion
 Soft feel, breathable performance
 Moisture-wicking performance fabric
 Best for training & lifestyle
 Tagless heat transfer label
 Sizes : S - 3XL
 RRP : 35.90 MYR / 14.90 SGD



CRV 1601
N. Orange / Charcoal



CRV 1602
White / Black



CRV 1603
Red / Black



CRV 1604
N. Green / Black



CRV 1605
Royal / Black



Size	S	M	L	XL	2XL	3XL
Width	19	20	21	22	23	24
Length	27	28	29	30	31	32
Shoulder	11	11	11	11	11	11

Measurements may vary +/- 5% from actual product
 Measurements are presented in inches



100% Performance Jacquard Pique
 Round neckline, Solid-toned tank
 Soft and smooth handfeel
 Antimicrobial, Anti-odor
 Moisture-wicking performance fabric
 Antimicrobial, Anti-odor
 Greater stretch and recovery
 Extra mobility & range of motion
 Double-needle bottom hems
 Tagless heat transfer label
 Sizes : S - 3XL
 RRP : 35.90 MYR / 19.90 SGD



CRV 1701
Black



CRV 1702
Navy



CRV 1703
Red



CRV 1704
Sapphire



CRV 1705
Neon Green

Size	S	M	L	XL	2XL	3XL
Width	19	20	21	22	23	24
Length	27	28	29	30	31	32
Shoulder	15.5	16.5	17	18	19	19.5

Measurements may vary +/- 5% from actual product
 Measurements are presented in inches

CRV 1700 VIGOR VEST



CRS 1100

Elite Training Shorts

Relaxed Fit



CRS 1101
Black



CRS 1102
Navy



CRS 1103
Royal



CRS 1104
Red

Performance Interlock
 Elastic waistband
 Internal drawstring
 Made with stretch fabric
 Perfect for sports or casual wear
 Quick-dry, lightweight comfort
 Perfectly relaxed cut
 Extra softness
 Unisex design
 Satin Label
 Sizes : S - XL
 RRP : 35.90 MYR / 19.90 SGD

Size	S	M	L	XL
Waist Relaxed	11.5	12.5	13.5	14.5
Waist Extended	20	21	22	23
Outseam	18	18.5	19	19.5

Measurements may vary +/- 5% from actual product
 Measurements are presented in cm



CRT 1100 P

Zeal Active Trackpants

Stress-free Comfort

Performance Flat Knit (Black)
 Poly Tricot Brush (Dark Grey)
 Elastic waistband
 Internal drawstring
 Welt side pockets
 Elasticised ankle cuffs
 Unisex design
 Relaxed fit
 Satin Label
 Superior Retail Fit : XS - 2XL
 RRP : 49.90 MYR / 19.90 SGD

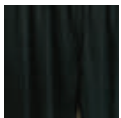

CRT 1101 P
Black



CRT 1102 P
Dark Grey



Size Chart

Size	XS	S	M	L	XL	2XL
Waist Relaxed	13	14	15	16	17	18
Waist Extended	15	16	17	18	19	20
Outseam	39	40	41	42	43	44

Measurements may vary +/- 5% from actual product
 Measurements are presented in cm





P - 501 Microfiber Track Pants

Material : 100% Polyester
 Fabric : Microfiber
 Weight : 110 grams
 Drawcord On Waist
 Sides Pocket
 Back Pocket With Zip
 Flat Opening Legs
 Quick-dry, lightweight material
 Adult Unisex
 Size : S - 2XL
 RRP : 39.90 MYR / 16.90 SGD

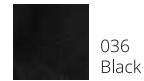

Size	S	M	L	XL	2XL
Waist Relaxed	13	13.5	14	14.5	15
Waist Extended	20	21	22	23	24
Hip	20.5	21.5	22.5	23.5	24.5
Outseam	38	39	40	41	42

Measurements may vary +/- 5% from actual product
 Measurements are presented in cm



P - 502

Microfiber Track Pants

Stress-free Comfort

Material : 100% Polyester
 Fabric : Microfiber
 Weight : 110 grams
 Drawcord On Waist
 Sides Pocket
 Back Pocket With Zip
 Grip opening legs with zip
 Quick-dry, lightweight material
 Adult Unisex
 Size : S - 2XL
 RRP : 39.90 MYR / 16.90 SGD



036
Black



032
Navy

Size Chart

Size	S	M	L	XL	2XL
Waist Relaxed	13	13.5	14	14.5	15
Waist Extended	20	21	22	23	24
Hip	20.5	21.5	22.5	23.5	24.5
Outseam	38.5	39.5	40.5	41.5	42.5

Measurements may vary +/- 5% from actual product
 Measurements are presented in cm





North Harbour

Light and comfortable, versatile and contemporary design for any moment. If you are looking for a garment with its own personality, the bomber jacket is the right option to combine with your entire wardrobe in any of the colours we offer.

NHJ 1100 BOMBER JACKET



NHJ 1101
Burgundy



NHJ 1102
Light Grey



NHJ 1104
Black



NHJ 1105
Army Green



NHJ 1103
Navy

Size	XS	S	M	L	XL	2XL	3XL
Width	20	21	21.5	22	23	24	25
Length	25.5	26	27	28	28.5	29.5	30
Shoulder	17	17.5	18	18.5	19	19.5	20
Sleeve	25	25.5	26	26.5	27	27.5	28

Measurements may vary +/- 5% from actual product
Measurements are presented in inches



NORTH HARBOUR®

Solid tone bomber jacket
Light weight polyester pongee
Interlining with 210t polyester
Wind resistant fabric
Stand collar neckline
Elasticated cuffs and hem
Long sleeve
2 front side pockets
1 inner pocket
Front zip fastening
5 colors
Satin label
Sizes : XS - 3XL
RRP : 69.90 MYR / 27.90 SGD



NHJ 2100 - FlipIt Reversible Jacket

High neckline
 Front zip fastening
 Elastic cuffs and hem
 Face: poly tricot / Back: poly pongee
 2 front side pockets; 2 front zip pockets
 Reversible with dual toned design on one side
 Regular fit
 Woven label
 Sizes : XS - 3XL
 RRP : 89.90 MYR / 35.90 SGD

Size	XS	S	M	L	XL	2XL	3XL
Width	20	21	21.5	22	23	24	25
Length	25.5	26	27	28	28.5	29.5	30
Shoulder	17	17.5	18	18.5	19	19.5	20
Sleeve	25	25.5	26	26.5	27	27.5	28

Measurements may vary +/- 5% from actual product
 Measurements are presented in inches





NORTH HARBOUR®

Stylish and functional



NHJ 2101 - Navy / Black



NHJ 2102 - Sky Blue / Navy



NHJ 2103 - Black / Dark Grey



260 g/m² (7.6 oz/yd²)
 60% Cotton 40% Polyester CVC Fleece
 Ribbed cuffs and hem
 Oversized fit
 Hooded neckline
 Color-matched drawcord
 Kangaroo pocket
 Soft and comfortable
 Straight cut suits all body types
 Best for lifestyle
 Satin Label
 Sizes : S - 2XL
 RRP : 79.90 MYR / 32.90 SGD

Size	S	M	L	XL	2XL
Width	23.5	24	25	26	26.5
Length	30	30.5	31.5	32	33
Shoulder	24	25	26	26.5	27
Sleeve	18	18.5	19	19.5	20

Measurements may vary +/- 5% from actual product
 Measurements are presented in inches





NHOH 1100 - Harper Oversized Hoodie



NHOH 1101
White



NHOH 1102
Red



NHOH 1103
Maroon



NHOH 1104
Black



NHOH 1105
Dark Heather



NHOH 1106
Navy



NHOH 1107
Royal



NHOH 1108
Sport Grey



NHH 1100B Payton Hoodie-Youth

260 g/m² (7.6 oz/yd²)
 60% Cotton 40% Polyester CVC Fleece
 Ribbed cuffs and hem
 Hooded neckline
 Kangaroo pocket
 Soft and comfortable
 Satin Label
 Sizes : S - XL
 RRP : 69.90 MYR / 27.90 SGD

Size	S	M	L	XL
Width	14	15	16	17
Length	19	20	21	22
Shoulder	12	13	14	15
Sleeve	18	18.5	19	19.5

Measurements may vary +/- 5% from actual product
 Measurements are presented in inches





North Harbour KIDS

Exclusively designed by us for you. Keep the little ones comfy this season! Setting a sporty look this hooded sweater is constructed of premium waffle fabric featuring a metal front zipper closure and functional side pockets! The cutest addition to your child's wardrobe.



NORTH HARBOUR®

NHH 1200B

Rhodes Hoodie-Youth

260 g/m² (7.6 oz/yd²)

60% Cotton 40% Polyester CVC Fleece

Ribbed cuffs and hem

Metal Zipper

Hooded neckline

Kangaroo pocket

Soft and comfortable

Satin Label

Sizes : S - XL

RRP : 69.90 MYR / 27.90 SGD

Size	S	M	L	XL
Width	14	15	16	17
Length	19	20	21	22
Shoulder	12	13	14	15
Sleeve	18	18.5	19	19.5

Measurements may vary +/- 5% from actual product
Measurements are presented in inches



GILDAN
Heavy Blend™



88000 | ADULT CREWNECK SWEATSHIRT



30 N
White



51 C
Royal



32 C
Navy



81 C
Purple



40 C
Red



95 H
Sport Grey



36 C
Black



285 g/m² (8.4 oz/yd²)
 50% cotton / 50% polyester preshrunk fleece knit
 2 x 1 rib with spandex
 Sideseamed
 Best for lifestyle
 Regular fit
 Authentic sweat fabric
 Tear away label
 Double-needle stitching at waistband and cuffs
 Straight cut suits all body types
 Versatile sweats for all outfits and occasions
 Sizes : XS - 2XL
 RRP : 79.90 MYR / 29.90 SGD

Size	XS	S	M	L	XL	2XL
Width	19	20	21	22	24	25
Length	24	25	26	27	28	29
Shoulder	15.5	16.5	17.5	18.5	19.5	20.5
Sleeve	22	22.5	23	23.5	24	24.5

Measurements may vary +/- 5% from actual product
 Measurements are presented in inches



GILDAN
Heavy Blend™



OEKO-TEX®
 CONFIDENCE IN TEXTILES
STANDARD 100
 68255 OeTI
 Tested for harmful substances
 www.oeko-tex.com/standard100

88500 Adult Hooded Sweatshirt

285 g/m² (8.4 oz/yd²)
 50% cotton / 50% polyester preshrunk fleece knit
 Double-needle stitching at waistband and cuffs
 Double-lined hood with color-matched drawcord
 2 x 1 rib with spandex
 Pouch pockets
 Sideseamed
 Best for lifestyle
 Tear away label
 Sizes : XS - 2XL
 RRP : 89.90 MYR / 32.90 SGD

Size	XS	S	M	L	XL	2XL
Width	19	20	21	22	24	25
Length	24	25	26	27	28	29
Shoulder	15.5	16.5	17.5	18.5	19.5	20.5
Sleeve	22	22.5	23	23.5	24	24.5

Measurements may vary +/- 5% from actual product
 Measurements are presented in inches



6 colors



30 N
 White

51 C
 Royal

32 C
 Navy

40 C
 Red

95 H
 Sport Grey

36 C
 Black

GILDAN
Heavy Blend™

OEKO-TEX®
CONFIDENCE IN TEXTILES
STANDARD 100
68255 OeTI
Tested for harmful substances
www.oeko-tex.com/standard100



88600 Adult Full Zip Hooded Sweatshirt

285 g/m² (8.4 oz/yd²)
 50% cotton / 50% polyester preshrunk fleece knit
 Double-needle stitching at waistband and cuffs
 Unlined hood with color-matched drawcord
 Metal Zipper
 Pouch pockets
 2 x 1 rib with spandex
 Sideseamed
 5 colors
 Tear away label
 Sizes : XS - 2XL
 RRP : 89.90 MYR / 32.90 SGD

Size	XS	S	M	L	XL	2XL
Width	19	20	21	22	24	25
Length	24	25	26	27	28	29
Shoulder	15.5	16.5	17.5	18.5	19.5	20.5
Sleeve	22	22.5	23	23.5	24	24.5

Measurements may vary +/- 5% from actual product
 Measurements are presented in inches



30 N
White



40 C
Red



32 C
Navy



95 H
Sport Grey



36 C
Black

GILDAN
Heavy Blend™

OEKO-TEX®
STANDARD 100
68255 OeTI
Tested for harmful substances
www.oeko-tex.com/standard100



18800 - Adult Vintage Cadet Collar Sweatshirt

Sweatshirts, the queen of streetwear, stand the test of time. Season after season, this classic garment continues to be on trend. Men's sporty looks wouldn't be the same without sweatshirts. Have a natural look that is great for everyday wear.



270 g/m² (8 oz/yd²)
 50% cotton / 50% polyester
 Preshrunk fleece knit
 Air jet yarn = softer feel and reduced pilling
 Cross dyed shades (2 colors in one fabric)
 Self fabric lined collar
 Contrast dark grey twill tape
 1/4 brass zipper with contrast dark grey trim
 Double-needle stitching at shoulder, armhole, waistband and cuffs
 1 x 1 rib with spandex
 Quarter-turned to eliminate center crease
 Sizes : S - XL Tear away label
 RRP : 79.90 MYR / 31.90 SGD



Size	S	M	L	XL
Width	20	22	24	26
Length	26	27	28	29
Shoulder	19.5	21.5	23.5	25.5
Sleeve	22.5	22.7	23	23.7

Measurements may vary +/- 5% from actual product
 Measurements are presented in inches



CRJ 1100 | VARSITY JACKET



CRJ 1102
Black / White



CRJ 1103
Royal / White



CRJ 1104
Navy / White



CRJ 1105
Sport Grey / White



CRJ 1107
Black



CRJ 1108
Navy



CRJ 1109
Royal



CRJ 1110
Red



CRJ 1111
Maroon



CRJ 1112
Sport Grey



60% Cotton 40% Polyester CVC Fleece
 Varsity style jacket with tipping detail
 Stand collar neckline
 Button fastening
 Striped rib-knit cuffs & collar
 Soft and comfortable
 Oversized fit
 Slanted welt pockets
 Straight cut suits all body types
 Authentic sweat fabric
 Satin Label
 Sizes : S - 3XL
 RRP : 69.90 MYR / 27.90 SGD

Size	S	M	L	XL	2XL	3XL
Width	20	21	22	23	24	25
Length	26.5	27.5	28.5	29.5	30.5	31.5
Shoulder	18	19	20	21	22	23
Sleeve	23.5	24	24.5	25	25.5	26

Measurements may vary +/- 5% from actual product
 Measurements are presented in inches



A FUN TAKE ON THE CLASSIC

brings your kids a simple joy



The perfect combination of stylish and practical, these classic retro youth varsity jackets are a must have.

CRJ 1100B

Youth Varsity Jacket

60% Cotton 40% Polyester CVC Fleece

Varsity style jacket with tipping detail

Striped rib-knit cuffs & collar

Short stand collar

Slanted welt pockets

Straight cut suits all body types

Authentic sweat fabric

Satin Label

Sizes : S - XL

RRP : 59.90 MYR / 21.90 SGD

Size	S	M	L	XL
Width	14	15	16	17
Length	21	22	23	24
Shoulder	12	13	14	15
Sleeve	16	16.5	17	17.5

Measurements may vary +/- 5% from actual product
Measurements are presented in inches



CROSSRUNNER®



CRJ 1102B
Black / White



CRJ 1103B
Royal / White



CRJ 1104B
Navy / White



CRJ 1105B
Sport Grey / White



CRJ 1107B
Black



CRJ 1108B
Navy



CRJ 1109B
Royal



CRJ 1110B
Red



CRJ 1111B
Maroon



CRJ 1112B
Sport Grey



NHB 1400 PREMIUM OXFORD

100% Premium Cotton Oxford
More opaque material, high-quality fabric
Pearlized buttons
Button-through sleeve plackets
Meticulous attention to detail with a long hem
Rounded hemline
Woven Label
Sizes : S - 3XL
RRP : 79.90 MYR / 31.90 SGD

Size Chart

Size	S	M	L	XL	2XL	3XL
Width	20	21	22	23	24	25
Length	30	31	32	32.5	33	33.5
Shoulder	17	18	19	20	21	22
Sleeve	25.5	26.5	27.5	28	28.5	29

Measurements may vary +/- 5% from actual product
Measurements are presented in inches



3 colors



NHB 1401
Black



NHB 1402
White



NHB 1403
Charcoal



3 colors



NHB 1501
Black



NHB 1502
White



NHB 1503
Charcoal



NHB 1500 Premium Oxford

Short Sleeve

100% Premium Cotton Oxford
 More opaque material, high-quality fabric
 Regular collar completes the look
 Pearlized buttons
 Great for both casual and dressier looks
 Meticulous attention to detail with a long hem
 Rounded hemline
 Woven Label
 Superior Retail Fit :
 Sizes : S - 3XL
 RRP : 79.90 MYR / 31.90 SGD

Size Chart

Size	S	M	L	XL	2XL	3XL
Width	20	21	22	23	24	25
Length	30	31	32	32.5	33	33.5
Shoulder	17	18	19	20	21	22
Sleeve	8.5	9	9.5	10	10.5	11

Measurements may vary +/- 5% from actual product
 Measurements are presented in inches







NORTH HARBOUR®

NHB 2000 Cotton Rayon Shirt

65% Cotton 35% Rayon

Pearlized buttons

Wrinkle-resistant even after washing for easy care

Smoother, more opaque material

Light and comfortable, high-quality fabric

Excellent breathability provides cool comfort

Button-through sleeve plackets

Meticulous attention to detail with a long hem

Rounded hemline

Woven Label

Sizes : S - 3XL

RRP : 79.90 MYR / 31.90 SGD



NHB 2001
Light Blue



NHB 2002
Gravel



NHB 2003
Carolina Blue

Size	S	M	L	XL	2XL	3XL
Width	20	21	22	23	24	25
Length	30	31	32	32.5	33	33.5
Shoulder	17	18	19	20	21	22
Sleeve	25.5	26.5	27.5	28	28.5	29

Measurements may vary +/- 5% from actual product
Measurements are presented in inches



NORTH HARBOUR®

NHB 3100

Virgil Shirt

SOFT DENIM

100% Soft cotton denim
Pearlized buttons
Front button placket
Regular collar completes the look
Button-through sleeve plackets
Great for both casual and dressier looks
Light and comfortable, soft hand feel material
Meticulous attention to detail with a long hem
Rounded hemline
Woven Label
Sizes : S -3XL
RRP : 69.90 MYR / 27.90 SGD



NHB 3101
Sky



NHB 3102
Earl Blue



NHB 3103
Midnight

Size	S	M	L	XL	2XL	3XL
Width	20	21	22	23	24	25
Length	30	31	32	32.5	33	33.5
Shoulder	17	18	19	20	21	22
Sleeve	25.5	26.5	27.5	28	28.5	29

Measurements may vary +/- 5% from actual product
Measurements are presented in inches



NORTH HARBOUR®



NHB 1700 Synergy Racewear

Premium Workwear



NHB 1701
Lavender / White



NHB 1702
Royal / White



NHB 1703
Navy / White



NHB 1704
Orange / White



NHB 1705
Charcoal / White



NHB 1706
Red / White

65% Viscose 35% Polyester
 Pearlized buttons
 Front button placket
 Pocket on the chest
 Contrast piping design
 Meticulous attention to detail with a long hem
 Rounded hemline
 Woven Label
 Superior Retail Fit :
 Sizes : S - 3XL
 RRP : 69.90 MYR / 27.90 SGD

Size	S	M	L	XL	2XL	3XL
Width	20	21	22	23	24	25
Length	30	31	32	32.5	33	33.5
Shoulder	17	18	19	20	21	22
Sleeve	8.5	9	9.5	10	10.5	11

Measurements may vary +/- 5% from actual product
 Measurements are presented in inches





NORTH HARBOUR®

NHB 1800 Impact Racewear

Regular Fit

65% Viscose 35% Polyester
 Pearlized buttons
 Collar neckline
 Front buttons fastening
 Welt pocket on the chest
 Contrast color panel design
 Back pleat detail
 Meticulous attention to detail with a long hem
 Rounded hemline
 Regular fit
 Woven Label
 Sizes : S - 3XL
 RRP : 69.90 MYR / 27.90 SGD



NHB 1801
Gold / Royal



NHB 1802
Sapphire / White



NHB 1803
Red / Gravel



NHB 1804
Dark Charcoal / Lime

Size	S	M	L	XL	2XL	3XL
Width	20	21	22	23	24	25
Length	30	31	32	32.5	33	33.5
Shoulder	17	18	19	20	21	22
Sleeve	8.5	9	9.5	10	10.5	11

Measurements may vary +/- 5% from actual product
 Measurements are presented in inches

NORTH HARBOUR®

NHB 1900 SMART RACEWEAR

65% Viscose 35% Polyester
Pearlized buttons
Collar neckline
Front buttons fastening
Pocket on the chest
Contrast color design collar & sleeve
Back pleat detail
Rounded hemline
Regular fit
Woven Label
Sizes : S - 3XL
RRP : 69.90 MYR / 27.90 SGD

Size	S	M	L	XL	2XL	3XL
Width	20	21	22	23	24	25
Length	30	31	32	32.5	33	33.5
Shoulder	17	18	19	20	21	22
Sleeve	8.5	9	9.5	10	10.5	11

Measurements may vary +/- 5% from actual product
Measurements are presented in inches



NHB 1901
White / Navy



NHB 1902
Sapphire / White



NHB 1903
Red / Black



NHB 1904
Charcoal / White



NHB 2600 Murphy Racewear

Premium Workwear

65% Viscose 35% Polyester
 Pearlized buttons
 Collar neckline
 Front buttons fastening
 Bold color matching sleeve
 Meticulous attention to detail with a long hem
 Rounded hemline
 Regular fit
 Woven Label
 Sizes : S - 3XL
 RRP : 69.90 MYR / 27.90 SGD



NHB 2601
White
Red / Navy



NHB 2602
Navy
White / Red



NHB 2603
Red
White / Black



NHB 2604
Royal
Charcoal / Navy



NHB 2605
Sapphire
Navy / White

Size	S	M	L	XL	2XL	3XL
Width	20	21	22	23	24	25
Length	30	31	32	32.5	33	33.5
Shoulder	17	18	19	20	21	22
Sleeve	8.5	9	9.5	10	10.5	11

Measurements may vary +/- 5% from actual product
 Measurements are presented in inches



NHB 3000 CYRIL SHIRT

65% Viscose 35% Polyester
 Knitted tipping collar & cuffs
 Pearlized buttons
 Front buttons fastening
 Great for both casual and dressier looks
 Meticulous attention to detail with a long hem
 Rounded hemline
 Regular fit
 Woven Label
 Sizes : S - 3XL
 RRP : 69.90 MYR / 27.90 SGD

NORTH HARBOUR®



NHB 3001
White / Red / Black



NHB 3002
Red / White / Navy



NHB 3003
Navy / White / Red



NHB 3004
Black / White / Red

Size	S	M	L	XL	2XL	3XL
Width	20	21	22	23	24	25
Length	30	31	32	32.5	33	33.5
Shoulder	17	18	19	20	21	22
Sleeve	8.5	9	9.5	10	10.5	11

Measurements may vary +/- 5% from actual product
 Measurements are presented in inches



NHB 3400 Charms Shirt

Short Sleeve



NHB 3401
Black



NHB 3402
Fortune Red



NHB 3403
Emerald Green



NHB 3404
Olive Green

65% Cotton 35% Rayon
Mandarin Collar
Stand collared neckline
Pearlized buttons
Wrinkle-resistant even after washing for easy care
Smoother, more opaque material
Light and comfortable, high-quality fabric
Excellent breathability provides cool comfort
Rounded hemline
Woven Label
Sizes : S -3XL
RRP : 69.90 MYR / 27.90 SGD

Size	S	M	L	XL	2XL	3XL
Width	20	21	22	23	24	25
Length	30	31	32	32.5	33	33.5
Shoulder	17	18	19	20	21	22
Sleeve	8.5	9	9.5	10	10.5	11

Measurements may vary +/- 5% from actual product
Measurements are presented in inches





SMW 1300 INAYAH

Muslimah Wear

40% Cotton 60% Polyester
Mandarin collar
Classic two color panel
Waistline pocket feature
Superior Retail Fit :
Ladies fitting from S to 3XL
RRP : 59.90 MYR / 23.90 SGD



SMW 1301
Daisy / Forest Green



SMW 1302
Maroon / Heliconia



SMW 1303
Black / Charcoal



SMW 1304
Purple / Red

Size	S	M	L	XL	2XL	3XL
Width	19	20	21	22	23	24
Length	35	36	37	38	39	40
Shoulder	15.5	16.5	17.5	18.5	19.5	20.5
Sleeve	20.5	21	21.5	22	22.5	23

Measurements may vary +/- 5% from actual product
Measurements are presented in inches

SARRA®



SMW 1300M IYADH MUSLIMIN

40% Cotton 60% Polyester
Welded collar and placket
Classic two color panel
Polo collar neckline
Regular fit
Button fastening
Superior Retail Fit :
Men fitting from S to 3XL
RRP : 59.90 MYR / 23.90 SGD

Size	S	M	L	XL	2XL	3XL
Width	19	20	21	22	23	24
Length	27	28	29	30	31	32
Shoulder	17	18	19	20	21	22
Sleeve	7	8	8.5	8.5	9	9

Measurements may vary +/- 5% from actual product
Measurements are presented in inches



SMW 1301 M
Daisy / Forest Green



SMW 1302 M
Maroon / Heliconia



SMW 1303 M
Black / Charcoal



SMW 1304 M
Purple / Red

SMW 1500 - AMMARA Muslimah Wear Collection

Sarra are caters to everyday modern Muslims with its wide variety of comfortable and stylish Muslim wear. Always bring the perfect outlook for men who wear it, fulfill the needs of fashion and comfortability. Sarra is an importance piece to earn by the modern Muslim.



40% Cotton 60% Polyester
Sporty Raglan design
Round neckline
Waistline pocket feature
A shape muslimah cutting
Woven label
Superior Retail Fit :
Ladies fitting from S to 3XL
RRP : 59.90 MYR / 23.90 SGD



SMW 1501
Black / Royal



SMW 1502
Maroon / Charcoal



SMW 1503
Navy / Red



SMW 1504
Navy / Sapphire



SMW 1505
Black / Charcoal



SMW 1506
Maroon / Heliconia



SMW 1507
Forest Green / Lime

Size	S	M	L	XL	2XL	3XL
Width	19	20	21	22	23	24
Length	35	36	37	38	39	40
Sleeve	24	25	26	27	28	29

Measurements may vary +/- 5% from actual product
Measurements are presented in inches

SMW 1500M - ADAM

Muslimin Wear Collection

40% Cotton 60% Polyester
 Welded collar and placket
 Sporty Raglan design
 Polo collar neckline
 Regular fit
 Button fastening
 Superior Retail Fit :
 Men fitting from S to 3XL
 RRP : 59.90 MYR / 23.90 SGD

Size	S	M	L	XL	2XL	3XL
Width	19	20	21	22	23	24
Length	27	28	29	30	31	32
Sleeve	12.5	13.5	14.5	15.5	16.5	17.5

Measurements may vary +/- 5% from actual product
 Measurements are presented in inches



SMW 1501 M
Black / Royal



SMW 1502 M
Maroon / Charcoal



SMW 1503 M
Navy / Red



SMW 1504 M
Navy / Sapphire



SMW 1505 M
Black / Charcoal



SMW 1506 M
Maroon / Heliconia



SMW 1507 M
Forest Green / Lime

SMW 1600 FADHILAH

100% Performance Dry Pique
 Round neckline
 Sporty raglan design
 Waistline pocket feature
 New asian A shape muslimah cutting
 Soft and smooth handfeel
 Antimicrobial, Anti-odor
 Breathable performance
 Woven Label
 Superior Retail Fit : Ladies fitting from S to 3XL

Size	S	M	L	XL	2XL	3XL
Width	19	20	21	22	23	24
Length	35	36	37	38	39	40
Sleeve	24	25	26	27	28	29

Measurements may vary +/- 5% from actual product
 Measurements are presented in inches



SMW 1601
Navy
Heliconia / White



SMW 1602
Charcoal
White / Black



SMW 1603
Forest Green
Daisy / Maroon



SARRA®

SMW 1800 OBADIAH

Muslimah Wear

100% Performance Dry Pique
 Solid coloured muslimah top
 Round neckline
 Hidden side pocket
 New asian A shape muslimah cutting
 Lightweight material
 Soft feel, breathable performance
 Woven label
 Superior Retail Fit : S -3XL
 RRP : 49.90 MYR / 19.90 SGD



SMW 1801
Heliconia



SMW 1802
Irish Green



SMW 1803
Purple



SMW 1804
Black



SMW 1805
Navy

Size	S	M	L	XL	2XL	3XL
Width	19	20	21	22	23	24
Length	35	36	37	38	39	40
Shoulder	15.5	16.5	17.5	18.5	19.5	20.5
Sleeve	20.5	21	21.5	22	22.5	23

Measurements may vary +/- 5% from actual product
 Measurements are presented in inches

NHC 1100 BASEBALL CAP

Acrylic twill
Six panel construction
6 breathable eyelets
6 rows of stitching on visor
Seamed front panel with full buckram
Curved peak
Pro stitch on crown
Matching fabric undervisor
Matching color sweatband
Metal sliding buckle closure
RRP : 26.90 MYR / 10.90 SGD

NORTH HARBOUR®





14 colors



NHC 1113
Light Pink



NHC 1114
Sand



NHC 1104
Daisy



NHC 1111
Orange



NHC 1106
Red



NHC 1107
Maroon



NHC 1105
Forest Green



NHC 1103
Black



NHC 1101
White



NHC 1102
Grey



NHC 1110
Charcoal



NHC 1112
Sapphire



NHC 1108
Royal



NHC 1109
Navy



The classic baseball cap has become an indispensable beacon that calls out to like-minded individuals, whether it's embroidered with a sports team, college, or company logo. A trusty cap is a practical shade in the summer, but it can also signal a hobby or alignment.



KIND OF COOL TREND

Acrylic Twill
6-panel Fitted Cap
Seamed Front Panel with Full Buckram
6 Sewn Eyelets
Pro Stitch on Crown
6 Rows of Stitching on Visor
Matching Fabric Undervisor
Matching Color Sweatband
Adjustable Snap Closure
RRP : 29.90 MYR / 11.90 SGD





NHC 1200 SNAPBACK



NHC 1203
Black



NHC 1201
White



NHC 1202
Grey



NHC 1205
Red



NHC 1206
Royal



NHC 1207
Navy



NHC 1204
Forest Green



CRST 1100 SPORTS TOWEL

Quick Dry

Material : Superfine fiber
Weight : 40 gsm
Highly absorbent
Anti-bacterial
Prevent Odour
Lightweight and soft
Compact design, Easy to pack
Fast-drying microfiber
Convenient and comfortable
Tear away label
Sizes : 13.7" x 25.5"
RRP : 22.90 MYR / 8.90 SGD



*Please note that CRST 1102 white towel are friendly for sublimation printing, kindly contact CS for further information.

4 colors



CRST 1132
Baby Pink



CRST 1131
Mint



CRST 1108
Midnight



CRST 1102
White





4 colors



CRST 2132
Baby Pink



CRST 2131
Mint



CRST 2108
Midnight



CRST 2102
White



*Please note that CRST 1102 white towel are friendly for sublimation printing, kindly contact CS for further information.



CRST 2100

Quick Dry Bath Towel

Material : Superfine fiber
Weight : 220 gsm
Highly absorbent
Anti-bacterial
Prevent Odour
Lightweight and soft
Compact design, Easy to pack
Fast-drying microfiber
Convenient and comfortable
Tear away label
Sizes : 29.5" x 55"
RRP : 32.90 MYR / 9.90 SGD



CROSSRUNNER[®]

NORTH HARBOUR®



NHT 1101
Soft White

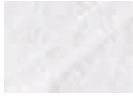

NHT 1102
Corn Silk



NHT 1103
Mint Cream



NHT 1104
Dust Blue



NHT 1105
Watermelon



NHT 1106
Light Brown



NHT 1107
Light Grey



NHT 1100 Soft Touch Hand Towel



Material: 100% Cotton
Weight: 80 gsm
Soft Touch hand feel
Ideal for a wide variety of uses
Striped border offers a touch of appeal
Exceptionally plush, rich and long lasting
Cozy comfort, durable and highly absorbent
Simplicity and elegance
Available in 7 colors.
Easy care, machine washable
Satin label
Size: 32cm x 70cm
RRP : 29.90 MYR / 11.90 SGD



NHT 2100

Soft Touch Spa Towel

Material: 100% Cotton
 Weight: 400 gsm
 Soft Touch hand feel
 Ideal for washroom ensemble
 Striped border offers a touch of appeal
 Exceptionally plush, rich and long lasting
 Cozy comfort, durable and highly absorbent
 Simplicity and elegance
 Available in 7 colors
 Easy care, machine washable
 Satin Label
 Size: 70cm x 140cm
 RRP : 49.90 MYR / 19.90 SGD



NHT 2101 Soft White NHT 2102 Corn Silk NHT 2103 Mint Cream NHT 2104 Dust Blue NHT 2105 Watermelon NHT 2106 Light Brown NHT 2107 Light Grey









NORTH HARBOUR®





NHA 1100 VICIOUS APRON

Material : 100% Polyester
 With practical pockets for small items
 The loop makes it easy to hang
 Strong seams for extra durability
 Simplicity and elegance
 High-grade materials & excellent workmanship
 Available in 6 colors.
 Easy care, machine washable
 Satin Label
 Size : 23.7" x 27.5"
 RRP : 29.90 MYR / 9.90 SGD

	NHA 1101 Black		NHA 1102 Navy
	NHA 1103 Red		NHA 1104 Royal
	NHA 1105 Forest Green		NHA 1106 Khaki

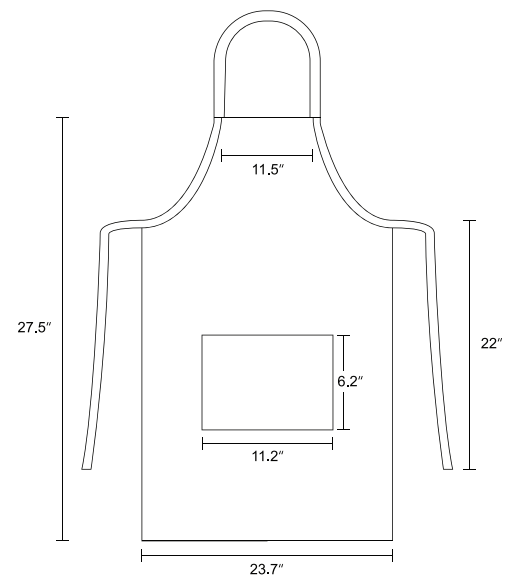



NHTB 1100

Emrys Canvas Tote Bag

Material : 100% Fully cotton
Thickness : 10 oz
Bottomless
Eco organic material
High-grade materials
Excellent workmanship
Simplicity and elegance
Strong seams for extra durability
Tear away label
Size : 14"(w) x 14.5"(h) - Raw
Size : 13"(w) x 14.5"(h) - Bleach
RRP : 19.90 MYR / 7.90 SGD





2 colors



NHTB 1101
Bleach



NHTB 1102
Raw



NORTH HARBOUR®

NORTH HARBOUR®





NHTB 2100

Emrys Canvas Tote Bag

Material : 100% Fully cotton
Thickness : 10 oz
Eco organic material
Self Fabric handles
High-grade materials
Excellent workmanship
Simplicity and elegance
Strong seams for extra durability
Perfect size for daily use
Tear away label
Size : 18"(w) x 16"(h)
Base : 12" (length) x 5.5" (bottom gusset)
RRP : 22.90 MYR / 8.90 SGD



2 colors



NHTB 2101
Bleach



NHTB 2102
Raw

WHILE STOCK LAST



FC 030
White / Red



FB 295
Sport Grey / Black



FS 036
Black / White



GI 346
Heather Aubergine



GJ 346
Heather Blue



ANV 234
Heather Red



ANV 036
Black

GILDAN 76700 - Adult 3/4 Sleeve T-shirt S - 2XL

ANVIL 6755 - 3/4 Sleeve Tee XS - XL

ANVIL 980 - Adult Tee S - XL



TTX 2401
Black



TTX 2403
Heather Red



32 C
Navy



30 N
White



295 H
RS Sport Grey



42 C
Charcoal



36 C
Black

TULTEX 240 - Ladies Tee LS - LL

GILDAN 63V00 - Adult V-Neck T-Shirt XS - 2XL



51C
Royal



26C
Sapphire



33C
Forest Green



30N
White



40C
Red



37C
Orange



98C
Daisy



30 N
White



40 C
Red

GILDAN 6800 - Adult Cotton Double Pique Sport Shirt XS - 3XL

GILDAN 83800 Polo XS - 2XL



71 C
Azalea



10 C
Heliconia



40 C
Red



26 C
Sapphire



81 C
Purple



12 C
Lime

GILDAN 73800L - Ladies Easy Care Polo LS - LXL



188C
Safety Green



774C
Sport Scarlet Red



765C
Sport Royal



276 C
Tweed



284 C
Lilac



277 C
Meadow



278 C
Blackberry

GILDAN 4B100 - Adult Performance Mesh T-Shirt XS - 2XL

GILDAN 18700 - Adult Vintage Full Zip Hooded Sweatshirt S - XL



NHB 1801
Gold / Royal



NHB 1802
Sapphire / White



NHB 1803
Red / Gravel



NHB 1804
Charcoal / Lime

NHB 1800 - Ladies Shirts S - XL



NHB 1902
Sapphire / White



NHB 1903
Red / Black



NHB 1904
Charcoal / White

NHB 1900 - Ladies Shirts S - 3XL



NHB 2602
Navy
White / Red



NHB 2603
Red
White / Black



NHB 2604
Royal
Charcoal / Navy



NHB 2605
Sapphire
Navy / White

NHB 2600 - Ladies Shirts S - XL



NHB 2101
Gold / Navy



NHB 2102
Red / White



NHB 2104
Navy / White

NHB 2100 - Ladies Polo S - 2XL



NHB 2303
Red
White / Black



NHB 2304
Royal
Charcoal / Navy



NHB 2305
Sapphire
Navy / White



NHB 2307
Forest Green
Charcoal / Black

NHB 2300 - Ladies Polo S - 2XL



NHB 2501
Navy / Sapphire



NHB 2502
Royal / Navy



NHB 2503
Red / Navy



NHB 2504
Black / Daisy

NHB 2500 - Ladies Polo S - XL

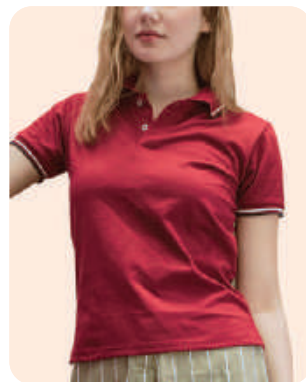

NHB 2704
Royal
White / Navy



NHB 2703
Sapphire
White / Navy

NHB 2700 - Ladies Polo S - XL



NHB 2802
Red / Charcoal



NHB 2803
Royal / Charcoal



NHB 2804
Navy / Charcoal



NHB 2805
Black / Light Blue

NHB 2800 - Ladies Polo S - XL

WHILE STOCK LAST

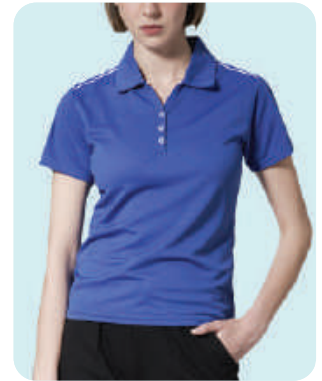
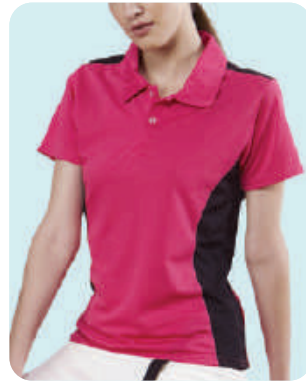
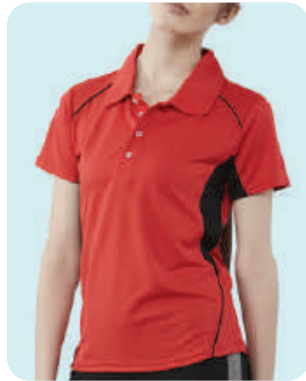

CRP 1101
Royal / White



CRP 1102
Charcoal / Royal



CRP 1301
Orange / Charcoal



CRP 1302
Red / Black



CRP 1401
Royal / Red



CRP 1402
Orange / Sapphire



CRP 2302
Red / Charcoal



CRP 2303
White / Black



CRP 1103
Red / Black



CRP 1104
Black / White



CRP 1304
Charcoal / Black



CRP 1305
Sapphire / Black



CRP 1403
Lime / White



CRP 1404
Heliconia / Black



CRP 2304
Sapphire / Charcoal



CRP 2305
Royal / White

CRP 1100L - Active Tee S - XL

CRP 1300L - Active Polo S - XL

CRP 1400L - Active Polo S - 2XL

CRP 2300L - Active Polo S - XL

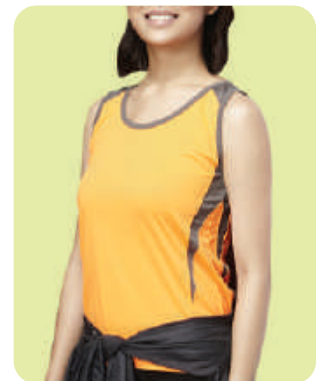
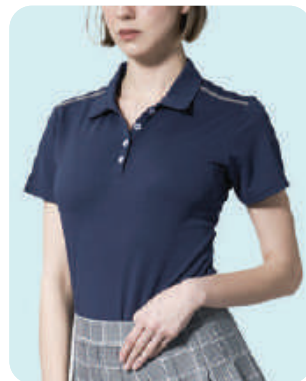

CRP 1203
Red / Black



CRP 1204
Royal / Charcoal



CRP 2401
Sapphire / Charcoal



CRP 2402
Orange / Charcoal



CRP 2505
Royal / Charcoal



CRP 2506
Jade Dome / Charcoal



CRV 1601
N. Orange / Charcoal



CRV 1604
N. Green / Black

CRP 1200L - Active Polo S - XL

CRP 2400L - Active Polo S - XL

CRP 2500L - Active Polo S - XL

CRV 1600L - Ladies Singlet S - XL



CRP 2901
Red / White



CRP 2902
Sapphire / White



CRR 1204
Neon Orange / Black



CRR 1205
Red / Black



CRR 1301
Navy / Red



CRR 1302
Black / White



CRR 1303
Sapphire / White



CRR 1701
Gold / Red



CRR 1702
Sapphire / Navy



CRR 1703
Royal / Navy



CRP 2903
Navy / White



CRP 2904
Black / White



CRR 1202
Black / White



CRR 1304
Neon Green / Black



CRR 1305
Jade Dome / Charcoal



CRR 1704
Black / Charcoal



CRR 1705
Royal / Red

CRP 2900L - Active Polo S - XL

CRR 1200L - Active Tee S - XL

CRR 1300L - Active Tee S - XL

CRR 1700L - Active Tee S - XL



CRV 1501
Sapphire / White



CRV 1502
Charcoal / Red



CRV 1303
Milo Green / Black



CRV 1304
Royal / Daisy



CRT 1101
Light Grey



CRT 1102
Daisy



CRV 1504
White / Sapphire

CRV 1300L - Ladies Singlet S - XL



CRT 1103
Red



CRT 1104
Navy

CRV 1300L - Ladies Singlet S - XL

CRT 1100J - Jacket XS - 2XL



SMW 1701
Heliconia / Navy



SMW 1702
Light Grey / Royal



SMW 1703
Daisy / Charcoal

SARRA SMW 1700 - Muslimah Wear S - XL

Decorating Techniques



DIRECT TO GARMENT

Utilizes specialized ink jet technology to print water-based CMYK+ white-ink directly on garments. Ideal for projects with short turnaround times. Works on both light and dark garments.

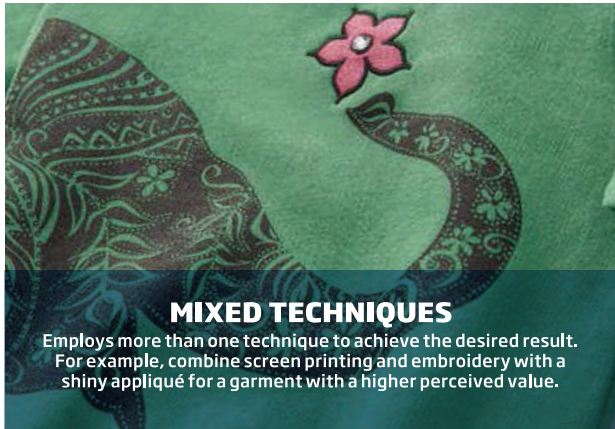

MIXED TECHNIQUES

Employs more than one technique to achieve the desired result. For example, combine screen printing and embroidery with a shiny appliqué for a garment with a higher perceived value.

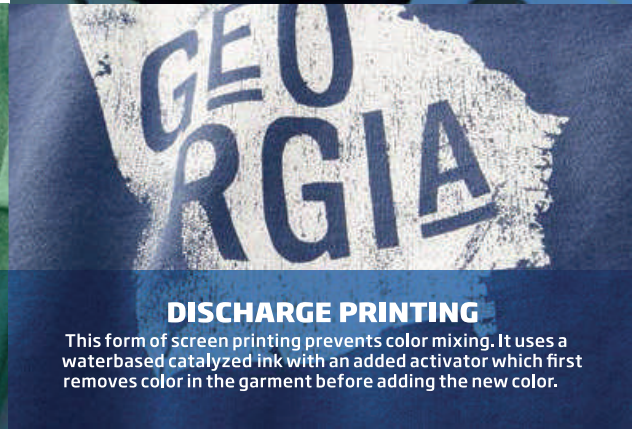

DISCHARGE PRINTING

This form of screen printing prevents color mixing. It uses a waterbased catalyzed ink with an added activator which first removes color in the garment before adding the new color.



HOT SPLIT TRANSFER PRINTING

Combines heat and pressure to transfer images to garments. Most of the ink melts into the fabric to create a softer, lighter feeling print. Great for customization and shorter runs.



HEAT TRANSFER

Heat transfer involves combining heat and pressure to transfer images to garments. This is a great option for detailed prints, customization, shorter runs and quick turnaround times.



REFLECTIVE PRINTING

Small glass beads in the carrier base of reflective inks cause any bright light to reflect off the print. This technique works best on larger print areas with simple designs.



APPLIQUÉ AND EMBROIDERY

Sewing a laser cut appliqué onto a garment and then embellishing it with embroidery adds dimension and detail to your garment. Ideal for heavier weight garments such as fleece.



EMBROIDERY

Embroidery is sewing a design, type or logo onto a garment with special thread. It gives garments a higher perceived value and works very well on fleece and heavier weight garments.

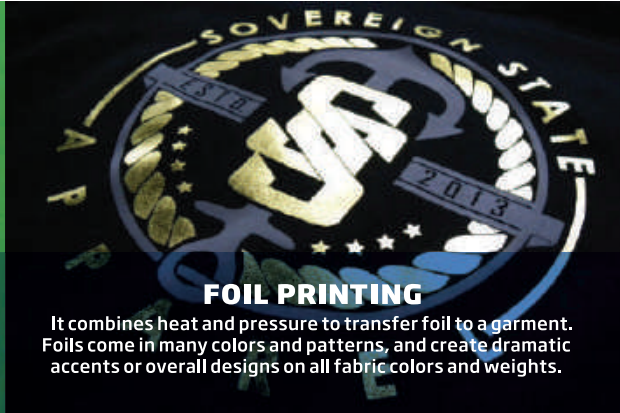

FOIL PRINTING

It combines heat and pressure to transfer foil to a garment. Foils come in many colors and patterns, and create dramatic accents or overall designs on all fabric colors and weights.



SCREEN PRINT

A technique that uses stencils and ink to create designs on garments. It is the most economical method for producing large quantities that involve cotton or cotton-blend garments.



SUBLIMATION

This process utilizes heat-sensitive inks to create long-lasting, full-color, photo-quality reproductions of digital images. Sublimation is well suited for 100% polyester garments.



PUFF PRINT LETTERING

A method for creating a 3D design by screen printing with an ink containing a unique foaming agent or puff additive that expands when heated. Ideal for simple designs.



GLITTER PRINTING

A special clear glitter topcoat is screen printed on top of the colored design to add shine and impact to your design. This technique can work on all colors and weights of fabrics.



DISTRESSED AND CLEAR INK

Distressed printing gives screen prints an intentionally weathered look. Clear inks can be used to add a glossy shine or dimension to a design.



NEON COLORS

Using this two-step screen printing process helps you achieve the brightest possible color on a garment. It works by printing transparent neon inks on top of a white opaque base.

POLOS

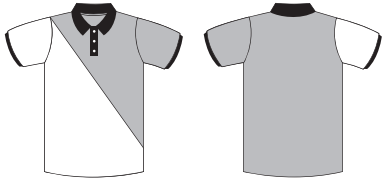

NHB 2100 - Georgia Polo



NHB 2200 - York Polo

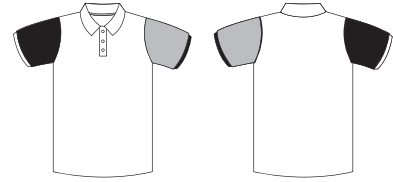

NHB 2300 - Murphy Polo

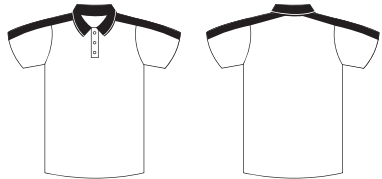

NHB 2500 - Muller Polo

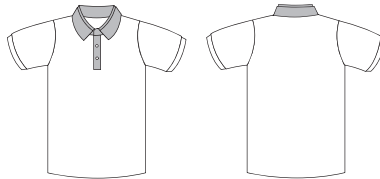

NHB 2800 - Glance Polo

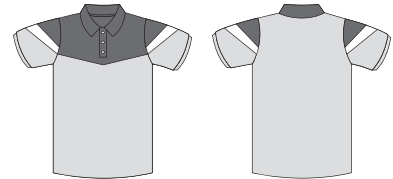

NHB 2900 - Adley Polo

PREMIUM WORKWEAR

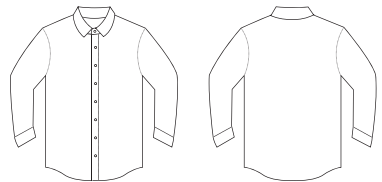

NHB 1400 - Premium Oxford

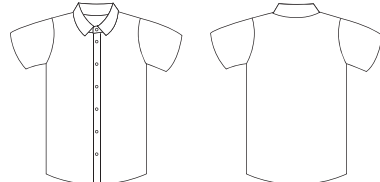

NHB 1500 - Oxford Short Sleeve

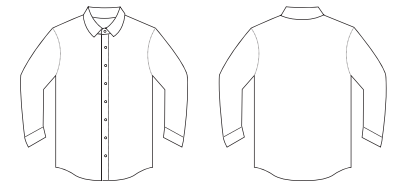

NHB 2000 - Cotton Rayon Shirt

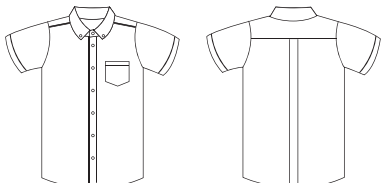

NHB 1700 - Synergy Racewear

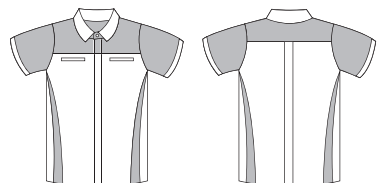

NHB 1800 - Impact Racewear

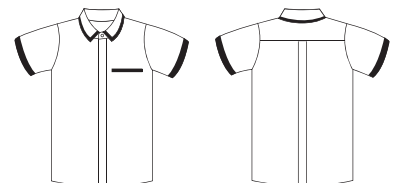

NHB 1900 - Smart Racewear

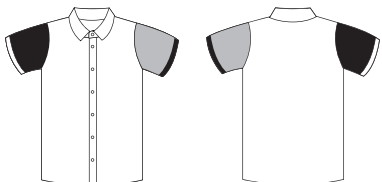

NHB 2600 - Murphy Racewear

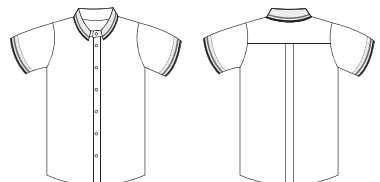

NHB 3000 - Cyril Shirt

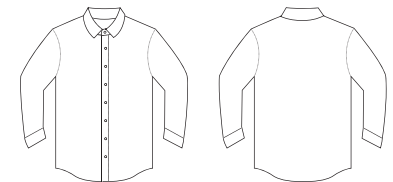

NHB 3100 - Virgil Shirt

ACTIVEWEAR

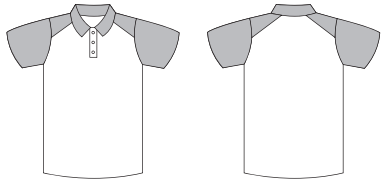

CRP 2100 - Infinite Polo

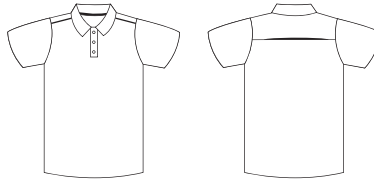

CRP 2300 - Oxley Polo

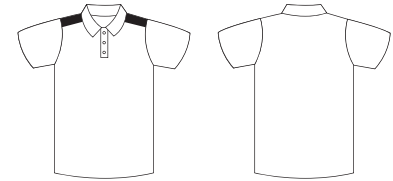

CRP 2400 - Henderson Polo

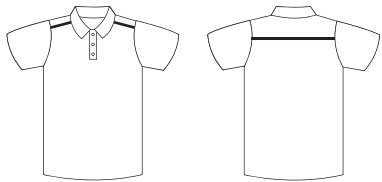

CRP 2500 - Ocean Polo

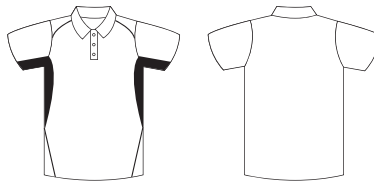

CRP 1300 - Delta Polo

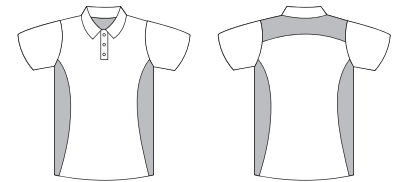

CRP 1400 - Explorer Polo

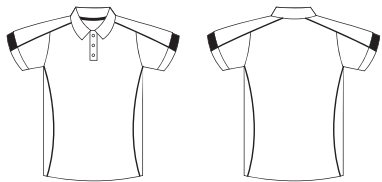

CRP 1500 - Finisher Polo

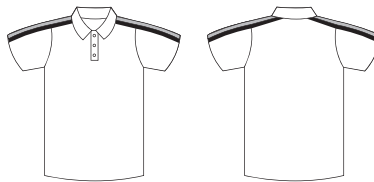

CRP 1600 - Racer Polo

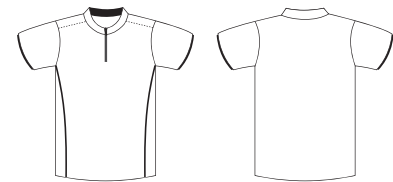

CRP 2900 - Paragon Polo

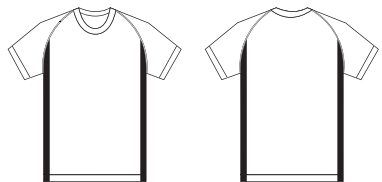

CRR 1100 - Storm Tee

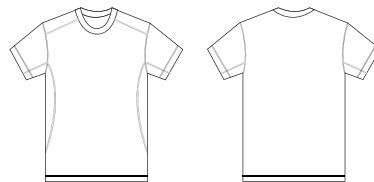

CRR 1200 - Velocity Tee

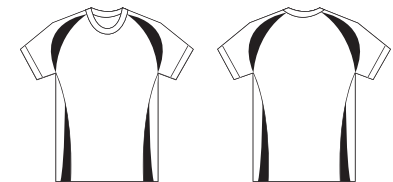

CRR 1300 - Zen Tee



CRV 1600 - Flex Running Vest



CRT 1200 J - Neil Track Jacket

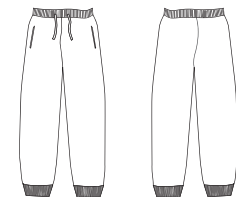

CRT 1100 P - Zeal Active Trackpants

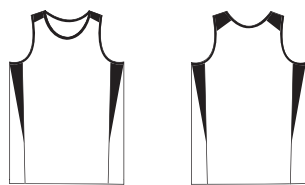

CRB 1100 - Vanguard Basketball Suit (Tops & Bottoms)

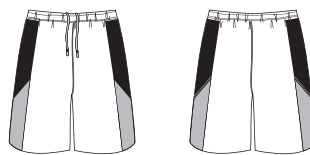

SUBLIMATION

UNLEASH YOUR IMAGINATION



ARTISTIC

BY CROSSRUNNER



BUYER'S GUIDE 衣單

COLLECTIONS OF YEAR 2023-2025

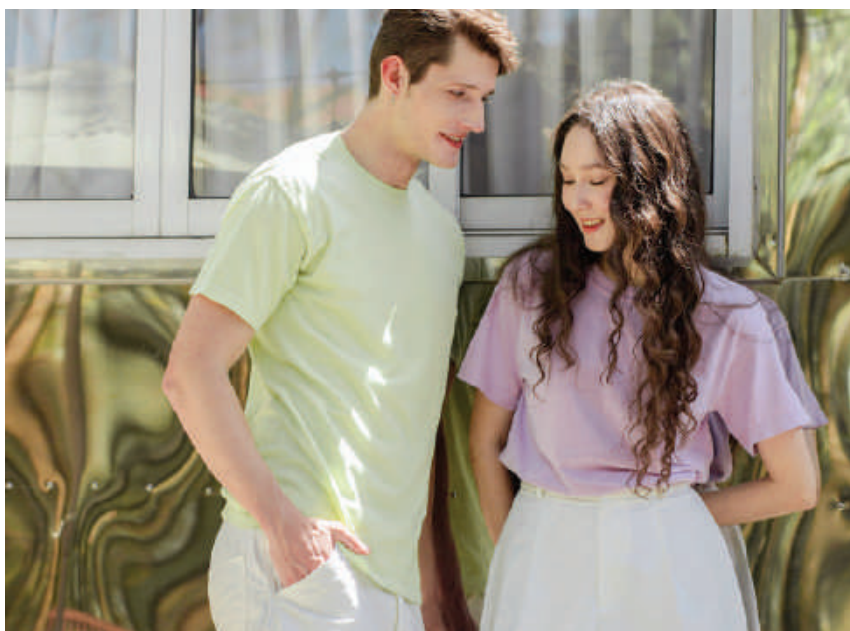

Timeless Pieces

It can be difficult to articulate the power of style and fashion through words, but these icons managed to do so with quote-worthy, Inspiring words of wisdom to live by

Being well dressed hasn't much to do with having good clothes. It's a question of good balance and good common sense