

# MIAND<sup>®</sup>

## PRODUCT CATALOGUE

---



MADE IN MALAYSIA

**BORNEO**

Since 1856

**Borneo Technical Co. (M) Sdn Bhd**  
A Member of Solid Automotive Berhad

# ELECTRIC FANS & WIRING ACCESSORIES

# CONTENT

## PAGE MQ SERIES

- 01 Flush Switches
- 02 Socket Outlets
- 03 Telecommunication Accessories
- 04 Telecommunication Accessories/  
Dimmers

## PAGE 2K SERIES

- 05 Flush Switches
- 06 Socket Outlets
- 07 Telecommunication Accessories
- 08 Dimmers
- 09 Industrial Wiring Accessories
- 10 Isolators / Plug Tops
- 11 Trailing Sockets
- 12 Multiways and Integrated change to Adaptors

## PAGE FAN SERIES

- 13 Ventilating Fans
- 14 16" Auto Fan
- 15 16" Wall Fan
- 16 16" Wall Fan
- 17 20" Wall Fan
- 18 60" Ceiling Fan



## PRODUCT CERTIFICATION :



MADE IN MALAYSIA

Certified "MADE IN MALAYSIA"  
Products



Standards and Industrial Research  
Institute of Malaysia (SIRIM)



Suruhanjaya Tenaga  
Energy Commission

Energy Commission of Malaysia  
(Suruhanjaya Tenaga)



Public Works Department of Malaysia  
(Jabatan Kerja Raya)

Conformity testing and Certification of Electrotechnical  
Equipment and Component (Known as CB Scheme)



**MIND**



## Unbreakable

UV protected for color consistency even **under direct sunlight**

Heat resistant, impact resistant & corrosion resistant **polycarbonate**

**Fire resistant** up to 650°C

**RoHS** compliant

### Nylon

- Fire retardant up to 850°C

### Contact Point

- Copper with selective silver plated
- Increased electrical conductivity & lifespan
- Superior heat & arc resistance

### Phosphorous Bronze L/N/E Pin Clips

- Tested up to 30,000 times plug insertion & withdrawal
- Designed for more than a decade of usage

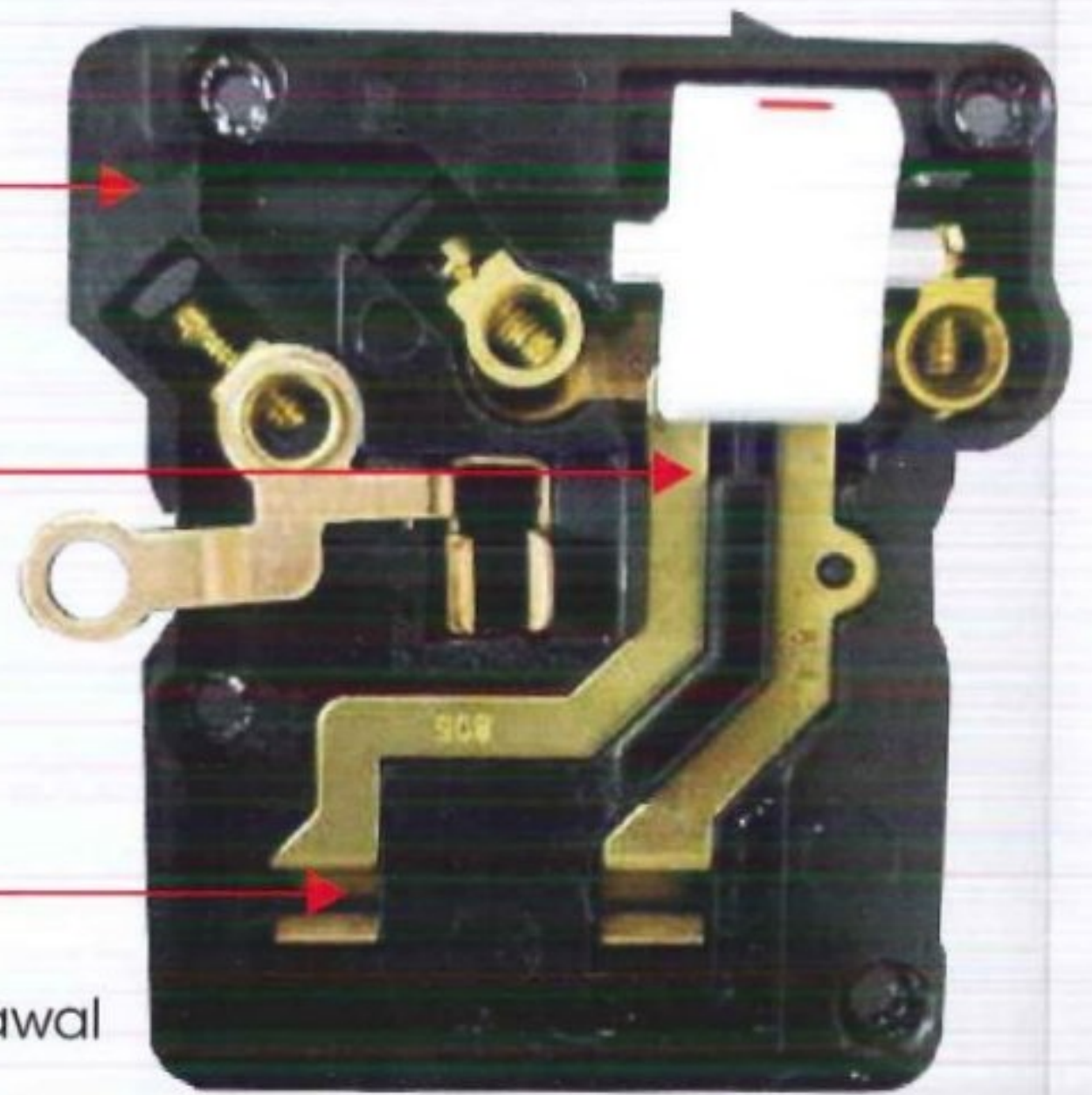

Fire Retardant Materials



Heavy Duty Materials



Ultraviolet (UV) Protection



Made in Malaysia



ISO Certified



Environmentally Friendly



Low Toxicity



Quality Assurance



Minimum Chemical Emissions



RoHS Compliant

**MAND**

# MQ SERIES

## Flush Switches

Compliance: IEC60669-1



CODE	DESCRIPTION	RATING	INNER BOX (pcs)	CARTON (pcs)
------	-------------	--------	-----------------	--------------

	MQ8101 (1W)	1 Gang 1 Way Flush Mounted Switch	10AX 250V~	10	100
	MQ8101 (2W)	1 Gang 2 Way Flush Mounted Switch	10AX 250V~	10	100
	MQ8101 (INT)	1 Gang Intermediate Flush Mounted Switch	16AX 250V~	10	100
	MQ 8102 (1W)	2 Gang 1 Way Flush Mounted Switch	10AX 250V~	10	100
	MQ 8102 (2W)	2 Gang 2 Way Flush Mounted Switch	10AX 250V~	10	100
	MQ 8103 (1W)	3 Gang 1 Way Flush Mounted Switch	10AX 250V~	10	100
	MQ 8103 (2W)	3 Gang 2 Way Flush Mounted Switch	10AX 250V~	10	100
	MQ 8104 (1W)	4 Gang 1 Way Flush Mounted Switch	10AX 250V~	10	100
	MQ 8104 (2W)	4 Gang 2 Way Flush Mounted Switch	10AX 250V~	10	100
	MQ 8101 (20A)	20A Double Pole Flush Mounted Switch	20A 250V~	10	100
	MQ8101 BELL	1 Gang Bell Flush Mounted Switch	10AX 250V~	10	100
	MQ 8102 BELL	2 Gang Bell Flush Mounted Switch (Auto Gate)	10AX 250V~	10	100

# MQ SERIES

## Socket Outlets

Compliance: MS589-2, MS1577, BS1363-2, BS546, SS145-2 & SS472

CODE	DESCRIPTION	RATING	INNER BOX (pcs)	CARTON (pcs)
 MQ 8131	1 Gang Flush Mounted Switched Socket Outlet	13A 250V~	10	100
 MQ 8131DP	1 Gang Double Pole Flush Mounted Switched Socket Outlet	13A 250V~	10	100
 MQ 8131N	1 Gang Flush Mounted Switched Socket Outlet with Neon	13A 250V~	10	100
 MQ 8131DP (With Neon)	1 Gang Double Pole Flush Mounted Switched Socket Outlet with Neon	13A 250V~	10	100
 MQ 8132	2 Gang Flush Mounted Switched Socket Outlet	13A 250V~	8	80
 MQ 8132DP	2 Gang Double Pole Flush Mounted Switched Socket Outlet	13A 250V~	8	80
 MQ 8132N	2 Gang Flush Mounted Switched Socket Outlet with Neon	13A 250V~	8	80
 MQ 8132DP (With Neon)	2 Gang Double Pole Flush Mounted Switched Socket Outlet with Neon	13A 250V~	8	80
 MQ 8151	1 Gang Flush Mounting Switched Socket Outlet	15A 250V~	10	100
 MQ 8151N	1 Gang Flush Mounting Switched Socket Outlet with Indicator Lamp (Neon)	15A 250V~	10	100
MQ 8131U	1 Gang Universal Flush Mounted Switched Socket Outlet	10A 250V~	10	100
MQ 8131U-USB	1 Gang Universal Flush Mounted Switched Socket Outlet with USB Charging Port	13A 250V~	8	80

# MQ SERIES

Telecommunication Accessories

Method of Application: Flush Mounted

CODE	DESCRIPTION	INNER BOX (pcs)	CARTON (pcs)
 MQ 8101-TV	Single Coaxial TV Outlet	10	100
 MQ 8102-TV	Double Coaxial TV Outlet	10	100
 MQ 8101-SAT	Cable TV Outlet (Astro)	10	100
 MQ 8102-TV-SAT	Single Coaxial TV & Cable TV Outlet	10	100
 MQ 8101-TEL	Single RJ11 Cat 3 Telephone Outlet	10	100
 MQ 8102-TEL	Double RJ11 Cat 3 Telephone Outlet	10	100
 MQ 8102-TEL-COM	Single RJ11 Cat 3 Telephone Outlet & RJ45 Cat 5E Data Outlet	10	100

# MQ SERIES

Telecommunication Accessories

Method of Application: Flush Mounted

CODE	DESCRIPTION	INNER BOX (pcs)	CARTON (pcs)
 MQ 8101-COM	Single 8 Core RJ45 Cat. 5E Data Outlet	10	100
 MQ8102-COM	Double 8 Core RJ45 Cat.5E Data Outlet	10	100
 MQ8101-CAT6	Single Category 6 Data Outlet	10	100
 MQ8102-CAT6	Double Category 6 Data Outlet	10	100
 MQ8101 USB2.4A	Single USB Power Charging Outlet (2.4A)	6	60
 MQ8102 USB2.4A	Double USB Power Charging Outlet (2.4A + 2.4A) ***Input: 240Va.c., 50/60Hz, 450mA Output: 5Vd.c., 2.4A	6	60









## Dimmers

CODE	DESCRIPTION	RATING	INNER BOX (pcs)	CARTON (pcs)
 MQ8500D	Flush Type 500W Dimmer Switch	500W 250V~	6	60
<i>For Project Usage</i>				
 MQ8131DP (Y/R)	1 Gang Double Pole Flush Mounted Switched Socket Outlet with Yellow Rocker	13A 250V~	10	100
 MQ8131DP (R/R)	1 Gang Double Pole Flush Mounted Switched Socket Outlet with Red Rocker	13A 250V~	10	100

# 2K SERIES

## FLUSH SWITCHES





Compliance: IEC60669-1

CODE	DESCRIPTION	RATING	INNER BOX (pcs)	CARTON (pcs)
 2K101 (1W)	1 Gang 1 Way Flush Mounting Switch	10AX 250V~	10	100
2K101 (2W)	1 Gang 2 Way Flush Mounting Switch	10AX 250V~	10	100
2K101 (INT)	1 Gang Intermediate Flush Mounting Switch	10AX 250V~	10	100
 2K102 (1W)	2 Gang 1 Way Flush Mounting Switch	10AX 250V~	10	100
2K102 (2W)	2 Gang 2 Way Flush Mounting Switch	10AX 250V~	10	100
 2K103 (1W)	3 Gang 1 Way Flush Mounting Switch	10AX 250V~	10	100
2K103 (2W)	3 Gang 2 Way Flush Mounting Switch	10AX 250V~	10	100
 2K104 (1W)	4 Gang 1 Way Flush Mounting Switch	10AX 250V~	10	100
2K104 (2W)	4 Gang 2 Way Flush Mounting Switch	10AX 250V~	10	100
 2K105 (1W)	5 Gang 1 Way Flush Mounting Switch	10AX 250V~	10	100
2K105 (2W)	5 Gang 2 Way Flush Mounting Switch	10AX 250V~	10	100
 2K102 (20A)	Double Pole Flush Mounting With Neon Switch	20A 250V~	10	100
 2K101 BELL	1 Gang Bell Flush Mounting Switch	10AX 250V~	10	100
 2K102 BELL	2 Gang Bell Flush Mounting Switch (Auto Gate)	10AX 250V~	10	100

# 2K SERIES SOCKET OUTLETS

Compliance: MS589-2, MS1577, BS1363-2, BS546, SS145-2 & SS472

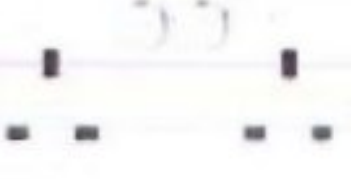
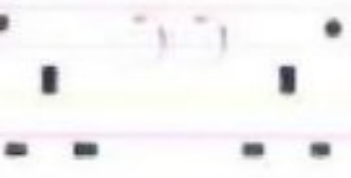

CODE	DESCRIPTION	RATING	INNER BOX (pcs)	CARTON (pcs)
 2K131	1 Gang Flush Mounting Switched Socket Outlet	13A 250V~	10	100
 2K131 (NEON)	1 Gang Flush Mounting Switched Socket Outlet with Neon	13A 250V~	10	100
 2K132	2 Gang Flush Mounting Switched Socket Outlet	13A 250V~	5	50
 2K132 (NEON)	2 Gang Flush Mounting Switched Socket Outlet with Neon	13A 250V~	5	50
 2K151	1 Gang Flush Mounting Switched Socket Outlet	15A 250V~	10	100
 2K151N	1 Gang Flush Mounting Switched Socket Outlet With Indicator Lamp (Neon)	15A 250V~	10	100



**MAND**

**MAND**

# 2K SERIES

TELECOMMUNICATION ACCESSORIES



Method of Application: Flush Mounted

	CODE	DESCRIPTION	INNER BOX (pcs)	CARTON (pcs)
	2K101 (TEL)	Single RJ11 Cat 3 Telephone Outlet	10	100
	2K101 (SAT)	Single Cable TV Outlet (Astro)	10	100
	2K101 (TV)	Single Coaxial TV Outlet	10	100
	2K102 (TV-S)	Single Coaxial TV & Cable TV Outlet	10	100
	2K101 (COM)	Single RJ45 Cat 5E Data Outlet	10	100
	2K101 (CAT 6)	Single Category 6 Data Outlet	10	100
	2K101 USB2.4A	Single USB Power Charging Outlet (2.4A)	6	60
	2K102 USB2.4A	2 Gang USB Module ***Input: 240V a.c., 50/60Hz, 450mA Output: 5 Vd.c., 2.4A	6	60

# 2K SERIES

## DIMMERS



CODE	DESCRIPTION	RATING	INNER BOX (pcs)	CARTON (pcs)
 2K163 (630W)	Flush Type 630W Dimmer Control	630W 250V~	6	60
 2K102 (D500)	Flush Type 500VA Light Dimmer	250V 2A 500VA A.C.	1	50
<b>For Project Usage</b>				
 2K101 (1W) (Y/C-R/R)	1 Gang 1 Way Flush Mounting Switch (Yellow Cover & Red Rocker)	10AX 250V~	10	100
 2K101 (1W) (R/C-R/R)	1 Gang 1 Way Flush Mounting Switch (Red Cover & Red Rocker)	10AX250V~	10	100
 2K131 (Y/C-R/R)	1 Gang Flush Mounting Switched Socket Outlet (Yellow Cover & Red Rocker)	13A 250V~	10	100
 2K131 (R/C-R/R)	1 Gang Flush Mounting Switched Socket Outlet (Red Cover & Red Rocker)	13A 250V~	10	100
 2k131DP	1 Gang Double Pole Flush Mounting Switched Socket Outlet (Available in Yellow / Red Rocker)	13A 250V~	10	100

# 2K SERIES

INDUSTRIAL WIRING ACCESSORIES

Compliance: MS589-2, MS1577, BS1363-2, BS546, SS145-2, SS472 & IEC60669-1



CODE	DESCRIPTION	RATING	INNER BOX (pcs)	CARTON (pcs)
 2K731	1 Gang Metalclad Surface Mounting Switched Socket Outlet	13A 250V~	5	100
 2K732	2 Gang Metalclad Surface Mounting Switched Socket Outlet	13A 250V~	5	50
 2K751	1 Gang Metalclad Switched Socket Outlet	15A 250V~	5	100
 2K701 (1W)	1 Gang 1 Way Metalclad Surface-Type Switch	10AX 250V~	5	100
 2K701 (2W)	1 Gang 2 Way Metalclad Surface-Type Switch	10AX 250V~	5	100
 2K701 (INT)	1 Gang Intermediate Metalcold Surface type switch.	10AX 250V~	5	100
 2K702 (1W)	2 Gang 1 Way Metalclad Surface-Type Switch	10AX 250V~	5	100
 2K702 (2W)	2 Gang 2 Way Metalclad Surface-Type Switch	10AX 250V~	5	100
 2K703 (1W)	3 Gang 1 Way Metalclad Surface-Type Switch	10AX 250V~	5	100
 2K704 (1W)	4 Gang 1 Way Metalclad Surface-Type Switch	10AX 250V~	5	100
 2K705 (1W)	5 Gang 1 Way Metalclad Surface-Type Switch	10AX 250V~	5	100
 2K702 (20A)	Double Pole Metalclad Surface-Type With Neon Switch	20A 250V~	5	100
 2K701 BELL	1 Gang Metalclad Surface-Type Bell Switch	10AX 250V~	5	100

# 2K SERIES

INDUSTRIAL WIRING ACCESSORIES

Compliance: MS589-2, MS1577, BS1363-2, BS546, SS145-2, SS472 & IEC60669-1

## ISOLATORS

Compliance: MS589-3, MS1144, MS1579, BS1363-3, BS5733, SS145-2, SS246

CODE

DESCRIPTION

INNER BOX  
(pcs)

CARTON  
(pcs)

WM-320 3 Pole / 20A Isolator Switch

1

30

WM-332 3 Pole / 32A Isolator Switch

1

30

WM-363 3 Pole / 63A Isolator Switch

1

30

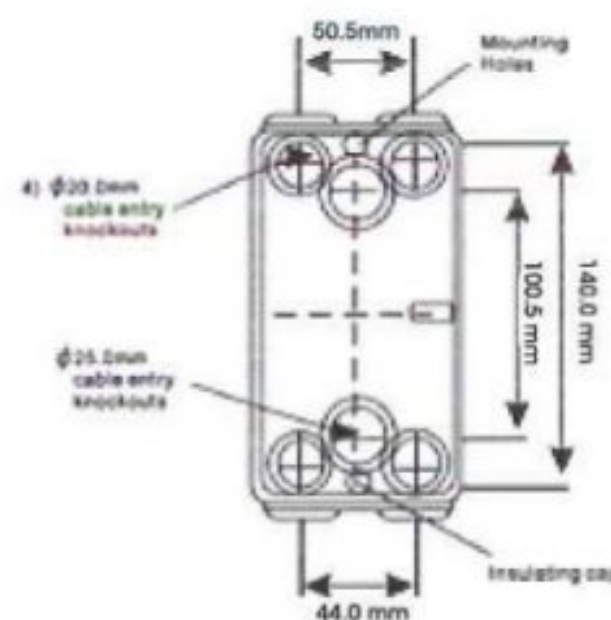
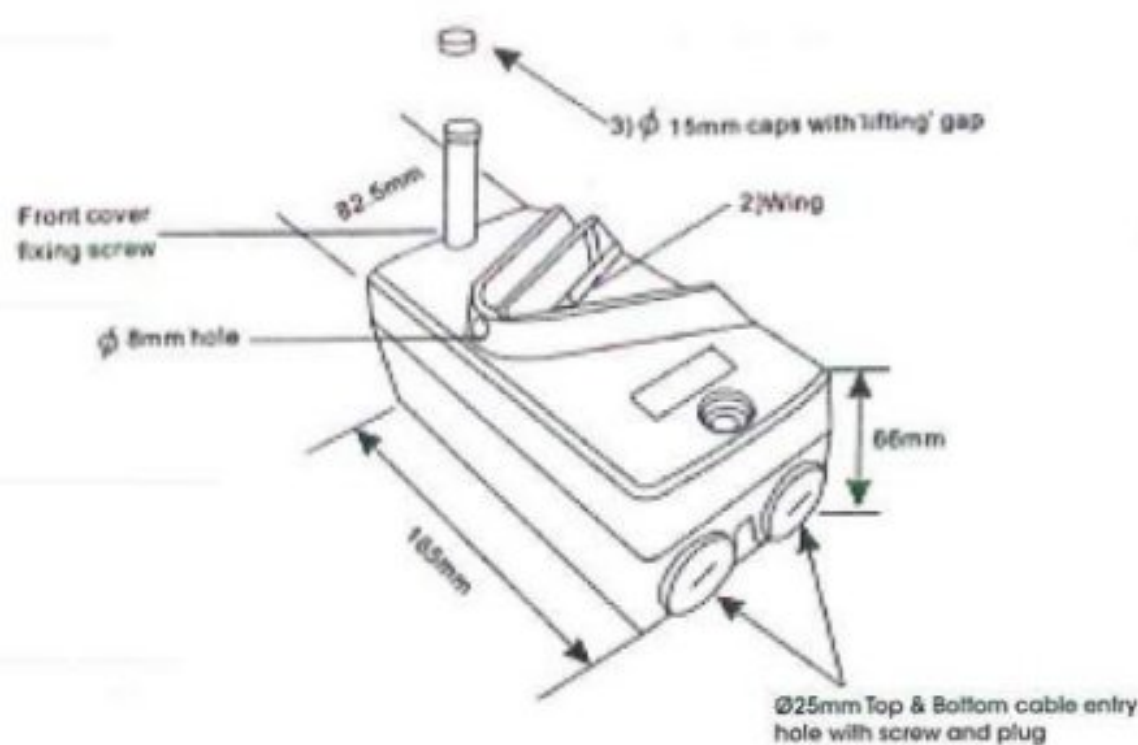

## PLUG TOPS

Compliance: MS589-1, MS1577, BS1363-1, BS546, SS145-1 & SS472



CODE

DESCRIPTION

INNER BOX  
(pcs)

CARTON  
(pcs)

2881 13A Rewireable Fused Plug

20

500

MA18 13A Rewireable Fused Plug

20

500

MA15 15A Rewireable Plug

20

200

**MAND**

# ADAPTORS

Compliance: MS589-3, MS1144, MS1579, BS1363-3, BS5733, SS145-2, SS246

CODE	DESCRIPTION	RATING	BLISTER PACK	CARTON (pcs)
------	-------------	--------	--------------	--------------



SA-32

3 Way Multi-Adaptor with LED Switch & 13A Fuse

13A 250V~ 3250W

1

60



MA-8322(S)

8 Way T-Type Multi-Adaptor with Surge Protector

13A 250V~ 3250W

1

24

# TRAILING SOCKETS

Compliance: MS589-2, BS1363-2, SS145-2

CODE	DESCRIPTION	RATING	BLISTER PACK	CARTON (pcs)
------	-------------	--------	--------------	--------------



MA-1183

3 Gang Trailing Socket with Neon Switches (2M/5M)

13A 250V~ 3250W

1

21

MA-1184

4 Gang Trailing Socket with Neon Switches (2M/5M)

13A 250V~ 3250W

1

21

MA-1185

5 Gang Trailing Socket with Neon Switches (2M/5M)

13A 250V~ 3250W

1

21

**MAND**







**MAND**

# ADAPTORS

Compliance: MS589-3, MS1144, MS1579, BS1363-3, BS5733, SS145-2, SS246

## OTHER ACCESSORIES

	CODE	DESCRIPTION	RATING	INNER BOX (pcs)	CARTON (pcs)
	MH-202	Pendent Lamp Holder (Socket Type B22)	2A 250V~	48	480
	MH-203	Wedge Holder (Socket Type B22)	2A 250V~	40	400
	MH-204	Lamp Holder (Screw Type E27)	4A 250V~	30	300
	MH-205	Lamp Holder (Screw Type E27)	4A 250V~	12	120
	ME-100	Weatherproof Socket Cover	-	1	48



# WALL MOUNTED EXHAUST FANS

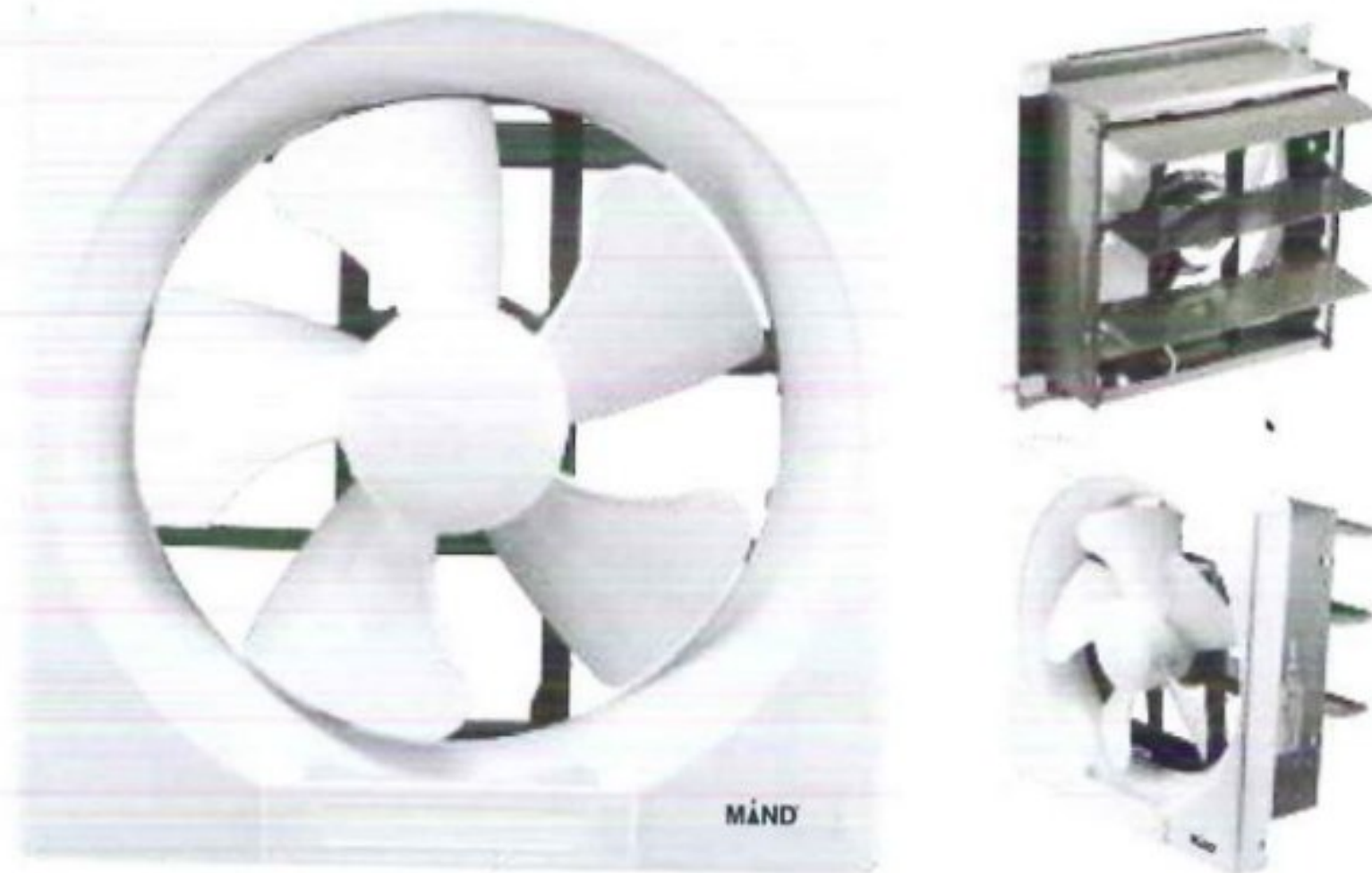

**MD-8VB**

**MD-10VB**

**MD-12VB**

**Specifications**

Fan Size	8 Inch / 200mm	10 Inch / 250mm	12 Inch / 300mm
Voltage Rating	220-240V~	220-240V~	220-240V~
Frequency	50Hz	50Hz	50Hz
Power	35W	40W	50W
Fan Speed	1300 rpm	1200 rpm	1200 rpm
Air Flow	320 CFM	490 CFM	580 CFM
Safety Standard	MS IEC 60335-1 : 2015 MS 1597 : Part 2-80 : 2010		

**Features**

- ✓ Fan Motor is made of Pure Copper Coil
- ✓ Equipped with Double Ball-Bearing for Durable Operation
- ✓ Metal Back Shutter
- ✓ Low Noise Operation
- ✓ Approved by SIRIM, Suruhanjaya Tenaga, JKR EMAL & IEC Certified

**Dimensions**

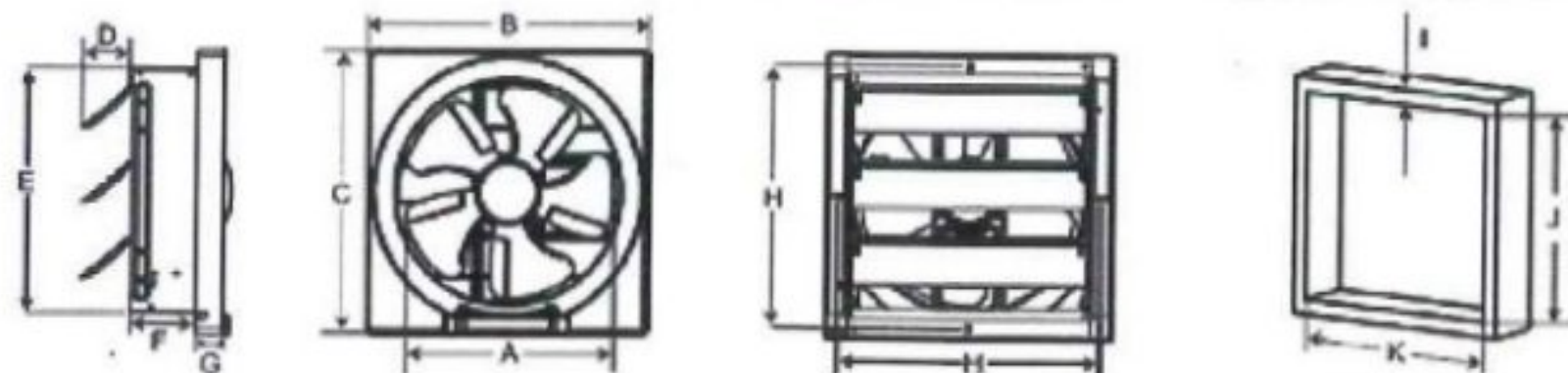

Model No.	A	B	C	D	E	F	G	H	I	J x K
MQ-8VS	200	300	300	52	240.6	90	46	264.8	25	250 x 250
MQ-10VS	250	348	353	55	290.6	90	39.5	313.8	25	300 x 300
MQ-12VS	300	400	400	75	340.6	90	40	363.8	25	350 x 350

\*unit in mm



CERTIFIED TO : MS IEC 60335-1 : 2015  
MS 1597 : PART 2-80 : 2010  
CERTIFICATION NO : PC000644



**MAND**

# 16" AUTO FAN

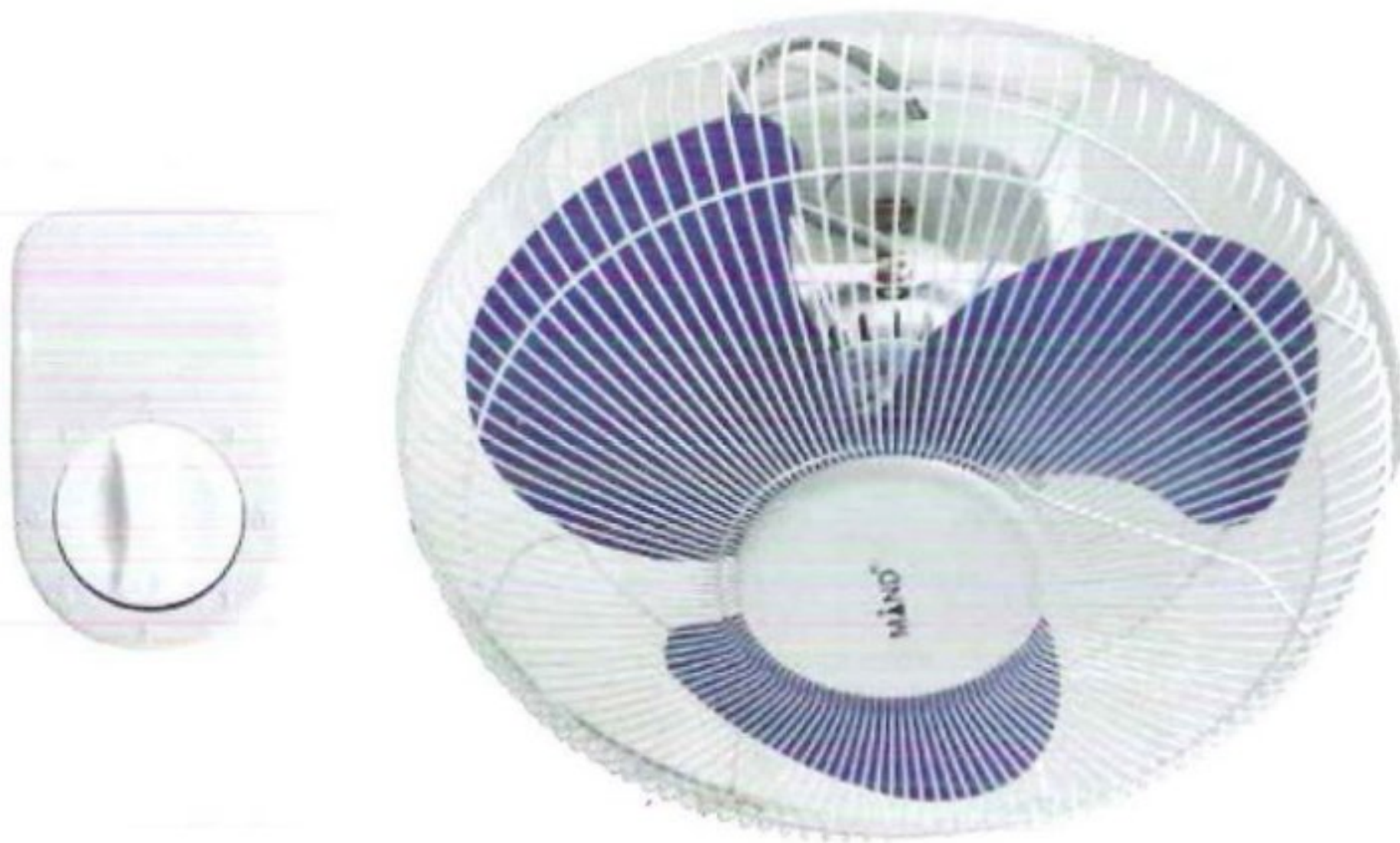

## AF16 (MD-16A)

### Specifications

Voltage Rating	220-240V~
Frequency	50 Hz
Power	55 Watts
Fan Speed	1140 ~ 1260 RPM
Air Velocity	6.0 ~ 6.7 m/s
Safety Standards	MS IEC 60335-1 : 2015 MS 1597 : PART 2 - 80 : 2010 MS 1220 : 2010

### Features

✓ 3-Metal Blade for Powerful Air Delivery
✓ Pure Copper Motor with Double Ball Bearing for Durable Operation
✓ 3 Speed Regulator
✓ 360 Degree Oscillation Function
✓ Built-in Safety Thermal Fuse
✓ Certified by 5 Star Energy Saving Rating by Suruhanjaya Tenaga
✓ Approved by SIRIM, Suruhanjaya Tenaga, JKR EMAL & IEC Certified

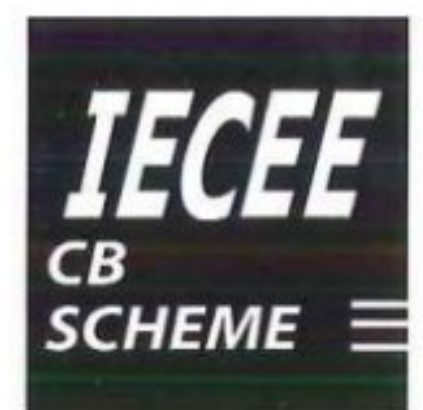

CERTIFIED TO : MS IEC 60335-1 : 2015  
MS 1597 : PART 2-80 : 2010  
MS 1220 : 2010  
CERTIFICATION NO : PC000828



**MAND**

# 16" WALL FAN



CERTIFIED TO : MS IEC 60335-1 : 2015  
MS 1597 : PART 2-80 : 2010  
MS 1220 : 2010  
CERTIFICATION NO : PC000566

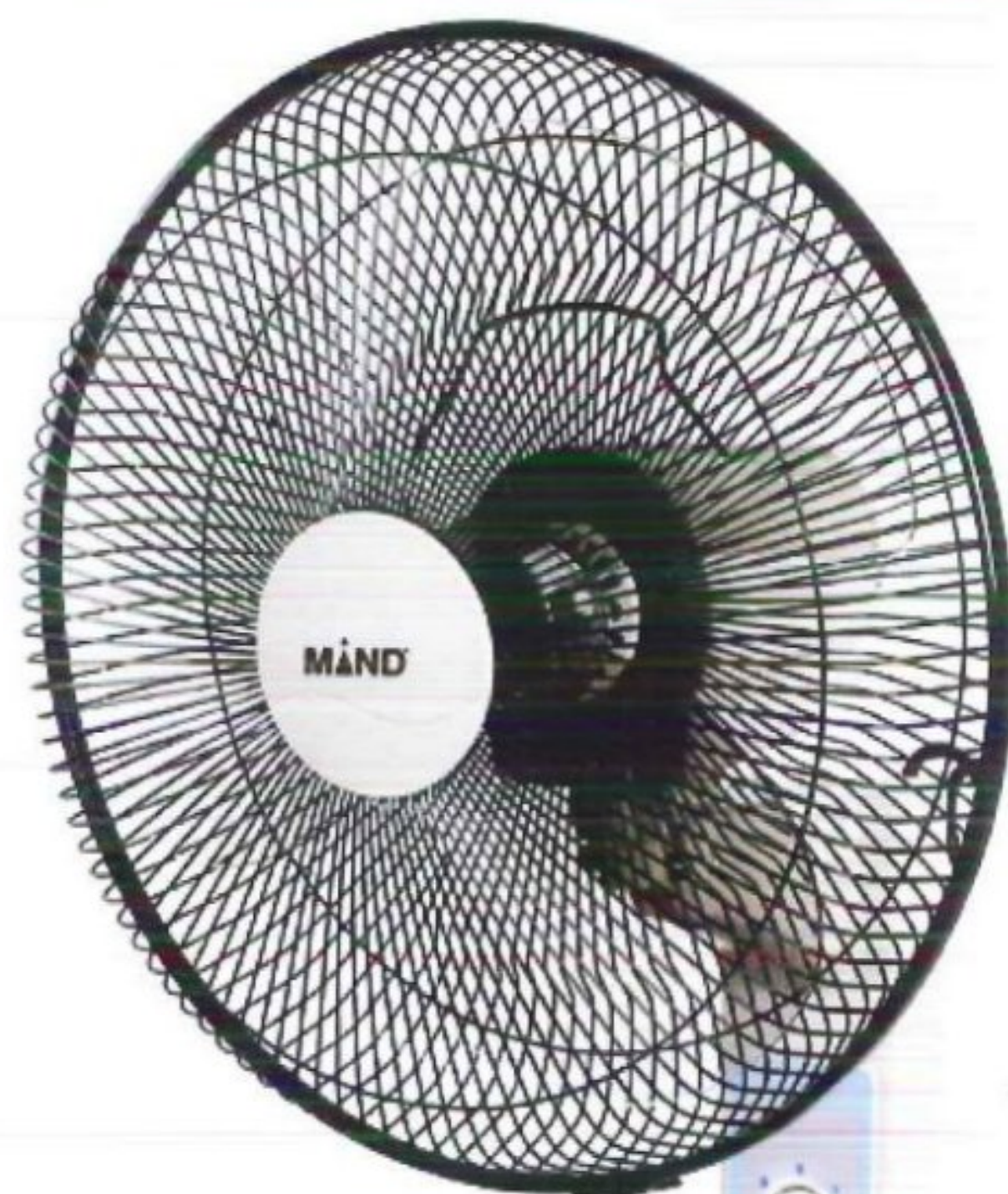

## WF16 (MD-16W)

### Specifications

Voltage Rating	220-240V~
Frequency	50 - 60Hz
Power	55 Watts
Fan Speed	1035 ~ 1265 RPM
Air Velocity	6.2 ~ 6.8 m/s
Safety Standards	MS IEC 60335-1 : 2015 MS 1597:PART 2-80:2010 MS 1220 : 2010

### Features

- ✓ 3-AS Blade for Powerful Air Delivery
- ✓ Pure Copper Motor with Double Ball Bearing for Durable Operation
- ✓ 3 Speed Control
- ✓ Oscillation Function
- ✓ Built-in Safety Thermal Fuse
- ✓ Certified by 5 Star Energy Saving Rating by Suruhanjaya Tenaga
- ✓ Approved by SIRIM, Suruhanjaya Tenaga, JKR EMAL & IEC Certified

**MAND**

# 16" WALL FAN



CERTIFIED TO: MS IEC 60335-1:2015  
MS 1597:PART 2-80:2010  
MS 1220:2010  
CERTIFICATION NO: PC000566



## MD-P316W

### Specifications

Voltage Rating	220-240V~
Frequency	50 - 60Hz
Power	60 Watts
Fan Speed	870 ~ 1100 RPM
Air Velocity	5.0 ~ 6.2 m/s
Safety Standards	MS IEC 60335-1 : 2015 MS 1597:PART 2-80:2010 MS 1220 : 2010

### Features

- ✓ 5-PP Blade for Powerful Air Delivery
- ✓ Pure Copper Motor for Durable Operation
- ✓ 3 Speed Control
- ✓ Oscillation Function
- ✓ Built-in Safety Thermal Fuse
- ✓ Certified by 5 Star Energy Saving Rating by Suruhanjaya Tenaga
- ✓ Approved by SIRIM, Suruhanjaya Tenaga, & IEC Certified

**MAND**

# 20" WALL FAN

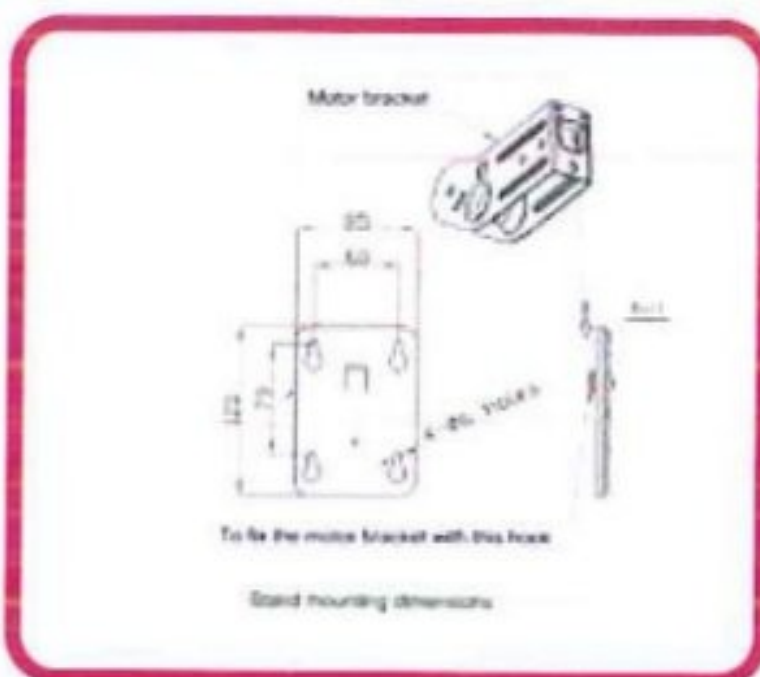
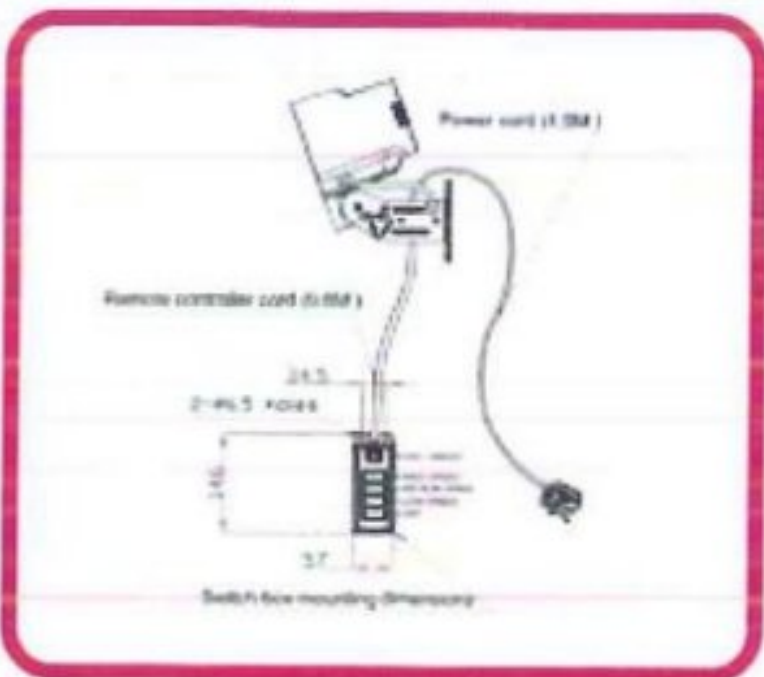
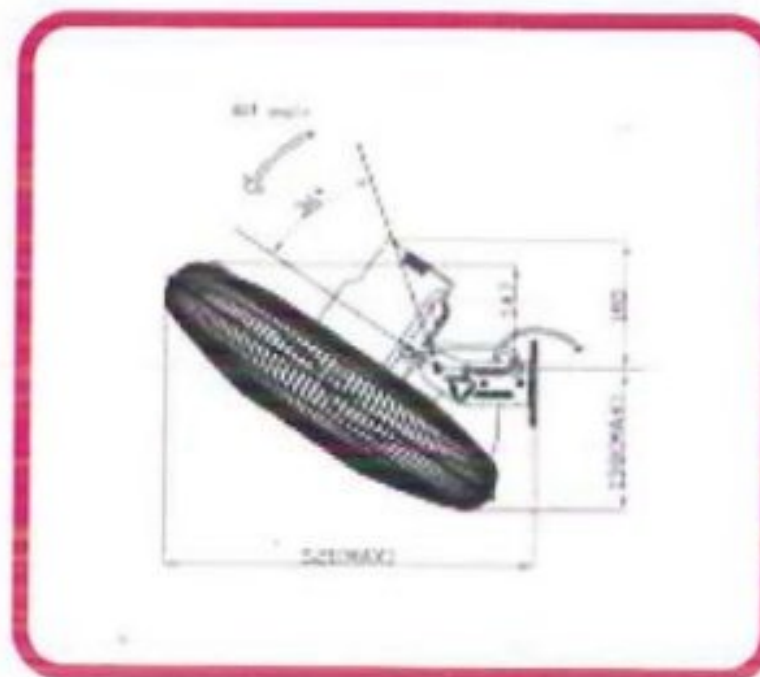
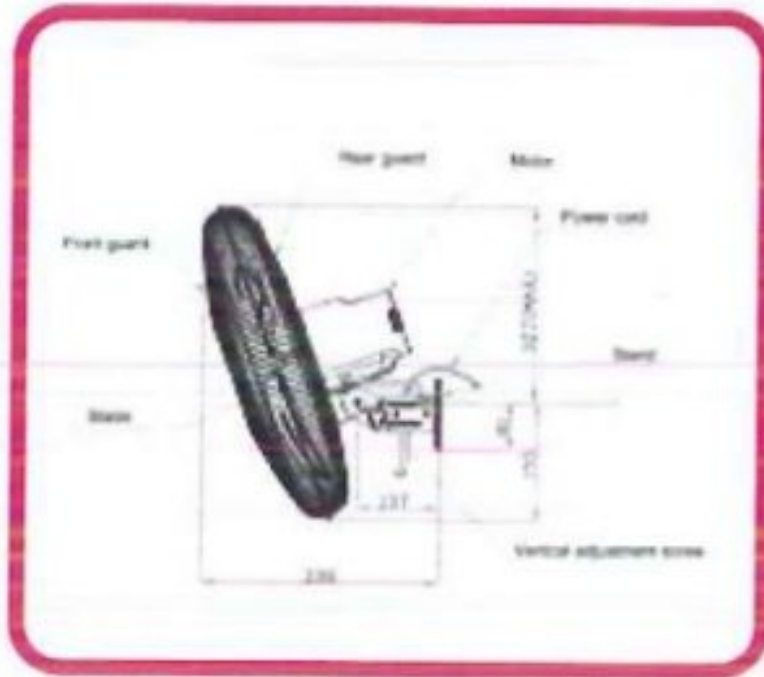

\*unit in mm

## IWF20 (MD-2016W)

### Specifications

Voltage Rating	220-240V~
Frequency	50 - 60Hz
Power	105 Watts
Fan Speed	1180 ~ 1380 RPM
Air Velocity	6.2 ~ 7.4 m/s
Safety Standards	MS IEC 60335-1 : 2015 MS 1597:PART 2-80:2010 MS 1220 : 2010

### Features

- ✓ 3-Aluminium Blade for Powerful Air Delivery
- ✓ Pure Copper Motor with Double Ball Bearing
- ✓ Extra Wired 3 Speed Controller (0.8M Length)
- ✓ Oscillation Function
- ✓ Built-in Safety Thermal Fuse
- ✓ Approved by SIRIM, Suruhanjaya Tenaga, JKR EMAL & IEC Certified



CERTIFIED TO: MS IEC 60335-1 : 2015  
MS 1597 : PART 2-80 : 2010  
MS 1220 : 2010  
CERTIFICATION NO : PC000566

# MAND

# 60" CEILING FAN



CERTIFIED TO: MS IEC 60335-1 : 2015  
MS 1597 : PART 2-80 : 2010  
MS 1220 : 2010  
CERTIFICATION NO: PC001948



## CF60(MCF-60)

Specifications	No. of Blades	3
	Fan Width	60 Inch / 1500mm
	Blade Material	Mild Steel
	Speed Control	Mechanical Control Regulator
	Speed Selection	5 Speed
	Motor RPM (Low-High)	140 ~ 280 RPM
	Air Delivery	219.54 m <sup>3</sup> /min
	Co-Efficient of Performance (COP)	3.045 m <sup>3</sup> /min/watt
	Safety Standards	MS IEC 60335-1 : 2015 MS 1597 : PART 2-80 : 2010 MS 1220 : 2010

Features	✓ Pure Copper Motor for Durable Operation
	✓ Pre-Assembled with Safety Wire Rope for Extra Protection
	✓ 5 Speed Regulator
	✓ Wider Sweeping Blades
	✓ Certified by 5 Star Energy Saving Rating by Suruhanjaya Tenaga
	✓ Approved by SIRIM, Suruhanjaya Tenaga, JKR EMAL & IEC Certified

**MAND**



**NOTE:**

---

# MÄND®

PRODUCT CATALOGUE ELECTRIC FANS & WIRING ACCESSORIES

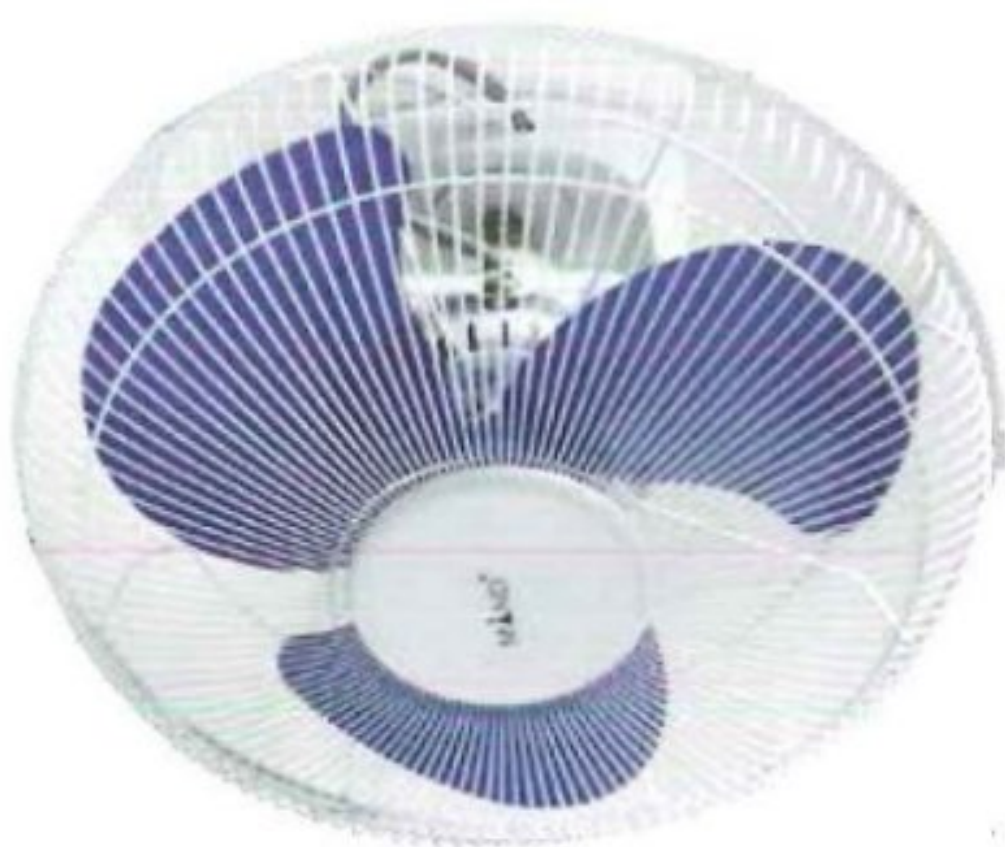
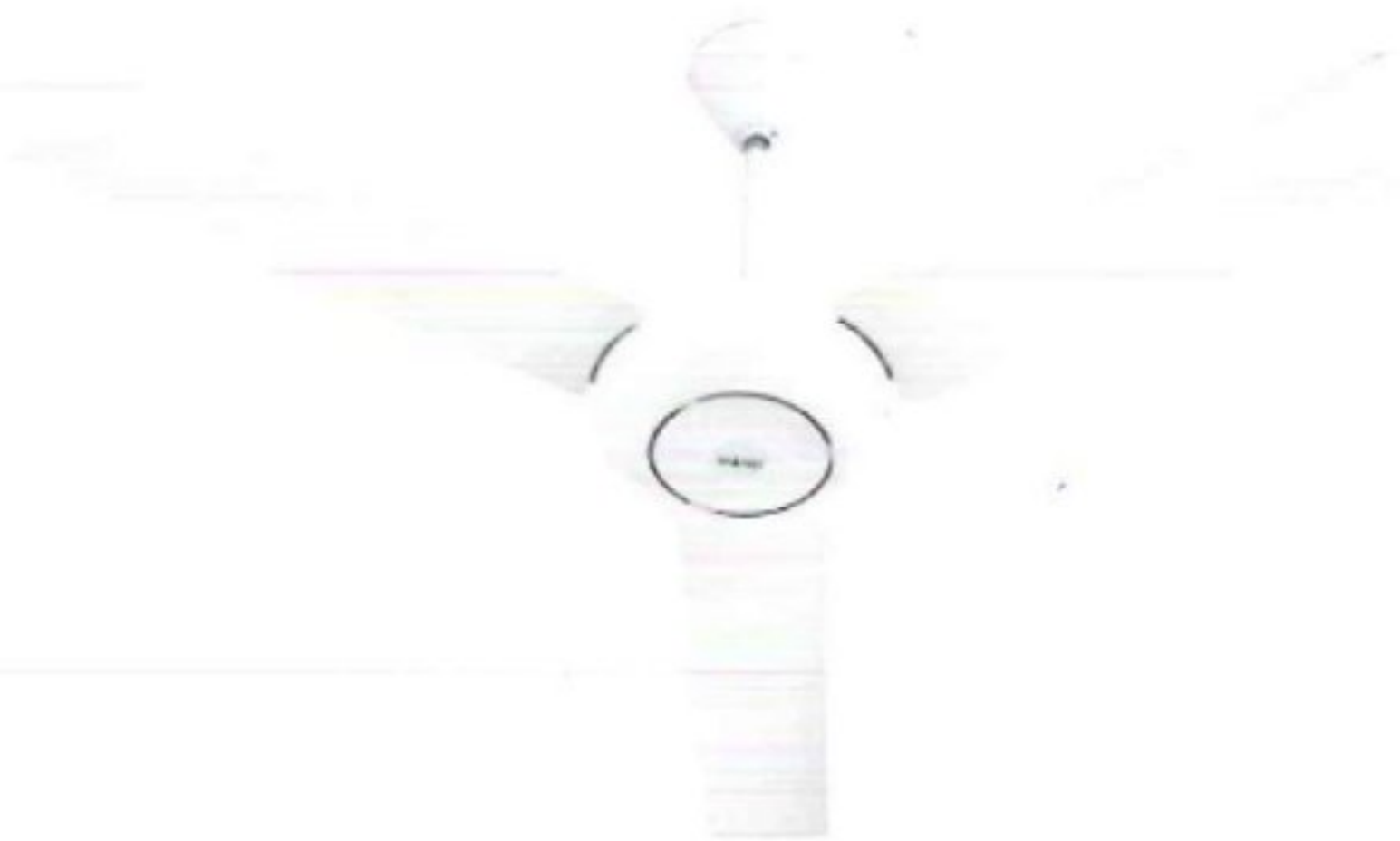

# MAND<sup>®</sup>

## PRODUCT CATALOGUE

### ELECTRIC FANS & WIRING ACCESSORIES



LIKE US

 Borneo Technical Co. M Sdn Bhd



Since 1856

**BORNEO TECHNICAL CO. (M) SDN. BHD. (24827-D)**

A Member of Solid Automotive Berhad

Lot DC01, Lot 2, Persiaran Sukan, Seksyen 13, 40100 Shah Alam, Selangor Darul Ehsan, Malaysia.

[www.borneogroup.com.my](http://www.borneogroup.com.my)