

Operation Instructions

Computrac[®] Vapor Pro[®] XL

PROPRIETARY RIGHTS NOTICE

This manual contains valuable information and material developed by AMETEK Brookfield for use with the Computrac® line of Moisture Analyzers. No part of this manual can be reproduced or transmitted in any form or by any means, electronic, mechanical or otherwise. This includes photocopying and recording or in connection with any information storage or retrieval system without the express written permission of AMETEK Brookfield.

ALL RIGHTS RESERVED

© 2020 AMETEK Brookfield. All rights reserved.

Table of Contents

1. WARNINGS AND SAFETY INFORMATION	1
2. A QUICK START GUIDE	4
3. UNPACKING, ACCESSORIES, AND SPARE PARTS	5
4. REPACKING AND SHIPPING	7
5. INTRODUCTION AND FEATURES	8
6. PRINCIPLES OF OPERATION	10
7. INSTALLATION	11
7.1. Instrument Location.....	11
7.2. AC Power Connection.....	12
7.3. Dry Air Or Nitrogen Connection.....	13
7.4. Accessory Connections.....	15
7.4.1. Connecting a USB Printer.....	16
7.4.2. Connecting a USB Drive	17
7.4.3. Connecting a Computer	17
7.4.4. USB Driver Setup.....	18
7.4.5. Connecting a USB Keyboard.....	21
7.4.6. Connecting a Bar Code Reader	22
8. OPERATING INSTRUCTIONS	23
9. TEST PROGRAMS	26
9.1. SAMPLE NAME	28
9.2. TEST START OPTIONS	28
9.3. TEMPERATURES	30
9.4. TEST END OPTIONS	31
9.5. RESULT DISPLAY OPTIONS.....	32
9.6. Vapor Pro XL w/Autosampler Pre-Purge Options.....	34
9.7. Saving And Loading Test Programs.....	36
10. TEST RESULTS	37
11. CALIBRATION MENU	39

11.1. CALIBRATION → FLOW SENSOR CONSTANTS	39
11.2. CALIBRATION → RH SENSOR CONSTANTS	40
11.3. CALIBRATION → SYSTEM CALIBRATION.....	40
11.3.1. Pipette Loading	41
11.4. CALIBRATION → SYSTEM CALIBRATION → VIEW CALIBRATION REPORT	42
11.5. CALIBRATION → TEMPERATURE CALIBRATION	43
12. SETUP MENU.....	45
12.1. SETUP → PRINTER SETUP.....	45
12.2. SETUP → REPORT SETUP	46
12.2.1 SETUP → REPORT SETUP → REPORT CONTROL OPTIONS.....	46
12.2.2. SETUP → REPORT SETUP → REPORT ITEMS TO PRINT	47
12.2.3. SETUP → REPORT SETUP → COMPANY NAME	47
12.2.4. SETUP → DATE/TIME SETUP.....	47
12.3. SETUP → ETHERNET SETUP.....	48
12.4. SETUP → MISC OPTIONS.....	49
12.5. SETUP → NITROGEN CONTROL	50
12.6. SETUP → LOGIN SETUP.....	50
13. SERVICE MENU	52
13.1. SERVICE → DISTRIBUTOR	52
13.2. SERVICE → SENSOR READINGS	52
13.3. SERVICE → WEB SERVER.....	53
14. AUDIT LOG.....	53
15. DETERMINE OPTIMUM TEST PARAMETERS	54
15.1. Starting With Karl Fischer Parameters.....	54
15.2. Parameter Development From Scratch.....	54
16. PERFORMING MOISTURE TESTS	56
17. WEB SERVER	57
17.1. CALIBRATION REPORT	58
17.2. LCD VIEW	59
17.3. TEST PROGRAMS.....	60
17.4. TEST RESULTS	61
17.5. AUDIT LOG.....	62

18. REPAIR, MAINTENANCE, AND OPTIONAL ACCESSORIES..... 63

- 18.1. LCD and Instrument Cleaning..... 63
- 18.2. Inserts for Crimp Top Sample Vials (not for VPXL Autosampler)..... 63
- 18.3. Cover Access..... 65
- 18.4. Hydrophobic Filter and Tubing Installation..... 66
- 18.5. Filter Inspection, Replacement & Flow Path Cleaning..... 67
- 18.6. Flow Check and Adjustment 68
- 18.7. Needle Replacement 69
- 18.8. Autosampler Unpacking and Quick Start Guide..... 72
- 18.9 Autosampler Operations 74

19. SPECIFICATIONS AND RATINGS 77

20. WARRANTY 79

1. WARNINGS AND SAFETY INFORMATION

- The instrument complies with “UL 61010 Electrical Equipment For Measurement, Control, and Laboratory Use (US, Canada, and Europe)”, electromagnetic compatibility, and the stipulated safety requirements.
- The instrument is Equipment Class I, Pollution Degree 2, and Installation Category II.
- The instrument contains a lithium coin cell battery to power the clock when the instrument is turned off. CAUTION: The battery may explode if mistreated. Do not recharge, disassemble, or dispose off in fire.
- The Temperature Calibration Interface (TCI) is electrostatic discharge (ESD) sensitive.
- Use I/O cables that are 3 meters or shorter.
- In case of emergency or instrument failure, disconnect the instrument from the AC power source.
- Failure to follow the instructions specified by the manufacturer may lead to failure in protection provided by the instrument.
- Before separating the VPXL from the Autosampler, retract the drawer (See Section 18.8).”
- Read this manual thoroughly before using the moisture analyzer to prevent damage to the equipment. Keep these instructions in a safe place. An up-to-date electronic copy of this manual can be found at www.brookfieldengineering.com.

The following instructions will help ensure safe and trouble-free operation of the Vapor Pro® XL moisture analyzer:

- Use the instrument only for performing moisture analysis of samples. Any improper use of the instrument can endanger persons and damage the instrument or other material assets.
- Do not use this instrument in a hazardous area/location. Operate it only under the ambient conditions specified in these instructions.
- Although the instrument is simple to operate and is very user-friendly, it should only be handled by qualified persons familiar with the properties of the sample being analyzed.
- Before getting started, ensure that the instrument line voltage setting matches the local power line voltage (See “7.1. Instrument Location”).
- The instrument is provided with a power cord that has a protective grounding conductor. Do not operate the instrument without the supplied three-wire power cord or an identical recognized equivalent that meets all applicable standards.
- AMETEK Brookfield does not recommend the use of an extension cord. However, if one must be used, use an extension cord that meets all applicable standards and has a protective grounding conductor.
- Do not remove the protective grounding wire from the power supply circuit.
- With the power switch off, power is still applied to the power entry module. Disconnect the power cord from the instrument to ensure complete power removal.
- Position the power cable so that it cannot touch any hot areas of the instrument.
- Use only factory-supplied accessories and options with the instrument or check with AMETEK Brookfield before using any third-party accessories, such as printers and analytical balances, to verify compatibility.
- If there is visible damage to the instrument or its power cord, unplug and isolate the

instrument first and then call Customer Service.

- Do not lift the instrument using the vial ramp. Lift from the instrument body instead.
- Do not open the instrument housing except as directed by this manual. There are no user-serviceable parts or user adjustments to be made inside the instrument, except as described herein. Any other maintenance inside the instrument is to be performed by factory-trained technicians only. Any unauthorized inspection and/or maintenance of the instrument will void the warranty.
- Handle the discharged sample vial with extreme care. Although the vials may cool rapidly, they are very hot when the transport removes them from the oven.
- Be extremely careful when working around the transport and heating chamber. They can be extremely hot.

Prevent Excess Heat Build-Up Around The Instrument

- When setting up the instrument, leave enough space to prevent instrument from overheating. Leave at least 20 cm (8 inches) around the instrument and 1 m (3 feet) above the instrument.
- Do not put any flammable substances on, under, or near the instrument, as this will heat up the area around the instrument.

Hazards Posed For Persons Or Equipment By Using Specific Samples:

Any flammables; explosives; substances that contain flammables, explosives, solvents; and/or substances that release flammable or explosive gases or vapors during the drying process.

- If flammable or explosive liquids are tested, the gasses escaping through the instrument's back are still dangerous when exposed to the atmosphere. Fume hoods may offer partial protection, but potential danger will be present. The user shall be liable and responsible for any damage that arises in connection with the instrument and potentially harmful substances.
- Substances containing toxic, caustic, or corrosive substances may be analyzed with the instrument in an appropriate fume hood only. The fume hood must keep the work area below the lower toxic limit established by appropriate standards.
- Substances that release corrosive or caustic vapors such as acids or bases should be analyzed in the smallest sample size possible. If vapors condense on the instrument housing parts, stop the testing, wipe the surface clean with a suitable neutralizer and place the instrument in a fume hood capable of removing the vapors. The instrument's flow system comprises aluminum parts and stainless steel and brass fittings connected with tubing. Check for the compatibility of substances to be tested before inserting them into the instrument.
- The user is responsible for carrying out appropriate decontamination if hazardous material is spilled on or inside the instrument.

Cleaning

- Clean the instrument according to the cleaning instructions only. The use of strong detergents and cleaners will damage the surfaces of the instrument.

- Before using any cleaning or decontamination method except those recommended by AMETEK Brookfield, check with Customer Service to ensure that the proposed method will not damage the equipment.
- The instrument's outside outer housing should be cleaned with a mild household detergent such as Formula 409® and a soft, lint-free cloth. The touchscreen LCD should be cleaned with lens or eyeglass cleaner only. Paper towels should never be used, as they will scratch the instrument's finish and the LCD. If more stringent methods are required, call Customer Service for recommendations.
- Cleaning of the flow system components is usually a factory operation. If components become contaminated, follow the directions for an isopropyl alcohol cleaning contained in §18.5 Filter Inspection on page 69.
- Every precaution has been taken to prevent contaminants from entering the instrument. However, if liquids or powders do enter the case, call Customer Service for recommendations.

The user shall be liable and responsible for any damage that arises in connection with the use of this instrument.

Environmental Conditions

Storage And Shipping

- The temperature should be between 0 °C and +40 °C (+32 °F and +104 °F).
- Relative Humidity should be between 10% and 80%.

Operational Conditions – Indoor Use.

- Optimum results will be achieved when the instrument is set on a smooth, leveled, non-vibrating surface in a non-condensing, non-explosive environment of 0 - 31 °C at less than 80% relative humidity or 32 - 40 °C at less than 50% relative humidity.
- Do not expose the instrument to extreme temperatures, moisture, shocks, blows, or vibration.

Warning ⚠



- **Protective Ground:**
It identifies the connection on the chassis and power inlet module for the safety ground (green/yellow) wire connection.



- **Warning:**
Observe information or procedures



- **Electrical Shock Hazard:**
Observe all steps of the procedure to prevent electrical shock.



- **Warning - Hot surface or area of possible severe burns:**
Use the listed precautions when opening the lid and handling samples to prevent injury.

2. A QUICK START GUIDE

(Please refer to section 18.8 for the Autosampler Unpacking and Quick Start Guide)

Read
WARNINGS
AND SAFETY
INFORMATION

Follow this flowchart to get set up and testing quickly.

Refer to **“1. WARNINGS AND SAFETY INFORMATION”** on page 1

UNPACK THE
INSTRUMENT

Refer to **“3. UNPACKING, ACCESSORIES, AND SPARE PARTS”** on page 5

INSTALL THE
INSTRUMENT &
CONNECT DRY
GAS SOURCE

Refer to **“7. INSTALLATION”** on page 11 for installation guidance and **“8. OPERATING INSTRUCTIONS”** on page 23 for any questions regarding navigating the instrument menu system or user interface. After the dry gas source is connected, perform **“18.6. Flow Check and Adjustment”** on page 68 to ensure the proper flow rate to the instrument.

ANY
ACCESSORIES?

Refer to **“7.4. Accessory Connections”** on page 15 to set up desired USB accessories (such as keyboards or printers) or an external balance.

SET UP
INSTRUMENT
OPTIONS

Refer to **“12. SETUP MENU”** on page 45 to configure instrument options, including Ethernet, N2 control, or user login options, as well as printer and Test Result report settings.

ANY SPECIAL
BOTTLE SIZES?

Refer to **“18.2. Inserts for Crimp Top Sample Vials”** on page 63 Vials for instructions on installing the inserts required for non-standard sample vials.

USING
HYDROPHOBIC
FILTER?

First, refer to **“18.3. Cover Access”** on page 65 for guidance on opening the instrument, then refer to **“18.4. Hydrophobic Filter and Tubing Installation”** on page 66 for initial filter installation or **“18.5. Filter Inspection, Replacement & flow path cleaning”** on page 67 for filter inspection and replacement.

If desired,
SYSTEM &/or
TEMPERATURE
CALIBRATIONS

Refer to **“11. CALIBRATION MENU”** on page 39. If a Temperature Calibration is desired, it should be performed before any System Calibration.

CREATE A TEST
PROGRAM FOR
THE SAMPLE
TO BE TESTED

Refer to **“9. TEST PROGRAMS”** on page 26 to set up a Test Program, or **“15. DETERMINE OPTIMUM TEST PARAMETERS”** on page 54 for guidance on developing a Test Program.

PERFORM
MOISTURE
TESTING

Refer to **“16. PERFORMING MOISTURE TESTS”** on page 56.

3. UNPACKING, ACCESSORIES, AND SPARE PARTS

(Please refer to section 18.8 for the Autosampler Unpacking and Quick Start Guide)

The Computrac® Vapor Pro® XL is easy to operate and ready for use upon receipt from the factory.

- Remove the instrument from the packing material. Do not lift the instrument using the vial ramp. Lift from the instrument body instead.
- **Retain all packaging materials for any future shipment of the instrument.**
If the instrument is returned to AMETEK Brookfield for any reason, it must be placed in the original packaging materials that have been tested and proven to be effective protection during shipment.
- Locate the following items:

PART NAME		PART NUMBER
Vapor Pro® XL Accessory Kit (Purchased Separately)		Y990-0265
1	Power Cord (varies with the area)	200-0002 US/CANADA 200-0003 England 200-0008 Europe
3'	Clear Tubing, 1/8" X 1/4"	345-0050
1 box	1.0 µL Microcaps Pipette (1 box of 100)	990-0150
1	Tweezers	690-0028
1	Inline Desiccator Kit	Y990-0116
1	Kit, Septa & Caps, Vapor Pro®	Y990-0206
	10 Vial Caps	990-0206 (x10)
	50 Septa for Sample Vials	990-0207 (x50)
1	Kit, Testing Assemblies	Y990-0226
	10 Vial Caps	990-0206 (x10)
	10 Septa for Sample Vials	990-0207 (x10)
	10 Sample Vials	990-0229 (x10)
1	Stylus	355-0167
1	Hose Barb Fitting, 10-32 x 1/8"	345-0113

Optional Accessories:		
	Hydrophobic Filter Kit with Fittings	Y990-0266
	Hydrophobic Filter & Tube	Y990-0267
	Bar Code Reader	990-0231
	Color Printer Kit (includes printer & USB cable)	Y990-0212
	Black & White Mini-Printer Kit (includes printer, USB cable & thermal paper)	Y990-0252 (Add'l Paper: 6100 0050)
	Temperature Calibration Kit	Y990-0142 (115 VAC) Y990-0165 (230 VAC)
	Dry Air Generator kit (115 VAC)	Y990-0143
	USB A to B Cable for Printer or PC connection	200-0165
	USB Keyboard	990-0230
	USB Hub (ONLY FOR VPXL)	990-0232
	USB Drive	990-0241
	Web Server	Y990-0268
	Digital balance with cable	Y990-0082 (115 VAC) Y990-0083 (230 VAC)
	Travel case (ONLY FOR VPXL)	990-0252
	IQOQPQ Validation Package (AUTOSAMPLER)	Y990-0269
	Technology Transfer Package	Y990-0249
	Kit, Small Crimp Vial (ONLY FOR VPXL)	Y990-0271
	Kit, Large Crimp Vial (ONLY FOR VPXL)	Y990-0272
	ADD A KIT FOR AUTOSAMPLER (8R VIAL)	Y990-0280
Spare Parts:		
	Vial Caps	990-0206
	Septa for Vial Caps	990-0207
	Sample Vials	990-0229
	Needle Replacement Kit	Y990-0270
	4 Amp Fuse	190-1002
	8 Amp Fuse	190-1001
	Shipping Container (ONLY FOR VPXL)	751-0025
	Oven Insert	300-0962
	Oven Insert Retaining Screw	850-0259

- Check for any damage and confirm receipt of all parts on the packing list. Contact Customer Service if you have any questions.

4. REPACKING AND SHIPPING

For service on your VPXL instrument, please call at 1+ 800-528-7411 to set up a Return Material Authorization before shipping your instrument.-

- For service on your VPXL AUTOSAMPLER instrument only, contact AMETEK Brookfield's service department at +1-508-946-6200 to obtain a return authorization number.
- Boxes and packing materials for all shipments are available from AMETEK Brookfield. Pack the instrument only in an AMETEK Brookfield shipping container.



**AMETEK BROOKFIELD will NOT be Responsible for Shipping Damage.
IF YOU RETURN THE INSTRUMENT IMPROPERLY PACKAGED OR
SHIPPED, YOU SHOULD INSURE IT FOR FULL VALUE.**



- Refer to the diagram below for guidance on repacking the Vapor Pro® XL.
- Place any accessories or loose items in the Tray.
- Before separating the VPXL from the Autosampler, retract the drawer (See Section 18.8)."

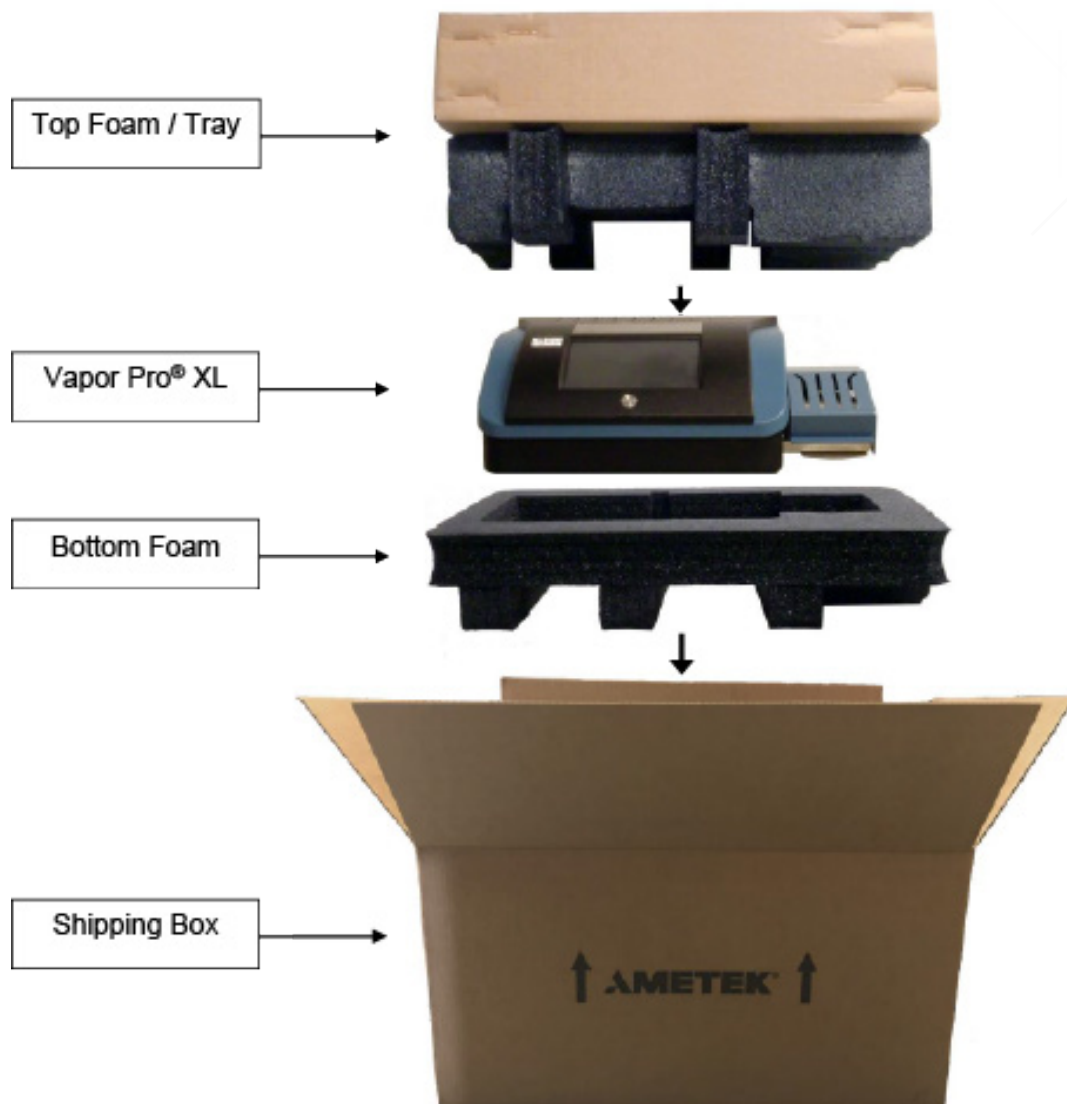

5. INTRODUCTION AND FEATURES

AMETEK Brookfield is proud to continue its leadership role in developing new technology for the moisture analysis industry. The Computrac® Vapor Pro® XL is a revolutionary high-performance programmable moisture analyzer that measures low moisture levels and has the following features:

- A lower detection limit of 10 ppm, depending on the sample size.
- Operates through a user-friendly, color LCD touchscreen. The LCD automatically dims when the instrument is not used for 30 minutes, to conserve energy.
- A patented system that measures low moisture samples without reagents and correlates to the Karl Fischer coulometric titration method (with an oven attachment) in precision and accuracy. Consumables are minimized, and fragile and expensive glassware is not required.
- Up to 250 Test Programs (including the factory Test Programs) are available. Each Test Program contains test parameters such as sample size, heater temperature, and test ending criteria. Parameters are adjusted to optimize speed and accuracy.
- Test temperatures are set in one-degree increments from 25 °C to 300 °C.
- Results are available in:
 - Parts per million water (ppm H₂O),
 - Micrograms water (µg H₂O), or
 - Percentage water (% H₂O).
- AMETEK Brookfield's pioneering prediction algorithm can reduce test times for some materials.
- The last 1000 Test Results are saved along with 100 Test Graphs:
 - Tests Results can be viewed, printed, and downloaded using Internet Explorer®/Edge browser (with the optional Web Server) or sent to a PC over a USB or serial port.
- The mean, standard deviation, and relative standard deviation can be calculated for test results.
- Moisture graphs can be viewed and printed.
- In addition to AMETEK Brookfield's standard 25 mL reusable sample vial, the oven accommodates crimp-top sample vial sizes from 2R to 30R. If necessary, the oven insert can be removed for larger diameter vials, which should only be done when the instrument is cold.
- An oven fan rapidly cools the oven to reduce wait time between Test Programs with lower temperatures.
- Periodic system and temperature calibrations maintain accuracy. NIST-traceable 1.0 µl pipettes (capillary tubes) permit quick and easy system verification. System calibration is checked in less than fifteen minutes. Recalibration is a menu-driven procedure to assure accurate and reliable results day after day.
- Built-in self-diagnostic routines continuously monitor system conditions to detect and report any abnormalities in the hardware, software, moisture sensor, or flow system.
- Designed for either lab or production floor use. Eliminating the expensive and fragile Karl Fischer glassware makes the instrument suitable for production floor use.
- An Audit Log tracks test program changes, calibrations, test result deletions, system

errors, and power-on events.

- Download a complete calibration report.
- View the LCD screen.
- Download and upload Test Programs.
- Download Test Results and Test Graph data.
- Download the Audit Log.
- A User Login function that can restrict access to calibration functions and instrument, and test configuration options to only authorized users. When User Login is active, a user is required to log in before testing, and the user name is recorded with each test result.
- On 21 CFR, Part 11 compliant instruments, the Delete Test Results and Delete Audit Log Events functions are disabled throughout the system.



6. PRINCIPLES OF OPERATION

The Computrac® Vapor Pro® XL Moisture Analyzer uses patented, state-of-the-art technology to provide quick, accurate, and precise results. The instrument uses a cylindrical sample oven, a dry carrier gas flow system, and a moisture sensor. The instrument heats the sample, typically in a reusable 25 mL septum vial, driving off volatiles. The carrier gas transports the volatiles from the sample vial to the sensor block containing a polymer capacitor Relative Humidity (RH) sensor. The RH sensor output, sensor block temperature, and carrier flow readings are combined by a microprocessor to generate an accurate moisture measurement. Test parameters are adjustable to optimize speed and accuracy.

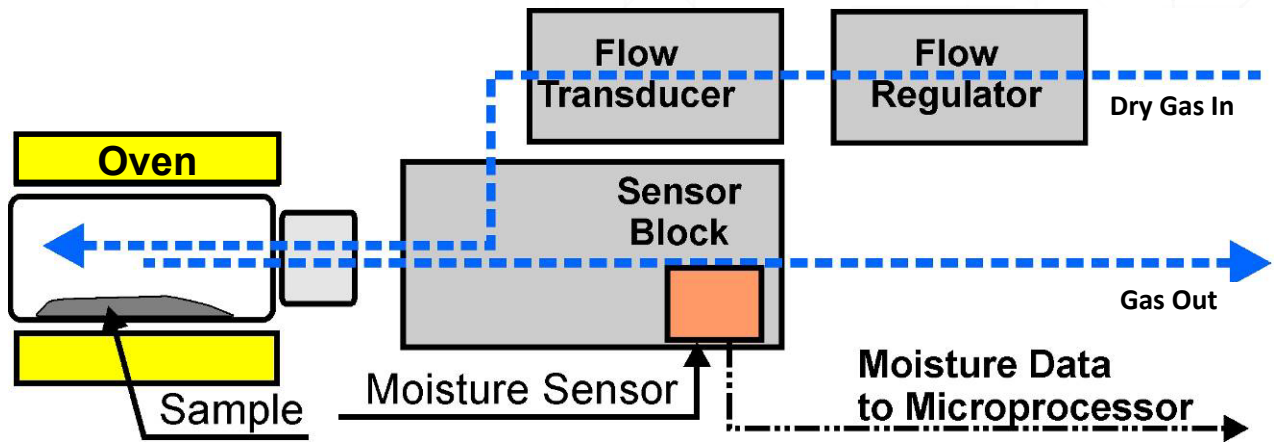

Applications

- Plastics
- Pharmaceuticals
- Batteries
- Oils
- Quality control



For those familiar with moisture analysis instruments, the Vapor Pro® XL should be simple to operate. However, please read all of the sections in this manual before attempting the first analysis.



A few materials are incompatible or interfere with the sensor. These are ammonium hydroxide, ethanol, methanol, and acetone. Samples containing these and similar chemicals should never be used. Additionally, never use these substances as cleaning agents in or on the Vapor Pro® XL.

Contact Customer Service if you have any questions about the instructions.

7. INSTALLATION

Place the **Computrac® Vapor Pro® XL** on a solid, level surface that is large enough to accommodate the instrument and any accessories or materials that may be required for your work (balance, printer, sample vials, samples, etc.).

- Perform the steps in this INSTALLATION section.
- Allow the instrument to warm up for 20 minutes.
- Perform a system calibration before testing (See “**11.3. CALIBRATION SYSTEM CALIBRATION**” on page 40).
- Set up a test program (See “**9. TEST PROGRAMS**” on page 26).

7.1. Instrument Location

The instrument is designed to provide reliable results under normal ambient conditions in the laboratory and on the production floor. Compliance with the following guidelines will help ensure optimum accuracy and minimum test times:

- Locate the instrument on a firm and level surface that is free from vibration.
- Locate the instrument close to an isolated power outlet that will provide a dedicated electrical power.
- Locate the instrument away from a fan, heating/air-conditioning vent, or drafts from a window/door.
- Maintain an operational clearance of 20 cm (8 inches) around the instrument and 1 m (3 feet) above the instrument.
- Keep all cables less than 2 meters (6 feet) in length, if possible.
- Avoid placing the instrument close to a heater or otherwise exposing it to heat or direct sunlight.
- Avoid exposing the instrument to extreme temperature fluctuations.
- Keep the instrument protected from dust, liquids, and caustic vapors as much as possible.
- Do not expose the instrument to saturated humidity environments. Moisture in the air can condense on a cold instrument's surfaces whenever it is brought into a substantially warmer place. If you move the instrument to a warmer area, make sure to condition it at room temperature by disconnecting it from AC power for one (1) hour and until moisture condensation no longer occurs.

7.2. AC Power Connection

Power Requirements: 100-120 VAC, 50/60 Hz @ 8 Amps
220-240 VAC, 50/60 Hz @ 4 Amps
Fused on/off switch is part of electromagnetic interference (EMI) power entry module

The instrument can be used with a 100-120 VAC or a 220-240 VAC input power source. Check the setting on the fuse holder located at the rear of the instrument. Make sure it is set to the correct voltage for the local power line voltage.

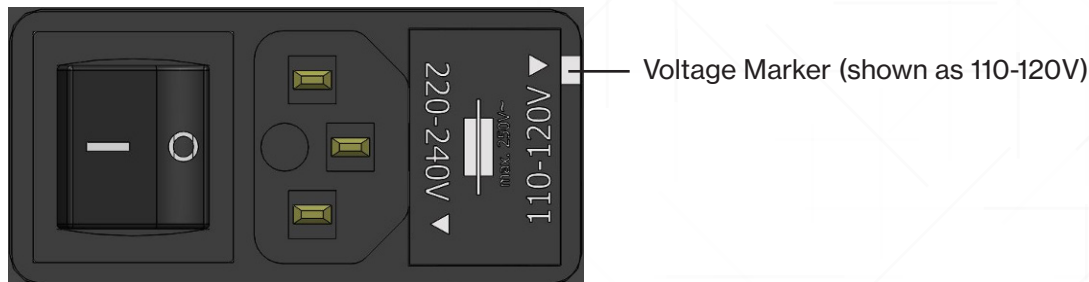

Ensure that the power entry module (where the power cord connects to the instrument) is set to the correct voltage for the local power line voltage.



To change the voltage from 110-120V to 220-240V or from 220-240V to 110-120V:

- Ensure the power switch located next to the fuse holder, is in the off (O) position.
- Remove the power cord, if connected.
- Pry the fuse holder from the power entry module.
- Ensure only 8 amp fuses are installed for 100-120 VAC operation, or only 4 amp fuses are installed for 220-240 VAC operation. Note the installation positions of the fuses before switching fuses.
- Rotate the fuse holder 180° and reinstall it in the power entry module, ensuring that the Voltage Marker (shown above) indicates the proper voltage for the local power line voltage.

Connect power to the instrument:

- Ensure that the power switch located on the power entry module in the instrument's back, is set to Off (O).
- Remove the power cord from the packing material and insert the rectangular end firmly into the power entry module.
- See “7.4. Accessory Connections” on page 15 and its subsections for accessory connections.

7.3. Dry Air Or Nitrogen Connection

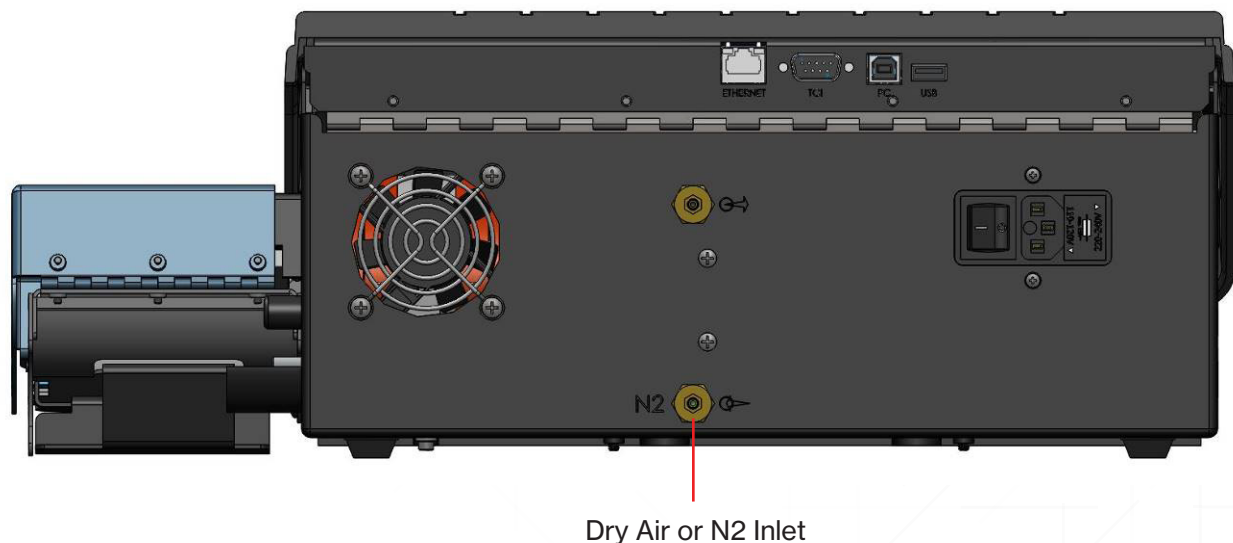

Using 1/8" ID clear tubing [P/N 345-0050], attach dry nitrogen or dry carrier gas source to the **Flow Inlet Port** fitting on the back of the instrument, indicated by an arrow pointing towards the fitting.

- Dry carrier gas source may be a cylinder, facility air or nitrogen supply, or a dry air generator.
- The pressure from a compressed gas cylinder is very high and is normally reduced by a two-stage regulator. The pressure from the compressed air or nitrogen system in most facilities will be moderate and usually requires only a single-stage regulator. The dry air generator, manufactured by AMETEK Brookfield [P/N Y990-0143], produces the pressure required by the instrument and therefore, no additional regulator is needed. The dry air generator is the ideal choice for portable operation.
- Examples of regulators capable of regulating pressure to below 30 psi are as follows:
- For cylinder applications: Multi-stage Gas Regulator for Compressed Air Cylinder, VWR #55850-474, or equivalent.
- For supplied gas sources: Matheson Gas Products Model 3473 Single Stage Line Regulator or equivalent.
- Connecting tubing must be P/N 345-0050 clear impermeable tubing, unless otherwise indicated, to prevent introducing moisture into the carrier gas system. Tubing size is 1/8" ID x 1/4" OD.
- A desiccant bed is recommended to remove any moisture that may be present in the carrier gas supply. A desiccant kit is available as P/N Y990-0116. As illustrated on the next page, the desiccant is placed just before the instrument's inlet connection. The desiccant turns from blue to pink as it absorbs moisture. When the entire column of desiccant is pink, it will no longer absorb moisture, and the desiccant must be replaced or regenerated to restore the drying capacity.
- Instructions on the Drierite® website show how to regenerate the Drierite® for continued use. For further information, contact W.A. Hammond Drierite Co, Ltd at (937) 376-2927 or at www.drierite.com.

The following diagrams are not to scale but illustrate the preferred connection arrangements.

Using a Compressed Gas Cylinder

The cylinder with a two-stage regulator is connected to the desiccator with clear tubing [P/N 345-0050]. The desiccator is connected to the instrument with the same type of tubing. The pressure to the instrument is between 17 and 22 psi (118-152 kPa).

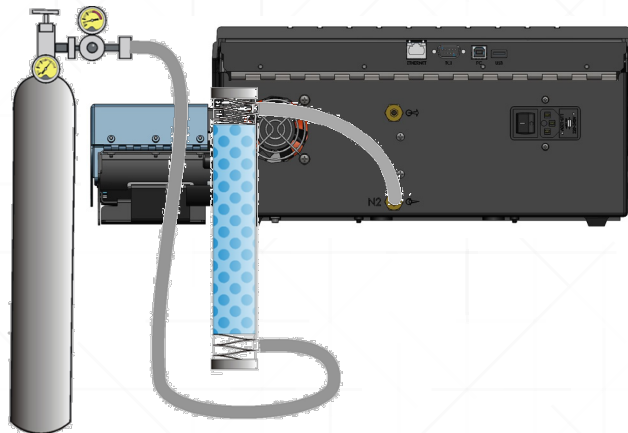

Using Facility Air or Gas Supply

The facilities air or gas supply is usually connected to a wall or bench mounted regulator. The regulator is connected to the desiccator with clear tubing [P/N 3450050]. The desiccator is connected to the instrument with the same type of tubing. The pressure to the instrument is between 17 and 22 psi (118-152 kPa).

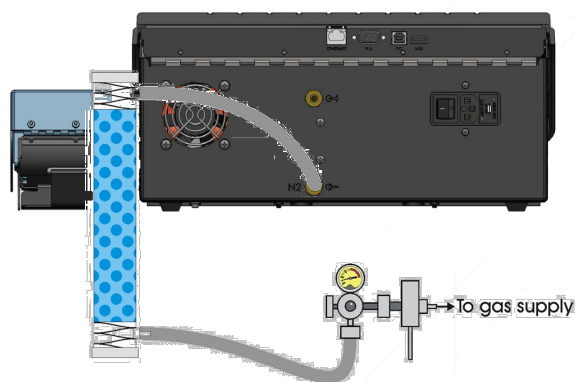

Using a Dry Air Generator

The dry air generator is connected to the desiccator with yellow tubing [P/N 2500 3003]. The desiccator is connected to the instrument with clear tubing [P/N 345-0050]. Pressure from the Dry Air Generator is not adjustable but should be above 14.5 psi (100 kPa).

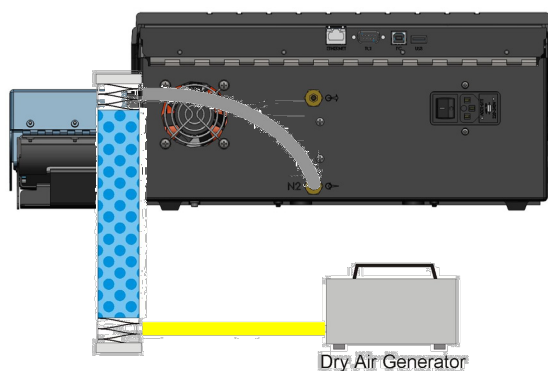

For all but the dry air generator, adjust the pressure to the instrument so that it is set between 17 and 22 psi (118-152 kPa) with 20 psi (138 kPa) being the preferred pressure.

Once the instrument is installed and the dry gas is connected, check the flow and adjust if necessary, according to “18.6. Flow Check and Adjustment” on page 68

7.4. Accessory Connections

If you plan to use a printer, electronic balance (connects to TCI port), and/or computer, connect them to the marked connectors at the back of the instrument, as described below.

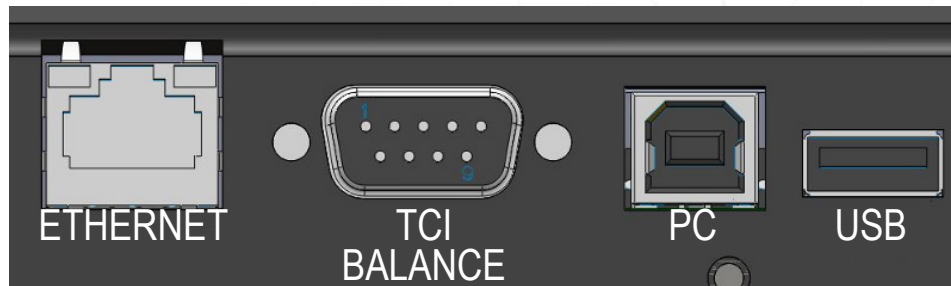

- Ethernet port:
 - The Ethernet port is used primarily to connect the instrument to a Local Area Network (LAN) for the optional Web Server. See “17. WEB SERVER” on page 57 for more information.
- Temperature Calibration Interface and Balance (marked TCI / BALANCE) port:
 - The TCI port is used primarily to connect the Temperature Calibration Interface when performing an oven temperature calibration. See “11.5. Calibration → Temperature Calibration” on page 43 for more information.
 - This port can also connect to a balance. Configure the balance to 9600 bits/s and (8 data bits, no parity, 1 stop bit) or (7 data bits, no parity, 2 stop bits). Configure the balance to output once per second. Many balances may work with the instrument, but if a new balance is going to be purchased, buy P/N Y990-0082 (115 VAC) or Y990-0083 (230 VAC) to ensure compatibility.

- USB Slave port (Square shape and marked PC) :
 - The USB slave connection is used to connect the instrument directly to a PC using a USB A to B cable [P/N 200-0165]. See §7.4.3 Connecting a Computer on page 21 for more information.

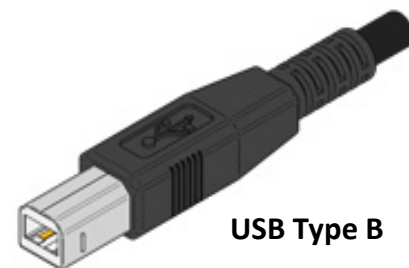

- USB Host port (Rectangular shape and marked USB):
 - The USB host connection connects to various accessories, including a USB printer, a USB drive, a USB keyboard, or a bar code reader. An icon (shown on the next page) appears at the top of the Main Screen, indicating the connected USB device's type.
 - A USB hub is required to connect more than one accessory simultaneously. USB

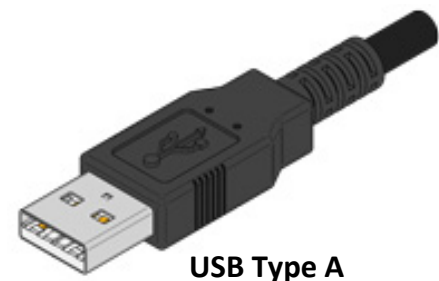

accessories (except printers) require a powered USB hub that connects to AC power. AMETEK Brookfield's powered USB hub [P/N 990-0232] is recommended for the best results.

- Use this port to connect to the optional Autosampler”
- For additional information on the USB host accessories, see:



“7.4.1. Connecting a USB Printer” on page 16



“7.4.2. Connecting a USB Drive” on page 17



“7.4.5. Connecting a USB Keyboard” on page 21



“7.4.6. Connecting a Bar Code Reader” on page 22

If you have any questions about connecting accessories to your instrument, call Customer Service.

7.4.1. Connecting a USB Printer

Two optional graphics capable printers are available from AMETEK Brookfield:

- Color Printer Kit: Y990-0212
- Black and White Mini-Printer Kit: Y990-0252

The printers connect to the USB host port (marked USB) on the back panel. Test Programs, Test Results and Graphs, and Calibrations can be printed. Some reports can be custom configured through the menu system. These same reports can be directed to a computer through the USB slave port (marked PC).

To set up the printer:

- Unpack the printer and cable.
- Load the ink cartridges (if any) and paper according to the printer instruction manual.
- Using a USB A to B cable, connect the printer into the instrument's USB host port (marked USB).
- Plug the power cord into the printer and to a GROUNDED power receptacle.
- Turn on the printer.
- Turn on the instrument.
- When a printer is connected, the printer icon appears at the top of the Main Screen. The icon varies depending on which printer is connected:
 - Standard Printer
 - Mini-Printer
- See “12.1. SETUP → PRINTER SETUP” on page 45 to enable printer output.
- See “12.2. SETUP → REPORT SETUP” on page 46 to configure test report options.
- Verify printer operation by printing a test result or calibration. For example:
 - Begin at the Main Screen and select [MENU] to access the Main Menu.
 - Select CALIBRATION MENU.
 - Select TEMP CALIBRATION MENU.

- Select **VIEW CALIBRATION REPORT**.
- Select **PRINT** and verify the report prints.
- If the printer runs out of paper while printing, printing will cease, and the print job will be purged. Printing to the PC, USB drive, or a 2nd attached printer will not be affected. To continue, refill the printer with paper and reprint the desired print job.

7.4.2. Connecting a USB Drive

If you wish to monitor testing using a USB drive [P/N 990-0241], one can be connected to the USB host port (marked USB) on the back panel. For best results, use AMETEK Brookfield Flash Drives [P/N 990-0241] that have been validated for use with the instrument. Compatibility with non-AMETEK Brookfield USB drives cannot be guaranteed.

See “**12.1. SETUP → PRINTER SETUP**” on page 45 to enable USB drive output. Do not use U3 USB drives, which are not compatible. Format the USB drive with FAT32 format before using it.

The instrument can send data to a computer, USB drive, and printer(s) simultaneously. However, graphs are only sent to the printer.

When a USB drive is connected, the  USB drive icon appears at the top of the Main Screen.

7.4.3. Connecting a Computer

If you wish to monitor testing with a personal computer (PC), connect the PC to the USB Slave port (marked PC) on the back panel using a USB A to B cable [P/N 200-0165]. A PC can connect to the TCI / BALANCE port instead, but most PCs no longer have 9-pin/RS-232 serial ports.



Before connecting the instrument to a PC with a USB cable, install the USB driver. See “7.4.4. USB Driver Setup” on page 18



- Use any serial port communications program on your PC to read the reports transmitted from the instrument. (Most Windows® PC’s prior to Windows® Vista came with HyperTerminal in the PC’s Start/Accessories/Communications menu. Numerous alternative terminal programs are available online for use with later operating systems). Configure the terminal program on the PC to use 9600bits/s, 8 data bits, no parity, 1 stop bit, and no flow control.
- Always have the instrument connected while the serial port is open on the PC. End the terminal session to close the serial port before disconnecting or powering off the instrument.
- The instrument does not test to see if the computer is connected or ready to receive data. It does not respond to a request from the computer for status information.
- The instrument can send data to a computer, USB drive, and printer(s) simultaneously. However, graphs are only sent to the printer.

7.4.4. USB Driver Setup

Before using the computer to receive information from the instrument through the USB Type B PC port on the back panel, the USB driver must be installed on the PC. The USB driver is on the CD with this manual and the Documents and Downloads page on the Support tab of the website at <http://www.azic.com>. The driver works with Windows®.

If the CD is available:

- Insert the CD in the PC's CD-ROM drive.
- Use Windows® to browse to the CD, locate the driver file (AMETEK_USB_Driver.zip), and copy it to the Windows® desktop.

If the CD is not available:

- Call Customer Service to request for USB Driver. If you received these instructions and the driver in an e-mail, save the attached file (AMETEK_USB_Driver.zip) to the desktop.

Once the driver file (AMETEK_USB_Driver.zip) is on the desktop:

- Double-click the file to open it.
- Drag the "Driver Install" directory from the .zip file to the desktop.
- Double-click the "Driver Install" folder to open it.
- Double-click the "Install Driver" shortcut to launch the AMETEK Driver Installer wizard.

Follow the instructions in the AMETEK Driver Installer wizard:

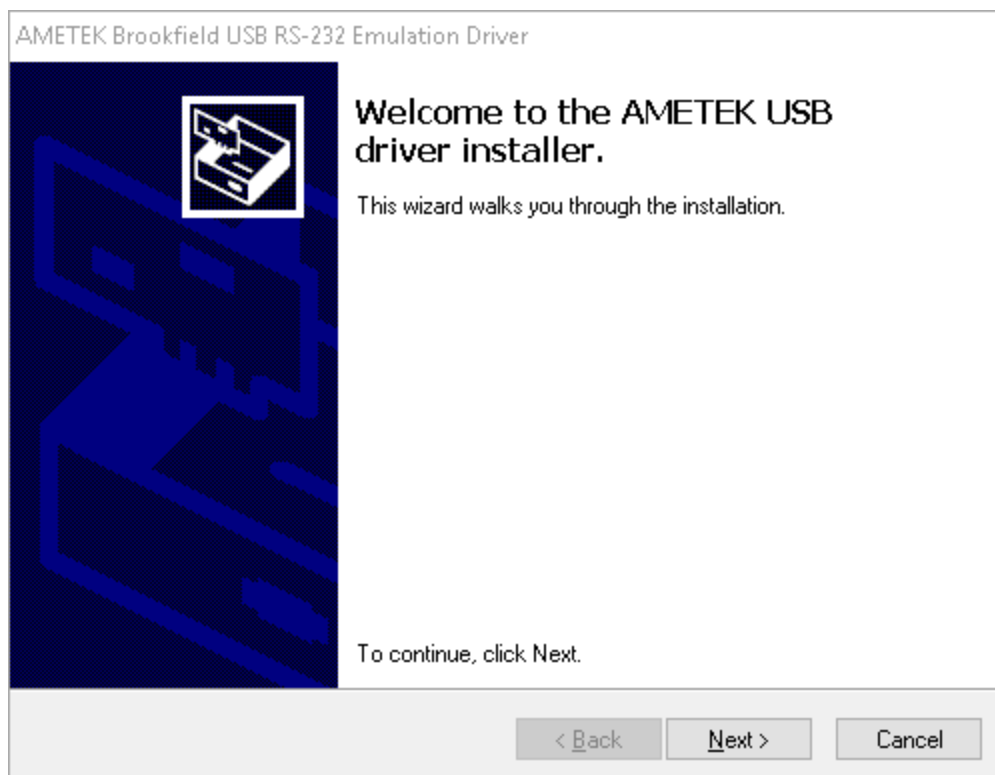

- Click Next.

Windows® will start installing the driver and then typically display a message indicating that the driver is from an “Unknown Publisher.”

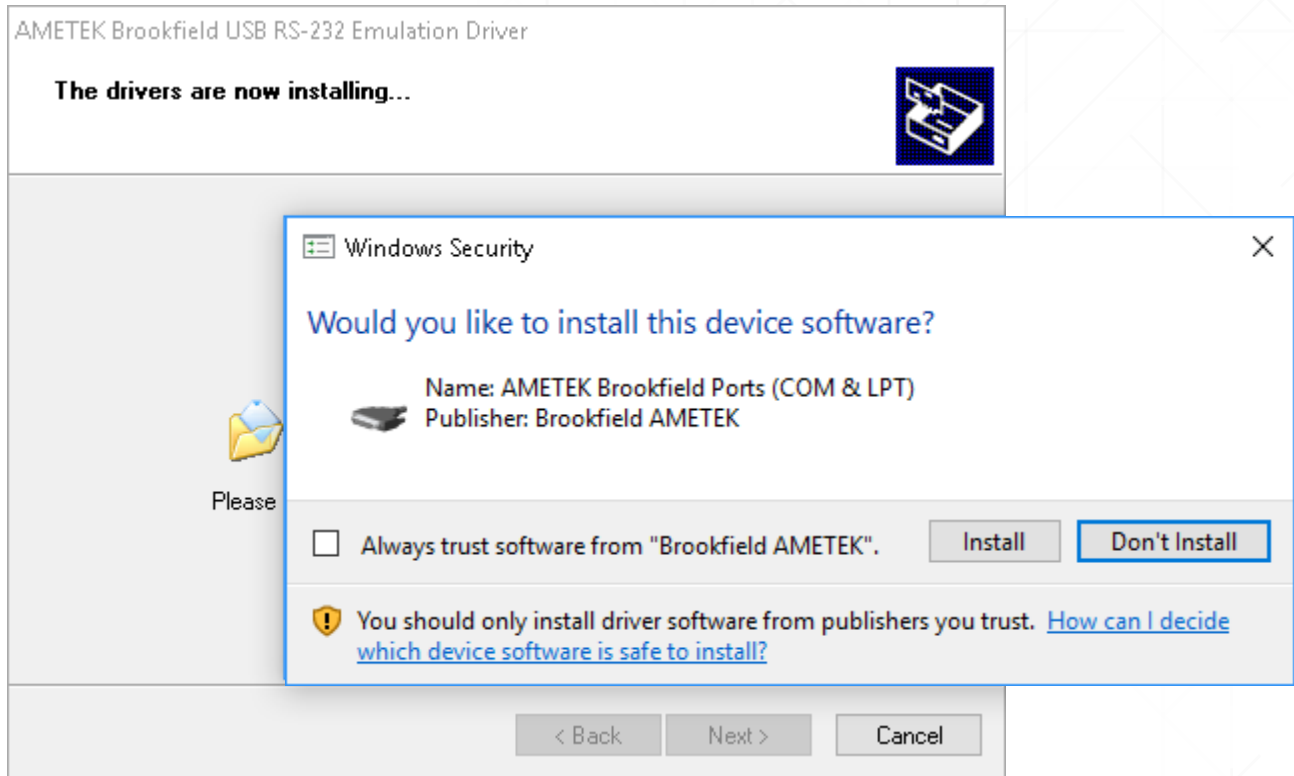

- Click “Install” to continue.

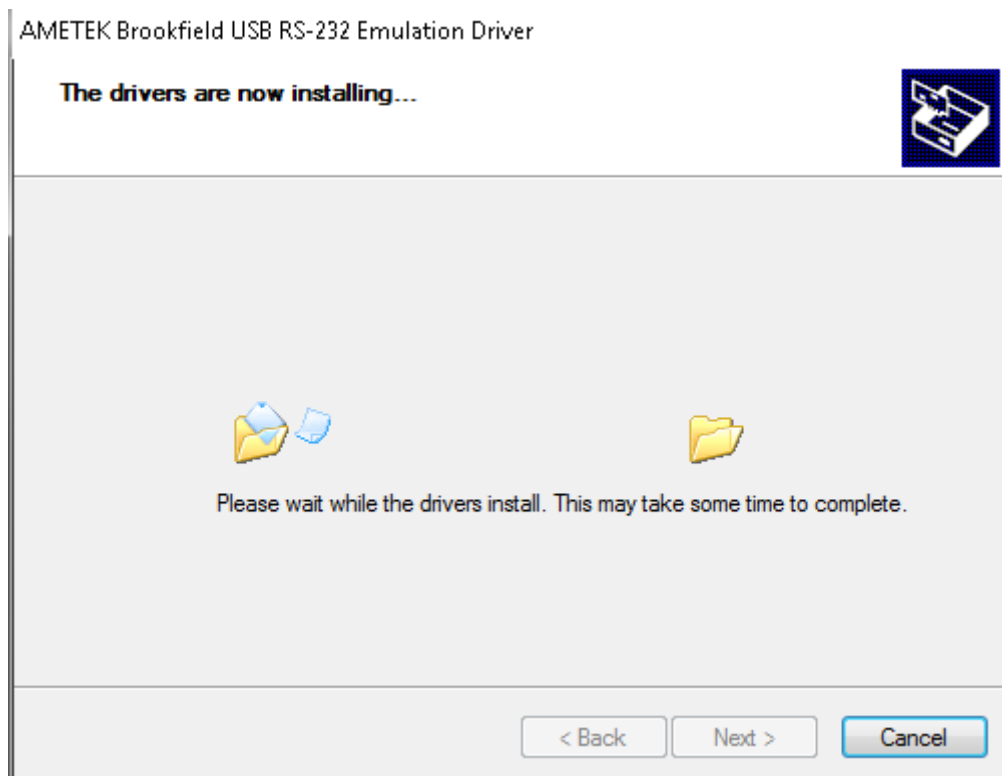

- Wait for the Driver to finish installing.

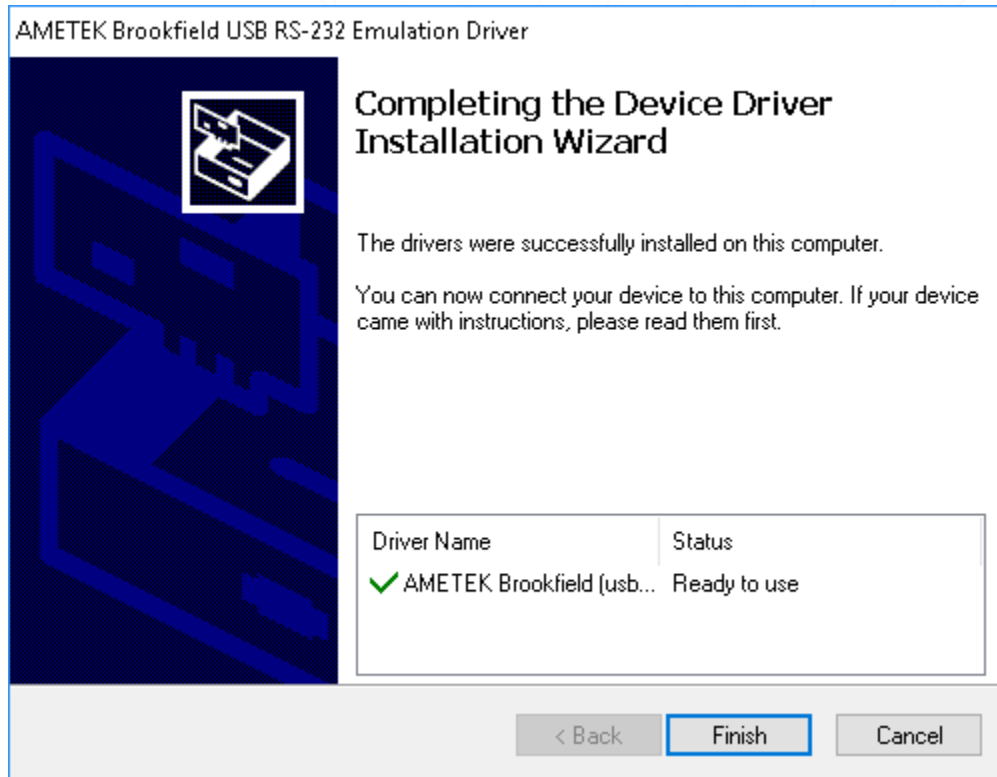

- Click 'Finish' to complete the installation.
- Connect the instrument to the target computer using a USB A-to-B cable [P/N 200-0165] and power on the instrument. Windows® will detect the instrument and automatically install the device driver software, as indicated by two pop-up balloons, possibly followed by the confirmation dialog shown on the next page.

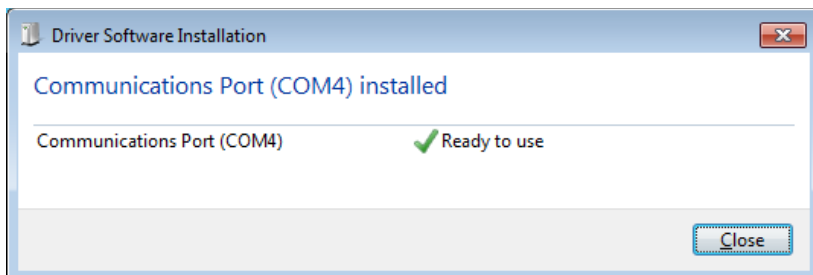
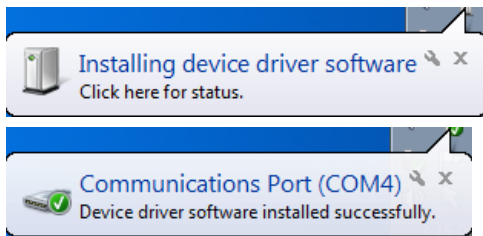

To determine what Windows® COM port was selected by the driver (if the COM Port number was not indicated in the pop-up balloon or dialog above), open the Control Panel (in Small or Large icons view), and open the Device Manager. Expand the Ports (COM & LPT) list and view the available Serial Ports.

In this example, COM4 is the new port. To verify, unplug the USB cable from the instrument and watch the communications port disappear from the list.

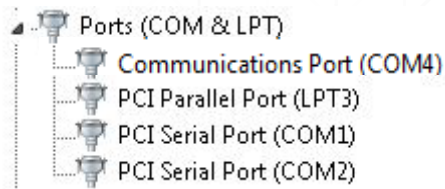

Make a note of the COM port in use, as this information will be needed when setting up the serial port communications program to communicate with the instrument.

7.4.5. Connecting a USB Keyboard

An optional keyboard is available from AMETEK Brookfield [P/N 990-0230] that allows easier text entry. It connects to the USB host port (marked USB) on the back panel.

- Unpack the keyboard.
- Plug the keyboard cable into the instrument's USB host port (marked USB).
- When the keyboard is connected, the  keyboard icon appears at the top of the Main Screen.

7.4.6. Connecting a Bar Code Reader

An optional bar code reader [P/N 990-0231] is available from AMETEK Brookfield that allows rapid data entry. Alphanumeric data can be entered into the instrument using the instrument touchscreen, a USB keyboard, and/or the bar code reader. When the field for the item to be input is highlighted on the instrument, simply scan the barcode to populate the item.

For example, if the test samples are labeled with bar codes, the bar code reader is useful to scan the LOT NUMBER and ID at the start of a test. See “12.4. SETUP → MISC OPTIONS” on page 49 for more information on LOT NUMBER and ID input.

- Unpack the bar code reader.
- Plug the bar code reading into the USB host port (marked **USB**) on the back panel.
- When the bar code reader is connected, the keyboard icon appears at the top of the Main Screen.

Note: The bar code reader also acts like a USB keyboard, and only one keyboard device can be connected to the instrument at a time. To use the keyboard, the bar code reader must first be disconnected from the instrument or USB hub, and vice versa.

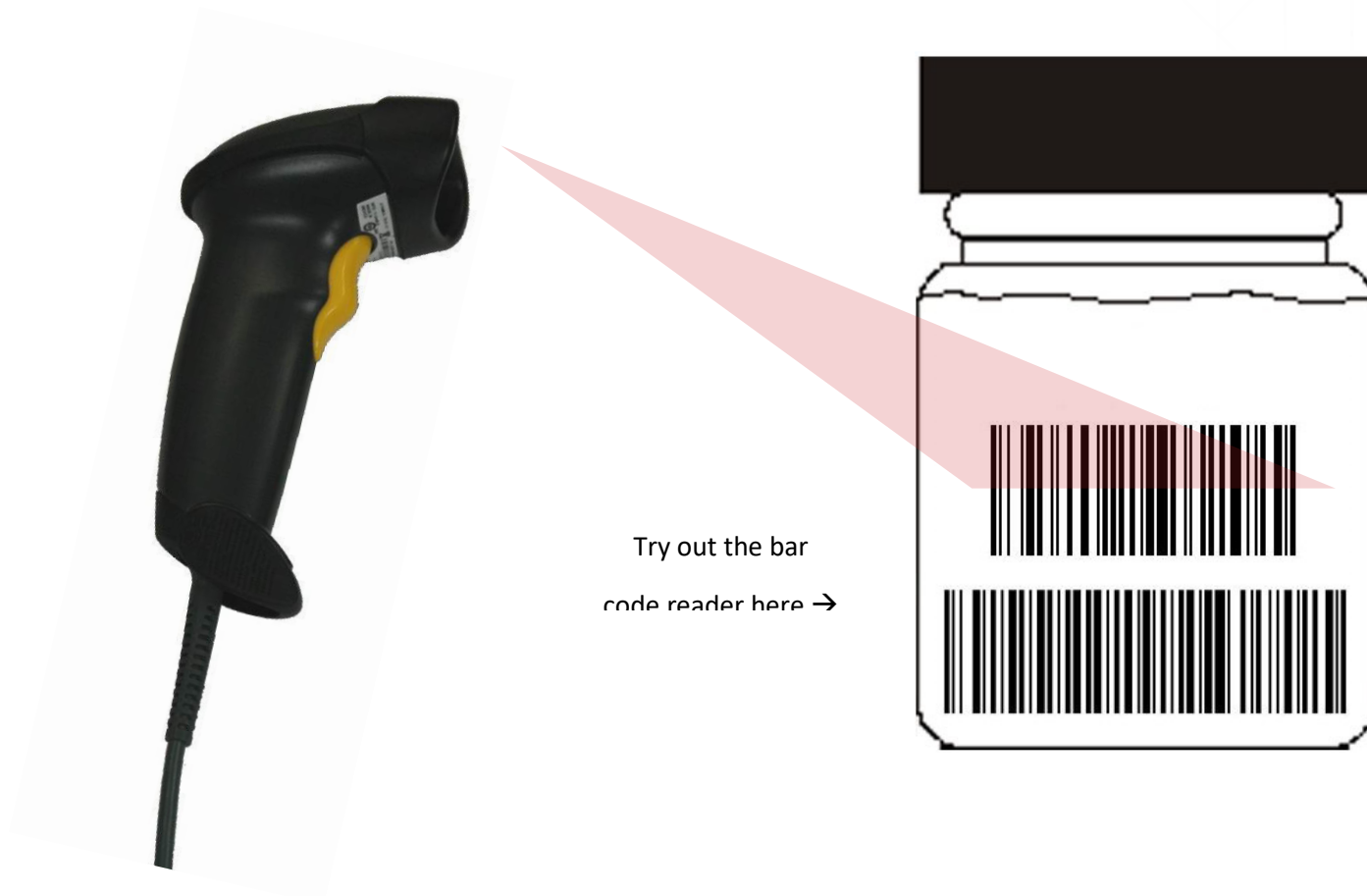

8. OPERATING INSTRUCTIONS

- During power-up, the screen momentarily displays the firmware revision and the serial number of the instrument.
- Touching the screen while this information is displayed initiates touchscreen calibration. The included resistive stylus [P/N 355-0167, no ink pens] is used to calibrate the touchscreen by following the on-screen instructions. This calibration is done at the factory and not typically required in the field.
- Next, the Main Screen shown below appears. (It may be necessary to press the OK button to clear any messages).
- The LCD automatically dims when the instrument is not used for 30 minutes, to conserve energy. Pressing the touchscreen returns the LCD to full brightness.

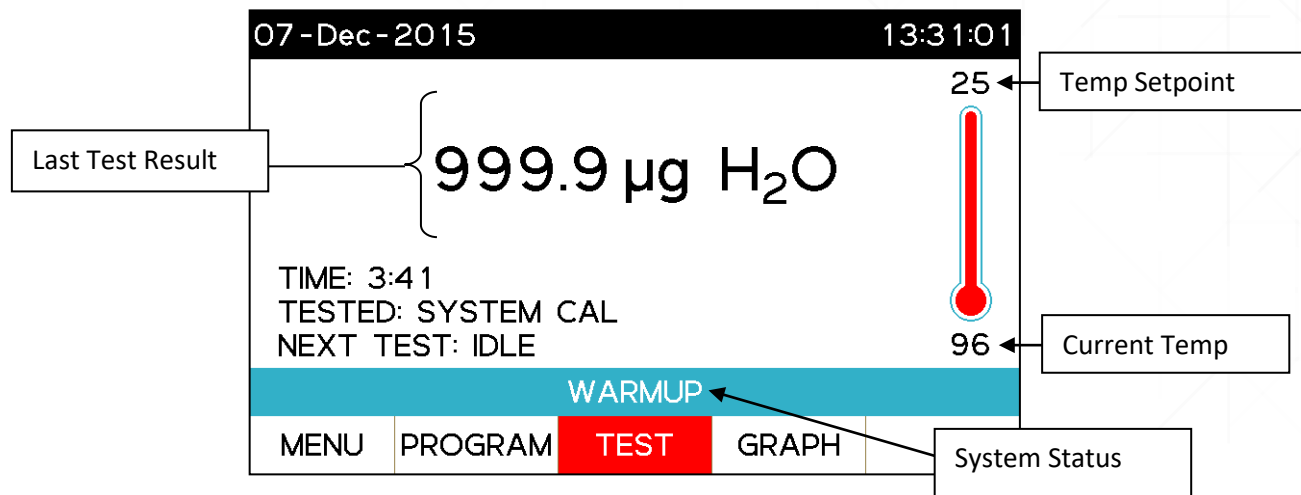



The Main Screen displays the length and result of the last test, Test Program used, current oven temperature, oven temperature setpoint, and current system status. These results indicate WARMUP, and show a countdown timer if the instrument is drying down or READY TO TEST when the drydown is complete. The NEXT TEST field indicates what Test Program is currently selected and will be used if the TEST button is pressed.

The functions of the bottom row touchscreen buttons are:

- **[MENU]** – Touch to access the Main Menu.
- **[PROGRAM]** – Touch to select an already defined test program to be used for testing. Use **MAIN MENU** → **TEST PROGRAMS** to add or edit test programs.
- **[TEST]** – Touch to begin a test using the currently selected Test Program.
- **[GRAPH]** – Touch to view the Test Graph from the last test that was run.





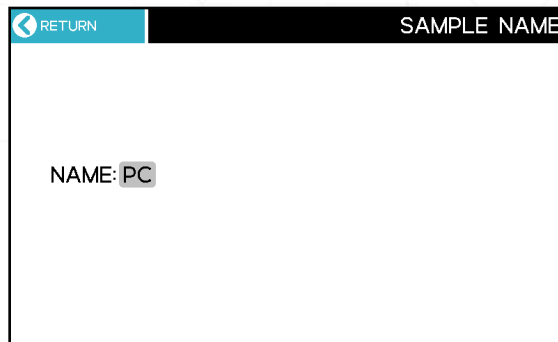

Note: Throughout this manual, **[BOLD]** text with square brackets indicates buttons or commands on this bottom row of touchscreen buttons. Other touchscreen buttons not located in the bottom row are shown in **BOLD** without square brackets.

Other user interface items:





- **Home Button** – The silver button beneath the LCD returns to the Main Screen, unless a Test is running, in which case it returns to the Test Screen.
- < RETURN or <RETURN TO PRIOR MENU - Non-editing screens are exited by pressing the upper left portion of the screen.
- Editing or text input screens are exited using the Enter button () or the Escape button (), as explained below.

To begin editing on screens with fields, select the gray text box to access the text editing screen (shown below).

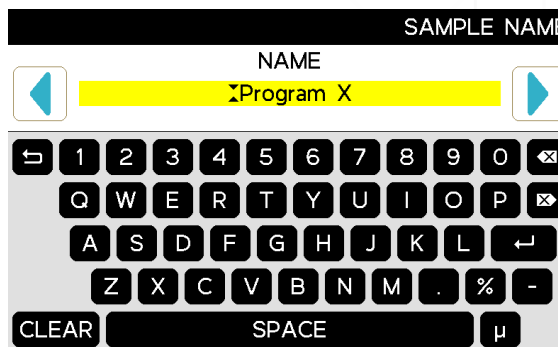

Once in edit mode, the current text is overwritten if the first key pressed is alphanumeric. Otherwise, use the cursor arrow keys   or delete arrow keys   to position the cursor where desired. Use  to save and use  to exit without saving.



On screens that have multiple pages, use the arrow keys to scroll. The single arrows   scroll the list one line at a time in the indicated direction, while the double arrows   scroll the list one page at a time in the indicated direction. When the desired list item is reached, touch to select it.

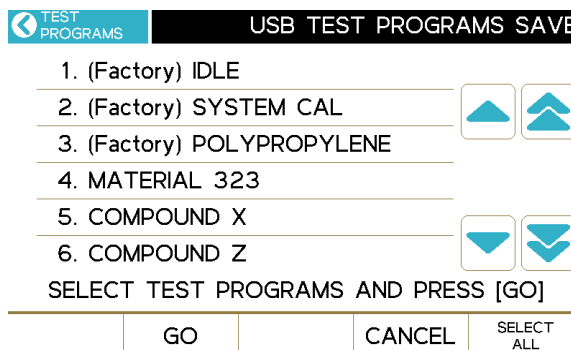

Pressing [MENU] displays the Main Menu screen, with the following options:

- TEST PROGRAMS
- TEST RESULTS
- CALIBRATION MENU
- SETUP MENU
- SERVICE MENU
- AUDIT LOG

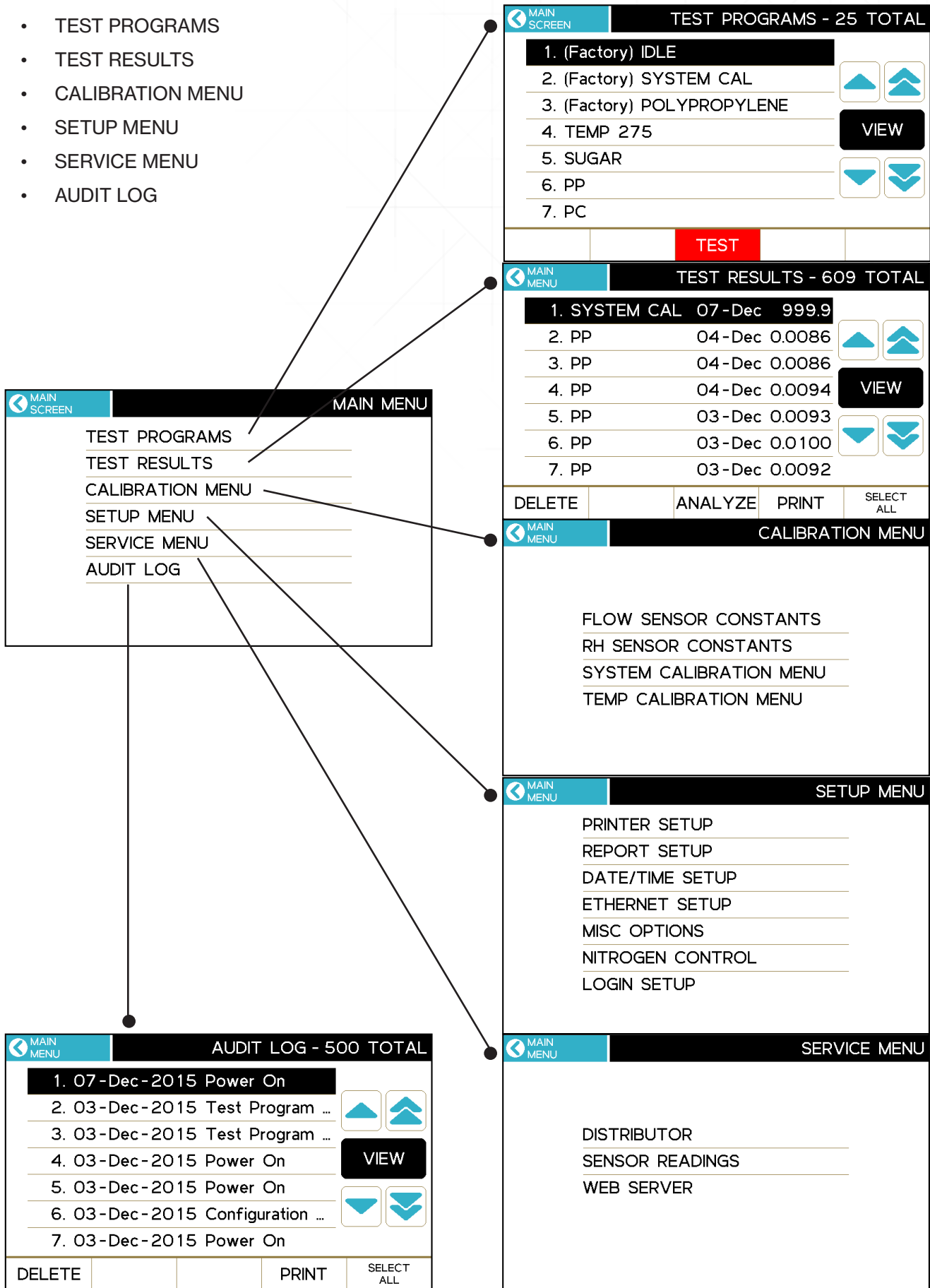

9. TEST PROGRAMS

The TEST PROGRAMS menu is used to create, select, edit, and print Test Programs and save them to or load them from a USB drive. The Computrac® Vapor Pro® XL can store 250 Test Programs. Each Test Program is optimized for a specific sample material (see §15 DETERMINE OPTIMUM TEST PARAMETERS on page 56). If desired, AMETEK Brookfield can help determine test program parameters for your samples. Contact the salesperson for details.

There are two different sets of buttons available from the Test Programs listing:

- The I/O KEYS: [SAVE], [LOAD], [PRINT], and [EDIT] (as shown in the image below-left).
 - The I/O KEYS are used to save Test Programs to a USB drive, load Test Programs from a USB drive, print selected Test Programs, or edit Test Programs.
 - Refer to §9.6 Saving And Loading Test Programs for guidance on using a USB drive to save Test Programs from an instrument or load Test Programs into an instrument.
- The MOVE KEYS: [CUT], [COPY], [INSERT ↑], and [INSERT ↓] (as shown in the image below-right).
 - The MOVE KEYS are used to create new Test Programs and for maintenance of the Test Programs listing.
- If the desired buttons are not displayed, press MOVE KEYS or I/O KEYS as appropriate to display the corresponding buttons.

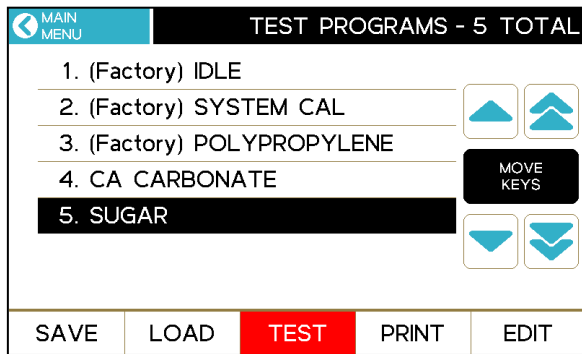

I/O Keys

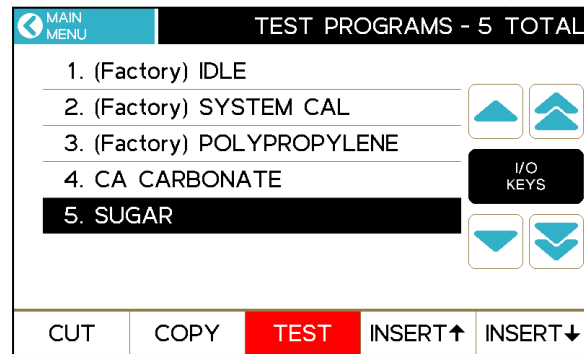

Move Keys

To create a new Test Program:

- Begin at the Main Screen and select **[MENU]** to access the Main Menu.
- Select TEST PROGRAMS.

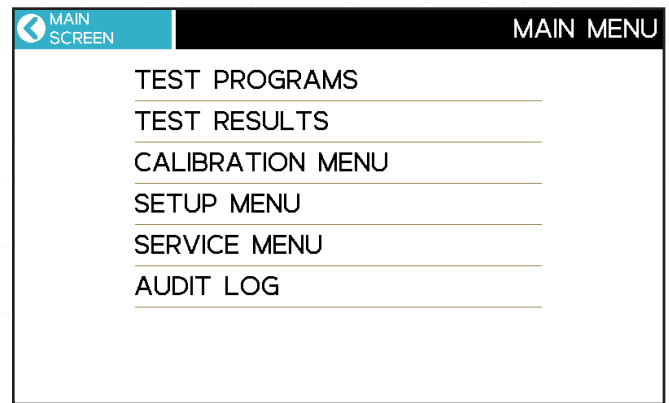

- Ensure that the Move Keys are displayed. If they are not, press **MOVE KEYS** to display them.

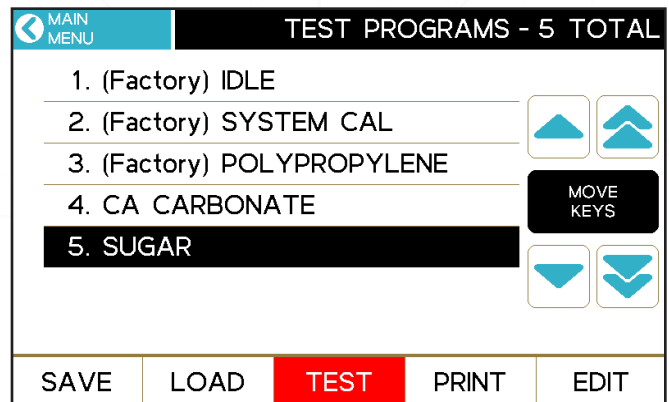

- Use the arrow keys to scroll to the last Test Program in the list and touch to select it. A black highlight bar indicates the selection.

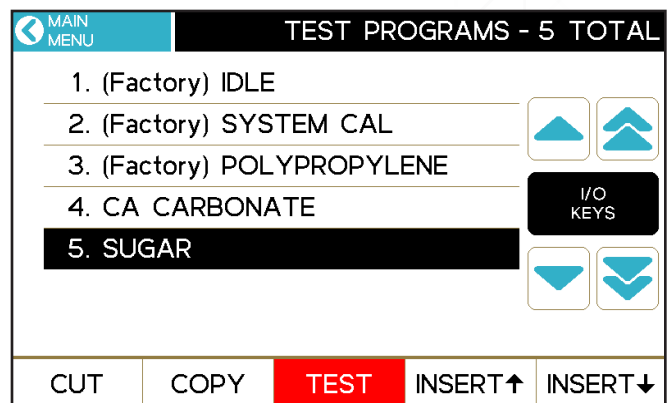

- Touch **[INSERT ↓]** to insert a new Test Program below the last Test Program.
- Press **I/O KEYS** to switch to the I/O keys.
- Ensure the new Test Program is still selected and press **[EDIT]** to edit the Test Program, as described in the next sections.

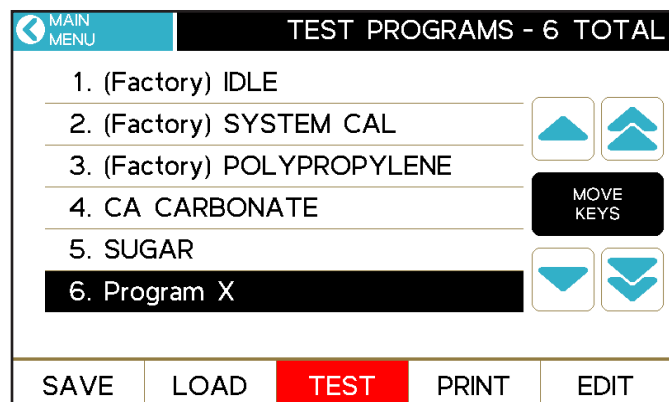

9.1. SAMPLE NAME

At the TEST PROGRAM menu, touch SAMPLE NAME to start editing the sample name.

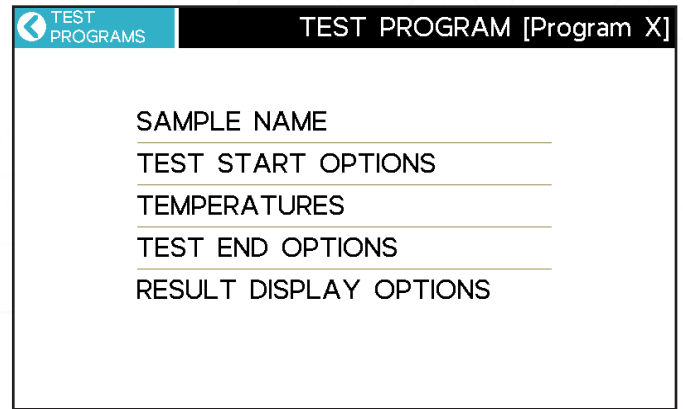

To begin editing, select the gray text box. In edit mode, the current text is overwritten if the first key pressed is alphanumeric. Otherwise, use the cursor or the delete keys to position for editing.

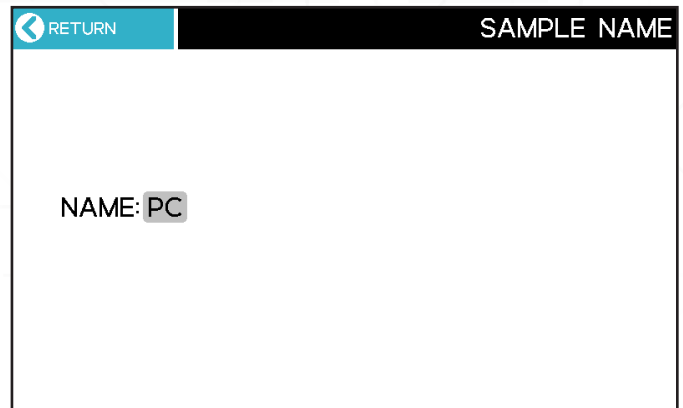

9.2. TEST START OPTIONS

- VIAL PURGE time is the length of high flow time required to rid the vial of headspace moisture after the vial is pulled into the oven. Typically, 35 seconds of purge time removes the headspace moisture. This time can be shortened if sample moisture is being lost during the purge. A significant moisture rate right after the purge time indicates that sample moisture is being lost.
- RESIDUAL VIAL MOISTURE is subtracted from the sample result. This is the headspace moisture that is not removed by the VIAL PURGE. A zero VIAL PURGE time can be used to capture all sample moisture, but an expected RESIDUAL VIAL MOISTURE amount must be used to get good test results. Running empty vials with zero VIAL PURGE time gives the approximate headspace moisture. When room humidity changes, the headspace moisture changes.
- SAMPLE PROMPT is a short user-defined message displayed when starting a test, such as "LOAD 5 GRAMS" or "USE 2.0G +/- 0.2G".
- SAMPLE WEIGHT ENTRY – Test result units, except $\mu\text{g H}_2\text{O}$, require SAMPLE WEIGHT

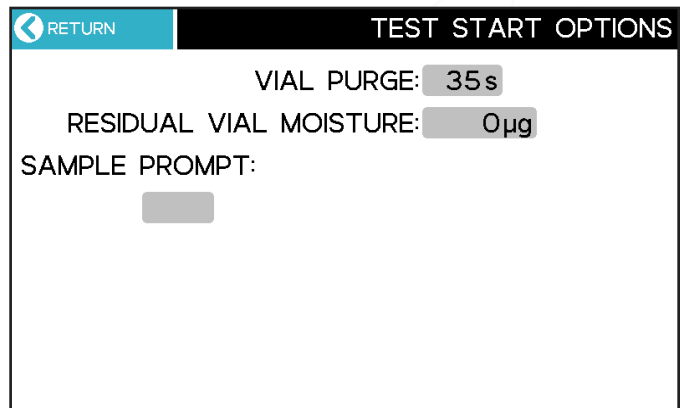

ENTRY to be set up in the TEST START OPTIONS. See “9.5. RESULT DISPLAY OPTIONS” on page 32 for additional information on the result display options.

To configure SAMPLE WEIGHT ENTRY, select Manual or Balance:

- **Manual:**
 - At the start of each test, the instrument will query the user for the sample's weight.
 - If fixed weight samples are used, enter the weight in the DEFAULT WEIGHT field. When the instrument queries for the weight, accept the default weight to proceed.
- **Balance:**
 - At the start of each test, the connected accessory balance is used to measure the sample weight, and the instrument queries the user for acceptance of the measured weight. This value can be manually overridden if desired.
- **Note:** See “10. TEST RESULTS” on page 37 for instructions on entering the weight of the empty vial and cap after the test, for pre-sealed sample vials where the initial sample weight includes the weight of the vial, cap, and sample.
- **DEFAULT WEIGHT** – If using **MANUAL** Sample Weight Entry and fixed weight samples, the default sample weight can be entered here, as noted above.
- **CALC WEIGHT FROM VOLUME** – For some materials, such as liquids, samples are more easily measured by volume than by weight. If the sample's volume and density are known, the instrument can use these values to calculate the initial sample weight.
- Pressing **CALC WEIGHT FROM VOLUME** displays the screen shown below left, and the sample **VOLUME** and **DENSITY** can be input. When **CALC** is pressed, the instrument will calculate the **DEFAULT WEIGHT** for the sample and will update the **SAMPLE PROMPT** and **DEFAULT WEIGHT** values, as shown in the image below-right.

RETURN SAMPLE VOLUME

VOLUME: 2.00cc (or mL)

DENSITY: 0.850g/cc (or g/mL)

CALC

RETURN TEST START OPTIONS

VIAL PURGE: 35s

RESIDUAL VIAL MOISTURE: 0µg

SAMPLE PROMPT:
2.00 CC

SAMPLE WEIGHT ENTRY: Manual

DEFAULT WEIGHT: 1.7000g

CALC WEIGHT FROM VOLUME

9.3. TEMPERATURES

- TEST TEMPERATURE is the temperature setpoint for the test.
- If enabled, COLD START begins testing at room temperature instead of at the specified TEST TEMPERATURE. During the test, the oven ramps up to the TEST TEMPERATURE instead. COLD START is rarely used.
- If enabled, the TEMPERATURE STEP puts the instrument into a special test mode. The instrument starts a test at the TEST TEMPERATURE and ends normally. A following test automatically begins with the temperature increased by the STEP INCREMENT amount and ends normally. New tests are started until the stepped temperature exceeds the MAX TEMPERATURE. Each stepped test is saved.
- TEMPERATURE STEP modes available are Off, Accumulate results, or Individual results. 'Individual' records the results of each test separately, while 'Accumulate' adds the moisture of the previous tests to the current result. 'Accumulate' mode is good for determining the temperature when a sample releases moisture and can help determine the proper test temperature.

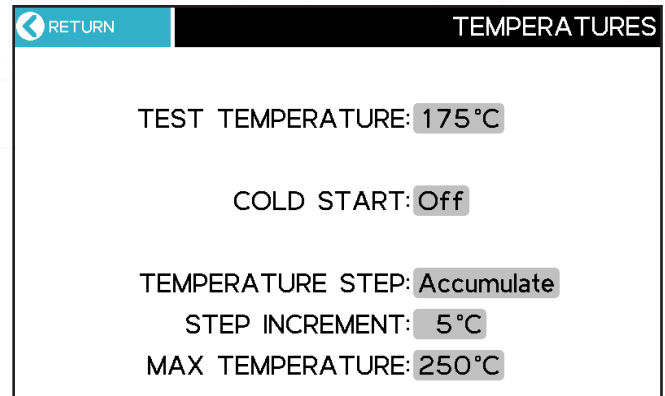
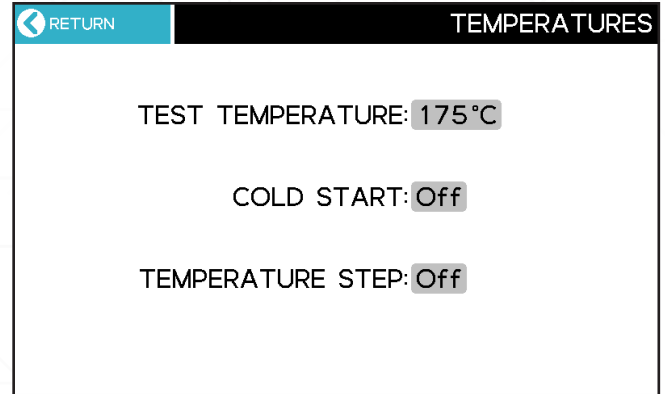

9.4. TEST END OPTIONS

Tests end based on the ending criteria specified for END ON, as explained below.

Rate: Ends the test when the moisture evolution rate drops below the set $\mu\text{g/s}$ value. Use RATE if you want to match an existing standard or method that utilizes RATE criteria (such as the KF titration method). This method is commonly used.

Predict: The instrument uses an exponential decay formula to calculate the final result before all moisture is driven from the sample. This function reduces test times without sacrificing result accuracy. Some sample materials are amenable to this feature, but many are not. If desired, try 'Predict' and compare results with the current method.

RELIABILITY determines how long the test should be run based on how close to the calculated value the current results must be., The process is based on the following equation.

$$\text{Reliability} = (\text{Current Moisture Measured So Far}) / (\text{Calculated Moisture}) * 100\%$$

Typically, 90% is a good starting value.

Time: Ends the test when the set time has elapsed. Fixed time ending is seldom superior to other ending criteria, but is useful when:

- Conducting application characterization tests,
- Investigating long-term stability of the instrument or material.

Time → Rate: Ends the test when the moisture evolution rate drops below the set $\mu\text{g/s}$ value after the set time has elapsed. This ending criterion is useful for:

- Samples that take a long time to heat up before evolving moisture (the rate curve stays low for a while before rising significantly).
- Samples that have a double peak evolution rate curve. Use the time set to extend the test past the first evolution rate peak.

These are only guidelines. Experiment with the sample to refine the size estimates to achieve the desired speed and accuracy. If using a rate-ending criterion, and the peak moisture rate is less than five (5) times the rate threshold, the sample sizes should not vary more than about 10%. A large sample size variation may lead to a larger result variation.

For your particular application, contact Customer Service for assistance in developing specific parameters.

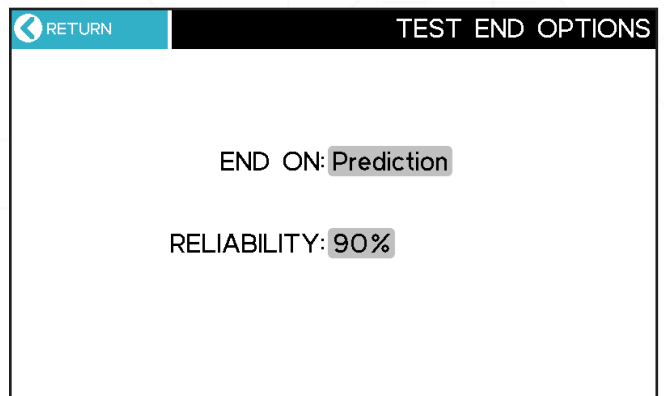
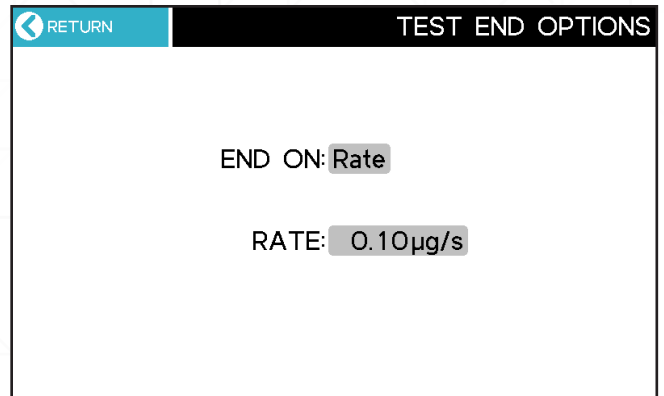

9.5. RESULT DISPLAY OPTIONS

Results can be displayed in selected units, as specified in the RESULT field:

- Parts per million water (ppm H₂O),
- Micrograms water (µg H₂O), or
- Percentage water (% H₂O), or
- Custom percentage water (% H₂O), explained on the next page.

Result display units, except µg H₂O, require SAMPLE WEIGHT ENTRY to be set in the TEST START OPTIONS, as explained in §9.2 TEST START OPTIONS (repeated on the next page for convenience).

PASS/FAIL – If PASS/FAIL is set to ON, a LOW LIMIT and a HIGH LIMIT can be specified for the Test Result.

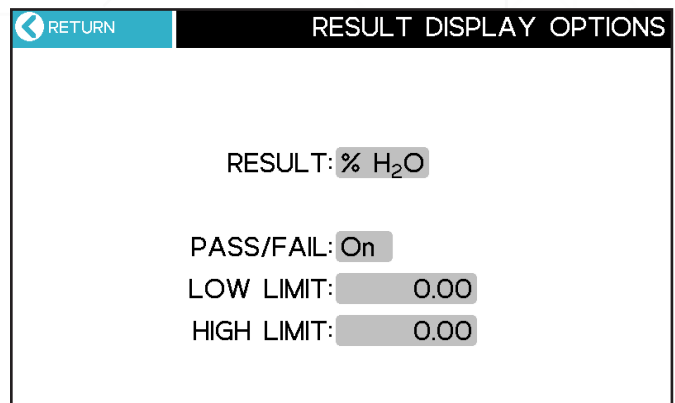
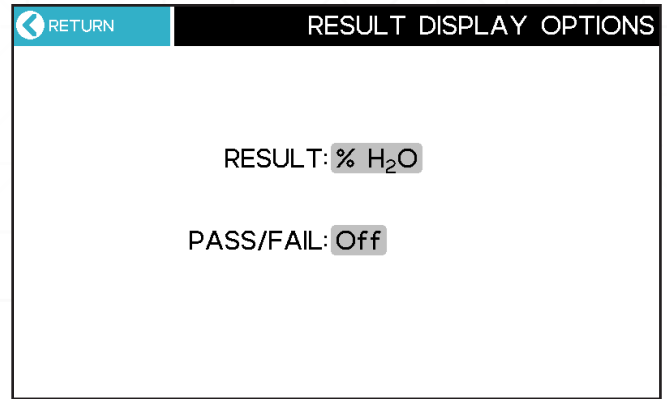

When the test completes, the Main Screen will be **GREEN** and show **[PASS]** to indicate Passing results or **RED** and show **[FAIL]** to indicate Failing results, as shown in the image. The corresponding results will also display with a **GREEN** or **RED** font in the Test Results listing, as shown on the right.

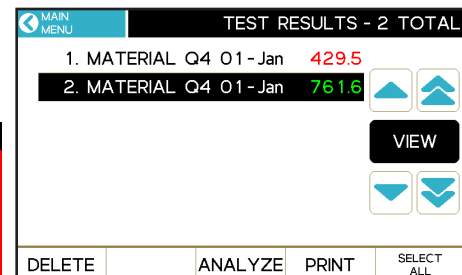
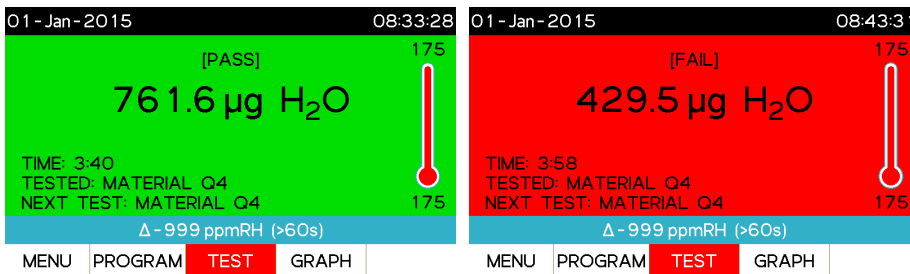

• **SAMPLE WEIGHT ENTRY – Select Manual or Balance:**

- **Manual:**
 - At the start of each test, the instrument will query the user for the sample's weight.
 - If fixed weight samples are used, enter the weight in the **DEFAULT WEIGHT** field. When the instrument queries for the weight, accept the default weight to proceed.
- **Balance:**
 - At the start of each test, the connected accessory balance is used to measure the sample weight, and the instrument queries the user for acceptance of the measured weight. This value can be manually overridden if desired.

Note: See §10 TEST RESULTS for instructions on entering the weight of the empty vial and cap after the test, for pre-sealed sample vials where the initial sample weight includes the weight of the vial, cap, and sample

- **DEFAULT WEIGHT** – If using **MANUAL** Sample Weight Entry and fixed weight samples, the default sample weight can be entered here, as noted above.
- **Custom percentage water (% H₂O)** – This feature is primarily used with very viscous samples that require dilution with an anhydrous liquid solvent to reduce the viscosity to facilitate sample handling. A **MULTIPLIER** is used to compensate for the change in sample weight caused by the additional weight of the solvent, as shown in the example below. Custom **UNITS** can be specified for the compensated Test Result.

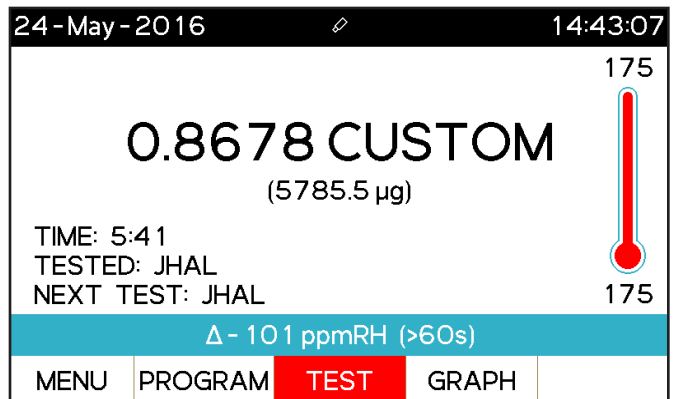
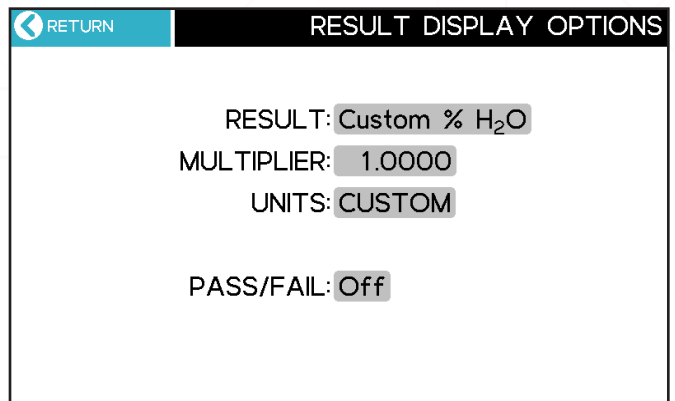
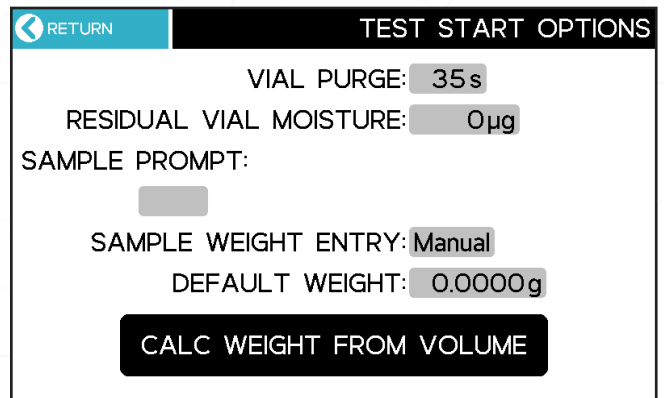

Example:

- Sample size: 2 grams
- Solvent added: 1 gram
- Total sample size: 3 grams
- Since the sample size was increased by 50% from 2 grams to 3 grams, the **MULTIPLIER** is set to 1.5000.

- The Vapor Pro® XL will multiply the percentage of water measured by the specified multiplier and then display it in the custom UNITS specified, as shown in the image, along with the total micrograms of water measured.

9.6. Vapor Pro XL w/Autosampler Pre-Purge Options

The Vapor Pro XL w/Autosampler comes with a function that allows the sample vial to be purged before starting the testing process. For some samples, resting on the carousel can either cause sample to absorb the vial headspace moisture resulting in a higher result bias as testing goes on or lose moisture into the vial headspace causing a lower result bias due to sample volatility. This option minimizes or eliminates this issue.

- Select the test program that you want to have Pre-Purge activated by selecting [Menu] → [Test Programs] → [*Program Name*] → [Autosampler Options] → [Pre-Purge] then toggle the [Pre-Purge] option from “No” to “Yes”.

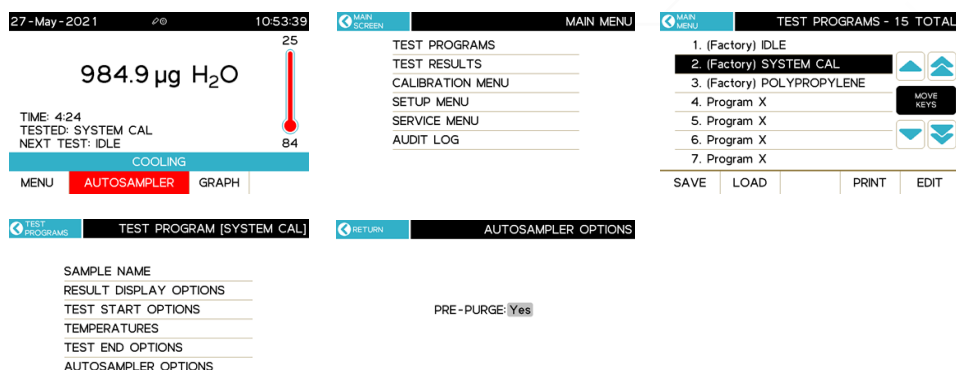

Figures 1-5 Showing the Path to Pre-Purge

- IMMEDIATELY after selecting “Yes” for Pre-Purge on your program of choice, switch the program to [(Factory) Idle] by means of [Menu] → [Test Programs] → [(Factory) Idle].
 - Pre-Purge will work if the Vapor Pro XL w/Autosampler is under 50°C, setting it to [(Factory) Idle] will allow the instrument to cool down from the previous setting it was on, if any.
- Once cooled to 50°C or below, go into the Autosampler Program selection screen by selecting [Autosampler] then choosing [Edit] in any available Autosampler Position to finally selecting your [*Program Name*] with Pre-Purge enabled.

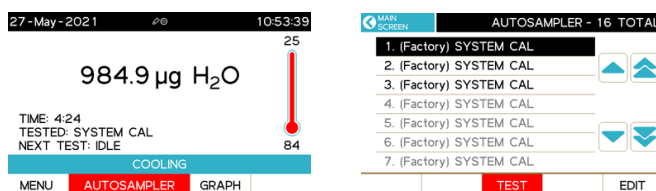

Figures 6-7 Showing Autosampler Edit Path

- To verify that Pre-Purge has been enabled, you will see a [Purge Vial] button under the program name.

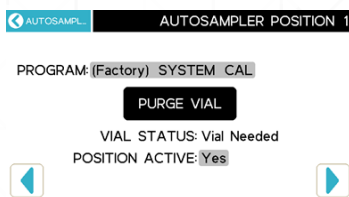

Figure 8 [Purge Vial] button

- Prep and load the sample as instructed from the Getting Started section. Once the vial has been placed in position and had its weight entered (if applicable), push the [Purge Vial] button to begin the purging process.
 - The purge time is the purge set in the program selected.
- When the purging process is finished, the vial will be ejected from the Vapor Pro XL w/ Autosampler into its set position with the [Purge Vial] button being replaced with "Vial Purged".

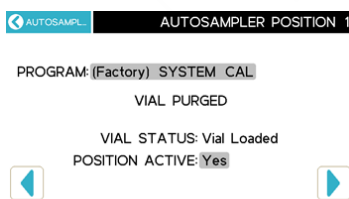

Figure 9 Vial Purged Confirmation

- Repeat the above steps as desired.
 - NOTE: it is highly recommended to Pre-Purge vials immediately after they have been prepped (i.e., weighed, capped/sealed, then loaded into the Vapor Pro XL w/ Autosampler) to avoid idle vaporization or adsorption of the sample.
- Once all desired vials have been purged, highlight the first available program, and select [Test] to begin heat up and testing.

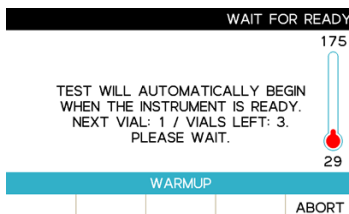

Figure 10 Vapor Pro XL w/Autosampler Heating after Pressing Test

- Once the instrument heats up to the specified temperature, it will begin the test immediately, skipping the purge.
- The Vapor Pro XL w/Autosampler will continue testing as normal until all tests are finished.

Standard Purge and Pre-Purge Graphs

There are some differences between the graphs when using the Pre-Purge opposed to Standard Purge. The following graphs are from System Calibration's using both purge types.

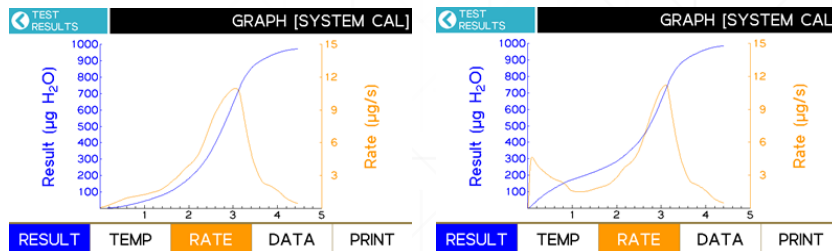

Figure 11-12 Standard Purge System Calibration (Left) Pre-Purge System Calibration (Right)

The graph on the left is the resulting graph using Standard Purge using the 1µL microcaps while the right graph uses the Pre-Purge. Due to the nature of water in the microcaps, the water evaporates quickly even if just removed from water source. It is always recommended to quickly test microcaps as they will evaporate into the vial and critical moisture will be lost during the purge.

Normally, you place a filled 1µL microcap into a test vial, seal it with cap and septa, place the vial into the transport and begin the test. This should be a rapid process from filling the microcap to testing it on the Vapor Pro XL. When testing multiple microcaps using the Vapor Pro XL w/Autosampler, under the standard setting, water will evaporate into the vial while it is sitting on the carousel waiting to be tested. The more microcaps waiting, the lower result bias over time of testing.

When using the Pre-Purge option, the microcap is to be filled, sealed with cap and septa, placed in a carousel position, press the Pre-Purge button, then when it is finished it will sit on the carousel until all other vials have been purged. The step from filling the microcap to purging is the most critical in the analysis as you can have a vial stand idle for some time after it has been purged as the only contents of the vial at that time will be the sample and dry air or nitrogen.

The right graph shows a tested microcap having sat for 3minutes after the Pre-Purge process. The initial peak is the water evaporating into the vial from the microcap and being recorded as a result. The Pre-Purge graph has a narrower major peak than the Standard Purge graph as, again, it lost water into the vial due to evaporation resulting in a narrower peak.

In either method, moisture content was close to the required specification of 1000µg±50µg of water.

9.7. Saving And Loading Test Programs

Test Programs can be saved to a USB drive from the Vapor Pro® XL for storage/archive or transferring and loading into a different Vapor Pro® XL from a USB drive. This function can help ensure that the Test Programs are the same on all of the Vapor Pro® XL's at your facility or across your organization.

From the Test Programs listing, if the **I/O KEYS** (SAVE, LOAD, TEST, PRINT, and EDIT) are not displayed, press **I/O KEYS** to

MAIN MENU		TEST PROGRAMS - 7 TOTAL		
		1. (Factory) IDLE		
		2. (Factory) SYSTEM CAL	▲	▲
		3. (Factory) POLYPROPYLENE		
		4. MATERIAL 323		MOVE KEYS
		5. COMPOUND X		
		6. COMPOUND Z	▼	▼
		7. LYO BATCH 12		
SAVE	LOAD	TEST	PRINT	EDIT

display them.

Press **[SAVE]** to save Test Programs to a USB drive or **[LOAD]** to load them from a USB drive, and then follow the on-screen instructions.

When saving Test Programs, they can be selected individually by touching them or **[SELECT ALL]** to select them all.

The Test Programs will be saved in a comma-separated values (.csv) format to the file TESTPGM.CSV on the USB drive. If the file already exists, it will be overwritten. The Vapor Pro® XL will prompt for confirmation if the file already exists on the drive.

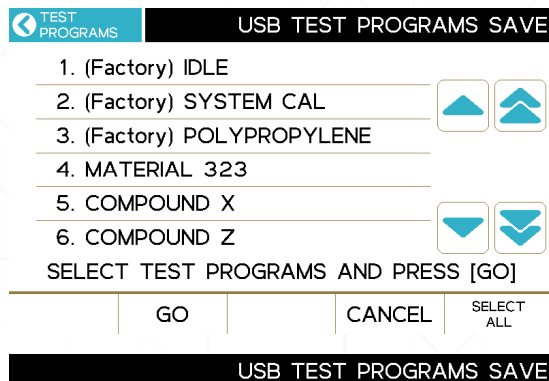

FILE [TESTPGM.CSV] EXISTS

OVERWRITE

CANCEL

10. TEST RESULTS

The TEST RESULTS menu is used to view or print Test Results and Test Graphs and perform statistical analysis of Test Results.

Selecting TEST RESULTS will display the Test Results stored in the instrument.

Touch a Test Result to select it or use the arrow keys to scroll to the desired Test Result.

To print the Test Result, select it, and press **[PRINT]**.

Touching a Test Result and pressing **VIEW** displays the details of the Test Result. Use **▲** and **▼** to scroll through the pages of information for the Test Result. Using **◀** and **▶** will switch to the details of the previous or next Test Result, respectively.

To enter the empty vial weight after the test, select **[VIAL WT]** to input the weight of the empty sample vial and cap; the test result is recalculated.

Select **[GRAPH]** to access the Test Graph for the Test Result being displayed. Press **[RESULT]**, **[TEMP]**, or **[RATE]** to toggle the display of the respective curve. **TEMP** and **RATE** cannot be displayed together.

MAIN MENU

TEST RESULTS - 305 TOTAL

1. POLYPRO	12-Feb	0.0104
2. POLYPRO	12-Feb	0.0093
3. POLYPRO	12-Feb	0.0102
4. POLYPRO	12-Feb	0.0099
5. PEEK	12-Feb	92.7
6. 5.5% STD	10-Feb	0.0042
7. 1% STD	05-Feb	1.0028

VIEW

DELETE ANALYZE PRINT SELECT ALL

TEST RESULTS

TEST RESULT [POLYPRO]

1/4

SAMPLE NAME: POLYPRO 1

LOT NUMBER:

ID:

DATE: 12-Feb-2016

TIME OF DAY: 15:36

FINAL RESULT: 0.0104% H₂O

PASS/FAIL:

BOT WT GRAPH

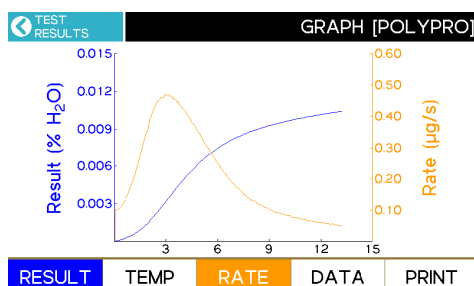

Pressing **[RESULT]** displays the graph of the result in **BLUE** on the left vertical axis versus time.

Pressing **[RATE]** displays the graph of the moisture loss rate in **ORANGE** on the right vertical axis versus time.

Pressing **[TEMP]** displays the graph of the temperature in **RED** on the right vertical axis versus time.

Press **[PRINT]** to print the Test Graph to a connected printer.

Press **[DATA]** to return to the Test Result detail screen.

To select multiple results for statistical analysis, touch each desired Test Result. An orange triangle will display next to the selected Test Results.

When the desired Test Results have been selected, press **[ANALYZE]** to perform statistical analysis. Press **PRINT** to print the analysis.

Individual Test Results can be deleted by selecting them and pressing **[DELETE]**, or all Test Results can be deleted by pressing **[SELECT ALL]** and then **[DELETE]**. The Vapor Pro® XL will prompt for confirmation before deleting the selected records.

TREND GRAPH can be performed from the **TEST RESULT ANALYSIS** screen.

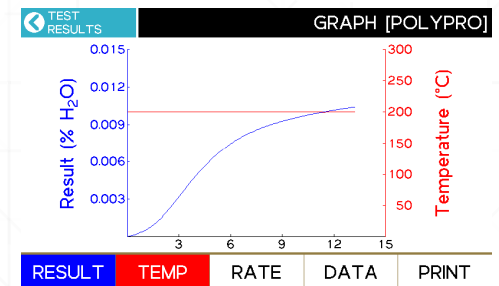

MAIN MENU TEST RESULTS - 305 TOTAL

▶	1. POLYPRO	12-Feb	0.0104	
▶	2. POLYPRO	12-Feb	0.0093	▲ ▲
▶	3. POLYPRO	12-Feb	0.0102	
▶	4. POLYPRO	12-Feb	0.0099	VIEW
	5. PEEK	12-Feb	92.7	▼ ▼
	6. 5.5% STD	10-Feb	0.0042	
	7. 1% STD	05-Feb	1.0028	

DELETE ANALYZE PRINT SELECT ALL

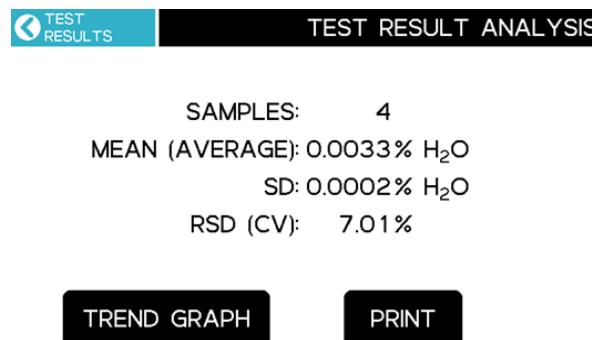
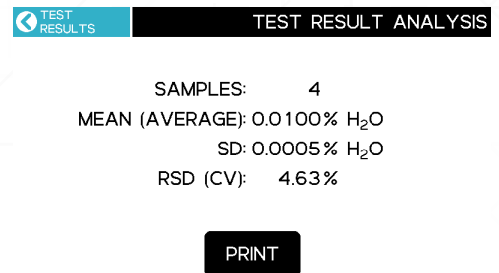

The selected test results are plotted over time from the oldest test date to the latest test date. Note, the graph has a X/Y margin, so the 0 result is above the X-Axis and the earliest date/time is right of the Y-Axis.

Note: On 21 CFR, Part 11 instruments, Test Result deletion is disabled.

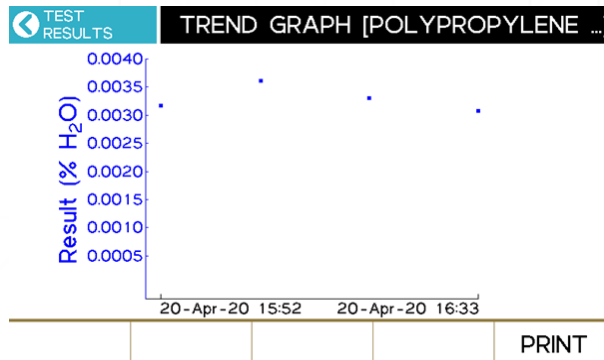

If the latest test selection had PASS/FAIL enabled in the test program, then test result limit lines are shown and the graph dots are turned GREEN/RED for PASS/FAIL respectively.

11. CALIBRATION MENU

The calibration functions available to the end user are on this menu.



They are:

- Flow Sensor Calibration
- System Calibration and Verification
- Temperature Calibration and Verification

FLOW SENSOR CONSTANTS
 RH SENSOR CONSTANTS
 SYSTEM CALIBRATION MENU
 TEMP CALIBRATION MENU

Temperature Calibration, if performed, should be done before any System Calibration.

NOTE: The calibration steps described in this section may invalidate the instrument factory calibration if not performed as directed. Contact Customer Service if you have any questions about performing these calibrations.

Any other instrument calibrations can only be performed at the factory or by certified AMETEK Brookfield Field Service Engineers.

11.1. CALIBRATION → FLOW SENSOR CONSTANTS

If a digital volumetric flow meter is connected to the exhaust port, then the internal flow sensor can be calibrated by recalculating the Flow Correction Factor (FLOW CF) by following these steps:

- Remove the plug from the exhaust port (above the N2 input) and install the included Hose Barb (P/N: 345-0113).
- Connect a digital volumetric flow meter to the exhaust port.
- Measure the flow.
- Use the equation below to calculate the new FLOW CF, and then enter it in the FLOW CF field:



FLOW: 97.65mL/min
 LAST CALIBRATION: 01 - Jan - 2015
 FLOW CF: 1.145
 FLOW @: 725mmHg
 FLOW @: 24°C

$$NewFLOWCF = CurrentFLOWCF \times \frac{ExternalFlowMeterValue}{ScreenFlowValue}$$

The instrument displayed flow value, and the flow meter value should be within 0.2 mL/min after the FLOW CF is updated.

- The LAST CALIBRATION date shown here will be updated when the FLOW CF is updated.

NOTE: Do not modify the FLOW @ values.

11.2. CALIBRATION → RH SENSOR CONSTANTS

Do not change any of the values on this screen. Constants in this menu should only be modified with factory consultation. Changing these values can adversely affect instrument performance. Typically, these values are for factory use only.

11.3. CALIBRATION → SYSTEM CALIBRATION

System calibration and verification ensure that the instrument is accurately measuring evolved moisture. Daily verification is recommended. If verification fails, the system can be recalibrated.

The system is calibrated and verified using the same procedure, as described below. The difference between calibration and verification is how the results are used:

- When a system calibration is performed, the instrument uses the selected tests to recalibrate the system.
- When verification is performed, the instrument analyzes the selected tests to confirm successful system calibration.

Procedure for Calibration or Verification:

- Select either PERFORM CALIBRATION or PERFORM VERIFICATION, as appropriate, and proceed as follows:
- Read the on-screen instructions.
- Select [TEST] to perform three or more tests (five tests are the recommended maximum).
- The instrument will switch to the “(Factory) SYSTEM CAL” test program and return to the Main Screen.
- See §11.3.1 Pipe e Loading on page 43 to load pipe es before a test.
- Load the vial into the ramp (standard VPXL) or carousel posi on #1 (Autosampler).



VIEW CALIBRATION REPORT
 PERFORM CALIBRATION
 PERFORM VERIFICATION

- When the system status is “READY” on the Main Screen, press TEST and follow the on-screen instructions to perform the test. Each test takes 3 to 5 minutes. For Autosampler systems, press AUTOSAMPLER, set position 1 to SYSTEM CAL, return to the MAIN SCREEN and press TEST.
- After testing, return to the PERFORM CALIBRATION or PERFORM VERIFICATION menu, as appropriate, but instead of pressing TEST, press SELECT to display the completed tests.
- Touch the desired tests and then select [CALC] to proceed or [CANCEL] to exit.
- After calculating is complete:
 - If calibrating: If the SD \leq 30 μ g, select SAVE.
 - If verifying: If the Mean is within 950 μ g to 1050 μ g and SD \leq 30 μ g, select SAVE.
 - If the verification Mean is out of spec, use the water tests for calibration instead by exiting and selecting PERFORM CALIBRATION, and then selecting the tests.

- After SAVE, the calibration report is displayed. Use VIEW CALIBRATION REPORT to view the report later.
- If calibration was performed, repeat the above steps to perform a verification.

11.3.1. Pipette Loading

Consumables for calibration:

- Sample Vial - 990-0229
- Septa for Sample Vials - 990-0
- 1.0 μ L Microcaps Pipette, 100/container - 990-0

- Carefully remove a 1.0 μ L Microcap Pipette [P/N 990-0150] from the storage container. Use forceps or tweezers [P/N 690-0028] to handle the tube.
- A new pipette is recommended for each test. However, most pipettes can be successfully loaded twice, while a third use often fails to load the pipette fully.
- Use a new sample vial to hold purified or deionized (DI) water for testing. Keep the DI vial loosely capped during testing to prevent dust from getting into the water. After testing, tightly cap the vial for future testing.

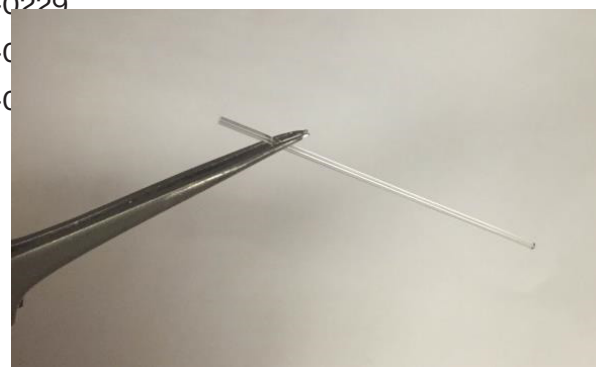

SYSTEM CALIBRATION

SYSTEM CALIBRATION is performed by:
First complete 3 or more 1000 μ g water tests and then SELECT the tests to use for calibration.

FIRST, SELECT **TEST**

THEN, SELECT **SELECT**

SYSTEM VERIFICATION

SYSTEM VERIFICATION is performed by:
First complete 3 or more 1000 μ g water tests and then SELECT the tests to use for verification.

FIRST, SELECT **TEST**

THEN, SELECT **SELECT**

- Just touch the end of the pipette into the water. The pipette must be in contact with the water long enough to fill, about 10 seconds. Swishing the pipette end in the water can reduce loading time. If the pipette is not full, the reading will be low.
- Pull the pipette straight out of the water. Excess moisture may be on the side of the pipette, which causes high readings. Wipe the bottom end of the pipette between a clean finger and thumb. (A folded Kimwipe® tissue can be used too, but wipe quickly. Tissues can easily wick water out of the pipette, so start by applying pressure to the tissue above the pipette and quickly pull the tissue towards the end and off the pipette. Minimize all tissue contact with the pipette end.)
- Angle a cool, dry sample vial and gently place the pipette just past the vial's neck, as shown in the image. Let the pipette slide to the vial's bottom. Dropping or shaking the pipette causes water loss and erratic results.
- Install a septum into a dry cap [P/N 990-0206], so the shiny side of the septum (the Teflon® liner) is facing into the sample vial, and then screw it on. (The other silicone side of the septum must be facing out of the vial or results will be affected). Initially, use a new septum; one septum is good for multiple tests.
- Gently place the sample vial onto the transport and close the vial ramp cover.



11.4. CALIBRATION → SYSTEM CALIBRATION → VIEW CALIBRATION REPORT

The SYSTEM CALIBRATION REPORT shows the last calibration and verification results. It also shows the system linearity calibration and linearity verification, which are performed at the factory.

SYSTEM CALIBRATION	SYSTEM CALIBRATION REPORT	SYSTEM CALIBRATION	SYSTEM CALIBRATION REPORT	SYSTEM CALIBRATION	SYSTEM CALIBRATION REPORT
SYSTEM CALIBRATION: 11-May-2016 CAL AMOUNT: 1000 µg CF: 1.284		LINEAR CALIBRATION: 11-May-2016		LINEAR VERIFICATION: 11-May-2016	
SYSTEM VERIFICATION: 11-May-2016 SAMPLES: 3 MEAN (AVERAGE): 1001.0 µg H ₂ O SD: 11.9 µg H ₂ O RSD: 1.19%		0.0 0.760 2.0 0.817 10.0 0.831 30.0 0.968 100.0 1.000		STANDARD MEASURED RESULT	
LINEAR CAL PRINT		LINEAR VERIFY PRINT		100 µg 99.1 µg Pass	
				500 µg 500.3 µg Pass	
				1000 µg 986.4 µg Pass	
				3000 µg 2924.5 µg Pass	
				10000 µg 9934.3 µg Pass	
				SUMMARY PRINT	

11.5. CALIBRATION → TEMPERATURE CALIBRATION

The temperature calibration and verification process takes approximately 3 hours.

Temperature Calibration Interface (TCI) Kit:

- P/N: Y990-0142 (115 VAC)
- P/N: Y990-0165 (230 VAC)
- Turn off the Vapor Pro® XL.
- Install the Temperature Calibration Probe into the calibration port to the rear of and below the vial ramp, as shown in the image. For autosampler, remove the carousel and open the internal cover for access.
- The probe must be inserted all the way in until the handle touches the case.
- Using the included 9-pin serial cable, connect the black Temperature Calibration Interface (TCI) box to the TCI port (marked TCI / BALANCE) on the Vapor Pro's back panel® XL. The TCI and probe serial numbers and calibration date shown on the TCI box will be recorded below.

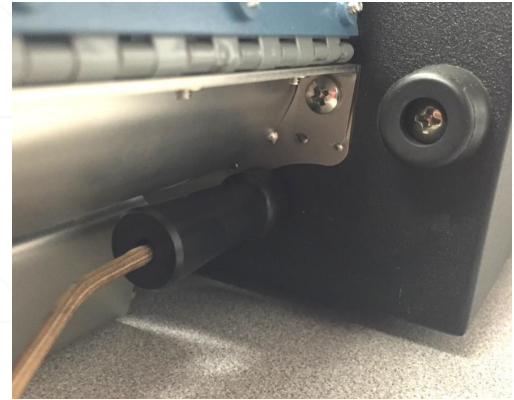

- Plug the AC adaptor into the appropriate AC outlet and connect it to the TCI box.
- Turn on the Vapor Pro XL®.
- Navigate MAIN MENU → CALIBRATION MENU → TEMP CALIBRATION MENU
- Select the CALIBRATION MODULE SETUP and enter the appropriate data for the MODULE serial number, PROBE serial number, and calibration date (CAL DATE), as listed on the labels on the TCI box. Then, press the upper left corner of the screen to return to the TEMP CALIBRATION MENU.
- From the TEMP CALIBRATION MENU, select VERIFICATION SETUP. The purpose of the verification function is to confirm whether the calibration was successful at a given set of

CALIBRATION MENU TEMP CALIBRATION MENU

VIEW CALIBRATION REPORT
VERIFICATION SETUP
CALIBRATION MODULE SETUP
PERFORM CALIBRATION
PERFORM VERIFICATION
CALIBRATION REMINDER SETUP

TEMP CALIBRATION CALIBRATION MODULE SETUP

MODULE #: 1420384

PROBE #: 1020644

CAL DATE: 11 - Feb - 2016

temperatures. The verification process can automatically follow the calibration by selecting Yes at the AUTO VERIFY AFTER CAL prompt. The rest of these instructions assume that the verification is run automatically, i.e., AUTO VERIFY AFTER CAL is set to Yes.

- If desired, set ADDITIONAL VERIFY TOL to a wider range than the standard verification tolerance of within ± 1.0 °C. Otherwise, leave set to “0.0°C.”
- If desired, set POINTS TO VERIFY to 1 to 4 Custom Points for specific verification temperatures. Otherwise, leave set to “All Cal Points.”
- To set specific verification temperature(s), touch the gray text box for the desired CUSTOM POINT to edit it. The selected temperatures should best represent those used for your product(s).
- When the VERIFICATION SETUP options are set as desired, press the upper left screen corner to return to the TEMP CALIBRATION MENU.

- Select PERFORM CALIBRATION; the next screen prompts you to attach the temperature calibration device. If the device is hooked up, press START.
- When the verification is complete, the instrument displays the TEMP VERIFICATION RESULTS. The DETAIL page shows the Pass/Fail results at each checkpoint.

- If the unit failed at any given point, rerun the calibration to improve the results.
- If a printer is connected, select PRINT to print out the calibration report.
- Calibration is complete.
- Disconnect the calibration module.

TEMP CALIBRATION VERIFICATION SETUP

AUTO VERIFY AFTER CAL: Yes

ADDITIONAL VERIFY TOL: 0.0°C (± 1.0 °C)

POINTS TO VERIFY: All Cal Points

TEMP CALIBRATION VERIFICATION SETUP

AUTO VERIFY AFTER CAL: Yes

ADDITIONAL VERIFY TOL: 0.0°C (± 1.0 °C)

POINTS TO VERIFY: 4 Custom Pts

CUSTOM TEMP VERIFICATION POINTS:

CUSTOM POINT 1: 100°C

CUSTOM POINT 2: 150°C

CUSTOM POINT 3: 200°C

CUSTOM POINT 4: 250°C

TEMP CALIBRATION TEMPERATURE CALIBRATION

TEMPERATURE CALIBRATION TAKES 3 HOURS TO COMPLETE.

ATTACH THE TEMPERATURE CALIBRATION MODULE TO THE SERIAL PORT, AND INSERT THE PROBE INTO THE CALIBRATION PORT.

PRESS [START] TO CONTINUE

START

TEMP CALIBRATION TEMP VERIFICATION RESULTS

INSTRUMENT	TCI	DIFFERENCE
50.0	50.0	0.0 Pass
99.8	99.8	0.0 Pass
150.0	149.8	0.2 Pass
199.3	199.3	0.0 Pass
249.2	249.1	0.1 Pass
273.7	273.7	0.0 Pass

SUMMARY PRINT



The probe may be hot from the last calibration or verification. So, grab the probe only by the handle.



12. SETUP MENU

The SETUP MENU is used to set up and configure the instrument options described in this section.

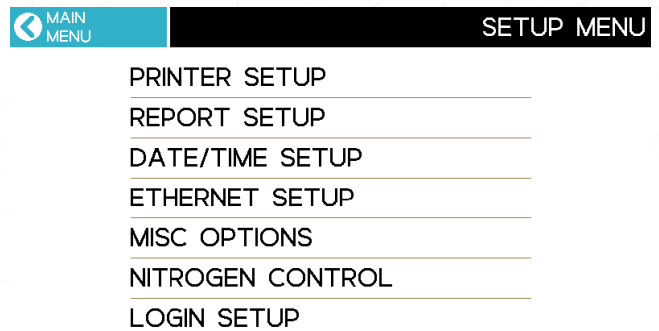

Check for Autosampler setup items

12.1. SETUP → PRINTER SETUP

PRINTER SETUP is used for configuring where data is sent whenever a PRINT button is pressed on the instrument. Available data output options are output to a computer, a printer, a USB drive, or any combination thereof, as shown in the image below. Note: Test Graphs are only sent to the printer.

The following options are available:

- OUTPUT TO COMPUTER sends reports to the USB PC port.
- OUTPUT TO USB DRIVE sends reports to a USB drive. Make sure to insert the drive in the USB host port (marked USB) before printing a report. When a report is printed, a file name is constructed from the instrument's serial number with a ".TXT" extension (for example, "42000000.TXT"), and the report is saved to the drive. As reports are printed, they are appended to this file. Always wait 5 seconds after a report finishes before removing the drive to allow the instrument to close the file. Otherwise, drive corruption can occur.
- OUTPUT TO PRINTER sends reports to a printer. If using the standard printer [P/N Y990-0212], TEST PRINT can send a test pattern to the printer to check the functionality. The TEST PRINT does not send the test pattern to a connected computer or USB drive.

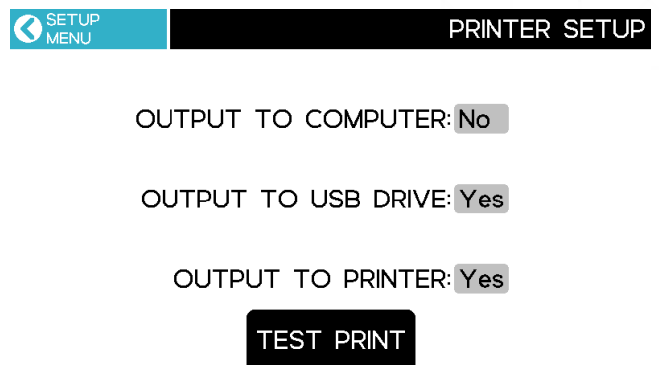

12.2. SETUP → REPORT SETUP

This menu enables and customizes reports.

SETUP
MENU

REPORT SETUP

REPORT CONTROL OPTIONS

REPORT ITEMS TO PRINT

COMPANY NAME

12.2.1 SETUP → REPORT SETUP → REPORT CONTROL OPTIONS

The report control options enable automated reports to be printed.

REPORT
SETUP

REPORT CONTROL OPTIONS

FINAL TEST REPORT: Off

TEST PROGRESS: Off

FINAL TEST GRAPH: Off

The following options are available:

- FINAL TEST REPORT – when set to On, a test report prints after a test is complete.
- TEST PROGRESS – when set to On, progress reports are printed during a test, at the selected interval. Intervals of 1 second, 5 seconds, 10 seconds, 15 seconds, 30 seconds, and 1 minute are available. Shorter intervals can be useful for test program development, while longer intervals are more helpful during normal use.
- FINAL TEST GRAPH – when set to On, a moisture graph is automatically printed after the test completes. Graphs are sent only to the printer, not to the computer or USB drive.

12.2.2. SETUP → REPORT SETUP → REPORT ITEMS TO PRINT

Test Results include information that may not be needed in your application. Touch to select which items are required on the test report. The selected items are indicated by checkmarks, as shown in the image.

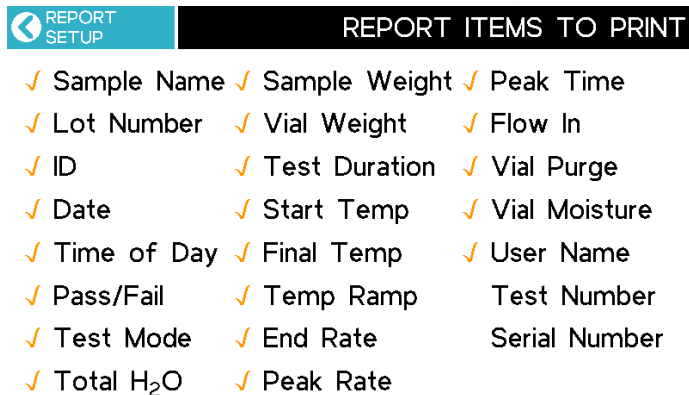

12.2.3. SETUP → REPORT SETUP → COMPANY NAME

The COMPANY NAME prints at the top of reports and may be used for the company name, test location, or other information.

12.2.4. SETUP → DATE/TIME SETUP

Use this function to change the TIME and DATE at the initial setup or when updating the time for daylight savings time. Time is in a 24-hour format.

An internal battery maintains the correct time and date when the power is off. If an “RTC Battery Failure” occurs or the clock resets when the power is turned off and on, the internal backup battery may need to be replaced. If this happens, call Customer Service. A battery failure does not affect the instrument’s Test Programs, Test Results, or configuration options.



TIME: 13 : 40

DATE: 07 - Dec - 2015

12.3. SETUP → ETHERNET SETUP

An optional Web Server can be purchased so that a Windows® PC can access the Vapor Pro® XL from your local area network (LAN) or intranet with Internet Explorer® (IE) v6 or higher, or Edge browser. Use the Ethernet Setup menu to configure the connection. Generally, the instrument cannot be viewed on the Internet because of company firewalls. But in some cases, it is possible and requires a registered IP address.

If the Web Server option is not purchased, the instrument can still be accessed over the intranet to test the LAN connection. However, reports, data, and other functionality will not be available.

The following options are available from the ETHERNET SETUP screen:

- NAME & PASSWORD are used to restrict access to the instrument over the intranet. When prompted by the browser, enter the assigned NAME value for the user name and enter the assigned PASSWORD for the password to gain access to the instrument. NOTE: For best security, do not reuse a password.
- OBTAIN IP ADDRESS options are:
 - Ethernet Off - disables the Ethernet port.
 - Manual - requires the manual entry of IP ADDRESS, SUBNET MASK, and GATEWAY. Consult with your Information Systems (IS/IT) department for the correct settings.
 - Automatic (factory default) - sets everything automatically. A DHCP server on the network is required to use automatic mode. This mode is useful to check the operation of the Web Server. However, because the DHCP server may assign a new IP address each time the instrument is powered on, the end user would need to check the instrument Ethernet Setup screen to verify that the correct instrument IP address is used by the browser. Therefore, the Manual mode is generally preferred.
- MAC ADDRESS is factory set and is unique to every Internet device. It may be helpful to your IS/IT department.

If OBTAIN IP ADDRESS is set to Manual, do not use an IP address for the instrument that conflicts with another IP address on your network. Conflicting IP addresses may cause network crashes or instability. As an additional safeguard against conflicts, the instrument will not accept IP addresses ending in .255 or .1.

See §17 **WEB SERVER** for details on the Web Server. Call Customer Service for more information or to purchase and activate the Web Server.

ETHERNET SETUP

NAME: VPXL

PASSWORD: [REDACTED]

OBTAIN IP ADDRESS: Automatic

IP ADDRESS: 192 . 168 . 4 . 31

SUBNET MASK: 255 . 255 . 252 . 0

GATEWAY: 192 . 168 . 4 . 1

MAC ADDRESS: 00-08-50-02-00-16



12.4. SETUP → MISC OPTIONS

The following options are available:

- OVEN FAN ENABLED – when set to the default value of Yes, the oven fan turns on to speed cooling between tests. This feature helps decrease the cooling time required between tests at different temperatures.
- LOT NUMBER - if enabled, starting a test displays the ENTER LOT NUMBER AND ID screen. These entries may be used to insert the lot designation and unique product identifier into reports. This feature is turned Off by default.
- If the LOT NUMBER and PRODUCT ID are barcoded on the samples, the values can be scanned using the Bar Code Reader [P/N: 990-0231]. Access the desired field, so the keyboard is displayed, and then scan the corresponding bar code to populate the field.
- STANDBY TIMEOUT reduces the oven temperature to the STANDBY TEMP after the specified timeout. When testing at high temperatures of 200 °C or higher, we recommend using this feature to reduce system wear and conserve power.



OVEN FAN ENABLED: Yes

LOT NUMBER: No

STANDBY TIMEOUT (0=DISABLE): 60min

STANDBY TEMP: 100°C



LOT NUMBER:

ID:

PRESS [TEST] TO CONTINUE

TEST

ABORT

12.5. SETUP → NITROGEN CONTROL

If using nitrogen gas cylinders, use this feature to conserve nitrogen when the instrument is idle. When nitrogen flow is off, selecting [TEST] on the Main Screen restarts the flow. The instrument waits for the flow to stabilize, and the test will begin when the system is READY.

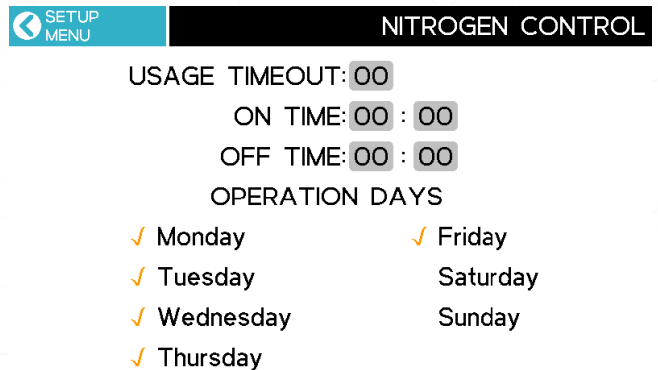

The following options are available:

- USAGE TIMEOUT enables a timeout, measured in minutes when the instrument is idle. Once the timeout reaches zero, nitrogen is shut off.
- ON TIME, OFF TIME, OPERATION DAYS – When ON and OFF times are different, the system shuts down nitrogen when outside of the specified times on the specified days. To test during the off times, set the usage timeout to enable nitrogen with a timeout even during the off times.

12.6. SETUP → LOGIN SETUP

This menu allows the setup of user logins. If User Login is active, access to calibration and configuration options can be restricted to authorized users. Users must log in before testing, and the user name is recorded with each test result. Up to 20 users can be added.

LOGIN SETUP options are:

- ACTIVATE LOGIN: If enabled, users are required to log in before testing. Users log in and log out using the [LOGIN] and [USER] keys on the Main Screen (shown).
- ADMIN KEY is the key required to access this LOGIN SETUP menu if restricted access to this menu is desired.
- USERS - Access the USER EDIT list screen to perform edits to the user list.

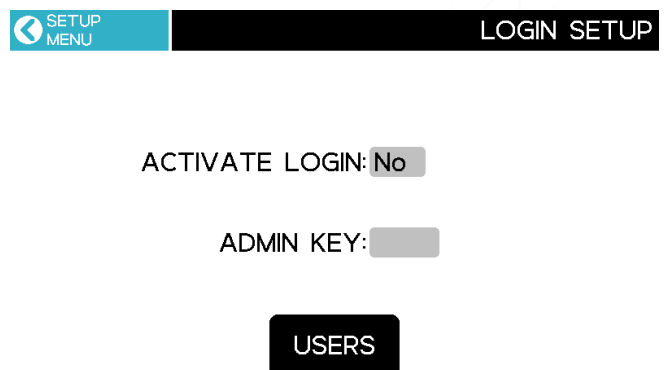

USER EDIT list options are:

- [EDIT] - Edit the user record.
- [CUT] - Copy the current user into temporary memory and delete it from the list. The user can be optionally inserted at another location using [INSERT↑] or [INSERT↓].
- [ADD] - Add a new user to the list.
- [INSERT↑] or [INSERT↓] - Insert the user who has been CUT into the list either above or below the current user. The following users are moved down.

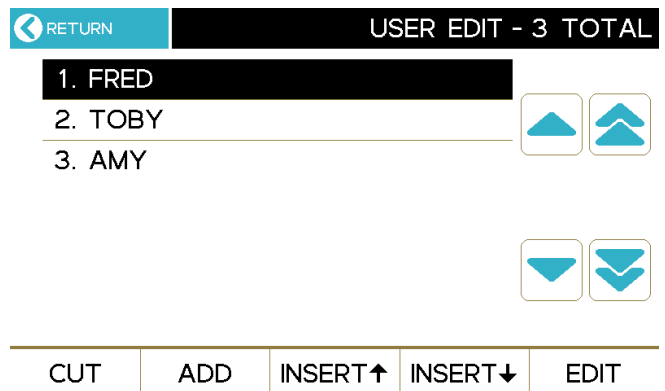

USER EDIT list options are:

- NAME - Set to the desired user name
- KEY - If desired, set the Access key (password) for this user.
- CALIBRATION USER – Allows the user to perform system calibrations.
- CONFIGURATION USER - Allows the user to change the system configuration and Test Programs.

USER EDIT

NAME: FRED

KEY: A1B2C3

CALIBRATION USER: Yes

CONFIGURATION USER: Yes

Users without Calibration and Configuration rights can run tests but cannot delete Test Results or Audit Log entries.

When user login is activated, [LOGIN] or [USER] is displayed on the Main Screen.

12-May-2016 13:50:24

1014.0 µg H₂O

180

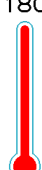

TIME: 3:41
TESTED: SYSTEM CAL
NEXT TEST: MATERIAL 323

180

✓ READY TO TEST

MENU PROGRAM **TEST** GRAPH LOGIN

12-May-2016 13:50:40

1014.0 µg H₂O

180



TIME: 3:41
TESTED: SYSTEM CAL
NEXT TEST: MATERIAL 323

180



✓ READY TO TEST



MENU PROGRAM **TEST** GRAPH USER

Selecting [LOGIN] displays the USER LOGIN list screen. Select the desired user. If the user has an access key, then the USER KEY ENTRY screen is displayed.

RETURN USER EDIT - 3 TOTAL

1. FRED
2. TOBY
3. AMY

CUT ADD INSERT↑ INSERT↓ EDIT

RETURN USER KEY ENTRY [HANS]

ENTER KEY:

To change users or to see what user is currently logged in, select [USER] and then select LOGOUT to log out the indicated user and return to the Main Screen or EXIT to keep the current user logged in and return to the Main Screen.

MAIN SCREEN USER INFORMATION

NAME: FRED

LOGOUT
EXIT

13. SERVICE MENU

Use this menu to check the system condition. The Sensor Readings provide valuable troubleshooting information for you and Customer Service.

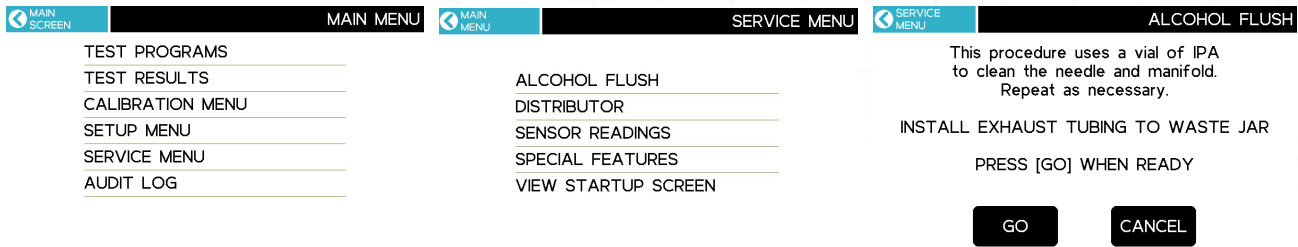

Check for Autosampler service items

13.1. SERVICE → DISTRIBUTOR

This screen displays the designated service provider for the instrument.



13.2. SERVICE → SENSOR READINGS

The information on this screen is used by the factory, or when checking or adjusting the flow, as described in “18.6. Flow Check and Adjustment” on page 68.

Changing any of the items on this screen, unless directed by the factory or this manual, is not recommended.

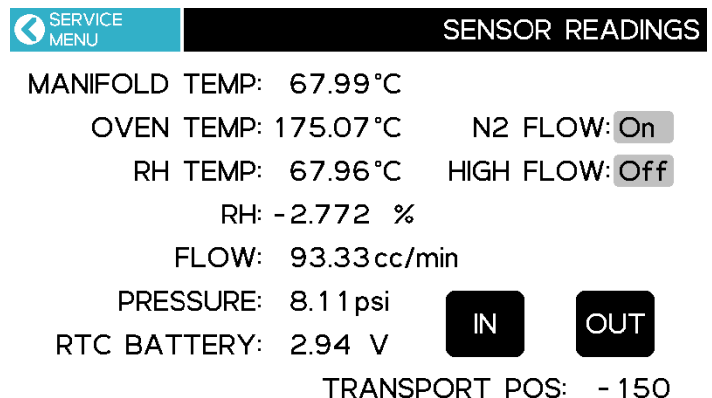

13.3. SERVICE → WEB SERVER

Use this menu to enable the Web Server option. When you purchase this feature, you will be given a key to enable the feature.

For more information regarding the special features available on your instrument, please call your technical sales representative or Customer Service.

WRITE KEY:

ENABLED: Yes

14. AUDIT LOG

The AUDIT LOG shows a history of instrument events. The following events are logged:

- Power on
- Calibrations
- Test Program Additions or Deletions
- Test Program Changes
- Test Result Deletions
- System Errors

MAIN MENU AUDIT LOG - 500 TOTAL

15. 03-Dec-2015 Test Program ...	
16. 03-Dec-2015 Power On	
17. 03-Dec-2015 Power On	
18. 03-Dec-2015 Configuration ...	VIEW
19. 03-Dec-2015 Power On	
20. 01-Jan-2015 Configuration C...	
21. 20-Nov-2015 Power On	

DELETE PRINT SELECT ALL

Some errors, such as memory errors, cannot be logged. Generally, hardware errors are immediately displayed on the top line of the screen in red, and the instrument halts, so access to the Audit Log may not be possible. There are a few hardware errors, such as RTC Battery Failure, that may be displayed in a message box on the Main Screen.

On 21 CFR, Part 11 compliant instruments, the Audit Log **[DELETE]** function is not available.

15. DETERMINE OPTIMUM TEST PARAMETERS

For best accuracy and speed, the sample should evolve between 200 µg and 5,000 µg of water during the test. Larger sample sizes do not significantly improve accuracy and extend the test time. Smaller quantities result in faster tests but may degrade accuracy depending on the properties of the sample.

The sample size can be entered in the test program's SAMPLE PROMPT field (See “9.2. TEST START OPTIONS” on page 28). This will prompt the user to load the vial with a specific amount of sample at the start of the test.

After determining the optimum test parameters, it is recommended to repeat the test to confirm the results.

For your particular application, contact Customer Service for assistance in developing specific parameters.

15.1. Starting With Karl Fischer Parameters

To match Karl Fischer (KF) analysis results, obtain the sample size and ‘sensitivity’ setting from the KF procedure. Use approximately 1.5 to 2 times as much sample in the Computrac® Vapor Pro® XL, and set the rate ending criteria to the ‘sensitivity’ value used in the KF equipment.

Example:

	Karl Fischer	Vapor Pro® XL
Sensitivity Setting	0.1 µg/sec	0.1 µg/sec
Sample Size	0.5 g	0.75 - 1 g

Start at the KF test temperature and adjust as needed.

15.2. Parameter Development From Scratch

Use the following calculation to estimate the minimum sample size for a sample expected to have 200 µg water.

$$\text{Minimum Sample Size (in grams)} = 0.02 / (\text{Expected Moisture in \%})$$

Example:

If Expected Moisture is 0.05%

Then Minimum Sample = $0.02 / 0.05 = 0.4$ grams

The following table gives general guidance for the selection of sample size for the expected moisture level. The sample vial also limits the maximum sample size. Do not fill the vial over a third full. This will typically be about five (5) grams for the sample vial used with the Vapor Pro® XL.

RECOMMENDED SAMPLE SIZE TABLE

Expected Moisture	Use
.001 - .035% / 10 - 350 ppm	1.5 - 2 gms
.035 - .075% / 350 - 750 ppm	1 - 1.5 gms
.075 - .150%	0.5 - 1 gm
.150 - .350%	0.2 - 0.5 gm
.350 - .750%	0.1 - 0.2 gm
.750 - 1.5%	0.05 - 0.1 gm

These are only guidelines. Experiment with your sample to refine the size estimates to achieve the desired speed and accuracy. When using a rate ending criterion, if the peak moisture rate is less than five times the rate threshold, the sample sizes should not vary more than about 10%. A larger variation of sample size leads to a larger variety of results.

Use the highest possible temperature without causing other 'undesirable' conditions (such as melting or excessive release of other volatiles). Lower temperatures result in longer test times and possibly low results.

In most cases, the sample must not melt. A melted sample may form an impermeable skin and trap moisture, producing an inaccurate result.

The following guidelines will help:

- If you have a reference method, set the test temperature to the same temperature as used in your reference method.
- If the melting temperature is known, set the temperature 10°C or 20°C lower.

For rate ending criteria, start with 0.3 µg/s for samples with 100µg moisture. 0.5 µg/s works well for larger sample moistures (500 to 10,000 µg). Adjust the rate ending criteria to target the desired test result value.

16. PERFORMING MOISTURE TESTS

Select the appropriate test program by selecting **[PROGRAMS]** from the Main Screen. If changing temperatures, wait for the temperature to stabilize, as indicated by the main screen's thermometer.

See “**9. TEST PROGRAMS**” on page 26 for creating and editing test programs.

Begin a test:

- Use a cool, clean empty sample vial with septum and cap.
- Wait for system status to read “READY” on the Main Screen.
- For ppm and % result output: Tare the empty vial on balance.
- If unable to tare the empty vial before testing, the vial weight can be entered through the TEST RESULTS screen after testing (See “**10. TEST RESULTS**” on page 37). This scenario occurs with prepackaged samples.
- Fill the sample vial:
- To prevent needle damage and manifold contamination, do not fill the vial more than one-third the volume.
- Press **[TEST]** and follow the on-screen instructions to perform the test.
- When prompted, weigh the loaded sample vial and enter the weight.
- Install a clean septum into a dry cap, so the shiny side (the Teflon® liner) faces into the sample vial, and then screw on the cap. (The other silicone side of the septum must face out of the vial or results will be affected). Septa are typically suitable for multiple tests. For liquid samples, wipe the septa clean before reuse.
- When prompted, insert the sample vial and close the vial ramp cover to begin the test. For Autosampler loading, see Sec on 18.9.
- An audible ‘beep’ sounds when the instrument completes the test.

NOTE: The accessory balance, P/N Y990-0082 (115V) or Y990-0083 (230V), communicates directly with the Vapor Pro® XL, eliminating possible transcription errors when entering the sample weight.

17. WEB SERVER

An optional Web Server can be purchased for the Vapor Pro® XL, which allows the instrument to be accessed from your local area network (LAN) or intranet by a Windows® PC with Internet Explorer® (IE) version 6 or higher, or Edge browser.

The Web Server provides these functions:

- View the instrument LCD screen.
- View and print or save a combined system calibration and temperature calibration report.
- Save (download) instrument Test Programs to a local PC, or transfer (upload) them from a PC to the instrument(s).
- View and save Test Results and graph data as spreadsheet compatible comma-separated values (.csv) formatted files.
- View the Audit Log.

Before accessing the instrument with a browser, the Ethernet settings must be configured (see “**12.3. SETUP → ETHERNET SETUP**” on page 48). Then, type the instrument’s IP address into the address bar (for example, 192.168.2.251). The IP address is configured (if using Manual mode) or assigned by the DHCP server (if using Automatic mode).

Note: For best results, do not attempt to access the same Vapor Pro® XL with multiple browsers or multiple PCs simultaneously.

For more information regarding the Web Server option, please contact your technical sales representative or Customer Service.

17.1. CALIBRATION REPORT

The calibration report is viewed by selecting CALIBRATION REPORT in the left bar. This report combines the system calibration and temperature calibration reports. The report can be downloaded to the PC as an HTML file.

BROOKFIELD AMETEK VAPOR PRO XL PREFERRED CUSTOMER SN: 42000033

CALIBRATION REPORT

LCD VIEW
TEST PROGRAMS
TEST RESULTS
AUDIT LOG

VAPOR PRO XL CALIBRATION REPORT

COMPANY NAME: PREFERRED CUSTOMER
INSTRUMENT #: 42000033
FACTORY CAL DUE: 13-Feb-2019

SYSTEM CALIBRATION

SYSTEM CALIBRATION: 12-Nov-2018
CAL AMOUNT: 1000µg
CF: 1.020

SYSTEM VERIFICATION:

LINEAR CALIBRATION: 09-Feb-2018
LINEAR TABLE:

0.0	0.734
2.0	0.734
10.0	0.815
30.0	0.844
100.0	1.000

LINEAR VERIFICATION: 09-Feb-2018

STANDARD	MEASURED	RESULT
100µg	98.5µg	Pass
500µg	504.9µg	Pass
1000µg	1032.0µg	Pass
3000µg	2973.0µg	Pass
10000µg	9675.2µg	Pass

RH SENSOR CONSTANTS:
VA: 0.8560V
VB: 3.0620V

FLOW SENSOR CONSTANTS:
LAST CALIBRATION: 18-May-2018
FLOW CF: 1.104
FLOW @: 725mmHg
FLOW @: 24°C

TEMPERATURE CALIBRATION

LAST CALIBRATION: 07-Feb-2018
LAST VERIFICATION: 07-Feb-2018

CAL MODULE #: 1420511
CAL PROBE #: 1020647
MODULE CAL DATE: 14-Nov-2017

CALIBRATION RESULTS:

RAW TEMP	OFFSET
50.03°C	-0.06°C
99.70°C	-0.94°C

Print / Save

Copyright 2018 AMETEK Brookfield

17.2. LCD VIEW

Selecting LCD VIEW in the left bar allows remote monitoring of the instrument.

The screenshot displays the LCD VIEW interface of the Brookfield VAPOR PRO XL instrument. The browser address bar shows the URL 10.100.5.76. The interface includes a navigation menu on the left with options: CALIBRATION REPORT, LCD VIEW (selected), TEST PROGRAMS, TEST RESULTS, and AUDIT LOG. The main display area shows the date 19-Dec-2018 and time 15:03:39. The primary measurement is 0.0357 % H₂O, equivalent to 266.7 µg. A temperature gauge on the right indicates a temperature of 180. The test status is 'READY TO TEST' with a checkmark icon. Below this, there are four buttons: MENU, PROGRAM, TEST (highlighted in red), and GRAPH. The footer of the interface contains the text 'Copyright 2018 AMETEK Brookfield'.

BROOKFIELD AMETEK VAPOR PRO XL PREFERRED CUSTOMER SN: 42000033

CALIBRATION REPORT
LCD VIEW
TEST PROGRAMS
TEST RESULTS
AUDIT LOG

19-Dec-2018 15:03:39

180

0.0357 % H₂O
(266.7 µg)

TIME: 6:58
TESTED: ABS M30-CYCOLAC MG94
NEXT TEST: ABS M30-CYCOLAC MG94 180

READY TO TEST

MENU | PROGRAM | **TEST** | GRAPH

Copyright 2018 AMETEK Brookfield

17.3. TEST PROGRAMS

Test Programs are viewed by selecting TEST PROGRAMS in the left bar. Test Programs can be downloaded from the instrument to the PC or uploaded to the instrument from the PC. Thus, Test Programs can be retrieved from one Vapor Pro® XL and saved to another.

Ideally, set up one Vapor Pro® XL with the desired Test Programs, transfer the Test Programs to the PC, and then transfer the Test Programs from the PC to other Vapor Pro® XL instruments. Test Programs are saved in a comma-separated values (.csv) format on the PC and can be read by Microsoft Excel®. Editing the Test Programs in Excel® is not recommended.

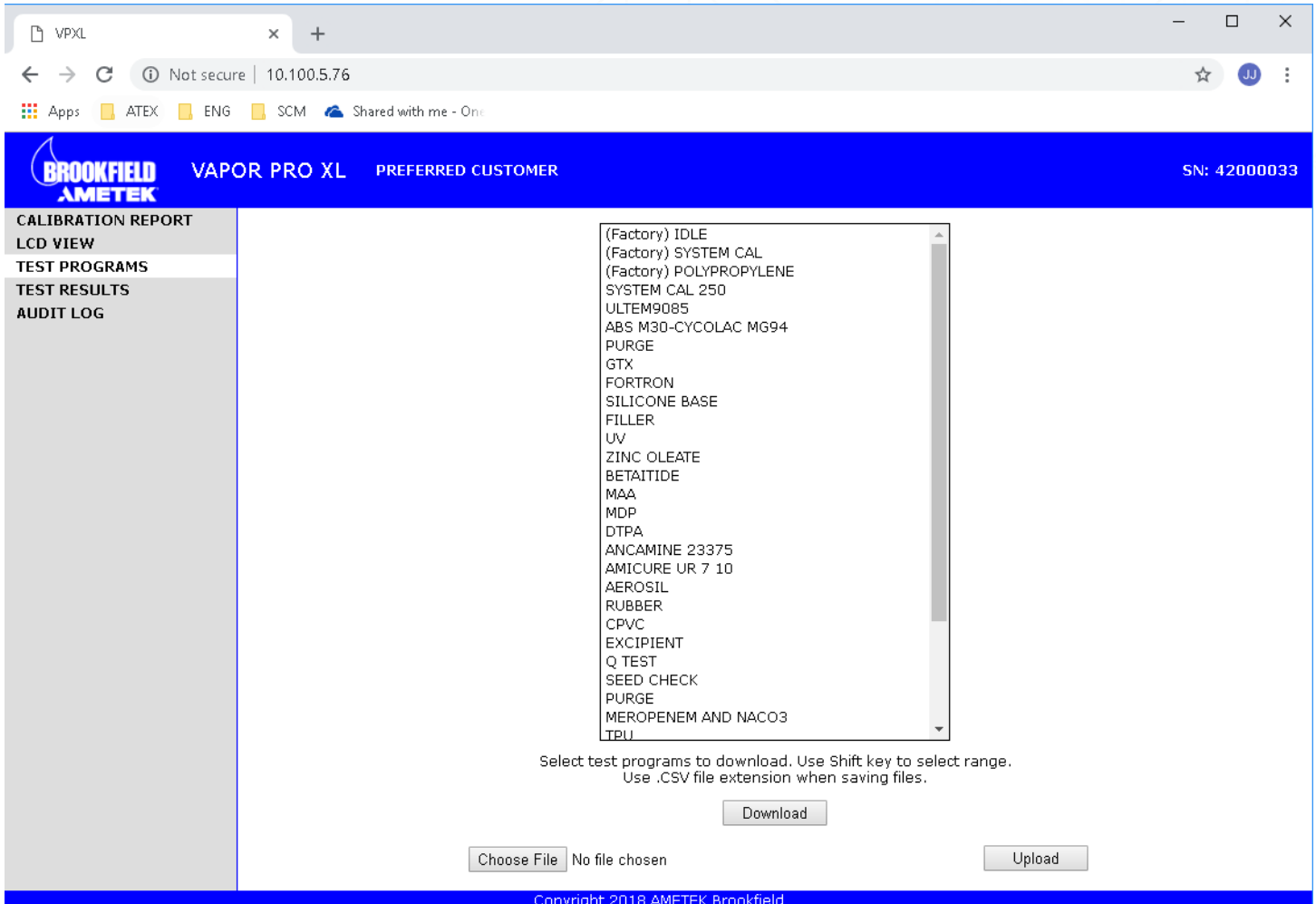

The screenshot shows a web browser window with the URL 10.100.5.76. The page header includes the Brookfield AMETEK logo, the text "VAPOR PRO XL PREFERRED CUSTOMER", and the serial number "SN: 42000033". The left sidebar contains a menu with the following items: CALIBRATION REPORT, LCD VIEW, TEST PROGRAMS (highlighted), TEST RESULTS, and AUDIT LOG. The main content area displays a scrollable list of test programs:

- (Factory) IDLE
- (Factory) SYSTEM CAL
- (Factory) POLYPROPYLENE
- SYSTEM CAL 250
- ULTEM9085
- ABS M30-CYCOLAC MG94
- PURGE
- GTX
- FORTRON
- SILICONE BASE
- FILLER
- UV
- ZINC OLEATE
- BETAITIDE
- MAA
- MDP
- DTPA
- ANCAMINE 23375
- AMICURE UR 7 10
- AEROSIL
- RUBBER
- CPVC
- EXCIPIENT
- Q TEST
- SEED CHECK
- PURGE
- MEROPENEM AND NACO3
- TBU

Below the list, there is a "Download" button and an "Upload" button. A "Choose File" button is also present, with the text "No file chosen" next to it. A note below the list reads: "Select test programs to download. Use Shift key to select range. Use .CSV file extension when saving files."

Copyright 2018 AMETEK Brookfield

17.4. TEST RESULTS

Test Results can be viewed by selecting TEST RESULTS in the left bar. Test Results cannot be modified or deleted through the Web Server; data can only be deleted at the instrument.

Test Results are saved in a comma-separated values (.csv) format, which can be read by Microsoft Excel®. The “Report Items to Print” (See “12.2.2. SETUP → REPORT SETUP → REPORT ITEMS TO PRINT” on page 47) controls which items are included in the report.

Graph data contains only the data points used by the instrument to generate the graph, not the actual visual graph. This is the best format to choose when making pivot tables in Excel® or using other specialized data analysis or visualization software.

The screenshot shows a web browser window displaying the Brookfield AMETEK VAPOR PRO XL interface. The browser address bar shows "10.100.5.76". The interface has a blue header with the Brookfield AMETEK logo, "VAPOR PRO XL", "PREFERRED CUSTOMER", and "SN: 42000033". On the left, a navigation menu includes "CALIBRATION REPORT", "LCD VIEW", "TEST PROGRAMS", "TEST RESULTS" (which is selected), and "AUDIT LOG". The main content area displays a table of test results:

ABS M30-CYCOLAC MG94	19-Dec-2018	0.0357
ABS M30-CYCOLAC MG94	19-Dec-2018	0.0342
ABS M30-CYCOLAC MG94	19-Dec-2018	0.0293
ABS M30-CYCOLAC MG94	19-Dec-2018	0.0338
SYSTEM CAL	19-Dec-2018	1033.9
ULTEM9085	18-Dec-2018	0.0282
ULTEM9085	18-Dec-2018	0.0250
ULTEM9085	18-Dec-2018	0.0191
ULTEM9085	18-Dec-2018	0.0147
SYSTEM CAL	18-Dec-2018	1025.5
SYSTEM CAL	18-Dec-2018	1019.5
SYSTEM CAL	18-Dec-2018	1022.0
EXCIPIENT	17-Dec-2018	0.8373
EXCIPIENT	17-Dec-2018	1.5264
EXCIPIENT	17-Dec-2018	1.2364
EXCIPIENT	17-Dec-2018	1.2028
EXCIPIENT	17-Dec-2018	1.1843
EXCIPIENT	17-Dec-2018	1.1850
SYSTEM CAL	17-Dec-2018	994.0
SYSTEM CAL	17-Dec-2018	994.8
SYSTEM CAL	17-Dec-2018	1008.4
SYSTEM CAL	17-Dec-2018	996.6

Below the table, there is a note: "Select test results to download. Use Shift key to select range. Use CSV file extension when saving files." Three buttons are provided: "Download Tests", "Download Test & Graph Data", and "Download Graph Data". The footer of the interface reads "Copyright 2018 AMETEK Brookfield".

17.5. AUDIT LOG

The Audit Log is viewed by selecting AUDIT LOG in the left bar. The log can be downloaded to the PC as an HTML file. See “14. AUDIT LOG” on page 53 for more details on the Audit Log.

VPXL

Not secure | 10.100.5.76

Apps ATEX ENG SCM Shared with me - On

BROOKFIELD AMETEK VAPOR PRO XL PREFERRED CUSTOMER SN: 42000033

CALIBRATION REPORT
LCD VIEW
TEST PROGRAMS
TEST RESULTS
AUDIT LOG

VAPOR PRO XL AUDIT LOG

19-Dec-2018 14:58:32	Configuration Changed
19-Dec-2018 13:50:12	Test Program Changed-ABS M30-CYCOLAC MG94
19-Dec-2018 13:10:24	Test Program Changed-ABS M30-CYCOLAC MG94
19-Dec-2018 13:10:05	Test Program Changed-ABS M30-CYCOLAC MG94
19-Dec-2018 12:46:45	Test Program Changed-ABS M30-CYCOLAC MG94
19-Dec-2018 11:17:37	Test Program Changed-ABS M30-CYCOLAC MG94
19-Dec-2018 11:16:17	Test Program Changed-Program X
19-Dec-2018 11:15:56	Test Program Added-Program X
18-Dec-2018 12:31:44	Test Program Changed-ULTEM9085
18-Dec-2018 08:53:33	Test Program Changed-PURGE
17-Dec-2018 15:08:34	Test Program Changed-EXCIPIENT
17-Dec-2018 14:45:50	Test Program Changed-EXCIPIENT
17-Dec-2018 13:02:08	Test Program Changed-EXCIPIENT
17-Dec-2018 12:23:54	Test Program Changed-EXCIPIENT
17-Dec-2018 12:19:39	Test Program Changed-EXCIPIENT
17-Dec-2018 11:42:20	Test Program Changed-EXCIPIENT
17-Dec-2018 11:11:08	Test Program Changed-EXCIPIENT
17-Dec-2018 11:01:54	Test Program Changed-EXCIPIENT
13-Dec-2018 13:07:26	Configuration Changed
13-Dec-2018 13:06:19	Configuration Changed
13-Dec-2018 12:26:26	Test Program Changed-ULTEM
13-Dec-2018 10:45:00	Test Program Changed-ULTEM
10-Dec-2018 09:20:38	Test Program Changed-SYSTEM CAL 250
10-Dec-2018 09:20:20	Test Program Changed-Program X
10-Dec-2018 09:19:50	Test Program Added-Program X

Print / Save

Copyright 2018 AMETEK Brookfield

18. REPAIR, MAINTENANCE, AND OPTIONAL ACCESSORIES

Routine maintenance consists of checking the flow, checking the optional Hydrophobic Filter (see “18.5. Filter Inspection, Replacement & flow path cleaning” on page 67) for clogging or contamination, checking the needles for clogs, and cleaning the flow path between the needle and the filter. Ensure the instrument is cool.

18.1. LCD and Instrument Cleaning

- The outer housing of the instrument should be cleaned with a mild household detergent such as Formula 409^a and a soft, lint-free cloth. Paper towels should never be used, as they will scratch the instrument’s finish.
- Clean the touchscreen LCD, only with a lens or eyeglass cleaner and a lens towel or Kimwipe. Paper towels should never be used, as they will scratch the LCD.
- If more aggressive cleaning is required, call Customer Service for recommendations.

18.2. Inserts for Crimp Top Sample Vials (not for VPXL Autosampler)

If your samples use crimp-top vials, insert kits are available so the Vapor Pro[®] XL can accommodate them.

The two kits and their compatible vials sizes are:

- Y990-0271 Kit, Small Crimp Vials fits: 13mm cap size (2R and 4R vials)
- Y990-0272 Kit, Large Crimp Vials fits: 20mm cap size (6R through 30R vials)

Make sure the oven is cold before proceeding.

Place the insert into the standard vial holder, as shown in the image. When properly installed, the setscrew in the insert will fit into the matching indentation in the standard vial holder, preventing rotation of the insert. Replace the insert to switch to a vial with a different sized cap. If needed, a small hole to the right of the setscrew is used to remove the insert with a small pointed object, such as a pen tip. Testing makes the transport and insert hot, so wait for cool down. Protect your hands from heat, or use a tool to replace the insert.

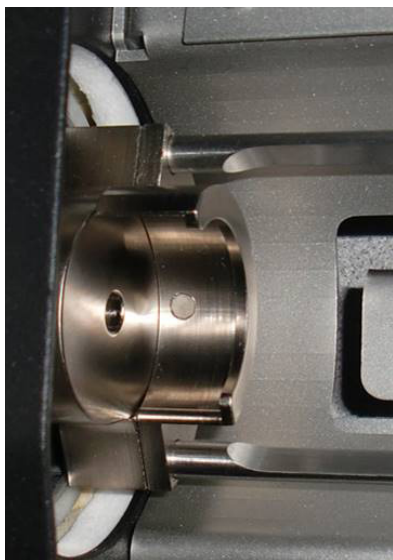

Standard/No Insert

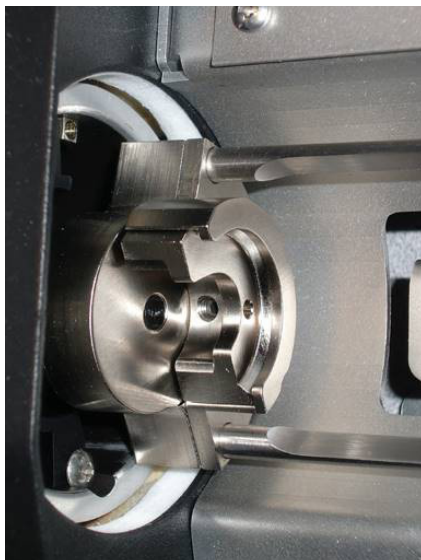

Small Vial Insert Installed



Large Vial Insert Installed

If using vials with an outer diameter of 28mm or more, it is necessary to remove the oven insert. Follow these steps to remove the oven insert:

- If the oven is hot, select the “(Factory) IDLE” test program for rapid cool down.
- Turn the instrument off.
- Unscrew and remove the indicated screw, then use tweezers to grab and pull the insert out of the oven.

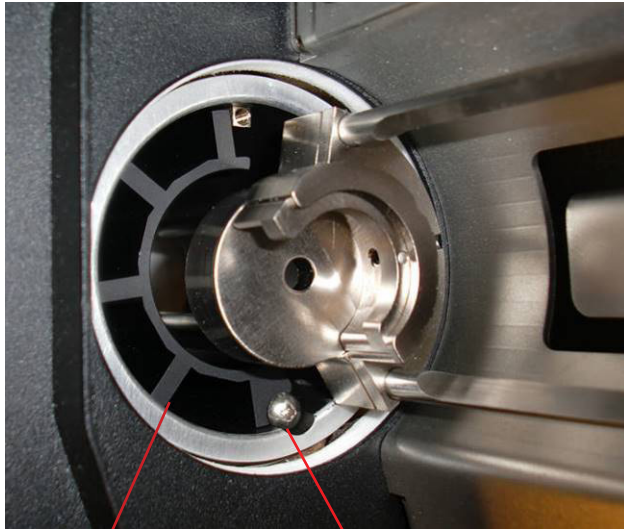

Oven Insert

Remove Screw



Save the oven insert and screw for reinstallation if needed for other size vials. For reference, the oven insert is P/N 300-0962, and the screw is P/N 850-0259.

18.3. Cover Access

- Refer to this procedure to gain access to the internal parts as directed in other sections of this manual.
- If the instrument oven is hot, switch to the “(Factory) IDLE” test program to quickly cool the oven. Wait for the oven to cool down to prevent burns.
- Turn the power off and remove the power cord to prevent electrical shocks.
- Loosen (but do not remove) the Phillips®-head screw on the front of the case, and lift the cover.
- Leave the power cord disconnected while the case is open unless otherwise directed.
- The manifold is heated to 68°C during operation. So, avoid contact when working inside the instrument or wait for the manifold to cool down.
- Perform the desired maintenance.
- After maintenance, close and secure the top cover by pushing the case screw in, closing the top cover, and tightening the screw.
- Reconnect the power cord and turn on.



CAUTION

Line voltage and a heated oven are present under the instrument's cover.
Turn off the power and remove the power cord to prevent electrical shock. Wait for
the oven to cool down to prevent burns.

Secure the cover in place before reconnecting the power cord.



18.4. Hydrophobic Filter and Tubing Installation

For applications such as nylon or other materials with unreacted or unpolymerized components (such as caprolactam), a hydrophobic particulate filter is recommended to minimize potential contamination of the RH sensor manifold with condensed material. The complete filter kit, including the required fittings, is available as P/N: Y990-0266. Once the filter kit is installed, only the filter and tubing require regular maintenance, as described in the next section.



Filter Kit with Fittings (P/N: Y990-0266)

To install the Filter Kit (P/N: Y990-0266):

- Follow the instructions in §18.3 Cover Access to gain access to the instrument.
- Use a slotted screwdriver to remove the indicated right fitting and the short piece of tubing attached to it.
- Use a slotted screwdriver to loosen, but do not remove, the indicated left fitting.
- Use a slotted screwdriver to install and secure the Filter Kit in the open hole.
- Rotate the left fitting to point away from you as shown in the image, then tighten it in place.
- Install the tubing between the barbed fitting (on the left) and filter.
- Ensure that all fittings (including the Luer lock on the filter) are secure.

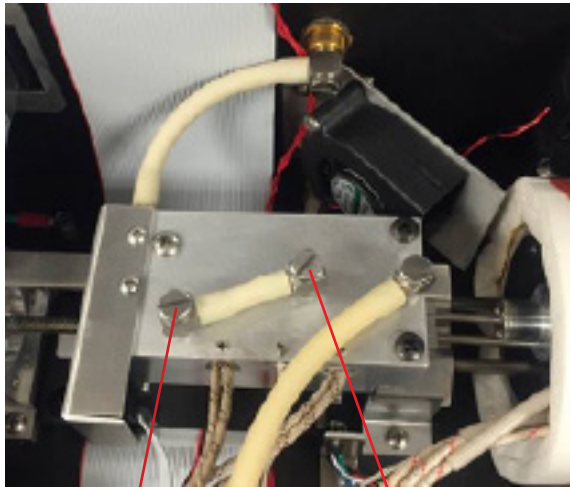

Loosen & Rotate

Loosen & Remove

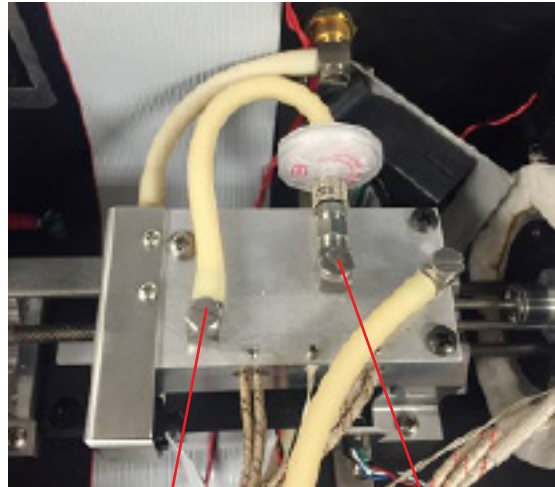

Connect Filter Kit

Install Filter Kit

18.5. Filter Inspection, Replacement & Flow Path Cleaning

If the Hydrophobic Filter Kit is installed, refer to this section for inspection, replacement, and flow path cleaning instructions. For cleaner samples, such as most plastic resin pellets, this is seldom necessary. For very dusty, high moisture or high volatile content samples, this may be necessary more often. The Kit with just the filter and tubing is P/N: Y990-0267.

- Follow the instructions in §18.3 Cover Access to gain access to the instrument.
- Examine the filter for any visible deposits or discoloration indicative of contamination.
- The tubing is opaque, so tubing contamination is not obvious. If contamination is suspected, replace the tubing. Tubing cannot be reused once removed. Slice open the old tubing to determine if the system is contaminated.
- If a deposit or discoloration is observed in the filter or tubing, they should be replaced, and the entire sample flow path cleaned with isopropyl alcohol (IPA), as described below.

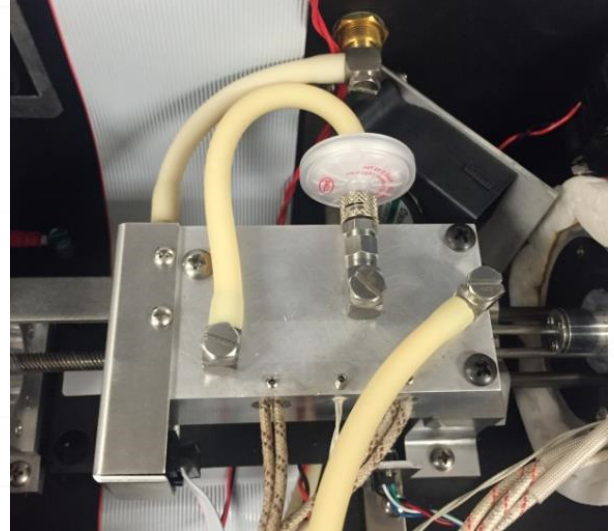

IMPORTANT

Never use methanol to clean any part of the instrument. Methanol interferes with the calibration of the RH sensor, and is very difficult to remove from the flow system.



To replace the filter and tubing and purge the flow path:

- Obtain a new Hydrophobic Filter Kit from AMETEK Brookfield (P/N Y990-0267).
- Rotate the Luer locking ring to unlock the filter, and remove it.
- Detach the tubing from the barbed fitting (on the left).
- Discard the old filter and tubing.
- Install the new filter onto the Luer fitting and rotate the locking ring to secure it.
- Install the tubing between the barbed fitting (on the left) and filter, as shown in the image above.
- Refer to §18.3 Cover Access to close the instrument, restore power, and turn it on.
- If contamination was seen or is suspected, purge the sample flow path with isopropyl alcohol (IPA) by following these steps:
 - If not already done, remove the plug from the instrument's exhaust port (above the N2 input) and install the included Hose Barb (P/N: 345-0113).



Filter Kit (P/N: Y990-0267)

- Attach a short tube to the exhaust port and route the other tube end to a waste jar or beaker to catch the IPA expelled from the flow system.
- Reconnect the power cord and turn on.
- Select the Factory (IDLE) Test Program to keep the oven from heating.
- Fill a sample vial with IPA, place it in the transport, and close the vial ramp cover.
- Navigate to MAIN MENU → SERVICE MENU → SENSOR READINGS.
- Press **IN** to move the transport and vial into the instrument and start the cleaning.
- When the IPA has stopped sputtering out of the output port, press **OUT** to move the transport and vial out. Repeat if necessary.
- When done flushing, remove the exhaust port tube and waste jar.

Note: Factory replacement of the Hydrophobic Filter is available and recommended.

18.6. Flow Check and Adjustment

The instrument has a normal flow for idle and testing, and a higher flow for vial purge at the test start. The normal flow should be checked upon installation of the instrument and adjusted if needed. Weekly checks after installation are recommended.

Flow Check procedure:

- Verify that the pressure of the carrier-gas supplied to the instrument is between 17-22 psi, and the instrument has been powered on for 20 minutes with the gas connected.
- Begin at the Main Screen.
- Navigate [**MENU**] → SERVICE MENU → SENSOR READINGS.
- Ensure that N2 FLOW is On and HIGH FLOW is Off. Touch to toggle if needed.
- Verify that the FLOW displayed is within 95.0 ± 5.0 mL/min. If so, no adjustment is needed. If not, continue to adjust the flow.

SERVICE MENU	SENSOR READINGS	
MANIFOLD TEMP:	68.00 °C	
OVEN TEMP:	26.50 °C	N2 FLOW: On
RH TEMP:	68.06 °C	HIGH FLOW: Off
	RH: - 1.230 %	
	FLOW: 98.39 mL/min	
PRESSURE:	8.87 psi	IN OUT
RTC BATTERY:	2.92 V	
	TRANSPORT POS:	-200

CAUTION

Line voltage and a heated oven are present inside the instrument.
Only technicians or users comfortable with this process should adjust the flow, as it is adjusted with the instrument powered ON.

Line voltage runs to circuits and components along the left side of the instrument. Avoid touching any circuits on the left side of the instrument. The flow adjustment is performed in the front right corner, which is away from the hazardous voltages.



Flow Adjustment procedure:

- Open Access Cover per §18.3 Cover Access on page 67.
- Reconnect the power cord and turn the instrument back on.
- Navigate [MENU] → SERVICE MENU → SENSOR READINGS.
- Wait a minute and make sure that the flow is stable.
- Ensure that the vial transport is out. If it is not, press OUT on the instrument.
- Inside the instrument, loosen the indicated silver locking ring on the black adjustable pressure regulator by hand.
- Slowly adjust the regulator by turning a regular screwdriver in the slot on top of the regulator until the instrument displays FLOW of 95.0 ± 1.0 mL/min.
- Tighten the silver locking ring.
Note: when the locking ring is tightened, the flow will decrease slightly.
- Repeat this process until the displayed FLOW after tightening the locking ring still meets the 95.0 ± 1.0 mL/min requirement.
- Refer to §18.3 Cover Access on page 67 to reclose the instrument access cover.

Note: The high flow is not adjustable by the user.

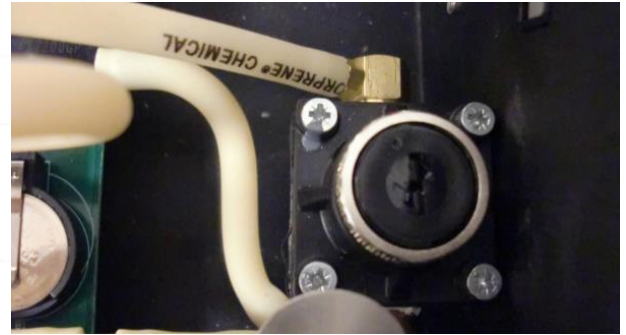

18.7. Needle Replacement

A Needle Replacement Kit is available from AMETEK Brookfield as P/N: Y990-0270. For most applications, needle replacement is not necessary. However, some powdery samples may clog the needle over time, requiring needle replacement sooner than the instrument is due for factory calibration.

Follow the instructions below to replace the needle:

- If the Vial Transport is not already out, from the Main Screen, navigate [MENU] → SERVICE MENU → SENSOR READINGS and press OUT.
- Follow the steps in §18.3 Cover Access to open the instrument access cover.
- Use a slotted screwdriver to unscrew the stainless steel fitting from the bronze bulkhead fitting.

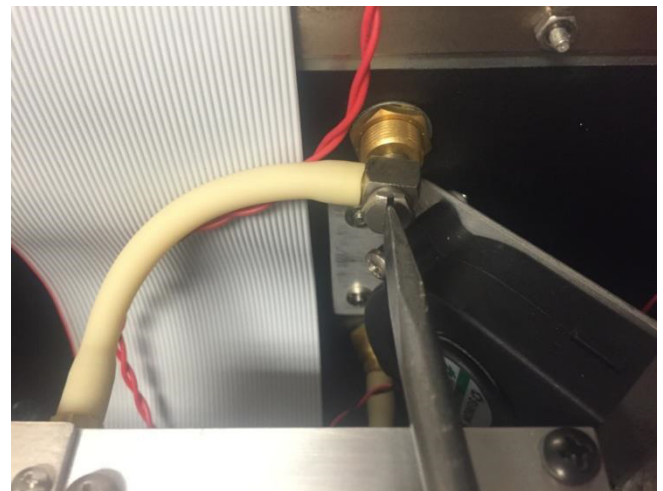

- Use a Phillips® screwdriver to unscrew the three (3) screws securing the Manifold (the silver screw on the left and the two black screws on the right).

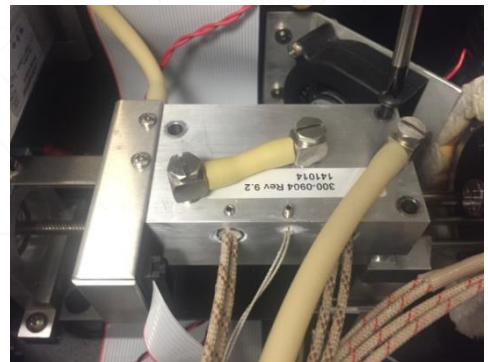

- Carefully rotate the Manifold/Needle/Floating Chamber assembly towards you.

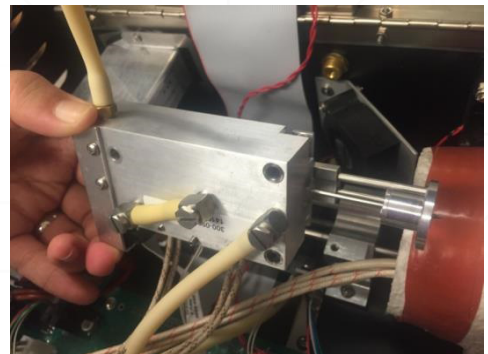

- Carefully remove the Floating Chamber from the Manifold and the Needle.

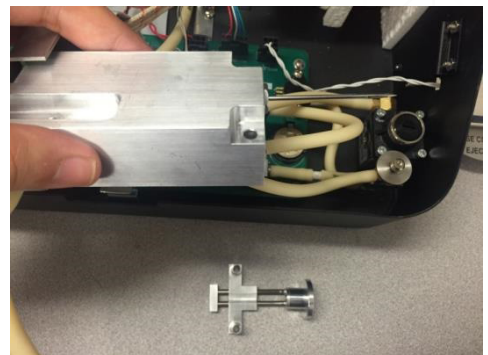

- Use a 3/8" open-end wrench to unscrew the Needle from the Manifold.

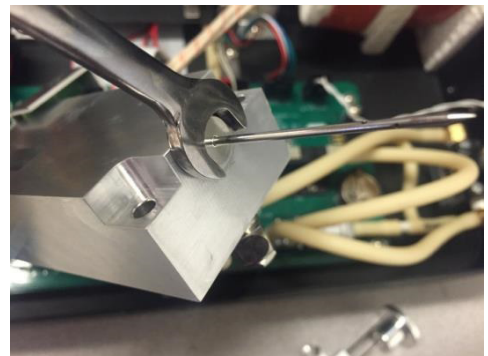

- Locate the used thin black Needle Seal and the brown Needle O-ring and discard them. They may be on the needle or in the needle mount hole in the manifold.

Installation is the reverse of removal, as detailed below:

Install the new Needle Seal [P/N: 350-0109] at the manifold's end, ensuring it lays flat.

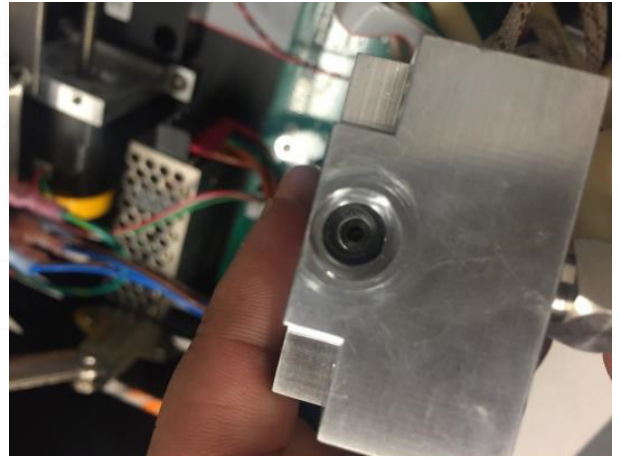

- Remove the Needle [P/N: 990-0242] from the protective tube. The Needle is fragile when not protected by the Manifold and Floating Chamber. Do not apply any bending force to the needle. The welds at the Needle base can break and leak if bent.
- Install the Needle O-ring [P/N: 2500 1005] on the base of the Needle.
- Install the Needle with O-ring into the Manifold using the 3/8" open-end wrench.
- Carefully reinstall the Floating Chamber back on the Manifold and Needle.
- Carefully reinstall the Manifold/Needle/Floating Chamber assembly and secure with the three (3) screws removed from above.
- Reconnect the steel fitting to the bronze bulkhead fitting.
- Refer to §18.3 Cover Access to reclose the instrument access cover.



After needle replacement, check for a flow leak:

- If not already done, remove the plug from the instrument's exhaust port (above the N2 input) and install the included Hose Barb (P/N: 345-0113).
- Power on the instrument
- Navigate [MENU] → SERVICE MENU → SENSOR READINGS.
- Firmly press on the exhaust port with a finger to stop the airflow.
- Ensure that the flow drops to 2.00 mL/min or less.

After needle replacement, wait for instrument warmup and refer to §11.3 CALIBRATION[®] SYSTEM CALIBRATION to perform System Calibration before proceeding.

18.8. Autosampler Unpacking and Quick Start Guide



Figure 1



Figure 2

Unpacking and Assembly

- Remove both the Vapor Pro XL (fig. 1) and Autosampler (fig. 2) and accessories from their respective packaging.
- Place the Vapor Pro XL onto the Autosampler by aligning the two pins on the Autosampler with the two holes on the flange at the rear of the Vapor Pro XL (fig. 3).
Note: The Autosampler should never be moved or transported with the Vapor Pro XL installed. If the VPXL needs to be removed, the sample drawer must be retracted first using the “Transport IN” button. (MAIN SCREEN - MENU - SERVICE MENU - SENSOR READINGS - IN button)
- Connect power adapters to both the rear of the Vapor Pro XL and Autosampler, and connect the supplied USB cable between the two at the rear of the units (the type A connector to the Vapor Pro XL, the type B to the Autosampler). Also, connect the input air connection to the Vapor Pro XL (fig. 3).
- Place the carousel on the Autosampler, ensuring that the dots on the carousel and spindle are aligned and the pin in the spindle is lined up with the alignment hole under the carousel (fig. 4).

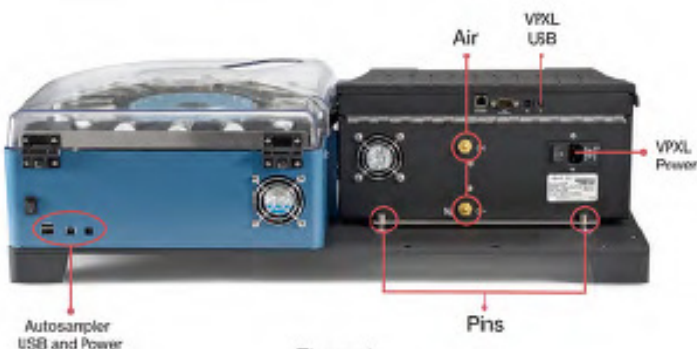

Figure 3

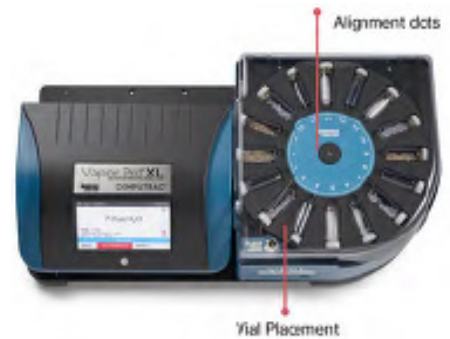

Figure 4

Getting Started

How to load sample vials (sample vials, caps, and septa – AMETEK Brookfield part numbers 990-0229, 990-0206, and 990-0207) and run tests with the Vapor Pro XL w/Autosampler:

- Tare vial and add/weigh sample as done for manual VPXL operation. See section 9 – TEST PROGRAMS in the operator’s manual for more information on this process.
- Select the Autosampler button from the VPXL main menu (fig. 5).
- The Autosampler test menu will appear and display 16 vial locations that correspond to vial positions on the carousel. Use the touch screen to select the vial position to be loaded (fig. 6).
- After pressing EDIT the carousel will rotate and stop when the selected vial location is in the vial loading position.
- Load vial into position with the cap facing the outer diameter of the carousel.
- Verify that the VPXL recognizes that a vial is loaded into the selected position and the position is active. Then select a test program and enter the sample weight (fig. 7).
- Repeat process until all samples to be tested are loaded into the Autosampler (up to 16).
- Once samples are loaded, initiate test by pressing the TEST button on the Autosampler test screen (fig. 8).

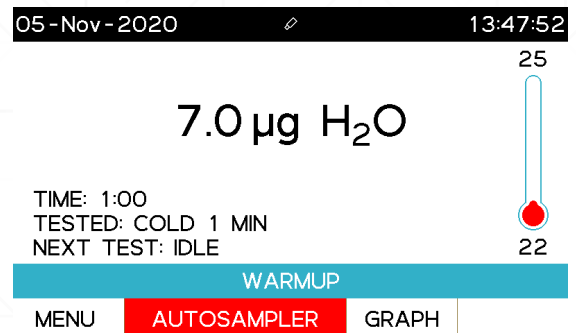

Figure 5

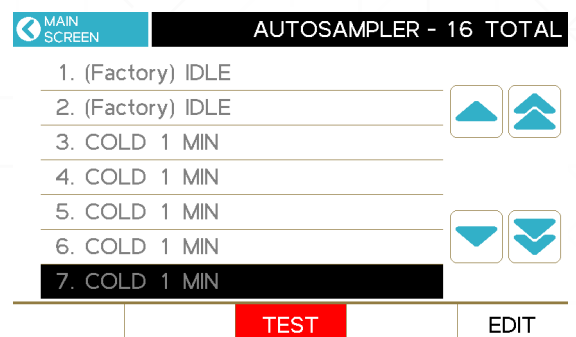

Figure 6

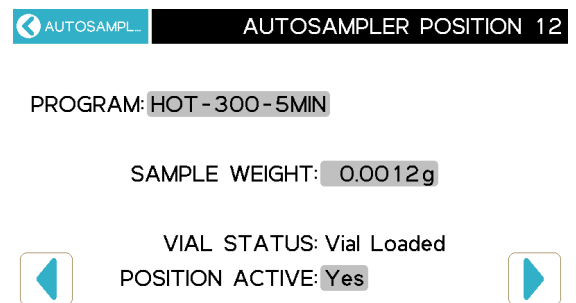

Figure 7

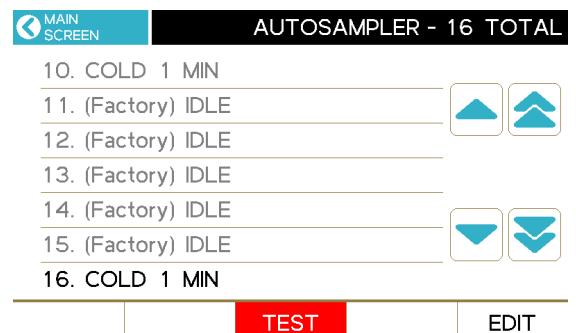

Figure 8

18.9 Autosampler Operations

The VPXL can be ordered with an Autosampler (AMETEK Brookfield part numbers XVP0A000000U00, XVP0A000000J00, or XVP0A000000E00), which allows for the automated testing of up to 16 different samples. Below are instructions specific to the operation of the optional Autosampler.



Loading sample vials (sample vials, caps, and septa – AMETEK Brookfield part numbers 990-0229, 990-0206, and 990-0207) and running tests:

- Tare vial and add/weigh sample as done for manual VPXL operation (see section 9 – TEST PROGRAMS for more information on this process).
- Select the Autosampler button from the VPXL Main Menu.
- The Autosampler test menu will appear and display 16 vial locations corresponding to vial positions on the carousel. Use the touch screen to select the vial position to be loaded

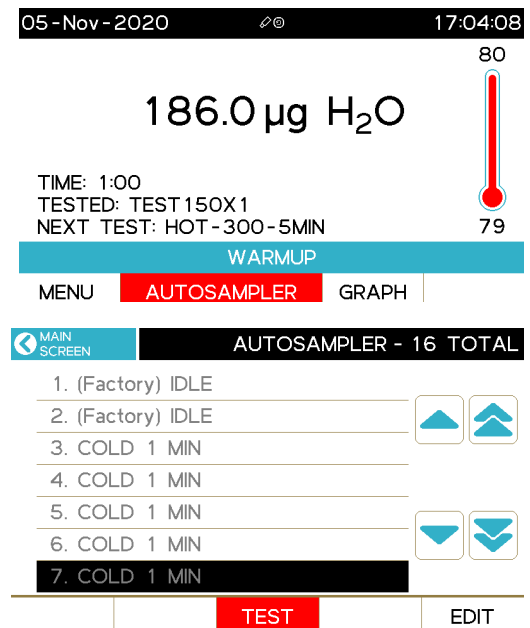

- The carousel will rotate and stop when the selected vial location is in the vial loading position.

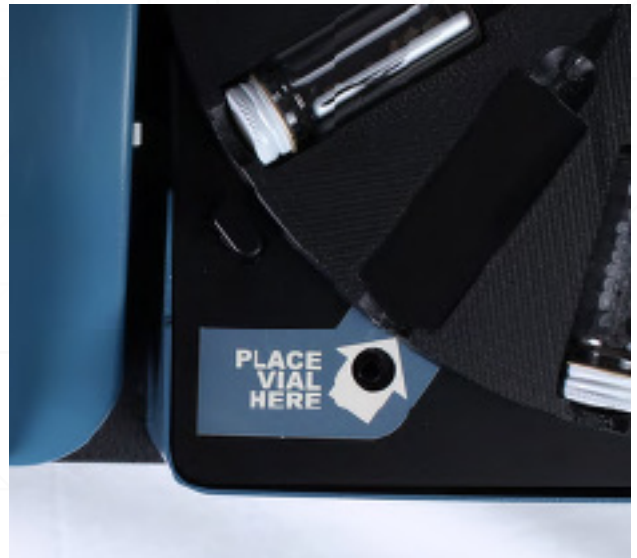

- Load the vial into position, with the cap facing the outer diameter of the carousel.



- Verify that the VPXL recognizes that a vial is loaded into the selected position, and the position is active. Then, select a test program and enter the sample weight.

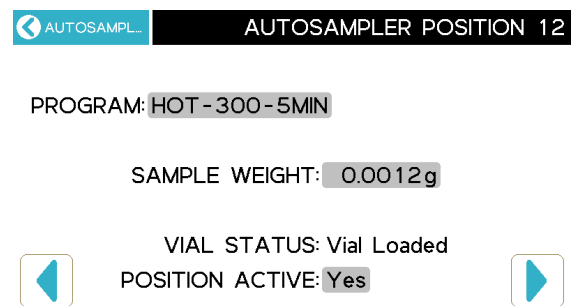

- Repeat the process until all samples are loaded into the Autosampler (up to 16).

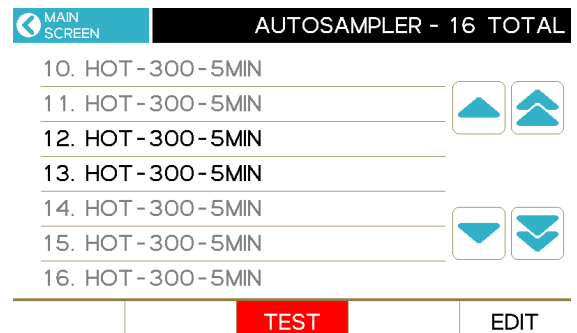

- Once samples are loaded, initiate the test by pressing the TEST button on the Autosampler test screen

The test will run automatically until all samples have been tested. Please note that there may be a short cool down between individual tests to ensure the vials are at a lower temperature before being placed back in the carousel.

- Tests using the VPXL Autosampler can also be conducted with 8R crimp top vials using an optional kit (part number Y990-0280 from AMETEK Brookfield). This kit includes a carousel and insert for the vial holder and **MUST** be used when testing with 8R vials (attachment of the vial holder can be found in section 18.2 - INSERTS FOR CRIMP TOP SAMPLE VIALS). All other testing procedures remain the same.



Status bar indicator lights:

Light	Function
Green	Idle
Blue	Busy (testing/moving)
Red	Fault, see VPXL for error message



Load position indicator lights

Light	Function
Off	No action
Green	Carousel slot loading mode

- Information on how to obtain results and test data can be found in section 10 – TEST RESULTS.



19. SPECIFICATIONS AND RATINGS

These specifications are intended as a guide to the proper use of the Vapor Pro® XL. AMETEK Brookfield product specifications are verified, validated, and compliant with ISO-9001. They are not to be construed as test criteria for every application and may vary accordingly. All specifications and features are subject to change without notice. Refer to the latest version of this manual for the current specifications for the Vapor Pro® XL. Contact Customer Service to see if any upgrades are available for the Vapor Pro® XL at brookfieldengineering.com or send an e-mail to customerservice.computrac@ametek.com.

FEATURE	VPXL SPECIFICATION	VPXL w/Autosampler SPECIFICATION
Size	6.8 in. height x 18.5 in. width (including vial ramp) x 11.0 in. depth 172 mm height x 470 mm width x 279 mm depth	8.2 in. height x 29.0 in. width x 15.5 in. depth 208 mm height x 737 mm width x 394 mm depth
Weight:	Approximately 8.0 kg (17.7 lbs.)	Approximately 18.6 kg (41.0 lbs.)
Power Ratings:	100-120 VAC, 50/60 Hz, 8A maximum 220-240 VAC, 50/60 Hz, 4A maximum 40W with oven heat off	In addition to the VPXL: 100-240 VAC, 50/60 Hz, 1.0-0.5 A
Operating Environment	5 to 40 °C, 0 to 80% RH, non-condensing, indoor use. Optimum results are obtained from 20 to 40 °C.	
Heating Range	25 °C to 300 °C, in 1 °C increments	
Heater Control	Temperature controlled to 1°C of set point	
Lower Detection Limit	10 micrograms, 10 ppm, 0.001% (depends on units selected for a particular test and sample size)	
Special Service Carrier Gas	Dry nitrogen or dry air (-40 °C dew point, or lower is suggested) at 17-22 psi. (User supplied)	
Rear Panel Connections	<ul style="list-style-type: none"> • USB host for USB printer, keyboard or USB drive. • Serial port for Balance and Temperature Calibration Interface (TCI) module. • USB slave connector for computer connection. • Ethernet for optional Web Server. • Carrier gas input barb fitting. • Carrier gas outlet port - used for test only. 	<ul style="list-style-type: none"> • Same as the manual VPXL, plus: • Power supply input • 2 USB connections
Resolution	0.1 microgram, 1 ppm, 0.0001 %	
Accuracy	±5% at 1000µg evolved moisture	
Repeatability	Depends on sample properties; typical coefficient of variation (CV) is less than 10% for moisture levels greater than 0.1 % & 15% for moisture levels below 0.1%.	
User Interface	Operation is through a menu driven touchscreen interface. LCD is 800 x 480 Color TFT.	In addition to the VPXL: Status light bar and vial load indicator light.
Memory	<ul style="list-style-type: none"> • Up to 250 Test Programs (including factory test programs) • The last 1000 Test Results are saved along with the 100 Test Graphs 	

Ending Criteria	User adjustable: <ul style="list-style-type: none"> • Prediction • Rate • Time Time ® Rate	
Certifications	US and Canadian Underwriters Laboratory CE Marking (EU Declaration of Conformity) AMETEK Brookfield is an ISO-9001 Registered Company	CE Marking (EU Declaration of Conformity) AMETEK Brookfield is an ISO-9001 Registered Company

20. WARRANTY

AMETEK Brookfield warrants the Computrac® Vapor Pro® XL to be free from defects in materials or workmanship for two years from the date of purchase for those instruments sold in the USA. All other sales typically carry a one year warranty. AMETEK Brookfield will repair or replace, at its option, products that AMETEK Brookfield determines to be defective during the warranty period. All defective parts replaced by AMETEK Brookfield become the property of AMETEK Brookfield. Replacement parts are warranted for the remaining portion of the effective warranty period. This warranty does not apply to expendable or maintenance items such as vials, caps, septa, or capillary tubes. Temperature Calibration Interfaces, Dry Air Generators, and External Balances typically carry a one year warranty.

The above warranty does not extend to any product which has been subjected to misuse, abuse, neglect, accident, improper application, modifications or service performed by persons other than AMETEK Brookfield's service representatives; power surges or spikes; negligence in use, maintenance, storage, transportation or handling; or acts of God.

If a Computrac® product is defective in workmanship or materials, the owner's sole remedy shall be repair or replacement of the defective part, or parts, as provided above. Under no circumstances shall AMETEK Brookfield be liable in any way to the owner or any user for any damage including, but not limited to, any loss of business or profits or any other direct, indirect, special incidental, or consequential damages, whether or not foreseeable, and whether or not based on breach of warranty, contract, or negligence in connection with the sale of such products. (Some states do not allow the exclusion or limitation of incidental or consequential damages, so the above limitations or exclusions may not apply to you.)

No other warranty is expressed or implied, including the warranties of merchantability or fitness for a particular purpose. In no event shall AMETEK Brookfield be liable for consequential and/or incidental damages.

The effective warranty begins on the date of purchase by, or lease to, the first end-user (owner). Keep the dated bill of sale, or invoice, for evidence of the effective warranty date when warranty service is requested.

In the event that any questions or problems should arise in the use or application of your Computrac® Vapor Pro® XL instrument, call AMETEK Brookfield Customer Service or your technical sales representative.

TRADEMARK AND COPYRIGHT PROTECTION

© Copyright 2020 AMETEK® Brookfield. All Rights Reserved.

Computrac®, Vapor Pro®, and the stylized AMETEK® Brookfield logo are all registered trademarks.

Instrument firmware is copyright protected.

All specifications subject to change without notice.

The Vapor Pro® XL uses the Graphics Interchange Format[®] as part of its Ethernet interface. The Graphics Interchange Format is the Copyright property of CompuServe Incorporated. GIF(sm) is a Service Mark property of CompuServe Incorporated.

Drierite® is a registered trademark of W.A. Hammond Drierite Company, Ltd.

Formula 409® is a registered trademark of The Clorox Company.

Kimwipe® is a registered trademark of Kimberly-Clark Corporation.

Phillips® is a registered trademark of the Phillips Screw Company.

Teflon® is a registered trademark of E.I. du Pont de Nemours and Company or its affiliates or successors.

Windows®, Excel®, and Internet Explorer® are registered trademarks of Microsoft Corporation in the United States and other countries.

AMETEK Brookfield
Computrac® Vapor Pro® XL Moisture Analyzer
User Manual P/N: 700-0133

If you have any questions regarding the operation of this instrument,
please call or e-mail for assistance.

AMETEK Brookfield
3375 N Delaware Street
Chandler, AZ 85225

(800) 528-7411

(602) 470-1414

Fax (480) 804-0656

brookfieldengineering.com

Email:

sales.computrac@ametek.com - Sales

international.computrac@ametek.com - International

customerservice.computrac@ametek.com - Customer Support