



Face ID 2

Face & Fingerprint Recognition Terminal

USER MANUAL

CONTENTS

5-6 Chapter 1: Getting Started

- Viewing the Face ID User Manual in the Internet
- Face ID Included Accessories
- Face ID Included Printed Materials
- Activating Face ID
- Registering Face ID

7-11 Chapter 2: Basics

- Introduction to Face ID
- Face ID Overview
- Main Menu
- Power On/Off Button
- Touch Keypad
- Keyboard
- Battery
- Date/Time
- Voice Control
- Security Features
- Cleaning Face ID
- Restarting and Resetting Face ID

12-14 Chapter 3: Connection - Syncing Face ID

- Installations and Communications
- Ingress Online Activation
- Installation and Setup of Ingress
- Connecting Terminals to Ingress
- Using USB to Download/Upload Data
- Communication Key

15-17 Chapter 4: User

- Enrolling User
- Verifying User
- Adding User Information
- Deleting User
- Access Level/Privilege

18-22 Chapter 5: System

General Settings

- Adjusting Date/Time
- Date Format
- Sound of Keyboard
- Voice
- Volume (%)
- Power Key

Display Settings

- System Language
- Style of Display
- View Toolbar
- Determining Default Verification Mode
- Picture Delay
- Sleep Time
- Fingerprint Settings
- Setting Threshold
- Number of Tries
- Display of Algorithm Version
- Display of Fingerprint Image Onscreen

Face Settings

- Setting Threshold
- Camera Exposure
- Gain
- Adjusting Image Quality

Log Settings

- Log Alert
- Update Interval
- Defining Work Codes
- Using Card Only

Update

System Information

- Record
- Terminal

- 23 Chapter 6: Data**
 - Deleting Transaction Logs
 - Deleting All Data
 - Managing User Privilege
 - Deleting Screen Savers
 - Resetting to Factory Settings

- 24 Chapter 7: USB**
 - Understanding the Need for USB Flash Disk
 - Type of USB
 - Downloading Attendance Logs
 - Downloading User Data
 - Uploading User Data from USB to Terminal
 - Uploading User Photo
 - Uploading Pictures to the Terminal

- 25 Chapter 8: Keyboard**
 - Shortcut Keys in Short
 - Configuring Shortcut Keys

- 25-26 Chapter 9: Auto Test**
 - Who should do the Auto Test?
 - Is the Screen OK?
 - Checking the Voice Message/Instruction
 - Checking the Keyboard
 - Inspection on the Optical Scanner
 - Checking the Infrared Camera
 - Is the Time Accurate?

- 26 Chapter 10: Calibration**
 - Calibrating Screen's Sensitivity to Default Level

- 27 Chapter 11: Bell**
 - Definition of Schedule Bell
 - Inserting Time to Trigger Schedule Bell
 - Determining the Ring Type of Schedule Bell
 - Adjusting Volume of the Bell
 - Repetition
 - State

- 28 Chapter 12: Access**
 - Using Face ID as Door Access
 - How Long It Takes Before The Door Locks Again
 - Delaying Door Sensor
 - Choosing Door Sensor Type
 - Delaying Alarm

- 29-31 Chapter 13: Troubleshooting**
 - "Unable to Connect" Appears
 - "Admin Affirm" Appears
 - Difficult to Read Finger
 - The Face ID Doesn't Read Your Face
 - The LED is Blinking All The Time
 - "Duplicate Finger" Appears
 - RFID Card Doesn't Respond
 - No Sound

- 32 Chapter 14: Other Resources**
 - Information About FingerTec
 - Copyright Notice & Disclaimer

1 • GETTING STARTED

Viewing the Face ID User Manual in the Internet

The Face ID User Manual is available in the package when you purchased the FingerTec® Face ID. The User Manual is also available online at fingertec.com and user.fingertec.com. Choose the language that you prefer for your User Manual.

Face ID Included Accessories

Do not abuse the fingerprint sensor by scratching the surface, contacting the sensor's surface with heat, pressing hard during placement of fingerprint for verification. Clean the sensor occasionally with microfiber cloth to maintain the performance of the sensor.

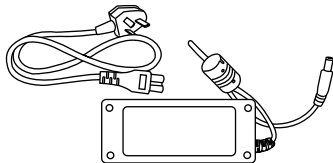

DC 12V Power Adapter

Connect the power adapter to Face ID and plug it into a standard power outlet to charge Face ID.

Connection Wires

Connect the wires to door lock, doorbell, RS232 and RS485, if required.

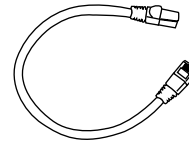

Cat 5 Cable

Connect the CAT5 to Face ID and another end for LAN connection.



A Packet of Bolts

Use the bolts to mount the back plate of Face ID on the wall.



Stylus

For easy navigation on touch screen LCD panel.

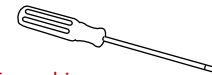

Screwdriver

T10 screwdriver to open the back plate of Face ID for installation.



Measurement Tape

Measuring installation height to achieve optimum performance for Face ID.

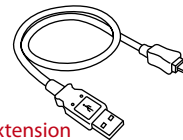

USB Extension

Connect one end of the USB extension to Face ID and another to a USB flash disk to download/upload data from/to Face ID.

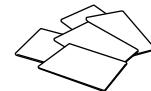

RFID Cards (5 pcs)

FingerTec provides extra cards for RFID (5pcs) and for Mifare Card, every package comes with only 1 sample card.

Face ID Included Printed Materials

- FingerTec Comprehensive DVD
- Quick Start Guide
- Pamphlet
- User Enrollment Template Form
- Warranty Card

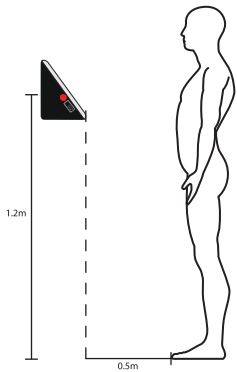

INSTALLATION TIPS:

Best installation location of Face ID 2 must be

- 1 - Avoid from direct or indirect sunlight.
- 2 - 2 meters away from light source i.e. ceiling fluorescent light
- 3 - Suggested 1.2m from the ground level (measure from ground to the face capturing camera)

Activating Face ID

Every FingerTec access control model comes bundled with a unique license key. To start using the terminal with Ingress, you must connect the terminal to Ingress and perform online activation. Ingress reads the serial number of your terminal and sends it for verification at the FingerTec server via Internet.

In case you do not have an Internet connection, you would need to do offline activation. Please send the serial number and models of your terminals to your local resellers or support@fingertec.com to request for a product key and activation key.

Registering Face ID

Make sure that you register your Face ID's warranty with us at fingertec.com/ver2/english/e_main.html#.

2 • BASICS

Introduction to Face ID

Introducing Face ID 2, the latest biometrics product, face recognition technology product combined with fingerprint technology. Face ID 2 can identify an identity in split seconds without any contact or hassle. Face ID 2 only requires user to look at the machine to get verification.

Face ID 2 is loaded with powerful microprocessor that can process dual biometrics authentication methods for accurate personal identifications and for collection of precise data for time attendance and door access. In addition, the Face ID 2 terminal accepts card verification as an added security measure.

If you are looking for contactless, hassle free biometrics product, choose Face ID 2. With one look you are good to go!

Face ID Overview

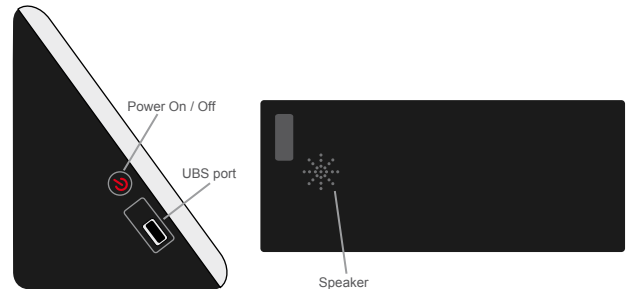
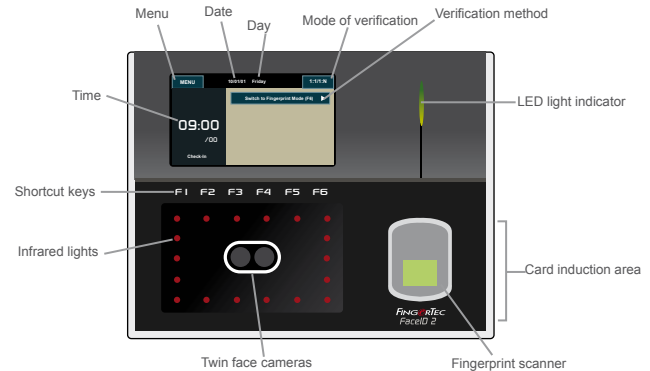

Item	What Is It For
Touch Screen Panel	Touch this screen to access into Face ID system and do configuration.
Shortcut Keys	Customize the function keys for easy access to certain functions.
Infrared Lights	Enhance facial image in poorly lighted areas.
Twin Face Camera	Capture face images in few directions.
Fingerprint Scanner	Use to scan finger for confirmation of identity.
Card Induction Area	Read the card information based on the card system of Face ID.
LED Light Indicator	Indicate the status of reader. Green indicates Face ID is on standby or verification is successful. Red indicates problem or verification is fail.
Speaker	Emit instructions from Face ID
USB Port	Connect the USB extension provided here to download/upload data from/to Face ID

Main Menu



User

Enroll, edit, delete and insert user information from User icon. Face ID 2 allows storage of 700 face images and 3000 fingerprint templates.



Connection

Setup Face ID 2 communication with computer through LAN, RS232 and RS485. Set communication with a computer for a secure data transfer.



System

Configure the settings of Face ID from general to display setting to face and fingerprint. Attendance settings and update settings are also done here.



Data

Check user attendance and transaction logs that are available in Face ID and perform housekeeping of the machine.



USB

Transfer data to and from Face ID 2 using a USB flash disk.



Keyboard

Define shortcut function keys according to your company's preferences.



Auto Test

Run tests to Face ID to diagnose the terminal on various aspects.



Calibration

Calibrate touch screen LCD panel of Face ID for sustained performance.



Bell

Setup siren schedule bell and time interval between rings.



Access

Configure door access settings in Face ID.

Power On/Off Button



Use the power on/off button to turn Face ID on or off. You can disable the button to avoid accidental shut off of Face ID. Refer to page 18, Chapter 5: System- Power Key for details.

Touch Keypad



Press 1:1/N to view the touch keypad. You can insert inputs to the Face ID through the touch keypad. It contains numbers from 0-9, verification mode, fingerprint verification, key and user.

Keyboard



Use the onscreen QWERTY keyboard to type in alphabet and number inputs into Face ID.

Type Upper Case

Tap the arrow pointing up on the left corner of the keyboard to change the lowercase to uppercase.

Type Number

Tap the 123 key to change the keyboard to display numbers.

Return

Tap on Enter button to return

Delete

Tap the arrow pointing left on the right corner of the keyboard to delete your input

Done

Tap X on the keyboard top right corner when you are done using the onscreen keyboard.

Battery

Face ID operates using power supply from a standard power outlet.

Internal battery

The internal battery is provided as a separate accessory and it can last up to 5 hours.

Mini UPS

Mini UPS 12V can also be used to provide power supply to Face ID.

Refer to accessory.fingertec.com for more information about accessories.

Date/Time

Face ID displays date and time at the home screen. Choose date and time format based on your preference. Press Menu > System > Date/Time > Select value > Save.

Voice Control

Voice Control lets you control the level of volume emitted by Face ID.

Turn On/Off

Face ID lets you to turn on/off the voice based on your preference. Press Menu > System > General > Voice Prompts > On/Off > Save.

Adjust Volume

Default volume of Face ID voice is 60. The volume can go as high as 100 and as low as 0. To sustain the performance of speaker in Face ID, it's recommended to stay at range 60-70. To adjust the volume Press Menu > System > General > Volume 1:100 > Set your number > Save.

Security Features

Security features help protect the information from Face ID from being accessed by others.

Admin Affirm

Register an administrator to the system by enrolling face, fingerprint or password to a user ID. Press Menu > User > Add > Privilege: Administrator > Choose enrollment method > Save. After enrolling an administrator, main menu can only be accessed by administrator.

Disable On/Off Button

To avoid accidental shut down of Face ID, the system allows you to disable the On/Off button. Disabling of the On/Off button will disallow unauthorized personnel to switch off Face ID. Press Menu > System > General > Power Key > Disable > Save.

Tamper Switch

Face ID comes with a tamper switch located at the rear of Face ID. During installation, the tamper switch is compressed against the back plate. Any attempt to dismantle Face ID will trigger the alarm inside Face ID and displays "System Broken" on the panel.

Cleaning Face ID

To clean Face ID, please turn off Face ID and unplug all the cables.

Clean Touch Panel

Use a dry cloth to clean Face ID. Do not use any liquids, household cleaners, aerosol spray, solvents, alcohol, ammonia and abrasive solutions to clean the touch screen panel of the Face ID because it could damage the panel.

Clean Fingerprint Scanner

Clean the fingerprint scanner with microfiber cloth.

Restarting and Resetting Face ID

If something isn't working right, try restarting or resetting Face ID

Restart Face ID

Push the On/Off button Face ID to restart Face ID. If you can't restart Face ID, or if the problem persists, you need to reset.

Reset Face ID

Go to Menu, press Data icon and click on Restore to Factory Settings. Press Yes to confirm. Resetting of Face ID will cause all your settings to return to the original factory settings.

3. CONNECTION - SYNCING FACE ID

Installations and Communications

At the rear of Face ID, there are 6 connections available for power and communications.



Back of Terminal

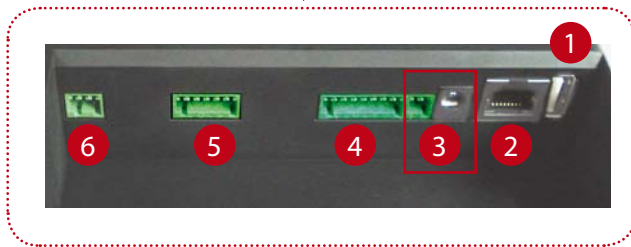

1 USB Port

Linking with USB flash disk for remote data transfer.

2 TCP/IP Port

Connecting with CAT 5 cable for LAN connection, one end to this port and another to the computer's TCP/IP Port.

TCP/IP for Single Connection – Linking Face ID to a single computer using TCP/IP requires Ethernet 10/100Base-T Crossover Cable.

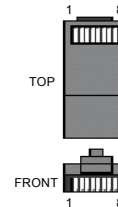

The cable can be used to cascade hubs or to connect Ethernet stations back-to-back without a hub. It works with both 10Base-T and 100Base-TX.

	Joint 1 Pin	Joint 2 Pin	
TX+	1	3	RX+
TX-	2	6	RX-
RX+	3	1	TX+
RX-	6	2	TX-

TCP/IP for Network Connection – Linking Face ID to multiple computers using TCP/IP requires Ethernet 10/100Base-T Straight Thru Cable or “whips”. The cable works with both 10Base-T and 100Base-TX, connecting a network interface card to a hub or

Connector Pin		Cable Color		Connector	
TX+	1	White/Orange	1	TX+	
TX-	2	Orange	2	TX-	
RX+	3	White/Green	3	RX+	
	4	Blue	4		
	5	White/Blue	5		
RX-	6	Green	6	RX-	
	7	White/Brown	7		
	8	Brown	8		

3 Power Supply Port

Insert the Power Adapter point to this port for power

4 RS232/RS485 – Wiegand Connection Port

RS232 – Connection to a computer using RS232 cable.

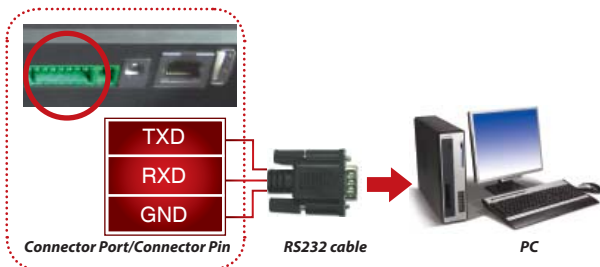

RS485 Single Connection - Connection to a single computer using RS485 wire.

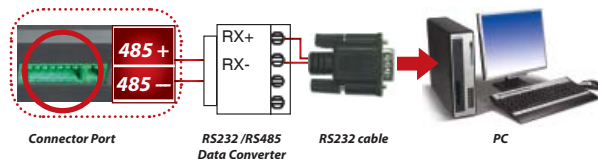

RS485 Network Connection - Connection to multiple computers using Daisy Chain connection.

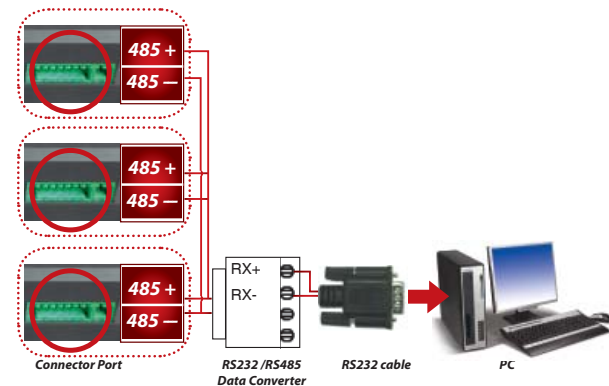

Wiegand Output – Connecting with third party connector or terminal(s)

5 Access Control Port

Linking Face ID terminal to door lock system.

6 Bell Port

Linking Face ID terminal to doorbell

Ingress Online Activation

Ingress is a genuine software by FingerTec. Every FingerTec access control model comes bundled with a unique license key. To start using the terminal with Ingress, you must connect the terminal to Ingress and perform online activation. Ingress reads the serial number of your terminal and sends it for verification at the FingerTec server via Internet.

In case you do not have an Internet connection, you would need to do offline activation. Please send the serial number and models of your terminals to your local resellers or support@fingertec.com to request for a product key and activation key.

Installation and Setup of Ingress

Install Ingress in a PC that fulfills Ingress' minimum requirements. Refer to <http://www.fingertec.com/customer/download/postsales/SUM-Ingress-E.pdf> for the Ingress user guide online. Setup Wizard will require you to do online activation before connection establish between Ingress and terminals.

Connecting the Terminals to Ingress

DETERMINING TERMINAL NUMBER: Identify the number of your terminals to differentiate them between one another. Ingress can connect up to 999 units of terminal. Press Menu > Options > Comm Opt > Dev Num > Select the number.

USING TCP/IP: IP address is important, as it is a unique address of the terminal in LAN. Without the IP address, locating the specific terminal is not possible. **To input the IP address of the terminal:** Press Menu > Options > Comm Opt > IP Addr > Key in IP address.

USING TCP/IP: It is important to setup the Ethernet to connect the terminals using TCP/IP connection. **Setting up the Ethernet is done by enabling the Ethernet function:** Press Menu > Options > Comm Opt >

Ethernet > Yes. Turn off the terminal after you have set the Ethernet setting to Yes. Now, plug-in the network plug to the Ethernet interface and turn the power on. **Determining the Netmask, Gateway and NetSpeed:** For TCP/IP connection, please configure the netmask, gateway and netspeed for the terminal. Press Menu > Options > Comm Opt > NetMask > Insert the numbers. Press Menu > Options > Comm Opt > Gateway > Insert the numbers. Press Menu > Options > Comm Opt > NetSpeed > Choose the speed of your Ethernet connection.

USING RS232 CONNECTION: For connection via RS232, baudrate is the determinant of communication speed between the terminal and the software. The higher the baudrate, the faster the speed is. **To turn on RS232 connection and set the baudrate:** Press Menu > Options > Comm Opt > RS232 > Change the RS232 connection to Y. **To change baudrate:** Press Menu > Options > Comm Opt > Baudrate > Change the Baudrate accordingly.

USING RS485 CONNECTION: For connection via RS485, baudrate is also the determinant of communication speed between the terminal and the software but the speed must be according to the speed of the converter. Check your converter for the speed. **To turn on RS485 connection and set the baudrate:** Press Menu > Options > Comm Opt > RS232 > Change the RS485 connection to Y. **To change baudrate:** Press Menu > Options > Comm Opt > Baudrate > Change the Baudrate accordingly.

Using USB to Download/Upload Data

A USB flash disk is useful in cases where the terminal is installed far from a PC or there is a connection problem. To determine the type of USB flash disks compatible with the terminal, please refer to this link at fingertec.com/newsletter/HL_74.html using USB

Press Menu > PenDrive Mgmt > Choose the operation that you want to carry out via USB flash disk.

Communication Key

Since the software is controlled by an activation code and a product key, set the COMM key to zero. Press Menu > Options > Comm Opt > COMM Key > Set to 0.

4 • USER

Enrolling User

Face ID can contain up to 700 face images and 3000 fingerprint templates, 10,000 card users. This section covers user enrollment for face, fingerprint, card and password.

1. Face Enrollment

One face registration would take approximately 1 minute to completion. The terminal snaps images from 5 angles of your face and generates a 3 dimensional template for storage. During enrolment on Face ID, please stand straight and do not move your face or body, and make sure that your face is calm with no extreme expression. For height between 150cm to 180cm, recommended distance between Face ID and user is 0.5m.

To enroll face: Press Menu > User icon > Add > User ID:1 > Insert User ID > Select Face > Follow instructions from Face ID to complete the enrolment (Make sure that you look at the camera) > Select Privilege > Save

2. Fingerprint Enrollment

It is recommended to enroll two fingers for one user ID. One template is default and another one is used for backup. You need to check the quality of the fingerprint before doing any fingerprint enrollment. It

is important to locate the center points of the finger because the center points has to be placed in the middle of the scanner during enrollment to get a good reading. You also have to make sure that the fingers are not too wet or too dry for enrollment.

To enroll fingerprint: Press Menu > User icon > Add > User ID:1 > Insert User ID > Select Fingerprint > Place your fingerprint 3 times following instructions given by Face ID > Select Privilege > Save

3. Card Enrollment

Default card for Face ID is RFID. MiFare and HID card systems are available upon request.

To enroll card: Press Menu > User icon > Add > User ID:1 > Insert User ID > Select Card > Wave the card at the scanning area until the screen displays the Card ID > Save

4. Password Enrollment

Face ID offers different enrolment methods and password can be used alone or in combination with other verification methods. Maximum length of password is 8 digit.

To enroll password: Press Menu > User icon > Add > User ID:1 > Insert User ID > Select Password > Input password using the touch keypad > OK > Reconfirm password > OK > Save

Verifying User

Verification Method What Is It For

1:1 (One to One) You have to identify your User ID before inputting any biometrics feature for verification. For example, your user ID is 1008 and you use Face verification. One to one method requires you to key in user ID followed by your face to get verified.

1:N (One to Many) You don't need to identify your User ID before inputting any biometrics feature for verification. Simply look at Face ID for face identification or place your finger for verification.

Voice / Message What Does It Mean?

"Verified" Identity verification is successful, Face ID stores the transaction logs and opens the door (if connected to door access)

"Try again please" Identity verification is failed because the finger or face is not properly positioned, the template is not available in Face ID or the password is incorrect.

"Admin Affirm" You are not administrator of the system and you cannot access Menu page.

"Duplicate Finger" This message only appears during registration when the finger that you want to enroll has been enrolled before.

"Invalid ID" For 1:1 verification, User ID entered does not match with face or fingerprint.

Face Verification

1:N – 1:N verification does not require any input of your user ID. Stand in front of Face ID until you can see the reflection of your face on the panel and look at the cameras. Face ID takes a second to verify your face.

1:1 – 1:1 requires input of User ID before Face ID reads and verifies. Press 1:1/1:N > Input ID on the screen > Press face icon > Face ID reads and verifies

Some precautions have to be taken to get a good read every time.

- Stay firm, do not move your head
- Do not cover your face
- Stay calm, do not make extreme facial expression like stick your tongue out or cringe your face
- Do not stand too close or too far from Face ID

Fingerprint Verification

1:N – 1:N verification does not require any input of your user ID. Place your finger properly on the scanner and Face ID takes second to verify your identity

1:1 – 1:1 requires input of User ID before Face ID reads and verifies. Press 1:1/1:N > Input ID on the screen > Press fingerprint icon > Face ID reads and verifies

Some precautions have to be taken to get a good read every time.

- Make sure the center point of your finger is placed in the middle of the scanner for a good read.
How to check your finger's center points?



- Recommended to use index finger. Face ID accepts other fingers but index is the most convenient.
- Make sure the finger is not wet, too dry, injured or dirty
- Do not press hard on the sensor, just place it comfortably
- Avoid direct sunlight or bright light

Password Verification

Password can be an option for those who do not prefer to use other verification methods. To verify using password, press 1:1/1:N > insert User ID and press key button > insert password and press OK.

Card Verification

Place the card on the card scanning area and Face ID reads and verifies.

Adding User Information

User information can be added into Face ID through two ways. One is through Face ID and another through TCMS V2. To add/change user information via Face ID, press Menu > User icon > Select User ID > Edit/Add > Save. To search for users by name, click on the alphabets at the bottom of the screen.



Field	What can you do?
User ID	Edit user ID based on your company's employee numbering system. Maximum length of user ID is 9 digit
Name	Edit/Add name of in this field. Maximum number of characters is 24
FP	Delete/Add Fingerprint
FC	Delete/Add Face
CARD	Delete/Add Card
PWD	Delete/Add Password

It is recommended that updating of user information be done through the TCMS V2 software. After the information is updated, sync TCMS V2 and Face ID to display the information.

Delete User

Only an administrator can do user deletion at Face ID. To delete certain user(s), press Menu > User icon > Select User ID to delete > Press Delete > Press Delete another time for confirmation.

Access Level/Privilege

Face ID offers two types of access level or privilege.

Privilege	What can you do?
Normal User	Only use Face ID to verify your identity. You cannot access into Menu and make changes into settings and system
Administrator	You are allowed to access into menu to enroll users and edit settings and system

5 • SYSTEM

General Settings

Adjusting Date/Time

Face ID is a terminal to record time attendance and door access activities of employees. Precision in time and date cannot be compromised for the system to work efficiently. Adjust Date/Time according to your time zone. Press Menu > System icon > General > Date/Time > Select Value > Save

Date Format

Date format can differ based on countries for example in Malaysia, date-month-year while in America month comes first. Choose your date format according to your preference. The default format is dd-mm-yy. Press Menu > System icon > General > Date Format > Select Format > Save

Sound of Keyboard

Face ID emits sound when you press any of its buttons. To turn on/off the keypad sound: Press Menu > System icon > Keyboard Beep > On/Off > Save

Voice

Face ID has certain voice commands for users to guide user during enrolment and to notify user during verification. Press Menu > System icon > General > Voice > On/Off > Save

Volume (%)

Voice Control lets you control the level of volume emitted by Face ID.

Turn On/Off: Face ID lets you to turn on/off the voice based on your preference. Press Menu > System > General > Voice Prompts > On/Off > Save.

Adjust Volume: Default volume of Face ID voice is 60. The volume can go as high as 100 and as low as 0. To sustain the performance of speaker in Face ID, it's recommended to stay at range 60-70. To adjust the volume. Press Menu > System icon > General > Volume 1:100 > Set your number > Save.

Power Key

You can disable or enable the power on/off button to avoid accidental shutdown of Face ID.

Disable/Enable: Press Menu > System > General > Power Key > Disable/Enable > Save.

Display Settings

Customize your Face ID display to your liking and requirements.

System Language

Face ID offers various languages to match your local requirements. Maximum of 3 language packs available in Face ID and it's set according to your request during purchase. Default language is English. Menu > System icon > Display > Language > Choose your language > Save

Style of Display

Advertise your products or corporate message on Face ID during idle period.

Clock Display: Half of the screen displays advertisement and the other half displays the clock.



Menu > System icon > Display > Display Style > Clock Display

View Toolbar



Choose either you want to hide or display the toolbar on the screen.

Always Display: The toolbar always showing at the bottom of the screen.

Auto Hide: The toolbar is hidden and reappear when you touch the soft touch panel. Menu > System icon > Display > Toolbar Style > Choose your style > Save

Determining Default Verification Mode

While Face ID offers 4 types of verification mode, you can choose your preferred default mode. Face ID automatically requires users to verify in this chosen mode unless user change to mode to his preference/requirements. Option available is face or fingerprint. Menu > System icon > Display > Default Verify Mode > Choose your mode > Save

Picture Delay

Picture delay is an idle period before the screen displays your loaded advertisement. It ranges from 0-999 seconds. Menu > System icon > Display > Picture Delay > Determine your time > Save

Sleep Time

Sleep time is a period before the Face ID goes to sleep mode. This setting is available as power saving feature of Face ID. The time range is from 0-999 seconds. Menu > System icon > Display > Sleep Time > Determine your time > Save

Fingerprint Settings

Configure settings for fingerprint enrollment and verification to achieve optimum effectiveness.

Setting Threshold

Threshold is a level of fingerprint scanner's sensitivity. Threshold determines how many percent of minutiae points on a fingerprint template being read by the system. The higher the threshold level, more points are being read, more restricted the system. Configure the threshold for 1:1 and 1:N methods.

For 1:1, the range is from 15-50 and the recommended value is 35.

For 1:N, the range is from 5-50 and the recommended value is 45.

Menu > System icon > Fingerprint > 1:1 Threshold or 1:N Threshold > Determine the Level > Save

Number of Tries

You can set the limit to the number of tries for 1:1 verification. The range is from 1-9. If a user's number of try exceeds the limit, Face ID could trigger the alarm system to alert security that somebody is meddling with the terminal. Menu > System icon > Fingerprint > 1:1 Retry Times > Determine the Level > Save

Display of Algorithm Version

You can find out the Algorithm Version of your Face ID. Algorithm version is important to know features that are loaded into it and having this knowledge would prompt you to upgrade your terminal for the latest features. The Algorithm Version also determines the firmware for the version. Neither the version can be changed nor deleted. Menu > System icon > Fingerprint > Algorithm Version

Display of Fingerprint Image Onscreen

Face ID offers display of fingerprint image when doing scanning for user to understand how to place the finger properly. You can opt to show the fingerprint image or otherwise.

To enable/disable the fingerprint image display: Menu > System icon > Fingerprint > Fingerprint Image > Choose Your Preference > Save

Options available include:

Fingerprint Image Display	What does it mean?
Both show	The fingerprint image is displayed on the screen during both enrollment and verification.
Neither show	The fingerprint image is neither displayed on the screen during enrollment nor during verification.
Enrol show	The fingerprint image is displayed on the screen only during enrollment.
Match show	The fingerprint image is displayed on the screen only during verification.

Face Settings

Configure settings for face enrollment and verification to achieve optimum effectiveness.

Setting Threshold

Threshold is a level of infrared scanner's sensitivity. Threshold determines how many percent of your face is being read by the system. The higher the threshold level, more percentage is being read, more restricted the system. Configure the threshold for 1:1 and 1:N methods.

For 1:1, the range is from 0-99 and the recommended value is 60.

For 1:N, the range is from 0-99 and the recommended value is 75.

Menu > System icon > Face > 1:1 Threshold/1:N Threshold > Input your value > Save

Camera Exposure/Contrast

You can adjust the light exposure level of infrared cameras in Face ID. Improper value to the settings could affect the performance of the camera. The recommended value is 320. Menu > System icon > Face > Exposure > Input your value > Save

Gain

You can alter the constrast level of infrared cameras in Face ID to get the cameras to perform at their best. The recommended value is 100. Menu > System icon > Face > Gain > Input your value > Save

Adjusting Image Quality

To determine the quality of face images captured by Face ID cameras during enrollment and verification, you can adjust the quality and the recommended value is 80. Menu > System icon > Face > Quality > Input your value > Save

Log Settings

Every time Face ID is being used, transaction logs are kept in the memory. The settings are for Face ID to regulate house-keeping of logs.

Log Alert

When log storage is at a certain level, user/administrator needs to be alerted to avoid underperformance of terminal. The recommended value is 99. Menu > System icon > Log Settings> Log Alert > Input your value > Save

Update Interval

Face ID needs to update transaction logs of all users in a time interval to avoid duplication of punch period. The default interval is 10 minutes. Menu > System icon > Log Settings> Dup. Punch Period (m) > Input your value > Save

Defining Work Codes

Face ID provides work code feature which allowing user to key in a predefined numbers after verification. The work code numbers are predefined in TCMS V2. The following table is showing examples of work codes.

Reasons	Work code
Check In	00
Check Out	01
OT start	04
Done	05
Sick Leave	10
Half-day Leave	12
Emergency Leave	11
Meeting Client	20
Outstation	21

Workcode Mode 1: Verification followed by work code

Workcode Mode 2: Work code followed by verification

Menu > System icon > Log Settings> Workcode Mode > Choose your preference > Save. To add work code through Face ID, please refer to page 21.

Using Card Only

Face ID allows combination of verification methods to achieve tighter security. This feature concentrates on card verification. You can enable or disable Card Only feature by choosing Y or N.

Y – Face ID only reads information from card to verify users.

N – Face ID requires other verification methods following reading of the card.

Menu > System icon > Log Settings > Card Only > Y or N > Save

Update

FingerTec offers update of Face ID regularly. Please always consult your local reseller before you update firmware of the terminal or alternatively you can contact us at support@fingertec.com

System Information

This option in System allows installer to check the information of the terminal including storage, firmware, algorithm, etc. To retrieve Face ID System Information click on icon located on the top right of the screen.

Records



Showing free storage and used storage of Face ID detailing user count, admin count and password user. It also displays other information such as FP templates, Face templates, Logs templates that have been used and available.

Terminal

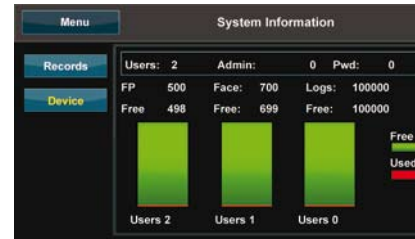

A click on terminal displays Terminal Name, Serial Number of Face ID, MAC Address, fingerprint and face algorithm, firmware version, manufacturer and manufactured date and time.

6. DATA

Every time an enrolment is performed or verification is done, a transaction log is stored inside Face ID. The data contains Terminal ID, date, time, userID and transaction activity. For example, 010502100900000000010000:

Description	Code
Terminal ID	01
Date (ddmmyy)	050210
Time (hhmm)	0900
User ID	000000001
Transaction Code	00
Terminal Activity	00

These logs need to be managed to maintain the effectiveness of the terminal. It is recommended to do the house-keeping of data from the TCMS V2 software but there are 5 functions available in Data icon to enable you to manage your data in Face ID.

Deleting Transaction Logs

Please make sure that you are certain when you want to do this operation. The logs that are stored inside Face ID are the ones that have not been downloaded into TCMS V2. Deleting the logs means that no backup data available. Menu > Data icon > Delete Transactions > Confirmation is required (Yes/No)

Deleting All Data

This function allows you to delete all attendance data and user information in the terminal. Make sure that all user information has been backed up in TCMS V2 before performing this task. Menu > Data icon > Delete All Data > Confirmation is required (Yes/No)

Managing User Privilege

There are two user privileges in Face ID, administrator and normal user. You can delete administrator privilege but without an administrator, normal user can access the menu easily and interrupt the settings. Menu > Data icon > Delete Administrator > Confirmation is required (Yes/No)

Deleting Screen Savers

You can advertise your product and company corporate message in Face ID using screen saver function. To delete all screen savers: Menu > Data icon > Delete Picture > Confirmation is required (Yes/No)

Resetting to Factory Settings

There are some instances, which require you to restore Face ID to original factory settings. Upon completion of this task, Face ID no longer keeps your settings in all functions. Please redo all the settings to suit to your company's requirements. Menu > Data icon > Restore to Factory Settings > Confirmation is required (Yes/No)

7 • USB

Understanding the Need for USB Flash Disk

Communication between Face ID and a PC is very important to upload and download transaction data for time attendance and door access reports. Face ID offers a few communication options such as LAN and serial cable connections but sometimes there are scenarios that require USB (Universal Serial Bus) connectivity. USB can connect Face ID with a computer for download and upload of user information and transaction logs.

Type of USB

There is various type of USB available in the market. Face ID can only work with USB flash disks that support minimum Linux Kernel 2.4.x, working fine with Imation, Transcend and Pen Drive (minimum support Linux Kernel 2.4.x) To determine the type of USB compatible by FingerTec terminal, please refer to this link at fingertec.com/newsletter/HL_74.html

Downloading Attendance Logs

To download attendance logs from Face ID to the computer: Menu > USB icon > Download Transactions. After download process is complete, eject USB flash disk from Face ID and connects it to your PC that has been installed with TCMS v2. Upload the data from the USB into TCMS V2 for further processing.

Downloading User Data

Enrolment of user must be done at the Face ID and during enrolment user data such as name and user ID are inputted. To sync the data in Face ID and computer: Menu > USB icon > Download User

Uploading User Data from USB to Terminal

While administrator can input user data from Face ID, the rests of user information is completed in TCMS V2. Get the latest updates of user information from TCMS V2 to Face ID terminal using USB Flash Disk. Menu > USB icon > User Upload

Uploading User Photo

User photo can be included in user information in TCMS V2. To get the same photos being displayed when user gets verified, upload user photo from TCMS V2 to Face ID. The size of each photo must be 320 x 240 resolution. To do it using USB Flash Disk: Menu > USB icon > Upload User photo

Uploading Pictures to the Terminal

Face ID terminal display advertisements or pictures on the touch screen panel during idle period. The size of the displayed picture must be 320 x 240 resolution. **To upload pictures using USB Flash Disk:** Menu > USB icon > Upload Picture

8 • KEYBOARD

Shortcut Keys in Short

Shortcut keys give you quick access to your most used functions. A total of 6 shortcut keys are available for you to configure. They are labeled as F1, F2, F3, F4, F5 and F6.

Configuring Shortcut Keys

Menu > Keyboard > Click on the key one at a time and select the function you want for the specific key > Save

Some of the functions you can configure for your shortcut keys include status key, work code, viewing of sms, settings of face, setting of fingerprint, etc.

9 • AUTO TEST

Who should do the Auto Test?

Auto Test page is to diagnose or analyze the conditions in Face ID. There are several tests available in the Auto Test page and only administrator is allowed to perform the test. Before running any tests, kindly contact your reseller for advice or you could email support@fingertec.com.

Is The Screen OK?

Test Screen determines the quality and sensitivity of Face ID touch screen panel. You will see lines of different colors; click the screen to continue testing. If there's a broken line or distorted colors on the screen, kindly send your Face ID for repair. Menu > Auto Test icon > Test Screen

Checking the Voice Message/ Instructions

Test Voice determines the quality of Face ID's audio. Every click on the screen will emit different voice message. If you found any distorted sound in any of the voice message or instruction, kindly send your Face ID for checking. Menu > Auto Test icon > Test Voice

Checking the Keyboard

Keyboard Test is for you to check the condition of the keyboard. Menu > Auto Test icon > Keyboard Test

Inspection on the Optical Scanner

To determine the condition of the fingerprint optical scanner you need to run fingerprint test. Once you go into the Test Fingerprint, Face ID will display a white square on the screen. Place your finger on the scanner. If you can see your fingerprint on the white square, the optical scanner works fine. Otherwise, kindly send your Face ID for checking. Menu > Auto Test icon > Test Fingerprint

Checking the Infrared Camera

To know the condition of the infrared face scanner, you need to run face test. Face ID will display a square in the middle of the screen; you have to look into the camera. If you can see your image in the square, the camera is working fine. Otherwise, kindly send your Face ID for checking. Menu > Auto Test icon > Test Face

Is the Time Accurate?

Time is an essence in Face ID and it can't be compromised. The Test Time will display date, time, 0 (s): 0 (ms) Click the screen to start the test. The 0 (s): 0 (ms) will start to run and every 10ms change the second to 1. If it doesn't run well, kindly send your Face ID for checking. Menu > Auto Test icon > Test Time

10 • CALIBRATION

Calibrating Screen Sensitivity to Default Level

Menu > Calibration

The screen will display five dots, one at a time in all corners of the screen and one at the center. You need to touch the center of the dot for the system to calibrate the screen automatically. When the process is done, the screen will return to the main menu.

Definition of Schedule Bell

Schedule bell is a function to alert employees or users at a certain time based on your company's scheduling and preference. For example, a group of employee's lunch time is at 10:30a.m while the other group is at 2:00p.m. Face ID offers up to 56 schedules you can define. Menu > Bell > Choose the options that you want to change and change the value accordingly > Save

Inserting Time to Trigger Schedule Bell

The screen displays 00:00 as default time. A tap on the time will prompt the number keypad. Input the time you want the bell to ring. The time format is 24:00 hours.

Determining the Ring Type of Schedule Bell

Face ID offers various type of ringtones to choose from. A tap on the ringtone will change the sound of the bell. Select the one you prefer.

Adjusting Volume of the Bell

You want it loud or not, it's up to you. Face ID offers volume from 0-100, default volume is 60. A tap on the value will prompt the keypad. Input your volume value to determine the level of volume you desire.

Repetition

How many times do you want the bell to ring? A tap on the value will prompt the keypad. Input the numbers and the bell will ring according based on your settings.

State

You can enable or disable the schedule bell with a tap on Enable/Disable bar.

12 • ACCESS

Using Face ID as Door Access

Face ID can be connected to door access accessories like electromagnetic lock and doorbolt to control access to doors. FingerTec provides all kinds of doorlock accessories which can be viewed at accessory.fingertec.com. In Access icon, you can configure 4 items which are explained below. To access to Access: Menu > Access

How Long It Takes Before The Door Locks Again

This value is the time period for the door to lock again after it unlocks on successful verification. Default value is 10 second and the range is between 1-10.

Delaying Door Sensor

This function only works if door sensor is available. When a door is not closing for a specified time, the sensor will trigger alarm system. Specify the time of the delay. Default value is 10s, the range is 0-99s. Choose your preference.

Choosing Door Sensor Type

There are two types of door sensor available for door access which are Normally Open (NO) and Normally Close (NC). Once a door sensor is available, you have to choose the door sensor type. Default is None.

Delaying Alarm

This function only works when there is alarm system installed with Face ID. You can adjust the time before Face ID triggering an alarm system if the door is not closed. A tap on the value will prompt a keypad. Input the value in seconds. The default value is 30s.

13 • TROUBLESHOOTING

“Unable to Connect” Appears

When this message appears, it means that the settings for Face ID and the computer are not properly done. Find out which method you are using to connect. Face ID offers LAN, RS232, RS485 and USB communication methods. Refer to Chapter 3 to further understand the topic.

“Admin Affirm” Appears

You are not the administrator of this Face ID terminal. Only an authorized administrator of the system is allowed to access the Menu. Any attempt of normal user to access the Menu will prompt “Admin Affirm” message on the screen. In case the administrator or he/she has resigned from the company, kindly contact your FingerTec authorized reseller to access the Face ID.

Difficult to Read Finger

Five things could be the caused of this:

Enrolment is not properly done

Enrolment is the most important process to ensure that Face ID captures the best quality of your fingerprints. Refer to chapter 4 for how to do a good enrolment.

The location of Face ID is not conducive

The scanner does not work well in bright-lighted area. Cover the scanner a bit if this is the cause of the difficulty. Shift the location area for a better performance.

Finger is not properly placed

To get a good read, make sure that your finger’s center points are located at the middle of the scanner. Adjust the position of your fingerprint as you see it onscreen.

The scanner is not cleaned or it is scratched

Check the quality of the scanner. If the scanner is dirty, please clean it with microfiber cloth on the scanner. If it’s scratched, contact your local reseller for a replacement.

Anything happen to your finger lately?

Make sure that the finger is not injured, cut or bruised because it could cause difficulty to read. The algorithm reads the minutiae points of your fingerprint, the more it can read, the better the result.

The Face ID Doesn't Read Your Face

Two possible causes for this to happen:

Have you stand properly and not making any facial expression?

Your position from the camera must be at a proper distance from the camera. If you see your reflection at the camera, you are at the right position. Now, were you making facial expression during verification? Don't. Stay calm and look at the camera. And please do not cover your face with anything.

Have you tested the camera of your Face ID?

The camera might not be working properly. Test your camera's performance. Refer to Chapter 9 to Test the Face Camera.

The LED is Blinking All The Time

You have nothing to worry about unless the blinking light is red. The green blinking light is indicating that Face ID is under its standby mode. Red blinking light may signal problem in the Face ID. Contact your reseller for consultation.

"Duplicate Finger" Appears

Face ID is an intelligent terminal. It will not accept the same fingerprint twice into its system. If you have registered a finger into Face ID, the system would prompt "duplicate finger" when you try to enroll that finger for another time. Choose a different finger to proceed.

RFID Card Doesn't Respond

Two possibilities for this problem

Have you registered the card to the terminal?

The card must be registered to face ID before the terminal could read the information in the card. Refer to chapter 4 User for card enrolment.

Have you assigned the user ID to the verification group that supports RFID card?

Without setting Face ID that you are under a group that supports RFID card, the Face ID wouldn't read your card.

No Sound

Two possible causes for this problem:

Face ID voice mode is silent

Perhaps someone has turned off the voice in your Face ID or reduced its volume to 0%. Refer to Chapter 5 System under Voice to rectify.

Speaker is damaged

Once you have rectified the voice mode and the problem persists, proceed to test the voice. Go to Chapter 9 to do the test. If no voice emitted, contact your local reseller for support.

14 • OTHER RESOURCES

Information About FingerTec

To learn about	Go to?
Company and the products	www.fingertec.com
The latest updates	Facebook Fan Page: FingerTec Worldwide Twitter: FingerTec Worldwide To subscribe for FingerTec newsletter: www.fingertec.com/subscribe-R/newsletter.html
Technical Tips and Latest Product Updates and Upgrades	user.fingertec.com
Email	info@fingertec.com (Sales) Support@fingertec.com (Technical)
Register for Warranty	www.fingertec.com/GPW/warranty.htm
FingerTec Accessory	accessory.fingertec.com

Copyright Notice & Disclaimer

COPYRIGHT NOTICE

All rights reserved. No part of this book may be reproduced or transmitted in any form or by any means, electronic or mechanical, including photocopying, recording, or by any information storage and retrieval system, without written permission from FingerTec Worldwide Sdn Bhd. Every precaution has been made to supply complete and accurate information. Information in this document is subject to change without prior notice.

DISCLAIMER

No person should rely on the contents of this publication without first obtaining advice from a qualified professional person. The company expressly disclaims all and any liability and responsibility to any terminal or user of this book, in respect of anything, and of the consequences of anything, done by any such person in reliance, whether wholly or partially, upon the whole or any part of the contents of this book.

FINGERTEC WORLDWIDE SDN BHD

© 2013 FingerTec Worldwide Sdn. Bhd. All rights reserved. • 062013

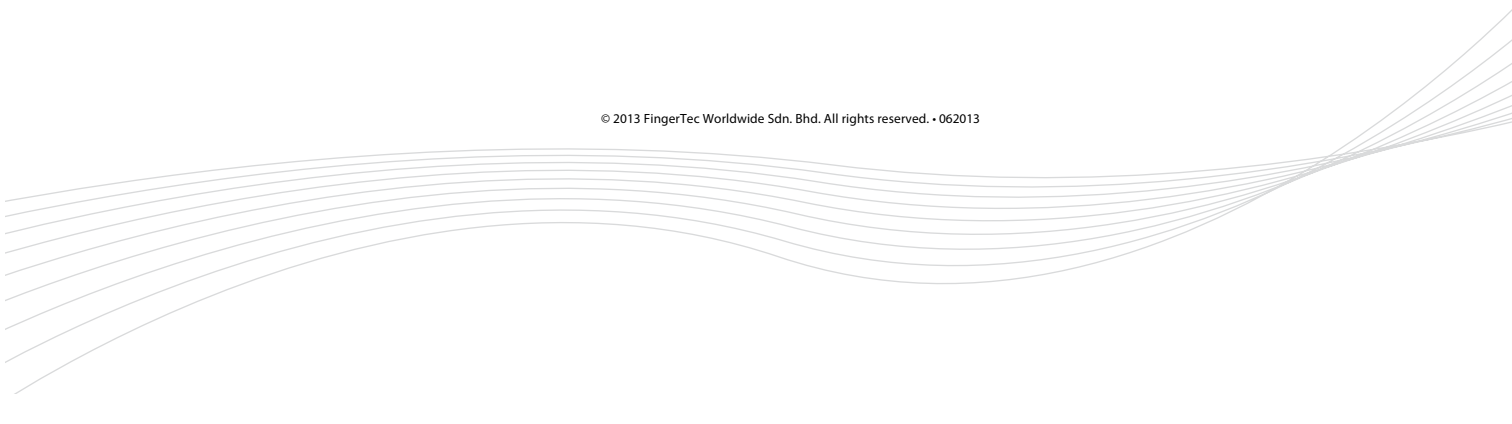
A decorative graphic consisting of several thin, light gray lines that curve and wave across the bottom of the page, starting from the left and ending on the right.