





VIVOS®

We Prevent Crime · Protect You

www.vivos.com.my

“EZ-P”

EASY PROGRAMMING

-  } App control
-  } Automation Control
-  } Protect Your Assets
-  } 365-days Monitoring

Most User Friendly

Alarm System in Malaysia



Secure and Protect

your loved ones and belongings

WHY LIVE IN FEAR WHEN PEACE IS JUST A CLICK AWAY?

VG6 / VG10

6-Zone Security System
10-Zone Security System

ViVOS[®]
We Prevent Crime · Protect You



VG6
6-Zone Security System



VG10
10-Zone Security System

Technical Comparison	VG6	VG10
EZ-P Setup (Easy programming setup)	✓	✓
During Start-up	✓	✓
Duress Contact	✓	✓
Alarm Memory Event	✓ 50 event log	✓ 50 event log
Telephone Voice Reporting	✓ Tone feedback	✓ Full voice reporting (2x language, English & Mandarin)
Zone Input	✓ 6 programmable zone	✓ max up to 16 programmable zone
Security Partition	✓ 2 partition	✓ 2 partition
Tel EZ Access	✓	✓
GSM Reporting	✓ 4 for personal reporting + 6 zone open SMS status	✓ 4 for personal reporting + 16 zone open SMS status
IOT Module & Apps	✓	✓
Auto Arm/Disarm Timer	✓	✓
Number Of Home Automation	Not support	✓ 4 Modules (16HA point)
Keypad Code Guessing Protection	✓	✓
Zone Sensitivity	✓	✓
Telephone Reporting	✓	✓
Central Monitoring Station (CMS)	✓	✓

VG10

10-Zone Security System

ViVOS[®]

We Prevent Crime · Protect You

Available on the
App Store

ANDROID APP ON
Google play

OUTDOOR SIREN ◀

▶ PANIC BUTTON

WINDOW SENSOR ◀

▶ DOOR SENSOR

▶ PHOTOBEAM SENSOR

▶ PIR MOTION SENSOR

SMOKE DETECTOR ◀

VG-10

10-ZONE (EXPANDABLE TO 16-ZONE)
ALARM AUTOMATION SYSTEM



} App control



} Protect Your Assets



} Automation Control



} 365-days Monitoring

Most User Friendly

ALARM SYSTEM IN MALAYSIA

1 APP

App Control
Arm/Disarm & Switch On/Off home appliances via Mobile Phone App. Receive message when user turn off the Vivos Mobile Apps like messaging apps.

Available on the **App Store** **GET IT ON Google play**

Automation Control
Smart control via Automation Module in which owner can remote monitor & control house gadget via Mobile Phone.

10-Zone Expandable to 16-Zone & SMS Control via GSM Module
A better surrounding for a better lifestyle. the GSM Module also Calls or SMS the user to inform about events happening on the system.

PRODUCT FEATURES

- 1) "EZ-P" Setup. Only required 4 set of data during system startup, i.e:
 - Step 1** - Master Code
 - Step 2** - User 1 Telephone Number
 - Step 3** - System Clock
 - Step 4** - System Date
- 2) Auto detecting keypad & module during startup
- 3) Duress User Identification for User 1 ~ User 4 **Emergency Tel-no**
- 4) 50 Events Log with Time, Date, Month and Year
- 5) English or Mandarin telephony voice guide menu selection
- 6) 2 x Partition with 2 x Siren Output
- 7) Access code: 1 Master Code and 15 User Code
- 8) Maximum up to 4 keypad
- 9) Fully programmable 10 zones with EOL on board. Expandable to 16 zones
- 10) 2 x CMS Reporting Numbers & 4 x Personal Call Reporting Numbers
- 11) 7 x Arm Mode : Away, Stay, Vacation, Force, Auto Timer, Remote and Telephony
- 12) Auto detection of system failed status
- 13) RS485 communication to support longer distance
- 14) AC and communication LED status indicator

Authorised Dealer

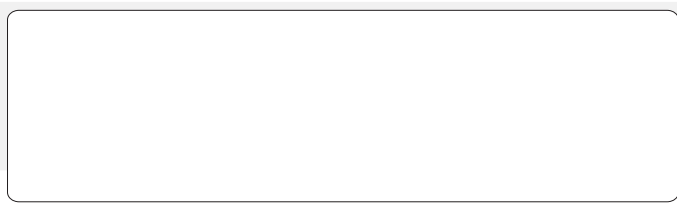

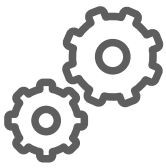

Module Expandable

ViVOS-VG6 is simple expansion module installation friendly & effortless. Changing of alarm panels or hardware for expansion module is optional.

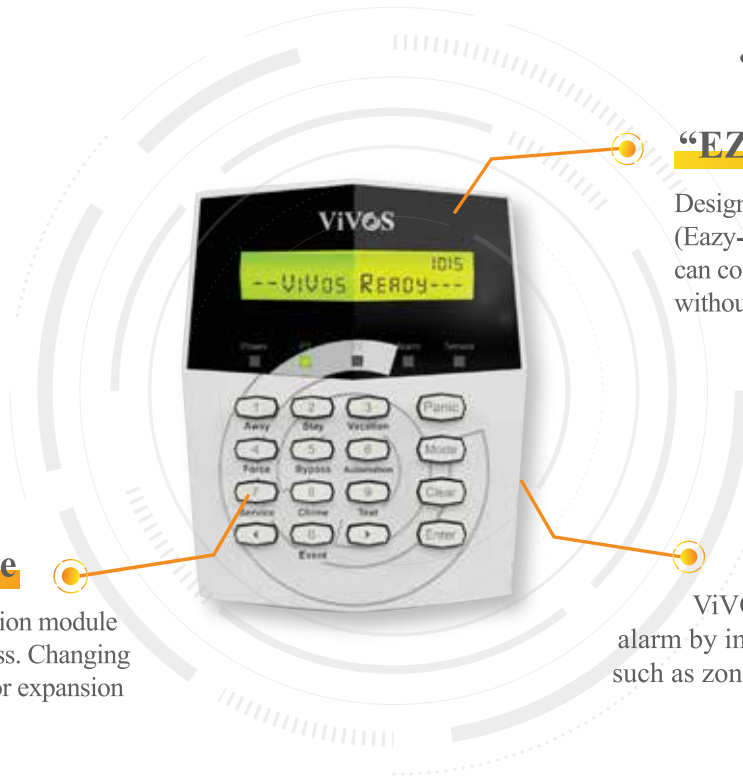

“EZ-P” Setup

















Designed for all generation. With “EZ-P” (Eazy-Programming) technique, everyone can configure the system during start-up without hassle.



Minimize False Alarm

ViVOS is engineered to minimize false alarm by implementing sensitivity adjustment such as zone response and smart zone features.

PRODUCT FEATURES

- | | |
|--|---|
| <p>1) “EZ-P” Setup. Only required 4 set of data during system startup, i.e.:</p> <ul style="list-style-type: none">  Step 1 - Master Code  Step 2 - User 1 x Telephone Number  Step 3 - System Clock  Step 4 - System Date | <ul style="list-style-type: none">  6) 2 x Partition  7) Access code: 1 Master Code and 5 User Code  8) Maximum up to 4 keypad  9) Fully programmable 6 zones with EOL on board.  10) 2 x CMS Reporting Numbers & 4 x Personal Call Reporting Numbers  11) 6 x Arm Mode: Away, Stay, Force, Auto Timer, Remote and Telephony  12) Auto detection of system failed status  13) RS485 communication to support longer distance  14) AC and communication LED status indicator |
| <ul style="list-style-type: none">  2) Auto detecting keypad & module during startup  3) Duress User Identification for User 1 ~ User 4  4) 50 Events Log with Time, Date, Month and Year  5) Guide by tone feedback | |

Authorised Dealer



Smart Security Mobile App

VIVOS[®]
We Prevent Crime · Protect You

MAIN FUNCTION



Push Notification Alert

Receive message when user turn off the Vivos Mobile Apps like messaging apps



Alarm & Home Automation Control

Arm/ Disarm & Switch On/Off home appliances via Mobile Phone App



System Status Report

Report viewing and system status checking like power/ battery failure



Autogate Control

Able to control open/close autogate via apps



CCTV Viewing

Integration with CCTV for viewing



FEATURES

- QR code registration process
- 2 x stand alone dedicated output
- Arm/ Disarm with 1 or 2 partition
- Device will show online or offline
- Login with multiple user email together at the same time
- “Priority security level” for Master or normal user to control via Apps
- Up to multiple user (different email)
- with multiple device(difference location)
- 50 event log with date, time, user & system health check (AC Loss, Battery Low, etc)

IOT App Module



YOUR SMART MOBILE APP

Safety, Security & Simplified.



GSM Module Alarm System

SMART FEATURE

- Backup unit for landline
- Duress reporting
- Voice Guide Control
- Full Zone open/close SMS report*
- SMS reporting (up to 3 GSM number)
- Personal reporting (up to 3 GSM number)
- Full SMS control with smart access detection
- System trouble reporting on personal reporting/SMS



VIVOS[®] GSM MODULE

- ViVOS[®] GSM module links to ViVOS alarm panel and then to the user's mobile phone.
- It enables the user to control many of the functions of the system from anywhere and everywhere as long as there is mobile network connection.
- The GSM module also calls or SMS the user to inform about events happening on the system.
- This means the user can monitor and control the alarm system and lights from the mobile phone.

ViVOS GSM Module can also continually monitor assigned zone for the open and close activity.

A BETTER SURROUNDING FOR A BETTER LIFESTYLE

STAY SAFE LIVE BETTER



Safety Convenience Security



0 1 0 0 1 0 0 1 1 0 1 1
0 1 1 1 0 1 0 1 0 0 1 0

Digital Security for your *peacefulness.*

Designed by **ViVOS®**

- "ViVOS is Most User Friendly Alarm System in Malaysia"
Our company is using the latest and most user friendly systems to provide the best services to our customers.
- Vivos established in Year 2013.
- Young Generation R&D Team in Security System Industry
- Total team experiences in Security field is >30 years.
- Providing security solutions including public safety, commercial, retail, residential, and industrial sectors.

Authorised Dealer



Website: www.vivos.com.my

MAINBOARD FEATURES

- Power restart Button on mainboard.
- Install sensor point without resistor
3 x choices for installer
 1. Built-in EOL (EOL-End of line= Resistor)
 2. External EOL
 3. Unused Zone
- Remote key switch input- remote control arm/disarm
- System Indicator - 12vdc(LED+ / LED-)
- Telephony Module- Plugable
- 10 zones on board, expandable to 16 zones

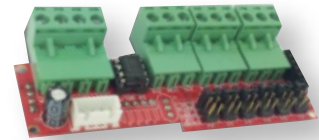
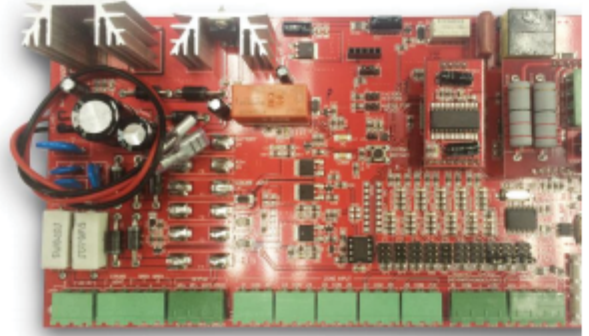

6 Zone Expander

PRODUCT FEATURES

- System Auto Recovery
- 4-points output control
- Relay built-in feedback sensor
- Expandable up to max 16 points
- 1-way or 2-way selection on board
- Latch and momentary output selection

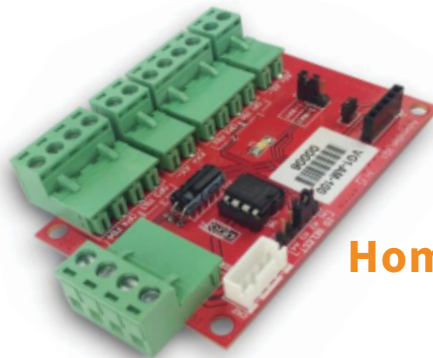
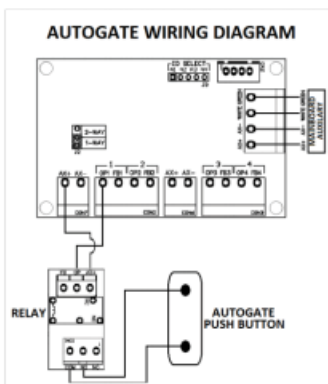
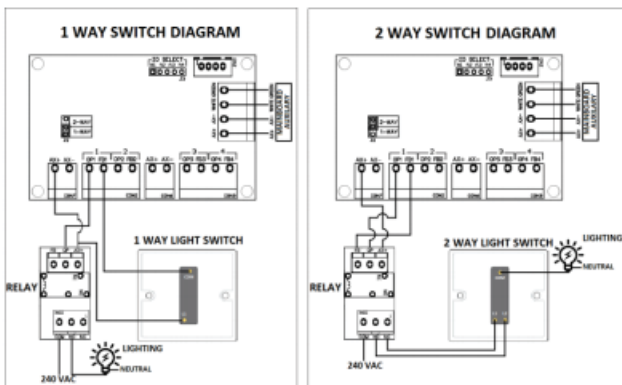

Home Automation Module

Authorised Dealer