

Contents

1.0 INTRODUCTION	3
2.0 TESTING	3
3.0 LIMITATIONS	3
3.1 WARNINGS	3
4.0 GLOSSARY	4
5.0 SUMMARY OF OPERATION	5
6.0 TELEPHONY CONTROL DIAGRAM	7
7.0 UNDERSTAND YOUR KEYPAD INDICATORS	8
8.0 USER MENU SUMMARY DIAGRAM	9
9.0 USER PROGRAMMING SUMMARY TABLE	10
10.0 ARMING THE SYSTEM	13
10.1 AWAY ARMING.....	13
10.2 DAY ARMING.....	14
10.3 NIGHT ARMING.....	14
10.4 FORCE ARMING.....	15
10.5 HOLIDAY ARMING.....	15
10.6 REMOTE CONTROL ARMING (OPTIONAL).....	16
10.7 AUTO TIMER ARMING.....	16
10.8 TELEPHONE REMOTE ARMING.....	17
11.0 DISARMING THE SYSTEM	17
11.1 KEYPAD DISARMING.....	17
11.2 REMOTE CONTROL DISARMING (OPTIONAL).....	18
11.3 AUTO TIMER DISARMING.....	18
11.4 TELEPHONE REMOTE DISARMING.....	18
12.0 TURN ON/OFF HOME AUTOMATION POINT	19
13.0 BYPASS ZONE	19
14.0 UN-BYPASS ZONE	20
15.0 VIEW SYSTEM TROUBLE	20
16.0 EVENT VIEWER	21
17.0 CHIME MODE	22
18.0 VIEW ZONE VOCABULARY SETTING	22
19.0 VIEW HA POINT VOCABULARY SETTING	23
20.0 EMERGENCY SITUATION	23
21.0 PARTITIONING THE SYSTEM	25
22.0 ARMING A PARTITIONED SYSTEM	25
22.1 AWAY ARMING 4 PARTITIONS SIMULTANEOUSLY.....	25
22.2 AWAY ARMING EITHER 1 PARTITION.....	26
22.3 FASTKEY AWAY ARMING EITHER 1 PARTITION.....	27
22.4 PARTITION DAY ARMING.....	28
22.5 PARTITION NIGHT ARMING.....	29

22.6 PARTITION FORCE ARMING 29

22.7 PARTITION HOLIDAY ARMING 30

23.0 PARTITION DISARMING 30

24.0 USER CODE 31

25.0 USER PROGRAMMING MODE 32

25.1 ACCESS USER PROGRAMMING MODE 32

25.2 EXIT USER PROGRAMMING MODE 32

25.3 PROGRAM NEW AND CHANGING EXISTING MASTER / USER CODE 32

25.4 PROGRAM NEW AND CHANGING EXISTING DURESS CODE 33

25.5 ERASE USER or DURESS CODE 34

25.6 PROGRAM SYSTEM TIMER..... 35

25.7 PROGRAM AUTO ARM PARTITION 1/2/3/4 TIMER 35

25.8 TO ERASE AUTO ARM PARTITION 1/2/3/4 TIMER..... 36

25.9 PROGRAM AUTO DISARM PARTITION 1/2/3/4 TIMER..... 36

25.10 TO ERASE AUTO DISARM PARTITION 1/2/3/4 TIMER 37

25.11 PROGRAM AUTO ON TIMER 1/2/3/4 FOR HOME AUTOMATION 38

25.12 TO ERASE AUTO ON TIMER 1/2/3/4 FOR HOME AUTOMATION 39

25.13 PROGRAM AUTO OFF TIMER 1/2/3/4 FOR HOME AUTOMATION 39

25.14 TO ERASE AUTO OFF TIMER 1/2/3/4 FOR HOME AUTOMATION 40

25.15 PROGRAM PERSONAL TELEPHONE NUMBER 1/2/3/4..... 41

25.16 TO ERASE PERSONAL TELEPHONE NUMBER 1/2/3/4..... 41

25.17 PROGRAM GSM TELEPHONE NUMBER 1/2/3/4..... 42

25.18 TO ERASE GSM TELEPHONE NUMBER 1/2/3/4..... 43

25.19 PROGRAM SYSTEM DATE 44

26.0 TESTING THE SYSTEM 44

26.1 WALK TEST 44

26.2 CMS TEST (Manual Test)..... 45

26.3 SIREN TEST 45

26.4 STROBE LIGHT TEST..... 45

26.5 BATTERY TEST 45

27.0 PAGE SWITCHING..... 46

28.0 SYSTEM INFORMATION..... 47

29.0 SYSTEM SETTING..... 48

1.0 INTRODUCTION

The **BLUGUARD** Control Panel is designed for simple operation yet provides the maximum protection for you. Please read this manual carefully and follow the instructions contained in this book. Fill in the system information page and store this manual in a safe place for future reference.

Your security system consists of a main control panel, one or more keypads and home automation (HA) modules, various sensors and detectors. An enclosure will contain the control panel, which includes the system electronics and standby battery.

2.0 TESTING

To ensure that your system is functioning, it is important that you test your system weekly. Please refer to testing procedures section in this manual. If your system does not function properly, please contact your system installer for services. There is normally no reason for anyone other than the installer or service professional to have access to the control panel.

3.0 LIMITATIONS

Even though BLUGUARD is an advanced security system, it does not 100% guarantee the protection against burglary, fire or other losses. Any alarm system whether commercial or residential is subjected to compromise or failure-to-warn for a variety of reasons. These include:

- Intruders may gain access through unprotected openings or have the technical sophistication to bypass an alarm sensor or disconnect an alarm warning device.
- Intrusion detectors, smoke detectors and many sensing devices will not operate without power. Devices powered by AC will not work if there is no AC power supply for any reason and the back-up battery is missing, dead or improperly installed.
- Alarm warning devices such as sirens may not alert people or wake up sleepers if they are located on the other side of closed or partly closed doors.
- Telephone line needed to transmit alarm events from the premise to a central monitoring station may be out or temporary out of service. Telephone line is subject to compromise by sophisticated method of attack.
- Smoke detector used in conjunction with the alarm system may not sense fire that start from where smoke cannot reach the detector such as wall, roof or the other side of the doors. Smoke detector also may not sense a fire on another level of the residence or building. In general, detectors may not always warn you about fire caused by carelessness and safety hazards like smoking, violent explosions, escaping gas, improper storage of flammable material, overloaded electrical circuits, children playing with matches.
- The most common cause of an alarm system not functioning properly when an intrusion or fire occurs is inadequate maintenance. Therefore, your system should be tested weekly to ensure all detectors or sensors are working properly.
- Installing an alarm system may make you eligible for lower insurance rates but an alarm system is not a substitute for insurance. Homeowners, property owners and renters should continue to insure their lives and properties.

3.1 WARNINGS

- **A readily accessible disconnect device shall be incorporated external to the equipment when installation.**
- No operator's replaceable batteries provided.
- The caution of replacement of battery provided in installation instructions for SERVICE PERSON.
- **CAUTION: RISK OF EXPLOSION IF BATTERY IS REPLACED BY INCORRECT TYPE.**
- **CAUTION: DISPOSE OF USED BATTERIES ACCORDING TO THE INSTRUCTIONS.**
- The installation instructions require the **external protective earthing green/yellow wire must be at least 0.75mm²/18AWG complying with table 3B.**

Note: All information is subject to changes without prior notice.

4.0 GLOSSARY

Alarm Memory	This is the history of the most recent violations that occurred the last time when an alarm was triggered.
Arm	To set the system into the ARMED mode. In this mode, a zone violation will activate an alarm condition. If the system is programmed accordingly, it will cause a reporting code to be sent to the central monitoring station.
Bypass	To deactivate zone. When the panel is ARMED, violation of a bypassed zone will be ignored.
Chime	A short beep sound from the keypad to indicate a zone is violated.
Day Arm	Instant arming that allows for certain preprogrammed, DAY STAY zones to be violated while the system is armed. In this mode, an ENTRY delay time will be given to the user to disarm using the keypad after entering the armed premises.
Day Stay Zone	Zones that are bypassed automatically when the system is DAY ARMED.
Disarm	To deactivate the system. FIRE, PANIC and MEDICAL remain active while the system is disarmed.
Duress Code	An ambush code which will disarm the system and simultaneously send a silent distress signal to the central monitoring station.
Entry/Exit Zone	A zone with programmable delay time will allow user to exit the premises after arming the system and disarm by using the keypad after entering the armed premises. This zone is generally the last exit point and the first entry point of the building, i.e. the front door of a house.
Follower Zone	A zone that may be temporary violated during exit delay period or after the first violation of an ENTRY/EXIT zone. This allows the user access to disarm the system. A FOLLOWER zone will behave as an instant zone if it is violated prior to the violation of an ENTRY/EXIT zone.
Force Arm	Arming with exit delay that allows for certain violated zones to be bypassed temporary. When the violated zones resume, these zones will be protected. There is an ENTRY delay time in this arming mode.
Home Automation (HA)	Optional system expander module that allows you to control different light and appliances from any keypad, remote telephone, cellular phone. It can also be programmed to turn on/off light at certain time daily or during alarm condition.
Instant Zone	When the system is armed, any violation of an instant zone will immediately cause an alarm condition to be registered.
Master Code	Master code is a 4-digit personal identification number that allows you to enter certain programming mode, arm or disarm the system and remotely control the system via telephone line.
Night Arm	Instant arming that allows for certain preprogrammed, NIGHT STAY zones to be violated while the system is armed. In this mode, there is no ENTRY delay time for the user.
Night Stay Zone	Zones that are bypassed automatically when the system is NIGHT ARMED.
Partitioning	A partitioned system is a single physical security system that provides independent areas of protection intended for use by independent users.
Remote Control Arm	Arming with a momentary or latch remote control module. In this mode, it allows certain violated zones to be bypassed temporary. When the violated zones resume, the zone will be protected. There is an ENTRY and EXIT delay time in this arming mode.
User Code	User code is a 4-digit personal identification number that allows you to arm or disarm the system.
Zone	A specific area of your premises guarded by sensors, which detect violations of that area.

5.0 SUMMARY OF OPERATION

System Disarm	[4-digit User Code] + [#]
Intelligent Arming	[4-digit User Code] + [#]
Away Arm	Hold down [1] for 2 seconds
Day Arm	Hold down [2] for 2 seconds
Night Arm	Hold down [3] for 2 seconds
Force Arm	Hold down [4] for 2 seconds
Turn On/Off Home Automation Point	Hold down [5] for 2 seconds + [HA point number 01 to 32] + [#]
Bypass Security Zone	Hold down [6] for 2 seconds + [Zone number 01 to 32] + [#]
View System Trouble	Hold down [7] for 2 seconds
View Event Log	Hold down [8] for 2 seconds
Program Chime Zone	Hold down [9] for 2 seconds + [Zone number 01 to 32] + [#]
Holiday Mode Arming	Hold down [0] for 2 seconds
Activate Fire Alarm	Hold down [F] for 2 seconds
Turn On/Off Keypad Buzzer	Press [MODE] + [6] + [#]
On/Off Voice for Chime Zone	Press [MODE] + [7] + [#]
Activate Panic Alarm	Press [MODE] + [8] + [#]
Activate Medical Alarm	Press [MODE] + [9] + [#]
Page Switching (Zone 1-16 or Zone 17-32)	Press [*]
<p>Remark: Press 2-digit number to enter zone number. Example: To enter zone number 8, press [0] + [8]; To enter zone number 15, press [1] + [5]; To enter zone number 32, press [3] + [2].</p>	

SUMMARY OF OPERATION (CONT.)

PARTITION SYSTEM ENABLED	
Intelligent Disarm	[4-digit User Code] + [#] + [Partition 1] or [Partition 2] or [Partition 3] or [Partition 4]
Intelligent Arming	[4-digit User Code] + [#] + [Partition 1] or [Partition 2] or [Partition 3] or [Partition 4]
Away Arm	Hold down [1] for 2 seconds + [Partition 1] or [Partition 2] or [Partition 3] or [Partition 4]
Day Arm	Hold down [2] for 2 seconds + [Partition 1] or [Partition 2] or [Partition 3] or [Partition 4]
Night Arm	Hold down [3] for 2 seconds + [Partition 1] or [Partition 2] or [Partition 3] or [Partition 4]
Force Arm	Hold down [4] for 2 seconds + [Partition 1] or [Partition 2] or [Partition 3] or [Partition 4]
Holiday Mode Arming	Hold down [0] for 2 seconds + [Partition 1] or [Partition 2] or [Partition 3] or [Partition 4]
TESTING THE SYSTEM	
Sensor Walk Test	Press : [MODE] + [1] + [#] or [Menu] ⇒ [System Tests] ⇒ [Walk Test]
CMS Reporting Test	Press : [MODE] + [2] + [#] or [Menu] ⇒ [System Tests] ⇒ [CMS Test]
Siren Test	Press : [MODE] + [3] + [#] or [Menu] ⇒ [System Tests] ⇒ [Siren Test]
Strobe Light Test	Press : [MODE] + [4] + [#] or [Menu] ⇒ [System Tests] ⇒ [Strobe Test]
Battery Test	Press : [MODE] + [5] + [#] or [Menu] ⇒ [System Tests] ⇒ [Battery Test]

6.0 TELEPHONY CONTROL DIAGRAM

Call In to System:

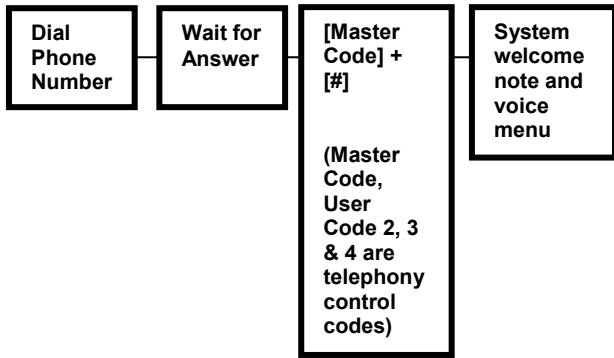

System Call Out:

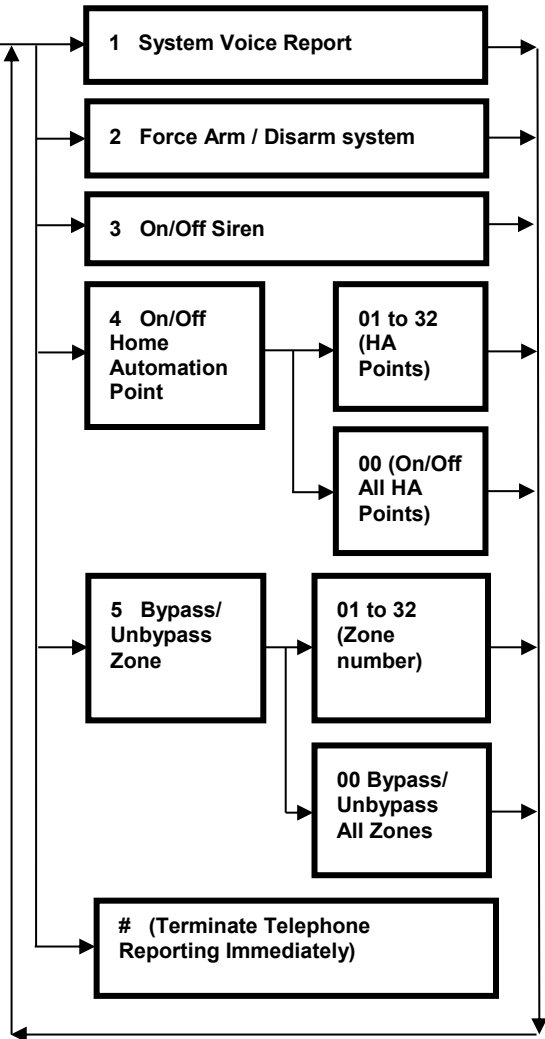
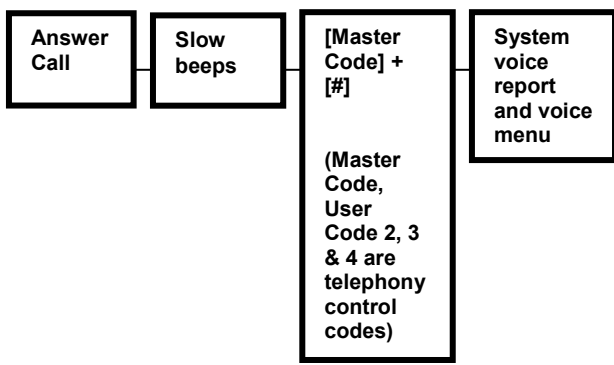

Remark:

1. The system will automatically cut off telephone line if the user does not key in any number for more than 60 seconds or key in wrong master code more than 3 times.
2. Master code, User code 2, User code 3 and user code 4 are Telephony remote access codes.

7.0 UNDERSTAND YOUR KEYPAD INDICATORS

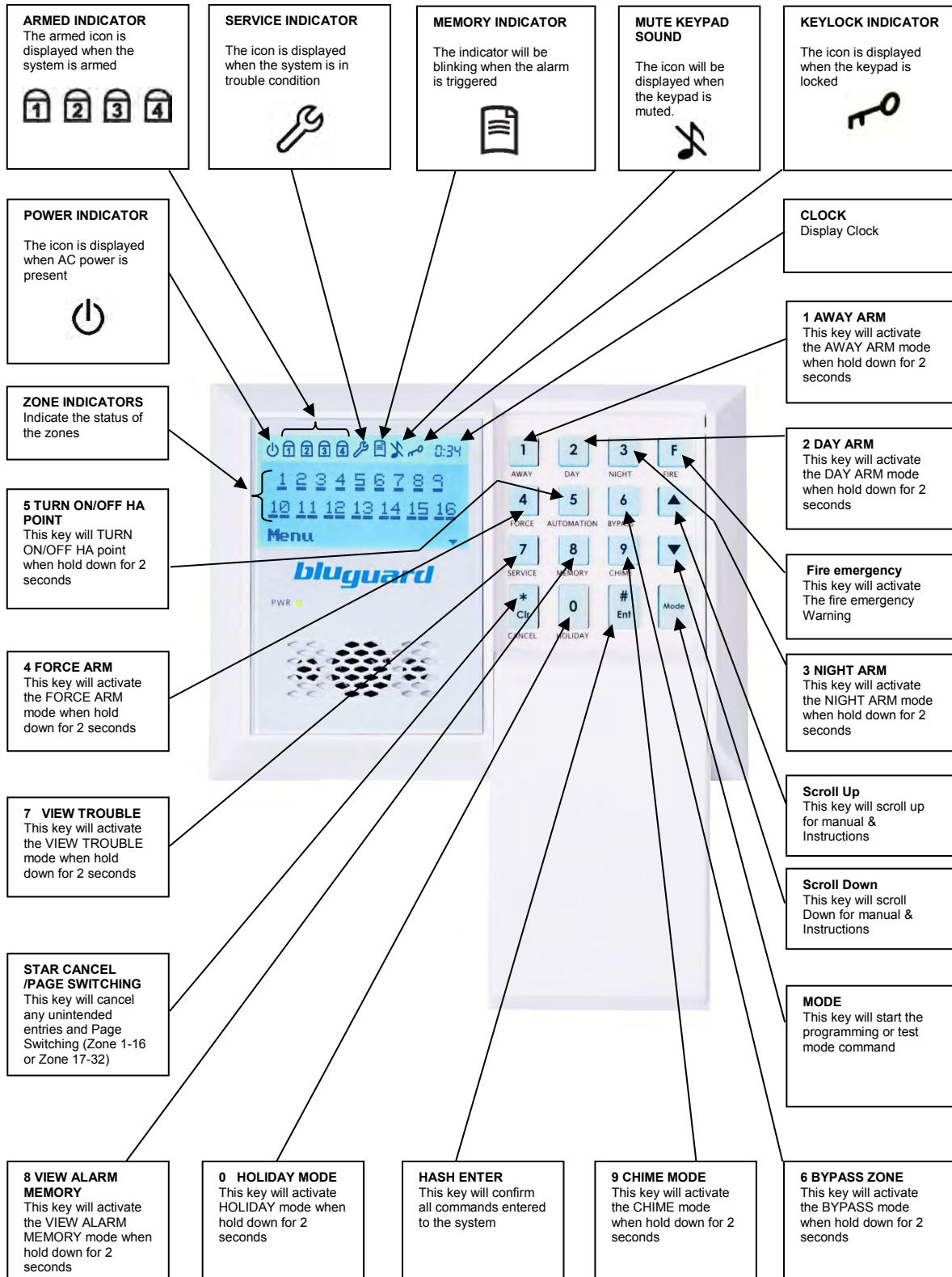

8.0 USER MENU SUMMARY DIAGRAM

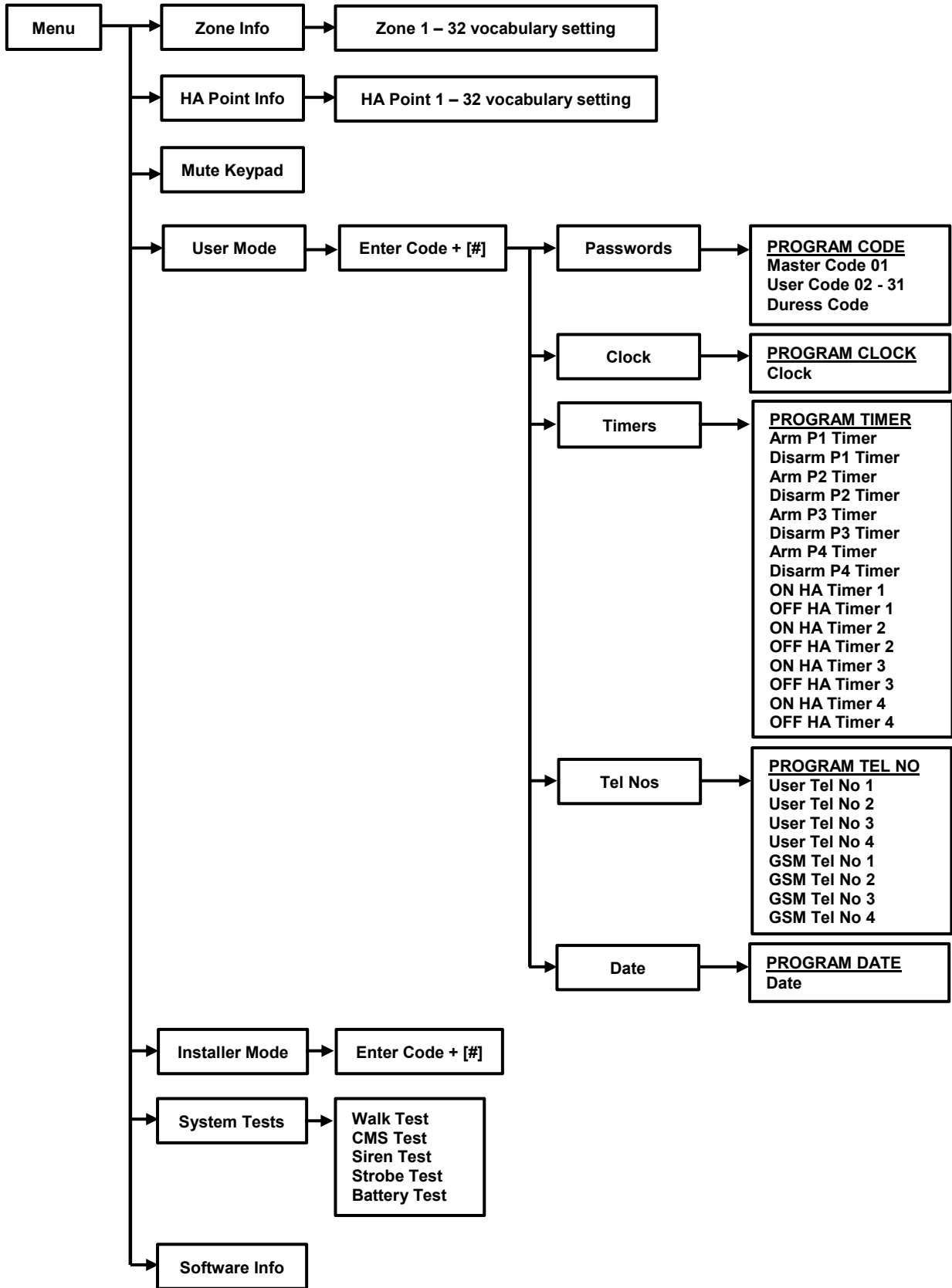

9.0 USER PROGRAMMING SUMMARY TABLE

Access User Programming Mode : [*] + [MODE] + [4-digit Master Code] + [#] OR Access from LCD Menu			
Exit User Programming Mode : [*] / Exit from LCD Menu			
Program New or Change Existing			
Password	Master Code 01	Key in [New User Code] + [#]	[Re-confirm New User Code] + [#]
	User Code 02	Key in [New User Code] + [#]	[Re-confirm New User Code] + [#]
	User Code 03	Key in [New User Code] + [#]	[Re-confirm New User Code] + [#]
	User Code 04	Key in [New User Code] + [#]	[Re-confirm New User Code] + [#]
	User Code 05	Key in [New User Code] + [#]	[Re-confirm New User Code] + [#]
	User Code 06	Key in [New User Code] + [#]	[Re-confirm New User Code] + [#]
	User Code 07	Key in [New User Code] + [#]	[Re-confirm New User Code] + [#]
	User Code 08	Key in [New User Code] + [#]	[Re-confirm New User Code] + [#]
	User Code 09	Key in [New User Code] + [#]	[Re-confirm New User Code] + [#]
	User Code 10	Key in [New User Code] + [#]	[Re-confirm New User Code] + [#]
	User Code 11	Key in [New User Code] + [#]	[Re-confirm New User Code] + [#]
	User Code 12	Key in [New User Code] + [#]	[Re-confirm New User Code] + [#]
	User Code 13	Key in [New User Code] + [#]	[Re-confirm New User Code] + [#]
	User Code 14	Key in [New User Code] + [#]	[Re-confirm New User Code] + [#]
	User Code 15	Key in [New User Code] + [#]	[Re-confirm New User Code] + [#]
	User Code 16	Key in [New User Code] + [#]	[Re-confirm New User Code] + [#]
	User Code 17	Key in [New User Code] + [#]	[Re-confirm New User Code] + [#]
	User Code 18	Key in [New User Code] + [#]	[Re-confirm New User Code] + [#]
	User Code 19	Key in [New User Code] + [#]	[Re-confirm New User Code] + [#]
	User Code 20	Key in [New User Code] + [#]	[Re-confirm New User Code] + [#]
	User Code 21	Key in [New User Code] + [#]	[Re-confirm New User Code] + [#]
	User Code 22	Key in [New User Code] + [#]	[Re-confirm New User Code] + [#]
	User Code 23	Key in [New User Code] + [#]	[Re-confirm New User Code] + [#]
	User Code 24	Key in [New User Code] + [#]	[Re-confirm New User Code] + [#]
	User Code 25	Key in [New User Code] + [#]	[Re-confirm New User Code] + [#]

User Code 26	Key in [New User Code] + [#]	[Re-confirm New User Code] + [#]
User Code 27	Key in [New User Code] + [#]	[Re-confirm New User Code] + [#]
User Code 28	Key in [New User Code] + [#]	[Re-confirm New User Code] + [#]
User Code 29	Key in [New User Code] + [#]	[Re-confirm New User Code] + [#]
User Code 30	Key in [New User Code] + [#]	[Re-confirm New User Code] + [#]
User Code 31	Key in [New User Code] + [#]	[Re-confirm New User Code] + [#]
Duress Code	Key in [New User Code] + [#]	[Re-confirm New User Code] + [#]

Remark:

1. Master code, User Code 2, User Code 3 and User Code 4 are telephone remote access codes. These codes can ARM/DISARM the security system via local keypad or via telephone remote access.

Program System Timer

Clock	Real Time Clock	Key in time [0000 to 2359] + [#]	[F# to erase the previous setting]
--------------	-----------------	----------------------------------	---

Program Security Timers

Timers	Arm P1 Timer	Key in time [0000 to 2359] + [#]	[F# to erase the previous setting]
	Disarm P1 Timer	Key in time [0000 to 2359] + [#]	[F# to erase the previous setting]
	Arm P2 Timer	Key in time [0000 to 2359] + [#]	[F# to erase the previous setting]
	Disarm P2 Timer	Key in time [0000 to 2359] + [#]	[F# to erase the previous setting]
	Arm P3 Timer	Key in time [0000 to 2359] + [#]	[F# to erase the previous setting]
	Disarm P3 Timer	Key in time [0000 to 2359] + [#]	[F# to erase the previous setting]
	Arm P4 Timer	Key in time [0000 to 2359] + [#]	[F# to erase the previous setting]
	Disarm P4 Timer	Key in time [0000 to 2359] + [#]	[F# to erase the previous setting]

Program Home Automation Timers

Timers	ON HA Timer 1	Key in time [0000 to 2359] + [#]	[F# to erase the previous setting]
	OFF HA Timer 1	Key in time [0000 to 2359] + [#]	[F# to erase the previous setting]
	ON HA Timer 2	Key in time [0000 to 2359] + [#]	[F# to erase the previous setting]
	OFF HA Timer 2	Key in time [0000 to 2359] + [#]	[F# to erase the previous setting]
	ON HA Timer 3	Key in time [0000 to 2359] + [#]	[F# to erase the previous setting]
	OFF HA Timer 3	Key in time [0000 to 2359] + [#]	[F# to erase the previous setting]
	ON HA Timer 4	Key in time [0000 to 2359] + [#]	[F# to erase the previous setting]
	OFF HA Timer 4	Key in time [0000 to 2359] + [#]	[F# to erase the previous setting]

Remark: All programmed timer must be in 24-hour format e.g. 7 am = 07 00, 8 pm = 20 00.

Program Reporting Telephone Numbers

Tel No's	User Tel No: 1	Key in [16 digit Tel No.] + [#]	<i>[F to erase the previous setting]</i>
	User Tel No: 2	Key in [16 digit Tel No.] + [#]	<i>[F to erase the previous setting]</i>
	User Tel No: 3	Key in [16 digit Tel No.] + [#]	<i>[F to erase the previous setting]</i>
	User Tel No: 4	Key in [16 digit Tel No.] + [#]	<i>[F to erase the previous setting]</i>
	GSM Tel No: 1	Key in [16 digit Tel No.] + [#]	<i>[F to erase the previous setting]</i>
	GSM Tel No: 2	Key in [16 digit Tel No.] + [#]	<i>[F to erase the previous setting]</i>
	GSM Tel No: 3	Key in [16 digit Tel No.] + [#]	<i>[F to erase the previous setting]</i>
	GSM Tel No: 4	Key in [16 digit Tel No.] + [#]	<i>[F to erase the previous setting]</i>

Remark: Button “▲” on the keypad is representing a “PAUSE” key of 5 seconds duration,
 Button “▼” on the keypad is representing a “*” key of telephone system.

Program System Date

Date	Current Date	[DD/MM/YY] + [#]	<i>[F # to erase the previous setting]</i>
-------------	--------------	------------------	--

10.0 ARMING THE SYSTEM

There are various options for arming the system

- a. **Partition Arming**
- b. **Away Arming**
- c. **Day Arming**
- d. **Night Arming**
- e. **Force Arming**
- f. **Holiday Arming**
- g. **Remote Control Arming**
- h. **Timer Auto Arming**
- i. **Telephone Remote Arming**

For information on how to ARM Partition system, please refer to **Partitioning The System** at page 25 (Section 21.0).

10.1 AWAY ARMING

[*] + [USER CODE] + [#]

(Leave via ENTRY/EXIT Zone)

1. Ensure that all zone indicators are extinguished; if not, check that all protected premises are closed.
2. Press **[*]** key to cancel any unintended entries.
3. Enter a valid 4-digit **[USER CODE]**. If you enter any mistakes, press **[*]** key and re-enter the code followed by **[#]** key to confirm you command.
4.  will be displayed.

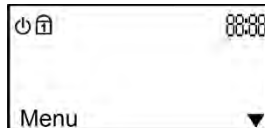

5. An **EXIT** delay countdown timer will be shown at the top right temporarily replace the clock and the keypad audible indicator will sound on and off for the duration of the **EXIT** delay.
6. Any bypassed zones will be shown by the flashing zone underline.
7. Leave the premises only via the **EXIT/ENTRY** zone.
8. User will be given an **ENTRY** delay time to disarm the system when enter the protected premises via **ENTRY/EXIT** zone.
9. It is also possible to AWAY arm by simply press and hold down key **[1]** for 2 seconds.

[1]

(Press and hold down for 2 seconds)

10.2 DAY ARMING

[2]

(Press and hold down for 2 seconds)

1. This arming mode is ideal for **DAY** time arming with user still remains in the protected premises.
2. In this mode, the system will be armed instantly with certain preprogrammed, **DAY STAY** zones bypassed automatically.
3. Ensure that all zone indicators are extinguished; if not, check that all protected premises are closed.
4. DO NOT open the **ENTRY/EXIT** zone.
5. Press and hold down key **[2]** for 2 seconds.
6.  icon will be displayed



7. The keypad audible indicator will sound 2 beeps to confirm the arming.
8. Any **DAY STAY** zones will be automatically bypassed which shown by flashing zone underline.
9. User will be given an **ENTRY** delay time to DISARM the system when enter the protected premises via **ENTRY/EXIT** zone.

10.3 NIGHT ARMING

[3]

(Press and hold down for 2 seconds)

1. This arming mode is ideal for **NIGHT** time arming with user still remains in the protected premises.
2. In this mode, the system will be armed instantly with certain preprogrammed, **NIGHT STAY** zones bypassed automatically.
3. Ensure that all zone indicators are extinguished; if not, check that all protected premises are closed.
4. DO NOT open the **ENTRY/EXIT** zone.
5. Press and hold down key **[3]** for 2 seconds.
6.  icon will be displayed

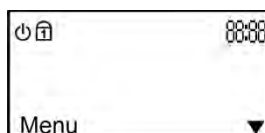

7. The keypad audible indicator will sound 2 beeps to confirm the arming.

8. Any **NIGHT STAY** zones will be automatically bypassed which shown by flashing zone underline.
9. There is no **ENTRY** delay in this arming mode. Any violation on the active zones will trigger the system instantly.

10.4 FORCE ARMING

[4]

(Press and hold down for 2 seconds)

1. In this mode, the system will be armed with **EXIT** delay time which allows certain violated zones to be bypassed temporary. When the violated zones resume, the zone will be protected again.
2. Press and hold down key **[4]** for 2 seconds.
3.  icon will be displayed

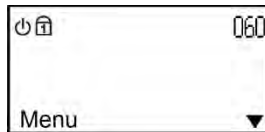

4. An **EXIT** delay countdown timer will be shown at the top right temporarily replace the clock and the keypad audible indicator will sound on and off for the duration of the **EXIT** delay.
5. Any bypassed zones will be shown by the flashing zone underline.
6. User will be given an **ENTRY** delay time to **DISARM** the system when enter the protected premises via **ENTRY/EXIT** zone.

10.5 HOLIDAY ARMING

[0]

(Press and hold down for 2 seconds)

1. This arming mode is ideal for long away occasion (holiday).
2. In this mode, the system will be **AWAY** armed. Home Automation points will be random ON/OFF every hour to simulate occupancy from 7pm to 1am.
3. Ensure that all zone indicators are extinguished; if not, check that all protected premises are closed.
4. Press and hold down key **[0]** for 2 seconds.
5.  icon will be displayed.

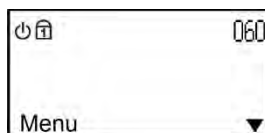

6. An **EXIT** delay countdown timer will be shown at the top right temporarily replace the clock and the keypad audible indicator will sound on and off for the duration of the **EXIT** delay.
7. Any bypassed zones will be shown by the flashing zone underline.
8. Leave the premises only via the **EXIT/ENTRY** zone.
9. User will be given an **ENTRY** delay time to disarm the system when enter the protected premises via **ENTRY/EXIT** zone.
10. After disarming, Home Automation random ON/OFF function will be deactivated and the system will resume to normal Home Automation ON/OFF timers setting.

10.6 REMOTE CONTROL ARMING (OPTIONAL)

1. This arming mode is ideal for remote control unit or key-switch arming.
2. The system will arm in **FORCE** arming mode.
3. The system will be armed with **EXIT** delay time which allows certain violated zones to be bypassed temporary. When the violated zones resume, the zone will be protected again.
4. Press the remote control button or twist and release the key-switch.
5. The system will be armed instantly. Leave the premises via **ENTRY/EXIT** zone.
6.  icon will be displayed.



7. An **EXIT** delay countdown timer will be shown at the top right temporarily replace the clock and the keypad audible indicator will sound 2 beeps to confirm the arming.
8. If programmed to do so, the siren will sound briefly for this remote control arming (please refer to Installer Programming Section – System Option Setting).
9. User will be given an **ENTRY** delay time to DISARM the system when enter the protected premises via **ENTRY/EXIT** zone.

10.7 AUTO TIMER ARMING

1. Your system can be programmed to automatically **ARM** itself according to a programmed schedule.
2. This arming mode will automatically turn to **FORCE ARM** mode when the system timer reaches the preset **AUTO ARM** time.
3. Please refer to **Program Auto Arm Partition 1/2/3/4 Timer** at page 35 (Section 25.7).

10.8 TELEPHONE REMOTE ARMING

1. Your system can be remotely ARM from outside the house through any normal DTMF telephone or GSM hand phone.
2. This arming mode will automatically turn to **FORCE ARM** mode when the user enter a correct Master Code through Telephone or hand phone.
3. Please refer to **Telephony Control Diagram** at page 7 (Section 6.0).

11.0 DISARMING THE SYSTEM



There are various options for disarming the system:

- a. **Partition Disarming**
- b. **Keypad Disarming**
- c. **Remote Control Disarming**
- d. **Timer Auto Disarming**
- e. **Telephone Remote Disarm**

For information on how to DISARM Partition system, please refer to **Partition Disarming** at page 30 (Section 23.0).

11.1 KEYPAD DISARMING

[USER CODE] + [#]

1. To disarm the system, enter a valid 4-digit **[USER CODE]** followed by **[#]** key before expiry of the entry delay time.
2. Enter the premises through a designated **ENTRY/EXIT** zone; entering via other zones will trigger an alarm instantly.
3. The **ENTRY** delay begins once the **ENTRY** zone is violated.
4. The keypad audible indicator will sound for the duration of the **ENTRY** delay to indicate that a valid user code is required.
5. If the  icon remains displayed, an error has been made while entering the user code. Press **[*]** key and re-enter the user code.
6. An **ENTRY** delay countdown timer will be shown at the top right temporarily replace the clock.
7. Once the system is disarmed, the  icon will extinguish and the keypad audible indicator will stop.

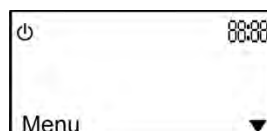

- If the  icon is flashing upon entry there has been an intrusion. Call for assistance. The intruder may still be inside.

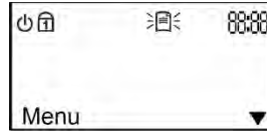

- If no valid user code has been entered by the end of the **ENTRY** delay period, an **ALARM** condition will be registered and stored into the system **MEMORY**.
- If programmed to do so, the keypad will be locked and non-responsive for a preprogrammed period for certain number of incorrect user codes, which are entered consecutively more than the keypad lock counter.
- If the **ENTRY** delay is too short, have your installer to change the **ENTRY** delay period.

11.2 REMOTE CONTROL DISARMING (OPTIONAL)

- To instantly disarm the system, press the remote control button or twist and release the key-switch.
- The  icon will extinguish and the keypad audible indicator will sound 2 beeps to confirm the disarming.

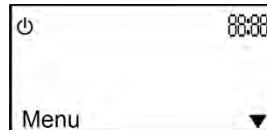

- If programmed to do so, the siren will sound briefly for this remote control disarming (Please refer to Installer Programming Section – System Option Setting).

11.3 AUTO TIMER DISARMING

- Your system can be programmed to automatically **DISARM** itself according to a programmed schedule.
- Please refer to **Program Auto Disarm Partition 1/2/3/4 Timer** at page 36 (Section 25.9).

11.4 TELEPHONE REMOTE DISARMING

- Your system can be remotely DISARM from outside the house through any normal **DTMF** telephone or **GSM** hand phone.
- This disarming mode will automatically turn off the security system when the user enters a correct Master Code through Telephone or hand phone.
- Please refer to **Telephony Control Diagram** at page 7 (Section 6.0).

12.0 TURN ON/OFF HOME AUTOMATION POINT

[5] + **[HA POINT NUMBERS] + [#]**
 (Press and hold down for 2 seconds) (01 to 32)

1. Press and hold down key **[5]** for 2 seconds.
2. The screen will show “**HA Info**” and keypad audible indicator will sound 2 beeps.

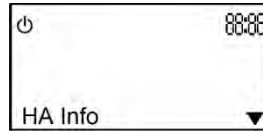

Zone 1 to 32 will be displayed if the respective HA points are ON.

Zone 1 to 32 will not be displayed if the respective HA points are OFF.

3. Enter the **HA point numbers** followed by **[#]** key. Keypad audible indicator will sound 2 beeps to confirm the command and the system will be back to normal mode.
4. To turn On/Off all Home Automation (**HA**) points at once, press key **[00]** followed by **[#]**.
5. Keypad audible indicator will sound 2 beeps to confirm the command and the system will be back to normal mode.

To turn ON/OFF HA point 3 and 4:

Press and hold down **[5]** for 2 seconds + **[03] + [04] + [#]**.

Keypad audible indicator will sound 2 beeps to confirm the command. HA point 3 and 4 will turn ON/OFF.

13.0 BYPASS ZONE

[6] + **[ZONE NUMBERS] + [#]**
 (Press and hold down for 2 seconds) (01 to 32)

1. Press and hold down key **[6]** for 2 seconds.
2. The screen will show “**Bypass Info**” and keypad audible indicator will sound 2 beeps.

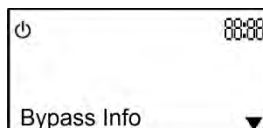

3. Press the zone number that needs to be bypassed, e.g. press **[02] + [12] + [16]** if you wish to bypass zone 2, 6 and 16.

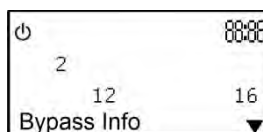

4. Press **[#]** key to exit the bypass mode and keypad audible indicator will sound 2 beeps to confirm the command.
5. To bypass all zones at once, press key **[00]** followed by **[#]**.
6. The relevant **ZONE** underline will slow flash to indicate that the zone is bypassed now.

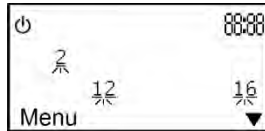

7. Zones cannot be bypassed once the system is armed.
8. All bypassed zones will be automatically un-bypassed each time the system is disarmed and must be reapplied before the next arming.

14.0 UN-BYPASS ZONE

[6] + **[ZONE NUMBERS] + [#]**
 (Press and hold down for 2 seconds) (01 to 32)

1. Press and hold down key **[6]** for 2 seconds.
2. The screen will show the Bypass Zones and keypad audible indicator will sound 2 beeps.

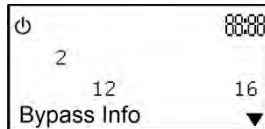

3. Press the zone number corresponding to the current bypassed zone e.g. press **[02]** + **[12]** + **[16]** if you wish to un-bypass zone 2, 6 and 16.

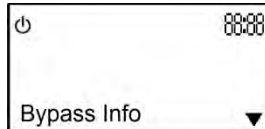

4. Press **[#]** key to exit the bypass mode and keypad audible indicator will sound 2 beeps to confirm the command.
5. To un-bypass all zones at once, press key **[00]** followed by **[#]**.
6. Keypad audible indicator will sound 2 beeps to confirm the command and the system will be back to normal mode.
7. The relevant **ZONE** indicator will extinguish to indicate that the zone is now active.

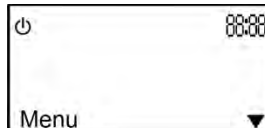

15.0 VIEW SYSTEM TROUBLE

[7]
 (Press and hold down for 2 seconds)

1. The system will monitor a number of possible trouble conditions. If one of these conditions occurs, the  icon will display until the trouble is restored.

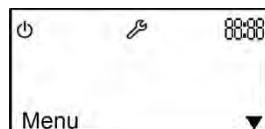

2. Press and hold down key **[7]** for 2 seconds.

- The screen will show Trouble Messages and keypad audible indicator will sound 2 beeps.

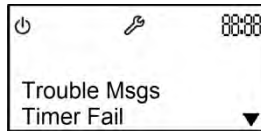

- The trouble occurred will be displayed. Press the [▼] key to check on all the troubles that need to be serviced.
- Press [#] key to exit and keypad audible indicator will sound 2 beeps.
- Possible trouble conditions:
 - ✓ AC Loss
 - ✓ Real Time Clock Loss (Please refer to **Program System Timer** at page 35 (Section 25.6))
 - ✓ Siren Fail
 - ✓ Battery Low Voltage
 - ✓ Telephone Line/GSM CMS Reporting Fail
 - ✓ Telephone Line/GSM Personal Reporting Fail
 - ✓ Telephone Line Connection Fail

Remark: CMS Reporting Fail and Personal Reporting Fail troubles will be extinguished when they are viewed once.

16.0 EVENT VIEWER

[8]

(Press and hold down for 2 seconds)

- The event viewer will store up to 20 latest events in the system. An alarm condition will cause the icon flash.

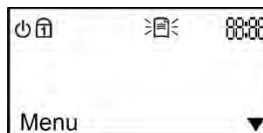

- The icon will extinguish once the user enters **EVENT VIEWER** mode.
- To view, press and hold down key [8] for 2 seconds.
- The viewer will displayed:
 - ✓ Date & Time
 - ✓ Event Occurred

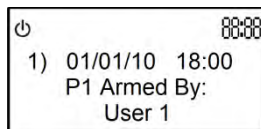

- Press [▼] to view the 2nd latest event and continue to press [▼] for next event.
- Press [#] to exit event viewer and keypad audible indicator will sound 2 beeps.

17.0 CHIME MODE

The chime mode allows user to monitor nominated zones while the system is disarmed. The audible indicator will sound briefly when the nominated zone is violated – the siren will NOT sound. If you wish to know there is someone enters or exits the front door, the keypad will beep once when the door is opened provided the zone is a chime zone.

[9] + [ZONE NUMBERS] + [#]

(Press and hold down for 2 seconds)

(01 to 32)

1. Press and hold down key **[9]** for 2 seconds.
2. The screen will show “**Chime Info**” and keypad audible indicator will sound 2 beeps.

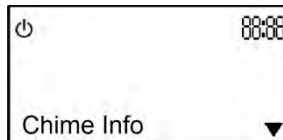

3. Press the key corresponding to the zone that you wish to be the chime zone.
4. Press **[#]** key to exit the chime mode and keypad audible indicator will sound 2 beeps to confirm the command.

To program zone 3 and zone 4 as CHIME zones:

Press and hold down **[9]** for 2 seconds + **[03]** + **[04]** + **[#]**.

Keypad audible indicator will sound 2 beeps to confirm the command. Zone 3 and 4 are now CHIME zones.

TO CANCEL CHIME ZONE:

Repeat the above steps and ensure that the zone number display is extinguished.

18.0 VIEW ZONE VOCABULARY SETTING

1. Press **[▼]** key to the **Zone Info** menu when system in normal mode.

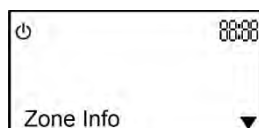

2. Press **[#]** to access into zone info setting. Vocabulary settings are shown in the LCD.

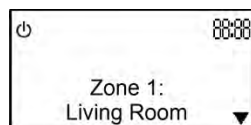

3. Continue press **[▼]** or **[▲]** to scroll up/down for other zone vocabulary.
4. Consult your system installer if you wish to change the vocabulary setting.
5. Press **[#]** to exit.

19.0 VIEW HA POINT VOCABULARY SETTING

1. Press [**▼**] key to the **HA Point Info** menu when system in normal mode.

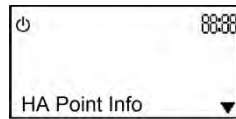

2. Press [**#**] to access into zone info setting. Vocabulary settings are shown in the LCD.

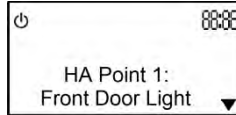

3. Continue press [**▼**] or [**▲**] to scroll up/down for other zone vocabulary.
4. Consult your system installer if you wish to change the vocabulary setting.
5. Press [**#**] to exit.

20.0 EMERGENCY SITUATION

FIRE MODE

[**F**]

(Press and hold down for 2 seconds)

1. This key will activate the FIRE ALARM condition when it is held down for 2 seconds.

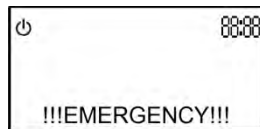

2. The FIRE ALARM condition can also be triggered by an installed smoke detector, which is set as fire zone.
3. The siren will sound and the FIRE REPORTING CODE will be transmitted to the central monitoring station.
4. To silence the siren, enter a 4-digit user code followed by [**#**] key.

PANIC MODE

[**MODE**] + [**8**] + [**#**]

1. The PANIC ALARM condition will be activated when press [**MODE**] + [**8**] + [**#**].



2. The PANIC ALARM condition can also be activated by any FIXED or REMOTE PANIC button that has been installed.
3. If the panic button is set as silent zone, then the PANIC REPORTING CODE will be transmitted to the central monitoring station without the siren sounding. Ensure that your installer has enabled this function if it is required.
4. To silence the siren, enter a valid 4-digit user code followed by [**#**] key. If the siren is not cancelled, it will stop automatically after the SIREN TIME OUT period.

5. Press this mode only in an emergency situation that requires response by emergency personnel.

MEDICAL MODE

[MODE] + [9] + [#]

1. The MEDICAL ALARM condition will be activated when press **[MODE] + [9] + [#]**.



2. The keypad audible indicator will sound to indicate that a MEDICAL ALARM has been initiated.
3. The siren will sound and the MEDICAL REPORTING CODE will be transmitted to the central monitoring station.
4. To silence the siren, enter a 4-digit user code followed by [#] key.

DURESS CODE

1. This is a special 4-digit user code that is only used in the unique situation where an intruder forces one to disarm the system “under duress”.
2. When the duress code is entered, the control panel will be disarmed. However, a DURESS REPORTING CODE is transmitted to the central monitoring station to inform them that you have been forced to disarm the control panel by an intruder.
3. It is advisable to choose a code that can be easily remembered by all family (or staff) members.

21.0 PARTITIONING THE SYSTEM

Depending on your needs, your installer can program your control panel to recognize and control 4 separate areas (Partition 1 to 4) by activating the system's partitioning feature. User codes can also be programmed to ARM/DISARM one partition or more partitions simultaneously.

You can use partitioning in installations where shared systems are more practical, such as office/warehouse buildings, or apartment/condominium complexes.

22.0 ARMING A PARTITIONED SYSTEM

Zones can be divided into four systems. Based on your requirements, the installer designates which zones belong to Partition 1, Partition 2, Partition 3, Partition 4, or more than one partition (common area), or are not given any partition assignment. A zone belonging to a 4 partitions is armed only when all 4 partitions are armed. However, this sharing zone will be disarmed if any partition is disarmed.

The installer must program the required user code settings. These settings determine which user codes can arm/disarm Partition 1, as well as which user code can arm/disarm Partition 2, Partition 3 or Partition 4. User code can also be given access to more than one partition or all partitions.





22.1 AWAY ARMING 4 PARTITIONS SIMULTANEOUSLY

If your user code has access to 4 partitions:

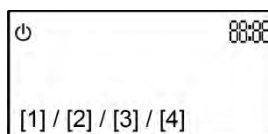
[*] + [USER CODE] + [#] + [1] + [2] + [3] + [4]
(Leave via ENTRY/EXIT Zone)

1. Ensure that all zone indicators are extinguished; if not, check that all protected premises are closed.
2. Press the **[*]** key to cancel any unintended entries.
3. Enter a valid 4-digit **[USER CODE]**. If you enter mistakes, press **[*]** key and re-enter the code followed by **[#]** key to confirm your command.
4. If the key in user code is assigned to control 4 partitions, P1 to P4 options will be displayed.



5. Press key **[1]** followed by key **[2]**, **[3]** and **[4]**. Then     icons will be displayed.

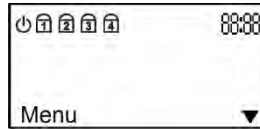

6. An **EXIT** delay countdown timer will be shown at the top right temporarily replace the clock and the keypad audible indicator will sound on and off for the duration of the **EXIT** delay.
7. Any bypassed zones will be shown by the flashing zone underline.
8. Leave the premises only via the **EXIT/ENTRY** zone.
9. User will be given an **ENTRY** delay time to disarm the system when enter the protected premises via **ENTRY/EXIT** zone.
10. It is also possible to AWAY arm by simply press and hold down key **[1]** for 2 seconds.

[1] + [1] + [2] + [3] + [4]

(Press and hold down for 2 seconds)

11. P1 to P4 options will be displayed.

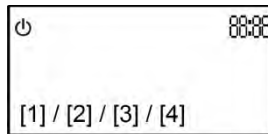

12. Press key **[1]** followed by key **[2]**, **[3]** and **[4]** to arm all partitions.

22.2 AWAY ARMING EITHER 1 PARTITION

If your user code has access to 4 partitions and you would like to arm Partition 1 only

[*] + [USER CODE] + [#] + [1] + [#]
(Leave via ENTRY/EXIT Zone)

If your user code has access to 4 partitions and you would like to arm Partition 2 only

[*] + [USER CODE] + [#] + [2] + [#]
(Leave via ENTRY/EXIT Zone)

If your user code has access to 4 partitions and you would like to arm Partition 3 only

[*] + [USER CODE] + [#] + [3] + [#]
(Leave via ENTRY/EXIT Zone)

If your user code has access to 4 partitions and you would like to arm Partition 4 only

[*] + [USER CODE] + [#] + [4] + [#]
(Leave via ENTRY/EXIT Zone)

1. Ensure that all zone indicators are extinguished; if not, check that all protected premises are closed.
2. Press **[*]** key to cancel any unintended entries.
3. Enter a valid 4-digit **[USER CODE]**. If you enter mistakes, press **[*]** key and re-enter the code followed by **[#]** key to confirm your command.
4. P1 to P4 options will be displayed.

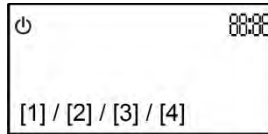

5. Enter the partition number that you wish to arm followed by [#] key.

6. The icon will be displayed if Partition 1 is armed.

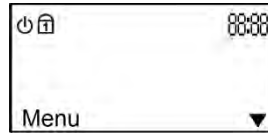

7. The icon will be displayed if Partition 2 is armed.

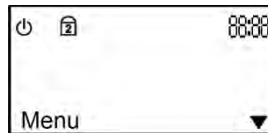

8. The icon will be displayed if Partition 3 is armed.

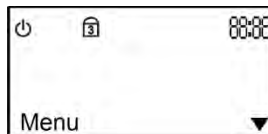

9. The icon will be displayed if Partition 4 is armed.

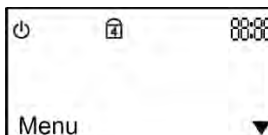

10. An **EXIT** delay countdown timer will be shown at the top right temporarily replace the clock and the keypad audible indicator will sound on and off for the duration of the **EXIT** delay.

11. Any bypassed zones will be shown by the flashing zone underline.

12. Leave the premises only via the **EXIT/ENTRY** zone.

13. User will be given an **ENTRY** delay time to disarm the system when enter the protected premises via **ENTRY/EXIT** zone.

22.3 FASTKEY AWAY ARMING EITHER 1 PARTITION

[1] + [1 or 2 or 3 or 4] + [#]
(Press and hold down for 2 seconds)

1. Ensure that all zone indicators are extinguished; if not, check that all protected premises are closed.
2. Press and hold down key [1] for 2 seconds.
3. P1 to P4 options will be displayed.

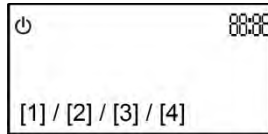

4. Select the partition number that you wish to arm followed by [#] key.
5. The partition number armed icon will be displayed if it is armed.
6. An **EXIT** delay countdown timer will be shown at the top right temporarily replace the clock and the keypad audible indicator will sound on and off for the duration of the **EXIT** delay.
7. Any bypassed zones will be shown by the flashing zone underline.
8. Leave the premises only via the **EXIT/ENTRY** zone.
9. User will be given an **ENTRY** delay time to disarm the system when enter the protected premises via **ENTRY/EXIT** zone.

22.4 PARTITION DAY ARMING

[2] + [1 or 2 or 3 or 4] + [#]
 (Press and hold down for 2 seconds)

1. This arming mode is ideal for **DAY** time arming with user still remains in the protected premises.
2. In this mode, system will be armed instantly with certain preprogrammed, **DAY STAY** zones bypassed automatically.
3. Ensure that all zone indicators are extinguished; if not, check that all protected premises are closed.
4. DO NOT open the **ENTRY/EXIT** zone.
5. Press and hold down key **[2]** for 2 seconds.
6. P1 to P4 options will be displayed.

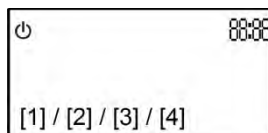

7. Select the partition number that you wish to arm followed by [#] key.
8. The partition number armed icon will be displayed if it is armed.
9. Any **DAY STAY** zones will be automatically bypassed (shown by flashing zone underline).
10. User will be given an **ENTRY** delay time to disarm the system when enter the protected premises via **ENTRY/EXIT** zone.

22.5 PARTITION NIGHT ARMING

[3] + [1 or 2 or 3 or 4] + [#]
 (Press and hold down for 2 seconds)

1. This arming mode is ideal for **NIGHT** time arming with user still remains in the protected premises.
2. In this mode, system will be armed instantly with certain preprogrammed, **NIGHT STAY** zones bypassed automatically.
3. Ensure that all zone indicators are extinguished; if not, check that all protected premises are closed.
4. DO NOT open the **ENTRY/EXIT** zone.
5. Press and hold down key **[3]** for 2 seconds.
6. P1 to P4 options will be displayed.

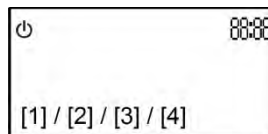

7. Select the partition number that you wish to arm followed by **[#]** key.
8. The partition number armed icon will be displayed if it is armed.
9. Any **NIGHT STAY** zones will be automatically bypassed (shown by flashing zone underline).
10. There is no **ENTRY** delay in this arming mode. Any violation on the active zones will trigger the system instantly.

22.6 PARTITION FORCE ARMING

[4] + [1 or 2 or 3 or 4] + [#]
 (Press and hold down for 2 seconds)

1. In this mode, the system will be armed with EXIT delay time which allows certain violated zones to be bypassed temporary. When the violated zones resume, the zone will be protected again.
2. Press and hold down key **[4]** for 2 seconds.
3. P1 to P4 options will be displayed.

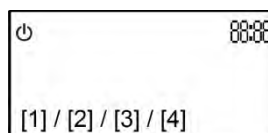

4. Select the partition number that you wish to arm followed by **[#]** key.
5. The partition number armed icon will be displayed if it is armed.
6. An **EXIT** delay countdown timer will be shown at the top right temporarily replace the clock and the keypad audible indicator will sound on and off for the duration of the **EXIT** delay.
7. Any bypassed zones will be shown by the flashing zone underline.

- User will be given an **ENTRY** delay time to disarm the system when enter the protected premises via **ENTRY/EXIT** zone.

22.7 PARTITION HOLIDAY ARMING

[0] + [1 or 2 or 3 or 4] + [#]
(Press and hold down for 2 seconds)

- This arming mode is ideal for long away occasion (holiday).
- In this mode, the system will be **AWAY** armed. Home Automation points will be random ON/OFF every hour to simulate occupancy from 7pm to 1am.
- Ensure that all zone indicators are extinguished; if not, check that all protected premises are closed.
- Press and hold down key **[0]** for 2 seconds.
- P1 to P4 options will be displayed.

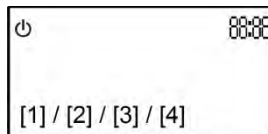

- Select the partition number that you wish to arm followed by **[#]** key.
- The partition number armed icon will be displayed if it is armed.
- An **EXIT** delay countdown timer will be shown at the top right temporarily replace the clock and the keypad audible indicator will sound on and off for the duration of the **EXIT** delay.
- Any bypassed zones will be shown by the flashing zone underline.
- Leave the premises only via the **EXIT/ENTRY** zone.
- User will be given an **ENTRY** delay time to disarm the system when enter the protected premises via **ENTRY/EXIT** zone.
- After disarming, Home Automation random ON/OFF function will be deactivated.

23.0 PARTITION DISARMING

[USER CODE] + [#]

- Enter the premises through a designated **ENTRY/EXIT** zone; entering via other zones will trigger an alarm instantly.
- The **ENTRY** delay begins once the **ENTRY** zone is violated.
- The keypad audible indicator will sound for the duration of the **ENTRY** delay to indicate that a valid user code is required.
- An **ENTRY** delay countdown timer will be shown at the top right temporarily replace the clock.
- To disarm the system, enter a valid 4-digit **[USER CODE]** followed by **[#]** key before expiry of the entry delay time.
- P1 to P4 options will be displayed.

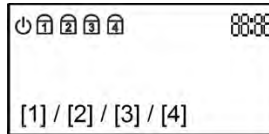

7. Select the partition number that you wish to disarm followed by **[#]** key.
8. The partition number armed icon will extinguish if it is disarmed.
9. If the partition number armed icon remain illuminated, an error has been made while entering the user code, press **[*]** key and re-enter the user code.
10. Once the system is disarmed, the keypad audible indicator will stop.
11. If no valid user code has been entered by the end of the **ENTRY** delay period, an **ALARM** condition will be registered and stored into the system **MEMORY**.
12. If programmed to do so, the keypad will be locked and non-responsive for a preprogrammed period for certain number of incorrect user codes, which are entered consecutively more than the keypad lock counter (Please refer to Installer Programming Section – Keypad Lock Counter Setting).
13. If the **ENTRY** delay is too short, have your installer to change the **ENTRY** delay period.
14. If the **MEMORY** indicator is flashing upon entry, there has been an intrusion. Call for assistance. The intruder may still be inside.

24.0 USER CODE

Master code is a 4-digit personal identification number that allows you to enter certain programming mode, arm or disarm the system and remotely control the system via telephone line. In addition to Master Code, the system can be programmed to accept 30 user codes that allow you to arm/disarm the system. The default Master Code is “1234”.

Duress Code is an ambush code which will disarm the system and simultaneously send a silent alarm signal to the center monitoring station. It is very useful code when you are forced to disarm your security system under threat.

25.0 USER PROGRAMMING MODE

25.1 ACCESS USER PROGRAMMING MODE

[*] + [MODE] + [USER MASTER CODE] + [#]

1. Ensure that the system is not ARMED.
2. Press the [*] key to cancel any unintended entries.
3. Press [MODE] key to go into **USER PROGRAMMING** mode.
4. Enter a valid 4-digit [USER MASTER CODE]. If you enter any mistakes, press [*] key and repeat step 3.
5. If a wrong USER MASTER CODE is entered, a long beep will be sound. Repeat step 3-4 to access USER PROGRAMMING MODE.
6. Screen will show “**User Mode**” and keypad audible indicator will sound 2 beeps if a valid USER MASTER CODE is entered. Below the “**User Mode**”, the “**Passwords**” command is ready to be entered.
7. Use the [▲] key and [▼] key to scroll up and down. Enter the command that you wish to change. Please refer to **User Programming Summary Table** at page 10 (Section 9.0).
8. To exit user programming mode press [*] or exit from MENU.

25.2 EXIT USER PROGRAMMING MODE

1. Press [*].
2. Screen will show “Menu” at the bottom (exactly like before entering the user programming mode) and keypad will sound 2 beeps to confirm the exit command.



25.3 PROGRAM NEW AND CHANGING EXISTING MASTER / USER CODE

1. Ensure that the system is in USER PROGRAMMING mode.

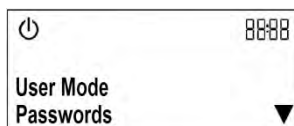

2. Press [#] to access **Passwords** menu.

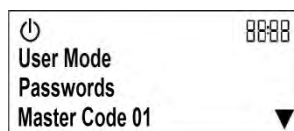

3. Press [#] to select **Master code 01**.

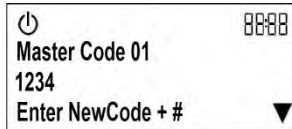

4. Enter the new 4-digit **[MASTER CODE]**. Example: 4567 followed by **[#]** key.

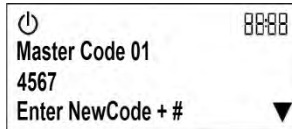

5. Re-enter the new 4-digit **[MASTER CODE]** followed by **[#]** key.

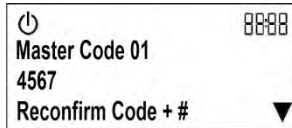

6. Use the **[▲]** key and **[▼]** key to scroll up and down to select other user code and repeat step 3.
7. Press **[*]** to exit user programming mode.
8. If any of the user codes are not used, please ensure that they are all erased.

25.4 PROGRAM NEW AND CHANGING EXISTING DURESS CODE

1. Ensure that the system is in USER PROGRAMMING mode.



2. Press **[#]** to access **Passwords** menu.

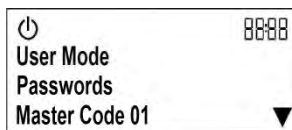

3. Press **[▼]** to scroll down to **Duress Code**.

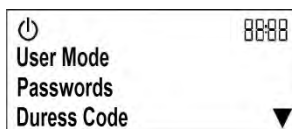

4. Press **[#]** to select **Duress Code**.

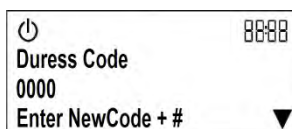

5. Enter the new 4-digit **[DURESS CODE]** followed by **[#]** key. Example, 1313 and press **[#]**.

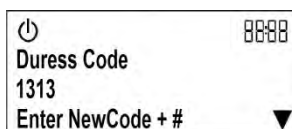

6. Re-enter the new 4-digit **[DURESS CODE]** followed by **[#]** key.

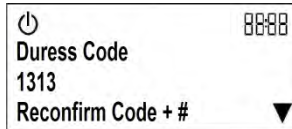

7. Press **[*]** to exit user programming mode.
8. If the duress code is not used, please ensure the code is erased.

25.5 ERASE USER or DURESS CODE

1. Ensure that the system is in USER PROGRAMMING mode.

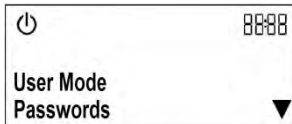

2. Press **[#]** to access **Passwords** menu.

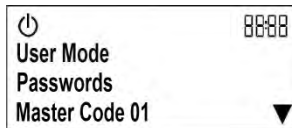

3. Press **[▼]** to scroll down to select which user code that you wish to erase. Example, **User Code 02**.

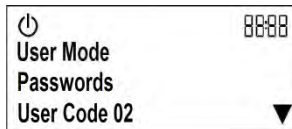

4. Press **[#]** to select **User Code 02**.

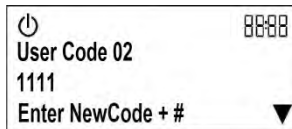

5. Enter 4-digit **[0000]** followed by **[#]** key.

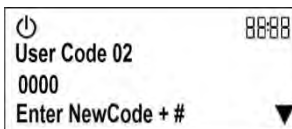

6. Re-enter the 4-digit **[0000]** followed by **[#]** key.

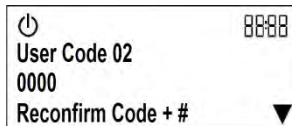

7. Repeat step 3 to 6 to erase other user codes.
8. Press **[*]** to exit user programming mode.
9. If any of the user/duress codes are not used, please ensure that they are all erased.
(Master code cannot be erased).

25.6 PROGRAM SYSTEM TIMER

1. Ensure that the system is in USER PROGRAMMING mode.

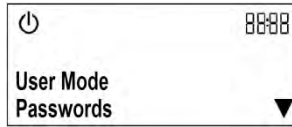

2. Press [▼] to scroll down to **Clock**.

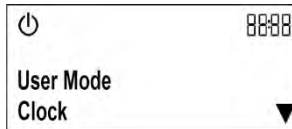

3. Press [#] to select clock for system timer setting.

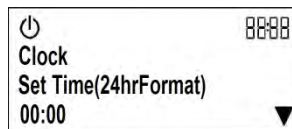

4. Enter the [**CURRENT TIME**] in 24-hour format. Example, 8:00pm is 20:00.

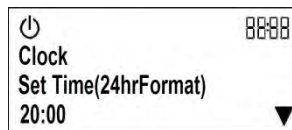

5. Press [#] key to confirm the time.
6. Press [*] to exit user programming mode.

25.7 PROGRAM AUTO ARM PARTITION 1/2/3/4 TIMER

1. Ensure that the system is in USER PROGRAMMING mode.

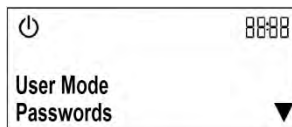

2. Press [▼] to scroll down to **Timers**.

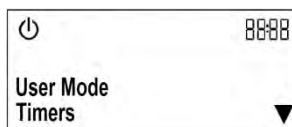

3. Press [#] to access **Timers** menu.

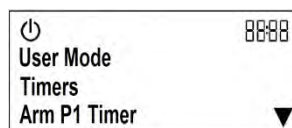

4. Press [#] to access **Arm P1 Timer** for auto arm partition 1 timer.

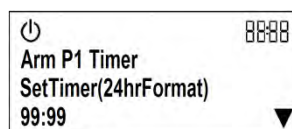

5. Enter the [**AUTO ARM P1 TIMER**] in 24-hour format. Example, 8:00pm is 20:00.

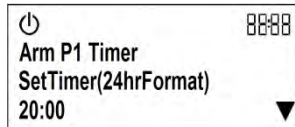

6. Press [#] key to confirm the time.
7. Press [▼] to scroll down to program **Arm P2 Timer**, **Arm P3 Timer** and **Arm P4 Timer**.
8. Press [*] to exit user programming mode.

25.8 TO ERASE AUTO ARM PARTITION 1/2/3/4 TIMER

1. Ensure that the system is in USER PROGRAMMING mode.

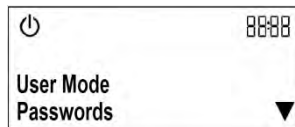

2. Press [▼] to scroll down to **Timers**.

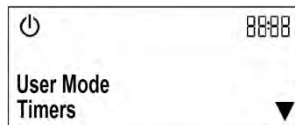

3. Press [#] to access **Timers** menu.

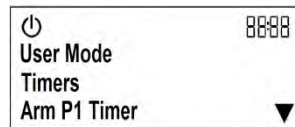

4. Press [#] to access **Arm P1 Timer** for auto arm partition 1 timer.

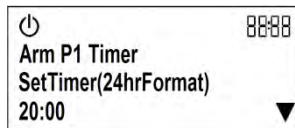

5. Press the [F] key to set to **99:99** setting.

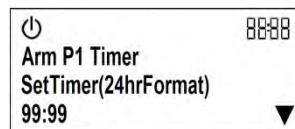

6. Press [#] key to erase previous [**AUTO ARM P1 TIMER**] setting.
7. Press [▼] to scroll down to erase **Arm P2 Timer**, **Arm P3 Timer** and **Arm P4 Timer**.
8. Press [*] to exit user programming mode.

25.9 PROGRAM AUTO DISARM PARTITION 1/2/3/4 TIMER

1. Ensure that the system is in USER PROGRAMMING mode.

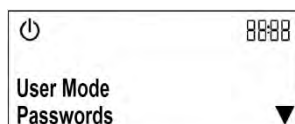

2. Press [▼] to scroll down to **Timers**.

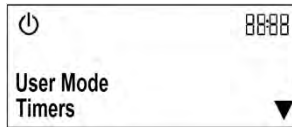

3. Press [#] to access **Timers** menu.

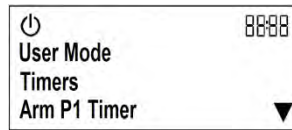

4. Press [▼] to scroll down to **Disarm P1 Tmr.**

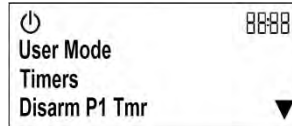

5. Press [#] to select **Disarm P1 Tmr** for auto disarm partition 1 timer.

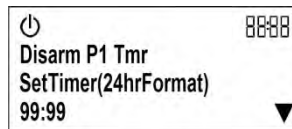

6. Enter the **[AUTO DISARM P1 TIMER]** in 24-hour format. Example, 8:00pm is 20:00.

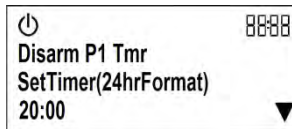

7. Press [#] key to confirm the time.

8. Press [▼] to scroll down to program **Disarm P2 Timer, Disarm P3 Timer and Disarm P4 Timer.**

9. Press [*] to exit user programming mode.

25.10 TO ERASE AUTO DISARM PARTITION 1/2/3/4 TIMER

1. Ensure that the system is in **USER PROGRAMMING** mode.

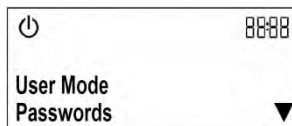

2. Press [▼] to scroll down to **Timers.**

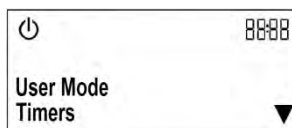

3. Press [#] to select **Timers** menu.

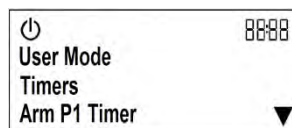

4. Press [▼] to scroll down to **Disarm P1 Tmr.**

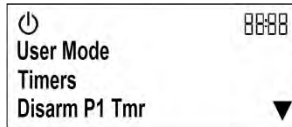

5. Press [#] to select **Disarm P1 Tmr** for auto disarm partition 1 timer.

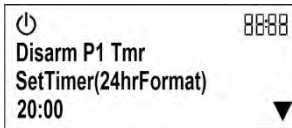

6. Press the [F] key to set to **99:99** setting.

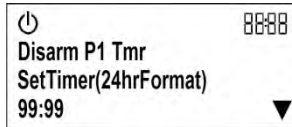

7. Press [#] key to erase previous [**AUTO DISARM P1 TIMER**] setting.
8. Press [▼] to scroll down to erase **Disarm P2 Timer, Disarm P3 Timer** and **Disarm P4 Timer**.
9. Press [*] to exit user programming mode.

25.11 PROGRAM AUTO ON TIMER 1/2/3/4 FOR HOME AUTOMATION

1. Ensure that the system is in USER PROGRAMMING mode.

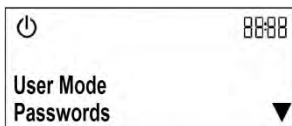

2. Press [▼] to scroll down to **Timers**.



3. Press [#] to access **Timers** menu.

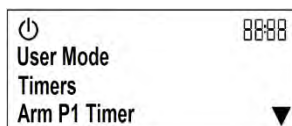

4. Press [▼] to scroll down to **ON HA Tmr 1** and press [#] for auto on timer 1.

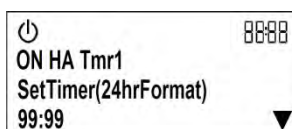

5. Enter the [**AUTO ON TIMER 1**] in 24-hour format. Example, 8:00pm is 20:00.

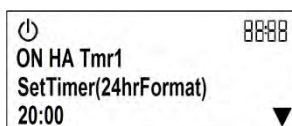

6. Press [#] key to confirm the time.
7. Press [▼] to scroll down to program **ON HA Tmr 2, ON HA Tmr 3** and **ON HA Tmr 4**.

- Press [*] to exit user programming mode.

25.12 TO ERASE AUTO ON TIMER 1/2/3/4 FOR HOME AUTOMATION

- Ensure that the system is in USER PROGRAMMING mode.

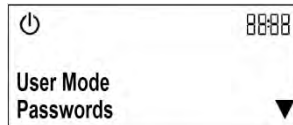

- Press [▼] to scroll down to **Timers**.

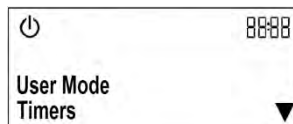

- Press [#] to access **Timers** menu.

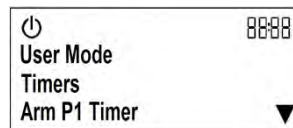

- Press [▼] to scroll down to **ON HA Tmr 1** and press [#] for auto on timer 1.

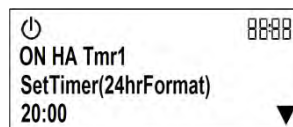

- Press the [F] key to set to **99:99** setting.

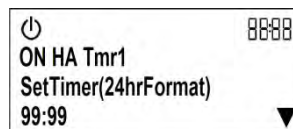

- Press [#] key to erase previous [**AUTO ON TIMER 1**] setting.
- Press [▼] to scroll down to erase **ON HA Tmr 2**, **ON HA Tmr 3** and **ON HA Tmr 4**.
- Press [*] to exit user programming mode.

25.13 PROGRAM AUTO OFF TIMER 1/2/3/4 FOR HOME AUTOMATION

- Ensure that the system is in USER PROGRAMMING mode.

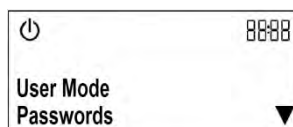

- Press [▼] to scroll down to **Timers**.

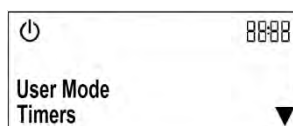

- Press [#] to access **Timers** Menu.

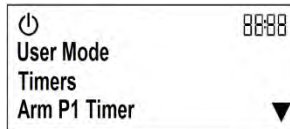

- Press [▼] to scroll down to **OFF HA Tmr 1** and press [#] for auto off timer 1.



- Enter the **[AUTO OFF TIMER 1]** in 24-hour format. Example, 8:00pm is 20:00.



- Press [#] key to confirm the time.
- Press [▼] to scroll down to program **OFF HA Tmr 2**, **OFF HA Tmr 3** and **OFF HA Tmr 4**.
- Press [*] to exit user programming mode.

25.14 TO ERASE AUTO OFF TIMER 1/2/3/4 FOR HOME AUTOMATION

- Ensure that the system is in USER PROGRAMMING mode.



- Press [▼] to scroll down to **Timers**.



- Press [#] to access **Timers** menu.

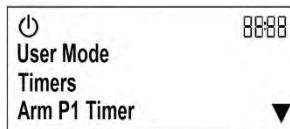

- Press [▼] to scroll down to **OFF HA Tmr 1** and press [#] for auto off timer 1.

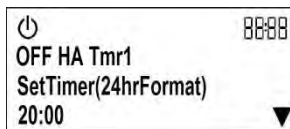

- Press the [F] key to set to **99:99** setting.

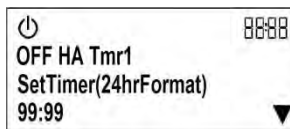

- Press [#] key to erase previous **[AUTO OFF TIMER 1]**.
- Press [▼] to scroll down to erase **OFF HA Tmr 2**, **OFF HA Tmr 3** and **OFF HA Tmr 4**.
- Press [*] to exit user programming mode.

25.15 PROGRAM PERSONAL TELEPHONE NUMBER 1/2/3/4

1. Ensure that the system is in USER PROGRAMMING mode.

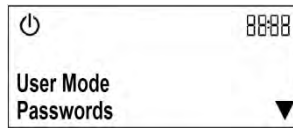

2. Press [▼] to scroll down to **Tel Nos**.

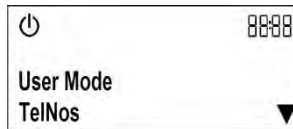

3. Press [#] to access **Tel Nos** menu.

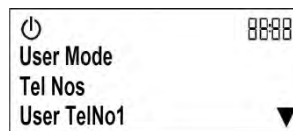

4. Press [#] to select **User Tel No1**.

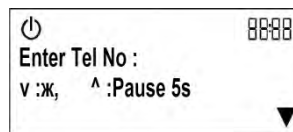

5. Enter the **[PERSONAL TELEPHONE NUMBER 1]**. The maximum telephone number length is 16 digits. The entered number will be displayed on the screen.

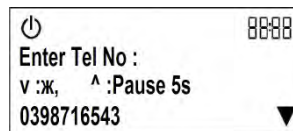

6. Press the [F] key to temporary erase setting or wrong keyed in numbers.
7. Button “▲” on the keypad is representing a “PAUSE” key of 5 seconds duration.
8. Button “▼” on the keypad is representing a “*” key.
9. Press [#] key to confirm the setting.
10. Press [▼] to scroll down to program **User Tel No2, User Tel No3 and User Tel No4**.
11. Press [*] to exit user programming mode.
12. If programmed so, system will call out to user telephone to report for any intrusion.
13. If the system fails to contact the preprogrammed personal telephone number 1, system will contact **[PERSONAL TELEPHONE NUMBER 2 to 4]** as backup.

25.16 TO ERASE PERSONAL TELEPHONE NUMBER 1/2/3/4

1. Ensure that the system is in USER PROGRAMMING mode.

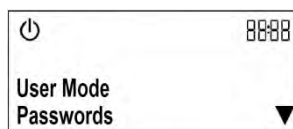

2. Press [▼] to scroll down to **Tel Nos**.

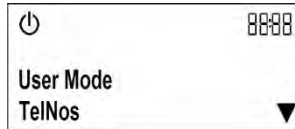

- Press [#] to access **Tel Nos** menu.

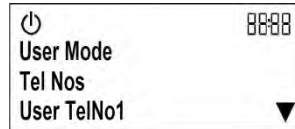

- Press [#] to select **User Tel No1**.

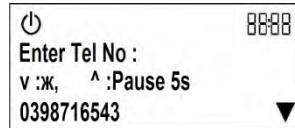

- Press the [F] key to erase the setting.

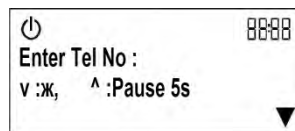

- Press [#] key to erase previous **[PERSONAL TELEPHONE NUMBER 1]**.
- Press [▼] to scroll down to erase **User Tel No2, User Tel No3 and User Tel No4**.
- Press [*] to exit user programming mode.

25.17 PROGRAM GSM TELEPHONE NUMBER 1/2/3/4

- Ensure that the system is in USER PROGRAMMING mode.

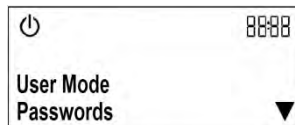

- Press [▼] to scroll down to **GSM Tel Nos**.

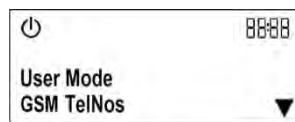

- Press [#] to access **GSM Tel Nos** menu.

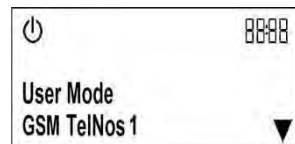

- Press [#] to select **GSM Tel No1**.

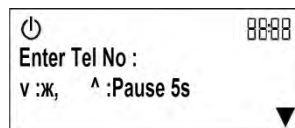

- Enter the **[GSM TELEPHONE NUMBER 1]**, the maximum telephone number length is 16 digits. The entered number will be displayed on the screen.

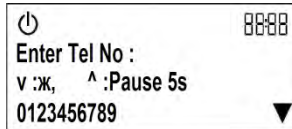

6. Press the **[F]** key to temporary erase setting or wrong keyed in numbers.
7. Button “▲” on the keypad is representing a “PAUSE” key of 5 seconds duration.
8. Button “▼” on the keypad is representing a “*” key.
9. Press **[#]** key to confirm the setting.
10. Press **[▼]** to scroll down to program **GSM Tel No2**, **GSM Tel No3** and **GSM Tel No4**.
11. Press **[*]** to exit user programming mode.
12. If programmed so, system will call out to user telephone to report for any intrusion.

25.18 TO ERASE GSM TELEPHONE NUMBER 1/2/3/4

1. Ensure that the system is in USER PROGRAMMING mode.



2. Press **[▼]** to scroll down to **GSM Tel Nos**.

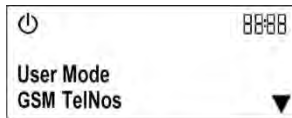

3. Press **[#]** to access **GSM Tel Nos** menu.

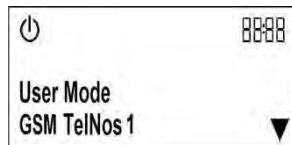

4. Press **[#]** to select **GSM Tel No 1**.

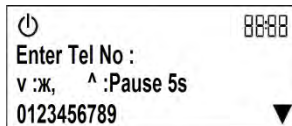

5. Press the **[F]** key to erase the setting.

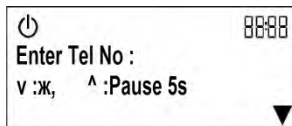

6. Press **[#]** key to erase previous **[GSM TELEPHONE NUMBER 1]**.
7. Press **[▼]** to scroll down to erase **GSM Tel No2**, **GSM Tel No3** and **GSM Tel No4**.
8. Press **[*]** to exit user programming mode.

25.19 PROGRAM SYSTEM DATE

1. Ensure that the system is in USER PROGRAMMING mode.

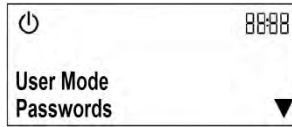

2. Press [▼] to scroll down to **Date**.



3. Press [#] to select **Date**.

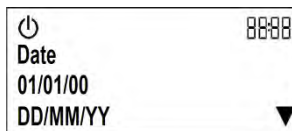

4. Enter the [DATE] in DDMMYY format. Example 22nd February 2010 is 220210.

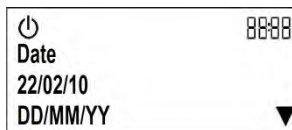

5. Press [#] key to confirm the date.
6. Press [*] to exit user programming mode.

26.0 TESTING THE SYSTEM

Users are advised to test the system as frequent as possible. System must be tested at least once every 3 months. If the system is not functioning accordingly, please contact your system installer for technical assistance.

26.1 WALK TEST

1. Walk Test allows on-site testing of each zone of the system.
2. Press [MODE] + [1] + [#] or from MENU, i.e, (Menu ⇒ System Test ⇒ WalkTest).

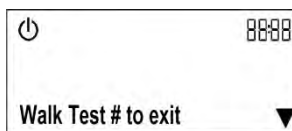

3. Siren will trigger for 2 seconds and keypad buzzer will sound briefly if any zone is violated during walk test mode.
4. If siren and keypad do not sound when zone is violated, consult your system installer.
5. To exit Walk Test, simply press [#] key.

26.2 CMS TEST (Manual Test)

1. CMS Test allows on-site testing of CMS Reporting.
2. Press **[MODE] + [2] + [#]** or from MENU, i.e, (**Menu ⇒ System Test ⇒ CMS Test**).



3. A CMS testing code will be sent to the central monitoring station.
4. Wait for 2 minutes, if CMS reporting fails then a new trouble condition will be registered.
5. Press and hold down key **[7]** for 2 seconds to view trouble condition and consult your system installer.
6. Please refer to **View System Trouble** at page 20 (Section 15.0).

26.3 SIREN TEST

1. Siren Test allows on-site testing of siren functionality.
2. Press **[MODE] + [3] + [#]** or from MENU, i.e, (**Menu ⇒ System Test ⇒ Siren Test**).



3. Siren will sound for 3 seconds.
4. If siren does not sound, consult your system installer.

26.4 STROBE LIGHT TEST

1. Strobe Light Test allows on-site testing of strobe light functionality.
2. Press **[MODE] + [4] + [#]** or from MENU, i.e, (**Menu ⇒ System Test ⇒ Strobe Test**).

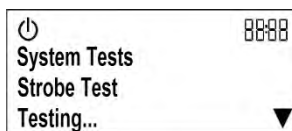

3. Strobe light will flash for 15 seconds.
4. If strobe light does not flash, consult your system installer.

26.5 BATTERY TEST

1. Battery Test allows on-site testing of battery functionality.
2. Press **[MODE] + [5] + [#]** or from MENU, i.e, (**Menu ⇒ System Test ⇒ Battery Test**).

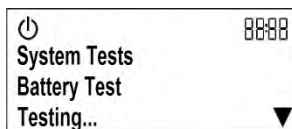

3. Wait for 5 seconds, if back-up battery fails then a new trouble condition will be registered.
4. Press and hold down **[7]** key for 2 seconds to view the trouble condition and consult your system installer.

27.0 PAGE SWITCHING

S32 LCD Keypad can display up to 32 zones status and it can be viewed up to 16 zones at a time. Page switching is divided into 2 pages where users are required to select which page to be displayed. The pages are categorized as of below:

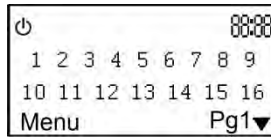

Pg1 – Page 1 consists of Zone 1 to 16

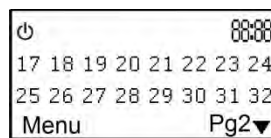

Pg2 – Page 2 consists of Zone 17 to 32

To switch between pages, press **[*]** and the page will display from **Pg1** to **Pg2** or vice-versa.

28.0 SYSTEM INFORMATION

SECURITY ZONE INFORMATION

Zone No.	Partition	Zone Type	Location
1			
2			
3			
4			
5			
6			
7			
8			
9			
10			
11			
12			
13			
14			
15			
16			
17			
18			
19			
20			
21			
22			
23			
24			
25			
26			
27			
28			
29			
30			
31			
32			

CMS

Central Monitoring Station Number : _____
 Central Monitoring Station Account Number : _____

Servicing

Installer company : _____
 Contact person : _____
 Contact number : _____
 Installation Date : ____ / ____ / ____

29.0 SYSTEM SETTING

Partition 1

Entry Time Partition 1 : _____ seconds
 Exit Time Partition 1 : _____ seconds
 Siren Cut-Off Time for Partition 1 : _____ minutes

Partition 2

Entry Time Partition 2 : _____ seconds
 Exit Time Partition 2 : _____ seconds
 Siren Cut-Off Time for Partition 2 : _____ minutes

Partition 3

Entry Time Partition 3 : _____ seconds
 Exit Time Partition 3 : _____ seconds
 Siren Cut-Off Time for Partition 3 : _____ minutes

Partition 4

Entry Time Partition 4 : _____ seconds
 Exit Time Partition 4 : _____ seconds
 Siren Cut-Off Time for Partition 4 : _____ minutes

Telephone Reporting

Telephone Number 1 : _____
 Telephone Number 2 : _____
 Telephone Number 3 : _____
 Telephone Number 4 : _____
 Dialing Attempt : _____ times

OPTIONAL GSM Telephone Reporting

GSM Telephone Number 1 : _____
 GSM Telephone Number 2 : _____
 GSM Telephone Number 3 : _____
 GSM Telephone Number 4 : _____

Home Automation

Home Automation 1 Turn On Time _____ : _____ am / pm
 Home Automation 1 Turn Off Time _____ : _____ am / pm
 Home Automation 2 Turn On Time _____ : _____ am / pm
 Home Automation 2 Turn Off Time _____ : _____ am / pm
 Home Automation 3 Turn On Time _____ : _____ am / pm
 Home Automation 3 Turn Off Time _____ : _____ am / pm
 Home Automation 4 Turn On Time _____ : _____ am / pm
 Home Automation 4 Turn Off Time _____ : _____ am / pm